

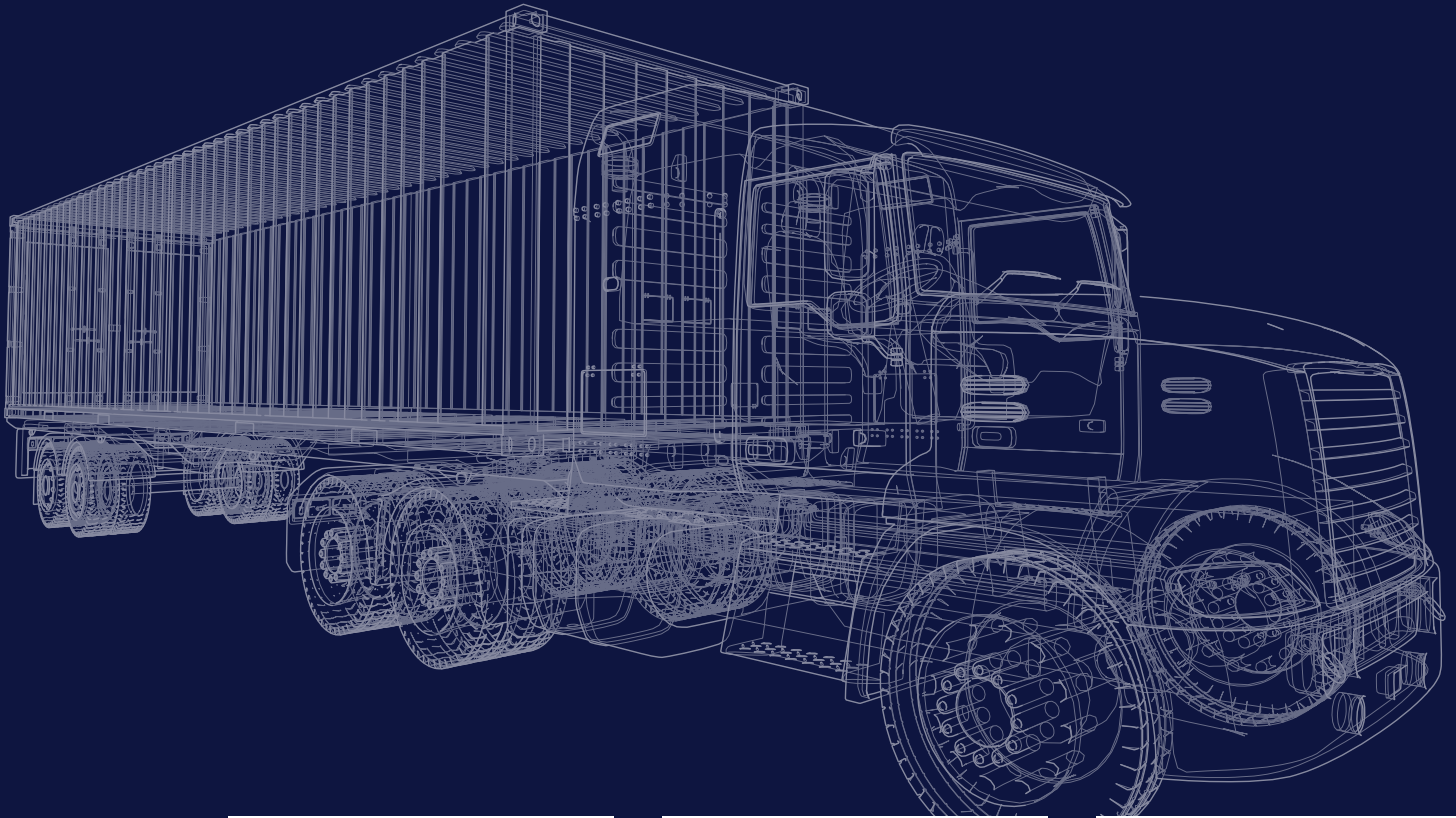

Form 562-22
Supersedes
Form 562-20



2022 PRODUCT GUIDE



FAST FACTS

YOUR SINGLE SOURCE FOR QUALITY FILTRATION BROADEST COVERAGE IN THE INDUSTRY

As leaders in the industry, Baldwin has a reputation for protecting heavy-duty engines in a wide range of markets and applications. From the big city to the remote countryside and everywhere in between, Baldwin provides protection you can rely on no matter where you're headed.

FILTRATION EXPERTISE

FOUNDED 1936 Baldwin's longevity has resulted in a sophisticated level of understanding across a broad range of industries.

TOUGH HEAVY-DUTY

	ON-HIGHWAY Class 4-8 Trucks
	CONSTRUCTION Backhoes, Loaders, Excavators
	OIL & GAS Generators, Industrial Engines, Trucks
	MINING Earth Movers, Excavators, Haul Trucks
	AGRICULTURE Tractors, Loaders, Combines
	MARINE Tug Boats, Generators

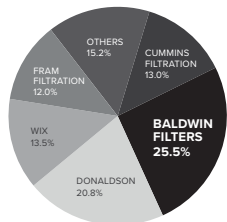

NORTH AMERICAN CLASS 4-8 MARKET SHARE

PREMIUM LIGHT-DUTY

	DIESEL PICKUPS
	GAS PICKUPS
	SUVS
	LAW ENFORCEMENT VEHICLES
	COMMERCIAL VEHICLES



80+ YEARS

UNSURPASSED PERFORMANCE

- Products designed to fully meet or exceed application requirements
- Efficiency to protect the most advanced modern engines
- Capacity to meet OE recommended service intervals
- Products tested over and beyond industry standards
- Industry leading fill rate of 97%

KNOWLEDGEABLE SERVICE

Largest, most experienced field and inside technical support team



RELIABLE QUALITY

- Vertical integration for world-class quality exceeding 6 Sigma
- Application specific filter design and unique, proprietary media development
- Complete process control, vertical integration from media development through component production and final assembly
- Cutting edge innovation center and on-site test labs to validate high performance

45000+
CASES SHIPPED PER DAY

7500+
OE QUALITY PARTS

150+
BRAND PARTNERSHIPS

MORE COVERAGE

BALDWIN VS. COMPETITOR A **68%**

46%

BALDWIN VS. COMPETITOR B **77%**

54%

BALDWIN VS. COMPETITOR C **84%**

68%

BALDWIN VS. COMPETITOR D **82%**

46%

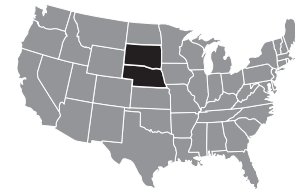

95% TOP 200 SALES
MADE IN THE USA

AIR | FUEL | LUBE | HYDRAULIC | COOLANT | TRANSMISSION | EMISSIONS

baldwinfilters.com

Table of Contents	1
Form 123, Form 124, Form 125, Form 560 and Form 561 List of Contents.....	2
Baldwin New Products.....	3-6
Baldwin Obsolete Products	7-16
Notes.....	17
Abbreviations Used Anywhere in Our Catalogs	18-26
Prefixes and Suffixes	27-35

PRODUCT GUIDE.....	36-660
How Product Guide is Arranged	36-40
Product Guide (Numerical Sequence Master List).....	41-660
Stanadyne Fuel Additives	661
Gaskets	662-669
Caterpillar Gaskets	670

DAHL	671-687
------------	---------

SIZE CHARTS.....	688-755
O-Ring Uniform Dash Numbers	688
Round Gaskets Arranged by O.D.	689-691
Spin-on Filters by Tap Size (U.S. Thread)	692-705
Spin-on Filters by Tap Size (British Standard Pipe Thread)	706
Spin-on Filters by Tap Size (Metric Thread)	707-713
Liquid Elements by Length.....	714-728
Round Air Filters by Length.....	729-744
Panel Air Filters	745-753
Oval, Oblong & Miscellaneous Air Filters	754
Box-Style and Can-Type Fuel Filters	755
Oil/Air Separator Elements by Length.....	756
Oil/Air Separator Spin-on Filters by Tap Size (Metric Thread)	757
In-Line Filters by Inlet Size.....	758-759

UPC Code Explanation.....	760
Baldwin to UPC (Individual Parts)	761-780
UPC to Baldwin (Individual Parts)	781-800
Baldwin Case to I 2/5 (Shipping Cases).....	801-810
I 2/5 to Baldwin Case (Shipping Cases).....	811-820
Baldwin Weights and Volumes	821-853
Filter Wrenches.....	854-856

TABLE OF CONTENTS

Product Guide

Form 123-21, Form 124-22, Form 125-21, Form 560-20 & Form 561-21 List of Contents

FORM 123-21 AUTOMOTIVE APPLICATIONS

Refer to the following list of contents for information contained in the Baldwin Automotive Filter Applications Catalog, Form 123-21.

AUTOMOTIVE APPLICATIONS

- *Automotive and Light-Duty Truck Applications 1980-on (Includes Imports)*
- *Automotive and Light-Duty Truck Applications Pre-1980 (Includes Imports)*

FORM 124-22 OFF-HIGHWAY APPLICATIONS

Refer to the following list of contents for information contained in the Baldwin Off-Highway Filter Applications Catalog, Form 124-22.

OFF-HIGHWAY APPLICATIONS

- *Off-Highway Applications*

FORM 125-21 TRUCKS & BUSES APPLICATIONS

Refer to the following list of contents for information contained in the Baldwin Trucks & Buses Filter Applications Catalog, Form 125-21.

TRUCKS & BUSES APPLICATIONS

- *Trucks & Buses Applications*

FORM 560-20 MANUFACTURERS' CROSS-REFERENCE

Refer to the following list of contents for information contained in the Baldwin Manufacturers' Cross-Reference Catalog, Form 560-20.

MANUFACTURERS' CROSS-REFERENCE

- *Cross-Reference Information Arranged by Manufacturer*

FORM 561-21 NUMBER-FINDER CROSS-REFERENCE

Refer to the following list of contents for information contained in the Baldwin Number-Finder Cross-Reference Catalog, Form 561-21.

NUMBER-FINDER CROSS-REFERENCE

- *Cross-Reference Information Arranged in Number-Finder Format*

ALSO INCLUDED

- *Manufacturers' Codes*

BALDWIN NEW PRODUCTS

BALDWIN NUMBER	DESCRIPTION	REPLACES	APPLICATIONS
BK6130	Service Kit		Mack & Volvo Engine Applications
PA10080	Panel Air Element with Pull Tabs	Hyundai 28113A9100; Kia 28113A9100	2017-20 Hyundai Santa Fe, 2017-18 Santa Fe Sport, 2020 Palisade; 2015-20 Kia Sedona, 2016-20 Sorento, 2020 Telluride
PA10088	Panel Air Element	Honda 172205PHA00	2017-19 Honda CR-V, 2018 Clarity
PA10107	Panel Air Element	Toyota 178010P090	2017-21 Lexus RX450h, 2018-21 RX450hL; 2017-19 Toyota Highlander
PA10406	Panel Air Element	Nissan 165461LA0A	2017-21 Nissan Armada; 2011-13 Infiniti QX56, 2014-20 QX80
PA10408	Panel Air Element	Ford Motor GN1Z9601A; Motorcraft FA1935	2018-20 Ford EcoSport
PA10410	Panel Air Element	Chrysler 68257030AA	2018-20 Jeep Wrangler, 2020 Gladiator
PA10413	Panel Air Element	Ford Motor EB3Z9601B; Motorcraft FA1943	2019-20 Ford Ranger
PA10414	Panel Air Element	Toyota 17801F0050	2019-20 Lexus ES350; Toyota Avalon, RAV4, 2018-20 Camry, 2020 Highlander
PA10415	Panel Air Element	Mazda PEHH133A0	2016-20 Mazda CX-3, 2017-18 Mazda 3 Sport
PA10416	Panel Air Element	ACDelco A3246C; GM General Motors 84121217	2021 Cadillac Escalade; 2021 Chevrolet Suburban, Tahoe, 2019-20 Silverado 1500; 2021 GMC Yukon, Yukon XL, 2020 Sierra 1500
PA10417	Panel Air Element	ACDelco A3244C; GM General Motors 84121219	2021 Cadillac Escalade; 2021 Chevrolet Suburban, Tahoe, 2019-20 Silverado 1500, 2020 Silverado 2500 HD, Silverado 3500 HD; 2021 GMC Yukon, Yukon XL, 2019-20 Sierra 1500; 2020 Sierra 2500 HD, Sierra 3500 HD
PA10418	Panel Air Element	Nissan 165466CA0A	2019-20 Nissan Altima
PA10419	Panel Air Element	Subaru 16546AA16A	2019-21 Subaru Ascent, Forester, 2018-21 Crosstrek, 2017-21 Impreza, 2020-22 Legacy, Outback
PA10420	Panel Air Element	Volkswagen 5QM129620B	2019-21 Volkswagen Golf, Jetta
PA10422	Panel Air Element	Mazda P53N133A0; Toyota 17801WB001	2016 Scion iA; 2019-20 Toyota Yaris, 2017-19 Yaris iA
PA10423	Panel Air Element with Foam Pad	AC Delco A3228C; GM General Motors 84065602	2018-20 Chevrolet Express Van 2500, Express Van 3500; GMC Savana 2500, Savana 3500, all with 4.3L Engine.
PA10424	Panel Air Element with Foam Pad	Nissan 165465RB1A	2018-21 Nissan Kicks, 2020-21 Versa
PA10425	Panel Air Element	Nissan 16546EZ31B	2017-19 Nissan NV2500, 2019 NV3500, 2017 Titan, 2016-18 Titan XD
PA10426	Panel Air Element with Foam Pad	ACDelco A3248C; GM General Motors 84554703	2020-21 Chevrolet Silverado 2500 HD, Silverado 3500 HD, GMC Sierra 2500 HD, Sierra 3500 HD with 6.6L Turbo Diesel Engine
PA10427	Panel Air Element	Ford Motor LC3Z9601A; Motorcraft FA1950	2020-21 Ford F-250 Super Duty, F-350 Super Duty, 2020 F-450 Super Duty, F-550 Super Duty trucks
PA10428	Panel Air Element with Foam Pad	Ford Motor LC3Z9601B; Motorcraft FA1951	2020-21 Ford F-250 Super Duty, F-350 Super Duty, 2020 F-450 Super Duty, F-550 Super Duty trucks
SA10429	Foam Pre-Cleaner	Ford Motor LC3Z9601C; Motorcraft FA1952	2020 Ford F-250 Super Duty, F-350 Super Duty, F-450 Super Duty, F-550 Super Duty trucks
PA10430	Panel Air Element with Foam Pad	ACDelco A3210C; GM General Motors 23430313	2021 Buick Envision, 2018-20 Buick Regal Sportback, Regal TourX; 2019-21 Cadillac XT4, 2018-21 Chevrolet Malibu
PA10431	Cabin Air Element	Ford Motor KB3Z19N619A; Motorcraft FP88	2019-22 Ford Ranger
PA10433	Panel Air Element	Honda 1722-06A-0A00	2018-21 Honda Accord
PA10435	Panel Air Element with Foam Pad	Chrysler 68320315AB	2019-21 Jeep Cherokee
PA10436	Panel Air Element	Ford Motor JX6Z9601A; Motorcraft FA1939	2019-22 Ford Transit Connect, 2020-22 Escape, 2021-22 Bronco Sport; 2020-22 Lincoln Corsair
PA10438	Panel Air Element	Chrysler 68386779AA; 68441763AA	2019-21 RAM 1500, 2021 1500 Classic
PA10439	Cabin Air Element	Nissan 272776CA0A, 272776CA1A	2019-21 Nissan Altima
PA10440	Cabin Air Element	Ford Motor JX6Z19N619BA; Motorcraft FP89	2021-22 Ford Bronco Sport, Mustang Mach-E, 2020-22 Escape, Explorer, 2020-21 Police Interceptor Utility; 2020-22 Lincoln Aviator, Corsair
PA10441	Panel Air Element	Ford Motor L1MZ9601A; Motorcraft FA1947	2020-22 Ford Explorer, 2020-21 Police Interceptor Utility



WARNING: These products can expose you to chemicals, including Diisononyl Phthalate, Carbon black extracts, Nickel, 1,3 Butadiene, Ethylene Oxide, Epichlorohydrin, which are known to the State of California to cause cancer, and Bisphenol-A, Ethylene Glycol, Ethylene Oxide, 1,3 Butadiene, Epichlorohydrin, which are known to the State of California to cause birth defects or other reproductive harm. For more information go to www.P65Warnings.ca.gov.

BALDWIN NEW PRODUCTS

BALDWIN NUMBER	DESCRIPTION	REPLACES	APPLICATIONS
CV15015	Crankcase Breather	Caterpillar 2747913; Racor CCV5527410; Donaldson P636077	Caterpillar Marine Engines
CV15016	Crankcase Breather	Caterpillar 2735711; Manitou 743204; Perkins 2654A104; Fleetguard CV51301; Mann+Hummel W10010	Caterpillar Compactors, Crawler Tractors, Dozers, Excavators, Generators, Gen Set Engines, Integrated Toolcarriers, Lift Trucks, Loaders, Material Handlers, Motor Graders; Manitou Loaders
PE17002 KIT	Diesel Exhaust Fluid Filter Kit	Bomag 4388378; Claas 0019999480; Cummins 4388378; DAF 2122909; Fleetguard UF106; Freightliner 1421089; Mercedes-Benz A0001420589, A0001420789, A0001420989, A0001421089; Paccar 2122909PE;	Freightliner 108SD, 114SD, 122SD, Business Class M2 106, Cascadia, Cascadia Evolution, Coronado, Coronado SD, M2 106, M2 112; Kenworth T880; Mercedes Benz European Trucks; Western Star 4900EX, 4900FA, 4900SA, 5700XE, 6900XD Trucks
20071	Transmission Filter	Toyota 3533033050, 3533048020	2007-18 Lexus ES350, 2010-15 RX350, RS450h, 2014-18 ES300h, 2016 NX200t, 2016-21 NX300h, 2018-21 NX300; 2008-17 Toyota Camry, 2010-18 Avalon, 2011-17 Sienna, 2009-16 Venza
20072	Transmission Filter	Motorcraft FT202; FT215; Ford Motor HL3Z7A098A, L1MZ7A098A	2019-22 Ford Expedition, Ranger, 2021 Bronco, 2022 Explorer, 2017-2021 F-150, 2018 Lobo, 2020-21 Mustang, 2020 Police Interceptor Utility; 2019-21 Lincoln Navigator
PT23624	Wire Mesh Hydraulic Element	Volvo 14530989	Volvo Excavators, Pipelayers
PT23625	Wire Mesh Hydraulic Element	Volvo 114100010	Volvo Excavators, Forestry Equipment
PT23637-MPG	Maximum Performance Glass Hydraulic Element with Bail Handle	Bobcat 7012314	Bobcat Loaders
PA30200	Secondary Air Element with Handles	Caterpillar 2089066; Donaldson P636759	Caterpillar Generators, Gen Set Engines, Industrial Engines, Marine Engines
CA30201	Channel Flow Primary Air Element with Handles	Caterpillar 2089065; Perkins SEV551H4	Caterpillar Generators, Gen Set Engines, Industrial Engines, Marine Engines
CA30202	Channel Flow Primary Air Element with Handles	Caterpillar 2262779; Donaldson P635236	Caterpillar Generators, Gen Sets, Industrial Engines, Marine Engines
RS30227	Radial Seal Air Element	Bobcat 7016038	Bobcat, Polarix Utility Vehicles
RS30238	Radial Seal Outer Air Element	Hino 178013360, S178013360, S179021140; Donaldson P500176, P503360, P849038, P849078; Fleetguard AF26523	Hino Trucks
RS30239	Radial Seal Inner Air Element	Hino S178013371; Donaldson P503370; Fleetguard AF26521	Hino Trucks
RS30273	Radial Seal Outer Air Element	Kubota 1G31911210; Mann & Hummel C10007	Kubota Tractors, Utility Vehicles
RS30274	Radial Seal Inner Air Element	Kubota K759182360	Kubota Tractors, Utility Vehicles
RS30282	Radial Seal Outer Air Element	Bobcat 6687262; Donaldson P628323; Fleetguard AF26116; Mann+Hummel C10010	Bobcat Loaders
RS30291	Radial Seal Inner Air Element	Caterpillar 3754302	Caterpillar Excavators, Material Handlers, Paving Equipment.
PA30333	Panel Air Element with Pull Tabs	Caterpillar 4886446	Caterpillar Excavators
PA31015	Primary EnduraPanel Air Element	John Deere R553819, R344419, RE580948, RE594852	John Deere Tractors
BT40067-MPG	Maximum Performance Glass Lube Spin-on	Donaldson DBB8665	
P40069	Lube Element	Paccar 2047411, 2047411PE, 2047542, 2047542PE, 2151728, 2151728PE, 2234788, 2234788PE	Kenworth, Peterbilt trucks with Paccar MX-13 Engines
B40121	Full-Flow Lube Spin-on	Chrysler 4494477; Mazda AM15-14-302	Chrysler, Eagle, Mazda, Auto, L-D Trucks



WARNING: These products can expose you to chemicals, including Diisononyl Phthalate, Carbon black extracts, Nickel, 1,3 Butadiene, Ethylene Oxide, Epichlorohydrin, which are known to the State of California to cause cancer, and Bisphenol-A, Ethylene Glycol, Ethylene Oxide, 1,3 Butadiene, Epichlorohydrin, which are known to the State of California to cause birth defects or other reproductive harm. For more information go to www.P65Warnings.ca.gov.

BALDWIN NEW PRODUCTS

BALDWIN NUMBER	DESCRIPTION	REPLACES	APPLICATIONS
P40134	Lube Element	Volvo 31372212	2014-20 Volvo V60, 2015-16 S80, XC70, 2015-20 S60, XC60, 2016-20 XC90, 2017-19 V90 Cross Country, 2017-20 S90, V60 Cross Country, 2019 V90, 2019-20 XC40
P40143	Lube Element	Hyundai 263203CKB0	2017-18 Genesis G80; 2014-16 Hyundai Genesis; 2017 Genesis Coupe, 2020 Palisade; 2017-19 Kia Cadenza, 2019-20 Sedona, 2020 Telluride
P40156	Lube Element	Ford Motor JX6Z6731B; Motorcraft FL2082	2019-20 Ford Transit Connect
BF46036 KIT	Set of 2 Fuel Filters	Agco 837079726, 837091128, 837079727, V837091129; Massey Ferguson V837079718, V837079555, V837079556	Ag-Chem Fertilizer Applicators; Challenger Tractors; Fendt Combines; Gleaner Combines; Massey Ferguson Harvesters, Wheel Tractors; Valtra Tractors
BF46061	Fuel Spin-on	Donaldson DBB8666; Fleetguard FF5897	
BF46068	Fuel Spin-on with Open Port	Case 84527831	Case Loaders; New Holland Loaders, Telehandlers, Trenchers
BF46134-O	Fuel/Water Separator with Open End for Bowl	Racor R90P-D MAX; Volvo 21005832, 21380490, 20782330; Donaldson P954895; Fleetguard FS20053; Mann & Hummel WK11001X	Volvo European FH Series Trucks
BF46156	Fuel Spin-on with Port	John Deere DZ115391, RE551507	John Deere Dozers, Excavators, Forestry Equipment, Generators, Harvesters, Industrial Engines, Loaders, Motor Graders, Sprayers, Tractors
BF46157	Fuel Spin-on	John Deere DZ115390, RE551508	John Deere Dozers, Generators, Harvesters, Industrial Engines, Loaders, Motor Graders, Sprayers, Tractors
BF46158	Fuel Spin-on	John Deere DZ115392, RE560681	John Deere Dozers, Forestry Equipment, Harvesters, Loaders, Motor Graders, Sprayers, Tractors
BF46159	Fuel Spin-on with Open Port	John Deere DZ115389, RE560682	John Deere Tractors
PF46172 KIT	Fuel Filter Kit	Ford HC4Z9N184A; Motorcraft FD4626	2017-19 Ford F650 & F750 with V8-406 (6.7L) Turbo Diesel Engine
BF46230	Fuel Spin-on	VAG (Volkswagen/Audi Group) 2R0127177E; Volvo 20841523; Donaldson P551523; Fleetguard FF5935	Volkswagen 26.260E Trucks
BF46234	Fuel Spin-on	Isuzu 8982394640, 8982394641, 8982394642, 8983129180	John Deere Excavators; Multiquip Equipment
PF46241	Wire Mesh Fuel Element	Isuzu 8980714010	Kubota Loaders, Tractors; Multiquip Equipment; Shindaiwa Generators
BF46242	In-Line Fuel Filter	Cummins 149234101; Onan 1492341	Onan RV Generators
BF46244	Fuel Spin-on	Donaldson DBB8777	
BF46248	Fuel Spin-on	Cummins 5575143; Fleetguard FF5971NN	Cummins X15 Truck engines
PF46250	Fuel/Water Separator Element	IHC International Harvester 2515892C91; GMC 19405644; ACDelco TP2011	2019 Chevrolet Silverado 4500 HD, Silverado 5500 HD, Silverado 6500 HD
BF46251-SP	Fuel/Water Separator Spin-on with Drain and Sensor Port	Caterpillar 3169954, 4385385; Fleetguard FS20130	Caterpillar Crawler Tractors, Drilling Equipment, Generators, Gen Set Engines, Loaders, Locomotive Engines, Marine Engines, Off-Highway Trucks
BF46252-SP	Fuel/Water Separator Spin-on with Drain and Sensor Port	Caterpillar 4385386; Donaldson P501108; Fleetguard FS20131	Caterpillar Crawler Tractors, Excavators, Forestry Equipment, Generators, Gen Set Engines, Loaders, Motor Graders, Off-Highway Trucks, Pipelayers, Pumps, Scrapers, Wheel Tractors
BF46256	Fuel Spin-on	Cummins 3644985; Fleetguard FF256	Cummins QSK23, QSK38, QSK50, QSK60 Off-Highway Engines



WARNING: These products can expose you to chemicals, including Diisononyl Phthalate, Carbon black extracts, Nickel, 1,3 Butadiene, Ethylene Oxide, Epichlorohydrin, which are known to the State of California to cause cancer, and Bisphenol-A, Ethylene Glycol, Ethylene Oxide, 1,3 Butadiene, Epichlorohydrin, which are known to the State of California to cause birth defects or other reproductive harm. For more information go to www.P65Warnings.ca.gov.

BALDWIN NEW PRODUCTS

BALDWIN NUMBER	DESCRIPTION	REPLACES	APPLICATIONS
PF46258	Fuel Coalescer	Detroit Diesel 23529393; Gillig 8241341000; Racor CLS4713301, RK4713301, RK47133; New Flyer 6639089	CNG, LNG and LPG powered vehicles
PF46259	Fuel Element	ACDelco TP2016; GM General Motors, 84428486, 84428487, 84186990; Opel 23153963	2021 Chevrolet Express 2500, Express 3500; 2021 GMC Savana 2500, Savanah 3500

NOTES



WARNING: These products can expose you to chemicals, including Diisononyl Phthalate, Carbon black extracts, Nickel, 1,3 Butadiene, Ethylene Oxide, Epichlorohydrin, which are known to the State of California to cause cancer, and Bisphenol-A, Ethylene Glycol, Ethylene Oxide, 1,3 Butadiene, Epichlorohydrin, which are known to the State of California to cause birth defects or other reproductive harm. For more information go to www.P65Warnings.ca.gov.

BALDWIN OBSOLETE PRODUCTS

OBSOLETE NUMBER	REPLACED BY	OBSOLETE NUMBER	REPLACED BY	OBSOLETE NUMBER	REPLACED BY	OBSOLETE NUMBER	REPLACED BY	OBSOLETE NUMBER	REPLACED BY
B-1/2		T-56-M	V835-M*	C-134-EL		P250		TB411-CPE25	
B-1/2-S		T57-M		BT136		PD-250		TC411-CPE2	
B-1	B2	T58-M		PT-139		P-252		TC411-OPE2	
BO-1A		C59-C		B-140		B-254	B50	TC411-CPE10	
V-1-F	V2-F*	P-59	C59-C*	C-141-F		P254		TB412-CPE25	
DL2	B2	C-60-C	P60	B-142		PT-255		T-412-PE	
V-2-A	B9	PT-61	PT61-HD	B-145	B243	V-261-A		P412-5	
V2-F	B2	T-62-P	PT62	PT147		PT-262		TB412-CPE25	
B-3	B9	T-63-P	PT63-1	P149		P-263		P412-5A	
V-3-A	B9	C64-P	P64*	T-153-M		BT-266	B2 or V2-F*	P412-25	
C-5-K	C-50-MH*	P64		V-156-M		P270		TA412-CPE5	
E-5		BT65		PT-157	P80 or P80-HD	BT272	B7082	PA4125	
ME-6-F		C-65-P	T77-P*	PT158(2)		P-272		P412-25A	
V-6-A	B6	P-65	T77-P*	PT-159	PT385	P276 KIT		TC412-CPE5	
D-7		PT-66	PT66-HD	PT-159-E	PT385-E	B-278		TC412-CPE25	
B-8	B27	C-67-P	P67	PT-160		B-280	B39	TC412-CPE5A	
V-9-A	B9	C-68-P	P68	B-161	B161-S	BT-281	B975	TC412-CPE2	
B-10	B10-AL	C-69-P	P69*	P165		BT282	BT8449	TC412-OPE5	
B-10 Bowl	B10-AL Bowl	P69		P-168		BT282-10	BT8449-10	TC412-CPE50	
B-10-HD	B10-AL	T70-P	PT70	P169		PT-286		TA412-CPE10A	
B-10-HD Bowl	B10-AL Bowl	T71-P	PT71	B-173	B173-S	PT-288	PT288-HD	TA412-CPE10	
B-13	B10-AL	T72-P	PT72	P-173		B-290		TS412-CPE50	
B-13 Bowl	B10-AL Bowl	C-73-P	P73	B175	B1422	B291		TC412-CPE10	
P-13		PT-73	P73	P-175		PT-291		TC412-CPE25A	
P-14		C-73-PS	P73	P-178		PT293		TC412-OPE10	
EO-16-A		T-73-P	P73	P-179	P177	PT-294		TB413-CPE25	
S-16	S16-1	C-74-P		P180		B297	B2	T-413-PE	
P17		T-75-P		PT-182 Kit		B-298	BT223	TS413-CPE50	
C18-A	P18 or P18-HD	B76-B	B76	C184-P	P184	VT-299	V842-O*	TA413-CPE10S	
C-19-A	P19	B76-HPG	B76-SS	P188		T-301-M	T300-M	TA413-CPE10	
P-20	P20-HD	PT-77	T77-P*	T192-P		T-302-M	T303-M	TS413-CPE75	
P-20-E	P20-HDE*	T77-P		PT-195	P15	T304-M	PT304	TC413-CPE10AS	
P20-HDE	P20-HD	C78-P		B196-MPG		T-305-M	T304-M*	TC413-CPE10	
C21-A		C80-P	P80	P-196		T-306-M		F-414-B	
P-21	C21-A*	C81-P	P81	B-197	B243	T-307-M		PF-414-10	
C22-A		C-84-P1	C84-P2*	P-197		P315		PF-414-15	
P-22	C22-A*	P-84-1	P84-2	C200-K		PT317	PT317-MPG	PF-414-25	
C23-A		C84-P2	P84-2	P-200	C200-K*	PT318	PT318-MPG	P-415-2A	P415-5A
C24-A		T-85-P	PT85	T-200-K	C200-K*	PT319	PT319-MPG	PF-415	P415-5
V24-A2		PT-86	PT86-HD	B-201	B201-S	PT320	PT320-MPG	S-416	PT416
C25-A	P25	PT-87	PT87-S	C-201-K	P42	BD321	BD325	S417	
C-26-A	P26	PT-87-HD	PT87-S	P-202	PT154	BD322	BD232	S-418	
V-27-A	B27	PT88	PT88-HD	P-202-S		BD323	BD232	S-419	
C-28-A		PT-90	PT90-10	P-205		C327-O		PT-420	
C-30-B		PT92		PT-208-10		B328	BT8417	S-421	PT435
C-31-B		PT94		P-209		BF335		S422	
C-32-B		B95-B	B95	PT-211		BT-344	BT344-S	S-424	
PT32-H		B95-HPG	B95-SS	PT-212	PT212-5	BT-352	BT486	PT-425	
C-33-B		C-95-IL		PT-215	P41	BT-356	BT292	S-426	
P-33	C-33-B*	B-96 Kit	BK6311*	PT-216	P198	BF362	BF7629	S-427	
C-34-M		B96-B	B96	P-217		BF363	BF984	BT428	BT372-MPG
P-34		B96-HPG	B96-SS	C-218-A		BT371-5		V-428-B	
B-35	B35-S	C-96-IL		P219		PT384		V-428-FF	
C-35-M		B97-B	B97	V-220-R		PT390	PT390-MPG	V-429-BP	V429-B
C36-M		C-97-G		V-221-R		PT391	PT391-MPG	PF-430	
P-36	C36-M*	B99-HPG	B99-SS	F-222-P		PT-394	P194-HD	PT-430-B	
C-37-M		C-100-C		P-223		PT394-5		PT432	
P-37	C-37-M*	C-101-W	T101-W* w/G115-A	F225-F	PF225	PT399	P7003	S-433	
B38		PT-101	T101-W*	F226-F	PF226	WG-400		PT-436-WO	PT436
V-39-A	B39	T101-W		PT-227		PT401	PT401-MPG	S-438	
C-40-F	P40	C-102-W		P-228	P190	WG-401		PT-439-HD20	
C-41-F	P41	T-103-W	P42 w/G143	C-229-A		WG-402		PT-439-HD40	PT-439-HD20*
C-42-F	P42	P-105		P-230		WG-403		S-440	
B43	B43-S	P107		B-232	B233	WG-404		S-441	
PT-43	PT29	P-109		B233-HPG		JC-405-B	JC405	PT442	PT442-MPG
T44-M		P-110		V-233-F	B233	CU-406-B	CU406	S-442	
PT-45		P-113		B-234	B296	CU-406-I	CU406	S-443	
T-45-F	PT-45*	V-117-F	PT117	PT-236		CU-406-WO	CU406	S444	
PT46		V-118-MN		P-237		P-406	CU406	PT445	PT445-MPG
T-46-F	PT46*	PT-119-5DL	(2) PT119-5	P-238		VCU-406	CU406	S-445	S423
C-47-P	P47	PT-119-5TR	(3) PT119-5	PF-239		VCU-406-HD	CU406	S-447	S444*
C-49-F		PT119-HD5DL		P-241	PT29	SD407		S448	
C-50-MH		PT-119-TR	(3) PT119	PT-242		VSD-407	SD407*	PT449	
PT-51	T51-M*	PF-120		PT-243	PT82-HD	VDF-408	DF408	PT-452	
T51-M		B-121	B50	P-244		T-409-PE		BT453	BT260-10
C-52-MS	P52	B-122		B245		T-410-PE		PT-453	
C-53-MJ	P53	PT123-5		PT-245		TA410-CPE5		PT-454	
C-54-M	P54	B-127		PT-246		TC411-CPE5		P457	
PT-55	T55-M*	C130-C		V-247-M		TC411-OPE5		PT457	PT457-MPG
T55-M		C-132-C Series		B-249	B2 or V2-F*	T-411-PE		S458	

* These Part Numbers are also Obsolete.

BALDWIN OBSOLETE PRODUCTS

OBSOLETE NUMBER	REPLACED BY	OBSOLETE NUMBER	REPLACED BY	OBSOLETE NUMBER	REPLACED BY	OBSOLETE NUMBER	REPLACED BY	OBSOLETE NUMBER	REPLACED BY
TB460-CPE25		PT569-10		PA-684		F-802-A	PF802	PF-880	
T-460-PE		P-570		PT684	PT8400-MPG	F-803-A		PF-881	
BT464	BT8860	PT570-10		PA-685		PF803		PF-885	
P-464		PT572-10		PT685	PT685-MPG	F-804-A	PF804	BF887	
PT465		PT574-10		PA-686		F-805-A		BF889	
P-466		PT575		PT686		F-806-C		PF-889	
P-467		B-576 Kit		PA-687		F808-A		PF-893-GR	PF893
PT467	PT467-MPG	BF580	BF5800	PT687		F-808-P	PF828	PF-894-GR	PF894
PT468	PT468-MPG	BF580-B	BF5800-B*	PA-689		F-809-P	PF809	BF895	
T-468-R		BF581	BF5810	PA-690		F-811-A		PF-895	
P-470		BF581-B	BF5810-B*	PA-692		PF-812	PF906	SF-898-GR	SF898
PT-472 Kit		PF589	PF7789*	PA-694	PA642	F813-F		F901-C	
S-473		PF589-10	PF7789-10*	PA695		PF-813	F813-F*	F902-C1	
PT-474		PF589-30E	PF7789-30*	PA-698		B-815-O		F-902-S	PF902-S
PT478	PT478-MPG*	PF589-E		C701-L	C704-L	BF815	BF7713	F-903-C	PF-903*
PT478-MPG		PF589-E		C702-L	C704-L	F-815-A		PF-902-3	
S-478		PF590	PF7790*	C703-L		F817-F		PF-903	
PT481	P446	PF590-10	PF7790-10*	C-704-L Poly	C704-L	F-818-A	F800-A*	F-904-C	PF904*
PT482	PT482-MPG*	PF590-30	PF7790-30*	PF590-30	C704-L	PF819-HD		PF904	
PT482-MPG	PT725-MPG	PF590-30E	PF7790-30*	F-704-L	P7040*	F-820-P	PF820-S	F905-C	
S-482		PF590-E		C705-L		F-820-S		F-905-W	
S-483		C-59-C3	C59-C*	PV706-M	P706-M	PF-821	PF821-S	F906-C	
PT484		PF599-30		PV-706-M Poly	PV706-M*	F-823-P	PF823	PF-906-S	PF906
P-486		PF599-30		PT-707	PT707-HD	PF823(2)	(2) PF823-E	F-910-C	PF910
PT487 KIT	PT487	PA-601	PA602	PT-707-10	PT707-HD10		w/5H-5601	F911-C	PF926
P-488		PF601		VT-708		PF823(3)	(3) PF823-E	F911-DL	PF952
S489		PA-603		C-709-L			w/8M-7830	F-911-W	
PT491(2)	(2) PT491	PA-605		VT-710		PF823(4)	(4) PF823-E	PF-911	F911-C* (Depth); PF926 (Paper)
BK495-A		BT606	BT606-MPG	V-711			w/7M-8286*	V-911-C	F911-C*
BK495-B		PA-606		V-712	P718*	PF823(6)	(6) PF823-E	F-912-W	
P-495		B608	B227	V-713			w/G219, (2) 4L-8212-R	PF-914	
PT-499	PT499-5	PA-608		PT714		PF824(2)	(2) PF824	R915	BF915
T500-MD		PA-609		P718		F828-F		F917-C	
T502-AMD		BT610	BT610-MPG	V-718-FF	P718*	BF830		BF918	BF918-K
T-503-MD		PA-610		P-719		PF-830		P-718	
V504-MD		BT611	BT611-MPG	P-720		BF832	BF7713	F-919-C3	(3) F919-C
P505		PA-611		PT-727	PT727-HD	PF-832		w/5B-1581, 7B-8037	
P-506		PA-614	PA650	PT-727-10	PT727-HD10	F-833-P		F-919-C4	(4) F919-C
PT508	PT508-MPG	PA-619		PT-727-HD5		F-835-M			w/(2) 7B-7635
P-509		PA-620		PT728	PT728-MPG	V835-M		F-919-C5	(5) F919-C
PT509 Kit	PT509-MPG Kit	PA-622		V-728-O		F-836-F			w/3H-5671*, 3H5673*
T-509-E		PA-623	PA602	PT730	PT8361	PF-837		F-919-A6	(6) F919-C
F-510-S		SA-624		BT731 Kit	BT8308-MPG Kit	BF-839	BT839		w/(2) 7B-7635
V-510-S		PA-626		BT734	BT8851-MPG	BF-840-K2	BF833-K2	F-919-C6	(6) F919-C
P-511		PA-627		V736-O		BF-840-K3	BF836-K3		w/(2) 7B-7999*
P-511-HD		PA-628	PA634	PT-737-5		BF-840-K4	BF836-K4	F-919-A9	(9) F919-C
F-515-O		PA-629		BT742	BT8870-MPG	BF-841			w/2F-9341*, 2F-9342*
EL-518		PA-630		V-743-O		BT841		F-919-B9	(9) F919-C
F-518-O		PA-635	PA-603*	V743-T		V842-O	VT842-O		w/1H-4511*, 1H4514-R*
V-518-O		PA-636		BT744	BT8862	F848-A		F-919-C9	(9) F919-C
B519	B1400	PA-637		BT745	BT8844	PF-849	PT849		w/(2) 7B-7664
P-519		PA-640-HD		BT746	BT8845	BF850		F-919-C10	(10) F919-C
PT520-10		PA-646	PA2007	BT747	BT8846	BF850-K			w/8F-7715*, 8F-7716*
BT523	BT8803-MPG	PA647		BT748	BT8840-MPG	BF851	BF833	F-919-C12	(12) F919-C
PT-523	PT561	PA656 FOAM		BT749	BT8852-MPG	PF-851			w/6B-2955*, 7B-8017
BT-524	B2	PA659		C-750-EP		PF-852		F-919-A17	(17) F919-C
P524	P294	BF660	BF1179	C-750-L Poly	C750-L	PF-853			w/9F-1805*, 9F-1806*
EL-527		PA-660		C-750-LS	C750-L	PF-854		F-919-C17	(17) F919-C
B530	B1402	T-660-P		F-750-L	P7500	V-854-O	V854-T*		w/2F-9228*, 2F-9231*
PT-530	PT390* or PT391*	BF661		PT754		V854-T		P-920	
S-530		PA-661		PT755		PF-855		F921-C	
PT531		PA-663	PA675	PT756		PF-856	PF859	F922-C	
S-531		PA-664	PA664-1*	PT-757-5		PF-858		F923-C	
PT-532-10	PT482*	PA664 Foam	PA664-1 Foam*	BT758	BT8850-MPG	F-861-C		F924-C	PF924
S-532		PA664-1		C759		F-862-C	F924-C*	BF925	
PT533	PT8331-MPG	PA664-1 FOAM		PT-760	PT760-10 or PT760-25	F-863-C		F925-C	
S-533		PA-665		PT762		PF-865		F927-C	
P540-S	P540	PA-667		PT769	PT8395 or PT8396	BF867	BF7713	PF-928	
PT542		PA-668		BT770	BT8861	F-867-M		PF-929	
PT544		PA-672		BT771	BT8863	PF-867		F-930-C	
PT-544-10		PA-673		PT773	PT773-MPG	PF-868		PF-930	
PT-547		PA-674		PT776	PT776-MPG	PF870	PF7521*	T931-3T	
PT552		PA-676		V-780-S		F871-F		V931-W(8)	
BF553		PA-679		BF785-MPG		F-872-A		F-932-C	
PT-553-10		PT679	PT23490-MPG	BF787	BF1280	PF-873		F-933-C	
BT-556		PA-681		BF793		BF875		BF934	
PT557-10		PT681	PT23489-MPG	BF796	BF7546	BF876-B	BF876	F-934-C	
PT559		PA-682		BF799-D	BF7639-D	BF877-B	BF877	P-937-C8	
PT562		PA-682(2)		F800-A		F878-F			
		PA-683		F801-P		BF880	BF880-FP		

* These Part Numbers are also Obsolete.

BALDWIN OBSOLETE PRODUCTS

OBSOLETE NUMBER	REPLACED BY	OBSOLETE NUMBER	REPLACED BY	OBSOLETE NUMBER	REPLACED BY	OBSOLETE NUMBER	REPLACED BY	OBSOLETE NUMBER	REPLACED BY
F-941-C		V-1055-O		BF1272-SP	BF1272-SPS	PA-1612		PA-1740	
BF944		BF1058			(Oval Sensor) or	PA-1612-1A	PA1754	PA-1741	
PF-944	PF947	BF1059			BF1293-SPS	PA1616		PA-1741 Foam	
BF948-B	BF948	V-1060-O			(Rectangular Sensor)	PA-1617		PA-1744-WPC	
BF948-D		V-1074-O		F-1280-C		PA-1620-2S	PA1620-S	PA-1742	
BF-948-D Kit	BF948-D*	BF1103		BF1284-SP	BF1399-SP	PA1621-S		PA-1743	
F-949-F	PF949	BF1106	BF1100	BF1290-O		PA1622		PA-1744	
F950F-WO	F950-F	BF1107	BF1155*	BF1295-O		PA-1623-S		PA-1744-FN	
P-951	PT951	BF1108	BF1179	CK1300	FB1301,	PA-1624		PA-1744-K	
BF-953		BF1109	BF1108*		FB1302, OB1303	PA-1628		PA-1745	
F-954-F		BF1111		FK1304		PA1632 FOAM		PA-1746	
PF-956		BF1112		BF1321	BF1212	PA-1636-2		PA-1747	
BF957-B	BF957	BF1116	BF1120*	BF1322	BF5813	PA-1636-2K		PA-1751	
BF-957-D Kit	BF957-D	BF1117		BF1323	BF1214	PA-1638		PA-1752	
B-958	BT839-10	BF1118		BF1324	BF1220	PA-1640	PA2007	PA-1753	
BT-958	BT839-10	BF1120		BK1327	B7577, OB1308	V1650-O		PA-1756	
F-959-C		BF1121	BF1123	BK1328	B95, OB1303	PA-1651(2)		PA-1759	
PF-960	P960	BF1126		BF1329-O	BF46083-O	PA-1652		PA-1760	
F961-C		BF1127		BF1341	BF1212	PA-1654		PA-1761	
BF964		BF1128		BF1342	BF5813	PA-1655		PA-1762	
F-964-C		BF1129		BF1343	BF1214	PA-1656	PA2140 (Cars)	PA-1764	
BF965		BF1130		BF1344	BF1220		PA2139 (Comp.)	PA-1766	
PF-965		BF1131		BF1351-SP	BF9811-SP	V-1657-O		PA-1767	
PF-966		BF1133		BF1352-SP	BF1352-SPS	PA1658		PA1770	
F-969-M		BF1135	BF1100	BF1354-SP	BF1354-SPS	PA-1659		PA-1785	
BF972		BF1136	BF1100	BF1366	BF1366-O	PA-1660		PA-1791	
BF-973	BF970	V-1136-O		OB1369		PA-1660 Special	PA2698	PA-1792	
PF-973		BF1137	BF1100	BF1383	BF1383-O	PA-1662		PA-1793	
PF-973 Kit	PF-973*	BF1138		B1401	B1400	PA-1665		PA-1796	PA1815
BF976-B	BF976	BF1139	BF1105	B1403	BD1403	PA-1668		PA-1796-K	PA1815
F-976-W		BF1144	BF1100	B1404	B245*	PA-1671		PA-1799	PA1848
B-977 Kit	BK6710	BF1145		B1408		PA-1672		PA1800 FOAM	
BF-977		BF1149	BF1191	B1412	B33	PA-1676	PA1863	PA-1801	
PF-980		BF1152	BF1100	B1415		PA-1677		PA-1803	
BF-981		BF1153	BF1100	B1420	B173-S	PA-1678(2)		PA1804	
BF982		BF1155		B1423	B113	PA-1685		PA1807	
BF-983	BF970	V-1155-C		B1424		PA-1690		PA-1808	
BF-985	BF991	BF1156		B1427	B421	PA-1691		SA-1809	
PF-988		BF1157	BF1100	HC-1430		PA-1693		PA1810-WPC	
BF-989 Kit		BF1158	BF1100	P1439	P1445	PA-1694		PA-1811	
BF990		BF1162		B1442	B1429	PA-1695		PA-1812	
BF-993	BF988	BF1165		P1445	P7442	PA-1700 Ele.		PA-1813-FN	
PF994		BF1167	BF1057	V1500-R		PA1700 FOAM		PA-1820	
P-997		BF1168	BF1057	V1506-FF		PA-1700 Scr.		PA-1822	
P999	P999-HD	BF1169		V1506-R		PA-1701 Scr.		PA-1829	
P-999 Kit		BF1175		V-1507-R		PA1702 Ele.		PA-1833	
P-999-B Kit		BF1183		V1509-R		PA-1702 Scr.		PA-1835	
B1000-CD	P996	BF1186		F-1510-R	P1510	PA-1703 Ele.		PA-1837	
B1001-N		BF1188		PF-1510	P1510	PA1703 FOAM		PA-1838	
B-1002-CD	B1000-CD*	BF1190		PF-1510-7		PA-1703 Scr.		PA-1838-K	
F1002-C		BF1192		V-1510-R	P1510	PA1706XP		PA1839-FN	
B-1003-N		BF1194		V-1515-R		PA-1708-FN	PA2657-FN	PA-1842	
BF1003		BF1196		V-1530-FF		PA-1711		PA-1843	
BF1004		BF1202	BF1237*	V1530-R		PA1713		PA-1844	
B-1004-N		BF1203	BF1236*	F-1540-C		PA-1714 Ele.		LL1847-FN	
B1005-N		BF1212-HP	BF1212	P1564		PA-1714 Foam		PA-1847	
BF1006		BF1212-W		P1566		PA-1714 Scr.		PA-1850	
B-1007-N		BF1229	BF1230*	P1569		PA-1715		PA-1853	
BF1007		BF1230	BF1222 or BF1222-SP	P1570		PA-1716		PA1853-FN	
B-1008-N		BF1234	BF1205 or BF1205-SP	P1571		PA-1716-FN		PA-1853-K	
V1009-W		BF1235	BF1257	P1572		PA-1717		PA-1854	
BF1010		BF1236	BF7673*	P1573		PA-1720		PA1855	
P-1010-L		BF1237	BF7674*	P1574		PA-1722		PA-1856	PA-2000*
PV-1010-L	P-1010-L*	BF1238	BF7672*	P1575		PA-1723		PA-1862	PA1885
F-1030-C		F-1240-C		P1576		PA-1724		LL1864-FN	
V-1030-C		V-1240-O		P1578		PA-1725		PA-1869	
B1031		V-1240-O1		P1579		PA-1727		PA-1870	
B-1032		BF1241	BF7679*	PF1580		PA-1728		PA-1871	
F-1033-O		F-1241-C		PF1581		PA-1728-1		PA-1872	
V-1033-O		V-1241-C		PF1582		PA1729		PA-1874	PA1884
F-1035-C		V-1250-O		PF1583		PA-1730		PA-1876	
V-1035-C		V-1251-O		PF1586		PA-1731		PA-1878	
T-1036-B		BF1254	BF7681*	PF1587		PA-1732		PA-1879	
V-1037-A		BF1255	BF7677*	PF1588		PA-1733		PA-1883	
V-1038-T		BF1259-W		PF1589		PA-1734		PA1887	
F-1040-O		BF1260	BF1283	PF1590		PA-1736		PA-1890	
V1040-C		BF1260-SP	BF1283-SP	PA-1601		PA-1737		PA-1902	
F-1050-O		BF1263-SP	BF1272-SP*	PA-1604		PA-1738		PA-1903	
BF1051		BF1264-SP	BF1274-SP	PA-1605		PA-1738(3)		PA-1908	
BF1054			or BF1274-SPS	PA-1611		PA1739		PA-1910	

* These Part Numbers are also Obsolete.

BALDWIN OBSOLETE PRODUCTS

OBSOLETE NUMBER	REPLACED BY	OBSOLETE NUMBER	REPLACED BY	OBSOLETE NUMBER	REPLACED BY	OBSOLETE NUMBER	REPLACED BY	OBSOLETE NUMBER	REPLACED BY
PA-1914		SA-2038.....SA2045 (Pad Only)		PA2203		PA2597		PA2974	
PA-1917		SA2040		PA2205		PA2600		PA2975	
PA-1918		PA-2043		PA2206		PA2603		PA2981	
PA-1918-K.....PA1667-FN		SA2045		PA2207		PA-2627 Ele.		PA2983	
LL1922-FN.....PA1922-FN		SA2046		PA2209		PA2639		PA2985	
PA-1923		PA-2047		PA2210		LL2641		PA2986	
PA-1924		PA-2048.....PA648		PA2211		LL2656.....PA2656		PA2987	
PA1925		SA2048		PA2213		LL2659.....PA2659		AD2990	
LL1926.....PA1926		PA-2049		PA2217		LL2663-FN.....PA2663-FN		AK2990	
PA-1927		PA2054		PA2219		PA2671		AD2991	
PA-1927-FN		PA2055		PA2220		LL2675.....PA2675		AK2991.....AD2991* & PA2735	
PA-1928.....PA1848		PA-2056		PA2227		LL2679.....PA2679		AD2992	
PA-1929		PA2057		PA2228		PA2681		AK2992.....AD2992* & PA2737	
PA-1930-FN		PA-2058		PA2229		PA2682-FN		AD2993	
PA-1931(2)		PA2059		PA2235		PA2683		AK2993.....AD2993* & PA2625	
PA-1933		PA-2060		PA2236		PA2685.....LL2685		AD2994	
PA-1935		PA2062		PA2238		PA2686		AK2994.....AD2994* & PA2738	
PA-1938		PA2066		PA2239		PA2695		AD2995	
PA-1939		PA2078		PA2242		PA2696		AK2995	
PA-1939-FN		PA-2080		PA2245.....PA2243		PA2697		AD2997	
PA-1939-K		PA2082		PA2246		PA2698-K		AK2997.....AD2997* & PA2739	
PA1942		SA2086		PA2259		PA2717		AD2998	
PA1943		SA2087		PA2309		PA2720		AK2998	
PA-1944		PA2088		PA-2311-FN		LL2734.....PA2734		AD2999	
PA-1947		PA2089		LL2316.....PA2316		PA2741.....PA3467		AK2999	
PA-1948		PA2090		PA-2324.....PA-2324-1*		LL2749.....PA2749		AD3000	
F-1950-O		PA-2098		PA-2324-1		PA2759		AK3000	
PA-1950		PA-2101.....PA2101A		PA-2324-K.....PA-2324-1*		PA2760		HSG3000	
V1950-O		PA2105		PA2325		PA2763		AD3001	
PA1954		PA2108		PA-2326-WO.....PA2326		PA2770		AK3001	
PA-1955		PA2111		PA2327		LL2780.....LL2503		HSG3001	
PA-1958		PA2112		PA-2334		PA2780.....PA2503		AD3002	
PA-1959		PA2115 FOAM		PA-2336		LL2783		AK3002	
PA-1962		PA2118		PA2348-FN		PA2795		HSG3002	
PA-1964		PA2119		PA-2355		PA2800-FN		HSG3003	
PA-1965		PA2120		LL2357.....PA2357		PA2802.....PA3499		HSG3004	
PA-1966		PA2122		PA-2365.....PA2546		PA2804 KIT.....PA2804		HSG3005	
PA-1968-FN		PA2123		PA-2366.....PA2547		PA2808		HSG3006	
PA-1968-K		PA2126		PA2373		PA2809		HSG3007	
PA-1970		PA2128		LL2382.....PA2382		PA2810		HSG3008	
PA1971		PA2129		LL2389-FN.....PA2389-FN		PA2811		HSG3009	
PA1974		PA2130		C2400-A		PA2841		HSG3010	
LL1979-FN.....PA1979-FN		PA2131		V-2400-A.....C2400-A*		PA2850		HSG3011	
LL1980-FN		PA2132		PA2406		PA2859.....PA2859-FN		HSG3012	
PA1983		PA2133		PA2416.....PA2845		PA2862 FOAM		HSG3013	
PA-1986 Kit.....PA1986-K		PA2137		LL2438.....PA2438		PA2863.....RS2863		HSG3014	
PA-1987 Kit.....PA-1987-K*		PA2141		PA2441		PA2868-FN.....PA2778-FN		HSG3015	
PA-1987-K		PA2142		PA2449-K		PA2873		HSG3016	
PA-1990		PA2143		LL2461.....PA2461		PA2879-FN		HSG3017	
PA-1991-FN		SA2144		PA2463		PA2882		HSG3018	
LL1992-FN		PA2145		LL2465.....PA2465		PA2883		HSG3019	
PA1992.....LL1992		PA2146		PA-2470.....PA2667		PA2887-FN		HSG3020	
PA-1993.....PA2546		PA2151		PA-2471.....PA2668		PA2889		HSG3021	
PA-1994.....PA2547		PA2155		PA2480		PA2890		HSG3022	
PA-1999		PA2157		PA2481		PA2893.....PA3477		HSG3023	
PA-2000		V-2160-O		PA2492		PA2894-FN		HSG3024	
PA-2003		PA2161		LL2494.....PA2494		PA2898		HSG3025	
PA2004		PA2165		PA2501.....PA3951		PA2899		HSG3026	
PA2008 FOAM		PA2166		PA-2505		PA2901		HSG3027	
PA-2011		PA2170		PA2506		PA2907		HSG3028	
PA-2012		PA2172		LL2515		PA2910		HSG3029	
PA-2013.....PA1802		PA2173		LL2516.....PA2516		PA2911		HSG3030	
PA2014		PA2174		LL2520.....PA2520		PA2916-FN.....PA3664-FN		HSG3031	
PA2015		PA2175		LL2531.....PA2531		PA2919		HSG3032	
PA-2016		PA2176		LL2532.....PA2532		PA2920		HSG3033	
PA-2017		PA2177		LL2533.....PA2533		PA2926-FN		HSG3034	
PA-2018		PA2179		PA-2537		PA2927-FN		HSG3035	
PA-2019		PA2180		PA2543		PA2929		HSG3036	
PA-2020		PA2184		PA2549		PA2929-FN		HSG3037	
PA-2021		PA2185		PA2553		PA2933		HSG3038	
PA-2022		PA2187		LL2555.....PA2555		PA2934.....PA3445*		HSG3039	
PA2025		PA2188		LL2556.....PA2556		PA2935		HSG3040	
PA-2026		PA2190		LL2558.....PA2558		PA2937.....PA2698		HSG3041.....HSG3069*	
PA-2028		PA2192		PA2560		PA2939.....PA2855		HSG3042	
PA-2029		PA2195		PA2561		PA2940		HSG3043	
PA-2030		PA2197		PA2565		PA2941		HSG3044	
PA-2032		PA2198		PA2584		PA2965		HSG3045	
PA-2033		PA2199		PA2590		PA2966		HSG3046	
PA2034		PA2201		PA2594		PA2969.....PA2689		HSG3047	
PA2035		PA2202		LL2596.....PA2596		PA2972-FN		HSG3048	

▼ Parts Available Now in Kits Only.

* These Part Numbers are also Obsolete.

BALDWIN OBSOLETE PRODUCTS

OBSOLETE NUMBER	REPLACED BY	OBSOLETE NUMBER	REPLACED BY	OBSOLETE NUMBER	REPLACED BY	OBSOLETE NUMBER	REPLACED BY	OBSOLETE NUMBER	REPLACED BY
HSG3049		AH3250		AR3330		PA3663		PA4136	PA4155 KIT
HSG3050		AH3251		AW3332		PA3665		SA4137	
HSG3051		AH3252		AW3333		PA3666-FN		SA4139	
HSG3052		AH3253		AW3334		PA3673		PA4140	
HSG3053		AH3254		AW3335		PA3677		SA4142	
HSG3054		AH3255		AW3336		RS3702	RS3988	SA4143	
HSG3055		AH3256		AW3337		PA3751-FN		PA4155 KIT	
HSG3056		AH3257		AW3338		PA3752		PA4186	
HSG3057	HSG3070*	AH3258		AW3339		PA3753		OAS4200	
HSG3058		AH3259		AW3340		PA3759		OAS4201	
HSG3059		AH3260		AW3341		PA3762		OAS4202	
HSG3060		AH3261		AS3343		PA3766		OAS4203	
HSG3061		AS3262		AS3344		PA3769		OAS4204	
HSG3062		AS3263		AD3345		PA3770		OAS4205	
HSG3063		AS3264		AS3346		PA3771		OAS4206	
HSG3064		AS3265		AD3347		PA3772		OAS4207	
HSG3065	HSG3064*	AS3266		AS3348		PA3776		OAS4208	
HSG3066	HSG3059*	AS3267		PA3400		PA3784		OAS4209	
HSG3067	HSG3068*	AS3268		PA3401		PA3793		OAS4210	
HSG3068		AS3269		PA3402		PA3821		OAS4211	
HSG3069		AS3270	AS3269*	PA3403		PA3837		OAS4212	
HSG3070		AS3271		PA3405		PA3842		OAS4213	
HSG3072		AS3272		PA3407		PA3845		OAS4214	
HSG3073		AS3273		PA3408		PA3856		OAS4215	
HSG3074		AS3274		PA3409		PA3857		OAS4216	
HSG3075		AS3275		PA3410	PA3410-FN*	PA3858		OAS4217	
HSG3076		AB3276		PA3410-FN		PA3866	PA2489	OAS4218	
HSG3079		AB3277		PA3412		PA3876		OAS4219	
HSG3080		AB3278		PA3413		PA3947		OAS4220	
AE3200		AB3279		PA3418		PA3961		OAS4221	
AS3200		AB3280	AB3312*	PA3423-FN		PA3962		OAS4222	
AE3201		AB3281	AB3314*	PA3424-FN		BF-4000		OAS4223	
AE3202		AB3282		PA3425		PF4001		OAS4224	
AE3203		AB3283		PA3441		WF4002-M		OAS4225	
AE3204		AB3284		PA3445		WF4003-M		OAS4226	
AE3205		AB3285		PA3449		PA4004		OAS4227	
AE3206		AC3286		PA3450		BF-4010		OAS4228	
AE3207		AC3287		PA3451		PF4011		OAS4229	
AE3208		AC3288		PA3454		WF4012-A		OAS4230	
AE3209		AC3289		PA3459		WF4013-A		OAS4231	
AE3210		AC3290		PA3462		PA4014		OAS4232	
AE3211		AC3291		PA3465		PA4019		OAS4233	
AE3212		AC3292		PA3468		PA4020		OAS4234	
AE3213		AC3293		PA3497		PA4026		OAS4235	
AE3214		AC3294		AD3522		PA4031		OAS4236	
AE3215		AC3295		AD3523		WG-4033		OAS4237	
AE3216		AC3296		AD3524		PA4034		OAS4238	
AE3217		AC3297		AD3525		PA4036		OAS4239	
AE3218		AC3298		AD3526		PA4038		OAS4240	
AE3219		AC3299		AD3527		PA4039		OAS4241	
AE3220		AC3300		RS3546	RS3954	PA4040		OAS4242	
AE3221		AC3301		PA3552		PA4047		OAS4243	
AE3222		AH3302		PA3559		PA4051		OAS4244	
AE3223		AH3303		PA3561		PA4052		OAS4245	
AE3224		AH3304		PA3564	PA3606	PA4053		OAS4246	
AE3225		AS3305		PA3567		PA4054		OAS4247	
AE3226		AS3306		PA3570	PA3691	PA4058		OAS4248	
AE3227		AB3307		PA3571		PA4061		OAS4249	
AE3228		AB3308		PA3574		PA4064		OAS4250	
AE3229		AB3309		PA3577		PA4067		OAS4251	
AE3230		AB3310		PA3580		PA4068		OAS4252	
AE3231		AB3311	AB3278*	PA3582-FN	PA3671-FN	PA4074	PA3763	OAS4253	
AE3232		AB3312		PA3583	PA3672	PA4076		OAS4254	
AE3233		AB3313		PA3586		PA4082		OAS4255	
AE3234		AB3314		PA3589		PA4083	PA4081	OAS4256	
AE3235		AB3315		PA3590		PA4086	PA4416 KIT	OAS4257	
AE3236		AV3316		PA3591		PA4087		OAS4258	
AE3237		AV3317		PA3592		PA4090		OAS4259	
AE3238		AV3318		PA3593		PA4094		OAS4260	
AH3239		AV3319		PA3594		PA4095		OAS4261	
AH3240		AC3320		PA3599		PA4096		OAS4262	
AH3241		AC3321		PA3603		PA4097		OAS4263	
AH3242		AC3322		PA3610		PA4098		OAS4264	
AH3243		AR3323		PA3634		PA4101		OAS4265	
AH3244		AR3324		PA3639		PA4115	PA4154	OAS4266	
AH3245		AR3325		PA3646-FN		PA4116		OAS4267	
AH3246		AR3326		PA3647		PA4117		OAS4268	
AH3247		AR3327		PA3648		PA4122	PA4163	OAS4269	
AH3248		AR3328		PA3659		PA4124		OAS4270	
AH3249		AR3329		PA3662		PA4135		OAS4271	

* These Part Numbers are also Obsolete.

BALDWIN OBSOLETE PRODUCTS

OBSOLETE NUMBER	REPLACED BY	OBSOLETE NUMBER	REPLACED BY	OBSOLETE NUMBER	REPLACED BY	OBSOLETE NUMBER	REPLACED BY	OBSOLETE NUMBER	REPLACED BY
OAS4272		PA4712		PA4835		PA4980		PA5480	
OAS4273		PA4714		PA4836		PA4981		PA5481	
OAS4274		PA4717		PA4837		PA4982		PA5487	
OAS4275		PA4718		PA4838		PA4998.....	PA4820	RS5488	
OAS4276		PA4719		PA4839		CS-5001.....		PA5501.....	RS5782
OAS4277		PA4721		PA4840		CS-5002.....	CS5008	PA5502.....	RS5783
OAS4278		PA4722-FN		PA4841		CS-5003.....	CS5009	PA5518	
OAS4279		PA4723		PA4842		CS-5004.....	CS5011	PA5519	
OAS4280		PA4724-FN		PA4843		CS-5005.....	CS5010	PA5521	
OAS4281		PA4725		PA4844		CK5006B		PA5522	
OAS4282		PA4726		PA4845		CT5006A		PA5523	
OAS4283		PA4727		PA4846		CTK5006.....	CTK5029	PA5524	
OAS4284		PA4728		PA4847		CSC5014		PA5525	
OAS4285		PA4729		PA4849		CT5026A		PA5526	
OAS4286		PA4731		PA4850		CT5026B		PA5527	
OAS4287		PA4735		PA4851		CTK5026.....	CTK5029	PA5530	
OAS4288		PA4738		PA4854 FOAM		CTK5027.....	CTK5029	PA5531	
OAS4289		PA4739		PA4856		CS5055		PA5532	
OAS4290		PA4741		PA4865-FN		OTK5062		PA5533	
OAS4291		PA4742		PA4866		LB-5100 Kit		RS5542.....	RS30142, RS30142 KIT
OAS4292		PA4743		PA4867		WF5100		PA5545	
OAS4293		PA4744		PA4868-FN		WF5101		RS5550	
OAS4294		PA4745		PA4869		BW-5120		PA5551	
OAS4295		PA4746		PA4873		BWC-5120		PA5552	
OAS4296		PA4747		PA4874		BW-5121		PA5553	
OAS4297		PA4748		PA4875		BWC-5121		PA5554	
OAS4298		PA4748 FOAM		PA4879		C5130-P		PA5555	
OAS4299		PA4749		PA4880		CW5130-P		PA5560	
OAS4300		PA4751		PA4882		CW-5130-PWP.....	CW5130-P* & WF4002-M*	PA5561	
OAS4301		PA4752		PA4884				PA5562	
OAS4302		PA4756		PA4888		CWC-5130-P		PA5564	
PA4319		PA4757		PA4892		CWC-5130-PWP		PA5565	
PA4353		PA4759		PA4893		CW5131-P		PA5567	
PA4354		PA4761		PA4894		CWC-5131-P		PA5568	
PA4357		PA4762 FOAM		PA4898		CW-5132-P.....	(2) CW5131-P*	PA5569	
PA4369		PA4765 FOAM		PA4901		CW5132-PWP.....	(2) CW5131-P* & WF4003-M*	PA5570	
PA4375		PA4767		PA4904				PA5571	
PA4380		PA4768		PA4906		CWC-5132-P		PA5572	
PA4382		PA4770		PA4907		CWC-5132-PWP		PA5573	
PA4387		PA4771.....	PA4689	PA4909		BW-5133.....	BW5139	PA5574	
PA4389		PA4772		PA4910		BW-5133-A.....	BW-5133*	PA5575	
PA4392		PA4774		PA4913		BW-5133-Z.....	BW-5133*	PA5576	
PA4395		PA4776		PA4914		BWC-5133		PA5577	
PA4396		PA4777		PA4915		BWC-5133-Z		PA5578	
PA4403		PA4779		PA4916		BW-5134.....	BW5137	PA5579	
PA4406 KIT		PA4780		PA4917		BW-5134-Z.....	BW-5134*	PA5582.....	PA30026
PA4407		PA4780 FOAM		PA4920		BWC-5134		PA5585	
PA4408		PA4782		PA4921		BWC-5134-A		PA5590 KIT	
PA4414		PA4783		PA4922		BWC-5134-Z		RS5591.....	RS5591XP
PA4415		PA4784		PA4923		BW-5135.....	BW5136	BA5592.....	BA5374
PA4420		PA4785		PA4924		CW5150-L		RS5593.....	RS5593XP
PA4424		PA4786		PA4925		BW5170.....	BW5070	PA5594	
PA4427		PA4787		PA4926		BW5171.....	BW5071	PA5596	
PA4467		PA4788.....	PA4389	PA4927		BW5173.....	BW5073	PA5598	
PA4556		PA4789		PA4928		BW5174.....	BW5074	PA5599	
RS4584.....	RS4634	PA4790		PA4933		BW-5176.....	BW5178	PA5600 KIT	
PA4607		PA4791		PA4935		BW-5177.....	BW5179	PA5601 KIT	
PA4612		PA4792		PA4936		BW5180		PA5603 KIT	
PA4615		PA4796		PA4937		BW5181		PA5608 KIT	
PA4621		PA4797		PA4940		PA5286 KIT		PA5609 KIT	
PA4626		PA4798		PA4941		RS5295.....	RS30191	PA5612 KIT	
PA4640.....	PA4640-FN	PA4799		PA4943		RS5296.....	RS30192	PA5613 KIT	
PA4645-FN		PA4800		PA4944		PA5307		PA5614 KIT	
PA4658		PA4801		PA4946.....	PA4938	PA5324-FN		PA5615 KIT	
PA4668		PA4805		PA4947		PA5330		PA5616 KIT	
PA4669		RS4807		PA4948		RS5347		PA5634	
PA4670		PA4808		PA4949		RS5348		PA5635	
PA4684		PA4810		PA4950		RS5362.....	RS30065, RS30065 KIT (w/Lid)	RS5639 KIT	
PA4685		PA4811		PA4951.....	PA4947			PA5643	
RS4686.....	RS4678	PA4812.....	PA3672	PA4952		BA5372		PA5644	
RS4687.....	RS4679	PA4814		PA4953		PA5394		PA5645	
PA4688		PA4815		PA4954		PA5402		PA5646	
PA4688 FOAM		PA4816		PA4957		PA5406-FN		PA5647	
PA4689		PA4817		PA4958		PA5407		PA5648	
PA4689 FOAM		PA4818		PA4964-FN		RS5438		PA5659	
PA4690		PA4821		PA4965		PA5444-FN		PA5660	
PA4691		PA4822		PA4974		PA5469		RS5671	
PA4696 FOAM		PA4826		PA4975		PA5473		RS5677 KIT	
PA4699		PA4828		PA4976.....	PA3872	PA5474		PA5687	
PA4710		PA4832		PA4978		PA5476		PA5688	

* These Part Numbers are also Obsolete.

BALDWIN OBSOLETE PRODUCTS

OBSOLETE NUMBER	REPLACED BY	OBSOLETE NUMBER	REPLACED BY	OBSOLETE NUMBER	REPLACED BY	OBSOLETE NUMBER	REPLACED BY	OBSOLETE NUMBER	REPLACED BY
PA5701		BK6259		BK6534		BK6946		B7460	
PA5702		BK6260		BK6537		BK6947		B7462	
PA5704		BK6261		BK6540		BK6948		B7464	B7370
PA5705		BK6266		BK6547		BK6949		B7465	
PA5714		BK6269		BK6553		BK6950		B7466	
PA5715		BK6271		BK6555		BK6951		B7470	
PA5717		BK6284		BK6556	BK6575*	BK6952		B7472	
PA5718 KIT		BK6289		BK6557		BK6981		B7473	
PA5721		BK6299		BK6558		BK6988		B7474	
PA5724		BK6300		BK6565		BK6993		B7475	
PA5724 FOAM		BK6301		BK6573		BK6996		B7476	
PA5726		BK6302		BK6575		B7006		B7478	
PA5732		BK6303		BK6580		B7008-D	B7019	B7481	
PA5737 KIT		BK6310		BK6582		B7026	B7026-MPG	B7482	
PA5740		BK6311		BK6584		B7027	B7085*	P7484	
RS5760 KIT		BK6312		BK6585		B7032	B7130	B-7500	B7500A*
PA5769 KIT		BK6313		BK6588		B7040	B7040-A*	B-7500 Kit	
PA5775		BK6314		BK6589		B7040-A		B7500A	
PA5777		BK6316		BK6590		B7040-CH	B7040-A*	B7500A-CH	
PA5778		BK6317		BK6592		B7040-PR	B7040-A*	B-7500-CH	B7500A-CH*
PA5779		BK6318		BK6593		BF7040		B-7500-PR	B7500A*
PA5785		BK6321		BK6594		BH7040	B7040-A*	BF7500	BF7500-A*
PA5786		BK6327		BK6596		BH7040-CH	B7040-A*	BF7500-A	
PA5787		BK6342		BK6602		BH7040-PR	B7040-A*	BH-7500	B7500A*
PA5798		BK6348		BK6603		F7040		BH-7500-CH	B7500A-CH*
PA5799		BK6350	BK6371*	BK6604		P7040	C704-L	BH-7500-PR	B7500A*
BF5800-B	BF5800	BK6351		BK6605		P7040 POLY	P7040*	C-7500-M	P7500
BF5810-B	BF5810	BK6352		BK6606		BD7041	BD7166	P7500 POLY	P7500
6010		BK6355		BK6609		B7043		P7500 SINGLE	P7500
6011		BK6370		BK6611		B7046		P7514	
6012		BK6371		BK6612		P7055		EL7518	
6013		BK6374		BK6614		PT-707-HD5		PF7520	PF7799
6014		BK6381		PA-664-1 Ele.		B7079		PF7521	PF7655
6015		BK6384		PA-664-1 Scr.		B7085	B7144	BF7523	
6016		BK6385		BK6649		P7087		BF7524	BF788
6018		BK6386		BK6660		P7088		BF7525	BF970
6019		BK6388		BK6669		BD7100		BF7526	B605
BK6034		BK6389		BK6671		B7108	B7004	BF7530-MPG	BF7632
BK6041		BK6395		BK6674		B7109	B7585	BF7533	BF7535
BK6043		BK6398		BK6685		B7118	B7144	BF7539	BF7644
BK6044		BK6400		BK6691		BD7120		BF7542	
BK6046		BK6401		BK6701		BC7140	BC7194	BF7543	
BK6047		BK6404		BK6708		B7149		PF7547	
BK6048		BK6411		BK6709		B7150	B7180	PF7548	PF7620*
BK6052		BK6413		BK6712		P7198	P1443		(Cat, Cummins)
BK6063		BK6416		BK6718		BT7237-MPG	BT7237	PF7621*	
BK6066		BK6418		BK6722		BD7244	BD7105		(Detroit)
BK6072		BK6419		BK6742		C7253		K-7550 Kit	BK6355*
BK6074		BK6420		BK6788		P7254		BF7557-B	BF7557
BK6077		BK6421		BK6792		P7257		B7575	B7577
BK6078		BK6423		BK6793		P7258		B7577-B	B7577
BK6079		BK6430		BK6800		P7261		K-7577 Kit	BK6401
BK6181		BK6431		BK6802		P7262		PF7578	PF7678
BK6186		BK6432		BK6804		P7265		BF7581	BF7646*
BK6189		BK6433		BK6806		P7266		BF7582	BF7647*
BK6200		BK6435		BK6807		B7272	B7402	PF7583	
BK6203		BK6439		BK6808		B7278		K-7596 Kit	BK6350*
BK6206		BK6444		BK6810		B7279		P7599	
BK6209		BK6452		BK6811		B7282		BF7601	BF954
BK6210		BK6456		BK6818		B7283		BF7609	
BK6211		BK6463		BK6826		B7284		PF7610	PF7651*
BK6212		BK6471		BK6829		B7288	B7217	PF7611	
BK6217		BK6475		BK6830		B7296		PF7620	PF7680
BK6220		BK6479		BK6831		P7300	P1562	PF7621	PF7680
BK6221		BK6481		BK6832		P7301		BF7626	
BK6223		BK6485		BK6834		P7302		B7637	
BK6226		BK6496		BK6838		C7304		BF7641	
BK6227		BK6498		BK6839		BT7339	BT7349	P7642	
BK6229		BK6500		BK6900		BD7353	BD40027	BF7643	BF7682*
BK6230		BK6504		BK6901		P7354	P40019	BF7646	BF7674*
BK6231		BK6509		BK6902		BD7355	BD40139	BF7647	BF7681*
BK6233		BK6510		BK6906		B7369		BF7649	BF7672*
BK6236		BK6511		BK6907		P7371		BF7650	BF7679*
BK6237		BK6514		BK6908		P7381		PF7651	PF7751
BK6238		BK6516		BK6939		B7389		BF7652	BF7674-D
BK6239		BK6520		BK6940		B7392		PF7654	PF7777
BK6240		BK6523		BK6941		P7405	P7505	BF7660	BF1163
BK6243		BK6526		BK6943		B7429		BF7662	
BK6247		BK6530		BK6944		B7457		BF7665	BF7675*
BK6254		BK6531		BK6945		B7459		BF7672	BF7672-D

* These Part Numbers are also Obsolete.

BALDWIN OBSOLETE PRODUCTS

OBSOLETE NUMBER	REPLACED BY	OBSOLETE NUMBER	REPLACED BY	OBSOLETE NUMBER	REPLACED BY	OBSOLETE NUMBER	REPLACED BY	OBSOLETE NUMBER	REPLACED BY
BF7673	BF7673-D	H8040	H9040	H8120		BT8934		PT9216	
BF7674	BF7674-D	H8041	H9041	H8121		BT8936		PT9218	
BF7675	BF7675-D	H8042	H9042	H8122		BT8938-MPG		PT9219	
BF7677	BF7677-D	H8043	H9043	H8123	H9123	PT8938-MPG		PT9220	
BF7679	BF7679-D	H8044	H9044	BT8300	BT8871-MPG*	PT8941-MPG		PT9221	
BF7681	BF7681-D	H8045	H9045	BT8303	BT8304	PT8942-MPG		PT9226	
BF7682	BF7682-D	H8046	H9046	BT8311	BT8873	PT8944-MPG		PT9228	
PF7688	PF7688	H8047	H9047	BT8313	BT8874-MPG	PT8949-MPG		H9229	
BF7689	BF7689	H8048	H9048	BT8315	BT8512	PT8953-MPG		H9230	
BF7710	BF7765	H8049	H9049	PT8321	PT8378-MPG	PT8961-MPG	PT9337-MPG	H9232	
BF7723		H8050	H9050	BT8324		PT8963-MPG		H9233	PT320-MPG
BF7724		H8051	H9051	BT8325		PT8964-MPG	PT9403-MPG	H9234	
BF7727	BF7827*	H8052		BT8327	BT8856-MPG	PT8965-MPG		PT9235-MPG	PT9350-MPG
BF7739	BF7801	H8053	H9053*	PT8336		PT8966-MPG		PT9236-MPG	
PF7789	PF7889	H8054	H9054	PT8337		PT8968-MPG		PT9241	
PF7789-10	PF7889-10	H8055	H9055	BT8340-MPG	BT8876-MPG	PT8973-MPG	PT8458-MPG	PT9243	
PF7789-30	PF7889-30	H8056	H9056	C8342		PT8976-MPG		PT9246	
PF7790	PF7890	H8057	H9057	PT8343		PT8977-MPG		PT9249	
PF7790-10	PF7890-10	H8058	H9058	PT8358		PT8979-MPG		PT9252	
PF7790-30	PF7890-30	H8059		BT8360	BT8871-MPG	PT8983-MPG		PT9253-MPG	
BF7807		H8060	H9060	PT8362		PT8986-MPG		PT9257	
BF7821		H8061		PT8364	PT8370-MPG	PT8988-MPG		PT9259	
BF7827	BF9882*, BF46062	H8062	H9062	PT8374-MPG		PT8993-MPG		PT9262-MPG	
PF7829		H8063		BT8377-MPG	BT8853-MPG	PT8999-MPG		PT9263	
PF7831		H8064		BT8379	BT8437	PT9000-MPG		PT9265	
PF7834		H8065		BT8380	PT8380	H9006		PT9269	
PF7835		H8066		PT8389	PT23282-MPG	H9010		PT9270	
BF7846		H8067		BT8398-MPG		H9015		PT9271	
BF7856		H8068		BT8399	BT8444	H9018		PT9273	
BF7858	BF7693	H8069	H9069	PT8402-MPG		H9024		PT9274	
BF7859		H8070	H9070	PT8405-MPG KIT		H9029		PT9275	
BF7861		H8071	H9071		PT8515-MPG KIT*	H9037		PT9276	
BF7867		H8072	H9072	PT8406-MPG KIT		H9039		PT9280	
BF7868		H8073	H9073		PT8516-MPG KIT*	H9040		PT9281	
BF7870		H8074	H9074	BT8424-MPG		H9042-V		PT9284-MPG	
BF7871		H8075	H9075	BT8434	B114	H9053		PT9285-MPG	
PF7902	FD7926 & BF7925	H8076	H9076	BT8454	BT9422	H9057		PT9292-MPG	
BF7918	BF7972	H8077	H9077	BT8466-MPG		H9095		PT9294-MPG	
BF7933 KIT	BF9918 KIT	H8078	H9078	PT8467		H9097		PT9295-MPG	
BF7953-D	BF7951-D	H8079	H9079	PT8469-MPG		PT9124-MPG		PT9298-MPG	
H8000		H8080	H9080	PT8515-MPG KIT		PT9125		PT9299-MPG	
H8001	H9001	H8081	H9081		PT9415-MPG KIT	PT9125-MPG		PT9301-MPG	PT9359-MPG
H8002		H8082	H9082	PT8516-MPG KIT		PT9126		PT9302-MPG	
H8003		H8083	H9083		PT9416-MPG KIT	PT9127		H9305	
H8004		H8084	H9084	OV8700		PT9128		PT9312-MPG	
H8005		H8085	H9085	OV8701		PT9130		PT9314-MPG	
H8006	H9006*	H8086	H9086	OS8702		PT9133		PT9317-MPG	PT8975-MPG
H8007	H9007	H8087		OS8703		PT9138		BT9319-MPG	
H8008		H8088		OS8704		PT9141		BT9322	
H8009		H8089		OS8705		PT9146		BT9323	
H8010	H9010*	H8090		OS8706		PT9147		BT9325	
H8011		H8091		OS8707		PT9151		PT9332	
H8012		H8092	H9092	OS8717		PT9154		PT9333	
H8013	H9013	H8093	H9093	OS8718		PT9155		PT9334-MPG	
H8014	H9014	H8094		OB8720		PT9156		PT9335-MPG	
H8015		H8095	H9095*	OB8724		PT9159		PT9336	
H8016		H8096	H9096	OB8726		PT9160		PT9412-MPG	
H8017		H8097	H9097	OV8728		PT9163		PT9415	
H8018	H9018	H8098		OB8740		PT9165		BT9437	
H8019		H8099		OB8741		PT9166		PT9453-MPG	
H8020	H9020	H8100		OB8744		PT9171		PT9463	
H8021	H9021	H8101		OB8745		PT9173		PT9473	
H8022		H8102		OB8746		PT9177		PT9474	
H8023		H8103	H9103	OB8771		PT9178		PT9480-MPG	
H8024	H9024	H8104		OB8772		PT9182		PT9485-MPG	
H8025		H8105		OB8781		PT9184		PT9497-MPG	
H8026		H8106		OB8783		PT9190		PT9498-MPG	
H8027		H8107	H9107	BT8806-MPG		PT9192		PT9500-MPG	
H8028		H8108	H9108	BT8807-MPG	BT8800-MPG	PT9194		PT9506	
H8029	H9029*	H8109		BT8860	BT8861	PT9198		PT9512	
H8030		H8110	H9110	BT8871-MPG	BT8876-MPG	PT9200		PT9514	
H8031		H8111	H9111	BT8914		PT9201		PT9531	
H8032		H8112	H9112	BT8916		PT9202		PF9806 KIT	PF9924 KIT
H8033		H8113	H9113	BT8921		PT9204		BF9813	
H8034		H8114	H9114	BT8923		PT9205		BF9819	
H8035		H8115		BT8924		PT9206		BF9824	
H8036	H9036	H8116		BT8925		PT9207		PF9824	
H8037	H9037	H8117		BT8929		PT9209		PF9825	
H8038		H8118		BT8932		BT9211	BT8474	BF9832	
H8039	H9039	H8119		BT8933		PT9213		PF9838	

* These Part Numbers are also Obsolete.

DAHL OBSOLETE PRODUCTS

OBSOLETE NUMBER	REPLACED BY	OBSOLETE NUMBER	REPLACED BY	OBSOLETE NUMBER	REPLACED BY	OBSOLETE NUMBER	REPLACED BY	OBSOLETE NUMBER	REPLACED BY
BF9840		19615	19739	PT23158		PT23325		PT23428-MPG	
BF9843		19623		PT23159		PT23326		PT23429-MPG	
PF9845		19631		PT23161		PT23327		PT23430-MPG	
BF9849		19658		PT23162		PT23328		PT23431-MPG	
BF9853		19666		PT23164		PT23329		PT23432-MPG	
BF9854		19674		PT23165		PT23330		PT23433-MPG	
CA9872		19682		PT23170		PT23331		PT23434-MPG	
BF9882	BF46062	19691		PT23171		PT23332		PT23435-MPG	
PF9896 KIT		19801		PT23173		PT23333		PT23436-MPG	
PF9900		19852		PT23175		PT23334		PT23437-MPG	
PF9902		19861		PT23177		PT23335		PT23438-MPG	
PF9909		19879		PT23180		PT23336		PT23439-MPG	
BF9926-O		19887		PT23183		PT23337		PT23440-MPG	
PA10013		19895		PT23188		PT23338-MPG		PT23443-MPG	
18000		19909		PT23191		PT23339-MPG		PT23446-MPG	
18001		19917		PT23192		PT23340-MPG		PT23448-MPG	
18003		19925		PT23194-MPG		PT23341-MPG		PT23452	
18005		19933		PT23195-MPG		PT23342-MPG		PT23453	
18006	18033	19941		PT23196-MPG		PT23343-MPG		PT23457	
18008	18022	19950	18032	PT23198-MPG		PT23344-MPG		PT23459	
18011		19968	18032	PT23199-MPG		PT23346-MPG		PT23460	
18012		19976		PT23204-MPG		PT23347-MPG		PT23462	
18014		19984		PT23205-MPG		PT23348-MPG		PT23465	
18015		19993		PT23208-MPG		PT23349-MPG		PT23466	PA4876
18016		19994		PT23210-MPG		PT23350-MPG		PT23469	
18017		19995		PT23212-MPG		PT23351-MPG		PT23474	
18018		19997		PT23214-MPG		PT23352-MPG		PT23479	
18019		19998	18010	PT23218-MPG		PT23353-MPG		PT23480	
18020		20001		PT23221-MPG		PT23354-MPG		PT23481	
18021		20009		PT23222-MPG		PT23355-MPG		PT23483-MPG	
18023		20041		PT23225-MPG		PT23359-MPG		PT23484-MPG	
18026		PT23004		PT23226-MPG		PT23360-MPG		PT23485-MPG	
18028		PT23008		PT23228-MPG		PT23361-MPG		PT23486-MPG	
18030		PT23012		PT23230-MPG		PT23362-MPG		PT23487-MPG	
18031		PT23013		PT23233-MPG		PT23364-MPG		PT23488-MPG	
18040		PT23014		PT23235-MPG		PT23367-MPG		PT23497-MPG	
18058		PT23015		PT23236-MPG		PT23369-MPG		PT23498-MPG	
18066	18155	PT23019		PT23238-MPG		PT23370-MPG		PT23503-MPG	
18074		PT23021		PT23243-MPG		PT23372-MPG		PT23504-MPG	
18082		PT23022		PT23249-MPG		PT23373-MPG		PT23506-MPG	
18091		PT23023		PT23252-MPG		PT23377-MPG		PT23511-MPG	
18112		PT23025		PT23255-MPG		PT23378-MPG		PT23512-MPG	
18121		PT23027		PT23256-MPG		PT23379-MPG		PT23522-MPG	
18147		PT23031-MPG		PT23257-MPG		PT23381-MPG		PT23524-MPG	
18163		PT23050-MPG		PT23258-MPG		PT23382-MPG		PT23527	
18180	18025	PT23053-MPG		PT23259-MPG		PT23384-MPG		PT23528-MPG	
18201		PT23054-MPG		PT23261-MPG		PT23385-MPG		PT23534	
18210		PT23055-MPG		PT23262-MPG		PT23387-MPG		PA30097	
18228		PT23056-MPG		PT23263-MPG		PT23388-MPG		RS30241 KIT	
18253		PT23057-MPG		PT23265-MPG		PT23390-MPG		RS30289	RS30220
18254	18264	PT23058-MPG		PT23268-MPG	H9001	PT23391-MPG		B40122	
18255	18265	PT23065-MPG		PT23269-MPG		PT23392-MPG		BF46013	
18256		PT23068-MPG		PT23270-MPG		PT23393-MPG		BF46034	BF46233
18257		PT23071-MPG		PT23271-MPG		PT23397-MPG		PF46086	
18258		PT23072-MPG		PT23274-MPG		PT23399-MPG		BF46095-O	
18261		PT23073-MPG		PT23275-MPG		PT23400-MPG		BF46124-O	
18262		PT23074-MPG		PT23276-MPG		PT23401-MPG		BF46197	
18266		PT23075-MPG		PT23278-MPG		PT23402-MPG		OAS98004	
18269		PT23094-MPG		PT23280-MPG		PT23403-MPG		OAS98007	
18270		PT23096-MPG		PT23283-MPG		PT23404-MPG		OAS98008	
18273		PT23099-MPG		PT23284-MPG		PT23405-MPG		OAS98011	
18274		PT23100-MPG		PT23288-MPG		PT23406-MPG		OAS98013	
18275		PT23102-MPG		PT23289-MPG		PT23408-MPG		OAS98014	
18277		PT23104-MPG		PT23293-MPG		PT23409-MPG		OAS98018	
18278		PT23105-MPG		PT23308		PT23410-MPG		OAS98021	
18281		PT23106-MPG		PT23309		PT23411-MPG		OAS98025	
18283		PT23109-MPG		PT23310		PT23412-MPG		OAS98026	
18284		PT23113-MPG		PT23311		PT23413-MPG		OAS98027	
18286		PT23115-MPG		PT23312		PT23415-MPG		OAS98030	
18287		PT23116-MPG		PT23313		PT23417-MPG		OAS98034	
18288	18024	PT23118-MPG		PT23314		PT23418-MPG		OAS98035	
18289		PT23119-MPG		PT23315		PT23419-MPG		OAS98036	
18290		PT23130-MPG	PT23396-MPG	PT23316		PT23420-MPG		OAS98037	
18291		PT23134-MPG		PT23317		PT23421-MPG		OAS98039	
19551		PT23144		PT23318		PT23422-MPG		OAS98040	
19569		PT23146		PT23319		PT23423-MPG		OAS98041	
19577		PT23147		PT23320		PT23424-MPG		OAS98043	
19585		PT23150		PT23321		PT23425-MPG		OAS98044	
19593		PT23151		PT23322		PT23426-MPG		OAS98046	
19607	18112	PT23153		PT23323		PT23427-MPG		OAS98047	

* These Part Numbers are also Obsolete.

BALDWIN OBSOLETE PRODUCTS

OBSOLETE NUMBER	REPLACED BY	OBSOLETE NUMBER	REPLACED BY	OBSOLETE NUMBER	REPLACED BY	OBSOLETE NUMBER	REPLACED BY	OBSOLETE NUMBER	REPLACED BY
OAS98048		DAHL OBSOLETES		150-15		300-AL		1010-10x8DTA	
OAS98049		85-P		150-16		300-BP		1010-10x8DTB	
OAS98051OAS98057	85-VK6x6		150-17		300-DB		1010-10x8DTC	
OAS98052		85-VK10x8		150-22		300-DB W/O		1010-10x8DTD	
OAS98054		85-VK10x10		150-24		300-DB5		1010-10x10	
OAS98055OAS98010	85-VK12x10		150-32		300-DB5 W/O		1010-10x10DTB	
OAS98057		85-VK12x12		150-35		300-DB5220		1010-12x10	
OAS99000		100		150-AL		300-DBA		1010-12x10DTB	
OAS99002		100-10		150-BP		300-DBA5		1010-12x12	
OAS99003		100-11		150-HBP		300-DBA220		1010-12x12DTB	
OAS99004		100-13		150-MFV		300-DHRAP5		1015-DDT	
OAS99005		100-14		150-W		300-DR		1015-F	
OAS99007		100-15		186-11		300-DR W/O		1020-6x4	
OAS99009		100-16		186-12		300-DR5		1020-6x6	
OAS99010		100-17		186-21		300-DR5 W/O		1020-10x8	
OAS99011		100-19		186-22		300-DR220		1020-10x10	
OAS99012		100-20		200-10P		300-DR5220		1020-12x10	
OAS99013		100-21H		200-11		300-DRA		1020-12x12	
OAS99015		100-21HBP		200-12		300-M		1028-F	
OAS99016		100-22		200-13		300-MBP		1030-4x4	
OAS99019		100-23		200-14		300-MF		1030-6x6	
OAS99021		100-24		200-16		300-MF3		1030-8x8	
OAS99022		100-25,26,27		200-17		300-MFV		1030-10x10	
OAS99023		100-33		200-18		300-MFV3		1030-12x12	
OAS99024		100-35		200-19A		300-MM		1040-6x4	
OAS99026		100-36		200-20		300-MM30		1040-6x4B	
OAS99027		100-AL		200-21AL		300-MMV		1040-6x6	
OAS99030		100-BMK		200-22		300-MMV3		1040-10x6	
OAS99031		100-BMKBP		200-23		300-MMV3-30		1040-10x8	
OAS99032		100-BMKH		200-24		300-MMV3BP		1040-10x12	
OAS99033		100-CUT		200-25,26,27		300-MMV30		1040-12x8	
OAS99036		100-DGK		200-30T		300-MPC		1040-12x12	
OAS99037		100-H		200-32		300-SB		1063-BK1	
OAS99039		100-HBP		200-33		300-SB5		1063-BK2	
OAS99040		100-HBP		200-34		300-SB12V		1063-BK3	
OAS99041		100-M		200-AL		300-SB22		1063-D	
OAS99042		100-M30		200-BP		300-SBBP		1063-F	
OAS99043		100-MMV30		200-CUT		300-SR		1072-B	
OAS99044		100-MMVBP		200-DGK		300-W		DEMO-100 MINI	
OAS99045		100-MPC		200-HBP		500-15		EA-002	
OAS99046		100-W/O		200-HN		500-BK1		EC-005	
		100-W/OBP		200-M		500-BP		EC-112	
		101-A		200-M30		500-MFVBP		EM-03D11	
		140 KIT		200-MBP		500-MFVBP22		EM-05D11	
		140-10		200-MMV30		500-SBBP W/O		HH4	
		140-12		200-MPC		1010-6x4		HH6	
		140-25 KIT		200-SR		1010-6x4DTD		HH8	
		143-6L KIT		200-W		1010-6x6		HH10	
		143-6L9 KIT		300-14		1010-6x6DTC		HH12	
		150-10		300-16		1010-6x6DTD			
		150-14		300-35		1010-10x8			

* These Part Numbers are also Obsolete.

NOTES

ABBREVIATIONS USED ANYWHERE IN OUR CATALOGS

2WD2-Wheel Drive
4WD4-Wheel Drive

A. Gskt. Attached Gasket(s)
ABS Anti-Lock Braking System
AD Anti-Drainback Valve
ADP Anti-Drainback Pipe
AirCond. Air Conditioned
or Air Conditioner
Alum. Aluminum
AMC American Motors
Amp Ampere
App Approved
Approx. Approximately
Arr. Arrangement
A.T. Automatic Transmission
ATAAC Air-to-Air Aftercooling
Attach Attachment
AutoTrans. Automatic Transmission
Aux. Auxiliary
AWD All Wheel Drive

Bbl. Barrel
BP By-Pass Valve (8-10 PSID)
B-P By-Pass
BPS By-Pass Screen
BSP British Standard Pipe Thread
BSP-PL British Standard
Pipe Parallel Thread
BTA PLUS Balanced Treatment
Additive Plus
BTE Balanced Treatment for
Ethylene Glycol Antifreeze
BTU British Thermal Unit

C Celsius, Centigrade
Calif. California
Carb. Carburetor, Carbureted
Cat Caterpillar
cc Cubic Centimeters
CCLS Closed Center Load Sensing
CES Closed Emission System
CFM Cubic Feet per Minute
CID Cubic Inch Displacement
CLN&R Clean & Reuse
Present Filter
CNG Compressed Natural Gas
Co. Company
COE Cab Over Engine
Comp. Compressor
Cont'd. Continued
Corp. Corporation
CPI Center Port Injection
CSC Coolant System Cleaner
Cu. Cubic
CVT Continuously Variable
Transmission
Cyl. Cylinder

D. Pan Deep Pan
Dbi. Double
DC Direct Current
DDA Detroit Diesel Allison
DEF Diesel Exhaust Fluid
DI Direct Injection
Div. Division
DOHC Dual Overhead Cam
Don. Donaldson

ea. Each
EFI Electronic Fuel Injection
EGR Exhaust Gas Recirculation

EHSS Electro-Hydraulic
Shuttle Shift
Ele. Element
Elec. Electric
E.M.D. Electro-Motive Division
Eng(s). Engine(s)
Equip. Equipment
Etc. Et cetera (and so forth)
EUI Electronic Unit Injector
Exc. Except
ExHiPres. Extra High Pressure
ExpHsg. Exposed Housing
ExpTank Expansion Tank
Ext. Extended

F. Fahrenheit
F. Drive Final Drive
F. Fuel Final Fuel
F. Gskt. Furnished Gasket(s)
FECV Front-End Check Valve
F-F Full-Flow
FFV Flex Fuel Vehicle
FI Fuel Injection
FidC/O Field Change-Over
FidInst. Field Installation
FP Fill Port
FRM Flame Retardant Media
Ft Foot
FWD Front Wheel Drive
FWS Fuel/Water Separator

[G] Gasket
Gal. Gallon(s)
GM, GMC General Motors
Corporation
gph Gallons per Hour
gpm Gallons per Minute
Gskt. Gasket(s)
GVW Gross Vehicle Weight

[H] Base or Housing Number
HBP High Pressure
By-Pass Valve (18-25 PSID)
HEUI Hydraulic Electronic
Unit Injector
Hgt. Height
Hi High
HiPerf. High Performance
HiPres. High Pressure
HLT High-Low Transmission
HO High Output
HP Horsepower
Hsg. Housing
HVAC Heating, Ventilation
and Air Conditioning
HvyDty. Heavy-Duty
Hyd. Hydraulic
Hz Hertz

I. Air Inner Air
I. Gskt. Integral Gasket(s)
I.D. Inside Diameter
IH, IHC International Harvester,
International Navistar
In. Inch(es)
Inc. Incorporated
Incl. Included
Ind. Industrial
Info Information
Int. International
ISO Inside-Out Flow Direction
IVT Infinitely Variable Transmission

J.C.W. John Cooper Works
JD John Deere
JIC Joint Industry Conference
Jr. Junior

KHD Klockner-Humboldt-Deutz
Kw Kilowatt

L Liters
LBP Low Pressure
By-Pass Valve (2-7 PSID)
Lb(s) Pound(s)
LGP Low Ground Pressure
L.H. Left Hand
LoPres. Low Pressure
LPG Liquefied Petroleum Gas
LPH Liters per Hour
Ltd. Limited

M-F Massey Ferguson
MBP Medium Pressure
By-Pass Valve (11-17 PSID)
Mfg. Manufacturing
Mfr. Manufacturer
MichFlPow. Michigan Fluid Power
Min. Minimum Order Quantity
mm Millimeter
M-M Minneapolis-Moline
MO Metering Orifice
M.T. Manual Transmission
Mtd. Mounted
Mtr. Motor

NPSF National Pipe Straight Fine
NPT National Pipe Thread
N/R Not Required
N/S Non-Serviceable

O. Air Outer Air
O. Gskt. Optional Gasket(s)
OBS Obsolete
O.D. Outside Diameter
OE Original Equipment
OEM Original Equipment
Manufacturer
OES Open Emission System
Off-Hwy Off-Highway
OHC Overhead Cam
OHV Overhead Valve
Olds Oldsmobile
Opt. Optional
oz. Ounce(s)

P. Cab Pressurized Cab
P. Fuel Primary Fuel
Perf. Performance
PCV Positive Crankcase Ventilation
PEEC Programmable Electronic
Engine Control
Pkg. Package
Pld. Pleated
PowBrakes Power Brakes
PowDr. Power Drive
PowrQuad Power Quad
PowShift Power Shift
PowSteer. Power Steering
Pri. Primary
PRWD Power Rear Wheel Drive
PS Integral Post Seal Gasket
PSI Pounds per Square Inch
PSID Pounds per Square Inch
Displacement

PSR Post Seal Required
Pt. Pint
PTO Power Take-Off
PZEV Partial Zero Emissions Vehicle

QR/SR Quad Range or Syncro Range
Qt. Quart
Qty. Quantity

RC Reinforced Centertube
Recirc. Recirculation
Rect. Rectangular
Res. Reservoir
RetLine Return Line
R.H. Right Hand
ROPS Roll Over Protection System
Rpl. Replaced, Replacement
rpm Revolutions per Minute
R.R. Railroad
RWD Rear Wheel Drive

S. Eng. Starter Engine
S. Fuel Secondary Fuel
S. Pan Shallow Pan
SCA Supplemental Coolant Additive
SCR Selective Catalytic Reduction
Sec. Secondary
Sgl. Single
SHBP Super High Pressure
By-Pass Valve (30-45 PSID)
SHO Super High Output
SintBronze Sintered Bronze
S/N Serial Number(s)
SOHC Single Overhead Cam
SP Sensor Port
Spd. Speed
Spec(s). Specification(s)
SPI Sequential Port Injection
Sr. Senior
SSS Synchro Shuttle Shift
Std. Standard
Steer. Steering
Sub. Substitute
SuctLine Suction Line
Sys. System

TBA To Be Announced
TBI Throttle Boded Injection
Temp. Temperature
Thd. Thread
THM Turbo-Hydrumatic
TorqConv. Torque Converter
Trans. Transmission
Turbo Turbocharger, Turbocharged
UK United Kingdom
UL, U.L. Underwriters Lab Listed
UNF Universal National Fine
U.S. United States
U.S.C.G. U.S. Coast Guard Accepted
V Volt
VapDiv. Vapor Diverter
Veh. Vehicle
Vers. Version
VIN Vehicle Identification Number
VW Volkswagen
w/ With
w/o Without
W.B. Wheel Base
XHBP Extra High Pressure
By-Pass Valve (50+ PSID)
XP Extreme Performance
Yd. Yard(s)

الاختصارات المستخدمة خلال جميع كتالوجاتنا

كوارت، ربع جالون	Qt.	لتر	L	عنصر	Ele.	الدفع الثنائي	2WD
الكمية	Qty.	صمام تحويل للضغط المنخفض (٧-٢ باوند للبوصة المربعة)	LBP	كهربي	Elec.	الدفع الرباعي	4WD
أنبوب مركزي مُقَوَّى	RC	٧-٢ باوند للبوصة المربعة	Lb(s).	قسم المحركات الكهربائية	E.M.D.	حشو ملحق	A. Gskt.
أنظمة إعادة التدوير	Recirc.	باوند	L(s).	محرك (محركات)	Eng(s).	فرامل مانعة للانزلاق	ABS
خزان	Res.	ضغط أرضي منخفض	LGP	معدات	Equip.	صمام مانع للتسرب المعاكس	AD
أنبوب الرجوع	RetLine	اليد اليسرى أو اليسار	L.H.	إنج (وهكذا)	Etc.	أنبوب مانع للتسرب المعاكس	ADP
اليد اليمنى أو اليمين	R.H.	ضغط منخفض	LoPres.	وحدة الحقن الإلكتروني	EUI	هواء مكيف أو مكيف الهواء	AirCond.
نظام الحماية من الانقلاب	ROPS	غاز نفض مسّيل	LPG	باستثناء	Exc.	ألومنيوم	Alum.
في السيارات		لتر في الساعة	LPH	ضغط عالي جداً	ExHiPres.	أمريكان موتورز	AMC
تم استبداله، بديل	Rpl.	المحدودة (المسؤولية)	Ltd.	خزان إضافي	ExpHsg.	American Motors	American Motors
عدد الدورات في الدقيقة	rpm	ميسي فيرغسون	M-F	ممتد	ExpTank	أمبير	Amp
خط السكة الحديدية	R.R.	Massey Ferguson			Ext.	معتمد	App.
الدفع الخلفي	RWD					حوالي	Approx.
		صمام تحويل بضغط متوسط (١٧-١١ باوند للبوصة المربعة)	MBP	درجة فرنهيت	F	ترتيب	Arr.
بإدارة المحرك	S. Eng.	الصنع	Mfg.	الدفع النهائي	F. Drive	النقل الأوتوماتيكي	A.T.
الوقود الثانوي	S. Fuel	حقن الوقود متعدد المداخل	MFI	الوقود النهائي	F. Fuel	التبريد اللاحق بمرور الهواء على الهواء	ATAAC
وعاء غير عميق	S. Pan	متشخان فلود باور	Mfpr.	الصمام الأمامي غير المُرجع	F. Gskt.	مُلقح، تركيبة	Attach
تخفيض تحفيزي اتقائتي	SCR	Michigan Fluid Power	MichFlPow.	التدفق الكامل	F-F	النقل الآلي،	AutoTrans.
ثانوي	Sec.	الحد الأدنى للطبية	Min	مركبة متعددة الوقود	FFV	النقل الأوتوماتيكي	
حقن الوقود المتتابع	SFI	مليمتر	mm	حقن الوقود	FI	إضافي	Aux.
فردي	Sgl.	منيابوليس مولين	M-M	التحويل في الموقع	FidC/O	سيارة الدفع الرباعي	AWD
ضغط عالي جداً صمام تحويل (٤٥-٣٠ باوند للبوصة المربعة)	SHBP	Minneapolis-Moline		التركيب في الموقع	FidInst.		
نتاج عالي جداً	SHO	فتحة معايرة	MO	مدخل التعبئة	FP		
بروزن مُلْد	SinBronze	حقن الوقود متعدد النقاط	MPI	مواد مقاومة للهلب	FRM		
الرقم المتسلسل	S/N	نقل يدوي	M.T.	قدم	Ft.		
كامة علوية مفردة	SOHC	مُركب أو مُحَمَل	Mtd.	الدفع بالعجلات الأمامية	FWD		B-P
مدخل استشعاري	SP	محرك، موتور	Mtr.	عازل الماء/الوقود	FWS		BPS
سرعة	Spd.			حشوة (المنع التسرب)	Gal.		BSP
المواصفات	Spec(s).	المواصفات القومية للوالب	NPSF	جالون	GM, GMC		BSP-PL
الحقن من مداخل متعددة بالتتابع (أو حقن الوقود المتتابع)	SPI	الأنايب الدقيقة المستقيمة	NPT	شركة جنرال موتورز	General Motors Corporation		
الأول أو الأكبر	Sr.	المواصفات القومية للوالب الأنايب	N/R	جالون في الساعة	gph		BTA PLUS
التحول المتزامن للمركبة	SSS	غير مطلوب	N/S	جالون في الدقيقة	gpm		
نقطي	Std.	غير قابل للخدمة		حشوة أو حشو	Gskt.		BTE
التوجيه، القيادة	Steer.			وزن المركبة الإجمالي	GVW		
بديل	Sub.	هواء خارجي	O. Air				BTU
أنبوب أو خرطوم ماض	SuctLine	حشوة إضافية	O. Gskt.	رقم القاعدة أو المبيت	HBP		C
		عتيق	OBS	صمام تحويل بضغط عالي (٢٥-١٨ PSI)	O.D.		درجة الحرارة المثوية (مقياس سلسيوس)
		صنع معدات أصلية	OEM	وحدة الحقن الإلكتروني الهيدروليكية	OE		Calif.
		نظام الانبعاث المفتوح	OES	Hi	OEM		كاليفورنيا
		خارج الطريق العام	Off-Hwy	HiPerf.	HEUI		المُركَب (الكربوريتور)، مُكْرَب
		كامة علوية	OHV	HiPres.	Hi		كاتربيلر Caterpillar
		صمام علوي	Olds	HLT	Hi		ستيمتور مكعب
		أولدموبيل Oldsmobile	Olds	HO	HiPerf.		نظام استشعار الحمل مغلق المركز
		إضافي	Opt.	HP	HiPres.		نظام الانبعاث المغلق
		أونس	oz.	Hsg.	HLT		حقن الوقود المركزي
		قمرة مكيفة الضغط	P. Cab	HvyDty.	HO		متر مكعب في الدقيقة
		الوقود الأساسي	P. Fuel	Hyd.	HO		الإزاحة بالبوصة المكعبة
		تهوية موجهة لعلبة المرافق	PCV	Hz	HP		تنظيف المرشح الحالي وإعادة استخدامه
		التحكم الإلكتروني المبرمج في المحرك	PEEC	I. Air	HP		قمرة فوق المحرك
		حقن الوقود المبرمج	PFI	I. Gskt.	HP		ضاغط
		عبوة	Pkg.	I.D.	Comp.		تاج
		ذو طيات، مُمَوِّج	PltD.	I.H, IHC	Cont'd.		مؤسدة
		فرامل آلية	PowBrakes	International Harvester	Corp.		حقن خلال المدخل الأوسط
		الدفع الآلي	PowDr.	International Navistar	CPI		منظف نظام التبريد
		رباعي القدرة	PowQuad	In.	CSC		مكعب
		نقل السرعة الآلي	PowShift	Incl.	Cu		أسطوانة، أسطواني
		توجيه آلي	PowSteer.	Ind.	Cyl.		
		أولي، أساسي	Pri.	Info	D. Pan		الوعاء العميق
		دفع خلفي آلي	PRWD	Int.	Dbi.		مزدوج، ضعف
		حشوة عمود متكاملة مانعة للتسرب	PS	ISO	DC		التيار الثابت
		رطل لكل بوصة مربعة	PSI	IVT	DDA		شركة ديترويت ديزل-أليسون
		إزاحة رطل لكل بوصة مربعة	PSID	J.C.W.	Detroit Diesel Allison		حقن مباشر
		يُطلب مانع للتسرب للعمود	PSR	J.D.	DI		الحقن المباشر
		بانيت	Pt.	JIC	Div.		قسم
		الطرف الناقل للقدرة (طرف زائد التدوير الذي ينقل الحركة إلى مجموعة التروس)	PTO	Jr.	DOHC		كامة علوية مزدوجة
		مركبة ذات انبعاثات ادم قرب الصفر	PZEV	KHD	Don.		دونالدسون
		طرز الجرارات كواد رينج	QR/SR	Klockner-Humboldt-Deutz	ea.		كل واحد(ة)
		Quad Range أو سينكو رينج	Quad Range	Kw	Efi.		حقن الوقود الإلكتروني
		Syncro Range	Syncro Range		EGR		إعادة تدوير العادم
					EHSS		الحركة الهيدروليكية للمركبات التي تدار كهربياً

本公司目录中出现的缩写词

2WD..... 二轮驱动	ExpHsg..... 暴露外壳	M-F..... Massey Ferguson	S. Eng..... 起动机引擎
4WD..... 四轮驱动	ExpTank..... 膨胀容箱	MBP..... 中压旁通阀(11-17 PSI)	S. Fuel..... 次要燃油
A. Gskt..... 附加垫圈	Ext..... 扩展的, 伸长的	Mfg..... 制造	S. Pan..... 浅油盘
ABS..... 防抱死制动系统	F..... 华氏	MFI..... 多点燃油喷射	SCR..... 选择性催化减少
AD..... 防回流阀	F. Drive..... 主减速器	Mfr..... 制造厂(商)	Sec..... 次要的, 二次的
ADP..... 防回流管	F. Fuel..... 最终燃油	MichFIPOw..... Michigan Fluid Power	SFI..... 顺序燃油喷射
AirCond..... 空调	F. Gskt..... 提供的垫圈	Min..... 最低订购量	Sgl..... 单
Alum..... 铝	FECV..... F 前端出油阀	mm..... 毫米	SHBP..... 超高压旁通阀(30-45 PSI)
AMC..... 美国汽车公司	F-F..... 全流式	M-M..... Minneapolis-Moline	SHO..... 超高输出
Amp..... 安培	FFV..... 灵活燃油车辆	MO..... 量孔	SintBronze..... 粉末青铜
App..... 批准	FI..... 燃油喷射	MPI..... 多点燃油喷射	S/N..... 系列号
Approx..... 大约	FidC/O..... 现场转换	M.T..... 手动变速器	SOHC..... 单顶置凸轮轴
Arr..... 安排	FidInst..... 现场安装	Mtd..... 安装的	SP..... 传感器端口
A.T..... 自动变速器	FP..... 加油孔	Mtr..... 马达	Spd..... 速度
ATAAC..... 增压中冷	FRM..... 阻燃剂	NPSF..... National Pipe Straight Fine	Spec(s)..... 规格
Attach..... 附件	Ft..... 呎	NPT..... 国家管材螺纹规范	SPI..... 顺序端口喷射
AutoTrans..... 自动变速器	FWD..... 前轮驱动	N/R..... 不要求的	Sr..... 高级, 资深
Aux..... 辅助的, 辅机	FWS..... 燃油/水分离器	N/S..... 不可修复的	SSS..... 同步换档
AWD..... 全轮驱动			Std..... 标准
	⊠..... 垫圈	O. Air..... 外部空气	Steer..... 转向
Bbl..... 桶	Gal..... 加仑	O. Gskt..... 可选垫圈	Sub..... 代替, 取代
BP..... 旁通阀(8-10 PSI)	GM, GMC..... 通用汽车公司	OBS..... 过时	SuctLine..... 进(吸)气管道
B-P..... 旁通	gph..... 每小时加仑	O.D..... 外径	
BPS..... 旁通滤网	gpm..... 每分钟加仑	OE..... 原始设备	TBA..... 待宣布
BSP..... 英国标准管材螺纹	Gskt..... 垫圈	OEM..... 原车设备生产厂	TBI..... 节气体喷射
BSP-PL..... 英国标准管材平行螺纹	GVW..... 车辆最大总质量, 总车重	OES..... 开放式排放系统	Temp..... 温度
BTA PLUS..... 增效平衡处理添加剂		Off-Hwy..... 越野	Thd..... 螺纹
BTE..... 乙二醇防冻剂平衡处理	⊠..... 底盘或外壳编号	OHC..... 顶置凸轮轴	THM..... 涡轮增压和液压自动变速
BTU..... 英国热量单位	HBP..... 高压旁通阀(18-25 PSI)	OHV..... 顶置气门	TorqConv..... 变矩器
	HEUI..... 液压电子控制泵-喷嘴	Olds..... Oldsmobile	TPI..... 顺序多点燃油喷射
C..... 摄氏, 摄氏度	Hi..... 高	Opt..... 可选, 选项	Trans..... 变速器, 传动
Calif..... 加利福尼亚	HiPerf..... 高性能	oz..... 盎司	Turbo..... 涡轮增压器, 涡轮增压的
Carb..... 化油器, 汽化的	HiPres.....		UK..... 英国
Cat..... 卡特彼勒	HLT..... 双(高/低)传动	P. Cab..... 密封驾驶室	UL, UL..... 安全检测实验室(美国)登记
cc..... 立方厘米	HO..... 高输出	P. Fuel..... 主要燃料	UNF..... Universal National Fine
CES..... 闭路排放系统	HP..... 马力	PCV..... 曲轴箱强制通风	U.S..... 美国
CFI..... 中央燃油喷射	Hsg..... 外壳	PEEC..... 编程电子引擎控制	U.S.C.G..... 美国海岸警卫队接受
CFM..... 每分钟立方呎	HvyDty..... 重型	PFI..... 程控燃油喷射	
CID..... 立方吋排量	Hyd..... 液压	Pkg..... 包, 成套	V..... 伏, 伏特
Cln&R..... 清洁后重新使用	I. Air..... 内部空气	Pltd..... 边的	VapDiv..... 蒸汽分离器
Co..... 公司	I. Gskt..... 整体式垫圈	PowBrakes..... 助力制动, 动力刹车	VIN..... 车辆识别代号
COE..... 平头汽车驾驶室	I.D..... 内径	PowDr..... 动力驱动	VV..... 可变喉管
Comp..... 压缩机	IH, IHC..... International Harvester,	PowrQuad..... PowerQuad	VW..... 大众牌汽车
Cont'd..... 续	International Navistar	PowShift..... 传动轴, 动力换档	
Corp..... 公司	In..... 吋	PowSteer..... 动力转向	w/..... 带有...
CPI..... 中央端口喷射	Inc..... 公司	Pri..... 主要的	w/o..... 不带有...
CSC..... 冷却系统清洁剂	Incl..... 包括	PRWD..... 动力后轮驱动	W.B..... 轴距
Cu..... 立方	Ind..... 工业	PS..... 整体式端口密封垫圈	
Cyl..... 汽缸	Info..... 信息, 资料	PSI..... 每平方吋磅	XHBP..... 超高压旁通阀(50+ PSI)
	Int..... 国际	PSID..... 每平方英寸排量磅	
D. Pan..... 深油盘	ISO..... 内-外流方向	PSR..... 要求端口密封: 必须在端口安装	Yd..... 码
Dbi..... 双	IVT..... 无限变速传动	Pt..... 品脱	
DC..... 直流电	J.C.W..... John Cooper Works	PTO..... 取力器, 动力输出装置	
DDA..... Detroit Diesel Allison	JD..... John Deere	PZEV..... 部分零排放车辆	
DI..... 直接喷射	JIC..... 联合工业会议		
Div..... 部门	Jr..... 之子	QR/SR..... Quad Range	
DOHC..... 双顶置凸轮轴	KHD..... Klockner-Humboldt-Deutz	or Syncro Range	
Don..... 唐纳逊(人名)	Kw..... 千瓦	Qt..... 夸特	
		Qty..... 数量	
ea..... 每个	L..... 公升	RC..... 强化中央脊梁管	
EFI..... 电子燃油喷射	LBP..... 低压旁通阀(2-7 PSI)	Recirc..... 再循环	
EGR..... 废气再循环	Lb(s)..... 磅	Rect..... 矩形	
EHSS..... 电液换行变速器	LGP..... 低对地压力	Res..... 储罐	
Ele..... 构件, 元件	L.H..... 左手, 左方	RetLine..... 回流管路	
Elec..... 电器, 电动	LoPres..... 低压	R.H..... 右手, 右方	
E.M.D..... 电动汽车部	LPG..... 液化石油气	ROPS..... 滚翻防护系统	
Eng(s)..... 引擎	LPH..... 每小时公升	Rpl..... 更换, 替换	
Equip..... 设备	Ltd..... 有限	rpm..... 每分钟转数	
Etc..... 等等		R.R..... 铁路	
EUI..... 电子控制泵-喷嘴		RWD..... 后轮驱动	
Exc..... 例外, 除了...			
ExHiPres..... 超高压			

ABREVIATIONS UTILISEES DANS NOS CATALOGUES

2WD2 Roues motrices	DonDonaldson	InclInclus, compris	PSJoint intégral de montant
4WD4 Roues motrices	eaChacun	IndIndustriel	PSIDLivres par pouce carré
A. GsktJoint(s) attaché(s)	EFI ...Injection de carburant électronique	InfoRenseignements	PSRJoint de montant nécessaire
ABS ...système de freinage antibloquant	EGRRecirculation des gaz d'échappement	IntInternational	PtPinte
ADClapet anti-retour	EHSSTransmission électro-hydraulique automatique	ISODirection d'écoulement intérieur vers extérieur	PTOPrise de force
ADPConduit anti-retour	EleElément	IVT ...Transmission à variation infinie	PZEV ..Véhicule à émissions quasi-nulles
AirCondAvec air conditionné ou climatiseur	ElecElectrique	J.C.W.John Cooper Works	QtQuart
AlumAluminium	E.M.D.Electro-Motive Division	JDJohn Deere	QtyQuantité
AMCAmerican Motors	Eng(s)Moteur(s)	JICJoint Industry Conference	RCTube central renforcé
AmpAmpère	EquipEquipement	JrJunior	RecircRecirculation
AppApprouvé	EtcEt cetera	KHDKlockner-Humboldt-Deutz	RectDe forme rectangulaire
ApproxEnviron	EUlInjecteur électronique	KwKilowatt, kW	ResRéservoir
ArrArrangement	Excexcepté	LLitres	RetLineConduite de retour
A.T. ...Boîte de vitesses automatique	ExHiPresPression très élevée	LBPVanne de dérivation basse pression (14 à 20 kPa)	R.H.Droit(e)
ATAACRefroidissement secondaire Air-Air	ExpHsgCarter exposé	Lb(s)Livres	ROPSSystème de protection en cas de renversement
AttachAccessoire	ExpTankVase d'expansion	LGPPression au sol faible	RplRemplacé, Remplacement
AutoTransBoîte de vitesses automatique	ExtProlongé	L.H.Gauche	rpmTours par minute, tr/min
AuxAuxiliaire	FFahrenheit	LoPresBasse Pression	R.R.Train, ferroviaire
AWDToutes roues motrices	F. DriveEntraînement final	LPHLitres par heure	RWDTraction arrière
BblCorps	F. FuelCarburant final	LtdLimited, Limité	S. EngMoteur de démarrage
BP ...Vanne de dérivation (55 à 69 kPa)	F. GsktJoint(s) fourni(s)	M-FMassey Ferguson	S. FuelCarburant secondaire
B-PDérivation	FECV ...Clapet antiretour d'extrémité avant	MBP ...Valve de dérivation moyenne pression (76 à 117 kPa)	S. PanBac peu profond
BPSCrépine de dérivation	F-FA plein débit	MfgFabrication	SCAAdditif supplémentaire
BSP ...Normes britanniques de tuyaux	FFVVéhicule polycarburant	MfrFabricant	SCR ...Réduction sélective catalytique
BSP-PLFiletage droit de tuyauterie aux normes britanniques	FIInjection de carburant	MichFIPOwMichigan Fluid Power	SecSecondaire
BTA PLUSAdditif de traitement équilibré Plus	FidC/OChangement sur chantier	Min ...Quantité minimum de la commande	SglUnique
BTETraitement équilibré pour antigel éthylène glycol	FidInstMontage sur le chantier	mmMillimètre	SHBPVanne de dérivation super haute pression (207 à 276 kPa)
BTUBritish Thermal Unit	FPOrifice de remplissage	M-MMinneapolis-Moline	SHORendement super élevé
CCelsius	FRMMédia ignifuge	MOOrifice de mesure	SintBronzeBronze fritté
CalifCalifornie	FtPied	M.T.Boîte de vitesse manuelle	S/NNuméro de série
Carb ...Carburateur, avec carburateur	FWDTraction avant	MtdMonté	SOHCà cames en tête unique
CatCaterpillar	FWSSéparateur carburant / eau	MtrMoteur	SPOrifice de capteur
ccCentimètres cubes	[G]Joint	NPSF ...Filetage tuyauterie NPT droit fin	SpdVitesse
CCLSDétection de charge à fermeture centrale	GalGallon	NPT ...National Pipe Thread	Spec(s)Spécification(s)
CESSystème fermé d'émissions	GM, GMC ...General Motors Corporation	N/RNon requis	SPI ...Injection séquentielle par orifice
CFMPied cube par minute	gphGallons par heure	N/SNon remplaçable	SrSenior
CIDCylindrée, en pouces cubes	gpmGallons par minute	O. AirAir extérieur	SSSTransmission synchro
CLN&RNettoyer et ré-utiliser le filtre existant	GsktJoint(s)	O. GsktJoint(s) en option	StdStandard
CNGGaz naturel comprimé	GVWPoids Total Brut	OBSPlus en usage	SteerDirection
CoCompagnie	[H]Numéro de boîtier (Notre remplacement n'est que le filtre)	O.D.Diamètre extérieur	SubRemplacement
COECabine avancée	HBPVanne de dérivation haute pression (124 à 138 kPa)	OEEquipement d'origine	SuctLineConduite d'aspiration
CompCompresseur	HEUIInjecteur électronique unité hydraulique	OEMFabricant d'équipement d'origine	SysSystème
Cont'dA suivre, suite	HgtHeight	OESSystème ouvert d'émissions	TBAÀ déterminer
CorpCorporation	HiHaut	Off-HwyHors route, de chantier	TBIinjection à étranglement
CPIInjection d'orifice centrale	HiPerfHaute performance	OHVArbre à cames en tête	TempTempérature
CSCProduit de nettoyage de circuit de refroidissement	HiPresPression élevée	OHVSoupapes en tête	ThdPas de vis
Cucube	HLT ...Boîte de vitesses hautes-basses	OldsOldsmobile	THMTurbo-Hydrématique
CVTTransmission à variation continue	HOPuissance élevée	OptEn option	TorqConv ...Convertisseur de couple
CylCylindre	HPPuissance	ozOnce	Trans ...Transmission, boîte de vitesses
D. PanCuvette profonde	HsgCarter	P. CabCabine pressurisée	TurboTurbo-compresseur
DblDouble	HVACChauffage, ventilation et conditionnement d'air	P. FuelCarburant primaire	UKRoyaume-Uni
DCCourant continu	HvyDtyService sévère	PCV ...Réaspiration des gaz du carter	UL, U.L. ...Homologué Underwriters Lab
DDADetroit Diesel Allison	HydHydraulique	PEECContrôleur moteur électronique programmable	UNFUniversal National Fine
DEFFluide d'échappement des diesels	HzHertz	PerfPerformance	U.S.Etats-Unis
DIInjection Directe	I. AirAir interne (sécurité)	PkgPaquet	U.S.C.G.Accepté par U.S. Coast Guard, Garde Côtière Américaine
DivDivision	I. GsktJoint intégral	PltDPlissé	VVolt
DOHC ...Double arbre à cames en tête	I.D.Diamètre interne	PowBrakesFreins assistés	VapDivDérivation de vapeur
	IH, IHCInternational Harvester, International Navistar	PowDrMotorisation	VehVéhicule
	InPouce	PowQuadPower Quad	VersVersion
	IncIncorporated, incorporé	PowShiftServo commande des vitesses	VIN ...Numéro d'identification du véhicule
		PowSteerDirection assistée	VWVolkswagen
		PriPrimaire, principal	w/Avec
		PRWDRoue motrice arrière	w/oSans
			W.B.Empattement
			XHBPVanne de dérivation extra haute pression (plus de 345 kPa)
			XPUltra-performant
			YdYard

ABKÜRZUNGEN, DIE IN UNSEREM KATALOG VERWENDET WERDEN

2WD 2-Rad-Antrieb	Elec. Elektrik	Jr. Junior	QR/SR Allradbetrieb oder Syncrobetrieb
4WD 4-Rad-Antrieb	E.M.D. Electro-Motive Division	KHD Klöckner-Humboldt-Deutz	Qt. Viertel Gallone
A. Gskt. beigefügte Dichtung(en)	Eng. Motor	Kw Kilowatt	Qty. Anzahl
ABS Antiblockiersystem	Equip. Ausrüstung	L Liter	RC Verstärktes Mittelrohr
AD Rücklaufsperrventil	Etc. usw.	LBP Niederdruck-Bypass-Ventil (2-7 PSID)	Recirc. Rezirkulation
ADP Rücklaufsperrrohr	EUI elektronische Einspritzzeitheit	Lb(s) Pound(s)	Rect. Rechteckig
AirCond. Klimaanlage	Exc. außen	LGP geringer Bodendruck	Res. Behälter
Alum. Aluminium	ExHiPres. sehr hoher Druck	L.H. links	RetLine Rückfuhrleitung
AMC American Motors	ExpHsg. offenes Gehäuse	LoPres. Niederdruck	R.H. rechts
Amp Ampere	ExpTank Ausdehnungstank	LPG Flüssig-Petroleumgas	ROPS Überrollkäfig
App. zugelassen	Ext. erweitert	LPH Liter pro Std.	Rpl. ersetzt, Austausch
Approx. ungefähr	F. Fahrenheit	Ltd. begrenzt	rpm UPM
Arr. Anordnung	F. Drive Endantrieb	M-F Massey Ferguson	R.R. Eisenbahn
A.T. Automobilgetriebe	F. Fuel Endbrennstoff	MBP Bypass-Ventil für mittelhohen Druck (11-17 PSID)	RWD Hinterradantrieb
ATAAC Luft-Luft-Nachkühlung	F. Gskt. mit Dichtung ausgestattet	Mfg. Herstellung	S. Eng. Anlaßmotor
Attach Befestigung	FECV vorderes Rückschlagventil	MFI Saugrohreinjection	S. Fuel sekundäres Brennstoffsystem
AutoTrans. automatisches Getriebe	F-F Hauptstrom	Mfr. Hersteller	S. Pan. Flache Wanne
Aux. Zusatz	FFV Mehrkraftstoff-Fahrzeug	MichFIPow. Michigan Fluid Power	SCR Selektive katalytische Reduktion
AWD Allradantrieb	FI Einspritzung	Min. Mindestbestellmenge	Sec. sekundär
Bbl. Vergaser-Venturi	FidC/O Feldwechsel	mm Millimeter	SFI sequentielle Kraftstoffeinspritzung
BP Bypass-Ventil (8-10 PSID)	FidInst. Feldeinbau	M-M Minneapolis-Moline	Sgl. einzeln
B-P Bypass	FP Füllanschluß	MO kalibrierte Bohrung	SHBP Extremdruck-Bypass-Ventil (30-45 PSID)
BPS Bypass-Sieb	FRM Schwer entflammbares Filtermedium	MPI Einlasskanaleinspritzung	SHO Super hohe Leistung
BSP britisches Standardrohrgewinde	Ft. Fuß (Foot)	M.T. Schaltgetriebe	SintBronze Sinterbronze
BSP-PL britisches Zylinderrohrgewinde	FWD Vorderradantrieb	Mtd. befestigt	S/N Seriennummer(n)
BTA PLUS abgestimmter Pflegezusatz Plus	FWS Kraftstoff-Wasserabscheider	Mtr. Motor	SOHC eine obenliegende Nockenwelle
BTE Ausgleichsbehandlung für Ethylenglykol-Frostschutz	ⓐ Dichtung	NPSF US-Rohrgewindenorm NPSF	SP Fühleranschluß
BTU British Thermal Unit (brit. Kalorie)	Gal. Gallone	NPT NPT-Gewinde	Spd. Geschwindigkeit
C. Grad Celsius	GM, GMC General Motors Corporation	N/R Nicht benötigt	Spec(s) Spezifikation
Calif. Kalifornien	gph Gallonen pro Std.	N/S Nicht wartbar	SPI sequentielle Kraftstoffeinspritzung
Carb. Vergaser, Vergaserausführung	gpm Gallonen pro Min.	O. Air äußere Luft	Sr. Senior
Cat Caterpillar	Gskt. Dichtung(en)	O. Gskt. zusätzliche Dichtung(en)	SSS Synchrongetriebe-Wendeschaltung
cc Kubikzentimeter	GVW Brutto Fahrzeug Gewicht	OBS. Veraltet	Std. Standard
CCLS Speicher-Lasterfassung	ⓑ Gehäusenummer (unser Ersatz ist nur der Einsatz)	O.D. äußerer Durchmesser	Steer. Lenkung
CES geschlossenes Emissionssystem	HBP Hochdruck-Bypass-Ventil (18-25 PSID)	OE Originalausstattung	Sub. Ersatz
CFI Zentraleinspritzung (Ford)	HEUI hydraulisch-elektronische Einspritzzeitheit	OEM Erstausrüster	SuctLine Ansaugleitung
CFM Kubikfuß pro Minute (ca. 28,317 l/min)	Hi Hoch	OES offenes Emissionssystem	TBA Wird noch bekannt gegeben
CID Hubraum in Kubikzoll	HiPerf. Hochleistung	Off-Hwy Gelände	TBI Zentraleinspritzung (GM)
CLN&R derzeitigen Filter reinigen und wieder verwenden	HiPres. Hochdruck	OHV hängende Ventile	Temp. Temperatur
Co. Firma	HLT Getriebe mit zusätzlicher Geländeübersetzung	Olds Oldsmobile	Thd. Gewinde
COE Frontlenker	HO hohe Leistung	Opt. wahlweise	THM Turbo-Hydratik
Comp. Kompressor	HP PS	oz. Unze	TorqConv. Drehmomentwandler
Cont'd. fortgesetzt	Hsg. Gehäuse	P. Cab Fahrerhaus unter Druck	TPI abgestimmte Anschlußinspritzung
Corp. Gesellschaft	HvyDty. hohe Beanspruchung	P. Fuel Primär-Brennstoffsystem	Trans. Getriebe
CPI Zentraleinspritzung	Hyd. Hydraulik	PCV positive Kurbelgehäuseentlüftung	Turbo [mit] Turbolader
CSC Kühlungssystemreiniger	Hz Hertz	PEEC programmierbare elektronische Motorsteuerung	UK Großbritannien
Cu. Kubik	I. Air innere (Sicherheits-) Luft	PFI programmierte Kraftstoffeinspritzung	UL, U.L. von Underwriters Lab aufgeführt
Cyl. Zylinder	I. Gskt. Integraldichtung(en)	Pkg. Packung	UNF UNF-Gewinde
D. Pan. tiefe Wanne	I.D. innerer Durchmesser	Pitd. gefaltet	U.S. Vereinigte Staaten
Dbi. doppelt	IH, IHC International Harvester, International Navistar	PowBrakes Bremskraftverstärker	U.S.C.G. akzeptiert von der U.S. Küstenwache
DC Gleichstrom	In. Inch (Zoll)	PowDr. Kraftantrieb	V Volt
DDA Detroit Diesel Allison	Inc. eingebaut	PowShift Lastschaltgetriebe	VapDiv. Dampfableiter
DI Direkte Einspritzung	Incl. beinhaltet	PowSteer. Servolenkung	VIN Fahrgestellnummer
Div. Geschäftsbereich	Ind. industriell	Pri. primär	VV Gleichdruck
DOHC zwei obenliegende Nockenwellen	Info Information	PRWD Hinterrad-Kraftantrieb	VVT Variable Ventilsteuerung
Don. Donaldson	Int. international	PS Dichtung mit integrierter Stütze	VW Volkswagen
ea. jedes	ISO Strömungsrichtung von innen nach Außen	PSID Pounds pro Quadratzoll	w/ mit
EFI Elektronisch gesteuerte Kraftstoffeinspritzung	IVT Stufenloses Getriebe	PSR Dichtung mit Stütze erforderlich	w/o ohne
EGR Abgasrückführung	J.C.W. John Cooper Works	Pt. Pint	W.B. Achsenabstand
EHSS Elektrohydraulische Wendeschaltung	JD. John Deere	PTO Zapfwellenantrieb	XHBP Extremdruck-Bypass-Ventil (>50 PSID)
Ele. Einsatz	JIC Joint Industry Conference	PZEV Partial Zero Emissions Vehicle (US-Standard für abgasarme Fahrzeuge)	Yd. Yard(s)

ABBREVIAZIONI USATE NEL NOSTRO CATALOGO

2WDTrazione su 2 ruote	Elec.Elettrico	LLitri	QR/SRRange quadrato
4WDTrazione integrale	E.M.D.Electro-Motive Division	LBPValvola di by-pass a bassa pressione (2-7 PSID)	Qt. ...Quart (Misura di capacità uguale a 1,1365 litri (ingl.) e 0,9463 (am.)
A. GsktGuarnizioni incluse	Eng(s).Motore/i	Lb(s)Libbre	Qty.Quantità
ABSSistema di frenata antibloccaggio (ABS)	Equip.Attrezzatura	LGPPressione litostatica bassa	
ADValvola di non ritorno	Etc.Eccetera	L.H.Sinistra	RCTubo centrale rinforzato
ADPTubatura di non ritorno	EUIIniettore unità elettronica	LoPres.Bassa pressione	Recirc.Ricircolo
AirCond.Ad aria condizionata oppure Condizionatore dell'aria	Exc.Eccetto	LPGGasolio liquido	Rect.Forma rettangolare
Alum.Alluminio	ExHiPres.Pressione altissima	LPHLitri all'ora	Res.Serbatoio
AMCAmerican Motors	ExpHsg.Alloggiamento esposto	Ltd. ...Società a responsabilità limitata	RetLineRitorno
AmpAmpere	ExpTankSerbatoio di espansione		R.H.Destra
App.Approvato	Ext.Esteso	M-FMassey Ferguson	ROPS ...Roll Over Protection System
Approx.Circa	FFahrenheit	MBPValvola di by-pass a media pressione (11-17 PSID)	Rpl.Sostituito, sostituzione
Arr.Disposizione	F. DriveCoppia al ponte	Mfg.Produzione	rpmGiri al minuto
A.T.Trasmissione automatica	F. FuelCarburante finale	MFI ...Iniezione carburante a più porte	R.R.Linea ferroviaria
ATAAC ...Postrefrigerazione aria-aria	F. GsktGuarnizioni fornite	Mfr.Produttore	RWDTrazione su ruote posteriori
Attach.Accessorio	FECVValvola di ritegno di testa	MichFIPowMichigan Fluid Power	
AutoTrans. ...Trasmissione automatica	F-FFlusso totale	Min.Ordine minimo	S. Eng.Motore avviatore
Aux.Ausiliario	FFVFlex Fuel Vehicle	mmMillimetro	S. FuelCarburante secondario
AWDTrazione integrale	FIIniezione del carburante	M-MMinneapolis-Moline	S. PanVaschetta poco profonda
Bbl.Cilindro	FidC/OCambiamento di campo	MOOrifizio dosatore	SCR ...Riduzione catalitica selettiva
BPValvola di bypass (8-10 PSID)	FidInst.Installazione campo	MPI ...Sistema ad iniezione multi-point	Sec.Secondario
B-PSchermo di bypass	FPPorta di riempimento	M.T.Trasmissione manuale	SFI ...Iniezione sequenziale di carburante
BSPFilettatura passo gas	FRMMezzi antifiamma	Mtd.Montato	Sgl.Singolo
BSP-PL ...Filettatura passo gas parallela	Ft.Piede	Mtr.Motore	SHBPValvola di by-pass a pressione molto alta (30-45 PSID)
BTA PLUSAdditivo per trattamento bilanciato PLUS	FWDTrazione anteriore		SHOPotenza molto elevata
BTETrattamento bilanciato per anticongelante a base di glicole etilenico	FWS ...Separatore carburante/acqua	NPSFFilettatura per tubi nazionale dritta fine	SintBronzeBronzo sinterizzato
BTUBritish Thermal Unit		NPT ...Filettatura passo gas nazionale	S/NNumero di serie
		N/RNon richiesto	SOHCSingolo albero a camma in testa
CCelsius, Centigrado	ⓂGuarnizione	NSNon idoneo al servizio	SPPorta sensore
Calif.California	GalGallone	O. AirAria esterna	Spd.Velocità
Carb.Carburatore, carburato	GM, GMC ...General Motors Corporation	O. Gskt.Guarnizioni opzionali	Spec.Specifica
CatCaterpillar	gphGalloni all'ora	OBSObsoleto	Spec(s).Specifiche
ccCentimetri cubi	gpmGalloni al minuto	O.D.Diametro esterno	SPI ...Iniezione porta sequenziale
CCLS ...Sensore di carico a centro chiuso	Gskt.Guarnizioni	OEAttrezzatura originale	Sr.Senior
CESSistema di emissione chiuso	GvwPeso lordo del veicolo	OEM ...Produttore di attrezzatura originale	SSS ...Cambio shuttle sincronizzato
CFIIniezione centralizzata del carburante	ⓂCodice base o alloggiamento	OESSistema di emissione aperto	Std.Standard
CFMPiedi cubi al minuto	HBPValvola di by-pass ad alta pressione (18-25 PSID)	Off-HwyVeicoli off-highway	Steer.Sterzo
CIDPortata in pollici cubi	HEUI ...Iniettore idraulico unità elettronica	OHCAlbero a camme in testa	Sub.Sostituito
CLN&R ...Pulire e riutilizzare il filtro in uso	HiAlto	OHVValvola in testa	SuctLineLinea d'aspirazione
Co.Società	HiPerf.Alta prestazione	OldsOldsmobile	TBADa comunicare
COEAutoveicolo con cabina sopra al motore	HiPres.Alta pressione	Opt.Opzionale	TBI ...Iniezione farfalla incorporata
Comp.Compressore	HLTTrasmissione alto-basso	oz.Oncia	Temp.Temperatura
Cont'd.Continuo	HOAlta potenza		Thd.Filettatura
Corp.Società per azioni	HPCavallo vapore	P. CabCabina pressurizzata	THMTurbo-Hydrumatic
CPIIniezione porta centrale	Hsg.Alloggiamento	P. FuelCarburante primario	TorqConv.Convertitore di coppia
CSCDepuratore sistema refrigerante	HvyDty.Servizio pesante	PCV ...Ventilazione basamento positiva	TPI ...Iniezione porta messa a punto
Cu.Cubico	Hyd.Idraulico	PEECControllo motore programmabile elettronico	Trans.Trasmissione
Cyl.Cilindro	HertzHertz	PFI ...Iniezione carburante programmata	TurboTurbocompressore a gas di scarico, sovralimentato con turbocompressore a gas di scarico
D. PanVaschetta profonda	I. AirAria interna	Pkg.Imballaggio	UKRegno Unito
Dbl.Doppio	I. Gskt.Guarnizioni integrali	Pld.Pieghettato	UL, U.L. ...Ripartato in Underwriters Lab
DCCorrente continua	I.D.Diametro interno	PowBrakesServofreni	UNFFilettatura universale fine
DDADetroit Diesel Allison	IH, IHCInternational Harvester, International Navistar	PowDrPower Drive	U.S.Stati Uniti
DIIniezione diretta	In.Pollice	PowQuadPower Quad	U.S.C.G. ...Accettato da U.S. Coast Guard
Div.Divisione	Inc.Incorporato	PowShiftPower Shift	VVolt
DOHC ...Doppio albero a camme in testa	Incl.Incluso	PowSteer.Servosterzo	VapDiv.Divertore vapore
Don.Donaldson	Ind.Industriale	PriPrimario	VIN ...Numero di identificazione del veicolo
ea.Ciascuno	Info.Informazione	PRWD ...Trazione su ruote posteriori	VVVenturi Variabile
EFI ...Iniezione elettronica del carburante	Int.Internazionale	PS ...Guarnizione integrale supporto filtro	VVTVariable Valve Timing
EGRRicircolo gas esausti	ISO ...Direzione flusso interno-esterno	PSILibbre per pollice quadrato	VWVolkswagen
EHSS ...Cambio shuttle elettroidraulico	IVT ...Trasmissione a variazione infinita	PSIDLibbre per pollice quadrato	
Ele.Elemento	J.C.W.John Cooper Works	PSRÈ necessario ermetizzare il supporto	w/Con
	JDJohn Deere	Pt.Pinta	w/oSenza
	JICJoint Industry Conference	PTOPresa di forza	W.B.Interasse ruote
	Jr.Junior	PZEV ...Partial Zero Emissions Vehicle	XHBPValvola di bypass a pressione altissima (50+ PSID)
	KHDKlockner-Humboldt-Deutz		Yd.Iarda
	KwKilowatt		

ABREVIATURAS UTILIZADAS NOS NOSSOS CATÁLOGOS

2WDtração em duas rodas	Ele.Elemento	Jr.Júnior	QR/SRTransmissão com relações Quad, ou Sincronizada
4WDtração nas quatro rodas	Elec.Electrico	KHDKlockner-Humboldt-Deutz	Qt.Um Quarto
A. Gskt.Acompanha Junta(s)	E.M.D.Divisão eletro-motiva	Kw.Quilowatt	Qty.Quantidade
ABS ...Sistema de Freio Antitravamento	Eng.Motor	LLitros	RCTubo central reforçado
ADVálvula anti-retorno	Equip.Equipamento	LBPVálvula de Contorno de Baixa Pressão (2-7 PSID)	Recirc.Recirculações
ADPTubo anti-retorno	Etc.Etecetera	Lb(s)Libra(s)	Rect.Rectangular
AirCond.Ar Condicionado	EUIInjetor de Unidade Eletrônica	LGPBaixa Pressão do solo	Res.Reservatório
Alum.Alumínio	Exc.Exceto	L.H.Esquerda	RetLineLinha de Retorno
AMCAmerican Motors	ExHiPres.Alta Pressão Extra	LoPres.Presao Barxa	R.H.Direita
AmpAmpere	ExpHsg.Carcaça exposta	LPGGás Liqüefeito de Petróleo	ROPSSistema de Proteção contra Capotagem
App.Aprovado	ExpTankTanque de expansão	LPHLitros por Hora	Rpl.Substituído, Substituição
Approx.Aproximadamente	Ext.Extensão	Ltd.Limitado	rpmRotações Por Minuto
Arr.Arranjo	F.Fahrenheit	M-FMassey Ferguson	R.R.Ferrovia
A.T.Transmissão automotiva	F. DriveÚltima marcha da transmissão	MBPVálvula de Contorno de Média Pressão (11-17 PSID)	RWDTração Traseira
ATAACPós-resfriamento ar - ar	F. Fuelcombustível, final	Mfg.Produção	S. Eng.Motor de Partida
Attach.Fixação	F. Gskt.Junta(s) fornecidas	MFIInjeção Multiponto	S. FuelCombustível Secundário
AutoTrans ...transmissão automática	FECVVálvula de verificação frente e verso	Mfr.Fabricante	S. PanCarter Raso
Aux.Auxiliar	F-FFluxo total	MichFIPowMichigan Fluid Power	SCR ...Redução Catalítica Seletiva
AWDTração em Todas as Rodas	FFV ..Veículo de Combustível Flexível	Min ...Quantidade mínima de pedido	SecSecundário
Bbl.Barril	FIInjeção de combustível	mmMilímetros	SFI ..Injeção de Combustível Sequencial
BP ...Válvula de Contorno (8-10 PSID)	FidC/OTroca no campo	M-MMinneapolis-Moline	Sgl.Único, Individual
B-PDesvio	FidInst.Instalação no campo	MOfuro para medição	SHBPVálvula de Contorno de Pressão Super Alta (30-45 PSID)
BPSTela de contorno	FPEntrada para abastecimento	MPI ..Injeção de Combustível Multiponto	SHOAlta Saída
BSPRosca norma Inglesa	FRMMeio retardante do fogo	M.T.Transmissão Manual	SintBronzeBronze Sinterizado
BSP-PLRosca Paralela de Tubos da Norma Britânica	FtPé	Mtd.Montado	S/NNumero(s) de Série
BTA PLUSAditivo Plus para Tratamento Balanceado	FWDTração dianteira	Mtr.Motor	SOHCComando de válvulas simples na cabeça
BTETratamento balanceado para anti-congelante Etileno Glicol	FWS ...Separador Combustível/Água	NPSFTubo Reto Fino Nacional	SPSuporte do Sensor
BTUUnidade Térmica Britânica	ⓂJunta	NPT ...Rosca para tubos, padrão USA	Spd.Velocidade
CCelsius, Centígrado	Gal.Galão	N/RNão Requerido	Spec(s)Especificações
Calif.California	GM, GMC ...General Motors Corporation	N/SNão Sujeito a Manutenção	SPIInjeção sequencial
Carb.Carburador, Carburado	gphGalões por hora	O. AirSaída de Ar	Sr.Senior
Cat.Caterpillar	gpmGalões por minuto	O. Gskt.Junta(s) Opcionais	SSSTransmissão Automática Contínua Sincronizada
ccCentímetros Cúbicos	Gskt.Junta(s)	OBS.Obsoleto	Std.Estandar
CCLSSensor de Carga de Centro Fechado	GVWPeso Bruto Vehicular	O.D.Diâmetro Externo	SteerDireção
CES ...Sistema de Emissões Fechado	ⓂNumero da carcaça (somente troca do elemento)	OEEquipamento Original	Sub.Substituto
CFI ..Injeção de Combustível Central	HBPVálvula de Contorno de Alta Pressão (18-25 PSID)	OEMFabricante de equipamento Original	SuctLineLinha de Sucção
CFMPés cúbicos por minuto	HEUIInjetor Hidráulico de Unidade Eletrônica	OESSistema de Emissões Aberto	TBAA Ser Anunciado
CID ...Capacidade Cúbica em Polegadas	HiAlto	Off-HwyFora de estrada	TBIInjeção de ponto simples
CLN&RLimpe e reuse o filtro	HiPerf.Alto desempenho	OHCComando de válvulas na Cabeça	Temp.Temperatura
Co.Companhia	HiPres.Alta pressão	OHVVálvulas na Cabeça	Thd.Rosca
COECabina acima do motor	HLTTransmissão alta e baixa	OldsOldsmobile	THMTurbo Hidramático
Comp.Compressor	HOAlta capacidade	Opt.Opcional	TorqConv.Conversor de Torque
Cont'd.Continuação	HPCavalo Vapor	oz.Onças	TPIInjeção ajustável
Corp.Corporação	Hsg.Carcaça	P. CabCabina Pressurizada	Trans.Transmissão
CPICorpo de injeção central	HvyDty.Serviço pesado	P. FuelCombustível Primário	TurboTurbocarregador
CSCLimpador do sistema de refrigeração	Hyd.Hidráulico	PVCVentilação Positiva do Carter	UKUnited Kingdon
CuCúbico	HzHertz	PEECControle de Motor Eletrônico Programável	UL, U.L.Registrado pelo laboratório Underwrites
Cyl.Cilindro	I. AirEntrada de Ar	PFI ..Injeção de combustível programada	UNF ...Rosca Fina Universal Americana
D. PanCuba profunda	I. Gskt.Junta inteira	Pkg.Embalagem	U.S.Estados Unidos
Dbi.Duplo	I.D.Diâmetro Interno	Pitd.Plissado	U.S.C.G.Aceito pela Guarda Costeira Americana
DCCorrente Direta	IH, IHCInternational Harvester, International Navistar	PowBrakes ...Freios servo-assistidos	VVolt
DDADetroit Diesel Allison	In.Polegada	PowDr.Unidade Propulsora	VapDiv.Derivação de Vapor
DIInj. Direccta	Inc.Incorporado	PowShift ...Transmissão Automática	VIN ..Numero de Identificação do Veículo
Div.Divisão	Incl.Incluso	PowSteer.Direção Hidráulica	VVVenturi Variável
DOHCCame Dupla no Cabeçote	Ind.Industrial	Pri.Primário	VVT ...Temporização Variável de Válvula
DonDonaldson	InfoInformação	PRWDTração traseira	VWVolkswagen
ea.cada	IntInternacional	PSJunta integral	w/Com
EFI ..Injeção eletrônica de combustível	ISO ..Semtido do fluxo de dentro para fora	PSID ...Libras por Polegada Quadrada	w/oSem
EGRRecirculação de Gases de Descarga	IVT ...Transmissão Infinitamente Variável	PSRJunta necessária	W.B.Distancia Entre Eixos
EHSSTransmissão Automática Contínua Eletrohidráulica	J.C.W.John Cooper Works	PtPintas	XHBPVálvula de Contorno de Pressão Extra Alta (50+ PSID)
	JDJohn Deere	PTOTomada de Força	
	JICJoint Industry Conference	PZEV ..Veículo de Emissão Zero Parcial	

СОКРАЩЕНИЯ, ИСПОЛЬЗУЕМЫЕ В НАШИХ КАТАЛОГАХ

2WDПривод на 2 колеса	EHSSЭлектродгидравлическая передача с сервоуправлением	KHDКомпания "Klockner-Humboldt-Deutz"	QtyКоличество
4WDПривод на 4 колеса	Ele.Элемент	KwКиловатт	RCУжесточенная центральная труба
A. Gskt.Устанавливаемая прокладка (прокладки)	Elec.Электрический	LЛитры	Recirc.Повторное использование
ABSАнтиблокировочная тормозная система	E.M.D.Отделение по работе с электрооборудованием	LBPПерепускной клапан низкого давления (2 - 7 фунт-сил на кв. дюйм)	Res.Емкость
ADКлапан, предотвращающий слив в бак	Eng.Двигатель	Lb(s).Фунт(ы)	RetLineМагистраль возврата
ADPТруба для предотвращения слива в бак	Equip.Оборудование	LGPНизкое давление на грунт	R.H.Правосторонний
AirCond.С кондиционированием воздуха или кондиционер	Etc.И т. д.	L.H.Левосторонний	ROPSСистема защиты пассажиров при переворачивании автомобиля
Alum.Алюминий	EUIЭлектронная насос-форсунка	LoPres.Низкое давление	Rpl.Заменяемый, замена
AMCКомпания "American Motors"	Exc.За исключением	LPGЖидкий нефтяной газ	rpmОборотов в минуту
AmpАмпер	ExHiPres.Сверхвысокое давление	LPHЛитры в час	R.R.Железная дорога
Appr.Утвержденный	ExpHsg.Открытый корпус	Ltd.Ограниченный или Лимитед (составляющая названий компаний)	RWDПривод на задние колеса
Approx.Приблизительно	ExpTankРасширительный бачок	M-FКомпания "Massey Ferguson"	S. Eng.Двигатель стартера
Arg.Компоновка, расположение	Ext.Расширенный	MBPПерепускной клапан среднего давления (11 - 17 фунт-сил на кв. дюйм)	S. FuelВторичное топливо
A.T.Автоматическая коробка передач	FФаренгейт	MfgПроизводственный, производство	S. PanНеглубокий поддон
ATAACВоздушное последовательное охлаждение	F. DriveГлавная передача	MFIМноготочечный впрыск топлива	SCRСелективное каталитическое восстановление
Attach.Приложение, приспособление	F. FuelТопливо после тонкой очистки	MfrПроизводитель	Sec.Вторичный, второстепенный
AutoTrans.Автоматическая коробка передач	F. Gskt.Поставляемая в комплекте прокладка (прокладки)	MfchFPow.Компания "Michigan Fluid Power"	SFIПоследовательный впрыск топлива
Aux.Дополнительный, вспомогательный	FECVПередний запорный клапан	MinМинимальный объем заказа	Sgl.Одиночный
AWDПолный привод	F-FПолный расход	mmМиллиметр	SHPBПерепускной клапан сверхвысокого давления (30 - 45 фунт-сил на кв. дюйм)
Bbl.Баррель	FFVТранспортное средство, работающее на нескольких видах топлива	M-MКомпания "Minneapolis-Moline"	SHOСо сверхвысокой производительностью
BPПерепускной клапан (8 - 10 фунт-сил на кв. дюйм)	FlВпрыск топлива	MOКалиброванное отверстие	SinBronzeСпеченная бронза
B-PСетчатый фильтр перепускного канала	FidC/OЗамена в полевых условиях	MPIМноготочечный впрыск топлива	S/NСерийный номер (номера)
BSPБританская стандартная трубная резьба	FidInst.Монтаж в полевых условиях	M.T.Ручная коробка передач	SOHCОдinarный верхний распределительный вал
BSP-PLБританская трубная резьба цилиндрической резьба	FPЗаливное отверстие	Mtd.Установленный	SPОтверсти датчика
BTA PLUSПрисадка Plus со сбалансированным составом	FRMОгнезащитные средства	Mtr.Двигатель	Spd.Скорость
BTEДобавка со сбалансированным составом для антифриза на основе этиленгликоля	FtФут	NPSFСтандарт США для труб NPSF	Spec(s).Характеристика (-ки)
BTUБританская тепловая единица (БТЕ)	FWDПередний привод	NPTНормальная трубная резьба	SPIПоследовательный впрыск во впускные каналы
CЦельсий	FWSТопливный фильтр с водоотделителем	N/SНе требуется	Sr.Старший
Calif.КалифорнияПрокладка	NVSНеобслуживаемый	SSSПередача с сервоуправлением и синхронизатором
Carb.Карбюратор, карбюрированный	Gal.Галлон	O. AirВоздух вне системы	Std.Стандарт, стандартный
CatГусеница, гусеничный ход	GM, GMCКомпания "General Motors"	O. Gskt.Дополнительная прокладка (прокладки)	Steer.Рулевое управление
ccКубические сантиметры	gphГаллоны в час	OBSУстаревший	Sub.Заменяющий, заменитель
CCLSРаспределитель с перекрытой золотником средней частью рабочего отверстия, работающий в зависимости от нагрузки	gpmГаллоны в минуту	O.D.Внешний диаметр	SuctLine.Линия всасывания
CESЗамкнутая система выпуска отработавших газов	Gskt.Прокладка (прокладки)	OE.Комплектное оборудование	TBAДолжно быть сообщено
CFIЦентральный впрыск топлива	GWVПолная масса автомобиля	OEMИзготовитель комплектного оборудования	TBIВпрыск топлива в корпус дроссельных заслонок
CFMКубические футы в минутуНомер на основании или корпусе	OESОткрытая система выпуска отработавших газов	Temp.Температура
CIDОбъем двигателя в кубических дюймах	HBPПерепускной клапан высокого давления (18 - 25 фунт-сил на кв. дюйм)	Off-HwyИспользуемый вне автомобильных дорог	Thd.Резьба
CLN&RОчистить и повторно использовать имеющийся фильтр	HEUIГидравлическая электронная насос-форсунка	ONCВерхний распределительный вал	THMФирменное название коробок передач "Turbo-Hydrmatic"
Co.Компания	HiВысокий	OHVКлапан верхнего расположения	TorqConv.Гидротрансформатор
COEКабина над двигателем	HiPerf.Высокие эксплуатационные характеристики	OldsМарка автомобилей "Oldsmobile"	TPIРегулируемый впрыск топлива во впускные каналы
Comp.Компрессор	HiPres.Высокое давление	Opt.Дополнительный	Trans.Коробка передач
Cont'd.Продолжающийся, продолжение	HLTКоробка передач с демультипликатором	oz.Унция (унции)	TurboТурбоагрегат, оборудованный турбонагнетателем
Corp.Корпорация	HOВысокопроизводительный	P. CabКабина с наддувом	UKСоединенное королевство (Великобритания и Северной Ирландии)
CPIВпрыск в центральный канал	HPЛошадиная сила	P. FuelПервичное топливо	UL, U.L.Включенный в перечень лаборатории "Underwriters Lab"
CSCСредство очистки системы охлаждения	Hsg.Корпус	PCVПринудительная вентиляция картера	UNFСтандартная мелкая резьба (UNF)
Cu.Кубический	HvyDty.Предназначенный для эксплуатации в тяжелом режиме	PEECПрограммируемая электронная система управления двигателем	U.S.Соединенный Штаты Америки
Cyl.Цилиндр	Hyd.Гидравлический	PFIПрограммируемая система впрыска топлива	U.S.C.G.Принятый Службой береговой охраны США
D. PanГлубокий поддон	Hz.Гц Hertz - герц	Pkg.Комплект	VВольт
DbI.Двойной	I. AirВоздух внутри системы	Pitd.Гофрированный, плиссированный	VapDiv.Устройство отвода паров
DCПостоянный ток	I. Gskt.Встроенная прокладка	PowBrakesТормоза с усилителем	VINИдентификационный номер автомобиля
DDAКомпания "Detroit Diesel Allison"	I.D.Внутренний диаметр	PowDr.Силовой привод	VVСмесительная камера с переменным давлением
DIНепосредственный впрыск	IH, IHCКомпании "International Harvester" и "International Navistar"	PowShiftПереключение (передач) при помощи усилителя	VVTРегулирование фаз газораспределения
Div.Отделение	In.Дюйм(ы)	PowSteer.Гидроусилитель рулевого управления	VWКомпания "Volkswagen"
DOHCДвойной верхний распределительный вал	Inc.Инкорпорейтид (составляющая названий корпораций)	Pri.Основной	w/С (предлог)
Don.Компания "Donaldson"	Incl.Включенный в комплект	PRWDСиловой привод на задние колеса	w/oБез
ea.Каждый	Ind.Промышленный	PSВстроенная прокладка стойки	W.B.Колесная база
EFIЭлектронный впрыск топлива	InfoИнформация	PSIDФунтов на квадратный дюйм	XHBPПерепускной клапан максимального сверхвысокого давления (50 и более фунт-сил на кв. дюйм)
EGRСистема повторного сжигания отработанных газов	Int.Международный	PSRТребуется прокладка стойки	Yd.Ярд(ы)
	ISOНаправление потока "изнутри наружу"	Pt.Пинта	
	IVTВариатор	PTOОтбор мощности	
	J.C.W.John Cooper Works	PZEVАвтомобиль с частично нулевыми выбросами	
	JDКомпания "John Deere"	QR/SRДиапазон четырехскоростной передачи или синхронизатора	
	JICОбщая конференция представителей промышленности	Qt.Кварта	
	Jr.Младший		

ABREVIATURAS USADAS EN CUALQUIER PARTE DE NUESTROS CATALOGOS

2WD Tracción sencilla a 2 ruedas
4WD Tracción doble a 4 ruedas

A. Gskt. Empaque(s) adjunto(s)
ABS Sistema de frenos antibloqueo
AD Válvula anti-retorno
ADP Tubo anti-retorno
AirCond. Climatizado
o acondicionador de aire

Alum. Aluminio
AMC American Motors
Amp Amperio
App Aprobado
Approx. Aproximadamente
Arr. Arreglo, disposición
A.T. Transmisión Automotriz
ATAAC Postrefrigeración de
aire a aire

Attach. Accesorio
AutoTrans. Transmisión automática
Aux. Auxiliar
AWD Tracción de cuatro ruedas

Bbl. Barril, tambor
BP Válvula de desviación (8-10 PSID)
B-P Desviación
BPS Tamiz de desvío
BSP Rosca de tubería
británica estándar
BSP-PL Rosca paralela de
tubería británica estándar
BTA PLUS Aditivo de tratamiento
equilibrado Plus
BTE Tratamiento balanceado para
anticongelante de etileno glicol
BTU Unidad térmica británica

C Celsius, centígrado
Calif. California
Carb. Carburador, carburado
Cat Caterpillar
cc Centímetros cúbicos
CCLS Detección de carga en
posición de cierre
CES Sistema de escape cerrado
CFM Pie cúbico por minuto
CID Cilindrada en pulgada cuadradas
CLN&R Limpie y reutilice
el filtro instalado

CNG Gas natural comprimido
Co Compañía
COE Cabina montada arriba del motor
Comp. Compresor
Cont'd. Continua
Corp. S.A.
CPI Inyección por Puerto Central
CSC Limpiador del sistema
de refrigeración
Cu. Cúbico
CVT Transmisión variable
continua
Cyl. Cilindro

D. Pan Colector profundo
Dbi. Doble
DC Corriente directa
DDA Detroit Diesel Allison
DEF Fluido para el flujo de
escape de vehículos diesel
DI Inj. Directa
Div. División
DOHC Árbol de levas doble en la culata
Don. Donaldson

ea. Cada uno
EFI Inyección electrónica de combustible

EGR Recirculación de gas de escape
EHSS Cambio de sentido de
desplazamiento electrohidráulico
Ele. Cartucho de repuesto
Elec. Electrico
E.M.D. División electromotriz
Eng(s). Motor(es)
Equip. Equipo
Etc. Etcétera
EUI Inyector de unidad electrónica
Exc. Excepto
ExHiPres. Muy alta presión
ExpHsg. Cáster abierto
ExpTank Tanque de expansión
Ext. Extendido

F Fahrenheit
F. Drive Tracción de transmisión final
F. Fuel Filtro final (último)
F. Gskt. Empaque(s) surtido(s)
FECV Válvula de no retorno al frente
F-F Flujo de combustible
FFV Vehículo de combustible flexible
FI Inyección de combustible
FidC/O Conversión en el campo
FidInst. Instalación en el campo
FP Puerto de llenado
FRM Medio ignífugo
Ft. Pie
FWD Tracción delantera
FWS Separador de combustible/agua

[G] Empaque
Gal. Galón
GM, GMC General Motors Corporation
gph Galones por hora
gpm Galones por minuto
Gskt. Empaque(s)
GVW Peso Bruto Vehicular

[H] Número de cáster (Nuestro
repuesto es sólo el cartucho)
HBP Válvula de desviación
de alta presión (18-25 PSID)
HEUI Inyector de unidad
hidráulica-electrónica
Hgt. Height
Hi Alto
HiPerf. Alto rendimiento
HiPres. Alta presión
HLT Transmisión alta-baja
HO Alta capacidad
HP Caballaje
Hsg. Cáster del cigüeñal
HVAC Calefacción, ventilación
y aire acondicionado
HvyDty. Servicio pesado
Hyd. Hidráulico
Hz Hertzio

I. Air Aire interior
(forma tapón de seguridad)
I. Gskt. Empaque(s) integral(es)
I.D. Diámetro interior
IH, IHC International Harvester,
International Navistar
In. Pulgada
Inc. Incorporado
Incl. Incluido
Ind. Industrial
Info Información
Int. Internacional
ISO Dirección de flujo
de adentro hacia afuera
IVT Transmision variable sin fin

J.C.W. John Cooper Works
JD John Deere
JIC Joint Industrial Conference
Jr. Junior

KHD Klockner-Humboldt-Deutz
Kw Kilovatios
L Litros
LBP Válvula de desviación
de baja presión (2-7 PSID)
Lb(s). Libra(s)
LGP Presión baja del terreno
L.H. Lado izquierdo
LoPres. Presion Baja
LPG Gas de petróleo licuado
LPH Litros por hora
Ltd. Limitado

M-F Massey Ferguson
MBP Válvula de desviación de
presión intermedia (11-17 PSID)
Mfg. Producción
Mfr. Fabricante
MichFIPow. Michigan Fluid Power
Min. Cantidad mínima a pedir
mm Milímetro
M-M Minneapolis-Moline
MO Orificio de medición
M.T. Transmision automatica
Mtd Montado
Mtr. Motor

NPSF Tubería nacional recta angosta
NPT National Pipe Thread (Rosca
nacional para tubería EE.UU.)
N/R No se requiere
N/S No se puede reparar

O. Air Aire exterior
O. Gskt. Empaque(s) opcional(es)
OBS Obsoleto
O.D. Diámetro exterior
OE Equipo original
OEM Fabricante de equipo original
OES Sistema de escape abierto
Off-Hwy Todo terreno
OHC Arbol de levas a la cabeza
OHV Válvulas a la cabeza
Olds Oldsmobile
Opt. Opcional
oz. Onza

P. Cab Cabina a presión
P. Fuel Combustible primario
PCV Ventilación positiva
de cárter del cigüeñal
PEEC Control de motor
electrónico programable
Perf. Rendimiento
Pkg. Paquete promocional
Pltd. Plegado
PowBrakes Frenos de potencia
PowDr. Unidad impulsora
PowrQuad Power Quad
PowShift Velocidades hidráulicas
PowSteer. Dirección hidráulica
Pri. Primario
PRWD Tracción Trasera de Potencia
PS Empaque integral de sello de poste
PSID Libras por pulgada cuadrada
PSR Se requiere sello de poste
Pt Pinta
PTO Toma de fuerza
PZEV Vehículo de cero
emisiones parciales

QR/SR Transmisión Quad
Range o Synchro Range
Qt. Un cuarto
Qty. La cantidad

RC Tubo central reforzado
Recirc. Recirculación
Rect. Rectangular
Res. Depósito
RetLine Línea de retorno
R.H. Lado derecho
ROPS Sistema de protección
contra vuelcos
Rpl Reemplazado, reemplazo
rpm Revoluciones por minuto
R.R. Ferrocarril
RWD Tracción trasera

S. Eng. Motor de arranque
S. Fuel Combustible secundario
S. Pan Un carter llano
SCR Reducción catalítica selectiva
SCA Aditivo de refrigerante
Suplementario
Sec. Secundario
Sgl Sencillo
SHBP Válvula de desviación de
super alta presión (30-45 PSID)
SHO Rendimiento superalto
SintBronze Bronce sinterizado
S/N Número(s) de serie
SOHC Arbol de levas único
sobre la culata
SP Puerto del sensor
Spd. La velocidad
Spec(s) Especificación(es)
SPI Inyección Secuencial por Puertos
Sr. Senior
SSS Cambio de sentido de
desplazamiento sincronizado
Std Estándar
Steer. Dirección
Sub Sustituto
SuctLine Línea de succión
Sys. Sistema
TBA A anunciarse
TBI Inyección por
el Cuerpo del Estrangulador
Temp. Temperatura
Thd. Rosca
THM Turbo-hydrumatic
TorqConv. Convertidor de torsión
Trans. Transmisión
Turbo Turboalimentado
UK Reino Unido
UL, U.L. Registrado por
Underwriters Laboratories
UNF Universal National Fine (Rosca
fina nacional universal-EE.UU.)
U.S. Estados Unidos
U.S.C.G. Aceptado por los
Guardacostas de los EE.UU.
V Voltio
VapDiv. Desviador de vapores
Veh. Vehículo
Vers. Versión
VIN Número de identificación
de vehículo
VW Volkswagen
w/ Con
w/o Sin
W.B. La distancia entre ejes
XHBP Válvula de desviación de
extra alta presión (50+ PSID)
XP Rendimiento extremo
Yd. Yarda(s)

PREFIXES AND SUFFIXES

PREFIXES

AB	Air Housing Mounting Band	H	Pall-Type Hydraulic Element
AC	Air Housing Accessory - Air Inlet Hoods or Clamps	HH	Hose
AD	Air Housing Dust Bowl, Air Filter Adapter	HSG	Air Filter Housing
AE	Air Housing Elbow	LL	Long Life Air Filter Element
AFG	Air Filter Restriction Gauge	OAS	Oil/Air Separator
AH	Air Housing Hump Hose	OB	Lube or Hydraulic Filter Base
AR	Air Housing O-Ring	OP	Plug
AS	Air Housing Sleeve, Stack Cap	OS	Electrical Indicator
AV	Air Housing Dust Ejector Valve	OTK	Oil Test Kit
AW	Air Housing Wing or Metric Nut	OV	Visual Indicator
B	Spin-on or Bag-Type Filter *	P	Paper Lube or Hydraulic Element
BA	Bag Air or Air Dryer	PA	Paper Air Element
BC	Centrifugal Element	PF	Paper Fuel Element
BD	Dual-Flow Lube Spin-on	PG	Pressure Gauge
BF	Spin-on, Can-Type or In-Line Fuel Filter	PKG	Package, Premium Item
BK	Baldwin Kit	PT	Paper Lube or Hydraulic Element
BT	Spin-on Lube or Hydraulic/Transmission Filter	PV	Paper and Vac-Cel Element *
BW	Coolant Spin-on with Chemicals	RS	Radial Seal Air Filter
C	Cotton Lube Element	S, SA, SF	Special Material *
CA	Channel Flow® Air Filter	T	Cotton Lube Element *
CFB	Coolant Filter Base	TA	Acrylic and Other Synthetic Fibers for Most Fluids; Medium Flow; 5 or 10 Micron Retention (Peco Prefix AF)
CS	Chemical Supplement	TB	Blend of Cotton and Sisal for Non-Acid Fluids; Medium to High Flow; 25 to 40 Micron Retention (Peco Prefix FTE)
CSC	Coolant System Cleaner	TC	All Cotton for Non-Acid Fluids; Low Flow Rates; 2, 5, or 10 Micron Retention (Peco Prefix FT)
CTK	Coolant Test Kit	V	Vac-Cel (Cotton) Lube Element *
CV	Crankcase Ventilation Breather	VG	Vacuum Gauge
CW	Coolant Sock-Type Element with Chemicals	VT	Vac-Cel (Cotton) Lube Element *
ES	End Seal		
F	Cotton Fuel Element		
FB	Fuel Filter Base		
FD	Fuel Filter Adapter		
G	Gasket		

SUFFIXES

Multiple letter suffixes may need to be read as single letters. Suffixes often indicate the maker of the filter housing in which the element fits. When the suffix is not used for this purpose, it most often indicates the following:

-1	Specification Change	-FN	Air Filter with Fins
-2	Double Length or Air Element with 2 Inch Pleats	-FP	Contains Fill Port
(2), (3), (4)	Number of Elements in a Kit	-H	Hydraulic Element
-3, -5, -10, -25, -30	Nominal Micron Retention	-HD	Heavy-Duty or Hydraulic
-A	Closed End, Conversion Kit, Aluminum, Version # *	-HPG	High Performance Glass Media
-AF	Normally on Air Filters	-K	Kit, Includes Reusable Parts, Fittings *
-AL	Can be Used with Fluids Containing Alcohol	-M	Magnesium, Mason Jar Screw Neck *
-B	By-Pass Lube, Boxed, Version # *	-MPG	Maximum Performance Glass Media
-BSP	British Standard Pipe	-O	Open End *
-CPE	Cotton Sock for Use with Non-Acid Fluids Flowing at Moderate Temperatures	-OPE	Orlon Sock for Use with Most Fluids; Particularly Recommended for High Heat or Acid-Content Fluids
-CS	Water Absorbent Media	-OW	Orlon Wrap
-D	Drain, Direct Mount *	-RV	Roll-Over Valve
-DL	Double Length	-S	Specification Change on Liquid Filters; Smaller, Solid Lid on Air Filters *
-DM	Drain - Marine Applications	-SP	With Sensor Port
-E	Economy or Fleet Pack *	-SPS	With Reusable Sensor Port
-F	Wound Cotton or Felt Media	-SS	Filter for Severe Service
-FF	Full-Flow Lube Element	-T	Sisal Sock for High Flow Applications *
		-V	Viton O-Ring
		-W	With Wrap, Winter - Cold Weather Applications *
		-WO	Without - See Specifications
		-WPC	With Pre-Cleaner
		XP	Extreme Performance

* See Specific Number in Product Guide for Details and Exceptions.

الحروف البادئة واللاحقة

الحروف البادئة	
AB	طوق تحميل مبيّت الهواء
AC	مستلزمات مبيّت الهواء - أغشية أو قامطات مدخل الهواء
AD	مهايئ مرشح الهواء
AE	كوع مبيّت الهواء
AFG	مقياس تقييد مرشح الهواء
AH	خرطوم بحدية لمبيّت الهواء
AR	حلقة سد مستديرة لمبيّت الهواء
AS	أغشية علوية وسفلية لجلبة مبيّت الهواء
AV	صمام طرد التراب لمبيّت الهواء
AW	صامولة مجنحة أو متريّة لمبيّت الهواء
B	مرشح لف أو مرشح جرابي *
BA	جراب الهواء
BC	جزء الطرد المركزي
BD	وسيلة التزييت بالسريان الثنائي والتركيّب باللف
BF	مرشح الزيت بتركيّب اللف، من نوع العلبة أو نوع التحادي
BK	عُدّة بولدوين Baldwin Kit
BT	فلتر بتركيّب اللف لنظام التزييق أو لمجموعة النقل الهيدرولي
BW	وسيلة تبريد بتركيّب اللف مع المواد الكيماوية
C	عنصر تزييق قطن
CA	مرشح هواء Channel Flow®
CFB	قاعدة مرشح التبريد
CS	مضافات كيماوية
CSC	منظف نظام التبريد
CTK	عدة اختبار التبريد
CV	فتحة التهوية الخاصة بعلبة المرافق
CW	عنصر مرشح التبريد من نوع الجورب مع المواد الكيماوية
ES	مانع للتسرب عند الطرف
F	عنصر من القطن لترشيح الوقود
FB	قاعدة مرشح الوقود
FD	مهايئ مرشح الوقود
G	حشوة (لمنع التسرب)
H	عنصر هيدرولي من نوع Paul-Type
HH	خرطوم
HSG	مبيّت مرشح الهواء
LL	عنصر مرشح هواء طويل العمر
OAS	عازل الزيت/الهواء
OB	قاعدة مرشح الزيت أو مرشح النظام الهيدرولي
OP	توصيل
OS	المؤشرات الكهربائية
OTK	عدة اختبار الزيت
OV	المؤشرات المرئية
P	عنصر ورقي لمرشح نظام التزييق أو النظام الهيدرولي
PA	عنصر ورقي لترشيح الهواء
PF	عنصر ورقي لترشيح الوقود
PG	مقياس الضغط
PKG	عبوة، منتج ممتاز
PT	عنصر ورقي لمرشح نظام التزييق أو النظام الهيدرولي
PV	عنصر من الورق والخلايا المفرغة *
RS	مرشح هواء ذو منع تسرب قطري
S, SA, SF	مواد خاصة *
T	عنصر تزييق قطن *
TA	أكريليك وألياف اصطناعية أخرى لأكثر أنواع السوائل، تدفق متوسط، مقياس الاحتفاظ ٥ أو ١٩ ميكرون (بادئ بيكو AF)
TB	خليط من القطن والسيزال للسوائل غير الحامضية، تدفق متوسط إلى عالي، مقياس الاحتفاظ ٢٥ إلى ٤٠ ميكرون (بادئ بيكو FTE)
TC	قطن خالص للسوائل غير الحامضية، تدفق منخفض، مقياس الاحتفاظ ٢ أو ٥ أو ١٠ ميكرون (بادئ بيكو FT)
V	عنصر تزييق بخلايا مفرغة (قطن) *
VG	مقياس التفريغ
VT	عنصر تزييق بخلايا مفرغة (قطن) *

اللواحق

قد يتطلب الأمر في بعض الأحيان قراءة اللواحق المتعددة الحروف كحرف واحد. تدل اللواحق في كثير من الأحيان على مُنتج مبيّت المرشح الذي يدخل فيه عنصر الترشيح. أما إن لم تكن اللاحقة تستخدم لهذا الغرض، ففيما يلي ماذا تدل عليه غالباً:

1-	تغيير في المواصفات
2-	طول مضاعف أو عنصر ترشيح هواء بطيات فئة ٢ بوصة
(2), (3), (4)	عدد عناصر الترشيح في العُدّة
3-5, 10-25, 30-	المقياس المسمى للاحتفاظ بوحدة الميكرون
A-	طرف مغلق أو عدة تحويل أو ألومنيوم أو نسخة رقم *
AF-	يظهر عادة على مرشحات الهواء
AL-	يمكن استخدامه مع سوائل تحتوي على الكحول
B-	تجاوزي لنظام التزييق، في إطار، نسخة رقم *
BSP-	الأنابيب القياسية البريطانية
CPE-	جورب قطن (عنصر ترشيح) للاستخدام مع السوائل غير الحمضية المتدفقة في درجات حرارة متوسطة
CS-	وسائط ماصة للماء
D-	تصفية، تحميل مباشر *
DL-	طول مزدوج
DM-	تطبيقات الصرف - التطبيقات البحرية
E-	عبوة اقتصادية أو عبوة أسطول *
F-	وسط من قطن ملفوف أو اللباد
FF-	عنصر لنظام التزييت كالم التدفق
FN-	مرشح هواء بزعانف
FP-	يحتوي على مدخل التعبئة
H-	عنصر هيدرولي
HD-	تحميل ثقيل أو هيدرولي
HGP-	وسيط زجاجي ذو أداء عالي
K-	عُدّة، تشمل أجزاء قابلة لإعادة الاستخدام، توصيلات *
M-	مغنسيوم، مرطبان جيسون بالرقبة الملولة *
MPG-	وسيط زجاجي ذو أداء عالي
O-	نهاية مفتوحة *
OPE-	جورب من الأورلون للاستخدام مع أكثر السوائل، يفضل خاصة في حالة السخونة العالية أو السوائل التي تحتوي على حامض.
OW-	لثيف من الأورلون
RV-	صمام انقلاب
S-	تغيير مواصفات مرشحات السوائل، أصغر، غطاء مصممت لمرشحات الهواء *
SP-	مع المدخل الاستشعاري
SPS-	مع مدخل استشعاري قابل لإعادة الاستخدام
SS-	مرشح للخدمة الشاقة
T-	جورب من السيزال لاستخدامات التدفق العالي *
V-	حلقة سد مستديرة من نوع فيتون.
W-	مع الغلاف، استخدامات الشتاء و الطقس البارد *
WO-	بدون - أنظر المواصفات
WPC-	مع مادة التنظيف الأولي
XP	الأداء الأمثل

* انظر الرقم المعين في دليل المنتجات للحصول على التفاصيل والاستثناءات

前缀和后缀

前缀

AB	空气滤清器外壳安装环
AC	空气滤清器外壳附件-空气进口罩或夹具
AD	空气滤清器接头
AE	空气滤清器外壳弯管
AFG	空气滤清器限流表
AH	空气滤清器外壳驼峰软管
AK	含空气滤清器接头和内空气滤芯的工具包
AR	空气滤清器 O型环
AS	空气滤清器外壳护套, 叠盖
AV	空气滤清器外壳 去尘器阀e
AW	空气滤清器外壳翼形螺母或公制螺母
B	旋装式或袋式滤清器*
BA	袋式空气滤清器
BC	离心滤芯
BD	双向流润滑油旋装式
BF	旋装式, 罐式或直列式燃油滤清器
BK	Baldwin 工具包
BT	旋装式润滑油或液压/变速滤清器
BW	冷却剂旋装式滤清器 (带化学品)
C	棉质润滑油滤芯
CA	Channel Flow® 空气滤清器
CFB	冷却剂过滤器底座
CS	化学补充剂
CSC	冷却剂系统清洁剂
CTK	冷却剂测试包
CW	冷却剂袜式滤芯 (带化学品)
ES	端密封
F	棉质燃油滤芯

FB	燃油滤清器底座
G	垫圈
H	罩式液压滤芯
HH	软管
HSG	空气滤清器外壳
LL	长寿命空气滤清器滤芯
OB	润滑油或液压滤清器底座
OTK	油测试包
P	纸质润滑油或液压滤芯
PA	纸质空气滤芯
PF	纸质燃油滤芯
PG	压力表
PKG	套装, 优质品
PT	纸质润滑油或液压滤芯
PV	纸质及 Vac-Cel 滤芯*
RS	径向密封空气滤清器
S, SA, SF	特殊材料 *
T	棉质润滑油滤芯*
TA	用于大多数丙烯酸及其它合成纤维; 5 或 10微米积垢 (Peco Prefix AF)
TB	用于非酸性液体的棉与剑麻混合物; 25或40 微米积垢 (Peco Prefix FTE)
TC	用于非酸性液体的全棉, 低流量; 2, 5, 或10微米积垢(Peco Prefix FT)
V	Vac-Cel (棉质) 润滑油滤芯 *
VG	真空表
VT	Vac-Cel (棉质) 润滑油滤芯 *

后缀

多字母组成的后缀可能需要读为单一字母。后缀往往表示滤清器外壳的制造厂商。如果不是这种情况, 则大多数表示以下意义:

-1	规格改变
-2	双倍长度或有2吋摺边的滤芯
(2), (3), (4)	工具包中的滤芯数
-3, -5, -10, -25, -30	标定微米积垢
-A	封口, 转换包, 铝质, 型号*
-AF	一般用于空气滤清器
-AL	可用于含酒精的液体
-B	旁通润滑油, 盒装, 型号*
-CPE	用于中等温度下流动非酸性液体的棉质袜式滤芯
-CS	吸水介质
-D	排放, 直接安装*
-DL	双倍长度
-E	经济型或车队包装
-F	织棉或毛毡介质
-FF	全流式润滑油滤芯
-FN	带肋片的空气滤清器
-FP	带加油端口
-H	液压滤芯
-HD	重型或液压
-HPG	高性能玻璃介质
-K	工具包, 包括可重新使用的零配件和紧固件 *
-M	镁, Mason Jar 螺旋颈 *
-MPG	最高性能玻璃介质
-O	开口 *
-OPE	用于大多数液体的奥纶袜式滤芯; 尤其推荐用于搞热或含酸的液体
-OW	奥纶匝环
-RV	翻车安全阀
-S	液体滤清器规格变化; 空气滤清器上较小的实心盖子*
-SP	带传感器出口
-SS	严酷服务条件下使用的滤清器
-SPS	带可重新使用的传感器端口
-T	高流量应用的剑麻袜式滤芯 *
-V	Viton O型环
-W	带匝环, 冬季 - 寒冷天气应用 *
-WO	不带 - 参见规格
-WPC	带预清洁剂
XP	超级性能

* 详情及例外情况请参阅产品指导中的特别编号。

PREFIXES ET SUFFIXES

PREFIXES

AB	Bande de montage de boîtier d'air	H	Cartouche hydraulique
AC	Accessoire de boîtier d'air - capots ou colliers d'entrée d'air	HH	Flexible
AD	Adaptateur de filtre à air	HSG	Boîtier de filtre à air
AE	Coude de boîtier d'air	LL	Cartouche de filtre à air longue durée
AFG	Indicateur de colmatage de filtre à air	OAS	Séparateur huile / air
AH	Flexible de bosse de boîtier d'air	OB	Base de filtre à huile de lubrification ou hydraulique
AR	Joint torique de boîtier d'air	OP	Obturbateur
AS	Manchon de boîtier d'air, capuchon cheminée	OS	Indicateur électrique
AV	Valve d'éjection de poussière du boîtier d'air	OTK	Nécessaire de contrôle d'huile
AW	Ecrou papillon ou métrique du boîtier d'air	OV	Indicateur visuel
B	Filtre de type vissable ou en ligne *	P	Cartouche en papier pour filtre à huile de lubrification ou hydraulique
BA	Élément sac ou sécheur d'air	PA	Cartouche en papier pour filtre à air
BC	Cartouche centrifuge	PF	Cartouche en papier pour filtre à carburant
BD	Lubrification, flux double, vissable	PG	Manomètre
BF	Filtre à carburant vissable, type bidon ou sur conduite	PKG	Paquet, article de qualité supérieure
BK	Jeu Baldwin	PT	Cartouche en papier pour filtre à huile de lubrification ou hydraulique
BT	Filtre à huile de lubrification ou hydraulique/de transmission vissable	PV	Cartouche Papier et Vac-Cel *
BW	Liquide de refroidissement avec produits chimiques, vissable	RS	Filtre à air à joint radial
C	Cartouche coton pour lubrification	S, SA, SF	Matériau spécial *
CA	Filtre à air Channel Flow®	T	Cartouche coton pour lubrification *
CFB	Base de filtre à liquide de refroidissement	TA	Fibres acryliques et autres fibres synthétiques pour la plupart des fluides; flux moyen; rétention 5 ou 10 microns (Préfixe peco AT)
CS	Supplément chimique	TB	Mélange de coton et sisal pour fluides non acides; flux moyen à élevé; rétention 25 à 40 microns (Préfixe peco FTE)
CSC	Produit de nettoyage de circuit de refroidissement	TC	Tout coton pour fluides non acides; débits faibles; rétention 2, 5 ou 10 microns (Préfixe peco TT)
CTK	Jeu de test de liquide de refroidissement	V	Cartouche pour lubrification Vac-Cel (coton) *
CV	Reniflard de carter	VG	Déprimomètre
CW	Élément de type chaussette pour liquide de refroidissement avec produits chimiques	VT	Cartouche pour lubrification Vac-Cel (coton) *
ES	Joint d'extrémité		
F	Cartouche en coton pour carburant		
FB	Base de filtre à carburant		
FD	Adaptateur pour filtre à carburant		
G	Joint		

SUFFIXES

Les suffixes à lettres multiples doivent parfois être lus comme lettres individuelles. Les suffixes indiquent souvent le fabricant du boîtier du filtre dans lequel s'ajuste la cartouche. Lorsque le suffixe n'est pas utilisé dans ce but, il indique le plus souvent ce qui suit:

-1	Changement de spécification	-FN	Filtre à air avec ailettes
-2	Double longueur ou cartouche air avec plis de 2 pouces (5 cm)	-FP	Contient orifice de remplissage
(2), (3), (4)	Nombre d'éléments dans un nécessaire	-H	Cartouche hydraulique
-3, -5, -10, -25, -30	Rétention nominale en microns	-HD	Usage intensif ou hydraulique
-A	Version extrémité fermée, nécessaire de conversion, aluminium *	-HPG	En verre haute performance
-AF	Normalement sur filtres à air	-K	Nécessaire, comprend pièces réutilisables, garnitures *
-AL	Peut être utilisé avec des fluides contenant de l'alcool	-M	Tubulure filetée, magnésium, récipient maçon *
-B	Version en boîte, dérivation, lubrification *	-MPG	En verre performance maximum
-BSP	British Standard Pipe	-O	Extrémité ouverte *
-CPE	Chaussette coton pour utiliser avec les fluides non acides s'écoulant à températures modérées	-OPE	Chaussette Orlon pour utiliser avec la plupart des fluides; particulièrement recommandée pour la chaleur élevée ou les fluides acides
-CS	Milieu avide d'eau	-OW	Enveloppe Orlon
-D	Montage direct, vidange *	-RV	Vanne de reuversement
-DL	Double longueur	-S	Changement de spécification sur filtres à liquide; Couvreclle plein, plus petit sur filtres à air *
-DM	Scarico - Applicazioni marine	-SP	Avec orifice de capteur
-E	Paquet économie ou flotte *	-SPS	Avec orifice de capteur réutilisable
-F	En coton enroulé ou feutre	-SS	Filtre SS pour les utilisations intensives
-FF	Cartouche pour lubrification à passage intégral	-T	Chaussette sisal pour applications de bit élevé *
		-V	Joint torique en Viton
		-W	Avec enveloppe, Hiver - Applications pour temps froid *
		-WO	Sans - Voir les spécifications
		-WPC	Avec préfiltre
		XP	Performances extrêmes

* Voir le numéro spécifique dans le Guide des Produits pour les détails et exceptions.

PRÄFIXE UND SUFFIXE

PRÄFIXE (VORSILBEN)

AB	Luftgehäuse Halteklammer
AC	Luftgehäuse Zubehör - Ansaugkappe oder Klammern
AD	Luftfilteradapter
AE	Luftgehäuse Kniestück
AFG	Luftfilter Drosselungsanzeige
AH	Luftgehäuse Buckelverbindungsstück
AR	Luftgehäuse Dichtungsring
AS	Luftgehäuse Verbindungsstück, Kappe
AV	Luftgehäuse Staubausstoßventil
AW	Luftgehäuse Flügelmutter
B	Dreh- oder Beutel-Filter *
BA	Taschenluftfilter oder Lufttrockner
BC	Zentrifugen Einsatz
BD	Öl doppelter Durchfluß Drehfilter
BF	Brennstoff Dreh-, Topf-, oder Durchfluß-Filter
BK	Baldwin Satz
BT	Drehfilter für Öl oder Hydraulik/Getriebe
BW	Kühlung, Dreh mit Chemikalien
C	Öl Baumwolle Einsatz
CA	Channel Flow®-Luftfilter
CFB	Kühlungsfiltergehäuse
CS	Chemikalien Ergänzungssatz
CSC	Kühlungssystemreiniger
CTK	Kühlungsprüfungssatz
CV	Kurbelgehäuseentlüftung
CW	Kühlungs Einsatz, Sockeu-typ, mit Chemikalien
ES	Abschlußdichtung
F	Treibstoff Baumwolle Einsatz
FB	Ölfiltergehäuse
FD	Kraftstofffilter-Adapter
G	Dichtung
H	Hydraulik Pall-typ Einsatz

HH	Schlauch
HSG	Luftfiltergehäuse
LL	Langlebiger Luftfilter Einsatz
OAS	Öl-Luft-Abscheider
OB	Öl- oder Hydraulikfiltergehäuse
OP	Verschlussstopfen
OS	Elektrische Anzeige
OTK	Öltestsatz
OV	Visuelle Anzeige
P	Öl- oder Hydraulik Papier Einsatz
PA	Luftfilter Papier Einsatz
PF	Brennstoff Papier Einsatz
PG	Druckanzeigergerät
PKG	Packung, gehobenes Modell
PT	Öl- oder Hydraulik Papier Einsatz
PV	Papier und Vac-Cel *
RS	Kreisartige Dichtung Luftfilter
S, SA, SF	Sondermaterial *
T	Öl Baumwolle Einsatz *
TA	Acrylik und andere synthetischen Faserstoffe für die meisten Flüssigkeiten; mittlerer Durchfluß 5 oder 10 Mikron Auffang (Peco Vorsatz AF)
TB	Mischung von Baumwolle und Sisal for nicht-sauere Flüssigkeiten; mittlerer bis hoher Durchfluß; 25 bis 40 Mikron Auffang (Peco Vorsatz FTE)
TC	Reine Baumwolle für nicht-sauere Flüssigkeiten; kleine Durchflußgeschwindigkeiten; 2, 5 oder 10 Mikron Auffang (Peco Vorsatz FT)
V	Öl Vac Cel (Baumwolle) Einsatz *
VG	Manometer
VT	Öl Vac Cel (Baumwolle) Einsatz *

SUFFIXE (NACHSILBEN)

Suffixe mit mehreren Buchstaben dürfen unter Umständen nur als ein einzelner Buchstabe gelesen werden. Suffixe geben oft den Hersteller des Filtergehäuses an in welches das Filter paßt. Falls der Zusatz nicht zu diesem Zweck gebraucht ist, dann bedeutet er meist wie folgt:

-1	Änderung der Spezifikationen
-2	Doppelte Länge oder Luft Einsatz mit 2-inch Falten
(2), (3), (4)	Anzahl der Einsätze in einem Satz
-3, -5, -10, -25, -30	Nominaler Auffang in Mikron
-A	Abschließendes Ende, Konversionssatz, Aluminium, Ausführung *
-AF	Normalerweise bei Luftfiltern
-AL	Kann mit alkoholischen Flüssigkeiten verwendet werden
-B	Öl By-Pass, Schachtel, Ausführung *
-BSP	British Standard Pipe (Gewindetyp)
-CPE	Baumwolle Socken-typ zum Gebrauch für nicht-sauere Flüssigkeiten bei mittleren Temperaturen
-CS	Wasseraufnahmefähiger Inhalt
-D	Abfluß, direkter Anbau *
-DL	Doppelte Länge
-DM	Abläss – Wasserfahrzeuge
-E	Spar-oder Mengenpackung *
-F	Gespulte Baumwolle oder Filzmaterial
-FF	Öl Hoher Durchfluß Einsatz

-FN	Luftfilter mit Finnen
-FP	Einschließlich Einfüllstutzen
-H	Hydraulik Einsatz
-HD	Schwere Belastung oder Hydraulik
-HPG	Glasinhalt für hohe Ansprüche
-K	Satz, einschließlich wiederverwendbarer Teile, Verbindungsstücke *
-M	Magnesium, Mason-Jar Schraubgewinde *
-MPG	Glasinhalt für höchste Ansprüche
-O	Offenes Ende *
-OPE	Orlon Socken-typ für die meisten Flüssigkeiten; besonders empfohlen bei hoher Hitze oder sauren Flüssigkeiten
-OW	Orlon Wickel
-RV	Roll-over Ventil
-S	Änderung der Spezifikationen für Filter für Flüssigkeiten; kleinerer harter Deckel für Luftfilter *
-SP	mit Sensoröffnung
-SPS	Mit wiederverwendbarer Sensoröffnung
-SS	SS-Filter für Schwerbetrieb
-T	Sisalsocken für Anwendungen mit hohem Durchfluß *
-V	Viton Dichtungsring
-W	Mit Umschlag, Winter Anwendungen bei niedrigen Temperaturen *
-WO	Ohne, bitte Spezifikationen beachten
-WPC	Mit Vorreiniger
XP	Höchstleistungsfilter

* Beachten Sie die Einzelheiten und Ausnahmen in der, Produktaufzeichnung.

PREFISSI E SUFFISSI

PREFISSI

AB	Fascetta di montaggio alloggiamento aria
AC	Accessorio alloggiamento aria – Cappucci o morsetti entrata aria
AD	Adattatore filtro aria
AE	Gomito alloggiamento aria
AFG	Indicatore di restrizione filtro aria
AH	Tubo flessibile alloggiamento aria
AR	O-Ring alloggiamento aria
AS	Manicotto alloggiamento aria, cappuccio pila
AV	Valvola estrattore polvere alloggiamento aria
AW	Ala alloggiamento aria oppure dado metrico
B	Filtro spin-on oppure filtro a sacco *
BA	Sacco aria
BC	Elemento centrifugo
BD	Filtro spin-on lubrificante a doppio flusso
BF	Filtro spin-on, filtro carburante a barattolo o in linea
BK	Kit Baldwin
BT	Filtro spin-on lubrificante oppure filtro idraulico/di trasmissione
BW	Filtro spin-on refrigerante con sostanze chimiche
C	Elemento di cotone lubrificante
CA	Filtro dell'aria Channel Flow®
CFB	Base filtro refrigerante
CS	Supplemento chimico
CSC	Depuratore sistema refrigerante
CTK	Kit di prova refrigerante
CV	Crankcase Ventilation Breather
CW	Elemento a sacco refrigerante con sostanze chimiche
ES	Guarnizione finale
F	Elemento di cotone carburante
FB	Base filtro carburante
FD	Fuel Filter Adapter

G	Guarnizione
H	Elemento idraulico di tipo Pall
HH	Tubo flessibile
HSG	Alloggiamento filtro aria
LL	Elemento filtro aria a lunga durata
OAS	Oil/Air Separator
OB	Base filtro idraulico o lubrificante
OP	Plug
OS	Electrical Indicator
OTK	Kit di prova olio
OV	Visual Indicator
P	Elemento di carta lubrificante o idraulico
PA	Elemento di carta aria
PF	Elemento di carta carburante
PG	Manometro
PKG	Confezione, articolo di qualità superiore
PT	Elemento di carta lubrificante o idraulico
PV	Elemento di carta e Vac-cel *
RS	Filtro aria guarnizione radiale
S, SA, SF	Materiale speciale *
T	Elemento di cotone lubrificante *
TA	Acrilico e altre fibre sintetiche per grand parte dei fluidi; flusso medio; ritenzione 5 o 10 micron (Prefisso Peco AF)
TB	Miscela di cotone e sisal per fluidi non acidi; flusso medio-alta; ritenzione da 25 a 40 micron (Prefisso Peco FTE)
TC	Puro cotone per fluidi non acidi; flusso basso; ritenzione da 2, 5, o 10 micron (Prefisso Peco FT)
V	Elemento in Vac-cel (cotone) lubrificante *
VG	Vacuometro
VT	Elemento in Vac-cel (cotone) lubrificante *

SUFFISSI

Può essere necessario leggere i suffissi con più lettere come lettere singole. Spesso i suffissi indicano il produttore dell'alloggiamento del filtro in cui risiede l'elemento. Quando il suffisso non è utilizzato per questo scopo, esso spesso indica quanto segue:

-1	Modifica della specifica tecnica
-2	Lunghezza doppia oppure elemento aria con pieghettature da 2 pollici
(2), (3), (4)	Numero di elementi in un kit
-3, -5, -10, -25, -30	Ritenzione nominale in micron
-A	Estremità chiusa, kit di conversione, alluminio, versione # *
-AF	Normalmente su filtri aria
-AL	Può essere utilizzato con fluidi contenenti alcol
-B	Bypass lubrificante, incassato, versione # *
-BSP	British Standard Pipe
-CPE	Sacco in cotone per uso con fluidi non acidi a temperature moderate
-CS	Mezzi assorbenti acqua
-D	Scarico, montaggio diretto *
-DL	Lunghezza doppia
-DM	Drain - Marine Applications
-E	Economia oppure fleet pack *
-F	Cotone avvolto oppure mezzo di feltro
-FF	Elemento lubrificante per flusso totale
-FN	Filtro aria con alette

-FP	Contiene porta di riempimento
-H	Elemento idraulico
-HD	Servizio pesante oppure idraulico
-HPG	Mezzi di vetro per alte prestazioni
-K	Kit, include parti riutilizzabili, accessori *
-M	Magnesio, vite Mason Jar *
-MPG	Mezzi di vetro per prestazioni massime
-O	Estremità aperta *
-OPE	Sacco di orlon per uso con gran parte dei fluidi; particolarmente consigliata per fluidi altamente riscaldati o acidi
-OW	Copertura di orlon
-RV	Valvola "roll-over"
-S	Modifica della specifica tecnica per filtri di liquidi; più piccolo; coperchio solido su filtri aria *
-SP	Con porta sensore
-SPS	Con porta sensore riutilizzabile
-SS	Filtro per servizio pesante
-T	Sacco in sisal per applicazioni con flusso elevato *
-V	O-Ring in Viton
-W	Con copertura, applicazioni inverno-tempo freddo *
-WO	Senza – Vedere specifiche tecniche
-WPC	Con pre-depuratore
XP	Prestazioni estreme

* Per dettagli ed eccezioni, vedere il numero specifico nella guida prodotto.

PREFIXOS E SUFIXOS

PREFIXOS

AB	Tira de montagem para carcaça de filtro de ar	FD	Adaptador do Filtro de Combustível
AC	Acessórios da carcaças dos filtros de ar - Chapéu ou abraçadeiras	G	Junta
AD	Adaptador do filtro de ar	H	Elemento de filtro hidráulico
AE	Cotovelo da carcaça do filtro de ar	HH	mangueira
AFG	Mostrador de restrição do filtro de ar	HSG	Carcaça de filtro de ar
AH	Mangueira curva da caixa de ar	LL	Elemento de filtro de ar de longa vida
AR	Anel "O" da caixa de ar	OAS	Separador de Óleo e Água
AS	Bucha e tampa da chaminé	OB	Base de filtro lubrificante ou hidráulico
AV	Válvula para retirar excesso de poeira da caixa de ar	OP	Bujão
AW	Porca métrica ou tipo borboleta da caixa de ar	OS	Indicador Elétrico
B	Filtro selado ou tipo bolsa *	OTK	Kit de teste de óleo
BA	Ar do Saco ou Secador de Ar	OV	Indicador Visual
BC	Elemento de centrifugação	P	Elemento de papel para lubrificante ou hidráulico
BD	Filtro selado de dois fluxos	PA	Elemento de papel para ar
BF	Filtro selado, tipo caneca, ou filtro de linha	PF	Elemento de papel para combustível
BK	Kit Baldwin	PG	Indicador de pressão
BT	Filtro selado para lubrificante ou transmissão hidráulica	PKG	Embalagem, artigo "premium"
BW	Filtro selado para sistema de refrigeração com substâncias químicas	PT	Elemento de papel para lubrificante ou hidráulico
C	Elemento de algodão	PV	Elemento de papel e Vac-Cel *
CA	Filtro de Ar Channel Flow®	RS	Elemento de filtro de ar tipo Selo radial
CFB	Base do filtro para sistemas de refrigeração	S, SA, SF	Material especial *
CS	Suplemento de substâncias químicas	T	Elemento de algodão para lubrificante
CSC	Limpador do sistema de refrigeração	TA	Acrílico ou outras fibras sintéticas para a maioria dos fluidos; Vazão média; retenção de 5 a 10 microns (Prefixo Peco AF)
CTK	Kit do teste do líquido refrigerante	TB	Mistura de algodão e sisal para fluidos não ácidos; Vazão de média para alta; Retenção de 25 a 40 microns (Prefixo Peco FTE)
CV	Suspiro de Ventilação do Câter	TC	Totalmente algodão para fluidos não ácidos; Baixas relações de vazão; retenção de 2, 5, ou 10 microns (Prefixo Peco FT)
CW	Elemento de filtro tipo meia para sistemas de refrigeração, com substâncias químicas	V	Elemento lubrificante de Vac-Cel (algodão) *
ES	Selo	VG	Indicados de vácuo - Vacuômetro
F	Elemento de filtro de algodão	VT	Elemento lubrificante de Vac-Cel (algodão) *
FB	Base do filtro de combustível		

SUFIXOS

Sufixos com muitas letras devem ser lidos como se fossem letras simples. Normalmente o sufixo indica o fabricante da carcaça do filtro, na qual o elemento se encaixa. Quando o sufixo não se utiliza para este propósito, na maioria das vezes indica o seguinte:

-1	Mudança de especificações	-FN	Filtro de ar com aletas
-2	Comprimento duplo, ou elemento de filtro de ar com plissado de duas polegadas	-FP	Contém orifício de entrada
(2), (3), (4)	Número de elemento no Kit	-H	Elemento hidráulico
-3, -5, -10, -25, -30	Retenção nominal em microns	-HD	Elemento hidráulico ou serviço pesado
-A	Fechamento externo, Kit de conversão, Alumínio, Versão # *	-HPG	Meio filtrante de alto desempenho de fibra de vidro
-AF	Normalmente em filtros de ar	-K	Kit, Inclui peças reutilizáveis, acessórios
-AL	Poderá ser utilizado em fluidos que contém álcool	-M	Magnésio, Jarra hermética com rosca
-B	Lubrificante tipo derivação, fechado, versão # *	-MPG	Meio filtrante de máximo desempenho de fibra de vidro
-BSP	British Standard Pipe	-O	Final aberto
-CPE	Tipo meia de algodão para utilização em fluidos não ácidos e temperaturas moderadas	-OPE	Meia de orlón para ser utilizado na maioria dos fluidos; particularmente recomendado para altas temperaturas ou fluidos que contem ácidos
-CS	Meio filtrante absorvente de água	-OW	Revestimento de orlón
-D	Drenagem, Montagem direta *	-RV	Válvula de rotação
-DL	Comprimento duplo	-S	Modificação das especificações dos filtros para líquidos, Menores, Tampa sólida nos filtros de ar
-DM	Dreno DM - Aplicações Marítimas	-SP	Com tomada para sensor
-E	Embalagem econômica ou para transporte	-SPS	Com tomada de sensor reutilizável
-F	Meio filtrante em algodão ou feltro	-SS	Filtros para serios severos
-FF	Elemento de fluxo total	-T	Meia de sisal para aplicações de altas vazões *
		-V	Anel "O" de viton
		-W	Com revestimento, Inverno - para aplicações em baixas temperaturas
		-WO	Sem - Verifique as especificações
		-WPC	Com o Pré-limpador
		XP	Desempenho Extremo

* Veja o Numero Especifico No Catalogo Produtos, com Relação aos Detalhes.

ПРИСТАВКИ И СУФФИКСЫ

ПРИСТАВКИ

AB	Лента крепления воздухозаборной коробки
AC	Принадлежности воздухозаборной коробки: предохранительный колпак на впуске воздуха или хомуты
AD	Переходник воздушного фильтра
AE	Колено воздухозаборной коробки
AFG	Указатель сопротивления воздушного фильтра
AH	Сортировочный шланг воздухозаборной коробки
AR	Уплотнительное кольцо воздухозаборной коробки
AS	Рукав воздухозаборной коробки, крышка выводного патрубка
AV	Клапан пылеэжектора воздухозаборной коробки
AW	Крыльчатая барашковая или метрическая гайка воздухозаборной коробки
B	Навинчиваемый или рукавный фильтр *
BA	Баллон с воздухом или осушитель воздуха
BC	Элемент центробежного фильтра
BD	Двухпоточный навинчиваемый масляный фильтр
BF	Навинчиваемый, стаканый или встраиваемый топливный фильтр
BK	Комплект принадлежностей фирмы "Болдуин"
BT	Навинчиваемый масляный фильтр или фильтр гидравлической системы или коробки передач
BW	Навинчиваемый фильтр охлаждающей жидкости с присадками
C	Хлопчатобумажный элемент масляного фильтра
CA	Воздушный фильтр с разделенными каналами (Channel Flow®)
CFB	Корпус фильтра охлаждающей жидкости
CS	Химическая добавка
CSC	Фильтр системы охлаждения
CTK	Набор принадлежностей для контроля качества охлаждающей жидкости
CV	Сапун вентиляции картера
CW	Рукавный элемент фильтра охлаждающей жидкости с присадками
ES	Торцевое уплотнение
F	Хлопчатобумажный элемент топливного фильтра
FB	Корпус топливного фильтра
FD	Переходной патрубок топливного фильтра
G	Уплотнительная прокладка

СУФФИКСЫ

Некоторые суффиксы из нескольких букв могут потребовать их чтения как суффиксов, состоящих из единственной буквы. Во многих случаях суффиксом обозначается предприятие-изготовитель корпуса фильтра, в который может быть установлен данный фильтрующий элемент. Если суффикс используется с иной целью, то им часто обозначаются следующие характеристики:

-1	Изменение технических данных
-2	Элемент воздушного фильтра, имеющий двойную длину или 2-дюймовый гофр
(2), (3), (4)	Число фильтрующих элементов в комплекте
-3, -5, -10, -25, -30	Номинальная удерживающая способность фильтра в микрометрах
-A	С закрытым торцом, комплектом для переоборудования, алюминиевое исполнение, модификация № *
-AF	Стандартно устанавливаемый на воздушных фильтрах
-AL	Может применяться с жидкостями, содержащими спирт
-B	Обводная линия смазки, корбчатое исполнение, модификация № *
-BSP	британская стандартная трубная [резьба]
-CPE	Хлопчатобумажный, в рукавном исполнении для применения с неокислотными текучими средами при умеренных температурах
-CS	Материал, впитывающий воду *
-D	Выпуск, непосредственный монтаж
-DL	Двойная длина
-DM	Слив - для использования на судах
-E	Экономичный вариант или для автохозяйств *
-F	Навитой хлопчатобумажный или фетровый материал
-FF	Полнопоточный элемент смазочного фильтра

H	Элемент Полла для фильтра гидравлической системы
HN	Шланг
HSG	Корпус воздушного фильтра
LL	Элемент воздушного фильтра с длительным сроком службы
OAS	Устройство для центробежной очистки моторного масла
OB	Корпус масляного фильтра или фильтра гидравлической системы
OP	Заглушка
OS	Электрический индикатор
OTK	Набор принадлежностей для контроля качества масла
OV	Индикатор визуального контроля
P	Бумажный элемент масляного фильтра или фильтра гидравлической системы
PA	Бумажный элемент воздушного фильтра
PF	Бумажный элемент топливного фильтра
PG	Манометр
PKG	Комплектное изделие высшего сорта
PT	Бумажный элемент масляного фильтра или фильтра гидравлической системы
PV	Бумажный фильтрующий элемент со структурой Vac-Cel *
RS	Воздушный фильтр с радиальным уплотнением
S, SA, SF	Специальный материал *
T	Хлопчатобумажный элемент масляного фильтра *
TA	Акриловое или иное синтетическое волокно для большинства рабочих сред; для средних значений расхода; степень фильтрации 5 или 10 мкм (для серии Peco - приставка AF)
TB	Материал из смеси хлопка с сизалем для неокислотных рабочих сред; для средних и высоких значений расхода; степень фильтрации 25 - 40 мкм (для серии Peco - приставка FTE)
TC	Чисто хлопчатобумажный материал; для низких значений расхода; степень фильтрации 2, 5 или 10 мкм (для серии Peco - приставка FT)
V	Элемент со структурой Vac-Cel (хлопчатобумажный) для масляного фильтра
VG	Вакуумметр
VT	Элемент со структурой Vac-Cel (хлопчатобумажный) для масляного фильтра

-FN	Воздушный фильтр с ребрами
-FP	Содержит заправочную горловину
-H	Элемент для гидравлических систем
-HD	Для тяжелых машин или гидравлических систем
-HPG	Высокоэффективный материал на основе стекла
-K	Комплект, содержащий детали повторного использования, элементы арматуры *
-M	Магний, керамическая резьбовая горловина *
-MPG	Предельно эффективный материал на основе стекла
-O	Открытый торец *
-OPE	Рукавное исполнение из полиакрилонитрильного волокна "орлон", для использования с большинством текучих сред; особенно рекомендуется для сильно нагретых или содержащих кислоты жидкостей
-OW	Витая оболочка из полиакрилонитрильного волокна "орлон"
-RV	Клапан, срабатывающий при переворачивании
-S	Изменение технических характеристик жидкостных фильтров; уменьшенная сплошная крышка на воздушных фильтрах *
-SP	С каналом для датчика
-SPS	С каналом для повторно используемого датчика
-SS	Фильтр для особо тяжелых условий эксплуатации
-T	Рукавное исполнение из сизаля для применения в устройствах с высоким расходом
-V	Кольцевое уплотнение из сополимера прфторпропилена с винилиденфторидом "вайтон"
-W	С витой оболочкой, для применения в условиях низких температур
-WO	Без - см. технические данные
-WPC	С предварительным очистителем
XP	Высокая производительность

* См. подробные сведения и исключения в разделе "Справочника по продукции", посвященном индивидуальным номерам.

PREFIJOS Y SUFIJOS

PREFIJOS

AB	Banda de montaje para la caja de aire	H	Elemento hidráulico
AC	Accesorio de caja de aire - Capucha o abrazador de la toma de aire	HH	Manguera
AD	Adaptador del filtro de aire	HSG	Caja de filtro de aire
AE	Codo de la caja de aire	LL	Elemento de filtro de aire de larga duración
AFG	Indicador de restricción del filtro de aire	OAS	Separador de aceite/aire
AH	Manguera encorvada de la caja de aire	OB	Base del filtro hidráulico o del lubricante
AR	Anillo "O" de la caja de aire	OP	Tapón
AS	Manga de unidad de aire, tapón de escape	OS	Indicador eléctrico
AV	Válvula eyectora de polvo de la caja de aire	OTK	Kit de comprobación del aceite
AW	Tuerca métrica o tuerca de orejetas de la caja de aire	OV	Indicador visual
B	Filtro de rosca o tipo-bolsa *	P	Elemento de papel para lubricantes o hidráulicos
BA	Aire en bolsa o secadora de aire	PA	Elemento de papel para aire
BC	Elemento de centrifugación	PF	Elemento de papel para combustible
BD	Filtro de lubricante de rosca de corriente dual	PG	Indicador de presión
BF	Filtro de combustible de rosca, tipo-lata o de línea	PKG	Paquete, artículo de primera
BK	Kit de Baldwin	PT	Elemento de papel para lubricantes o hidráulicos
BT	Filtro de lubricante de rosca o de sistema de transmisión hidráulica	PV	Papel y Vac-Cel *
BW	Filtro de refrigerante de rosca con químicos	RS	Filtro de aire de sellado radial
C	Elemento de algodón para lubricación	S, SA, SF	Material especial *
CA	Filtro de aire Channel Flow®	T	Elemento de algodón para lubricante *
CFB	Base del filtro de refrigerante	TA	Acrílicos y otras fibras sintéticas para la mayoría de los fluidos; caudal medio; 5 ó 10 micrometros de retención (Prefijo Peco AF)
CS	Suplemento químico	TB	Derivados de algodón y fibra de para fluidos sin contenido de ácidos; caudal medio a alto; de 25 a 40 micrometros de retención (Prefijo Peco FTE)
CSC	Limpiador del sistema de refrigeración	TC	Puro algodón para fluidos sin contenido de ácidos; Porcentajes de caudal bajo; 2, 5, ó 10 micrometros de retención (Prefijo Peco FT)
CTK	Kit de comprobación del refrigerante	V	Elemento de lubricación de Vac-Cel (algodón) *
CV	Respiradero de ventilación del cárter	VG	Vaciómetro
CW	Elemento de refrigeración tipo calcetín con químicos	VT	Elemento de lubricación de Vac-Cel (algodón) *
ES	Sello de extremo		
F	Elemento de algodón para combustible		
FB	Base del filtro para combustible		
FD	Adaptador para filtro de combustible		
G	Empaque		

SUFIJOS

Puede que los sufijos de múltiples letras necesiten leerse como letras simples. Los sufijos a menudo indican el fabricante de la caja de filtro en la que el elemento encaja. Cuando el sufijo no se utiliza para este propósito, la mayoría de las veces indica lo siguiente:

-1	Cambio de especificación	-FP	Contiene orificio de entrada
-2	Doble longitud o elemento de aire con 2 pulgadas de pliegues	-H	Elemento hidráulico
(2), (3), (4)	Número de elementos en un kit	-HD	Trabajos pesados o hidráulicos
-3, -5, -10, -25, -30	Retención nominal de micrometros	-HPG	Medio de cristal de alto rendimiento
-A	Versión de extremo cerrado, de kit de conversión, Aluminio *	-K	Kit, incluye piezas reutilizables, accesorios *
-AF	Normalmente en filtros de aire	-M	Magnesio, bote hermético con cuello de rosca *
-AL	Puede usarse junto con fluidos que contengan alcohol	-MPG	Medio de cristal de máximo rendimiento
-B	Versión de lubricación por derivación en caja	-O	Extremo abierto *
-BSP	Tubería estándar británica	-OPE	Calcetín de Orlón a utilizar con la mayoría de los fluidos; Recomendado particularmente en fluidos de temperaturas elevadas o en fluidos conteniendo ácidos
-CPE	Calcetín de algodón para el uso en fluidos sin contenido de ácidos corriendo a temperaturas moderadas	-OW	Envoltura de Orlón
-CS	Medio de fécula de maíz	-RV	Válvula de rotación
-D	Desagüe, montaje directo *	-S	Cambio de especificación en los filtros de líquidos; más pequeños, tapadera sólida en filtros de aire *
-DL	Doble longitud	-SP	Con lumbrera sensora
-DM	Drenaje – Aplicaciones marinas	-SPS	Con lumbrera sensora reutilizable
-E	Paquete económico o de carga	-SS	Filtro SS para servicio severo
-F	Medio de algodón en ovillo o fieltro	-T	Calcetín de fibra de para aplicaciones de alta corriente *
-FF	Elemento de lubricación de flujo pleno	-V	Anillo-O de Vitón
-FN	Filtro de aire con aletas	-W	Con envoltura, aplicaciones de temperaturas frías - Invierno
		-WO	Sin - Véase las especificaciones
		-WPC	Con Pre-limpiador
		XP	Rendimiento extremo

* Véase el número específico en la Guía de Productos para observar los detalles y excepciones.

HOW PRODUCT GUIDE IS ARRANGED

PRODUCT GUIDE

Filter Master List
Gasket Master List
Air Filter Housings
DAHL Filters
Filter Size Charts

All products are arranged in numerical order, ignoring prefixes and suffixes in the arrangement. The Filter Master List is first, followed by Gaskets, DAHL Filters and Filter Size Charts.

MEASUREMENTS ARE TIP-TO-TIP

We use overall measurements unless stated otherwise. Some catalogs show size of element only. We show overall size including gaskets and other protrusions that extend the farthest. You can then make sure there is sufficient clearance when this is a critical factor. Measurements are shown in inches and millimeters.

IMPORTANT NOTICE

All specifications in this catalog are based on the latest authoritative information available at press time. However, changes are made by equipment manufacturers without notice, which necessitates changes in our product. Keep your stock rotated so that you always use your oldest stock first. If a filter does not seal when installed, it should not be used. We cannot be responsible for misapplications.

Original equipment manufacturer's tradenames or trademarks are for identification purposes only. There is no affiliation, sponsorship or connection with the original equipment parts or manufacturer.

العربية / Arabic كيفية تنظيم دليل المنتجات

دليل المنتجات

قائمة المرشحات الرئيسي
قائمة حشو منع التسرب الرئيسي
مبايت مرشحات الهواء
مرشحات DAHL
جدول سعة المرشحات

المرشح إذا وجد أنه يسمح بالتسرب بعد تركيبه. نحن لا يمكن أن نتحمل مسؤولية الأخطاء في الاستخدام.

الأسماء التجارية والعلامات التجارية الخاصة بمنتجات المعدات الأصلية واردة للتعريف فقط. لا يوجد ارتباط أو انتساب أو علاقة مع منتجي قطع الغيار الأصلية أو الشركة المصنعة الأصلية.

ترتب جميع المنتجات بترتيب الأرقام بدون اعتبار الزوائد البادئة واللاحقة. تأتي قائمة المرشحات الرئيسية في البداية، وتتبعها قائمة الحشو المانع للتسرب، ثم مبايت مرشحات الهواء، ثم مرشحات DAHL، وجدول سعة المرشحات.

الأبعاد من الطرف إلى الطرف

نحن نستخدم الأبعاد الكلية إلا عند ذكر خلاف ذلك. تظهر بعض الكتالوجات مقاييس العناصر فقط. ولكننا نظهر الأبعاد الكلية ويدخل فيها الحشو المانع للتسرب وغير ذلك من البروزات التي تمتد إلى أقصى بُعد. ويمكنك ذلك التحقق من وجود خلوص كاف حين يكون ذلك عاملاً حيوياً. تعرض جميع الأبعاد بالبوصة والمليمتر.

تنبيه هام

وردت جميع المواصفات في هذه الكتالوج على أحدث معلومات موثوق بها متوفرة في وقت النشر. ولكن كثيراً ما يقوم منتجو المعدات بتعديلات بدون إنذار مما يلزم إجراء تعديلات على منتجنا. حافظ على تسلسل استخدام مخزونك بحيث تستخدم المخزون الأقدم أولاً. يجب ألا يستخدم

产品指导

滤清器总清单
垫圈总清单
空气滤清器外壳
DAHL滤清器
滤清器尺寸表

所有产品均按数字顺序排列，排列时不考虑前缀和后缀。首先是滤清器总清单，然后是垫圈总清单、空气滤清器外壳、DAHL滤清器和滤清器尺寸表。

端到端的尺寸

我们使用的是总体尺寸，除非另有说明。有些目录只给出部件本身的大小。我们提供总体尺寸，包括垫圈和其它伸出之部分。如果大小是一个重要的问题，您就可以确定是否有足够的空间来安装滤清器。尺寸以英寸和毫米表示。

重要通知

本目录中的所有规格均根据付印时能够搜集到的最新权威资料。然而，设备厂商会不经通知而作出改变，迫使我们相应改动我们的产品。请保持您的库存周转，总是先用最老的库存品。如果滤清器安装时不能密封，就不应使用。本公司不能对误用负责。

原设备生产厂的商品名或商标仅用于识别之目的，与原始设备零件或厂商并无附属、资助或其它关系。

ORGANISATION DU GUIDE DES PRODUITS

Tous les produits sont classés par ordre numérique, sans tenir compte des préfixes ni des suffixes. La liste principale des filtres est la première, suivie des tableaux de dimensions des joints, des filtres DAHL et des filtres.

LES DIMENSIONS SONT MESURÉES D'EXTRÉMITÉ À EXTRÉMITÉ

Nous utilisons les dimensions hors tout, sauf indication contraire. Certains catalogues montrent les dimensions de l'élément uniquement. Nous montrons les dimensions hors tout, y compris les joints et autres protubérances. Vous pouvez alors vérifier que le dégagement est suffisant quand c'est un facteur critique. Les dimensions sont données en pouces et en millimètres.

AVIS IMPORTANT

Les données de ce catalogue sont basées sur les informations les plus récentes disponibles à la mise sous presse. Cependant, les fabricants d'équipement font des changements sans préavis, et ces changements nécessitent des changements

GUIDE DES PRODUITS

Liste principale des filtres
Liste principale des joints
Boîtiers de filtres à air
Filtres DAHL
Tableaux des dimensions des filtres

de nos produits. Faites tourner votre stock pour utiliser d'abord votre stock le plus ancien. Si un filtre n'est pas étanche après installation, il ne doit pas être utilisé. Nous ne pouvons pas être tenus responsables des mauvaises applications.

Les marques et noms de fabricant d'équipement d'origine ne sont utilisés que pour des raisons d'identification. Il n'existe aucune affiliation, parrainage ou connexion avec le fabricant d'équipement d'origine ou ses pièces.

GLIEDERUNG DER PRODUKTÜBERSICHT**PRODUKT-ÜBERSICHT**

Hauptliste Filter

Hauptliste Dichtungen

Luftfiltergehäuse

DAHL-Filter

Tabelle Filtergröße

Alle Produkte sind in numerischer Reihenfolge angeordnet, Vorangestellte und angehängte Zeichen bleiben dabei unberücksichtigt. Als erstes ist die Hauptliste Filter aufgeführt, gefolgt von der Hauptliste Dichtungen, de DAHL-Filtern und den Filter-Größentabellen.

DIE ABMESSUNGEN BEZIEHEN SICH AUF DIE GESAMTLÄNGE

Wenn nicht anders angegeben, beziehen sich unsere Abmessungen auf die Gesamtlänge. In manchen

Katalogen wird nur die Größe eines bestimmten Teils angegeben. Wir geben jedoch die Gesamtlänge an, einschließlich Dichtungen und anderer Teile, die am weitesten herausragen. Dadurch können Sie diesen Faktor berücksichtigen, falls er eine wichtige Rolle spielen sollte. Die Abmessungen sind in Zoll und Millimeter angegeben.

WICHTIGER HINWEIS

Alle technischen Daten in diesem Katalog basieren auf den neuesten zum Zeitpunkt des Drucks verfügbaren Informationen. Die Kfz-Teilehersteller nehmen jedoch bisweilen Änderungen ohne Vorankündigung vor, die auch zu Anpassungen unserer Produkte führen. Rotieren Sie ihre Lagerbestände, so dass die ältesten Teile zuerst verkauft werden. Schließt ein Filter nicht dicht ab, so verwenden Sie ihn nicht. Wir übernehmen keine Haftung für falsche Verwendung.

Die Handelsnamen oder Handelsmarken der Originalteilehersteller werden nur zu Identifikationszwecken angegeben. Es besteht keine Angliederung, Förderung oder Verbindung mit dem Originalteil oder dem Hersteller.

COM'È ORGANIZZATA LA GUIDA PRODOTTO**GUIDA PRODOTTO**

Elenco generale filtri

Elenco generale guarnizioni

Alloggiamenti filtri aria

Filtri DAHL

Grafici delle dimensioni dei filtri

Tutti i prodotti sono elencati in ordine numerico, ignorando i prefissi e i suffissi. Viene prima l'elenco generale dei filtri, seguito da Guarnizioni, Filtri DAHL e Grafici delle dimensioni dei filtri.

LE DIMENSIONI SI INTENDONO DA ESTREMITÀ A ESTREMITÀ

A meno che non indicato diversamente, noi utilizziamo le dimensioni totali. Alcuni cataloghi riportano solo le dimensioni dell'elemento. Noi

indichiamo le dimensioni totali incluso guarnizioni e altre sporgenze massime. In tal modo è possibile verificare che vi sia gioco sufficiente quando questo è un fattore critico. Le dimensioni sono indicate in pollici e millimetri.

AVVISO IMPORTANTE

Tutte le specifiche tecniche riportate in questo catalogo si basano sulle informazioni più autorevoli disponibili al momento di andare in stampa. Tuttavia, i produttori delle apparecchiature apportano modifiche senza preavviso, rendendo necessario modificare il nostro prodotto. Fate ruotare le vostre scorte, in modo da utilizzare prima le scorte più vecchie. Non utilizzare filtri non a tenuta dopo l'installazione. Non siamo responsabili di usi impropri.

I nomi o i marchi di fabbrica del produttore di apparecchiature originali si intendono unicamente per scopi di identificazione. Non esistono affiliazioni, sponsorizzazioni né connessioni con i produttori né con i componenti di apparecchiature originali.

CONFIGURAÇÃO DESTE GUIA DE PRODUTOS

Todos os produtos estão dispostos em ordem numérica, sem levar em conta os prefixos e sufixos. A Lista Mestra de Filtros é a primeira, seguida das juntas, filtros DAHL e tabelas de tamanhos de filtros.

AS MEDIDAS SÃO DE PONTA A PONTA

Utilizamos as dimensões totais, salvo indicações em contrário. Alguns catálogos mostram somente o tamanho do elemento. Mostramos as dimensões totais, incluindo as juntas e outras protuberâncias que se estendam mais para fora. Desta forma, você pode se certificar de que haverá folga suficiente quando isto for um fator crítico. As medidas são mostradas em polegadas e milímetros.

AVISO IMPORTANTE

Todas as especificações neste catálogo têm por base as informações mais recentes disponíveis no momento da publicação. Contudo, os fabricantes dos equipamentos introduzem modificações sem aviso prévio, o que torna necessário alterar nossos

GUIA DE PRODUTOS

Lista principal de filtros

Lista principal de juntas

Carcaças de filtros de ar

Filtros DAHL

Tabelas de tamanhos de filtros

produtos. Mantenha a rotatividade do seu estoque de maneira que sempre se utilize primeiramente do produto mais antigo. Se um filtro não vedar ao ser instalado, não deve ser utilizado. Não nos responsabilizamos por aplicações incorretas.

Os nomes ou marcas comerciais dos fabricantes de equipamentos são apenas para fins de identificação. Não há relacionamento, patrocínio ou conexão com as peças dos equipamentos originais ou com o fabricante.

СХЕМА ОРГАНИЗАЦИИ СПРАВОЧНИКА ПО ПРО—УКЦИИ

Все изделия указываются в порядке нумерации - без учета приставок и суффиксов в обозначении. Первым приводится "Основной перечень фильтров", за которым следуют "Основной перечень уплотнений", "Корпуса воздушных фильтров", "Фильтры серии DAHL" и "Таблицы выбора типоразмера фильтра".

УКАЗАНИЕ РАЗМЕРОВ

За особо оговоренными исключениями, мы применяем габаритные размеры. В некоторых каталогах указывается только размер фильтрующего элемента. Мы сообщаем габаритный размер, которым охватываются уплотнения и прочие выступающие элементы, которые в наибольшей степени влияют на габаритный размер. Благодаря этому можно убедиться в наличии достаточного просвета, если он имеет существенное значение. Размеры указываются в дюймах и миллиметрах.

ВАЖНОЕ ПРИМЕЧАНИЕ

Все технические характеристики, содержащиеся в настоящем каталоге, основаны на последней версии сообщений из авторитетных источников, имевшихся во время печатания каталога. Однако изготовители оборудования не предупреждают о внесении изменений, делающих необходимыми изменения в нашей публикации. Схема

СПРАВОЧНИК ПО ПРО—УКЦИИ

Основной перечень фильтров

Основной перечень уплотнений

Корпуса воздушных фильтров

Фильтры серии DAHL

Таблицы выбора типоразмера фильтра

расходования инвентарных запасов должна быть построена таким образом, чтобы в первую очередь непременно использовались изделия из самой старой партии. Если после установки фильтра не достигается его герметичность, такой фильтр не следует применять. Мы не можем нести ответственность за неправильное использование.

Торговые арки и товарные знаки изготовителей комплектного оборудования приводятся исключительно в целях обозначения продукции. Отсутствует какая-либо принадлежность, поручительство или связь с элементами или изготовителями комплектного оборудования.

CONFIGURACIÓN DE LA GUÍA DE PRODUCTOS

GUÍA DE PRODUCTOS

Lista maestra de filtros

Lista maestra de empaque

Envueltas de filtros de aire

Filtros DAHL

Tablas de tamaños de filtros

Todos los productos están dispuestos en orden numérico, sin tomar en cuenta los prefijos y sufijos. La lista maestra de filtros aparece primero, seguida por las tablas de empaques, filtros DAHL y tamaños de filtros.

MEDIDAS DE PUNTA A PUNTA

Utilizamos dimensiones totales salvo indicación contraria. Algunos catálogos muestran el tamaño del elemento solamente. Nosotros mostramos el

tamaño total incluyendo los empaques y otras protuberancias que sobresalgan más. De esa manera se tiene la seguridad de que hay espacio suficiente cuando éste es un factor crítico. Las medidas se muestran en pulgadas y en milímetros.

NOTA IMPORTANTE

Todas las especificaciones en este catálogo están basadas en la información más reciente disponible en el momento de la publicación. Sin embargo, los fabricantes de equipos a menudo hacen modificaciones a sus equipos sin previo aviso, lo que se traduce en cambios en nuestro producto. Rotar continuamente el stock de manera que siempre se use la mercancía más antigua primero. Si un filtro no cierra bien después de instalado, no usarlo. No podemos responsabilizarnos por aplicaciones incorrectas.

Los nombres comerciales o marcas registradas de los fabricantes de equipos se dan solamente para propósito de identificación. No existe ninguna afiliación, patrocinio o conexión con el fabricante o pieza de equipo original.

B2 Full-Flow Lube Spin-on (Also Used as Hydraulic or Transmission)
Notes: Can be used with OB40079 base.
Contains: Anti-Drainback Valve
 8 PSID By-Pass Valve
 Front End By-Pass Valve
Fits: Chrysler, Ford, Mazda, Toyota Automotive, Light-Duty Trucks; Freightliner, International, Kenworth, Mack, Volvo Trucks; Allis Chalmers, Case, Caterpillar, Ford, John Deere, New Holland Equipment
Replaces: Allis Chalmers 7023700-0; Case A146696; Ford B7A-6714-A, C9NN-6714-A
Thread: 3/4 -16
O.D.: 3 11/16 (93.7)
Height: 5 13/32 (137.3)
I.Gskt: G381-A
Related To: B34 (Short Version)



B6-HPG High Performance Glass Full-Flow Lube Spin-on
Notes: 1 Quart Capacity
Fits: Chevrolet, GM Automotive, Light-Duty Trucks, Vans
Replaces: GMC 25013454
Thread: 13/16 -16
O.D.: 3 11/16 (93.7)
Height: 5 11/32 (135.7)
I.Gskt: [1] Included
Related To: B1428 (with Anti-Drainback Valve)



B2-HPG High Performance Glass Full-Flow Lube Spin-on (Also Used as Hydraulic or Transmission)
Contains: Anti-Drainback Valve
 8 PSID Front End By-Pass Valve
Fits: Antonio Carraro, Hagie, Hymac, Steyr-Daimler-Puch Equipment; Iveco, R.V.I. Trucks
Replaces: Allis Chalmers 7023700-0; Case A146696; Ford B7A-6714-A, C9NN-6714-A
Thread: 3/4 -16
O.D.: 3 11/16 (93.7)
Height: 5 13/32 (137.3)
I.Gskt: G381-A



B7 Full-Flow Lube Spin-on
Notes: 2 Quart Capacity
Fits: Chevrolet, GMC Trucks, Buses
Replaces: GMC 25010754
Thread: 13/16 -16
O.D.: 3 11/16 (93.7)
Height: 8 11/16 (220.7)
I.Gskt: [1] Included



B4 Full-Flow Lube Spin-on
Fits: Chevrolet Automotive
Replaces: GMC 5575425
Thread: 7/16 -20
O.D.: 3 7/16 (87.3)
Height: 4 13/16 (122.2)
I.Gskt: [1] Included
F. Gskt: ES1001



B9 Full-Flow Lube Spin-on
Contains: Anti-Drainback Valve
Fits: Allis Chalmers, Case Equipment; Chrysler, GMC, International Light-Duty Trucks; Jeep; Crusader Marine
Replaces: GMC 5515104, 6435678
Thread: 13/16 -16
O.D.: 3 11/16 (93.7)
Height: 5 3/8 (136.5)
I.Gskt: [1] Included
Related To: B39 (Short Version)
 BT112 (Turbo Version)



BT5 Full-Flow Lube Spin-on (Also Used as Hydraulic or Transmission)
Notes: Can be used with OB40079 base.
Contains: Anti-Drainback Valve
 8 PSID By-Pass Valve
Fits: Fiat Automotive; Ford, Massey Ferguson, Minneapolis-Moline, Same Equipment; Interceptor Marine; Iveco Trucks
Replaces: Ford B8NN-6714-A
Thread: 3/4 -16
O.D.: 4 1/4 (108.0)
Height: 3 15/16 (100.0)
I.Gskt: G381-A



B10-AL Fuel Storage Tank Assembly with Drain
Notes: Removes damaging particles and water from fuels.
 Easily installed on fuel tanks or pumps. Gives effective filtration at flow rates to 25 gpm or gravity flow of 10 gpm with 30 in. head.
 To convert to Spin-on, use FB1307 and BF915.
Contains: [1] B10-AL CAP
 [1] B10-AL BOWL
 [1] PF10 Element
Replaces: Fleetguard 3307454S
O.D.: 4 5/32 (105.6)
Inlet: 1 In. NPT
Outlet: 1 In. NPT
Height: 9 25/32 (248.4)
F. Gskt: G264-A



B6 Full-Flow Lube Spin-on
Notes: 1 Quart Capacity
Fits: Chevrolet, GM Automotive, Light-Duty Trucks, Vans
Replaces: GMC 25013454
Thread: 13/16 -16
O.D.: 3 11/16 (93.7)
Height: 5 11/32 (135.7)
I.Gskt: [1] Included
Related To: B1428 (with Anti-Drainback Valve)



B10-AL BOWL Transparent Amber Bowl with Drain
Thread: 3 3/8 -12
O.D.: 3 7/8 (98.4)
Height: 8 1/8 (206.4)
F. Gskt: [1] Included



Measurements Are Shown In Inches And (Millimeters)

WARNING: These products can expose you to chemicals, including Diisononyl Phthalate, Carbon black extracts, Nickel, 1,3 Butadiene, Ethylene Oxide, Epichlorohydrin, which are known to the State of California to cause cancer, and Bisphenol, Ethylene Glycol, Ethylene Oxide, 1,3 Butadiene, Epichlorohydrin, which are known to the State of California to cause birth defects or other reproductive harm. For more information go to www.P65Warnings.ca.gov.

B10-AL BSP Fuel Storage Tank Assembly with Drain
Notes: Removes damaging particles and water from fuels. Easily installed on fuel tanks or pumps. Gives effective filtration at flow rates to 25 gpm or gravity flow of 10 gpm with 30 In. head.
Contains: [1] CAP
 [1] B10-AL BOWL
 [1] PF10 Element
O.D.: 4 5/32 (105.6)
Inlet: 1 In. BSP
Outlet: 1 In. BSP
Height: 9 25/32 (248.4)
F. Gskt: G264-A



B10-AL BSPCS Fuel Storage Tank Assembly with Water Absorbing Media and Drain
Notes: Removes damaging particles and water from fuels. Easily installed on fuel tanks or pumps. Gives effective filtration at flow rates to 25 gpm or gravity flow of 10 gpm with 30 In. head.
Contains: [1] CAP
 [1] B10-AL BOWL
 [1] PF10-CS Element
O.D.: 4 5/32 (105.6)
Inlet: 1 In. BSP
Outlet: 1 In. BSP
Height: 9 25/32 (248.4)
F. Gskt: G264-A



B10-AL CAP Inlet-Outlet Cap for B10-AL Only
Inlet: 1 In. NPT
Outlet: 1 In. NPT



PF10 Fuel Storage Tank Element
Contains: 1 1/8-12 Mounting Stud
Fits Inside: B10-AL, B10-AL BSP Assembly
O.D.: 3 (76.2)
Height: 4 7/8 (123.8)
F. Gskt: G264-A
End Seals: [1] Attached
Related To: PF10-CS (Water Absorbing Media Version)



PF10-CS Water Absorbing Fuel Storage Tank Element
Contains: 1 1/8-12 Mounting Stud
O.D.: 3 (76.2)
Height: 4 7/8 (123.8)
F. Gskt: G264-A
End Seals: [1] Attached
Related To: PF10 (Standard Version)



PT11 Full-Flow Lube Element
Fits: Detroit Diesel, GMC Engines
Replaces: GMC 5574978
O.D.: 4 7/16 (112.7)
I.D.: 1 17/32 (38.9)
Height: 5 3/4 (146.0)
F. Gskt: G115-MSB, G143
O. Gskt: G280
End Seals: [2] Attached



PT11-HD Heavy-Duty Full-Flow Lube or Hydraulic Clutch Element
Fits: Detroit Diesel, GMC Engines
Replaces: GMC 5574978
O.D.: 4 7/16 (112.7)
I.D.: 1 17/32 (38.9)
Height: 5 3/4 (146.0)
F. Gskt: G115-MSB, G143
O. Gskt: G280
End Seals: [2] Attached



PT12 Full-Flow Lube Element
Fits: Claas, Ford, Perkins Engines; Hymac, Hyster, J.C. Bamford, Massey Ferguson, New Holland Equipment
Replaces: Perkins 1531639
O.D.: 3 3/4 (95.3)
I.D.: 1 5/16 (33.3)
Height: 4 11/16 (119.1)
F. Gskt: G168-B
O. Gskt: G140-A
End Seals: [2] Attached



BF13 Fuel Spin-on
Fits: Isuzu, Nissan Trucks
Replaces: Nissan 16403-Z9003
Thread: 3/4 -16
O.D.: 3 1/32 (77.0)
Height: 4 13/16 (122.2)
I.Gskt: [1] Included



P15 Full-Flow Lube Element
Fits: Ford, Perkins Engines
Replaces: Ford C2TZ-6714-A
O.D.: 3 3/4 (95.3)
I.D.: 1 5/16 (33.3)
Height: 3 13/16 (96.8)
F. Gskt: G168-B
End Seals: [2] Attached



S16-1 Transmission Element with Screen Reinforced Pleats
Fits: Allison Transmissions
Replaces: GMC 6437221
O.D.: 2 7/8 (73.0)
I.D.: 1 3/16 (30.2)
Height: 8 7/16 (214.3)
F. Gskt: [1] Copper Washer, [1] Cork Gasket, [2] O-Rings
End Seals: [2] Attached



Measurements Are Shown In Inches And (Millimeters)

WARNING: These products can expose you to chemicals, including Diisononyl Phthalate, Carbon black extracts, Nickel, 1,3 Butadiene, Ethylene Oxide, Epichlorohydrin, which are known to the State of California to cause cancer, and Bisphenol, Ethylene Glycol, Ethylene Oxide, 1,3 Butadiene, Epichlorohydrin, which are known to the State of California to cause birth defects or other reproductive harm. For more information go to www.P65Warnings.ca.gov.

P18 Full-Flow Lube Element
Fits: Chevrolet, GMC Trucks; Crusader, Mercruiser Marine
Replaces: Chris-Craft 5574540; Cruisemaster 204; GMC 25010471
O.D.: 3 17/32 (89.7)
I.D.: 1 5/16 (33.3)
Height: 5 21/32 (143.7)
F. Gskt: G153
End Seals: [2] Attached



P18-HD Heavy-Duty Racing Lube or Hydraulic Element
Fits: Allison Transmissions; Joy Compressors; Volvo Trucks
Replaces: Joy 1224973; Volvo 1526895-6
O.D.: 3 17/32 (89.7)
I.D.: 1 5/16 (33.3)
Height: 5 21/32 (143.7)
F. Gskt: G153
End Seals: [2] Attached



P19 Full-Flow Lube Element
Fits: Chevrolet Trucks
Replaces: GMC 5573976
O.D.: 3 1/2 (88.9)
I.D.: 1 1/4 (31.8)
Height: 6 1/4 (158.8)
F. Gskt: G153



P20-HD Full-Flow Lube Element
Notes: To convert to spin-on, use OB1303 base and B95 filter.
 For copper bolt seal, use ES1071.
Fits: Allis Chalmers, Case, Clark, Euclid, Gardner Denver, Gradall, Terex Equipment; Detroit Diesel Engines; IHC, Iveco, Kenworth, Mack Trucks
Replaces: GMC 5573013, 25013194
O.D.: 4 7/16 (112.7)
I.D.: 1 1/2 (38.1)
Height: 9 1/16 (230.2)
F. Gskt: ES1032, G115-MSB, G143A
O. Gskt: G143, G280, G336, G340
End Seals: [2] Attached
Related To: PT159, PT159-E (Transmission Versions)



P25 Full-Flow Lube Element
Contains: Reinforced Centertube
Fits: Buick, Oldsmobile, Pontiac Automotive; GMC Light-Duty Trucks; Crusader, GMC, Hyster, DAF Engines
Replaces: GMC 5572188
O.D.: 3 15/16 (100.0)
I.D.: 1 1/16 (27.0)
Height: 6 1/4 (158.8)
F. Gskt: [1] Included
End Seals: [2] Attached



P26 By-Pass Lube Element with Bail Handle
Fits: ACDelco Optional Filter Housings; Buick Automotive
Replaces: GMC 5572202
O.D.: 4 7/32 (107.2)
I.D.: 17/32 (13.5)
Height: 4 11/16 (119.1)
F. Gskt: G115-A
Grommets: [2] Attached



B27 Full-Flow Lube Spin-on
Fits: Buick, Chevrolet Automotive; GMC Light-Duty Trucks, Vans
Replaces: GMC 6437412
Thread: 13/16 -16
O.D.: 3 13/16 (96.8)
Height: 4 3/8 (111.1)
I.Gskt: [1] Included



BD28 Dual-Flow Lube Spin-on
Contains: Anti-Drainback Valve
 20 PSID By-Pass Valve
Fits: Ford Light-Duty Trucks
Replaces: Ford E5TZ-6731-A
Thread: M26 x 1.5
O.D.: 3 11/16 (93.7)
Height: 5 3/8 (136.5)
I.Gskt: G381-A



PT29 Full-Flow Lube Element
Fits: Caterpillar Lift Trucks; Ford (British) Tractors; Claas, Massey Ferguson, Timberjack Equipment
Replaces: Ford E1ADKN-18662-A, E1ADKN-18662-B
O.D.: 2 13/16 (71.4)
I.D.: 1 1/4 (31.8) & 1 5/16 (33.3)
Height: 5 17/32 (140.5)
F. Gskt: G147-A, G161, [2] Included
End Seals: [2] Attached



AFG30 Air Filter Restriction Gauge
Notes: Murphy switch gauge shows exact degree of air filter restriction at a glance. Mounts in dash (2 1/16 in. diameter hole) and shows both inches and cubic centimeters. Measures 0-30 inches water column vacuum.
Contains: Mounting Bracket
Replaces: Fleetguard 3826036S













B30 Full-Flow Lube Spin-on
Fits: GM Automotive
Replaces: GMC 25010324
Thread: 13/16 -16
O.D.: 3 (76.2)
Height: 5 1/8 (130.2)
A. Gskt: G449-B













Measurements Are Shown In Inches And (Millimeters)

WARNING: These products can expose you to chemicals, including Diisononyl Phthalate, Carbon black extracts, Nickel, 1,3 Butadiene, Ethylene Oxide, Epichlorohydrin, which are known to the State of California to cause cancer, and Bisphenol, Ethylene Glycol, Ethylene Oxide, 1,3 Butadiene, Epichlorohydrin, which are known to the State of California to cause birth defects or other reproductive harm. For more information go to www.P65Warnings.ca.gov.

<p>B31</p> 	<p>Full-Flow Lube Spin-on Contains: Anti-Drainback Valve Fits: AMC, GM Automotive, Light-Duty Trucks, Vans Replaces: GMC 25010251 Thread: 13/16 -16 O.D.: 3 (76.2) Height: 3 1/2 (88.9) A. Gskt: G449-B</p>	<p>B37</p>  <p>Full-Flow Lube Spin-on Contains: Anti-Drainback Valve 14 PSID By-Pass Valve Fits: GMC Imports, Suzuki, Toyota Automotive Replaces: GMC 94848478; Toyota 90915-10004 Thread: 3/4 -16 O.D.: 2 9/16 (65.1) Height: 3 1/2 (88.9) I.Gskt: [1] Included</p>
<p>B33</p> 	<p>Full-Flow Lube Spin-on Contains: Anti-Drainback Valve 14 PSID By-Pass Valve Fits: Daihatsu, GMC, Toyota Automotive, Light-Duty Trucks; Generac Generators; John Deere Equipment Replaces: GMC 25161880; John Deere AM107423; Toyota 90915-03001 Thread: 3/4 -16 O.D.: 2 11/16 (68.3) Height: 3 (76.2) I.Gskt: [1] Included</p>	<p>AFG38D</p>  <p>Direct Mount Air Filter Restriction Gauge Notes: Mounts directly on air intake system. Maintains the highest reading until it is reset, which enables the gauge to be monitored whether the engine is running or not. Allows user to get maximum life of an air filter without wasting fuel. Contains: Service decal and Installation instructions Replaces: GMC 25095863; Fleetguard 3304584S</p>
<p>B34</p> 	<p>Lube Spin-on Notes: Can be used with OB40079 base. Contains: Anti-Drainback Valve 8 PSID By-Pass Valve Fits: Chrysler, Mitsubishi, Volkswagen Automotive, Light-Duty Trucks, Vans Replaces: Chrysler 5281090 Thread: 3/4 -16 O.D.: 3 11/16 (93.7) Height: 3 7/8 (98.4) I.Gskt: G381-A Related To: B2 (Long Version)</p>	<p>B39</p>  <p>Full-Flow Lube Spin-on Contains: Anti-Drainback Valve Fits: AMC, GM Automotive; GMC, International Engines Replaces: GMC 6437462 Thread: 13/16 -16 O.D.: 3 11/16 (93.7) Height: 4 3/8 (111.1) A. Gskt: G381-A Related To: B9 (Long Version)</p>
<p>B35-S</p> 	<p>Full-Flow Lube Spin-on Contains: Anti-Drainback Valve Fits: GM Automotive, Light-Duty Trucks, Vans Replaces: GMC 25012760 Thread: M18 x 1.5 O.D.: 3 (76.2) Height: 4 27/32 (123.0) A. Gskt: G449-B Related To: B43-S (Short Version)</p>	<p>P40</p>  <p>Full-Flow Lube Element with Bail Handle Fits: Clark, Galion, Hyster in Fram F3 Series Housings; Allis Chalmers, Bobcat, Case, Caterpillar, Fiat, Onan, Massey Ferguson Equipment Replaces: Clark 604081; Hyster 60518-24; Massey Ferguson 1014219-M91 O.D.: 3 23/32 (94.5) I.D.: 1/2 (12.7) Height: 4 7/16 (112.7) F. Gskt: G105 O. Gskt: G115-A, G402 Grommets: [2] Attached</p>
<p>AFG37R</p> 	<p>Remote Mount Air Filter Restriction Gauge Notes: Mounts on instrument panel or firewall. Maintains the highest reading until it is reset, which enables the gauge to be monitored whether the engine is running or not. Allows the user to get maximum life of an air filter without wasting fuel. Contains: 10 foot rubber hose Push-on brass 1/8 In NPT fitting with brass coupling Mounting screws Service decal Installation instructions Replaces: GMC 25095861; Fleetguard 3303943S</p>	<p>P41</p>  <p>By-Pass Lube Element with Bail Handle Fits: Allis Chalmers, Case, Clark, Continental, Deutz, Ford, Huber Equipment; Hercules, Mercedes-Benz Engines Replaces: Allis Chalmers 4502495-4; Case G54008; Clark 4502495; Ford C7NN-6N605-A O.D.: 4 7/32 (107.2) I.D.: 1/2 (12.7) Height: 4 7/8 (123.8) F. Gskt: G104 Grommets: [2] Attached Related To: PF809 (Fuel Version)</p>













Measurements Are Shown In Inches And (Millimeters)

WARNING: These products can expose you to chemicals, including Diisononyl Phthalate, Carbon black extracts, Nickel, 1,3 Butadiene, Ethylene Oxide, Epichlorohydrin, which are known to the State of California to cause cancer, and Bisphenol, Ethylene Glycol, Ethylene Oxide, 1,3 Butadiene, Epichlorohydrin, which are known to the State of California to cause birth defects or other reproductive harm. For more information go to www.P65Warnings.ca.gov.

<p>P42</p> 	<p>By-Pass Lube Element with Bail Handle Fits: Allis Chalmers, Case, Caterpillar, Continental, Deutz Equipment; Mercedes-Benz Engines Replaces: Case A28008; Caterpillar 63-6372; Deutz 1168469 O.D.: 4 7/32 (107.2) I.D.: 1/2 (12.7) Height: 7 3/4 (196.9) F. Gskt: G104 O. Gskt: G103 Grommets: [2] Attached</p>	<p>B50</p> 	<p>By-Pass Lube Spin-on Notes: Can be used with OB1305 base. Contains: Flow Control Orifice Fits: Allis Chalmers, Caterpillar Engines, Equipment; Massey Ferguson, Oliver Equipment Replaces: Allis Chalmers 4512207-3; Caterpillar 666-3172; Chrysler J0936407; Massey Ferguson 1069954-M91 Thread: 5/8 -18 O.D.: 3 11/16 (93.7) Height: 5 3/8 (136.5) I.Gskt: G381-A Related To: B164 (Long Version) BT341 (Short Version)</p>
<p>B43-S</p> 	<p>Full-Flow Lube Spin-on Contains: Anti-Drainback Valve Fits: AMC, GM, Isuzu Automotive Replaces: GMC 25010766 Thread: M18 x 1.5 O.D.: 2 29/32 (73.8) Height: 3 1/2 (88.9) A. Gskt: G449-B Related To: B35-S (Long Version)</p>	<p>P52</p> 	<p>By-Pass Lube Element with Bail Handle Fits: ACDelco S2 Military Senior Housing; Atlas Copco, Clark, Euclid, Grove, Link-Belt, Terex Equipment; Detroit Diesel, Deutz, GMC, Waukesha Engines Replaces: GMC 5570092; ACDelco P117 O.D.: 4 7/32 (107.2) I.D.: 1/2 (12.7) Height: 8 (203.2) F. Gskt: G115-A, G115-MSB O. Gskt: ES1071, G208-A, G280 Grommets: [2] Attached</p>
<p>B45</p> 	<p>Full-Flow Lube Spin-on Fits: Nissan Engines, Trucks Replaces: Nissan 15208-Z9003 Thread: 1 1/8 -16 O.D.: 4 5/16 (109.5) Height: 9 5/32 (232.6) I.Gskt: [1] Included</p>	<p>P53</p> 	<p>By-Pass Lube Element with Bail Handle Fits: Equipment, Trucks with Chevrolet, Continental, GMC, Hercules, Waukesha, White, Wisconsin Engines Replaces: GMC 5570098 O.D.: 4 7/32 (107.2) I.D.: 1/2 (12.7) Height: 5 (127.0) F. Gskt: G115-A Grommets: [2] Attached</p>
<p>P47</p> 	<p>Full-Flow Lube Element Fits: Ford Equipment Replaces: Ford B8QH-6714-A O.D.: 4 1/2 (114.3) I.D.: 13/16 (20.6) Height: 4 15/16 (125.4) F. Gskt: G164-A, [2] Included End Seals: [1] Attached</p>	<p>P54</p> 	<p>By-Pass Shunt-Type Lube Element with Bail Handle (Also Used as Fuel or Power Steering) Fits: Crane Carrier, Davey, Oliver Equipment; Ingersoll-Rand Compressors Replaces: Davey M14402; Oliver AS5507B O.D.: 3 23/32 (94.5) I.D.: 1/2 (12.7) Height: 6 23/32 (170.7) F. Gskt: G123, [1] Included Grommets: [2] Attached</p>
<p>PT48</p> 	<p>Hydraulic or Transmission Element with Bail Handle Fits: Allis Chalmers, Clark, Hyster Equipment; Iveco Trucks Replaces: Allis Chalmers 618478; Fiat 70618478; Hyster 236093-12 O.D.: 2 7/8 (73.0) I.D.: 25/32 (19.8) & 13/16 (20.6) Height: 3 31/32 (100.8) F. Gskt: [1] Included End Seals: [2] Attached</p>	<p>B56</p> 	<p>Lube Spin-on Contains: 19 PSID By-Pass Valve Fits: Onan Engines Replaces: Onan 122-0602 Thread: M22 x 1.5 O.D.: 3 (76.2) Height: 4 27/32 (123.0) I.Gskt: G449-B</p>
<p>B49</p> 	<p>Full-Flow Lube Spin-on Fits: Caterpillar Equipment Replaces: Fleetguard LF691 Thread: 1 1/2 -16 O.D.: 4 21/32 (118.3) Height: 11 1/4 (285.8) I.Gskt: G498-A Related To: B99 (Long Version)</p>		

Measurements Are Shown In Inches And (Millimeters)

WARNING: These products can expose you to chemicals, including Diisononyl Phthalate, Carbon black extracts, Nickel, 1,3 Butadiene, Ethylene Oxide, Epichlorohydrin, which are known to the State of California to cause cancer, and Bisphenol, Ethylene Glycol, Ethylene Oxide, 1,3 Butadiene, Epichlorohydrin, which are known to the State of California to cause birth defects or other reproductive harm. For more information go to www.P65Warnings.ca.gov.

<p>P60</p> 	<p>Full-Flow Lube Element Fits: Chrysler Industrial, Marine Engines; Purolator P800 Series Housings Replaces: Purolator P82 O.D.: 3 5/16 (84.1) I.D.: 1 1/4 (31.8) Height: 6 3/4 (171.5) F. Gskt: G106, G162, [1] Included</p>	<p>66</p> 	<p>DAHL Fuel Element Notes: 4 Micron Nominal (20 Absolute) Fits: DAHL 65 and 75 Series Fuel Filter/Water Separator Units O.D.: 2 15/16 (74.6) I.D.: 13/32 (10.3) & 1/2 (12.7) Height: 1 13/16 (46.0) A. Gskt: [1] Included O-Ring: [1] Included Grommets: [1] Attached</p>
<p>61</p> 	<p>DAHL Fuel Element Notes: 4 Micron Nominal (20 Absolute) Fits: DAHL 60 Series Fuel Filter/Water Separator Unit O.D.: 2 29/32 (73.8) I.D.: 1/2 (12.7) & 23/32 (18.3) Height: 1 23/32 (43.7) A. Gskt: [1] Included F. Gskt: [1] Included Grommets: [1] Attached</p>	<p>66-30</p> 	<p>DAHL Fuel Element Notes: 9 Micron Nominal (40 Absolute) Fits: DAHL 65 and 75 Series Fuel Filter/Water Separator Units O.D.: 2 15/16 (74.6) I.D.: 13/32 (10.3) & 1/2 (12.7) Height: 1 13/16 (46.0) A. Gskt: [1] Included O-Ring: [1] Included Grommets: [1] Attached</p>
<p>61-W</p> 	<p>DAHL Fuel Element Notes: 5 Micron Nominal (25 Absolute) Fits: DAHL 60 Series Fuel Filter/Water Separator Unit O.D.: 2 29/32 (73.8) I.D.: 1/2 (12.7) & 23/32 (18.3) Height: 1 23/32 (43.7) A. Gskt: [1] Included F. Gskt: [1] Included Grommets: [1] Attached</p>	<p>66-W</p> 	<p>DAHL Fuel Element Notes: 5 Micron Nominal (25 Absolute) Fits: DAHL 65 and 75 Series Fuel Filter/Water Separator Units O.D.: 2 15/16 (74.6) I.D.: 13/32 (10.3) & 1/2 (12.7) Height: 1 13/16 (46.0) A. Gskt: [1] Included O-Ring: [1] Included Grommets: [1] Attached</p>
<p>PT61-HD</p> 	<p>Full-Flow Lube or Hydraulic Element Contains: Reinforced Centertube Fits: Caterpillar Engines, Equipment Replaces: Caterpillar 5B8934, 8B5935 O.D.: 3 1/2 (88.9) I.D.: 1 15/32 (37.3) Height: 5 29/32 (150.0) O. Gskt: G115-MSB, G171, G333</p>	<p>PT66-HD</p> 	<p>Full-Flow Lube or Hydraulic Element Notes: Can be used independently or with PT88-HD as outer lube. Contains: Reinforced Centertube Fits: Caterpillar, Clark, Gardner Denver, LeRoi, Link-Belt Equipment Replaces: Caterpillar 1S9150; LeRoi 24901-2, A43-208, A43-208-A O.D.: 2 7/8 (73.0) I.D.: 1 13/32 (35.7) Height: 9 (228.6) O. Gskt: G171, G270, G283, G376, G410, G432, G435, G436, G442 End Seals: [2] Attached</p>
<p>PT62</p> 	<p>Full-Flow Lube Element Fits: John Deere Equipment Replaces: John Deere AH1081R O.D.: 3 5/16 (84.1) I.D.: 1 1/8 (28.6) Height: 4 1/8 (104.8) A. Gskt: [1] Attached F. Gskt: G107</p>	<p>P67</p> 	<p>By-Pass Lube Element with Bail Handle Fits: Massey Ferguson Engines; Purolator N1600 Series Housings Replaces: Case 10017-2; Chrysler 557218 O.D.: 3 23/32 (94.5) I.D.: 21/32 (16.7) Height: 5 1/4 (133.4) F. Gskt: [1] Included End Seals: [2] Attached</p>
<p>PT63-1</p> 	<p>Full-Flow Lube Element Fits: John Deere Equipment Replaces: John Deere AT15088 O.D.: 3 9/32 (83.3) I.D.: 1 19/32 (40.5) Height: 6 1/2 (165.1) O. Gskt: G220, G251</p>	<p>P68</p> 	<p>By-Pass Lube or Torque Converter Element with Bail Handle Fits: Caterpillar, International Engines; Purolator N1700 Series Housings Replaces: Caterpillar 1L6946; International 259630-R91 O.D.: 3 23/32 (94.5) I.D.: 25/32 (19.8) Height: 5 7/8 (149.2) F. Gskt: [1] Included End Seals: [2] Included</p>

Measurements Are Shown In Inches And (Millimeters)

WARNING: These products can expose you to chemicals, including Diisononyl Phthalate, Carbon black extracts, Nickel, 1,3 Butadiene, Ethylene Oxide, Epichlorohydrin, which are known to the State of California to cause cancer, and Bisphenol, Ethylene Glycol, Ethylene Oxide, 1,3 Butadiene, Epichlorohydrin, which are known to the State of California to cause birth defects or other reproductive harm. For more information go to www.P65Warnings.ca.gov.

PT70



By-Pass Lube Element
Fits: International Engines
Replaces: International 360431-R91
O.D.: 3 1/2 (88.9)
I.D.: 1/2 (12.7) & 15/16 (23.8)
Height: 7 11/32 (186.5)
F. Gskt: G107

PT71



By-Pass Lube Element
Fits: International Engines, Equipment
Replaces: International 376374-R91
O.D.: 3 15/32 (88.1)
I.D.: 17/32 (13.5) & 31/32 (24.6)
Height: 5 11/32 (135.7)
F. Gskt: G107

PT72



By-Pass Lube Element
Fits: Galion, International, LeRoi, Link-Belt, Oliver Equipment; Hercules, International Engines
Replaces: International 257867-R91
O.D.: 3 15/16 (100.0)
I.D.: 5/8 (15.9) & 27/32 (21.4)
Height: 7 1/4 (184.2)
O. Gskt: G115-MSB, G280

P73



By-Pass Lube Element with Bail Handle
Fits: Lid-Type Remote-Mounted By-Pass Filter Housings on Caterpillar, Massey Ferguson, Oliver, Palmer, Pettibone Equipment
Replaces: Caterpillar A68660
O.D.: 3 15/32 (88.1)
I.D.: 9/16 (14.3) & 13/16 (20.6)
Height: 4 3/16 (106.4)
F. Gskt: G106
Grommets: [1] Attached
Related To: P81 (Shunt-Type Version)

B74



Lube Spin-on
Notes: Can be used with OB40079 base.
Contains: Anti-Drainback Valve
 20 PSID By-Pass Valve
Fits: Caterpillar, Ford, New Holland Equipment; Land Rover Light-Duty Trucks
Replaces: Ford E8NN-6714-AA
Thread: 3/4 -16
O.D.: 3 3/4 (95.3)
Height: 3 31/32 (100.8)
I.Gskt: G381-A

B75



Full-Flow Lube Spin-on
Fits: Caterpillar, Iveco, J.C. Bamford, Kawasaki, Kobelco, Koehring, Link-Belt, MDI/Yutani, New Holland, Tamrock, White Equipment; Caterpillar, Isuzu Engines; Chevrolet, GMC, Isuzu, Iveco, Mitsubishi Trucks
Replaces: Caterpillar 9N6007; Isuzu 1-13240-122-0
Thread: 1 1/8 -16
O.D.: 4 1/4 (108.0)
Height: 5 27/32 (148.4)
I.Gskt: [1] Included

B76



Full-Flow Lube Spin-on
Fits: Akerman, Mack, V.M.E., Volvo, R.V.I. Engines, Equipment
Replaces: Mack 485GB3191
Thread: 1 1/8 -16
O.D.: 4 1/4 (108.0)
Height: 10 1/16 (255.6)
I.Gskt: [1] Included
Related To: B76-MPG (Maximum Performance Glass Version)
 B76-SS (Severe Service Version)
 BT556-10 (Hydraulic Version)
 B7225 (Media Difference)
 B7700 (High Performance Version)

B76-MPG



Maximum Performance Glass Full-Flow Lube Spin-on
Fits: Akerman, Mack, V.M.E., Volvo, R.V.I. Engines, Equipment
Replaces: Mack 485GB3191; Donaldson DBL7483
Thread: 1 1/8 -16
O.D.: 4 1/4 (108.0)
Height: 10 1/16 (255.6)
I.Gskt: [1] Included
Related To: B76 (Standard Version)
 B76-SS (Severe Service Version)
 BT556-10 (Hydraulic Version)
 B7225 (Media Difference)
 B7700 (High Performance Version)

B76-SS



Severe Service Lube Spin-on
Fits: Akerman, Mack, V.M.E., Volvo, R.V.I. Engines, Equipment
Replaces: Mack 485GB3191
Thread: 1 1/8 -16
O.D.: 4 1/4 (108.0)
Height: 10 1/16 (255.6)
I.Gskt: [1] Included
Related To: B76 (Standard Version)
 B76-MPG (Maximum Performance Glass Version)
 BT556-10 (Hydraulic Version)
 B7225 (Media Difference)
 B7700 (High Performance Version)

PT79





Full-Flow Lube Element
Fits: Galion, International Equipment; Ingersoll-Rand, Joy, LeRoi Compressors
Replaces: International 262146-R91
O.D.: 4 9/16 (115.9)
I.D.: 1 1/4 (31.8) & 1 11/16 (42.9)
Height: 9 (228.6)
F. Gskt: [1] Included
End Seals: [1] Attached

Measurements Are Shown In Inches And (Millimeters)

WARNING: These products can expose you to chemicals, including Diisononyl Phthalate, Carbon black extracts, Nickel, 1,3 Butadiene, Ethylene Oxide, Epichlorohydrin, which are known to the State of California to cause cancer, and Bisphenol, Ethylene Glycol, Ethylene Oxide, 1,3 Butadiene, Epichlorohydrin, which are known to the State of California to cause birth defects or other reproductive harm. For more information go to www.P65Warnings.ca.gov.

P80 Full-Flow Lube Element

Fits: Allis Chalmers, Case, Grove, New Holland Equipment
Replaces: Ford CPN-6731-A; Fuller A2007, 12039
O.D.: 3 15/16 (100.0)
I.D.: 23/32 (18.3)
Height: 4 13/16 (122.2)
F. Gskt: G132, G208-A, [2] Included
O. Gskt: G171
Grommets: [2] Attached

PT82-HD10 Hydraulic Element

Fits: Case, Ingersoll-Rand Equipment
Replaces: Allis Chalmers 4513108-2; Case D45338; Caterpillar 3K5487; Clark 957572
O.D.: 3 15/16 (100.0)
I.D.: 1 1/16 (27.0)
Height: 5 15/16 (150.8)
F. Gskt: [4] Included
O. Gskt: G219, G222-B
Related To: PF822 (Fuel Version)

P80-HD Heavy-Duty Full-Flow Lube or Hydraulic Element

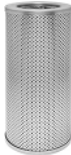
Fits: Various Equipment with Dana, Fuller Transmissions
Replaces: Ford CPN-6731-A; Fuller A2007, 12039
O.D.: 3 15/16 (100.0)
I.D.: 23/32 (18.3)
Height: 4 13/16 (122.2)
F. Gskt: G132, G208-A, [2] Included
O. Gskt: G171
Grommets: [2] Attached

PT83 Hydraulic Element

Notes: Inside-Out Flow Direction.
 Use ES4008 for stacked elements.
Contains: Reinforced Centertube
Fits: Caterpillar Equipment
Replaces: Caterpillar 9J5461
O.D.: 5 1/16 (128.6)
I.D.: 3 11/32 (84.9)
Height: 11 (279.4)
O. Gskt: ES4008, G247, G263, G416, G433
Related To: PT83-MPG (Maximum Performance Glass Version)

P81 Shunt-Type Lube Element

Fits: Purolator P704 Shunt-Type Filter Housing on Chrysler Engines
Replaces: Chrysler 1123151
O.D.: 3 5/16 (84.1)
I.D.: 15/16 (23.8)
Height: 4 1/16 (103.2)
F. Gskt: G106
Related To: P73 (By-Pass Version)

PT83-MPG Maximum Performance Glass Hydraulic Element

Notes: Inside-Out Flow Direction.
 Use ES4008 for stacked elements.
Contains: Reinforced Centertube
Fits: Caterpillar Equipment
Replaces: Caterpillar 9J5461
O.D.: 5 1/16 (128.6)
I.D.: 3 11/32 (84.9)
Height: 11 (279.4)
O. Gskt: ES4008, G247, G263, G416, G433
Related To: PT83 (Standard Version)

P82 Full-Flow Lube Element

Fits: Allis Chalmers, Case, Caterpillar, Deutz Equipment; Chrysler, Hercules Engines
Replaces: Allis Chalmers 73035376; Case D45338; Caterpillar 5B5935; Clark 957577
O.D.: 3 15/16 (100.0)
I.D.: 1 1/16 (27.0)
Height: 5 15/16 (150.8)
F. Gskt: G106, [3] Included
O. Gskt: G219, G222-B
Related To: PF822 (Fuel Version)

P84-2 Full-Flow Lube Element

Fits: Chrysler Engines; Link-Belt, Massey Ferguson, Oliver Equipment
Replaces: Chrysler 1557376
O.D.: 3 5/16 (84.1)
I.D.: 15/16 (23.8)
Height: 4 1/16 (103.2)
F. Gskt: [5] Included

PT82-HD Heavy-Duty Lube or Hydraulic Element

Fits: Akerman, Allis Chalmers, Case, Caterpillar, Clark, Deutz, Link-Belt Equipment
Replaces: Allis Chalmers 4513108-2; Case D45338; Caterpillar 3K5487; Clark 957572
O.D.: 3 15/16 (100.0)
I.D.: 1 1/16 (27.0)
Height: 5 15/16 (150.8)
F. Gskt: [4] Included
O. Gskt: G219, G222-B
Related To: PF822 (Fuel Version)

PT85 Full-Flow Lube Element

Fits: Cleveland, Hough, International, Link-Belt Equipment
Replaces: International 323863-R91
O.D.: 4 5/8 (117.5)
I.D.: 1 5/16 (33.3)
Height: 5 1/8 (130.2)
O. Gskt: G203
End Seals: [1] Attached

PT86-HD Full-Flow Lube or Hydraulic Element

Fits: Dresser, Galion, Hough, International, LeRoi, Link-Belt Equipment
Replaces: International 346609-R91
O.D.: 4 1/2 (114.3)
I.D.: 1 25/32 (45.2)
Height: 8 15/16 (227.0)
F. Gskt: [2] Included
O. Gskt: G280
End Seals: [2] Attached

PT86-HD Full-Flow Lube or Hydraulic Element

Fits: Dresser, Galion, Hough, International, LeRoi, Link-Belt Equipment
Replaces: International 346609-R91
O.D.: 4 1/2 (114.3)
I.D.: 1 25/32 (45.2)
Height: 8 15/16 (227.0)
F. Gskt: [2] Included
O. Gskt: G280
End Seals: [2] Attached

Measurements Are Shown In Inches And (Millimeters)

WARNING: These products can expose you to chemicals, including Diisononyl Phthalate, Carbon black extracts, Nickel, 1,3 Butadiene, Ethylene Oxide, Epichlorohydrin, which are known to the State of California to cause cancer, and Bisphenol, Ethylene Glycol, Ethylene Oxide, 1,3 Butadiene, Epichlorohydrin, which are known to the State of California to cause birth defects or other reproductive harm. For more information go to www.P65Warnings.ca.gov.

PT87-S Full-Flow Lube, Hydraulic or Transmission Element



Fits: John Deere Equipment
Replaces: John Deere AR28271, AR75603, AT34670
O.D.: 4 9/16 (115.9)
I.D.: 2 1/4 (57.2)
Height: 5 1/2 (139.7)
F. Gskt: G307, G397
End Seals: [2] Attached

PT88-HD Full-Flow Lube or Hydraulic Element



Notes: Use ES4008 for stacked elements. Can be used independently or with PT66-HD as inner lube.
Fits: Caterpillar, Clark, Hyster, Komatsu, LeRoi Equipment
Replaces: Caterpillar 5S485, 5S0485
O.D.: 5 1/8 (130.2)
I.D.: 3 3/8 (85.7)
Height: 8 15/16 (227.0)
F. Gskt: G196-B
O. Gskt: ES4008, G303, G304, G306, G354

PT89 Hydraulic Steering or Power Control Element



Fits: Allis Chalmers Tractors; Caterpillar Equipment
Replaces: Caterpillar 5J8877
O.D.: 5 1/8 (130.2)
I.D.: 3 3/8 (85.7)
Height: 6 (152.4)
O. Gskt: G265

PT90-10 Hydraulic Element



Notes: Use ES4008 for stacked elements.
Contains: Reinforced Centertube
Fits: Allis Chalmers, Caterpillar, Fiat-Allis, Komatsu Equipment
Replaces: Caterpillar 4J806, 4J6064
O.D.: 5 1/8 (130.2)
I.D.: 3 3/8 (85.7)
Height: 9 (228.6)
O. Gskt: ES4008, G196-B, G265, G347, G360
Related To: PT90-MPG (Glass Media Version) PT568 (as Specified in Applications)

PT90-MPG Maximum Performance Glass Hydraulic Element



Notes: Use ES4008 for stacked elements.
Contains: Reinforced Centertube
Fits: Caterpillar Equipment
Replaces: Caterpillar 4J806, 4J6064
O.D.: 5 1/8 (130.2)
I.D.: 3 3/8 (85.7)
Height: 9 (228.6)
O. Gskt: ES4008, G196-B, G265, G347, G360
Related To: PT90-10 (Standard Media Version) PT568 (as Specified in Applications)

PT91 Hydraulic Element



Notes: Inside-Out Flow Direction
Contains: Reinforced Centertube
Fits: Caterpillar Equipment
Replaces: Caterpillar 4T0522
O.D.: 5 1/8 (130.2)
I.D.: 3 3/8 (85.7)
Height: 7 (177.8)

PT93 Full-Flow Lube or Hydraulic Element



Contains: Reinforced Centertube
Fits: Caterpillar Equipment
Replaces: Caterpillar 4J816
O.D.: 3 1/8 (79.4)
I.D.: 1 7/8 (47.6)
Height: 8 31/32 (227.8)
O. Gskt: G162, G323, G434

PT93-MPG Maximum Performance Glass Hydraulic Element



Contains: Reinforced Centertube
Fits: Caterpillar Equipment
Replaces: Caterpillar 4J816
O.D.: 3 1/8 (79.4)
I.D.: 1 7/8 (47.6)
Height: 8 31/32 (227.8)
O. Gskt: G162, G323, G434

B95 Full-Flow Lube Spin-on



Notes: Can be used with OB1303 base.
Contains: Integral Post Seal
Fits: Detroit Diesel Engines
Replaces: GMC 25010495
Thread: 1 1/2 -12
O.D.: 4 21/32 (118.3)
Height: 9 15/16 (252.4)
I.Gskt: [1] Included
Related To: B105 (Short Version)

B95-MPG Maximum Performance Glass Full-Flow Lube Spin-on



Notes: Can be used with OB1303 base.
Contains: Integral Post Seal
Fits: Detroit Diesel Engines
Replaces: GMC 25010495
Thread: 1 1/2 -12
O.D.: 4 21/32 (118.3)
Height: 9 15/16 (252.4)
I.Gskt: [1] Included

B95-SS Severe Service Full-Flow Lube Spin-on



Notes: Can be used with OB1303 base.
Contains: Integral Post Seal
Fits: Detroit Diesel Engines
Replaces: GMC 25010495
Thread: 1 1/2 -12
O.D.: 4 21/32 (118.3)
Height: 9 15/16 (252.4)
I.Gskt: [1] Included

Measurements Are Shown In Inches And (Millimeters)

WARNING: These products can expose you to chemicals, including Diisononyl Phthalate, Carbon black extracts, Nickel, 1,3 Butadiene, Ethylene Oxide, Epichlorohydrin, which are known to the State of California to cause cancer, and Bisphenol, Ethylene Glycol, Ethylene Oxide, 1,3 Butadiene, Epichlorohydrin, which are known to the State of California to cause birth defects or other reproductive harm. For more information go to www.P65Warnings.ca.gov.

B96 Full-Flow Lube Spin-on
Notes: Can be used with OB1368, OB1369 bases.
Contains: Integral Post Seal
Fits: Cummins Engines
Replaces: Cummins 3313287
Thread: 1 1/2 -12
O.D.: 4 11/16 (119.1)
Height: 11 9/32 (286.5)
I.Gskt: [1] Included
Related To: B196, B205 (Short Versions)



PT98-MPG Maximum Performance Glass Hydraulic Element
Notes: Use ES4008 for stacked elements.
Contains: Reinforced Centertube
Fits: Caterpillar Equipment
Replaces: Caterpillar 7J670, 7J0670
O.D.: 6 25/32 (172.2)
I.D.: 3 15/16 (100.0)
Height: 9 (228.6)
O. Gskt: ES4008, G412, G438



B96-MPG Maximum Performance Glass Full-Flow Lube Spin-on
Notes: Can be used with OB1368, OB1369 bases.
Contains: Integral Post Seal
Fits: Cummins Engines
Replaces: Cummins 3313287
Thread: 1 1/2 -12
O.D.: 4 11/16 (119.1)
Height: 11 9/32 (286.5)
I.Gskt: [1] Included
Related To: B196, B205 (Short Versions)



B99 Full-Flow Lube Spin-on
Fits: Atlas Copco, Demag, Caterpillar Equipment
Replaces: Caterpillar 1R0716
Thread: 1 1/2 -16
O.D.: 5 3/8 (136.5)
Height: 12 3/32 (307.2)
I.Gskt: [1] Included
Related To: B49 (Short Version)
 B7249-MPG, B7299 (High Efficiency Versions)



B96-SS Severe Service Lube Spin-on
Notes: Can be used with OB1368, OB1369 bases.
Contains: Integral Post Seal
Fits: Cummins Engines
Replaces: Cummins 3313287
Thread: 1 1/2 -12
O.D.: 4 11/16 (119.1)
Height: 11 9/32 (286.5)
I.Gskt: [1] Included
Related To: B196, B205 (Short Versions)



B99-B Full-Flow Lube Spin-on (Boxed Version)
Fits: Atlas Copco, Demag, Caterpillar Equipment
Replaces: Caterpillar 1R0716
Thread: 1 1/2 -16
O.D.: 5 3/8 (136.5)
Length: 12 3/32 (307.2)
I.Gskt: [1] Included
Related To: B49 (Short Version)
 B7249-MPG (High Efficiency Version)
 B7299 (High Efficiency Version)



B97 Full-Flow Lube Spin-on
Fits: Hough, International Equipment
Replaces: International 684206-C1
Thread: 1 1/2 -16
O.D.: 4 21/32 (118.3)
Height: 9 29/32 (251.6)
I.Gskt: G498-A



B99-MPG Maximum Performance Glass Full-Flow Lube Spin-on
Fits: Atlas Copco, Demag, Caterpillar Equipment
Replaces: Caterpillar 1R0716
Thread: 1 1/2 -16
O.D.: 5 3/8 (136.5)
Height: 12 3/32 (307.2)
I.Gskt: [1] Included
Related To: B49 (Short Version)
 B7249-MPG (High Efficiency Version)
 B7299 (High Efficiency Version)



PT98-10 Hydraulic Element
Notes: Use ES4008 for stacked elements.
Contains: Reinforced Centertube
Fits: Caterpillar Equipment
Replaces: Caterpillar 7J670, 7J0670
O.D.: 6 25/32 (172.2)
I.D.: 3 15/16 (100.0)
Height: 9 (228.6)
O. Gskt: ES4008, G412, G438



B99-SS Severe Service Lube Spin-on
Fits: Atlas Copco, Demag, Caterpillar Equipment
Replaces: Caterpillar 1R0716
Thread: 1 1/2 -16
O.D.: 5 3/8 (136.5)
Height: 12 3/32 (307.2)
I.Gskt: [1] Included
Related To: B49 (Short Version)
 B7249-MPG (High Efficiency Version)
 B7299 (High Efficiency Version)



101 DAHL Fuel Element
Notes: 4 Micron Nominal (20 Absolute)
Fits: DAHL 100 Series Fuel Filter/Water Separator Units
O.D.: 4 7/32 (107.2)
I.D.: 5/8 (15.9) & 1 11/16 (42.9)
Height: 2 5/16 (58.7)
A. Gskt: [1] Included
F. Gskt: [1] Included
Grommets: [1] Attached









101 DAHL Fuel Element
Notes: 4 Micron Nominal (20 Absolute)
Fits: DAHL 100 Series Fuel Filter/Water Separator Units
O.D.: 4 7/32 (107.2)
I.D.: 5/8 (15.9) & 1 11/16 (42.9)
Height: 2 5/16 (58.7)
A. Gskt: [1] Included
F. Gskt: [1] Included
Grommets: [1] Attached













Measurements Are Shown In Inches And (Millimeters)

WARNING: These products can expose you to chemicals, including Diisononyl Phthalate, Carbon black extracts, Nickel, 1,3 Butadiene, Ethylene Oxide, Epichlorohydrin, which are known to the State of California to cause cancer, and Bisphenol, Ethylene Glycol, Ethylene Oxide, 1,3 Butadiene, Epichlorohydrin, which are known to the State of California to cause birth defects or other reproductive harm. For more information go to www.P65Warnings.ca.gov.

<p>101-30 DAHL Fuel Element Notes: 9 Micron Nominal (40 Absolute) Fits: DAHL 100 Series Fuel Filter/Water Separator Units O.D.: 4 7/32 (107.2) I.D.: 5/8 (15.9) & 1 11/16 (42.9) Height: 2 5/16 (58.7) A. Gskt: [1] Attached F. Gskt: [1] Included Grommets: [1] Attached</p> 	<p>BD103-SS Severe Service Dual-Flow Lube Spin-on Fits: Cummins Engines Replaces: Cummins 3318853; Fleetguard LF3000 Thread: 2 1/4 -12 O.D.: 4 21/32 (118.3) Height: 11 13/32 (289.7) I.Gskt: G293-B Related To: BD103 (Standard Version) BD103-MPG (Maximum Performance Glass Version) BD324 (Short Version) BD7309 (High Velocity Version)</p> 
<p>101-W DAHL Fuel Element Notes: 5 Micron Nominal (25 Absolute) Fits: DAHL 100 Series Fuel Filter/Water Separator Units O.D.: 4 7/32 (107.2) I.D.: 5/8 (15.9) & 1 11/16 (42.9) Height: 2 5/16 (58.7) A. Gskt: [1] Included F. Gskt: [1] Included Grommets: [1] Attached</p> 	<p>P104 Full-Flow Lube Element Fits: Rolls-Royce Engines Replaces: Rolls-Royce OE12448 O.D.: 3 15/16 (100.0) I.D.: 19/32 (15.1) & 1 15/32 (37.3) Height: 5 23/32 (145.3) F. Gskt: [1] Included End Seals: [1] Attached</p> 
<p>P102 2-Section Full-Flow/By-Pass Lube Element with Bail Handle Contains: Grommet Seal Between Sections Fits: Mercedes-Benz Buses, Trucks Replaces: Mercedes-Benz 6171840025, 6171840125 O.D.: 3 15/32 (88.1) I.D.: 7/16 (11.1) & 31/32 (24.6) Height: 7 5/8 (193.7) F. Gskt: [1] Included Grommets: [3] Attached</p> 	<p>B105 Full-Flow Lube Spin-on Notes: Can be used with OB1303 base. Fits: Detroit Diesel Engines Replaces: GMC 25014120 Thread: 1 1/2 -12 O.D.: 4 21/32 (118.3) Height: 6 9/32 (159.5) I.Gskt: [1] Included Related To: B95 (Long Version)</p> 
<p>BD103 Dual-Flow Lube Spin-on Fits: Cummins Engines Replaces: Cummins 3318853; Fleetguard LF3000 Thread: 2 1/4 -12 O.D.: 4 21/32 (118.3) Height: 11 13/32 (289.7) I.Gskt: G293-B Related To: BD103-MPG (Maximum Performance Glass Version) BD103-SS (Severe Service Version) BD324 (Short Version) BD7309 (High Velocity Version)</p> 	<p>P106 Full-Flow Lube Element Notes: Outside-In Flow Direction Fits: Iveco Engines Replaces: Mercedes-Benz 11507425104 O.D.: 2 5/16 (58.7) I.D.: 11/16 (17.5) Height: 3 31/32 (100.8) F. Gskt: [1] Included O. Gskt: G232</p> 
<p>BD103-MPG Maximum Performance Glass Dual-Flow Lube Spin-on Fits: Cummins Engines Replaces: Cummins 3318853; Fleetguard LF3000 Thread: 2 1/4 -12 O.D.: 4 21/32 (118.3) Height: 11 13/32 (289.7) I.Gskt: G293-B Related To: BD103 (Standard Version) BD103-SS (Severe Service Version) BD324 (Short Version) BD7309 (High Velocity Version)</p> 	<p>P106-HD Power Steering Element Notes: Inside-Out Flow Direction Fits: DAF, Iveco, M.A.N., Mercedes-Benz, R.V.I. Trucks Replaces: Mercedes-Benz 11507425104 O.D.: 2 5/16 (58.7) I.D.: 11/16 (17.5) Height: 3 31/32 (100.8) F. Gskt: [1] Included O. Gskt: G232</p> 
	<p>PT108 Full-Flow Lube Element Fits: Allis Chalmers, Caterpillar, Ford, Hyster, Massey Ferguson, Perkins, Timberjack Engines, Equipment Replaces: Hyster 156952; Massey Ferguson 1851766-M1; Perkins 26540132 O.D.: 2 29/32 (73.8) I.D.: 27/32 (21.4) Height: 4 1/2 (114.3) F. Gskt: G147-A</p> 

Measurements Are Shown In Inches And (Millimeters)

WARNING: These products can expose you to chemicals, including Diisononyl Phthalate, Carbon black extracts, Nickel, 1,3 Butadiene, Ethylene Oxide, Epichlorohydrin, which are known to the State of California to cause cancer, and Bisphenol, Ethylene Glycol, Ethylene Oxide, 1,3 Butadiene, Epichlorohydrin, which are known to the State of California to cause birth defects or other reproductive harm. For more information go to www.P65Warnings.ca.gov.

<p>PT108-HD</p> 	<p>Heavy-Duty Lube or Hydraulic Element Fits: Massey Ferguson Equipment Replaces: Hyster 156952; Massey Ferguson 1851766-M1; Perkins 26540132 O.D.: 2 29/32 (73.8) I.D.: 27/32 (21.4) Height: 4 1/2 (114.3) F. Gskt: G147-A</p>	<p>B114</p> 	<p>Full-Flow Lube Spin-on Contains: Anti-Drainback Valve 30 PSID By-Pass Valve Fits: Audi, Volkswagen, Volvo Automotive, Light-Duty Trucks; R.V.I. Trucks Replaces: Volkswagen 68115561; Volvo 13281611 Thread: 3/4 -16 O.D.: 3 3/4 (95.3) Height: 5 9/32 (134.1) I.Gskt: G381-A</p>
<p>B109</p> 	<p>Full-Flow Lube Spin-on Contains: Anti-Drainback Valve 20 PSID By-Pass Valve Fits: Caterpillar, Kobelco, Mustang Equipment; GMC, Isuzu Automotive Replaces: GMC 94428931 Thread: M20 x 1.5 O.D.: 3 3/4 (95.3) Height: 5 5/16 (134.9) I.Gskt: [1] Included</p>	<p>PT115</p> 	<p>Full-Flow Lube Element Fits: Allis Chalmers Equipment Replaces: Allis Chalmers 4349986 O.D.: 4 7/16 (112.7) I.D.: 1 17/32 (38.9) Height: 7 7/8 (200.0) F. Gskt: [1] Included End Seals: [2] Attached</p>
<p>BC110</p> 	<p>Centrifugal By-Pass Lube Element Fits: Mack Engines Replaces: Mack 57GC286, 236GB244 O.D.: 3 27/32 (97.6) I.D.: 9/16 (14.3) & 5/8 (15.9) Height: 4 1/2 (114.3) F. Gskt: G118 End Seals: ES3012 Included</p>	<p>P116</p> 	<p>By-Pass Lube Element with Bail Handle Notes: Used in Fram F43P housing. Fits: Cummins, Deutz Engines Replaces: Cummins 151858; Deutz P4H4120 O.D.: 5 27/32 (148.4) I.D.: 31/32 (24.6) Height: 9 13/16 (249.2) F. Gskt: G102-A Grommets: [2] Attached</p>
<p>BT111</p> 	<p>Lube Spin-on Contains: 20 PSID By-Pass Valve Fits: Ford Tractors; New Holland Equipment Replaces: Bosch 451-203-059; New Holland 86546614 Thread: 3/4 -16 O.D.: 3 11/16 (93.7) Height: 5 3/8 (136.5) I.Gskt: G381-A</p>	<p>PF116</p> 	<p>Fuel Element with Bail Handle Notes: Used in Fram F1143PBM housing. Optional gasket G356 used in Fleetguard housing. Fits: Cummins Engines Replaces: Cummins 139097 O.D.: 5 27/32 (148.4) I.D.: 31/32 (24.6) Height: 9 13/16 (249.2) F. Gskt: G102-A, [1] Included O. Gskt: G356 Grommets: [2] Attached</p>
<p>BT112</p> 	<p>Turbocharger Lube Spin-on Contains: 8 PSID By-Pass Valve Fits: Cummins Engines; Euclid Equipment Replaces: Cummins 152499 Thread: 13/16 -16 O.D.: 3 11/16 (93.7) Height: 5 3/8 (136.5) I.Gskt: G381-A Related To: B9 (Lube Version)</p>	<p>PT117</p> 	<p>By-Pass Lube Element with Bail Handle Fits: Equipment with Fram F54 Series Housings Replaces: Fram C54 O.D.: 6 (152.4) I.D.: 1 1/8 (28.6) Height: 14 1/2 (368.3) O. Gskt: G102-A End Seals: [2] Attached</p>
<p>B113</p> 	<p>Full-Flow Lube Spin-on Contains: Anti-Drainback Valve Fits: Ford Vans; Nissan, Subaru, Volkswagen Automotive, Light-Duty Trucks; Kubota Lift Trucks Replaces: Nissan 15208-H8916; Subaru 15208-AA001 Thread: 3/4 -16 O.D.: 3 1/32 (77.0) Height: 4 1/16 (103.2) I.Gskt: [1] Included</p>		

Measurements Are Shown In Inches And (Millimeters)

WARNING: These products can expose you to chemicals, including Diisononyl Phthalate, Carbon black extracts, Nickel, 1,3 Butadiene, Ethylene Oxide, Epichlorohydrin, which are known to the State of California to cause cancer, and Bisphenol, Ethylene Glycol, Ethylene Oxide, 1,3 Butadiene, Epichlorohydrin, which are known to the State of California to cause birth defects or other reproductive harm. For more information go to www.P65Warnings.ca.gov.

PT117-25 Full-Flow Lube Element with Bail Handle
Fits: Equipment with Fram F54 Series Housings
Replaces: Fram C54
O.D.: 6 (152.4)
I.D.: 1 1/8 (28.6)
Height: 14 1/2 (368.3)
O. Gskt: G102-A
End Seals: [2] Attached



B120 Full-Flow Lube Spin-on
Contains: Anti-Drainback Valve
Fits: Nissan Automotive, Engines
Replaces: Nissan 15208-W1116
Thread: 3/4 -16
O.D.: 3 11/16 (93.7)
Height: 3 7/8 (98.4)
I.Gskt: G381-A



B118 Full-Flow Lube Spin-on
Contains: Anti-Drainback Valve
Fits: Ford, Isuzu, Nissan Engines
Replaces: Isuzu 8-94414-778
Thread: 3/4 -16
O.D.: 3 11/16 (93.7)
Height: 5 3/8 (136.5)
I.Gskt: G381-A



PF121 Fuel Element
Replaces: John Deere TY5029, TY15218
O.D.: 3 9/32 (83.3)
I.D.: 1 1/4 (31.8) One End
Height: 5 1/8 (130.2)
O. Gskt: G229
End Seals: [1] Attached



PT119 Hydraulic Sump Element
Notes: Used in Fram FH58PL or FH258PL housings.
Fits: Clark Equipment
Replaces: Clark 943559
O.D.: 6 (152.4)
I.D.: 3 1/2 (88.9)
Height: 14 1/2 (368.3)
A. Gskt: [2] Attached
O. Gskt: G210



PT122-5 Hydraulic Element
Fits: Peco Housings
Replaces: Peco PP618-5
O.D.: 6 (152.4)
I.D.: 3 1/2 (88.9)
Height: 18 (457.2)
A. Gskt: [2] Attached



PT119-5 Special Fluid Element
Notes: Used in Bowser-Briggs 845, 852 housings.
Fits: Clark Equipment
Replaces: Clark 943559
O.D.: 6 (152.4)
I.D.: 3 1/2 (88.9)
Height: 14 1/2 (368.3)
A. Gskt: [2] Attached
O. Gskt: G210



BT124 Full-Flow Lube Spin-on
Contains: Anti-Drainback Valve
 20 PSID By-Pass Valve
Fits: Oliver, White Equipment
Replaces: White 40-0000406
Thread: 7/8 -16
O.D.: 4 1/4 (108.0)
Height: 7 11/32 (186.5)
I.Gskt: G381-A



PT119-HD Heavy-Duty Hydraulic Sump Element
Fits: Clark Equipment
Replaces: Clark 943559
O.D.: 6 (152.4)
I.D.: 3 1/2 (88.9)
Height: 14 1/2 (368.3)
A. Gskt: [2] Included
O. Gskt: G210



P125 Full-Flow Lube Element with 2 Bail Handles
Fits: Mercedes-Benz Automotive
Replaces: Mercedes-Benz 11849925
O.D.: 3 1/4 (82.6)
I.D.: 7/16 (11.1) & 1 13/32 (35.7)
Height: 4 3/4 (120.7)
F. Gskt: [3] Metal Washers
O-Ring: [1] Included
Grommets: [2] Attached



PT119-HD5 Heavy-Duty Hydraulic Sump Element
Fits: Clark Equipment
Replaces: Clark 943559
O.D.: 6 (152.4)
I.D.: 3 1/2 (88.9)
Height: 14 1/2 (368.3)
A. Gskt: [2] Attached
O. Gskt: G210



BT126 Full-Flow Lube Spin-on
Contains: Anti-Drainback Valve
 8 PSID By-Pass Valve
Fits: Minneapolis-Moline, Oliver, White Equipment
Replaces: Oliver 169019-A
Thread: 7/8 -14
O.D.: 3 11/16 (93.7)
Height: 7 1/8 (181.0)
I.Gskt: G381-A
Related To: BT264 (Short Version)



Measurements Are Shown In Inches And (Millimeters)

WARNING: These products can expose you to chemicals, including Diisononyl Phthalate, Carbon black extracts, Nickel, 1,3 Butadiene, Ethylene Oxide, Epichlorohydrin, which are known to the State of California to cause cancer, and Bisphenol, Ethylene Glycol, Ethylene Oxide, 1,3 Butadiene, Epichlorohydrin, which are known to the State of California to cause birth defects or other reproductive harm. For more information go to www.P65Warnings.ca.gov.

P127 Full-Flow Lube Element
Replaces: Leyland 801779
O.D.: 3 31/32 (100.8)
I.D.: 1 5/8 (41.3)
Height: 5 1/32 (127.8)
End Seals: [2] Attached



C133-OW Wound Cotton Full-Flow Lube Orlon Sock
Notes: For use with high heat applications.
Fits: Waukesha Engines
Replaces: Waukesha 168660, 168660B
O.D.: 4 3/8 (111.1)
I.D.: 1 1/16 (27.0) & 1 5/8 (41.3)
Height: 31 (787.4)
End Seals: [1] Attached
Related To: V1656-O, V1656-T (Single-Length Versions)



B128 By-Pass Lube Spin-on
Fits: Thermo King Refrigeration Units
Replaces: Thermo King 11-3746
Thread: 3/4 -20
O.D.: 4 1/4 (108.0)
Height: 7 3/8 (187.3)
I.Gskt: G401



C133-W Wound Cotton Full-Flow Lube Cotton Sock
Fits: Waukesha Engines
Replaces: Waukesha 168660, 168660B
O.D.: 4 3/8 (111.1)
I.D.: 1 1/16 (27.0) & 1 5/8 (41.3)
Height: 31 (787.4)
End Seals: [1] Attached
Related To: V1656-O, V1656-T (Single-Length Versions)



B129 Full-Flow Lube Spin-on
Fits: Thermo King Refrigeration Units
Replaces: Thermo King 11-3871
Thread: 1 -12
O.D.: 4 1/4 (108.0)
Height: 7 3/8 (187.3)
I.Gskt: G401



B134 Full-Flow Lube Spin-on
Fits: Ford Automotive, Light-Duty Trucks, Vans; Ford, International Equipment
Replaces: Ford E3TZ-6731-A; International 1804442-C1
Thread: 1 1/2 -16
O.D.: 4 1/4 (108.0)
Height: 5 7/8 (149.2)
I.Gskt: [1] Included



B131 Full-Flow Lube Spin-on
Contains: Anti-Drainback Valve
 8 PSID By-Pass Valve
Fits: Chevrolet, Toyota Automotive; Datsun, Nissan Lift Trucks; John Deere Lawn & Garden Equipment; Northern Lights Equipment
Replaces: Nissan 31725-L1000; Toyota 11501-01270
Thread: 3/4 -16
O.D.: 3 1/32 (77.0)
Height: 3 7/16 (87.3)
I.Gskt: [1] Included



PT135 By-Pass Lube Element
Fits: Eaton, International, Universal Equipment
Replaces: International 251404-R91
O.D.: 2 9/16 (65.1)
I.D.: 7/16 (11.1) & 17/32 (13.5)
Height: 4 5/8 (117.5)
O. Gskt: G379



B132 Full-Flow Lube Spin-on
Notes: Can be used with OB40079 base.
Contains: Anti-Drainback Valve
 8 PSID By-Pass Valve
Fits: AMC, Chrysler, Renault Automotive; Volvo Engines
Replaces: Chrysler 4419970, 4419970-0; Renault 7701348028
Thread: 3/4 -16
O.D.: 3 11/16 (93.7)
Height: 3 1/4 (82.6)
I.Gskt: G381-A



PT137 Full-Flow Lube Element
Fits: Allis Chalmers, Oliver Equipment
Replaces: Hercules 380221
O.D.: 4 7/16 (112.7)
I.D.: 1 1/2 (38.1)
Height: 7 (177.8)
F. Gskt: [1] Included
End Seals: [2] Attached













PT138-10 Hydraulic Element
Fits: Case Equipment
Replaces: Case D45378, G33058 Element in A61235 Kit
O.D.: 3 15/16 (100.0)
I.D.: 1 1/16 (27.0)
Height: 6 1/16 (154.0)
F. Gskt: G376, [1] Included
End Seals: [2] Attached

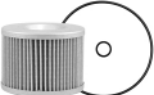













Measurements Are Shown In Inches And (Millimeters)

WARNING: These products can expose you to chemicals, including Diisononyl Phthalate, Carbon black extracts, Nickel, 1,3 Butadiene, Ethylene Oxide, Epichlorohydrin, which are known to the State of California to cause cancer, and Bisphenol, Ethylene Glycol, Ethylene Oxide, 1,3 Butadiene, Epichlorohydrin, which are known to the State of California to cause birth defects or other reproductive harm. For more information go to www.P65Warnings.ca.gov.

<p>PT138-25 Hydraulic, Power Steering or Brake Element Fits: Case Equipment Replaces: Case A60524, A61234 O.D.: 3 15/16 (100.0) I.D.: 1 1/16 (27.0) Height: 6 1/16 (154.0) F. Gskt: G376, [1] Included End Seals: [2] Attached</p> 	<p>P144 Full-Flow Lube Element Replaces: Citroen N223/1; Purflux L108 O.D.: 3 3/16 (81.0) I.D.: 1 1/16 (27.0) Height: 2 9/16 (65.1) End Seals: [2] Attached</p> 
<p>PT139-10 Pressure-Type Hydraulic Element with Exposed Pleats Fits: Caterpillar Lift Trucks; Marvel TB578366 Housing Replaces: Marvel 578366-5110 O.D.: 4 1/2 (114.3) I.D.: 2 1/4 (57.2) One End Height: 9 3/4 (247.7) A. Gskt: [1] Attached</p> 	<p>PT146 Full-Flow Lube Element Contains: Reinforced Centertube Fits: Komatsu Equipment Replaces: Komatsu 6610-50-5100, 6610-51-4400 O.D.: 5 (127.0) I.D.: 2 3/16 (55.6) Height: 9 5/16 (236.5) O. Gskt: G164-A End Seals: [2] Attached</p> 
<p>P140 Full-Flow Lube Element Fits: GM Automotive Replaces: GMC 25012305 O.D.: 2 29/32 (73.8) I.D.: 1 1/16 (17.5) One End Height: 2 3/4 (69.9) O-Ring: [1] Attached Grommets: [1] Attached</p> 	<p>P148 Full-Flow Lube Element Fits: Honda, Kawasaki, Yamaha Motorcycles Replaces: Honda 15412-300-024 O.D.: 3 1/32 (77.0) I.D.: 7/8 (22.2) Height: 2 1/4 (57.2) F. Gskt: [2] Included Grommets: [2] Attached</p> 
<p>B141 Full-Flow Lube Spin-on Contains: Anti-Drainback Valve 20 PSID By-Pass Valve Fits: Buick, Chevrolet, Chrysler, Eagle, Jeep, Peugeot Automotive Replaces: GMC 6439354 Thread: M20 x 1.5 O.D.: 3 11/16 (93.7) Height: 3 7/8 (98.4) I.Gskt: G381-A</p> 	<p>P150 Full-Flow Lube Element with Bail Handle Fits: Isuzu Engines; Komatsu, TCM Lift Trucks Replaces: Isuzu 13240-045; Komatsu 13240045 O.D.: 2 7/8 (73.0) I.D.: 9/16 (14.3) Height: 6 5/8 (168.3) Grommets: [2] Attached</p> 
<p>BD142 Dual-Flow Lube Spin-on Contains: Anti-Drainback Valve Integral Post Seal Standpipe Fits: GMC, Isuzu, Nissan Automotive Replaces: Isuzu 8-94143-205-0 Thread: 1 -12 O.D.: 4 7/32 (107.2) Height: 5 1/8 (130.2) I.Gskt: [1] Included</p> 	<p>151 DAHL Fuel Element Notes: 4 Micron Nominal (20 Absolute) Fits: DAHL 150 Series Fuel Filter/Water Separator Unit O.D.: 4 7/32 (107.2) I.D.: 27/32 (21.4) & 1 11/16 (42.9) Height: 4 9/32 (108.7) A. Gskt: [1] Included O-Ring: [1] Included Grommets: [1] Attached</p> 
<p>B143 Full-Flow Lube Spin-on Contains: Anti-Drainback Valve Fits: Toyota Automotive, Lift Trucks Replaces: Toyota 15601-33020 Thread: 3/4 -16 O.D.: 3 (76.2) Height: 5 3/32 (129.4) I.Gskt: [1] Included Related To: B295 (Long Version)</p> 	<p>151-30 DAHL Fuel Element Notes: 9 Micron Nominal (40 Absolute) Fits: DAHL 150 Series Fuel Filter/Water Separator Unit O.D.: 4 7/32 (107.2) I.D.: 27/32 (21.4) & 1 11/16 (42.9) Height: 4 9/32 (108.7) F. Gskt: 150-15 O-Ring: [1] Included Grommets: [1] Attached</p> 

Measurements Are Shown In Inches And (Millimeters)
WARNING: These products can expose you to chemicals, including Diisononyl Phthalate, Carbon black extracts, Nickel, 1,3 Butadiene, Ethylene Oxide, Epichlorohydrin, which are known to the State of California to cause cancer, and Bisphenol, Ethylene Glycol, Ethylene Oxide, 1,3 Butadiene, Epichlorohydrin, which are known to the State of California to cause birth defects or other reproductive harm. For more information go to www.P65Warnings.ca.gov.

<p>151-W</p> 	<p>DAHL Fuel Element Notes: 5 Micron Nominal (25 Absolute) Fits: DAHL 150 Series Fuel Filter/Water Separator Unit O.D.: 4 7/32 (107.2) I.D.: 27/32 (21.4) & 1 11/16 (42.9) Height: 4 9/32 (108.7) A. Gskt: [1] Included O-Ring: [1] Included Grommets: [1] Attached</p>	<p>B156</p> 	<p>Full-Flow Lube Spin-on Contains: Anti-Drainback Valve 20 PSID By-Pass Valve Fits: Honda Automotive Replaces: Honda 15400-689-004 Thread: M22 x 1.5 O.D.: 3 11/16 (93.7) Height: 3 1/4 (82.6) I.Gskt: G324-A</p>
<p>PT151</p> 	<p>Full-Flow Lube Element with Bail Handle Fits: Minneapolis-Moline Tractors Replaces: LeTourneau 10P732, 10R1322 O.D.: 3 23/32 (94.5) I.D.: 9/16 (14.3) Height: 4 13/32 (111.9) F. Gskt: G123 Grommets: [2] Attached</p>	<p>B157</p> 	<p>Full-Flow Lube Spin-on Notes: 1 1/2 Quart Capacity Contains: 20 PSID By-Pass Valve Fits: Ford Engines, Trucks Replaces: Ford E7HZ-6731-A Thread: 1 -12 O.D.: 4 1/4 (108.0) Height: 7 3/8 (187.3) I.Gskt: G401</p>
<p>PT152</p> 	<p>Full-Flow Lube Element Fits: Minneapolis-Moline, Oliver Tractors Replaces: Minneapolis-Moline 10A10423, 10R1323 O.D.: 4 17/32 (115.1) I.D.: 7/8 (22.2) Height: 6 1/4 (158.8) O. Gskt: G380</p>	<p>B159</p> 	<p>Full-Flow Lube Spin-on Contains: Anti-Drainback Valve 8 PSID By-Pass Valve Fits: GMC Imports, Suzuki Automotive Replaces: GMC 96058042; Suzuki 16510-83011 Thread: 3/4 -16 O.D.: 3 (76.2) Height: 4 1/16 (103.2) I.Gskt: [1] Included</p>
<p>PT153</p> 	<p>Full-Flow Lube Element Fits: International Light-Duty Trucks; Nissan Lift Trucks Replaces: Nissan 15208-61525 O.D.: 3 15/16 (100.0) I.D.: 19/32 (15.1) & 1 5/8 (41.3) Height: 6 3/8 (161.9) F. Gskt: [2] Included End Seals: [1] Attached</p>	<p>B160</p> 	<p>Full-Flow Lube Spin-on Contains: Anti-Drainback Valve 20 PSID By-Pass Valve Fits: Cadillac, GMC Light-Duty Trucks; VM Engines Replaces: GMC 89017524; VM Engines 4115031 Thread: M22 x 1.5 O.D.: 3 (76.2) Height: 3 1/2 (88.9) I.Gskt: G449-B</p>
<p>PT154</p> 	<p>Full-Flow Lube Element Contains: Reinforced Centertube Fits: Case, Grove, International Engines Replaces: Case A20822; International 193187-R91 O.D.: 4 17/32 (115.1) I.D.: 1/2 (12.7) & 1 25/32 (45.2) Height: 7 1/16 (179.4) F. Gskt: G184-A O. Gskt: G115-MSB, G280 End Seals: [1] Attached Grommets: [1] Attached</p>	<p>B161-S</p> 	<p>Full-Flow Lube Spin-on Contains: Anti-Drainback Valve 20 PSID By-Pass Valve Fits: Acura, Ford, Honda, Mazda Automotive; Kubota Engines Replaces: Ford D87Z-6731-A; Mazda 8173-23-802 Thread: M20 x 1.5 O.D.: 3 1/32 (77.0) Height: 4 1/16 (103.2) I.Gskt: [1] Included</p>
<p>PF155</p> 	<p>Fuel Element Notes: Used in Luber-finer F155C, F170 housings. Fits: Cummins Engines Replaces: Cummins 130909 O.D.: 4 1/2 (114.3) I.D.: 7/8 (22.2) Height: 8 3/16 (208.0) O. Gskt: ES1066, ES1074, G169, G363 End Seals: [2] Attached</p>	<p>P162</p> 	<p>Full-Flow Lube Element Fits: Lamborghini, Maserati Automotive Replaces: Lamborghini 11880; Maserati 421242874 O.D.: 2 5/8 (66.7) I.D.: 1 7/32 (31.0) Height: 8 11/16 (220.7) End Seals: [2] Attached</p>

Measurements Are Shown In Inches And (Millimeters)

⚠️ WARNING: These products can expose you to chemicals, including Diisononyl Phthalate, Carbon black extracts, Nickel, 1,3 Butadiene, Ethylene Oxide, Epichlorohydrin, which are known to the State of California to cause cancer, and Bisphenol, Ethylene Glycol, Ethylene Oxide, 1,3 Butadiene, Epichlorohydrin, which are known to the State of California to cause birth defects or other reproductive harm. For more information go to www.P65Warnings.ca.gov.

B163 Full-Flow Lube or Transmission Spin-on
Notes: Can be used with OB40079 base.
Contains: Anti-Drainback Valve
 8 PSID By-Pass Valve
Fits: Allis Chalmers, Atlas Copco, Bolens, Case, Ford, International, John Deere, Oliver, Onan, White Equipment; Ford, Volvo Automotive
Replaces: Ford E8NN-6714-CA; Mack 6432PER17; Onan 122-0185; White 156513A
Thread: 3/4 -16
O.D.: 3 11/16 (93.7)
Height: 3 7/8 (98.4)
I.Gskt: G381-A



P170 Full-Flow Lube Element
Fits: Komatsu Lift Trucks; Nissan Engines
Replaces: Nissan 15208-32225, 15208-43800
O.D.: 2 13/16 (71.4)
I.D.: 1 5/16 (33.3)
Height: 5 13/32 (137.3)
End Seals: [2] Attached



B164 By-Pass Lube Spin-on
Notes: Can be used with OB1305 base.
Contains: Flow Control Orifice
Fits: Carrier Refrigeration Units
Replaces: Carrier-Transcold 30-00304-00
Thread: 5/8 -18
O.D.: 3 11/16 (93.7)
Height: 6 5/8 (168.3)
I.Gskt: G381-A
Related To: B50, BT341 (Short Versions)



P171 Full-Flow Lube Element
Fits: J.C. Bamford Equipment; Leyland Engines
Replaces: Chrysler 2067263; Nissan 15208-31300
O.D.: 2 7/8 (73.0)
I.D.: 1 5/16 (33.3)
Height: 4 1/4 (108.0)
F. Gskt: G147-A, G161
O. Gskt: G183
Related To: P172 (with End Seals)



B166 Full-Flow Lube Spin-on
Contains: Anti-Drainback Valve
 20 PSID By-Pass Valve
Fits: Honda Automotive; Ford Tractors
Replaces: Honda 15400-634-003
Thread: M20 x 1.5
O.D.: 3 25/32 (96.0)
Height: 3 1/4 (82.6)
I.Gskt: [1] Included



P172 Full-Flow Lube Element
Fits: Leyland Engines, Equipment
Replaces: Leyland 162429
O.D.: 2 29/32 (73.8)
I.D.: 1 5/16 (33.3)
Height: 4 7/16 (112.7)
F. Gskt: G147-A, G165, [1] Included
End Seals: [2] Attached
Related To: P171 (without End Seals)



B167 Full-Flow Lube Spin-on
Notes: 1 1/2 Quart Capacity
Contains: Anti-Drainback Valve
 8 PSID By-Pass Valve
Fits: Dresser, Hough, International Engines, Equipment
Replaces: International 427207-C3, 528250-R91, 3059246-R91, 3059247-R91
Thread: 1 -12
O.D.: 3 11/16 (93.7)
Height: 7 1/8 (181.0)
I.Gskt: G381-A



B173-S Full-Flow Lube Spin-on
Contains: Anti-Drainback Valve
 20 PSID By-Pass Valve
Fits: AMC, Chrysler, Eagle, Hyundai, Isuzu, Mitsubishi Automotive, Light-Duty Trucks
Replaces: Chrysler 4186267
Thread: M20 x 1.5
O.D.: 3 11/16 (93.7)
Height: 3 1/4 (82.6)
A. Gskt: G381-A



B168 Full-Flow Lube Spin-on
Contains: Anti-Drainback Valve
 8 PSID By-Pass Valve
Fits: Takeuchi Equipment; Yanmar Engines
Replaces: John Deere CH10467; Thermo King 11-4928; Yanmar 124550-35110
Thread: M20 x 1.5
O.D.: 3 (76.2)
Height: 5 3/32 (129.4)
I.Gskt: [1] Included



P174 Full-Flow Lube Element
Fits: International, Leyland, Lister, Petter Engines
Replaces: International 3043283-R91; Leyland ABU8912; Lister 419-3265; Nissan 15208-32200
O.D.: 2 7/8 (73.0)
I.D.: 1 5/16 (33.3)
Height: 5 9/16 (141.3)
F. Gskt: G147-A, G165, [2] Included
O. Gskt: G161, G239
End Seals: [2] Attached













P176 Full-Flow Lube Element
Fits: Lister Engines
Replaces: Lister 419-3038, 201-26020
O.D.: 2 7/8 (73.0)
I.D.: 1 5/16 (33.3)
Height: 3 15/32 (88.1)
F. Gskt: G239
O. Gskt: G402
Related To: PF820-S (Fuel Version)



Measurements Are Shown In Inches And (Millimeters)

WARNING: These products can expose you to chemicals, including Diisononyl Phthalate, Carbon black extracts, Nickel, 1,3 Butadiene, Ethylene Oxide, Epichlorohydrin, which are known to the State of California to cause cancer, and Bisphenol, Ethylene Glycol, Ethylene Oxide, 1,3 Butadiene, Epichlorohydrin, which are known to the State of California to cause birth defects or other reproductive harm. For more information go to www.P65Warnings.ca.gov.

<p>P177</p> 	<p>Full-Flow Lube Element Fits: Coventry Climax Engines, Lift Trucks; Perkins Engines Replaces: Perkins 26540055 O.D.: 2 7/8 (73.0) I.D.: 1 5/16 (33.3) Height: 6 (152.4) F. Gskt: G161, [2] Included O. Gskt: G147-A End Seals: [2] Attached</p>	<p>P184</p> 	<p>Full-Flow Lube Element Fits: Ford, Iveco Engines, Trucks Replaces: Ford B8C-6731-A O.D.: 3 5/16 (84.1) I.D.: 15/16 (23.8) Height: 4 27/32 (123.0) F. Gskt: G132, G268, [2] Included</p>
<p>B178</p> 	<p>Full-Flow Lube Spin-on Contains: Anti-Drainback Valve 30 PSID By-Pass Valve Fits: Audi, BMW, Dodge, Porsche, Volkswagen Automotive; Bobcat, Deutz, Ingersoll-Rand, Vermeer Equipment Replaces: Chrysler J3232126; Volkswagen 56115561G Thread: 3/4 -16 O.D.: 2 15/16 (74.6) Height: 4 27/32 (123.0) I.Gskt: G449-B Related To: B228 (Short Version)</p>	<p>PT185</p> 	<p>Full-Flow Lube Element Fits: Dresser, Drott, Galion, Gradall, Hough, International Equipment; International Engines Replaces: International 279994-R91 O.D.: 3 15/16 (100.0) I.D.: 1 19/32 (40.5) Height: 5 9/16 (141.3) F. Gskt: G273 End Seals: [2] Attached</p>
<p>B179</p> 	<p>Full-Flow Lube Spin-on Contains: Anti-Drainback Valve 8 PSID By-Pass Valve Fits: Honda Automotive; Kubota, Yanmar Engines Replaces: Kubota 70000-15241; Transcold 2535206; Yanmar 124450-35100 Thread: M20 x 1.5 O.D.: 3 (76.2) Height: 2 27/32 (72.2) I.Gskt: [1] Included</p>	<p>P186</p> 	<p>Power Steering Element Fits: Allis Chalmers, Massey Ferguson Equipment Replaces: Allis Chalmers 79170-7; International 168743-R91 O.D.: 3 17/32 (89.7) I.D.: 1 1/8 (28.6) Height: 2 1/2 (63.5)</p>
<p>PT181 KIT</p> 	<p>3-Part Hydraulic Kit Contains: Reinforced Centertube [2] Elements [1] S423 Resin Ribbon Spacer Element [2] Gaskets Fits: Allis Chalmers Crawler Tractors, Excavators, Loaders Replaces: Allis Chalmers 3019695, 3033507 Larger Element O.D.: 3 5/16 (84.1) I.D.: 1 1/8 (28.6) Height: 8 7/8 (225.4) F. Gskt: [2] Included Smaller Element O.D.: 3 5/16 (84.1) I.D.: 1 5/32 (29.4) Height: 4 13/32 (111.9)</p>	<p>P187</p> 	<p>Transmission or Air Shift Breather Element Fits: Dana, Fuller Transmissions; Euclid, Massey Ferguson, WABCO Equipment; GMC Trucks Replaces: GMC 2354770 O.D.: 2 7/8 (73.0) I.D.: 1 1/16 (27.0) Height: 3 (76.2) F. Gskt: [1] Included</p>
<p>P183</p> 	<p>Power Steering or Hydraulic Element Fits: Case, Caterpillar, Ford, International, Massey Ferguson Equipment; Chrysler, Ford Automotive Replaces: Case A22279; International 133205-R91 O.D.: 3 3/16 (81.0) I.D.: 1 1/16 (27.0) Height: 1 9/16 (39.7) End Seals: [2] Attached</p>	<p>PT189</p> 	<p>Hydraulic or Transmission Element Notes: Use ES4007 for stacked elements. Contains: Reinforced Centertube Fits: Caterpillar Equipment Replaces: Caterpillar 2M3943 O.D.: 3 15/16 (100.0) I.D.: 2 9/32 (57.9) Height: 9 3/16 (233.4) O. Gskt: ES1049, ES1074, ES4007, G229, G310, G333, G342, G376, G403, G433, G445, G447</p>
		<p>PT189-MPG</p> 	<p>Maximum Performance Glass Hydraulic or Transmission Element Notes: Use ES4007 for stacked elements. Contains: Reinforced Centertube Fits: Caterpillar Equipment Replaces: Caterpillar 2M3943 O.D.: 3 15/16 (100.0) I.D.: 2 9/32 (57.9) Height: 9 3/16 (233.4) O. Gskt: ES1049, ES1074, ES4007, G229, G310, G333, G342, G376, G403, G433, G445, G447</p>

Measurements Are Shown In Inches And (Millimeters)

WARNING: These products can expose you to chemicals, including Diisononyl Phthalate, Carbon black extracts, Nickel, 1,3 Butadiene, Ethylene Oxide, Epichlorohydrin, which are known to the State of California to cause cancer, and Bisphenol, Ethylene Glycol, Ethylene Oxide, 1,3 Butadiene, Epichlorohydrin, which are known to the State of California to cause birth defects or other reproductive harm. For more information go to www.P65Warnings.ca.gov.

P190 Full-Flow Lube Element
Fits: Case, David Brown Equipment; Ford Buses, Trucks
Replaces: David Brown 902125; Ford 528E-6731-A
O.D.: 3 3/4 (95.3)
I.D.: 1 5/16 (33.3)
Height: 2 7/8 (73.0)
F. Gskt: G168-B
End Seals: [2] Attached



PT193 KIT Hydraulic Element Plus Gaskets
Contains: [1] PT193
 [2] G253-A
 [1] G288
 [1] G289
Fits: Euclid, Terex Equipment
Replaces: Euclid 9190077
O.D.: 6 (152.4)
I.D.: 3 17/32 (89.7)
Height: 8 17/32 (216.7)
F. Gskt: [4] Included



PT191 Hydraulic Sump Element
Fits: Clark, Euclid, Gradall Equipment; Sullair Compressors
Replaces: Clark 141676; Euclid 4008687
O.D.: 6 (152.4)
I.D.: 3 17/32 (89.7)
Height: 8 (203.2)
O. Gskt: G253-A, G314, G359



PT193-3 Hydraulic Element
Notes: For Terex Kit 9038953, Add Optional Gaskets [2] G253-A and [1] G289
Fits: Euclid, Terex Equipment
Replaces: Euclid 9190077
O.D.: 6 (152.4)
I.D.: 3 17/32 (89.7)
Height: 8 17/32 (216.7)
O. Gskt: G289



PT191-10 Hydraulic Element
Fits: Clark, Euclid, Gradall Equipment; Sullair Compressors
Replaces: Clark 141676; Euclid 4008687
O.D.: 6 (152.4)
I.D.: 3 17/32 (89.7)
Height: 8 (203.2)
O. Gskt: G253-A, G314, G359



P194 Full-Flow Lube Element
Fits: Caterpillar, Quincy Equipment; Mack Engines
Replaces: Allis Chalmers 3010360-0; Case A26984; Euclid 9029081
O.D.: 6 1/32 (153.2)
I.D.: 1 23/32 (43.7)
Height: 7 5/8 (193.7)
O. Gskt: G193
End Seals: [2] Attached
Related To: PT394-5, PT394-15 (Different Microns)



PT191-5 Hydraulic Element
Fits: Clark, Euclid, Gradall Equipment; Sullair Compressors
Replaces: Clark 141676; Euclid 4008687
O.D.: 6 (152.4)
I.D.: 3 17/32 (89.7)
Height: 8 (203.2)
O. Gskt: G253-A, G314, G359



P194-HD Hydraulic Element
Fits: Allis Chalmers, Case, Euclid, Gradall, John Deere, Koehring Equipment
Replaces: Allis Chalmers 3010360-0; Case A26984; Euclid 9029081
O.D.: 6 1/32 (153.2)
I.D.: 1 23/32 (43.7)
Height: 7 5/8 (193.7)
O. Gskt: G193
End Seals: [2] Attached
Related To: PT394-5, PT394-15 (Different Microns)



PT193 Hydraulic or Full-Flow Lube Element
Fits: Euclid, Terex Equipment
Replaces: Euclid 9190077
O.D.: 6 (152.4)
I.D.: 3 17/32 (89.7)
Height: 8 17/32 (216.7)
O. Gskt: G289









P194-HD10 Hydraulic Element
Fits: CMC, Gardner Denver, Ingersoll-Rand Equipment
Replaces: Caterpillar 6B8217; Ingersoll-Rand 35252154
O.D.: 6 1/32 (153.2)
I.D.: 1 23/32 (43.7)
Height: 7 5/8 (193.7)
O. Gskt: G193
End Seals: [2] Attached
Related To: PT394-5, PT394-15 (Different Microns)













Measurements Are Shown In Inches And (Millimeters)

WARNING: These products can expose you to chemicals, including Diisononyl Phthalate, Carbon black extracts, Nickel, 1,3 Butadiene, Ethylene Oxide, Epichlorohydrin, which are known to the State of California to cause cancer, and Bisphenol, Ethylene Glycol, Ethylene Oxide, 1,3 Butadiene, Epichlorohydrin, which are known to the State of California to cause birth defects or other reproductive harm. For more information go to www.P65Warnings.ca.gov.

<p>PF194</p> 	<p>Fuel Element Fits: Caterpillar Engines Replaces: Caterpillar 2H7254 O.D.: 6 1/32 (153.2) I.D.: 1 23/32 (43.7) Height: 7 5/8 (193.7) O. Gskt: G193 End Seals: [2] Attached Related To: PT394-5, PT394-15 (Different Microns)</p>	<p>201-30</p> 	<p>DAHL Fuel Element Notes: 9 Micron Nominal (40 Absolute) Fits: DAHL 200 Series Fuel Filter/Water Separator Units O.D.: 6 1/16 (154.0) I.D.: 1 15/32 (37.3) & 3 9/32 (83.3) Height: 4 5/8 (117.5) A. Gskt: [1] Attached F. Gskt: 200-15A O-Ring: [1] Attached</p>
<p>B195</p> 	<p>Full-Flow Lube Spin-on Contains: Anti-Drainback Valve Fits: Peugeot Automotive, Light-Duty Trucks Replaces: Peugeot 1109-35,-59 Thread: M18 x 1.5 O.D.: 3 1/8 (79.4) Height: 3 1/2 (88.9) I.Gskt: [1] Included</p>	<p>201-W</p> 	<p>DAHL Fuel Element Notes: 4 Micron Nominal (20 Absolute) Fits: DAHL 200 Series Fuel Filter/Water Separator Units O.D.: 6 1/16 (154.0) I.D.: 1 15/32 (37.3) & 3 9/32 (83.3) Height: 4 5/8 (117.5) A. Gskt: [1] Included F. Gskt: 200-15A O-Ring: [1] Attached</p>
<p>B196</p> 	<p>Full-Flow Lube Spin-on Notes: Can be used with OB1368, OB1369 bases. Contains: Integral Post Seal Fits: Cummins Engines Replaces: Fleetguard LF670SC Thread: 1 1/2 -12 O.D.: 4 21/32 (118.3) Height: 9 15/16 (252.4) I.Gskt: [1] Included Related To: B96, B96-MPG (Long Versions)</p>	<p>B201-S</p> 	<p>By-Pass Lube Spin-on Fits: Ford, Mazda Automotive, Light-Duty Trucks Replaces: Ford E3TZ-6731-B; Mazda 8259-23-802,-0 Thread: M20 x 1.5 O.D.: 4 1/4 (108.0) Height: 3 3/16 (81.0) I.Gskt: [1] Included</p>
<p>P198</p> 	<p>Full-Flow Lube or Transmission Element Fits: Broom & Wade Compressors; Dorman, Lister, Petter Engines Replaces: Broom & Wade A1413302; Dorman L111/4, Q429/4; Lister 291-40910 O.D.: 3 1/2 (88.9) I.D.: 2 (50.8) Height: 6 15/16 (176.2) F. Gskt: [1] Included O. Gskt: G202</p>	<p>B202</p> 	<p>Full-Flow Lube Spin-on Contains: Anti-Drainback Valve 20 PSID By-Pass Valve Fits: Chrysler, Ford, Mazda, Mitsubishi Automotive, Light-Duty Trucks Replaces: Ford E37A-6714-BA; Mazda S213-23-802 Thread: M20 x 1.5 O.D.: 3 11/16 (93.7) Height: 5 3/8 (136.5) I.Gskt: G381-A</p>
<p>B199</p> 	<p>Full-Flow Lube Spin-on Contains: Anti-Drainback Valve 8 PSID By-Pass Valve Fits: Ford, Mercury Automotive Replaces: Ford D2PJ-6714-AA Thread: M20 x 1.5 O.D.: 3 (76.2) Height: 5 1/8 (130.2) I.Gskt: G449-B</p>	<p>P203</p> 	<p>Full-Flow Lube Element Contains: Reinforced Centertube Fits: Austin-Western Equipment; International Engines, Equipment Replaces: Chrysler 2647018; Ford C5R-6731-A; International 213388-R91 O.D.: 4 17/32 (115.1) I.D.: 1/2 (12.7) & 2 9/32 (57.9) Height: 5 1/16 (128.6) F. Gskt: [2] Included O. Gskt: G115-MSB, G280 End Seals: [1] Attached Grommets: [1] Attached</p>
<p>201</p> 	<p>DAHL Fuel Element Notes: 4 Micron Nominal (20 Absolute) Fits: DAHL 200 Series Fuel Filter/Water Separator Units O.D.: 6 1/16 (154.0) I.D.: 1 15/32 (37.3) & 3 9/32 (83.3) Height: 4 5/8 (117.5) A. Gskt: [1] Included F. Gskt: 200-15A O-Ring: [1] Attached</p>		







Measurements Are Shown In Inches And (Millimeters)

WARNING: These products can expose you to chemicals, including Diisononyl Phthalate, Carbon black extracts, Nickel, 1,3 Butadiene, Ethylene Oxide, Epichlorohydrin, which are known to the State of California to cause cancer, and Bisphenol, Ethylene Glycol, Ethylene Oxide, 1,3 Butadiene, Epichlorohydrin, which are known to the State of California to cause birth defects or other reproductive harm. For more information go to www.P65Warnings.ca.gov.

<p>P203-HD Hydraulic Element</p>  <p>Contains: Reinforced Centertube Fits: Dresser, International, Racine Equipment Replaces: Chrysler 2647018; Ford C5R-6731-A; International 213388-R91 O.D.: 4 17/32 (115.1) I.D.: 1/2 (12.7) & 2 9/32 (57.9) Height: 5 1/16 (128.6) F. Gskt: [1] Included O. Gskt: G115-MSB, G280 End Seals: [1] Attached Grommets: [1] Attached</p>	<p>B205 Full-Flow Lube Spin-on</p>  <p>Notes: Can be used with OB1368, OB1369 bases. Contains: Integral Post Seal Fits: Ag-Chem, Case, Case-International, Champion, Daewoo, Dresser, Fiat-Allis, Gradall, Grove, Hyster, Hyundai, Ingersoll-Rand, Kawasaki, Link-Belt, Rickel, Steiger, Timberjack, White Equipment; Case, Cummins Replaces: Case A77537; Cummins 3313281 Thread: 1 1/2 -12 O.D.: 4 21/32 (118.3) Height: 8 3/32 (205.6) I.Gskt: [1] Included Related To: B96 (Long Version)</p>
<p>P203-HD10 Hydraulic Element</p>  <p>Contains: Reinforced Centertube Fits: Cessna, Challenger Equipment Replaces: Chrysler 2647018; Ford C5R-6731-A; International 213388-R91 O.D.: 4 17/32 (115.1) I.D.: 1/2 (12.7) & 2 9/32 (57.9) Height: 5 1/16 (128.6) O. Gskt: G115-MSB, G280 End Seals: [1] Attached Grommets: [1] Attached</p>	<p>P206 Full-Flow Lube Element</p>  <p>Fits: International Engines, Trucks Replaces: International 236649-R91, 871867-R91, 871868-R91 O.D.: 4 17/32 (115.1) I.D.: 1/2 (12.7) & 2 1/4 (57.2) Height: 3 3/4 (95.3) F. Gskt: G115-MSB O. Gskt: G280 End Seals: [1] Attached Grommets: [1] Attached</p>
<p>P204 Full-Flow Lube Element</p>  <p>Contains: Reinforced Centertube Fits: Clark, Crane Carrier, Galion, Gradall, Grove, Hough, International Equipment Replaces: Caterpillar 63-6083; International 213445-R91 O.D.: 4 17/32 (115.1) I.D.: 1/2 (12.7) & 2 9/32 (57.9) Height: 7 1/16 (179.4) O. Gskt: G184-A, G211, G280, G362 End Seals: [1] Attached Grommets: [1] Attached</p>	<p>PT207 Hydraulic Element</p>  <p>Notes: Use in Gresen in-line housing. Fits: Allis Chalmers, Case, Caterpillar, John Deere, Massey Ferguson, New Holland, Oliver, Steiger, Versatile Equipment Replaces: Gresen 1509, 1567, 3143, 3144 O.D.: 4 1/2 (114.3) I.D.: 1 7/8 (47.6) Height: 6 31/32 (177.0) F. Gskt: [2] ES1092 O. Gskt: ES3029, G236-A, G385, G386 Related To: PT554, PT573 (Long Versions)</p>
<p>P204-HD Hydraulic Element</p>  <p>Contains: Reinforced Centertube Fits: Case, Caterpillar, Dresser, International Equipment Replaces: Caterpillar 63-6083; International 213445-R91 O.D.: 4 17/32 (115.1) I.D.: 1/2 (12.7) & 2 9/32 (57.9) Height: 7 1/16 (179.4) O. Gskt: G184-A, G211, G280, G362 End Seals: [1] Attached Grommets: [1] Attached</p>	<p>PT207-10 Hydraulic Element</p>  <p>Notes: Use in Gresen in-line housing. Fits: Allis Chalmers, Case, Caterpillar, John Deere, Massey Ferguson, New Holland, Oliver, Steiger, Versatile Equipment Replaces: Gresen 1509, 1567, 3143, 3144 O.D.: 4 1/2 (114.3) I.D.: 1 7/8 (47.6) Height: 6 31/32 (177.0) F. Gskt: [2] ES1092 O. Gskt: ES3029, G236-A, G385, G386 Related To: PT554, PT573 (Long Versions)</p>
<p>P204-HD10 Hydraulic Element</p>  <p>Contains: Reinforced Centertube Fits: Case, Michigan, P&H Harnischfeger, Vickers Equipment Replaces: Caterpillar 63-6083; International 213445-R91 O.D.: 4 17/32 (115.1) I.D.: 1/2 (12.7) & 2 9/32 (57.9) Height: 7 1/16 (179.4) O. Gskt: G184-A, G211, G280, G362 End Seals: [1] Attached Grommets: [1] Attached</p>	<p>PT207-HD Heavy-Duty Hydraulic Element</p>  <p>Notes: Use in Gresen in-line housing. Fits: Allis Chalmers, Case, Caterpillar, John Deere, Massey Ferguson, New Holland, Oliver, Steiger, Versatile Equipment Replaces: Gresen 1509, 1567, 3143, 3144 O.D.: 4 1/2 (114.3) I.D.: 1 7/8 (47.6) Height: 6 31/32 (177.0) F. Gskt: [2] ES1092 O. Gskt: ES3029, G236-A, G385, G386 Related To: PT554, PT573 (Long Versions)</p>











Measurements Are Shown In Inches And (Millimeters)

WARNING: These products can expose you to chemicals, including Diisononyl Phthalate, Carbon black extracts, Nickel, 1,3 Butadiene, Ethylene Oxide, Epichlorohydrin, which are known to the State of California to cause cancer, and Bisphenol, Ethylene Glycol, Ethylene Oxide, 1,3 Butadiene, Epichlorohydrin, which are known to the State of California to cause birth defects or other reproductive harm. For more information go to www.P65Warnings.ca.gov.

<p>PT207-HD10</p> 	<p>Heavy-Duty Hydraulic Element Notes: Use in Gresen in-line housing. Fits: Allis Chalmers, Case, Caterpillar, John Deere, Massey Ferguson, New Holland, Oliver, Steiger, Versatile Equipment Replaces: Gresen 1509, 1567, 3143, 3144 O.D.: 4 1/2 (114.3) I.D.: 1 7/8 (47.6) Height: 6 31/32 (177.0) F. Gskt: [2] ES1092 O. Gskt: ES3029, G236-A, G385, G386 Related To: PT554, PT573 (Long Versions)</p>	<p>PT214(2)</p>  <p>Set of 2 Hydraulic Elements Fits: International Crawler, Wheel Tractors Replaces: International 375085-R91 O.D.: 2 7/8 (73.0) I.D.: 1 1/16 (27.0) Height: 1 17/32 (38.9) F. Gskt: [2] Included</p>
<p>PT208</p> 	<p>Hydraulic Reservoir Element Fits: Clark Lift Trucks Replaces: Clark 733289, 883687, 1810143 O.D.: 6 (152.4) I.D.: 3 1/2 (88.9) Height: 4 3/16 (106.4) O. Gskt: G314 End Seals: [2] Attached</p>	<p>BT215</p>  <p>Full-Flow Lube Spin-on Contains: Anti-Drainback Valve 8 PSID By-Pass Valve Standpipe Fits: Allis Chalmers, Compair, Eicher, Landini, Massey Ferguson Equipment; Perkins Engines Replaces: Perkins 2654408 Thread: 3/4 -16 O.D.: 3 (76.2) Height: 5 1/8 (130.2) I.Gskt: G449-B</p>
<p>PT210</p> 	<p>Hydraulic Element Fits: Minneapolis-Moline Equipment Replaces: White 10A23992, 10P1851 O.D.: 2 15/32 (62.7) I.D.: 1 1/16 (27.0) Height: 7 25/32 (197.6) F. Gskt: G274 End Seals: [2] Attached</p>	<p>BT216</p>  <p>Full-Flow Lube Spin-on Contains: Anti-Drainback Valve 8 PSID By-Pass Valve Standpipe Fits: Allis Chalmers, Bobcat, Caterpillar, Claas, J.C. Bamford, Landini, Massey Ferguson, New Holland, Vermeer, Volvo Equipment; Perkins Engines Replaces: Perkins 2654403 Thread: 3/4 -16 O.D.: 3 11/16 (93.7) Height: 5 3/8 (136.5) I.Gskt: G381-A Related To: BT237 (Long Version)</p>
<p>B211</p> 	<p>Full-Flow Lube Spin-on Contains: 20 PSID By-Pass Valve Fits: Hyster Lift Trucks Replaces: Hyster 360974 Thread: M20 x 1.5 O.D.: 4 1/4 (108.0) Height: 5 27/32 (148.4) I.Gskt: [1] Included</p>	<p>BT217</p>  <p>Full-Flow Lube Spin-on Notes: Can be used with OB40079 base. Contains: Anti-Drainback Valve 8 PSID By-Pass Valve Standpipe Fits: Hanomag, Hyster Equipment; Transicold Refrigeration Units Replaces: Transicold 3000323, 3000323-00 Thread: 3/4 -16 O.D.: 3 11/16 (93.7) Height: 7 1/8 (181.0) I.Gskt: G381-A</p>
<p>PT212-5</p> 	<p>Hydraulic Element Notes: Inside-Out Flow Direction Fits: Hough, International Wheel Loaders; Lorain Equipment Replaces: International 176028-H2 O.D.: 6 (152.4) I.D.: 2 5/8 (66.7) Height: 18 1/16 (458.8) End Seals: [2] Attached Related To: PT499-5 (Single-Length Version)</p>	<p>B218</p>  <p>Full-Flow Lube Spin-on Contains: Anti-Drainback Valve 30 PSID By-Pass Valve Fits: Agco, Liebherr, O & K, Poclain Equipment; Deutz Engines Replaces: Deutz 1173765 Thread: 1 1/8 -16 O.D.: 4 1/4 (108.0) Height: 10 7/16 (265.1) I.Gskt: [1] Included</p>
<p>PT213</p> 	<p>Hydraulic Element Fits: Atlas Copco, Compair Compressors; Volvo Equipment Replaces: Atlas Copco 1619-0355; Volvo 4786319 O.D.: 3 17/32 (89.7) I.D.: 2 1/32 (51.6) Height: 10 (254.0) F. Gskt: G202</p>	











Measurements Are Shown In Inches And (Millimeters)

WARNING: These products can expose you to chemicals, including Diisononyl Phthalate, Carbon black extracts, Nickel, 1,3 Butadiene, Ethylene Oxide, Epichlorohydrin, which are known to the State of California to cause cancer, and Bisphenol, Ethylene Glycol, Ethylene Oxide, 1,3 Butadiene, Epichlorohydrin, which are known to the State of California to cause birth defects or other reproductive harm. For more information go to www.P65Warnings.ca.gov.

<p>B220</p>  <p>Full-Flow Lube Spin-on Fits: Hitachi Equipment Replaces: Hitachi 4192527 Thread: 1 3/8 -16 O.D.: 4 21/32 (118.3) Height: 9 7/8 (250.8) I.Gskt: G498-A</p>	<p>PF226</p>  <p>Secondary Fuel Element Fits: Adams, Austin-Western, Galion, International, Link-Belt Equipment; International Engines, Equipment Replaces: International 266839-R91 O.D.: 3 15/32 (88.1) I.D.: 9/16 (14.3) & 1 (25.4) Height: 6 3/4 (171.5) O-Ring: [1] Attached O. Gskt: G241 Grommets: [1] Attached</p>
<p>BT221</p>  <p>Full-Flow Lube Spin-on Contains: 32 PSID By-Pass Valve Fits: Toyota Lift Trucks Replaces: Toyota 15601-68010 Thread: M30 x 1.5 O.D.: 4 1/4 (108.0) Height: 5 5/8 (142.9) I.Gskt: [1] Included</p>	<p>B227</p>  <p>Full-Flow Lube Spin-on Contains: Anti-Drainback Valve 20 PSID By-Pass Valve Fits: Chrysler, Ford, GMC, Honda, Isuzu, Mitsubishi Automotive; Kubota, Yanmar Engines Replaces: Kubota 15241-39092; Yanmar 1196-6035150 Thread: M20 x 1.5 O.D.: 3 (76.2) Height: 2 27/32 (72.2) I.Gskt: [1] Included</p>
<p>B222</p>  <p>By-Pass Lube Spin-on Fits: Isuzu Engines Replaces: Isuzu 8-94169-779-0, 8-94169-779-1, 8-94169-779-2 Thread: 5/8 -18 O.D.: 4 1/4 (108.0) Height: 3 3/16 (81.0) I.Gskt: [1] Included</p>	<p>B228</p>  <p>Full-Flow Lube Spin-on Contains: Anti-Drainback Valve 30 PSID By-Pass Valve Fits: Atlas Copco Compressors; Audi, BMW, GM Automotive; Bobcat, Claas, Gehl Equipment; Deutz Engines Replaces: Deutz 1163420; GMC 6696776 Thread: 3/4 -16 O.D.: 3 (76.2) Height: 3 1/2 (88.9) I.Gskt: G449-B Related To: B178 (Long Version)</p>
<p>BT223</p>  <p>Full-Flow Lube Spin-on Contains: Anti-Drainback Valve 8 PSID By-Pass Valve Fits: BMW, Chrysler, Dodge, GMC, Saab, Saturn, Suzuki, Toyota Automotive; Bobcat, Cub Cadet, Interceptor, John Deere Equipment Replaces: Chrysler 2647020; Lister 201-55370; Onan 122-0645; Toyota 15601-13051 Thread: 3/4 -16 O.D.: 2 29/32 (73.8) Height: 3 1/2 (88.9) A. Gskt: G449-B</p>	<p>B229</p>  <p>Full-Flow Lube Spin-on Contains: Anti-Drainback Valve 20 PSID By-Pass Valve Fits: Case Equipment; David Brown, Isuzu Engines; Toyota Automotive, Light-Duty Trucks Replaces: Case A46158; Isuzu X13201-001; Toyota 15601-44011 Thread: 3/4 -16 O.D.: 3 11/16 (93.7) Height: 4 3/8 (111.1) I.Gskt: G381-A</p>
<p>PF224</p>  <p>Fuel Element Fits: Ensign Carburetors; International Engines, Equipment Replaces: Ensign 6261B; International 64400-DC O.D.: 1 7/8 (47.6) I.D.: 23/32 (18.3) Height: 2 15/32 (62.7) F. Gskt: [2] Included O. Gskt: G204-A End Seals: [2] Attached</p>	<p>BT230</p>  <p>Full-Flow Lube Spin-on Fits: Ag-Chem, Caterpillar, Grove, Hitachi, New Holland, Takeuchi, White Equipment; Hino, International, Mack, Volvo Trucks Replaces: Caterpillar 8N9586 Thread: 1 1/8 -16 O.D.: 3 11/16 (93.7) Height: 5 3/8 (136.5) I.Gskt: G381-A Related To: BT260, BT260-10 (Transmission Versions)</p>
<p>PF225</p>  <p>Fuel Element Fits: Dresser, Galion, Hough Equipment; International Engines, Equipment, Trucks Replaces: International 266840-R91 O.D.: 4 7/32 (107.2) I.D.: 13/16 (20.6) & 1 (25.4) Height: 6 3/4 (171.5) O. Gskt: G104, G115-MSB, G240, G302 End Seals: [1] Attached</p>	

Measurements Are Shown In Inches And (Millimeters)

WARNING: These products can expose you to chemicals, including Diisononyl Phthalate, Carbon black extracts, Nickel, 1,3 Butadiene, Ethylene Oxide, Epichlorohydrin, which are known to the State of California to cause cancer, and Bisphenol, Ethylene Glycol, Ethylene Oxide, 1,3 Butadiene, Epichlorohydrin, which are known to the State of California to cause birth defects or other reproductive harm. For more information go to www.P65Warnings.ca.gov.

<p>PF231</p> 	<p>Fuel Element Fits: Deutz, International, Mercedes-Benz Engines; M.A.N., R.V.I. Buses, Trucks Replaces: Deutz R1H4155,-H; International 3029244-R91; Mercedes-Benz 4773515 O.D.: 2 7/8 (73.0) I.D.: 9/16 (14.3) Height: 5 27/32 (148.4) Grommets: [2] Attached</p>	<p>B236</p> 	<p>Full-Flow Lube or Hydraulic Spin-on Contains: Anti-Drainback Valve 30 PSID By-Pass Valve Fits: Atlas Copco Compressors; Bomag, Case, Caterpillar, Demag, Deutz, Drott, Fendt, John Deere, Liebherr Equipment; Deutz Engines Replaces: Case A44081; Deutz 1173430; John Deere AZ22878 Thread: 1 -12 O.D.: 3 11/16 (93.7) Height: 8 1/8 (206.4) I.Gskt: G381-A Related To: B7031 (Short Version)</p>
<p>BD232</p> 	<p>Dual-Flow Lube Spin-on Contains: 36 PSID By-Pass Valve Standpipe Fits: Allis Chalmers, Fiat Equipment; Iveco, R.V.I. Trucks Replaces: Fiat 1902076, 4787410, 5983900 Thread: 3/4 -16 O.D.: 4 1/4 (108.0) Height: 5 11/16 (144.5) I.Gskt: [1] Included</p>	<p>BT237</p> 	<p>Full-Flow Lube Spin-on Notes: Can be used with OB40079 base. Contains: Anti-Drainback Valve 8 PSID By-Pass Valve Standpipe Fits: Bobcat, Caterpillar, Hymac, Hyster, J.C. Bamford, Komatsu, Landini, Massey Ferguson Equipment; Perkins Engines Replaces: Perkins 2654407 Thread: 3/4 -16 O.D.: 3 11/16 (93.7) Height: 7 1/8 (181.0) I.Gskt: G381-A Related To: BT216 (Short Version)</p>
<p>B233</p> 	<p>Full-Flow Lube Spin-on Notes: Can be used with OB40079 base. Contains: Anti-Drainback Valve 8 PSID By-Pass Valve Fits: Chrysler, Ford, Toyota, Volkswagen Automotive, Light-Duty Trucks, Vans Replaces: Chrysler 3549957; Ford C5ZZ-6731-A Thread: 3/4 -16 O.D.: 3 11/16 (93.7) Height: 4 3/8 (111.1) A. Gskt: G381-A</p>	<p>BT238</p> 	<p>Full-Flow Lube Spin-on Contains: Anti-Drainback Valve 20 PSID By-Pass Valve Fits: Kubota, Thomas Equipment Replaces: Kubota 70000-15451 Thread: 3/4 -16 O.D.: 4 1/4 (108.0) Height: 7 11/32 (186.5) I.Gskt: G381-A</p>
<p>BT234</p> 	<p>Full-Flow Lube Spin-on Fits: Nissan Engines Replaces: Nissan 15274-99186, 15274-99626 Thread: 1 1/8 -16 O.D.: 4 9/32 (108.7) Height: 8 1/32 (204.0) I.Gskt: [1] Included</p>	<p>B239</p> 	<p>Full-Flow Lube Spin-on Contains: 30 PSID By-Pass Valve Fits: John Deere Equipment Replaces: John Deere AZ36942 Thread: 1 1/2 -16 O.D.: 5 3/8 (136.5) Height: 12 3/32 (307.2) I.Gskt: [1] Included</p>
<p>P235</p> 	<p>Full-Flow Lube Element Fits: DAF, Iveco, M.A.N., R.V.I, Volvo Trucks; Deutz Engines; Fiat Equipment Replaces: Deutz 1168446; Fiat 1909123 O.D.: 3 17/32 (89.7) I.D.: 1 5/16 (33.3) Height: 7 13/16 (198.4) F. Gskt: G202 End Seals: [2] Attached</p>	<p>P240</p> 	<p>Full-Flow Lube Element Fits: David Brown Equipment Replaces: Ford 105E-6731-A O.D.: 2 7/8 (73.0) I.D.: 27/32 (21.4) Height: 3 5/32 (80.2) F. Gskt: [1] Included</p>
	<p>BT241</p> 	<p>Full-Flow Lube Spin-on Contains: Anti-Drainback Valve 8 PSID By-Pass Valve Fits: Wisconsin Engines Replaces: Wisconsin RV51 Thread: 13/16 -16 O.D.: 3 13/16 (96.8) Height: 4 3/8 (111.1) I.Gskt: [1] Included</p>	

Measurements Are Shown In Inches And (Millimeters)

WARNING: These products can expose you to chemicals, including Diisononyl Phthalate, Carbon black extracts, Nickel, 1,3 Butadiene, Ethylene Oxide, Epichlorohydrin, which are known to the State of California to cause cancer, and Bisphenol, Ethylene Glycol, Ethylene Oxide, 1,3 Butadiene, Epichlorohydrin, which are known to the State of California to cause birth defects or other reproductive harm. For more information go to www.P65Warnings.ca.gov.

P242 Full-Flow Lube Element
Contains: Reinforced Centertube
Fits: Mercedes-Benz Engines, Equipment
Replaces: Mercedes-Benz 4011800009
O.D.: 4 25/32 (121.4)
I.D.: 17/32 (13.5) & 2 5/32 (54.8)
Height: 7 13/32 (188.1)
F. Gskt: [3] Washers
O-Ring: [1] Included
Spring: [1] Attached



P249 Full-Flow Lube Element
Fits: Caterpillar, Kobelco Equipment; Mitsubishi Engines
Replaces: Mitsubishi ME034611
O.D.: 4 11/32 (110.3)
I.D.: 3/4 (19.0)
Height: 7 5/8 (193.7)
A. Gskt: [1] Attached
F. Gskt: [1] Included
O-Ring: [1] Included
Grommets: [2] Attached



B243 Full-Flow Lube Spin-on
Contains: Anti-Drainback Valve
 8 PSID By-Pass Valve
Fits: Chrysler, Ford, Mazda, Toyota, Volkswagen Automotive, Light-Duty Trucks, Vans; Ford, Gehl, Kubota Equipment; Kohler, Onan Engines
Replaces: Ford E4FZ-6731-AB; Kohler 277233; Onan 122-0680
Thread: 3/4 -16
O.D.: 3 (76.2)
Height: 4 27/32 (123.0)
A. Gskt: G449-B



BT251 Full-Flow Lube Spin-on
Notes: Can be used with OB40079 base.
Contains: Anti-Drainback Valve
 8 PSID By-Pass Valve
Fits: Ford, Oliver Tractors
Replaces: Ford D2NN-6714-C
Thread: 3/4 -16
O.D.: 3 11/16 (93.7)
Height: 7 1/8 (181.0)
I.Gskt: G381-A



B244 Full-Flow Lube Spin-on
Contains: Anti-Drainback Valve
 20 PSID By-Pass Valve
Fits: GMC, Isuzu Engines, Trucks
Replaces: GMC 94169778; Isuzu 8-94169-778-0, 8-94169-778-1, 8-94169-778-2
Thread: 3/4 -16
O.D.: 3 11/16 (93.7)
Height: 5 3/8 (136.5)
I.Gskt: G324-A



B252 Transmission Spin-on
Contains: Anti-Drainback Valve
 20 PSID By-Pass Valve
Fits: Allison Transmissions
Replaces: GMC 25010441
Thread: 3/4 -16
O.D.: 3 11/16 (93.7)
Height: 5 15/32 (138.9)
I.Gskt: G401



B246 Lube Spin-on
Contains: Anti-Drainback Valve
Replaces: Nissan 15208-W3401
Thread: 3/4 -16
O.D.: 3 3/4 (95.3)
Height: 5 9/32 (134.1)
I.Gskt: G381-A



B253 Full-Flow Heavy-Duty Lube Spin-on
Notes: Can be used with OB40079 base. Can be used in racing applications.
Contains: Anti-Drainback Valve
 20 PSID By-Pass Valve
 Standpipe
Fits: Ferrari, Porsche Automotive
Replaces: Ferrari 45384000; Lancia 2220425; Porsche 901-107-203-02
Thread: 3/4 -16
O.D.: 3 11/16 (93.7)
Height: 5 15/32 (138.9)
I.Gskt: G401



B247 Full-Flow Lube Spin-on
Contains: Anti-Drainback Valve
 8 PSID By-Pass Valve
Fits: Komatsu Equipment; Thermo King Refrigeration Units
Replaces: Thermo King 11-5522
Thread: M20 x 1.5
O.D.: 3 (76.2)
Height: 4 13/16 (122.2)
I.Gskt: [1] Included



B255 Full-Flow Lube Spin-on
Fits: Sullair Compressors
Replaces: Sullair 408107
Thread: 1 -12
O.D.: 3 11/16 (93.7)
Height: 5 15/32 (138.9)
I.Gskt: G401



BT248 Full-Flow Lube Spin-on
Contains: Anti-Drainback Valve
 8 PSID By-Pass Valve
Fits: New Holland Equipment; Wisconsin Engines
Replaces: Wisconsin RV38-S
Thread: 5/8 -18
O.D.: 3 11/16 (93.7)
Height: 5 13/32 (137.3)
I.Gskt: G381-A



PT256 Hydraulic Element
Contains: Reinforced Centertube
Fits: Army-Navy Hydraulic Systems
Replaces: Army-Navy AN6235-2A; Bendix 572760
O.D.: 1 5/32 (29.4)
I.D.: 5/8 (15.9) One End
Height: 4 11/16 (119.1)
O-Ring: [1] Attached



Measurements Are Shown In Inches And (Millimeters)

WARNING: These products can expose you to chemicals, including Diisononyl Phthalate, Carbon black extracts, Nickel, 1,3 Butadiene, Ethylene Oxide, Epichlorohydrin, which are known to the State of California to cause cancer, and Bisphenol, Ethylene Glycol, Ethylene Oxide, 1,3 Butadiene, Epichlorohydrin, which are known to the State of California to cause birth defects or other reproductive harm. For more information go to www.P65Warnings.ca.gov.

PT257 Hydraulic Element
Contains: Reinforced Centertube
Fits: Caterpillar Excavators; Army-Navy Hydraulic Systems
Replaces: Army-Navy AN6235-3A; Vickers 62343
O.D.: 1 21/32 (42.1)
I.D.: 7/8 (22.2) One End
Height: 3 1/2 (88.9)
O-Ring: [1] Attached



B262 Full-Flow Lube Spin-on
Contains: 30 PSID By-Pass Valve
Fits: Atlas Copco Compressors; Gardner Denver Drills; Yanmar Engines
Replaces: Atlas Copco 1619-3771
Thread: 1 -12
O.D.: 3 11/16 (93.7)
Height: 8 23/32 (221.5)
I.Gskt: G381-A



PT258 Hydraulic Element
Contains: Reinforced Centertube
Fits: Army-Navy Hydraulic Systems; International Combines; Massey Ferguson Tractors; Vickers Optional Filter Housings
Replaces: Army-Navy AN6235-4A; Bendix 572759; International 573201-R91
O.D.: 1 25/32 (45.2)
I.D.: 1 (25.4) One End
Height: 4 1/2 (114.3)
O-Ring: [1] Attached



B263 Full-Flow Lube Spin-on
Fits: Mercedes-Benz Engines
Replaces: Mercedes-Benz 31841701
Thread: 1 -12
O.D.: 4 1/4 (108.0)
Height: 9 1/8 (231.8)
I.Gskt: G401



BT259 Full-Flow Lube or Hydraulic Spin-on
Contains: 20 PSID By-Pass Valve
Fits: Blaw Knox, Caterpillar, Ditch Witch, Dynapac, John Deere, Rayco, Vermeer, Zetor Equipment; Ingersoll-Rand Compressors
Replaces: John Deere AR58956, T19044
Thread: 13/16 -16
O.D.: 3 11/16 (93.7)
Height: 5 13/32 (137.3)
I.Gskt: G401



BT264 Full-Flow Lube Spin-on
Contains: Anti-Drainback Valve
 8 PSID By-Pass Valve
Fits: Caterpillar Engines, Equipment
Replaces: Caterpillar 2S5262, 2S9969
Thread: 7/8 -14
O.D.: 3 11/16 (93.7)
Height: 4 3/8 (111.1)
I.Gskt: G381-A
Related To: BT126 (Long Version)



BT260 Hydraulic or Transmission Spin-on
Fits: Cessna Hydraulic Systems; International, John Deere, New Holland, Yale & Towne Equipment
Replaces: Cessna 60187-6
Thread: 1 1/8 -16
O.D.: 3 11/16 (93.7)
Height: 5 3/8 (136.5)
I.Gskt: G381-A
Related To: BT230 (Lube Version)



PT265 Transmission Element
Fits: Allis Chalmers, Fiat-Allis Equipment
Replaces: Allis Chalmers 631828, 4995265
O.D.: 3 (76.2)
I.D.: 1 1/16 (27.0)
Height: 7 23/32 (196.1)
F. Gskt: ES1030, G270, [1] Included
O. Gskt: G133
End Seals: [2] Attached

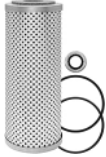

BT260-10 Hydraulic or Transmission Spin-on
Fits: Cessna Hydraulic Systems; Bobcat, Case, Ford, John Deere, Kobelco, Massey Ferguson, New Holland Equipment
Replaces: Cessna 60187-6
Thread: 1 1/8 -16
O.D.: 3 11/16 (93.7)
Height: 5 3/8 (136.5)
I.Gskt: G381-A
Related To: BT230 (Lube Version)



P266 Full-Flow Lube Element
Fits: Isuzu Engines; Kobelco, Koehring, Multiquip Equipment
Replaces: Isuzu 9-88513-106-1
O.D.: 3 9/32 (83.3)
I.D.: 23/32 (18.3) & 1 5/8 (41.3)
Height: 5 11/16 (144.5)
F. Gskt: [4] Included
End Seals: [1] Attached
Grommets: [1] Attached



BT261 Full-Flow Lube Spin-on
Contains: Anti-Drainback Valve Standpipe
Fits: Case, Dresser, Drott, Galion, Hough, International, John Deere Equipment
Replaces: Case A58672, A75294
Thread: 1 -12
O.D.: 3 11/16 (93.7)
Height: 7 1/8 (181.0)
I.Gskt: G381-A
Related To: B299 (High Performance Version)















BT267 Full-Flow Lube Spin-on
Contains: Anti-Drainback Valve
 20 PSID By-Pass Valve
Fits: Allis Chalmers, Fiat-Allis, Ford, Hanomag, Iveco Equipment
Replaces: Allis Chalmers 2089505; Ford D5NN-6714-A
Thread: 3/4 -16
O.D.: 4 1/4 (108.0)
Height: 5 13/16 (147.6)
I.Gskt: G381-A



Measurements Are Shown In Inches And (Millimeters)

WARNING: These products can expose you to chemicals, including Diisononyl Phthalate, Carbon black extracts, Nickel, 1,3 Butadiene, Ethylene Oxide, Epichlorohydrin, which are known to the State of California to cause cancer, and Bisphenol, Ethylene Glycol, Ethylene Oxide, 1,3 Butadiene, Epichlorohydrin, which are known to the State of California to cause birth defects or other reproductive harm. For more information go to www.P65Warnings.ca.gov.

<p>PT268</p>  <p>Hydraulic Element Fits: Case, Dresser, International Equipment Replaces: International 390560-R91, 528507-R91 O.D.: 5 (127.0) I.D.: 2 13/16 (71.4) Height: 6 1/8 (155.6) F. Gskt: G261, G307, G360, G368 O. Gskt: G260, G362, G382 End Seals: [2] Attached</p>	<p>PT275-10</p>  <p>Transmission Element Contains: Reinforced Centertube Fits: Dresser, International, Racine Equipment Replaces: Eaton 493144 O.D.: 4 17/32 (115.1) I.D.: 1/2 (12.7) & 2 9/32 (57.9) Height: 9 1/16 (230.2) O. Gskt: G211 End Seals: [1] Attached Grommets: [1] Attached</p>
<p>PT269</p>  <p>Full-Flow Lube Element Fits: Deutz, Hyster Equipment Replaces: Deutz 150154012; Hyster 136853 O.D.: 3 5/16 (84.1) I.D.: 15/16 (23.8) Height: 4 5/8 (117.5)</p>	<p>P276</p>  <p>Full-Flow Lube Element Fits: Ag-Chem Fertilizer Applicators, Sprayers; International Buses, Engines, Trucks Replaces: International 244572-R92, 313117-C92 O.D.: 4 1/2 (114.3) I.D.: 1 1/16 (27.0) Height: 6 5/8 (168.3) Grommets: [2] Attached</p>
<p>P271</p>  <p>Full-Flow Lube Element Fits: OMC Engines Replaces: Ford 113E-6731-A O.D.: 2 7/8 (73.0) I.D.: 27/32 (21.4) Height: 4 3/16 (106.4) F. Gskt: [1] Included</p>	<p>PT277</p>  <p>Hydraulic Element Notes: Inside-Out Flow Direction Fits: Massey Ferguson Equipment Replaces: Massey Ferguson 228529-M1; Timberjack 101465 O.D.: 3 15/16 (100.0) I.D.: 2 (50.8) Height: 7 1/2 (190.5)</p>
<p>PT273</p>  <p>Hydraulic Element Replaces: Allis Chalmers 631827 O.D.: 2 7/8 (73.0) I.D.: 1 1/16 (27.0) Height: 4 15/16 (125.4) F. Gskt: [1] Included, [1] Metal Washer O-Ring: [1] Included End Seals: [2] Attached</p>	<p>B279</p>  <p>Full-Flow Lube Spin-on Notes: Can be used in racing applications. Contains: Anti-Drainback Valve 20 PSID By-Pass Valve Fits: Mercruiser Marine Replaces: GM 6438868 Thread: 13/16 -16 O.D.: 3 11/16 (93.7) Height: 5 11/32 (135.7) I.Gskt: [1] Included</p>
<p>BT274</p>  <p>Hydraulic Spin-on Contains: 10 PSID By-Pass Valve Fits: Case, International, Wayne Equipment Replaces: Case A32297 Thread: 1 -12 O.D.: 3 11/16 (93.7) Height: 5 3/8 (136.5) I.Gskt: G381-A</p>	<p>P280</p>  <p>Full-Flow Lube Element Fits: Isuzu Engines; John Deere Loaders Replaces: Isuzu 9-88513-107-01; John Deere GV10805 O.D.: 2 7/8 (73.0) I.D.: 1 5/16 (33.3) Height: 5 15/32 (138.9) F. Gskt: [3] Included End Seals: [2] Attached</p>
<p>PT275</p>  <p>Transmission Element Contains: Reinforced Centertube Fits: FWD, Racine, Wagner, Yale & Towne Equipment Replaces: Racine 493144 O.D.: 4 17/32 (115.1) I.D.: 1/2 (12.7) & 2 9/32 (57.9) Height: 9 1/16 (230.2) O. Gskt: G211 End Seals: [1] Attached Grommets: [1] Attached</p>	<p>B281</p>  <p>Full-Flow Lube Spin-on Contains: Anti-Drainback Valve 20 PSID By-Pass Valve Fits: Komatsu, New Holland Equipment; Onan Generators; VM Engines Replaces: Onan 122-0550; VM Engines 4115030 Thread: M22 x 1.5 O.D.: 3 11/16 (93.7) Height: 5 3/8 (136.5) I.Gskt: G381-A</p>

Measurements Are Shown In Inches And (Millimeters)

WARNING: These products can expose you to chemicals, including Diisononyl Phthalate, Carbon black extracts, Nickel, 1,3 Butadiene, Ethylene Oxide, Epichlorohydrin, which are known to the State of California to cause cancer, and Bisphenol, Ethylene Glycol, Ethylene Oxide, 1,3 Butadiene, Epichlorohydrin, which are known to the State of California to cause birth defects or other reproductive harm. For more information go to www.P65Warnings.ca.gov.

PT283



Hydraulic Element

Fits: Barber-Greene Loaders with International Engines
Replaces: Bendix 47197
O.D.: 1 1/16 (27.0)
I.D.: 5/8 (15.9)
Height: 3 5/32 (80.2)

PT284



Hydraulic Element

Fits: Barber-Greene Loaders with International Engines
Replaces: Bendix 47198
O.D.: 1 3/8 (34.9)
I.D.: 7/8 (22.2)
Height: 4 1/32 (102.4)

PT285



Hydraulic Element

Fits: International Equipment
Replaces: International 613788-C91
O.D.: 5 (127.0)
I.D.: 2 13/16 (71.4)
Height: 11 1/16 (281.0)

BT287



Full-Flow Lube or Hydraulic Spin-on

Notes: CAUTION: Use G372 (yellow striped) gasket ONLY on Case and G369-B (blue striped) gasket on John Deere. Installing wrong gasket prevents seal. Use with OB1313, OB1314, OB1315, OB1316 bases (requires optional G286-C gasket).
Fits: Ag-Chem, Bobcat, Case, Demag, Hydra-Mac, Hyster, John Deere, Manitowoc, Michigan Fluid Power, Steiger Equipment
Replaces: Bobcat 6552507, Case A57857; Demag 25577440; Hydra-Mac 3401-307; John Deere AR43261, AR43634
Thread: 1 1/2 -16
O.D.: 5 1/32 (127.8)
Height: 7 (177.8)
F. Gskt: G369-B (Blue Striped), G372 (Yellow Striped)
O. Gskt: G286-C, G369-V, G447, G483, G704, G710

BT287-10



Hydraulic Spin-on

Notes: CAUTION: Use furnished G369-B (blue striped) gasket on John Deere. Use optional G372 (yellow striped) gasket ONLY on Case. Installing wrong gasket prevents seal. Can use with OB1313, OB1314, OB1315, OB1316 bases (requires opt. G286-C gasket)
Contains: Square-Cut Gasket
Fits: Case, Case-International, Caterpillar, Champion, Ditch Witch, Dynamic Industries, Ford, Gehl, Hesston, John Deere, Manitou, Michigan Fluid Power, New Holland, Steiger Equipment
Replaces: Case 87027972; Caterpillar 9T5664; Champion 13028; Ditch Witch 155-954; Dynamic 1H1234; John Deere AT58368; Michigan Fluid Power 200-0600; New Holland 86542664
Thread: 1 1/2 -16
O.D.: 5 1/32 (127.8)
Height: 7 (177.8)
F. Gskt: G369-B (Blue Striped)
O. Gskt: G286-C, G369-V, G372, G447, G483, G704, G710

BT287-3



High Efficiency Hydraulic Spin-on

Notes: Can be used with OB1313, OB1314, OB1315, OB1316 bases (requires optional G286-C gasket).
Fits: Agco Combines
Replaces: Gresen K23020; Zinga SE3
Thread: 1 1/2 -16
O.D.: 5 1/16 (128.6)
Height: 7 (177.8)
F. Gskt: G369-B (Blue Striped)
O. Gskt: G286-C, G369-V, G372, G447, G483, G704, G710

PT288-HD



Hydraulic Element

Fits: Case Loaders, Optional Equipment; Link-Belt Backhoes
Replaces: Case D35995; Ford D3NN-F882-A; John Deere AT45811; Link-Belt 20P14
O.D.: 4 1/2 (114.3)
I.D.: 2 7/32 (56.4)
Height: 7 7/16 (188.9)
I.Gskt: [2] Included
O. Gskt: G307, G397
Related To: PT550-10 (Double-Length Version)

PT288-HD10



Hydraulic Element

Fits: Ford Loaders; John Deere Equipment
Replaces: Case D35995; Ford D3NN-F882-A; John Deere AT45811; Link-Belt 20P14
O.D.: 4 1/2 (114.3)
I.D.: 2 7/32 (56.4)
Height: 7 7/16 (188.9)
I.Gskt: [2] Included
O. Gskt: G307, G397
Related To: PT550-10 (Double-Length Version)

Measurements Are Shown In Inches And (Millimeters)

WARNING: These products can expose you to chemicals, including Diisononyl Phthalate, Carbon black extracts, Nickel, 1,3 Butadiene, Ethylene Oxide, Epichlorohydrin, which are known to the State of California to cause cancer, and Bisphenol, Ethylene Glycol, Ethylene Oxide, 1,3 Butadiene, Epichlorohydrin, which are known to the State of California to cause birth defects or other reproductive harm. For more information go to www.P65Warnings.ca.gov.

PT289 Hydraulic Element
Fits: Austin-Western, Case Equipment
Replaces: Case D43567, D75831
O.D.: 2 5/8 (66.7)
I.D.: 1 1/4 (31.8) One End
Height: 7 5/16 (185.7)
I.Gskt: [1] Included
F. Gskt: G247



B295 Full-Flow Lube Spin-on
Contains: Anti-Drainback Valve
Fits: Mercedes-Benz, Nissan, Toyota Automotive; Ford, Hitachi, International Equipment; Komatsu, Nissan Lift Trucks
Replaces: GMC 25011623; Nissan 15209-J1800; Toyota 15601-22010
Thread: 3/4 -16
O.D.: 3 1/32 (77.0)
Height: 5 27/32 (148.4)
I.Gskt: [1] Included
Related To: B143 (Short Version)



PT289-10 Hydraulic Element
Fits: Agco, Franklin Equipment
Replaces: Franklin 1503007
O.D.: 2 5/8 (66.7)
I.D.: 1 1/4 (31.8) One End
Height: 7 5/16 (185.7)
I.Gskt: [1] Included
F. Gskt: G247



B296 By-Pass Lube Spin-on
Contains: Flow Control Orifice
Fits: Clark Lift Trucks; Ingersoll-Rand Compressors
Replaces: Clark 906540
Thread: 5/8 -18
O.D.: 3 11/16 (93.7)
Height: 3 7/8 (98.4)
I.Gskt: G381-A



PT290 Hydraulic Element
Fits: Allis Chalmers Equipment
Replaces: Marvel 5602065125
O.D.: 2 5/8 (66.7)
I.D.: 1 1/4 (31.8) One End
Height: 7 5/16 (185.7)
F. Gskt: G247
O-Ring: [1] Attached



PT298-10 Transmission Element
Fits: Gomaco Paving Equipment
Replaces: Marvel 676366-7110
O.D.: 4 1/2 (114.3)
I.D.: 2 1/4 (57.2)
Height: 7 3/8 (187.3)
I.Gskt: [2] Included



BT292 Full-Flow Lube Spin-on
Contains: Anti-Drainback Valve
 30 PSID By-Pass Valve
Fits: Atlas Copco Compressors; Blaw-Knox, Bomag, Caterpillar, Claas, Demag, Deutz, Ditch Witch, Dynapac, Fendt, Hanomag, Komatsu, Liebherr, New Holland, Nissan, Poclain, Vermeer Equipment
Replaces: Atlas Copco 9712540103; Deutz 150157510
Thread: 1 -12
O.D.: 3 11/16 (93.7)
Height: 5 3/8 (136.5)
I.Gskt: G381-A



B299 High Performance Full-Flow Lube Spin-on
Contains: Anti-Drainback Valve
 Standpipe
Fits: Case, International Equipment
Replaces: International 1808896-C1
Thread: 1 -12
O.D.: 3 11/16 (93.7)
Height: 7 5/32 (181.8)
I.Gskt: G401
Related To: BT261 (Standard Version)



P294 Full-Flow Lube Element
Contains: Reinforced Centertube
Fits: M.A.N., Mercedes-Benz, R.V.I. Buses, Engines, Trucks
Replaces: Mercedes-Benz 4031840025
O.D.: 4 25/32 (121.4)
I.D.: 17/32 (13.5) & 2 5/32 (54.8)
Height: 10 13/32 (264.3)
F. Gskt: [3] Metal Washers
O-Ring: [1] Included
End Seals: [1] Attached
Grommets: [2] Attached















T300-M Vac-Cel By-Pass Lube Spin-on with Mason Jar Screw Neck
Fits: Allis Chalmers, Case, Clark, Hyster, Kohler, Massey Ferguson, New Holland, Oliver Equipment
Replaces: Allis Chalmers 70240912; Case A36136; Clark 872790; Hyster 28714; Kohler 270197; Massey Ferguson 835652-M91; White TO11663
Thread: 2 3/4 -4
O.D.: 3 17/32 (89.7)
Height: 4 27/32 (123.0)
F. Gskt: [1] Included



Measurements Are Shown In Inches And (Millimeters)

WARNING: These products can expose you to chemicals, including Diisononyl Phthalate, Carbon black extracts, Nickel, 1,3 Butadiene, Ethylene Oxide, Epichlorohydrin, which are known to the State of California to cause cancer, and Bisphenol, Ethylene Glycol, Ethylene Oxide, 1,3 Butadiene, Epichlorohydrin, which are known to the State of California to cause birth defects or other reproductive harm. For more information go to www.P65Warnings.ca.gov.

<p>301</p> 	<p>DAHL Fuel Element Notes: 4 Micron Absolute Fits: DAHL 300 Series Fuel Filter/Water Separator Units O.D.: 6 1/16 (154.0) I.D.: 1 15/32 (37.3) & 3 1/4 (82.6) Height: 9 11/16 (246.1) A. Gskt: [1] Included F. Gskt: 200-15A O-Ring: [1] Attached</p>	<p>PT302</p> 	<p>By-Pass Lube Spin-on with Mason Jar Screw Neck Fits: Oliver, White Equipment Replaces: Oliver 100126ASA; White 1LA5507 Thread: 2 3/4 -4 O.D.: 3 7/8 (98.4) Height: 6 3/8 (161.9) F. Gskt: [1] Included</p>
<p>301-30</p> 	<p>DAHL Fuel Element Notes: 9 Micron Nominal (40 Absolute) Fits: DAHL 300 Series Fuel Filter/Water Separator Units O.D.: 6 1/16 (154.0) I.D.: 1 15/32 (37.3) & 3 1/4 (82.6) Height: 9 11/16 (246.1) A. Gskt: [1] Included F. Gskt: 200-15A O-Ring: [1] Attached</p>	<p>T303-M</p> 	<p>Vac-Cel By-Pass Lube Spin-on with Mason Jar Screw Neck Fits: Allis Chalmers Engines; Joy Compressors; Oliver Equipment Replaces: Allis Chalmers 8009129; Joy 202317; Oliver 100929ASA Thread: 2 3/4 -4 O.D.: 3 7/8 (98.4) Height: 6 13/32 (162.7) F. Gskt: [1] Included</p>
<p>301-CS</p> 	<p>DAHL Fuel Element with Water Absorbing Media Contains: Water Absorbent Media Fits: DAHL 300 Series Fuel Filter/Water Separator Units O.D.: 6 1/16 (154.0) I.D.: 1 15/32 (37.3) & 3 1/4 (82.6) Height: 9 11/16 (246.1) A. Gskt: [1] Included F. Gskt: 200-15A O-Ring: [1] Attached</p>	<p>PT304</p> 	<p>By-Pass Lube Spin-on with Mason Jar Screw Neck Fits: Kohler, Link-Belt, Oliver Equipment; Waukesha Engines Replaces: Oliver 250046, 100125ASA; Waukesha 119390A, K5507 Thread: 2 3/4 -4 O.D.: 3 7/8 (98.4) Height: 7 5/8 (193.7) F. Gskt: [1] Included</p>
<p>301-MPG</p> 	<p>Maximum Performance Glass DAHL Fuel Element Fits: DAHL 300 Series Fuel Filter/Water Separator Units O.D.: 6 1/16 (154.0) I.D.: 1 15/32 (37.3) & 3 1/4 (82.6) Height: 9 11/16 (246.1) A. Gskt: [1] Included F. Gskt: 200-15A O-Ring: [1] Attached</p>	<p>BT305</p> 	<p>Hydraulic Spin-on Fits: Caterpillar Equipment Replaces: Caterpillar 93-7521 Thread: 1 1/8 -16 O.D.: 3 11/16 (93.7) Height: 7 1/8 (181.0) A. Gskt: G381-A</p>
<p>301-W</p> 	<p>DAHL Fuel Element Notes: 3 Micron Nominal (9 Absolute) Fits: DAHL 300 Series Fuel Filter/Water Separator Units O.D.: 6 1/16 (154.0) I.D.: 1 15/32 (37.3) & 3 1/4 (82.6) Height: 9 11/16 (246.1) A. Gskt: [1] Included F. Gskt: 200-15A O-Ring: [1] Attached</p>	<p>B307</p> 	<p>Full-Flow Lube or Hydraulic Spin-on Contains: Anti-Drainback Valve 8 PSID By-Pass Valve Fits: R.V.I. Trucks Replaces: Renault 5000791145 Thread: M20 x 1.5 O.D.: 3 (76.2) Height: 2 7/8 (73.0) I.Gskt: G449-B</p>
<p>B301</p> 	<p>Lube Spin-on Contains: 8 PSID By-Pass Valve Fits: Subaru Automotive Replaces: Subaru 15208-AA021 Thread: M20 x 1.5 O.D.: 3 (76.2) Height: 2 27/32 (72.2) I.Gskt: [1] Included</p>	<p>T308-M</p> 	<p>Vac-Cel By-Pass Lube Spin-on with Mason Jar Screw Neck Fits: Bobcat, Case, Ditch Witch, Gehl, John Deere, New Holland, Vermeer Equipment; Wisconsin Engines Replaces: Wisconsin RV40 Thread: 2 3/4 -5 1/2 O.D.: 3 17/32 (89.7) Height: 4 27/32 (123.0) F. Gskt: [1] Included</p>

Measurements Are Shown In Inches And (Millimeters)

WARNING: These products can expose you to chemicals, including Diisononyl Phthalate, Carbon black extracts, Nickel, 1,3 Butadiene, Ethylene Oxide, Epichlorohydrin, which are known to the State of California to cause cancer, and Bisphenol, Ethylene Glycol, Ethylene Oxide, 1,3 Butadiene, Epichlorohydrin, which are known to the State of California to cause birth defects or other reproductive harm. For more information go to www.P65Warnings.ca.gov.

B309 High Performance Full-Flow Lube Spin-on
Fits: Case, International Equipment
Replaces: International 1811953-C1
Thread: 1 -12
O.D.: 4 1/4 (108.0)
Height: 7 3/8 (187.3)
I.Gskt: G401



PF316 Fuel/Water Separator Element with Bail Handle
Fits: Caterpillar, Cummins, Detroit Diesel, M.A.N. Engines; Grove Cranes
Replaces: Caterpillar 8N0205; Cummins 256559
O.D.: 5 27/32 (148.4)
I.D.: 31/32 (24.6)
Height: 8 3/4 (222.3)
A. Gskt: [1] Attached
F. Gskt: ES1036
O-Ring: [1] Included
Grommets: [2] Attached



BT310 Full-Flow Lube Spin-on
Contains: Anti-Drainback Valve
2 PSID By-Pass Valve
Fits: Yale Equipment
Replaces: Yale 1500176-00
Thread: M20 x 1.5
O.D.: 3 (76.2)
Height: 3 17/32 (89.7)
I.Gskt: G449-B



PT317-MPG Maximum Performance Glass Hydraulic Element
Fits: Allison Transmissions
Replaces: GMC 23018850
O.D.: 3 3/32 (78.6)
I.D.: 1 11/16 (42.9) One End
Height: 12 7/8 (327.0)
O-Ring: [1] Attached



PF311 Fuel Element
Fits: Daewoo, Hitachi Equipment; Hino, Isuzu Trucks; Kawasaki Loaders
Replaces: Isuzu 9-88511-191-1
O.D.: 2 7/8 (73.0)
I.D.: 9/16 (14.3)
Height: 4 11/32 (110.3)
F. Gskt: ES1036, [2] Included
Grommets: [2] Attached



PT318-MPG Maximum Performance Glass Hydraulic Element
Fits: Allison Transmissions
Replaces: GMC 23018851
O.D.: 3 3/32 (78.6)
I.D.: 1 11/16 (42.9) One End
Height: 12 7/8 (327.0)
O-Ring: [1] Attached



PF312 Primary Fuel Element
Fits: Allis Chalmers, Fiat-Allis, New Holland Equipment; Iveco Trucks
Replaces: Allis Chalmers 4964323; Fiat 1902096; Iveco 1902096
O.D.: 3 23/32 (94.5)
I.D.: 1/2 (12.7) & 1 1/32 (26.2)
Height: 7 17/32 (191.3)
F. Gskt: G480
End Seals: [1] Attached
Grommets: [1] Attached



PT319-MPG Maximum Performance Glass Hydraulic Element
Fits: Allison Transmissions
Replaces: GMC 23018852
O.D.: 3 25/32 (96.0)
I.D.: 2 3/16 (55.6) One End
Height: 16 13/16 (427.0)



PF313 Fuel Element
Fits: Isuzu Engines, Trucks
Replaces: Isuzu 5-87810-050-0
O.D.: 2 7/8 (73.0)
I.D.: 9/16 (14.3)
Height: 3 5/16 (84.1)
F. Gskt: [1] Included
Grommets: [2] Attached



PT320-MPG Maximum Performance Glass Hydraulic Element
Fits: Allison Transmissions
Replaces: GMC 23018853
O.D.: 3 25/32 (96.0)
I.D.: 2 3/16 (55.6) One End
Height: 16 13/16 (427.0)
O-Ring: [1] Attached















PF314 Fuel Element
Fits: Ford Light-Duty Trucks, Vans
Replaces: Ford E6TZ-9365-A
O.D.: 2 3/4 (69.9)
I.D.: 9/16 (14.3) One End
Height: 1 1/2 (38.1)
F. Gskt: [1] Included
Grommets: [1] Attached



Measurements Are Shown In Inches And (Millimeters)

WARNING: These products can expose you to chemicals, including Diisononyl Phthalate, Carbon black extracts, Nickel, 1,3 Butadiene, Ethylene Oxide, Epichlorohydrin, which are known to the State of California to cause cancer, and Bisphenol, Ethylene Glycol, Ethylene Oxide, 1,3 Butadiene, Epichlorohydrin, which are known to the State of California to cause birth defects or other reproductive harm. For more information go to www.P65Warnings.ca.gov.

<p>BD324</p> 	<p>Dual-Flow Lube Spin-on Fits: Agco, Case, Fiat-Allis, Grove, Ingersoll-Rand, Komatsu, Link-Belt Equipment Replaces: Case J919562 Thread: 2 1/4 -12 O.D.: 4 21/32 (118.3) Height: 9 5/8 (244.5) I.Gskt: G293-B Related To: BD103 (Long Version)</p>	<p>B333</p> 	<p>Full-Flow Lube Spin-on Fits: Engines originally equipped with the BD103, which have since added an optional remote mount by-pass filter such as the Baldwin B7577 or BC110 centrifuge filter. Thread: 2 1/4 -12 O.D.: 4 21/32 (118.3) Height: 11 13/32 (289.7) I.Gskt: G293-B</p>
<p>BD325</p> 	<p>Dual-Flow Lube Spin-on Contains: 35 PSID By-Pass Valve Fits: Allis Chalmers, Fiat-Allis, New Holland Equipment; Iveco Buses, Trucks Replaces: Iveco 1903715 Thread: M30 x 2.0 O.D.: 4 1/4 (108.0) Height: 8 7/16 (214.3) I.Gskt: [1] Included</p>	<p>BT334</p> 	<p>Hydraulic or Lube Spin-on Fits: Case, Hyundai, J.C. Bamford, Link-Belt, Volvo Equipment Replaces: Link-Belt KNJ0288 Thread: 1 1/8 -16 O.D.: 3 11/16 (93.7) Height: 5 3/8 (136.5) I.Gskt: G381-A</p>
<p>B326</p> 	<p>Lube Spin-on Contains: Anti-Drainback Valve Fits: Volvo Loaders Replaces: Volvo 4804406-9 Thread: 7/8 -16 O.D.: 4 1/4 (108.0) Height: 7 3/8 (187.3) I.Gskt: G401</p>	<p>B336</p> 	<p>Lube Spin-on Contains: Anti-Drainback Valve 14 PSID By-Pass Valve Standpipe Fits: Ford, New Holland, Versatile Tractors; Timberjack Equipment Replaces: Ford E8NN-6714-BA Thread: 3/4 -16 O.D.: 3 11/16 (93.7) Height: 5 3/8 (136.5) I.Gskt: G381-A</p>
<p>B329</p> 	<p>Lube Spin-on Contains: Anti-Drainback Valve 20 PSID By-Pass Valve Fits: Chrysler, Ford, Mazda Automotive, Light-Duty Trucks, Vans Replaces: Ford F1AZ-6731-A Thread: M22 x 1.5 O.D.: 3 11/16 (93.7) Height: 3 7/8 (98.4) I.Gskt: G381-A</p>	<p>B337</p> 	<p>By-Pass Lube Spin-on Fits: Isuzu Engines; Link-Belt Equipment Replaces: Isuzu 1-13240-123-0 Thread: M20 x 1.5 O.D.: 4 1/4 (108.0) Height: 5 27/32 (148.4) I.Gskt: [1] Included</p>
<p>BF330</p> 	<p>Fuel Spin-on Fits: Cummins, Komatsu Engines, Equipment Replaces: Komatsu 6136-71-6120 Thread: 3/4 -16 O.D.: 3 1/32 (77.0) Height: 5 7/8 (149.2) I.Gskt: G449-B</p>	<p>BT338</p> 	<p>By-Pass Lube Spin-on Contains: Integral Post Seal Fits: Caterpillar, Kobelco, MDI-Yutani Excavators; Mitsubishi Engines Replaces: Mitsubishi ME014838 Thread: M18 x 1.5 O.D.: 3 11/16 (93.7) Height: 3 7/8 (98.4) I.Gskt: G324-A</p>
<p>PF332</p> 	<p>Fuel Element Fits: Hitachi Equipment; Isuzu, Yanmar Engines Replaces: Hitachi 4514801 O.D.: 3 19/32 (91.3) I.D.: 9/16 (14.3) Height: 5 1/2 (139.7) F. Gskt: [2] Included Grommets: [2] Attached</p>	<p>BT339</p> 	<p>Full-Flow Lube Spin-on Notes: BT7349 may be used in place of BT339. Do NOT substitute BT339 for BT7349. Fits: Ag-Chem, Case, Champion, Dresser, Dynapac, Fiat-Allis, Grove, Ingersoll-Rand, J.C. Bamford, Komatsu, Timberjack, Vermeer, White Equipment; Case, Cummins, DAF Engines Replaces: Case J903264; Consolidated Diesel 3903264; Cummins 3914395 Thread: 1 -16 O.D.: 3 11/16 (93.7) Height: 7 1/8 (181.0) I.Gskt: G381-A Related To: BT427 (Short Version)</p>

Measurements Are Shown In Inches And (Millimeters)

WARNING: These products can expose you to chemicals, including Diisononyl Phthalate, Carbon black extracts, Nickel, 1,3 Butadiene, Ethylene Oxide, Epichlorohydrin, which are known to the State of California to cause cancer, and Bisphenol, Ethylene Glycol, Ethylene Oxide, 1,3 Butadiene, Epichlorohydrin, which are known to the State of California to cause birth defects or other reproductive harm. For more information go to www.P65Warnings.ca.gov.

BT340

By-Pass Lube Spin-on



Fits: Allis Chalmers Equipment
Replaces: Allis Chalmers 4036791
Thread: 1 1/8 -16
O.D.: 4 1/4 (108.0)
Height: 10 7/16 (265.1)
I.Gskt: [1] Included

BT346

Hydraulic Spin-on



Contains: 8 PSID By-Pass Valve
Fits: CMI Equipment; Mahindra Tractors
Replaces: Racine 493308
Thread: 1 -12
O.D.: 3 11/16 (93.7)
Height: 3 1/4 (82.6)
I.Gskt: G381-A

BT341

By-Pass Lube Spin-on



Notes: Can be used with OB1305 base.
Contains: Flow Control Orifice
Fits: Bobcat, Case, Grove, International, Vermeer Equipment; Wisconsin Engines
Replaces: Wisconsin RV52
Thread: 5/8 -18
O.D.: 3 11/16 (93.7)
Height: 4 3/8 (111.1)
I.Gskt: G381-A
Related To: B50, B164 (Long Versions)

BT347

Full-Flow Lube Spin-on



Contains: Anti-Drainback Valve
 30 PSID By-Pass Valve
 Standpipe
Fits: Allis Chalmers, Antonio Carraro, Fiat, Ford, Hesston, New Holland Equipment; Iveco Engines, Trucks
Replaces: Fiat 1909101
Thread: 3/4 -16
O.D.: 4 1/4 (108.0)
Height: 7 11/32 (186.5)
I.Gskt: G381-A

BT342

Hydraulic Spin-on



Contains: 20 PSID By-Pass Valve
Fits: Ford Tractors
Replaces: Ford C7NN-F933-A
Thread: 1 -12
O.D.: 3 11/16 (93.7)
Height: 6 5/8 (168.3)
I.Gskt: G381-A

BT348

Full-Flow Lube Spin-on



Contains: Anti-Drainback Valve
 30 PSID By-Pass Valve
 Standpipe
Fits: Allis Chalmers, Caterpillar, Fiat, Ford, Hesston, New Holland Equipment
Replaces: Fiat 1909102
Thread: 3/4 -16
O.D.: 4 1/4 (108.0)
Height: 5 13/16 (147.6)
I.Gskt: G381-A

BT343

Full-Flow Lube Spin-on



Contains: Anti-Drainback Valve
 18-20 PSID By-Pass Valve
Fits: Ford Equipment
Replaces: Ford D8NN-6714-DA
Thread: 1 1/8 -16
O.D.: 5 3/8 (136.5)
Height: 6 1/32 (153.2)
I.Gskt: [1] Included

BT349

Full-Flow Lube Spin-on



Contains: Anti-Drainback Valve
 20 PSID By-Pass Valve
Fits: Allis Chalmers, Astra, Case Equipment; Fiat, Iveco Engines
Replaces: Fiat 1909137
Thread: 1 -12
O.D.: 4 1/4 (108.0)
Height: 9 1/8 (231.8)
I.Gskt: G401

BT344-S

Hydraulic Spin-on



Contains: 20 PSID By-Pass Valve
Fits: Caterpillar, Daewoo Equipment
Replaces: Caterpillar 4T7948
Thread: 13/16 -16
O.D.: 3 23/32 (94.5)
Height: 4 15/32 (113.5)
I.Gskt: G401

BT350

Hydraulic Spin-on



Fits: Allis Chalmers Equipment
Replaces: Allis Chalmers 267600
Thread: 13/16 -16
O.D.: 4 1/4 (108.0)
Height: 7 11/32 (186.5)
I.Gskt: G381-A

BT345 KIT

Set of 2 Hydraulic Spin-ons



Contains: 20 PSID By-Pass Valve
Fits: Case Tractors
Replaces: Case A161846 KIT
Thread: 1 1/2 -16
O.D.: 5 1/16 (128.6)
Height: 10 25/32 (273.8)
F. Gskt: [2] G483 (One Per Filter)
O. Gskt: G286-C, G369-V, G447, G483, G704, G710

BT351











Hydraulic Spin-on

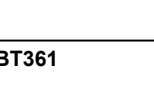

Notes: Can be used with OB1313, OB1314, OB1315 and OB1316 bases.
Fits: Aveling-Barford, Braud, J.C. Bamford, Liebherr, New Holland Equipment
Replaces: J.C. Bamford 32/901401
Thread: 1 1/4 -11 BSP-PL
O.D.: 5 (127.0)
Height: 7 3/32 (180.2)
I.Gskt: [1] Included
Related To: BT8450 (with Anti-Drainback Valve, 15 PSID By-Pass Valve)

Measurements Are Shown In Inches And (Millimeters)

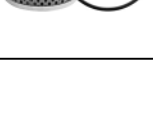
WARNING: These products can expose you to chemicals, including Diisononyl Phthalate, Carbon black extracts, Nickel, 1,3 Butadiene, Ethylene Oxide, Epichlorohydrin, which are known to the State of California to cause cancer, and Bisphenol, Ethylene Glycol, Ethylene Oxide, 1,3 Butadiene, Epichlorohydrin, which are known to the State of California to cause birth defects or other reproductive harm. For more information go to www.P65Warnings.ca.gov.

<p>BT351-MPG</p> 	<p>Maximum Performance Glass Hydraulic Spin-on Replaces: U.C.C. UCMXR9550; Fleetguard HF7980; Woodgate WGUC9550 Thread: 1 1/4 -11 BSP-PL O.D.: 5 (127.0) Height: 7 (177.8) I.Gskt: [1] Included</p>	<p>BT357</p> 	<p>Hydraulic Spin-on Contains: 2 PSID By-Pass Valve Fits: International, New Holland Equipment Replaces: International 404886-R1, 404886-R91 Thread: 1 -12 O.D.: 3 11/16 (93.7) Height: 3 1/4 (82.6) I.Gskt: G381-A</p>
<p>P352</p> 	<p>Lube Element Fits: ERF Trucks; Leyland Buses, Trucks Replaces: Leyland GL21779 O.D.: 3 3/16 (81.0) I.D.: 7/16 (11.1) Height: 8 9/16 (217.5) Spring: [1] Attached Grommets: [1] Attached</p>	<p>B358</p> 	<p>Power Steering Spin-on Contains: 2 PSID By-Pass Valve Replaces: International 995285-C1 Thread: 13/16 -16 O.D.: 3 11/16 (93.7) Height: 4 3/8 (111.1) I.Gskt: G381-A</p>
<p>BT353</p> 	<p>Full-Flow Lube Spin-on Contains: Anti-Drainback Valve 20 PSID By-Pass Valve Fits: Allis Chalmers, Massey Ferguson Tractors Replaces: Allis Chalmers 20797690-8; Massey Ferguson 3280185-M91 Thread: 3/4 -16 O.D.: 3 1/32 (77.0) Height: 5 27/32 (148.4) I.Gskt: [1] Included</p>	<p>BT359</p> 	<p>Transmission Spin-on Fits: Allison Transmissions Replaces: GMC 25010335 Thread: 1 5/16 -12 O.D.: 4 5/8 (117.5) Height: 10 9/32 (261.1) I.Gskt: [1] Included</p>
<p>BT354</p> 	<p>Transmission Spin-on Contains: 8 PSID By-Pass Valve Fits: Ford, Massey Ferguson, New Holland Equipment Replaces: Ford D8NN-B486-EA Thread: 1 1/8 -16 O.D.: 3 11/16 (93.7) Height: 5 3/8 (136.5) I.Gskt: G381-A</p>	<p>B360</p> 	<p>Full-Flow Lube Spin-on Contains: Anti-Drainback Valve Fits: Mercruiser Marine Engines Replaces: Quicksilver 14957 Thread: 13/16 -16 O.D.: 3 13/16 (96.8) Height: 4 3/8 (111.1) I.Gskt: [1] Included</p>
<p>BT355</p> 	<p>Full-Flow Lube Spin-on Contains: 20 PSID By-Pass Valve Fits: Ford, New Holland Equipment Replaces: Ford D8NN-6714-AA Thread: 1 -12 O.D.: 4 1/4 (108.0) Height: 5 7/8 (149.2) I.Gskt: G401</p>	<p>BT361</p> 	<p>Hydraulic Spin-on Contains: 8 PSID By-Pass Valve Fits: Cessna Hydraulic Systems; Owatonna Equipment Replaces: Cessna Fluid Power 62200G Thread: 7/8 -14 O.D.: 3 11/16 (93.7) Height: 5 3/8 (136.5) I.Gskt: G381-A</p>
<p>P356</p> 	<p>Lube Element Fits: Bedford Buses, Trucks; Hymac, J.C. Bamford Equipment; Perkins Engines Replaces: Perkins 26560076 O.D.: 3 21/32 (92.9) I.D.: 1 11/32 (34.1) Height: 6 (152.4) F. Gskt: [1] Included End Seals: [2] Attached</p>	<p>BT364</p> 	<p>Full-Flow Lube or Hydraulic Spin-on Contains: 20 PSID By-Pass Valve Fits: Ag-Chem, Caterpillar, CMI, Dynapac, Grove, New Holland, White Equipment; Caterpillar Engines; Ford, GMC, International, Mack, WhiteGMC Trucks Replaces: Caterpillar 9N5680, 1R0734 Thread: 1 -12 O.D.: 3 11/16 (93.7) Height: 5 3/8 (136.5) I.Gskt: G381-A</p>

Measurements Are Shown In Inches And (Millimeters)

⚠ WARNING: These products can expose you to chemicals, including Diisononyl Phthalate, Carbon black extracts, Nickel, 1,3 Butadiene, Ethylene Oxide, Epichlorohydrin, which are known to the State of California to cause cancer, and Bisphenol, Ethylene Glycol, Ethylene Oxide, 1,3 Butadiene, Epichlorohydrin, which are known to the State of California to cause birth defects or other reproductive harm. For more information go to www.P65Warnings.ca.gov.

BT365 Lube or Hydraulic Spin-on
Fits: Case, Hydra-Mac, Perkins Engines, Equipment; Thermo King Refrigeration Units
Replaces: Hydra-Mac 3408-305; Thermo King 11-3712
Thread: 1 -12
O.D.: 3 11/16 (93.7)
Height: 7 3/16 (182.6)
I.Gskt: G401



B369 Air Breather Spin-on
Replaces: Mack 2MD3131
Thread: 3/4 -20
O.D.: 3 11/16 (93.7)
Height: 4 3/8 (111.1)
I.Gskt: G381-A



BT365-10 Lube or Hydraulic Spin-on
Fits: Hydra-Mac Equipment
Replaces: Hydra-Mac 1309-108
Thread: 1 -12
O.D.: 3 11/16 (93.7)
Height: 7 3/16 (182.6)
I.Gskt: G401



PT370 Hydraulic Element
Fits: Massey Ferguson Industrial Equipment
Replaces: Massey Ferguson 1430492-M92
O.D.: 6 25/32 (172.2)
I.D.: 4 7/32 (107.2)
Height: 15 5/16 (388.9)
A. Gskt: [2] Attached



BT366-10 Hydraulic Spin-on
Fits: Bedford, J.C. Bamford, New Holland, Thwaites Equipment; U.C.C. Hydraulic Systems
Replaces: U.C.C. UC-MS1518-4-10
Thread: 3/4 -14 BSP-PL
O.D.: 3 11/16 (93.7)
Height: 5 13/32 (137.3)
I.Gskt: G401



BT371-10 Hydraulic or Transmission Spin-on
Fits: Case, International, John Deere, New Holland Equipment
Replaces: Hyster 27749012; John Deere AE37594; Pall HC9540SUJ4H
Thread: 1 1/2 -16
O.D.: 3 13/16 (96.8)
Height: 5 13/32 (137.3)
I.Gskt: [1] Included
Related To: BT372-10, BT372-MPG (Long Versions)



BT366-MPG Maximum Performance Glass Hydraulic Spin-on
Replaces: U.C.C. UCMXR8550; Fleetguard HF7983; Woodgate WGUC8550
Thread: 3/4 -14 BSP-PL
O.D.: 3 25/32 (96.0)
Height: 5 23/32 (145.3)
I.Gskt: [1] Included



BT371-5 Hydraulic Spin-on
Notes: OBSOLETE. Availability Limited to Dealer Stock.
Replaces: Woodgate WGH6606
Thread: 1 1/2 -16
O.D.: 3 25/32 (96.0)
Height: 5 23/32 (145.3)
I.Gskt: [1] Included



BT367 Air Breather Spin-on
Fits: Steiger Equipment
Replaces: Steiger 18-1633
Thread: 1 1/8 -16
O.D.: 3 11/16 (93.7)
Height: 4 11/32 (110.3)
O. Gskt: ES3028



BT371-MPG Maximum Performance Glass Hydraulic or Transmission Spin-on
Fits: Case, International, John Deere, New Holland Equipment
Replaces: Pall HC7400SUT4H
Thread: 1 1/2 -16
O.D.: 3 13/16 (96.8)
Height: 5 13/32 (137.3)
I.Gskt: [1] Included
Related To: BT372-10, BT372-MPG (Long Versions)



BT367-S Air Breather Spin-on
Fits: Liebherr, McNeilus, Vermeer Equipment
Replaces: Schroeder ABF3/10 (without Adapter)
Thread: 1 1/8 -16
O.D.: 3 11/16 (93.7)
Height: 3 7/32 (81.8)
O. Gskt: ES3028
Related To: B7024 (with Adapter)



BT372-10 Hydraulic or Transmission Spin-on
Fits: Caterpillar, Dresser, Galion, Gehl, International Equipment
Replaces: Caterpillar 3T8642; Galion 149661; International 562871-C91; John Deere AT63557
Thread: 1 1/2 -16
O.D.: 3 11/16 (93.7)
Height: 8 1/16 (204.8)
I.Gskt: [1] Included
Related To: BT371-10, BT371-MPG (Short Versions)



BT368 Air Breather Spin-on
Fits: Allis Chalmers Optional Equipment
Replaces: Allis Chalmers 4835378
Thread: 3/4 -14 BSP-PL
O.D.: 3 11/16 (93.7)
Height: 3 7/32 (81.8)



Measurements Are Shown In Inches And (Millimeters)

WARNING: These products can expose you to chemicals, including Diisononyl Phthalate, Carbon black extracts, Nickel, 1,3 Butadiene, Ethylene Oxide, Epichlorohydrin, which are known to the State of California to cause cancer, and Bisphenol, Ethylene Glycol, Ethylene Oxide, 1,3 Butadiene, Epichlorohydrin, which are known to the State of California to cause birth defects or other reproductive harm. For more information go to www.P65Warnings.ca.gov.

BT372-MPG Maximum Performance Glass Hydraulic or Transmission Spin-on
Fits: International, John Deere, Mustang, Owatonna Equipment
Replaces: John Deere AT69852, AT73307
Thread: 1 1/2 -16
O.D.: 3 11/16 (93.7)
Height: 8 1/16 (204.8)
I.Gskt: [1] Included
Related To: BT371-10, BT371-MPG (Short Versions)



PT377-10 Hydraulic Element
Fits: Michigan Fluid Power Systems
Replaces: Michigan Fluid Power C68
O.D.: 3 1/32 (77.0)
I.D.: 1 1/4 (31.8) One End
Height: 6 15/32 (164.3)
F. Gskt: G458
End Seals: [1] Attached



PT373 Hydraulic Element
Fits: Massey Ferguson Equipment
Replaces: Massey Ferguson 516069-M94
O.D.: 4 1/2 (114.3)
I.D.: 1 29/32 (48.4)
Height: 7 (177.8)
F. Gskt: [2] ES1092, G236-A, [1] Included
O. Gskt: ES3029



B378 Full-Flow Lube Spin-on
Fits: Gardner Denver, Ingersoll-Rand, LeRoi Compressors; Volvo, Yanmar Equipment
Replaces: Ingersoll-Rand 35296920
Thread: 1 1/4 -12
O.D.: 3 11/16 (93.7)
Height: 8 23/32 (221.5)
I.Gskt: G381-A
O. Gskt: G401



PT374 Hydraulic Element
Contains: 20 PSID By-Pass Valve
Fits: Allison Transmissions; Versatile Equipment
Replaces: Versatile SW6502
O.D.: 3 15/32 (88.1)
I.D.: 1 11/32 (34.1) One End
Height: 4 23/32 (119.9)
F. Gskt: [2] Included



B378-10 Full-Flow Lube or Hydraulic Spin-on
Fits: Gardner Denver, Ingersoll-Rand, LeRoi Compressors; Volvo, Yanmar Equipment
Replaces: Gardner Denver 2109412; Ingersoll-Rand 39138433
Thread: 1 1/4 -12
O.D.: 3 11/16 (93.7)
Height: 8 23/32 (221.5)
I.Gskt: G381-A
O. Gskt: G401



PT375 Hydraulic Element
Contains: 20 PSID By-Pass Valve
Fits: New Holland, Versatile Equipment
Replaces: Versatile 36169
O.D.: 3 15/32 (88.1)
I.D.: 1 11/32 (34.1) One End
Height: 9 3/16 (233.4)
F. Gskt: [2] Included

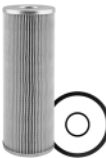

PT379 KIT Set of 2 Hydraulic Elements
Fits: International Tractors
Replaces: International 133736-C1
O.D.: 5 (127.0)
I.D.: 2 15/16 (74.6)
Height: 3 (76.2)
F. Gskt: G368



PT376 Transmission Element
Contains: Reinforced Centertube
Fits: Dresser, Hough, International Equipment
Replaces: International 1140079-C1
O.D.: 4 1/2 (114.3)
I.D.: 2 1/4 (57.2)
Height: 9 3/16 (233.4)
O. Gskt: G211
End Seals: [2] Attached



PT380 KIT Set of 2 Hydraulic Elements
Contains: Reinforced Centertube
Fits: Case Tractors
Replaces: Case A46403 Kit
O.D.: 4 1/2 (114.3)
I.D.: 2 9/32 (57.9)
Height: 7 1/8 (181.0)
F. Gskt: [1] Included for Stacked Elements
O. Gskt: G305 for Side-By-Side Elements
End Seals: [2] Attached to Each Element



PT377 Hydraulic Element
Fits: Michigan Fluid Power Systems
Replaces: Michigan Fluid Power C69
O.D.: 3 1/32 (77.0)
I.D.: 1 1/4 (31.8) One End
Height: 6 15/32 (164.3)
F. Gskt: G458
End Seals: [1] Attached



PT381 Hydraulic Element
Notes: Inside-Out Flow Direction
Fits: Caterpillar Lift Trucks
Replaces: Towmotor 349804
O.D.: 4 1/2 (114.3)
I.D.: 2 1/4 (57.2)
Height: 9 (228.6)



Measurements Are Shown In Inches And (Millimeters)

WARNING: These products can expose you to chemicals, including Diisononyl Phthalate, Carbon black extracts, Nickel, 1,3 Butadiene, Ethylene Oxide, Epichlorohydrin, which are known to the State of California to cause cancer, and Bisphenol, Ethylene Glycol, Ethylene Oxide, 1,3 Butadiene, Epichlorohydrin, which are known to the State of California to cause birth defects or other reproductive harm. For more information go to www.P65Warnings.ca.gov.

PT382

Hydraulic Element



Replaces: Tennant 51885
O.D.: 2 7/8 (73.0)
I.D.: 1 5/16 (33.3) One End
Height: 4 3/8 (111.1)
End Seals: [1] Attached

PT383

Hydraulic Element



Fits: John Deere Equipment
Replaces: John Deere AH91274
O.D.: 5 (127.0)
I.D.: 2 13/16 (71.4)
Height: 6 3/16 (157.2)
O. Gskt: G263
End Seals: [2] Attached

PT385

Transmission Element with Gaskets



Fits: ACDelco Housings; Allis Chalmers, Case, Euclid, Steiger, Terex, Volvo, WABCO Equipment
Replaces: Euclid 6439400; Fiat 70197121; Volvo 66175068; WABCO PB5038
O.D.: 4 7/16 (112.7)
I.D.: 1 1/2 (38.1)
Height: 9 1/16 (230.2)
F. Gskt: ES1071, G115-MSB, G211
End Seals: [2] Attached
Related To: P20-HD (Lube Version)

PT385-E

Transmission Element without Gaskets



Fits: Allis Chalmers, Case, Galion, Grove, Hough, Letourneau, Link-Belt, Michigan, Terex, WABCO Equipment
Replaces: Euclid 6439400; Fiat 70197121; Volvo 66175068; WABCO PB5038
O.D.: 4 7/16 (112.7)
I.D.: 1 1/2 (38.1)
Height: 9 1/16 (230.2)
End Seals: [2] Attached
Related To: P20-HD (Lube Version)

PT386

Hydraulic Element



Contains: Reinforced Centertube
Fits: Hough Equipment
Replaces: International 927535-C91
O.D.: 4 1/2 (114.3)
I.D.: 1 25/32 (45.2)
Height: 11 (279.4)
F. Gskt: [3] Included
End Seals: [2] Attached

BT387

Hydraulic Spin-on



Notes: Can be used with OB1313, OB1314, OB1315, OB1316 bases.
Fits: Gresen Hydraulic Systems; Sellick, Toro Equipment
Replaces: Gresen 7521001
Thread: 1 1/2 -16
O.D.: 5 1/32 (127.8)
Height: 7 (177.8)
F. Gskt: G286-C
O. Gskt: G369-B, G369-V, G372, G447, G483, G704, G710
Related To: BT388, BT388-10 (Long Versions)

BT387-10

Hydraulic Spin-on



Notes: Can be used with OB1313, OB1314, OB1315, OB1316 bases.
Contains: L-Shaped Gasket
Fits: Gresen Hydraulic Systems; Sellick, Toro Equipment
Replaces: Cross 1A9251; Gresen 7521001
Thread: 1 1/2 -16
O.D.: 5 1/32 (127.8)
Height: 7 (177.8)
F. Gskt: G286-C
O. Gskt: G369-B, G369-V, G372, G447, G483, G704, G710
Related To: BT388, BT388-10 (Long Versions)

BT388

Hydraulic Spin-on



Notes: Can be used with OB1313, OB1314, OB1315, OB1316 bases.
Fits: Champion, Rexworks Equipment; Cross Hydraulic Systems
Thread: 1 1/2 -16
O.D.: 5 1/32 (127.8)
Height: 10 3/4 (273.1)
F. Gskt: G286-C
O. Gskt: G369-B, G369-V, G372, G447, G483, G704, G710
Related To: BT387, BT387-10 (Short Versions)

BT388-10

Hydraulic Spin-on



Notes: Can be used with OB1313, OB1314, OB1315, OB1316 bases.
Fits: Cross Hydraulic Systems
Replaces: Cross 1A9253
Thread: 1 1/2 -16
O.D.: 5 1/32 (127.8)
Height: 10 3/4 (273.1)
F. Gskt: G286-C
O. Gskt: G369-B, G369-V, G372, G447, G483, G704, G710
Related To: BT387, BT387-10 (Short Versions)

BT389









Hydraulic Spin-on



Fits: Bandit, Case, Koehring Equipment; Special AMBAC Base
Replaces: Zinga LE10
Thread: 1 1/2 -16
O.D.: 5 1/16 (128.6)
Height: 10 3/4 (273.1)
F. Gskt: G372
O. Gskt: G286-C, G369-B, G369-V, G372, G447, G483, G704, G710, G725

Measurements Are Shown In Inches And (Millimeters)

WARNING: These products can expose you to chemicals, including Diisononyl Phthalate, Carbon black extracts, Nickel, 1,3 Butadiene, Ethylene Oxide, Epichlorohydrin, which are known to the State of California to cause cancer, and Bisphenol, Ethylene Glycol, Ethylene Oxide, 1,3 Butadiene, Epichlorohydrin, which are known to the State of California to cause birth defects or other reproductive harm. For more information go to www.P65Warnings.ca.gov.

<p>BT389-10</p>  <p>Hydraulic Spin-on Fits: Bandit, Case, Koehring Equipment; Special AMBAC Base Replaces: Zinga LE10 Thread: 1 1/2 -16 O.D.: 5 1/16 (128.6) Height: 10 3/4 (273.1) F. Gskt: G369-B O. Gskt: G286-C, G369-B, G369-V, G372, G447, G483, G704, G710, G725</p>	<p>PT394-5</p>  <p>Hydraulic Element Replaces: Ingersoll-Rand 39101704 O.D.: 6 1/32 (153.2) I.D.: 1 23/32 (43.7) Height: 7 5/8 (193.7) O. Gskt: G193 End Seals: [2] Attached Related To: P194 Series (Micron Difference)</p>
<p>PT390-MPG</p>  <p>Maximum Performance Glass Hydraulic Element Contains: Reinforced Centertube Fits: John Deere Equipment Replaces: John Deere AR94510 O.D.: 4 9/16 (115.9) I.D.: 2 7/32 (56.4) Height: 7 31/32 (202.4) O. Gskt: G397 End Seals: [2] Attached</p>	<p>BT395</p>  <p>Hydraulic Spin-on Contains: 20 PSID By-Pass Valve Fits: Dresser, International Equipment Replaces: International 709014-C1 Thread: 7/8 -14 O.D.: 3 11/16 (93.7) Height: 5 3/8 (136.5) I.Gskt: G381-A</p>
<p>PT391-MPG</p>  <p>Maximum Performance Glass Hydraulic Element Contains: Reinforced Centertube Fits: John Deere Equipment Replaces: John Deere AR98098 O.D.: 4 9/16 (115.9) I.D.: 2 7/32 (56.4) Height: 7 31/32 (202.4) O. Gskt: G397 End Seals: [2] Attached</p>	<p>PT396</p>  <p>Hydraulic Element Contains: Spring Reinforced Centertube Fits: Komatsu Equipment Replaces: Komatsu 101-60-15171 O.D.: 2 9/16 (65.1) I.D.: 1 3/32 (27.8) Height: 5 5/8 (142.9)</p>
<p>PT392</p>  <p>Differential Element Fits: Allis Chalmers Tractors Replaces: Allis Chalmers 270781 O.D.: 5 (127.0) I.D.: 2 13/16 (71.4) Height: 6 1/8 (155.6) F. Gskt: [2] Included End Seals: [2] Attached</p>	<p>PT397</p>  <p>Hydraulic Element Fits: Kobelco, Komatsu Equipment Replaces: Komatsu 195-60-16320 O.D.: 5 29/32 (150.0) I.D.: 4 11/32 (110.3) Height: 11 13/16 (300.0)</p>
<p>PT393</p>  <p>Hydraulic Element Fits: Allis Chalmers Tractors Replaces: Allis Chalmers 270782 O.D.: 5 (127.0) I.D.: 2 15/16 (74.6) Height: 9 (228.6) O-Ring: [2] Included</p>	<p>BT398</p>  <p>Hydraulic Spin-on Fits: Komatsu Equipment; Nissan Trucks Replaces: Komatsu 195-60-23160 Thread: 1 1/8 -16 O.D.: 4 1/4 (108.0) Height: 9 1/8 (231.8) I.Gskt: [1] Included</p>
<p>PT394-15</p>  <p>Hydraulic Element Replaces: Ingersoll-Rand 39101704 O.D.: 6 1/32 (153.2) I.D.: 1 23/32 (43.7) Height: 7 5/8 (193.7) O. Gskt: G193 End Seals: [2] Attached Related To: P194 Series (Micron Difference)</p>	<p>PT400</p>  <p>Hydraulic Element Fits: J.C. Bamford, Kobelco, Komatsu, Takeuchi Equipment Replaces: Komatsu 198-49-11440 O.D.: 4 13/32 (111.9) I.D.: 2 3/4 (69.9) Height: 11 9/16 (293.7)</p>

Measurements Are Shown In Inches And (Millimeters)

WARNING: These products can expose you to chemicals, including Diisononyl Phthalate, Carbon black extracts, Nickel, 1,3 Butadiene, Ethylene Oxide, Epichlorohydrin, which are known to the State of California to cause cancer, and Bisphenol, Ethylene Glycol, Ethylene Oxide, 1,3 Butadiene, Epichlorohydrin, which are known to the State of California to cause birth defects or other reproductive harm. For more information go to www.P65Warnings.ca.gov.

PT401-MPG Maximum Performance Glass Hydraulic Element



Fits: Case Dozers; Dresser Loggers, Pay Loaders; Hough Wheel Loaders
Replaces: Case D83130; International 930654-C1
O.D.: 4 1/2 (114.3)
I.D.: 1 25/32 (45.2)
Height: 9 1/8 (231.8)
O. Gskt: G392
End Seals: [2] Attached

BT402 Full-Flow Lube Spin-on



Contains: 30 PSID By-Pass Valve
Replaces: Mitsubishi 3254001600; Onan 1220774
Thread: 1 1/8 -16
O.D.: 4 1/4 (108.0)
Height: 9 1/8 (231.8)
I.Gskt: [1] Included

B403 Full-Flow Lube Spin-on



Contains: Anti-Drainback Valve
 50 PSID By-Pass Valve
Fits: R.V.I., Volvo Buses, Trucks; Renault Engines
Replaces: Renault 5000670670
Thread: 1 -12
O.D.: 3 11/16 (93.7)
Height: 8 1/8 (206.4)
I.Gskt: G381-A

B404 Full-Flow Lube Spin-on



Fits: Hino Trucks
Replaces: Hino 15607-1670
Thread: 1 1/2 -12
O.D.: 4 21/32 (118.3)
Height: 6 1/4 (158.8)
I.Gskt: G498-A

JC405 Cotton and Fiber By-Pass Lube Sock with Pull-Out Bail Handle



Fits: Clark Lift Trucks; Dodge Trucks; Hercules Engines
Replaces: Chrysler 1504092; Clark 955290
O.D.: 4 (101.6)
I.D.: 9/16 (14.3) & 1 5/16 (33.3)
Height: 5 1/4 (133.4)
F. Gskt: G127
End Seals: [1] Attached

CU406 Cotton and Fiber By-Pass Lube Sock with Pull-Out Bail Handle



Fits: ACF-Brill, Aero Coach, Beaver, Brockway, Duplex Buses; International, WhiteGMC Trucks; Allis Chalmers, Barber-Greene, Bucyrus-Erie, Clark, Grove, Hough, International, Link-Belt Equipment
Replaces: ACF-Brill 275633; Beaver 70609H; Brockway 106704; International 649729-R93; White 1267529
O.D.: 4 1/8 (104.8)
I.D.: 9/16 (14.3) & 1 13/16 (46.0)
Height: 5 1/2 (139.7)
F. Gskt: [1] Included
O. Gskt: G127
End Seals: [1] Attached

DF408 Cotton and Fiber By-Pass Lube Sock with Pull-Out Bail Handle



Fits: Oshkosh Trucks; Adams, Bucyrus-Erie, Euclid, Ingersoll-Rand, Schramm Equipment; Allis Chalmers, Waukesha Engines
Replaces: Allis Chalmers 4041082; Bucyrus-Erie P70162; Euclid 9045063
O.D.: 5 3/4 (146.0)
I.D.: 7/8 (22.2) & 1 9/16 (39.7)
Height: 10 (254.0)
F. Gskt: G148
End Seals: [1] Attached

TC413-CPE5 All Cotton Sock Element with Bail Handle



Notes: Cotton sock for most non-acid fluids, flowing at moderate temperatures.
Contains: Spring Reinforced Centertube
Replaces: Peco FT318C5, FTE318C5
O.D.: 3 (76.2)
I.D.: 3/4 (19.0) & 1 11/16 (42.9)
Height: 19 1/2 (495.3)

V414-B Vac-Cel By-Pass Lube Sock



Fits: Bowser-Briggs Housings
Replaces: Bowser-Briggs A414 with A413 Holder
O.D.: 6 3/16 (157.2)
I.D.: 2 7/32 (56.4)
Height: 15 1/2 (393.7)

V414-FF Vac-Cel Dual-Stage Full-Flow Lube Sock



Fits: Bowser-Briggs Housings
Replaces: Bowser-Briggs A414 with A413 Holder
O.D.: 6 3/16 (157.2)
I.D.: 2 7/32 (56.4)
Height: 15 1/2 (393.7)











F415-B Special Vac-Cel Fuel Sock



Notes: Use ONLY as a fuel filter on Bowser-Briggs, Commercial, Hilco, Nugent, Winslow applications.
O.D.: 6 3/16 (157.2)
I.D.: 2 13/32 (61.1)
Height: 18 (457.2)





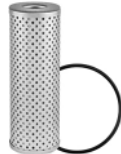







Measurements Are Shown In Inches And (Millimeters)

WARNING: These products can expose you to chemicals, including Diisononyl Phthalate, Carbon black extracts, Nickel, 1,3 Butadiene, Ethylene Oxide, Epichlorohydrin, which are known to the State of California to cause cancer, and Bisphenol, Ethylene Glycol, Ethylene Oxide, 1,3 Butadiene, Epichlorohydrin, which are known to the State of California to cause birth defects or other reproductive harm. For more information go to www.P65Warnings.ca.gov.

<p>P415-10</p> 	<p>Full-Flow Lube Element with Bail Handle Replaces: Commercial D4674 O.D.: 6 (152.4) I.D.: 2 1/8 (54.0) Height: 18 (457.2) O. Gskt: G309-B End Seals: [2] Attached</p>	<p>P415-5A</p> 	<p>Full-Flow Lube Element with Bail Handle Replaces: Large Center Hole Bowser-Briggs BP718 O.D.: 6 (152.4) I.D.: 2 5/8 (66.7) Height: 18 (457.2) O. Gskt: G309-B End Seals: [2] Attached</p>
<p>P415-10A</p> 	<p>Full-Flow Lube Element with Bail Handle Replaces: Large Center Hole Bowser-Briggs BP718 O.D.: 6 (152.4) I.D.: 2 5/8 (66.7) Height: 18 (457.2) O. Gskt: G309-B End Seals: [2] Attached</p>	<p>P415-5AN</p> 	<p>Full-Flow Lube Element with Neoprene End Seals and Bail Handle Replaces: Bowser-Briggs BP718 O.D.: 6 (152.4) I.D.: 2 5/8 (66.7) Height: 17 3/4 (450.9) O. Gskt: G309-B End Seals: [2] Attached</p>
<p>P415-25</p> 	<p>Full-Flow Lube Element with Bail Handle Replaces: Commercial D4674 O.D.: 6 (152.4) I.D.: 2 1/8 (54.0) Height: 18 (457.2) O. Gskt: G309-B End Seals: [2] Attached</p>	<p>P415-GM</p> 	<p>GM Version Full-Flow Lube Element with Bail Handle Contains: Spring Reinforced Centertube Replaces: Large Center Hole Bowser-Briggs BP718 O.D.: 6 17/32 (165.9) I.D.: 2 17/32 (64.3) Height: 18 (457.2) O. Gskt: G309-B End Seals: [2] Attached</p>
<p>P415-25A</p> 	<p>Full-Flow Lube Element with Bail Handle Replaces: Large Center Hole Bowser-Briggs BP718 O.D.: 6 (152.4) I.D.: 2 5/8 (66.7) Height: 18 (457.2) O. Gskt: G309-B End Seals: [2] Attached</p>	<p>V415-B</p> 	<p>Vac-Cel By-Pass Lube Sock Fits: Bowser-Briggs, Commercial, Hilco, Winslow Housings O.D.: 6 3/16 (157.2) I.D.: 2 13/32 (61.1) Height: 18 (457.2)</p>
<p>P415-5</p> 	<p>Full-Flow Lube Element with Bail Handle Replaces: Commercial D4674 O.D.: 6 (152.4) I.D.: 2 1/8 (54.0) Height: 18 (457.2) O. Gskt: G309-B End Seals: [2] Attached</p>	<p>V415-FF</p> 	<p>Vac-Cel Dual-Stage Full-Flow Lube Sock Fits: Bowser-Briggs, Commercial, Hilco, Winslow Housings Replaces: Allis Chalmers 4369208, 4369208-8; Bowser-Briggs A418; Fiat 74369208; General Motors 6438006; White A014040 O.D.: 6 3/16 (157.2) I.D.: 2 13/32 (61.1) Height: 18 (457.2)</p>
		<p>PT416</p> 	<p>Hydraulic Element Fits: Oliver Tractors; White Equipment Replaces: Oliver 165442-A O.D.: 1 31/32 (50.0) I.D.: 29/32 (23.0) One End Height: 5 9/16 (141.3) F. Gskt: G247 End Seals: [1] Attached</p>











Measurements Are Shown In Inches And (Millimeters)

WARNING: These products can expose you to chemicals, including Diisononyl Phthalate, Carbon black extracts, Nickel, 1,3 Butadiene, Ethylene Oxide, Epichlorohydrin, which are known to the State of California to cause cancer, and Bisphenol, Ethylene Glycol, Ethylene Oxide, 1,3 Butadiene, Epichlorohydrin, which are known to the State of California to cause birth defects or other reproductive harm. For more information go to www.P65Warnings.ca.gov.

<p>PT418 Hydraulic Element Notes: Inside-Out Flow Direction Fits: International Equipment Replaces: International 666220-C1 O.D.: 6 1/2 (165.1) I.D.: 5 1/2 (139.7) Height: 15 3/32 (383.4)</p> 	<p>PT426 Hydraulic Element Fits: John Deere Equipment Replaces: Marvel M3401-5110 O.D.: 4 1/2 (114.3) I.D.: 2 1/4 (57.2) One End Height: 7 1/4 (184.2) I.Gskt: [1] Included F. Gskt: G397</p> 
<p>BT420 Transmission Spin-on Contains: Anti-Drainback Valve 8 PSID By-Pass Valve Fits: Hyster Lift Trucks Replaces: Hyster 309112 Thread: 3/4 -16 O.D.: 3 11/16 (93.7) Height: 4 15/32 (113.5) I.Gskt: G401</p> 	<p>BT427 Full-Flow Lube Spin-on Fits: Agco, Bandit, Bomag, Case, Dresser, Dynapac, Grove, Komatsu, MacDon, Vermeer Equipment; Cummins Engines Replaces: Cummins 3903224 Thread: 1 -16 O.D.: 3 11/16 (93.7) Height: 5 3/8 (136.5) I.Gskt: [1] Included Related To: BT339 (Long Version)</p> 
<p>B421 Lube Spin-on Contains: Anti-Drainback Valve 14 PSID By-Pass Valve Fits: Isuzu Automotive Replaces: Isuzu 8-94430-411-1 Thread: M20 x 1.5 O.D.: 3 (76.2) Height: 2 27/32 (72.2) I.Gskt: [1] Included</p> 	<p>V429-B Vac-Cel Standard-Flow Lube Sock Replaces: Michiana 12900, 17800, 17900 O.D.: 6 3/16 (157.2) I.D.: 2 1/2 (63.5) Height: 29 1/4 (742.9)</p> 
<p>S423 Resin Ribbon Hydraulic Breather Element Notes: Element is also in PT181 KIT. Fits: Bantam Carriers, Cranes; Case Loaders, Tractors; LeRoi Compressors; McCoy Dump Boxes Replaces: Bendix R32-20; Case A10059; Hyster 78122 O.D.: 2 (50.8) I.D.: 1 5/8 (41.3) Height: 1 1/4 (31.8)</p> 	<p>V429-FF Vac-Cel Dual-Stage Fast-Flow Lube Sock Replaces: Michiana 12900, 17800, 17900 O.D.: 6 3/16 (157.2) I.D.: 2 1/2 (63.5) Height: 29 1/4 (742.9)</p> 
<p>BT424 Hydraulic Spin-on Contains: 10 PSID By-Pass Valve By-Pass Screen Fits: Ford Tractors Replaces: Ford D8NN-F914-BA, D8NN-F914-CA D8NN-M903-AA, D8NN-M903-FA Thread: 1 1/2 -16 O.D.: 5 1/32 (127.8) Height: 6 31/32 (177.0) F. Gskt: G369-B O. Gskt: G369-V, G704, G710</p> 	<p>PT430-FF All Fluids Element Fits: Bowser-Briggs Optional Filter Housings; Hill Diesel Engines Replaces: Bowser-Briggs BP518-1; Commercial 100257 O.D.: 4 1/2 (114.3) I.D.: 1 25/32 (45.2) Height: 18 1/8 (460.4) End Seals: [2] Attached</p> 
<p>BT425 Hydraulic Spin-on Contains: 9 PSID By-Pass Valve By-Pass Screen Fits: Ford Tractors Replaces: Ford D8NN-M903-EA, D8NN-F914-AA Thread: 1 1/2 -16 O.D.: 5 1/16 (128.6) Height: 8 15/16 (227.0) F. Gskt: [1] Included</p> 	<p>PT431 All Fluids Element Fits: Nugent Optional Filter Housings Replaces: Nugent 1555D1R O.D.: 4 31/32 (126.2) I.D.: 1 9/16 (39.7) Height: 9 1/16 (230.2) F. Gskt: G164-A O-Ring: [2] Included Related To: PT490 (Double-Length Version)</p> 

Measurements Are Shown In Inches And (Millimeters)

WARNING: These products can expose you to chemicals, including Diisononyl Phthalate, Carbon black extracts, Nickel, 1,3 Butadiene, Ethylene Oxide, Epichlorohydrin, which are known to the State of California to cause cancer, and Bisphenol, Ethylene Glycol, Ethylene Oxide, 1,3 Butadiene, Epichlorohydrin, which are known to the State of California to cause birth defects or other reproductive harm. For more information go to www.P65Warnings.ca.gov.

<p>PT433</p>  <p>Hydraulic Element Fits: John Deere Equipment Replaces: John Deere AT79080 O.D.: 4 1/2 (114.3) I.D.: 1 25/32 (45.2) Height: 7 1/8 (181.0) O. Gskt: G236-A, G385, G386 End Seals: [2] Attached</p>	<p>PT437</p>  <p>Hydraulic Element Fits: Cessna Hydraulic Systems; New Holland, Oliver, White Equipment Replaces: Cessna 62300S; New Holland 86546065; White 197650AS O.D.: 3 15/16 (100.0) I.D.: 1/2 (12.7) & 2 1/4 (57.2) Height: 5 1/16 (128.6) F. Gskt: ES1036, G310 End Seals: [1] Attached Grommets: [1] Attached</p>
<p>PT434</p>  <p>Hydraulic Element Notes: NOT interchangeable with PT477 or PT492. Fits: Case, Hough, International Equipment Replaces: Case D71352; International 185531-H1 O.D.: 2 5/8 (66.7) I.D.: 1 7/32 (31.0) One End Height: 4 13/16 (122.2) F. Gskt: G247 End Seals: [1] Attached</p>	<p>BT438</p>  <p>Hydraulic Spin-on Fits: Case, Hesston Equipment Replaces: Hesston 8040461 Thread: 13/16 -16 O.D.: 3 23/32 (94.5) Height: 5 15/32 (138.9) I.Gskt: G401</p>
<p>PT434-10</p>  <p>Hydraulic Element Notes: NOT interchangeable with PT477 or PT492. Fits: Case, Hough, International Equipment Replaces: Case D71352; International 185531-H1 O.D.: 2 5/8 (66.7) I.D.: 1 7/32 (31.0) One End Height: 4 13/16 (122.2) F. Gskt: G247 End Seals: [1] Attached</p>	<p>PT439</p>  <p>Hydraulic Element Contains: Reinforced Centertube Fits: Joy Compressors Replaces: Joy 1139451; Parker 862F O.D.: 2 3/4 (69.9) I.D.: 1 1/4 (31.8) Height: 8 5/8 (219.1) F. Gskt: [2] Included</p>
<p>PT435</p>  <p>Hydraulic Element Notes: Inside-Out Flow Direction Contains: [1] Metal Bushing Fits: Case, International Equipment Replaces: Case G13113 O.D.: 2 5/16 (58.7) I.D.: 1 11/32 (34.1) Height: 6 (152.4)</p>	<p>BT440</p>  <p>Full-Flow Lube Spin-on Fits: Allis Chalmers Engines, Equipment Replaces: Allis Chalmers 4037047 Thread: 1 -16 O.D.: 4 1/4 (108.0) Height: 7 11/32 (186.5) I.Gskt: G381-A Related To: BT564 (Short Version)</p>
<p>PT436</p>  <p>Hydraulic or Lube Element Contains: Reinforced Centertube Fits: Bowser-Briggs Optional Housings; Allis Chalmers, Fiat-Allis, International Equipment Replaces: Allis Chalmers 6407803; Bowser-Briggs BP509-2; International 172595-H1 O.D.: 4 1/2 (114.3) I.D.: 1 25/32 (45.2) Height: 9 1/16 (230.2) F. Gskt: [3] Included End Seals: [2] Attached</p>	<p>PT441</p>  <p>Hydraulic Element Contains: Spring Reinforced Centertube Fits: Fai, Komatsu Equipment Replaces: Komatsu 130-60-48210 O.D.: 2 9/16 (65.1) I.D.: 1 3/32 (27.8) Height: 10 29/32 (277.0)</p>
<p>PT442-MPG</p>  <p>Maximum Performance Glass Hydraulic Element Notes: Inside-Out Flow Direction Fits: John Deere Equipment Replaces: John Deere AT78414 O.D.: 4 17/32 (115.1) I.D.: 2 1/4 (57.2) Height: 8 3/32 (205.6) End Seals: [2] Attached</p>	

Measurements Are Shown In Inches And (Millimeters)

WARNING: These products can expose you to chemicals, including Diisononyl Phthalate, Carbon black extracts, Nickel, 1,3 Butadiene, Ethylene Oxide, Epichlorohydrin, which are known to the State of California to cause cancer, and Bisphenol, Ethylene Glycol, Ethylene Oxide, 1,3 Butadiene, Epichlorohydrin, which are known to the State of California to cause birth defects or other reproductive harm. For more information go to www.P65Warnings.ca.gov.

BT443 Hydraulic Spin-on
Contains: Integral Post Seal
Fits: Massey Ferguson Wheel Tractors
Replaces: Massey Ferguson 3322234-M2
Thread: 1 1/4 -12
O.D.: 4 21/32 (118.3)
Height: 8 3/32 (205.6)
I.Gskt: [1] Included



BT452 Hydraulic Spin-on
Contains: 20 PSID By-Pass Valve
Fits: Daewoo Lift Trucks; Case, International, Steiger Equipment
Replaces: Daewoo D141099; International 70203-C1
Thread: 1 -12
O.D.: 3 11/16 (93.7)
Height: 5 13/32 (137.3)
I.Gskt: G401
Related To: BT839 (without By-Pass Valve)



PT445-MPG Maximum Performance Glass Hydraulic Element
Fits: John Deere Equipment
Replaces: John Deere AT67960
O.D.: 2 7/8 (73.0)
I.D.: 1 1/8 (28.6)
Height: 7 1/2 (190.5)
End Seals: [2] Attached



P454 Power Steering Element
Notes: Inside-Out Flow Direction
Fits: Ford, Peterbilt, WhiteGMC Trucks; International-Harvester Planters
Replaces: Ford D0HZ-3C602-B; International 507809-C91
O.D.: 2 15/32 (62.7)
I.D.: 1 1/16 (27.0) One End
Height: 3 9/16 (90.5)



P446 Power Steering Element
Notes: Inside-Out Flow Direction
Fits: Case, Caterpillar Equipment; International Trucks
Replaces: Case A18061; Caterpillar 32-1504; Ford C5TZ-3C602-A; International 974707-R92
O.D.: 2 15/32 (62.7)
I.D.: 1 3/32 (27.8)
Height: 3 9/16 (90.5)
F. Gskt: G296



S455 Resin Ribbon Fuel Element or Hydraulic Breather
Fits: Austin-Western, Bendix, Case, Franklin, Raygo Equipment
Replaces: Bendix 479135; Case A40314
O.D.: 1 1/2 (38.1)
I.D.: 1 1/8 (28.6)
Height: 1 3/8 (34.9)



B447 Full-Flow Lube Spin-on
Contains: Anti-Drainback Valve
 20 PSID By-Pass Valve
Fits: Volvo Marine Engines
Replaces: Volvo 471034, 471034-9
Thread: 1 -12
O.D.: 4 1/4 (108.0)
Height: 4 11/16 (119.1)
I.Gskt: G381-A



S456 Resin Ribbon Hydraulic Breather Element
Fits: Link-Belt Equipment
Replaces: Link-Belt 1PX316
O.D.: 2 (50.8)
I.D.: 1 5/8 (41.3)
Height: 5 (127.0)

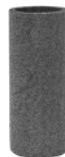

P450 Power Steering Element
Fits: International Balers, Combines
Replaces: International 276259-C91
O.D.: 2 15/32 (62.7)
I.D.: 1 1/16 (27.0)
Height: 1 9/16 (39.7)
O. Gskt: G296



PT457-MPG Maximum Performance Glass Hydraulic Element
Contains: Reinforced Centertube
Fits: John Deere Tractors
Replaces: John Deere AR99661
O.D.: 5 1/2 (139.7)
I.D.: 2 5/8 (66.7)
Height: 7 7/8 (200.0)
O-Ring: [2] Attached



S451 Resin Ribbon Power Steering Element
Fits: FWD Corporation, Patrick Equipment; Mack Trucks
Replaces: FWD Corporation 7D213984; Mack 63SL12; Vickers 213984
O.D.: 2 1/4 (57.2)
I.D.: 1 7/8 (47.6)
Height: 1 13/16 (46.0)













Measurements Are Shown In Inches And (Millimeters)

WARNING: These products can expose you to chemicals, including Diisononyl Phthalate, Carbon black extracts, Nickel, 1,3 Butadiene, Ethylene Oxide, Epichlorohydrin, which are known to the State of California to cause cancer, and Bisphenol, Ethylene Glycol, Ethylene Oxide, 1,3 Butadiene, Epichlorohydrin, which are known to the State of California to cause birth defects or other reproductive harm. For more information go to www.P65Warnings.ca.gov.

<p>PT459 Hydraulic Element Fits: Cessna Hydraulic Systems; Massey Ferguson, New Holland Equipment Replaces: Cessna 20416-43; Massey Ferguson 1023057-M1; New Holland 167495 O.D.: 2 3/32 (53.2) I.D.: 23/32 (18.3) Height: 2 1/16 (52.4)</p> 	<p>PT468-MPG Maximum Performance Glass Hydraulic Element Fits: Massey Ferguson Equipment Replaces: Massey Ferguson 535040-M1 O.D.: 3 3/4 (95.3) I.D.: 1 1/8 (28.6) One End Height: 5 (127.0)</p> 
<p>PT461 Transmission Element Contains: 20 PSID By-Pass Valve Fits: Allis Chalmers, Clark, International, Minneapolis-Moline, Oliver Equipment Replaces: Allis Chalmers 1137201, 1137201-8; Clark 891105; International 392532-R91 O.D.: 1 11/16 (42.9) I.D.: 1 1/32 (26.2) One End Height: 4 3/16 (106.4) F. Gskt: [1] Included End Seals: [1] Attached</p> 	<p>PT469 Hydraulic Element Fits: Galion Equipment Replaces: Galion D67373A O.D.: 5 (127.0) I.D.: 2 1/2 (63.5) Height: 11 7/8 (301.6) End Seals: [2] Attached</p> 
<p>PT462 Hydraulic Element Fits: Ford Equipment Replaces: Ford C5NN-F882-B, C7NN-F882-A O.D.: 6 (152.4) Bottom 6 1/2 (165.1) I.D.: 2 13/32 (61.1) & 3 1/2 (88.9) Height: 6 (152.4) End Seals: [1] Attached</p> 	<p>BT470 Hydraulic Spin-on Fits: Fiat, Ford, Hesston, New Holland Equipment Replaces: Fiat 1909130 Thread: 1 1/8 -16 O.D.: 4 1/4 (108.0) Height: 7 3/8 (187.3) I.Gskt: [1] Included</p> 
<p>PT463 Hydraulic Element Fits: Nicholson Equipment with Purolator Hydraulic Filters Replaces: Purolator 7500501 O.D.: 2 1/32 (51.6) I.D.: 1 7/32 (31.0) One End Height: 7 1/16 (179.4) O-Ring: [1] Attached</p> 	<p>PT471 Hydraulic Element Notes: Inside-Out Flow Direction Fits: John Deere, Minneapolis-Moline Equipment Replaces: John Deere AT45422 O.D.: 4 3/8 (111.1) I.D.: 1 1/16 (17.5) & 3 5/8 (92.1) Height: 9 9/16 (242.9) End Seals: [1] Attached</p> 
<p>PT466 Hydraulic Element Contains: Reinforced Centertube Fits: Hitachi, Isuzu, TCM Equipment Replaces: Hitachi 4505384 O.D.: 4 1/4 (108.0) I.D.: 9/16 (14.3) & 1 15/16 (49.2) Height: 9 15/16 (252.4) A. Gskt: [1] Attached F. Gskt: [2] Included Grommets: [1] Attached</p> 	<p>BT472 Full-Flow Lube Spin-on Contains: Anti-Drainback Valve 20 PSID By-Pass Valve Fits: Allis Chalmers, Fiat-Allis Equipment Replaces: Fiat-Allis 4744707 Thread: M30 x 2.0 O.D.: 4 1/4 (108.0) Height: 9 1/8 (231.8) I.Gskt: [1] Included</p> 
<p>PT467-MPG Maximum Performance Glass Hydraulic Element Fits: White Equipment; Agco Tractors Replaces: White 30-334311B O.D.: 4 1/2 (114.3) I.D.: 1 7/8 (47.6) Height: 6 31/32 (177.0) F. Gskt: [4] Included</p> 	<p>B474 Full-Flow Lube Spin-on Contains: 8 PSID By-Pass Valve Replaces: Quincy 110814 Thread: M16 x 1.5 O.D.: 3 (76.2) Height: 3 17/32 (89.7) I.Gskt: G449-B</p> 













Measurements Are Shown In Inches And (Millimeters)

WARNING: These products can expose you to chemicals, including Diisononyl Phthalate, Carbon black extracts, Nickel, 1,3 Butadiene, Ethylene Oxide, Epichlorohydrin, which are known to the State of California to cause cancer, and Bisphenol, Ethylene Glycol, Ethylene Oxide, 1,3 Butadiene, Epichlorohydrin, which are known to the State of California to cause birth defects or other reproductive harm. For more information go to www.P65Warnings.ca.gov.

<p>PT475</p>  <p>Power Steering Element Fits: Dresser Industrial Equipment; Galion Rollers Replaces: Galion D98524; GMC 6439020 O.D.: 4 1/2 (114.3) I.D.: 1 23/32 (43.7) Height: 8 15/16 (227.0) O. Gskt: G252 End Seals: [2] Attached</p>	<p>PT480-MPG</p>  <p>Maximum Performance Glass Hydraulic Element Contains: Reinforced Centertube Fits: Allis Chalmers, Case, Caterpillar, Minneapolis-Moline, Nicholson Equipment Replaces: Allis Chalmers 2460855; Case A20902 O.D.: 3 (76.2) I.D.: 1 1/16 (27.0) One End Height: 5 21/32 (143.7) O. Gskt: G366 Grommets: [1] Attached</p>
<p>P476</p>  <p>Full-Flow Lube Element Fits: GM Automotive, Engines, Trucks Replaces: GMC 6437562 O.D.: 3 1/2 (88.9) I.D.: 1 5/16 (33.3) Height: 8 7/16 (214.3) F. Gskt: G153</p>	<p>B481</p>  <p>Full-Flow Lube Spin-on Contains: 50 PSID By-Pass Valve Replaces: Worthington FLR412 Thread: 3/4 -16 O.D.: 3 11/16 (93.7) Height: 6 5/8 (168.3) I.Gskt: G381-A</p>
<p>PT477</p>  <p>Hydraulic Element Notes: NOT interchangeable with PT434, PT434-10 or PT492. Fits: Case, Hough Equipment; Marvel Hydraulic Systems Replaces: Case D51411; Marvel 529206-5125 O.D.: 2 5/8 (66.7) I.D.: 1 7/32 (31.0) One End Height: 4 13/16 (122.2) O-Ring: [1] Attached</p>	<p>PT483</p>  <p>Hydraulic Element Fits: Daewoo, Fiat, Hokuetsu, Komatsu Equipment Replaces: Komatsu 205-60-51430 O.D.: 5 29/32 (150.0) I.D.: 4 11/32 (110.3) Height: 17 23/32 (450.1)</p>
<p>PT480</p>  <p>Hydraulic Element Contains: Reinforced Centertube Fits: Allis Chalmers, Case, Caterpillar, Minneapolis-Moline, Nicholson Equipment Replaces: Allis Chalmers 2460855; Case A20902 O.D.: 3 (76.2) I.D.: 1 1/16 (27.0) One End Height: 5 21/32 (143.7) O. Gskt: G366 Grommets: [1] Attached</p>	<p>S485</p>  <p>Resin Ribbon Full-Flow Lube Element O.D.: 1 1/2 (38.1) I.D.: 1 1/8 (28.6) Height: 3 1/2 (88.9)</p>
<p>PT480-10</p>  <p>Hydraulic Element Contains: Reinforced Centertube Fits: Allis Chalmers, Case, Caterpillar, Minneapolis-Moline, Nicholson Equipment Replaces: Allis Chalmers 2460855; Case A20902 O.D.: 3 (76.2) I.D.: 1 1/16 (27.0) One End Height: 5 21/32 (143.7) O. Gskt: G366 Grommets: [1] Attached</p>	<p>BT486</p>  <p>Full-Flow Lube Spin-on Fits: Ag-Chem, Bandit, John Deere Equipment Replaces: John Deere AR98329, AR101278 Thread: 1 1/2 -12 O.D.: 5 1/16 (128.6) Height: 6 31/32 (177.0) F. Gskt: [1] Included</p>

Measurements Are Shown In Inches And (Millimeters)

WARNING: These products can expose you to chemicals, including Diisononyl Phthalate, Carbon black extracts, Nickel, 1,3 Butadiene, Ethylene Oxide, Epichlorohydrin, which are known to the State of California to cause cancer, and Bisphenol, Ethylene Glycol, Ethylene Oxide, 1,3 Butadiene, Epichlorohydrin, which are known to the State of California to cause birth defects or other reproductive harm. For more information go to www.P65Warnings.ca.gov.

<p>PT487</p> 	<p>Hydraulic Element Contains: Reinforced Centertube Fits: Allis Chalmers, Case, Fiat-Allis Equipment Replaces: Allis Chalmers 647256; Fiat 70647256; GMC 25012559 O.D.: 3 15/16 (100.0) I.D.: 1 5/8 (41.3) Height: 9 1/4 (235.0) O. Gskt: ES3012, G368</p>	<p>PT492</p> 	<p>Hydraulic Element Notes: NOT interchangeable with PT434, PT434-10 or PT477. Replaces: Marvel 629206-5110 O.D.: 2 5/8 (66.7) I.D.: 1 7/32 (31.0) Height: 5 (127.0) O-Ring: [2] Attached</p>
<p>B488</p> 	<p>Lube Spin-on Contains: Anti-Drainback Valve 20 PSID By-Pass Valve Fits: Daewoo, John Deere, Komatsu, Yanmar Equipment Replaces: John Deere M801209 Thread: M20 x 1.5 O.D.: 3 11/16 (93.7) Height: 3 1/4 (82.6) I.Gskt: G324-A</p>	<p>PT493</p> 	<p>Hydraulic Element Notes: Inside-Out Flow Direction Fits: Gardner Denver Compressors Replaces: Gardner Denver 5E30 O.D.: 4 31/32 (126.2) I.D.: 1 3/16 (30.2) Height: 18 5/8 (473.1) F. Gskt: [1] Included End Seals: [2] Attached</p>
<p>S489</p> 	<p>Felt Disk Turbocharger Lube Element Notes: OBSOLETE. Availability Limited to Dealer Stock. Fits: International, John Deere Equipment; M & W Gear Co. Supercharger Replaces: M & W Gear Co. 4E005 O.D.: 3 1/4 (82.6) I.D.: 3/4 (19.0) Height: 4 11/16 (119.1) F. Gskt: G105, [2] Included</p>	<p>B494</p> 	<p>By-Pass Lube Spin-on Fits: GMC Trucks; Isuzu Engines Replaces: GMC 94360419; Isuzu 8-94360-419-0 Thread: 5/8 -18 O.D.: 4 1/4 (108.0) Height: 3 3/16 (81.0) I.Gskt: [1] Included</p>
<p>PT490</p> 	<p>Hydraulic Element Fits: Nugent Optional Filter Housings Replaces: Gardner Denver 5E14; Nugent 1555D1S O.D.: 4 15/16 (125.4) I.D.: 1 17/32 (38.9) Height: 18 (457.2) End Seals: [2] Attached Related To: PT431 (Single-Length Version)</p>	<p>B495</p> 	<p>Full-Flow Lube Spin-on Fits: Detroit Diesel Engines Replaces: Detroit Diesel 23518480 Thread: 1 5/8 -12 O.D.: 4 21/32 (118.3) Height: 9 15/16 (252.4) I.Gskt: [1] Included</p>
<p>PT491</p> 	<p>Hydraulic Element Notes: Inside-Out Flow Direction Contains: Reinforced Centertube Fits: Michigan Equipment Replaces: Clark 1530600 O.D.: 6 (152.4) I.D.: 2 23/32 (69.1) Height: 18 (457.2) O. Gskt: G382 End Seals: [1] Attached</p>	<p>B495-MPG</p> 	<p>Maximum Performance Glass Lube Spin-on Fits: Detroit Diesel Engines Replaces: Detroit Diesel 23518480 Thread: 1 5/8 -12 O.D.: 4 21/32 (118.3) Height: 9 15/16 (252.4) I.Gskt: [1] Included</p>
<p>PT491-10</p> 	<p>Hydraulic Element Notes: Inside-Out Flow Direction Contains: Reinforced Centertube Fits: Austin, Western, Clark, Michigan, V.M.E., Volvo Equipment Replaces: Clark 1530600 O.D.: 6 (152.4) I.D.: 2 23/32 (69.1) Height: 18 (457.2) O. Gskt: G382 End Seals: [1] Attached</p>	<p>B495-SS</p> 	<p>Severe Service Lube Spin-on Fits: Detroit Diesel Engines Replaces: Detroit Diesel 23518480 Thread: 1 5/8 -12 O.D.: 4 21/32 (118.3) Height: 9 15/16 (252.4) I.Gskt: [1] Included</p>

Measurements Are Shown In Inches And (Millimeters)

WARNING: These products can expose you to chemicals, including Diisononyl Phthalate, Carbon black extracts, Nickel, 1,3 Butadiene, Ethylene Oxide, Epichlorohydrin, which are known to the State of California to cause cancer, and Bisphenol, Ethylene Glycol, Ethylene Oxide, 1,3 Butadiene, Epichlorohydrin, which are known to the State of California to cause birth defects or other reproductive harm. For more information go to www.P65Warnings.ca.gov.

P496 Full-Flow Lube Element
Fits: Toyota Lift Trucks
Replaces: Toyota 4152-21010, 4152-40010, 4512-40011
O.D.: 2 7/8 (73.0)
I.D.: 21/32 (16.7)
Height: 4 3/8 (111.1)
F. Gskt: ES1049, [1] Included
End Seals: [2] Attached



P497 Full-Flow Lube Element
Fits: Toyota Lift Trucks, Light-Duty Trucks
Replaces: Toyota 4152-40020, 4152-40030, 15600-40012
O.D.: 2 7/8 (73.0)
I.D.: 21/32 (16.7)
Height: 5 1/16 (128.6)
F. Gskt: ES1049, G233-A
End Seals: [2] Attached



PT498 Hydraulic Element
Fits: Austin-Western, Dynahoe, Nicholson Equipment
Replaces: Allis Chalmers 706795132; Clark 993611; Ford 3900612; International 8968811-C1; John Deere AT45810
O.D.: 4 1/2 (114.3)
I.D.: 2 1/4 (57.2) One End
Height: 7 1/4 (184.2)
I.Gskt: [1] Included
O. Gskt: G307, G397



PT498-10 Hydraulic Element
Fits: Allis Chalmers, Fiat-Allis, Ford, Hough Equipment
Replaces: Allis Chalmers 706795132; Clark 993611; Ford 3900612; International 8968811-C1; John Deere AT45810
O.D.: 4 1/2 (114.3)
I.D.: 2 1/4 (57.2) One End
Height: 7 1/4 (184.2)
I.Gskt: [1] Included
O. Gskt: G307, G397



PT499-5 Hydraulic Element
Fits: Gradall, Hough, International Equipment
Replaces: International 26328-M1, 878015-C3
O.D.: 6 (152.4)
I.D.: 2 5/8 (66.7)
Height: 9 (228.6)
End Seals: [2] Attached
Related To: PT212 (Double-Length Version)



501 DAHL Fuel Element
Notes: 4 Micron Nominal (20 Absolute)
Fits: DAHL 500 Series Fuel Filter/Water Separator Units
O.D.: 6 1/16 (154.0)
I.D.: 1 15/32 (37.3)
Height: 9 23/32 (246.9)
O-Ring: [2] Attached



501-30 DAHL Fuel Element
Notes: 9 Micron Nominal (40 Absolute)
Fits: DAHL 500 Series Fuel Filter/Water Separator Units
O.D.: 6 1/16 (154.0)
I.D.: 1 15/32 (37.3)
Height: 9 23/32 (246.9)
O-Ring: [2] Attached

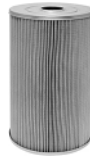

501-W DAHL Fuel Element
Notes: 5 Micron Nominal (25 Absolute)
Fits: DAHL 500 Series Fuel Filter/Water Separator Units
O.D.: 6 1/16 (154.0)
I.D.: 1 15/32 (37.3)
Height: 9 23/32 (246.9)
O-Ring: [2] Attached

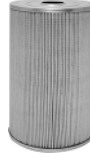

F501-MD Cotton Batting Fuel Sock
Fits: Murphy Diesel Engines; Northwest Equipment
Replaces: Murphy MD13924A
Thread: 1/4 -18 NPT
O.D.: 2 3/8 (60.3)
Height: 36 3/4 (933.5)
F. Gskt: [1] Included



PT503 Hydraulic Element
Fits: Dresser, International Equipment
Replaces: International 666219-C1
O.D.: 6 1/2 (165.1)
I.D.: 5 1/2 (139.7)
Height: 12 3/16 (309.6)



PF506 Fuel Element
Fits: Ford Light-Duty Trucks
Replaces: Ford E5TZ-9365-B
O.D.: 2 3/4 (69.9)
I.D.: 9/16 (14.3) One End
Height: 2 9/16 (65.1)
F. Gskt: [1] Included
Grommets: [1] Attached













P507 Full-Flow Lube Element
Contains: Reinforced Centertube
Fits: Mercedes-Benz Engines, Trucks, Vans
Replaces: Mercedes-Benz 11843925
O.D.: 4 3/4 (120.7)
I.D.: 2 1/4 (57.2)
Height: 8 31/32 (227.8)
A. Gskt: [2] Included
O. Gskt: G439













Measurements Are Shown In Inches And (Millimeters)

WARNING: These products can expose you to chemicals, including Diisononyl Phthalate, Carbon black extracts, Nickel, 1,3 Butadiene, Ethylene Oxide, Epichlorohydrin, which are known to the State of California to cause cancer, and Bisphenol, Ethylene Glycol, Ethylene Oxide, 1,3 Butadiene, Epichlorohydrin, which are known to the State of California to cause birth defects or other reproductive harm. For more information go to www.P65Warnings.ca.gov.

<p>PT508-MPG</p> 	<p>Maximum Performance Glass Hydraulic Element Fits: John Deere Equipment Replaces: John Deere RE11889 O.D.: 4 9/16 (115.9) I.D.: 2 7/32 (56.4) Height: 5 15/32 (138.9) End Seals: [2] Attached</p>	<p>PT515</p> 	<p>Hydraulic Element Fits: Case Equipment Replaces: Case L50384 O.D.: 6 15/32 (164.3) I.D.: 1 27/32 (46.8) Height: 9 23/32 (246.9) O-Ring: [2] Attached</p>
<p>PT509-MPG KIT</p> 	<p>Kit of 2 Maximum Performance Glass Hydraulic Elements Contains: Reinforced Centertube Fits: Case Tractors Replaces: Case A176593 KIT O.D.: 4 1/2 (114.3) I.D.: 2 1/4 (57.2) Height: 7 5/32 (181.8) A. Gskt: [2] Attached on Each Element</p>	<p>PT516</p> 	<p>Hydraulic Element Fits: Bobcat Excavators; Komatsu Equipment Replaces: Komatsu 1546-01-2170 O.D.: 3 15/16 (100.0) I.D.: 2 11/32 (59.5) Height: 8 5/16 (211.1)</p>
<p>PT510</p> 	<p>Hydraulic Element Contains: Reinforced Centertube Fits: Komatsu Equipment Replaces: Komatsu 424-16-11140, 385-10100021, 385-10100022 O.D.: 4 1/2 (114.3) I.D.: 1 23/32 (43.7) Height: 8 15/16 (227.0) A. Gskt: [2] Attached</p>	<p>PT517</p> 	<p>Hydraulic Element Fits: Komatsu Equipment Replaces: Komatsu 1446-01-1160 O.D.: 3 15/16 (100.0) I.D.: 2 11/32 (59.5) Height: 11 1/16 (281.0)</p>
<p>PT512</p> 	<p>Full-Flow Lube Element Fits: E.M.D. Locomotives Replaces: E.M.D. 8322064 O.D.: 4 1/2 (114.3) I.D.: 1 23/32 (43.7) One End Height: 20 (508.0) A. Gskt: [1] Attached</p>	<p>PT518</p> 	<p>Hydraulic Element Fits: American Hoist & Derrick Backhoes; Ingersoll-Rand Compressors Replaces: American Hoist & Derrick 9832252; Ingersoll-Rand 35222981 O.D.: 7 7/16 (188.9) I.D.: 4 3/4 (120.7) One End Height: 22 (558.8) End Seals: [1] Attached</p>
<p>PT513</p> 	<p>Full-Flow Lube Element Fits: E.M.D. Locomotives Replaces: E.M.D. 8340000 O.D.: 2 29/32 (73.8) I.D.: 1 (25.4) One End Height: 7 7/16 (188.9) A. Gskt: [1] Attached</p>	<p>PT518-10</p> 	<p>Hydraulic Element Fits: American Hoist & Derrick, Insley Backhoes Replaces: American Hoist & Derrick 9832252; Ingersoll-Rand 35222981 O.D.: 7 7/16 (188.9) I.D.: 4 3/4 (120.7) One End Height: 22 (558.8) End Seals: [1] Attached</p>
<p>PT514</p> 	<p>Differential Element Fits: Allis Chalmers Equipment Replaces: Allis Chalmers 267300 O.D.: 5 (127.0) I.D.: 2 13/16 (71.4) Height: 6 1/8 (155.6) F. Gskt: [2] Included End Seals: [2] Attached</p>		







Measurements Are Shown In Inches And (Millimeters)

WARNING: These products can expose you to chemicals, including Diisononyl Phthalate, Carbon black extracts, Nickel, 1,3 Butadiene, Ethylene Oxide, Epichlorohydrin, which are known to the State of California to cause cancer, and Bisphenol, Ethylene Glycol, Ethylene Oxide, 1,3 Butadiene, Epichlorohydrin, which are known to the State of California to cause birth defects or other reproductive harm. For more information go to www.P65Warnings.ca.gov.

<p>PT520 Hydraulic Element Fits: Gradall Construction Equipment; Marvel Hydraulic Systems Replaces: Marvel M25415125, M25415140 O.D.: 6 1/2 (165.1) I.D.: 3 15/32 (88.1) Height: 7 1/2 (190.5) I.Gskt: [2] G366</p> 	<p>BT526 Hydraulic Spin-on Fits: Allis Chalmers, Char-Lynn, Ingersoll-Rand, Massey Ferguson Equipment Replaces: Char-Lynn 5604 Thread: 1 1/4 -12 O.D.: 3 11/16 (93.7) Height: 5 3/8 (136.5) I.Gskt: G381-A</p> 
<p>AF521-WN Wing Nut Thread: 7/16 -20 Length: 2 1/16 (52.4) Height: 15/16 (23.8)</p> 	<p>BT526-10 Hydraulic Spin-on Fits: Allis Chalmers, Blaw-Knox, Bobcat, Case, Char-Lynn, Gehl, Ingersoll-Rand, Massey Ferguson, New Holland Equipment Replaces: Char-Lynn 5610 Thread: 1 1/4 -12 O.D.: 3 11/16 (93.7) Height: 5 3/8 (136.5) I.Gskt: G381-A</p> 
<p>BT521 Full-Flow Lube Spin-on Notes: CAUTION: Use ONLY on Case applications. Contains NO by-pass valve. Do NOT substitute for any other filter. Contains: Anti-Drainback Valve Fits: Case Tractors Replaces: Case A62423 Thread: 7/8 -16 O.D.: 4 1/4 (108.0) Height: 7 11/32 (186.5) I.Gskt: G381-A</p> 	<p>PT527 Hydraulic Element Contains: Spring Reinforced Centertube Fits: Koehring Equipment Replaces: Koehring 288B1212 O.D.: 6 1/2 (165.1) I.D.: 2 31/32 (75.4) Height: 18 5/8 (473.1) I.Gskt: [2] Included</p> 
<p>PT522 Hydraulic Element Fits: John Deere Equipment Replaces: John Deere AH76668 O.D.: 3 3/4 (95.3) I.D.: 2 9/16 (65.1) Height: 8 (203.2)</p> 	<p>P528 Hydraulic and Power Steering Element Notes: Inside-Out Flow Direction Fits: Freightliner, International, Kenworth, Mack, Peterbilt, Volvo Trucks Replaces: White 3105264 O.D.: 4 3/4 (120.7) I.D.: 15/16 (23.8) & 1 9/16 (39.7) Height: 4 3/16 (106.4) O. Gskt: G252, G356 End Seals: [2] Attached</p> 
<p>AF525-WN Wing Nut Thread: 7/16 -20 Length: 1 31/32 (50.0) Height: 31/32 (24.6)</p> 	<p>P529 Hydraulic Element with Handle Fits: Marvel Hydraulic Systems; Rexworks Equipment Replaces: Marvel M2801; Rex 298-00133-53 O.D.: 6 1/2 (165.1) I.D.: 1 19/32 (40.5) One End Height: 7 25/32 (197.6) I.Gskt: [1] Included</p> 
<p>BT525 Hydraulic Spin-on Contains: Anti-Drainback Valve Fits: Allis Chalmers Equipment Replaces: Allis Chalmers 253952 Thread: 13/16 -16 O.D.: 3 11/16 (93.7) Height: 8 23/32 (221.5) I.Gskt: G381-A</p> 	<p>PT534 Hydraulic Element Fits: International Wheel Tractors Replaces: International 113618-C1 O.D.: 5 (127.0) I.D.: 2 29/32 (73.8) Height: 2 9/16 (65.1)</p> 











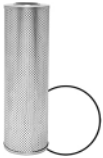

Measurements Are Shown In Inches And (Millimeters)

WARNING: These products can expose you to chemicals, including Diisononyl Phthalate, Carbon black extracts, Nickel, 1,3 Butadiene, Ethylene Oxide, Epichlorohydrin, which are known to the State of California to cause cancer, and Bisphenol, Ethylene Glycol, Ethylene Oxide, 1,3 Butadiene, Epichlorohydrin, which are known to the State of California to cause birth defects or other reproductive harm. For more information go to www.P65Warnings.ca.gov.

<p>PT535</p> 	<p>Hydraulic Element Fits: Caterpillar Equipment Replaces: Caterpillar 9T9054 O.D.: 3 (76.2) I.D.: 1 1/16 (27.0) One End Height: 8 3/16 (208.0) Grommets: [1] Attached</p>	<p>BT541</p> 	<p>Turbocharger Lube Spin-on Notes: Tilt filter to let air out while you fill with oil before installing filter. Contains: Flow Control Orifice 8 PSID By-Pass Valve Fits: International, John Deere, M & W Gear Co., Same Equipment Replaces: M & W Gear Co. 4E023 Thread: 5/8 -18 O.D.: 3 11/16 (93.7) Height: 5 3/8 (136.5) I.Gskt: G381-A</p>
<p>BT536</p> 	<p>Full-Flow Lube Spin-on Contains: 30 PSID By-Pass Valve Fits: Case, International Equipment Replaces: International 3136046-R93 Thread: 1 -12 O.D.: 3 11/16 (93.7) Height: 4 3/8 (111.1) I.Gskt: G381-A</p>	<p>PT543 KIT</p> 	<p>Kit of 2 Hydraulic Elements Fits: Allis Chalmers Tractors; Gardner Denver Drills Replaces: Allis Chalmers 647255; Gardner Denver 165335 O.D.: 2 7/8 (73.0) I.D.: 1 1/16 (27.0) Height: 9 5/8 (244.5) A. Gskt: [2] Attached on Each Element F. Gskt: [2] G366</p>
<p>P537</p> 	<p>Full-Flow Lube Element Replaces: Bofors 91-471-068-01 O.D.: 6 (152.4) I.D.: 3 17/32 (89.7) Height: 13 (330.2)</p>	<p>P545</p> 	<p>Power Steering Element Fits: WhiteGMC Trucks Replaces: White 3107499 O.D.: 3 15/16 (100.0) I.D.: 1 1/8 (28.6) Height: 5 1/8 (130.2) A. Gskt: [2] Attached</p>
<p>PT538</p> 	<p>Hydraulic Element Fits: International Wheel Tractors Replaces: International 113940-C1 O.D.: 4 27/32 (123.0) I.D.: 2 7/8 (73.0) Height: 9 (228.6) F. Gskt: [1] Included End Seals: [2] Attached</p>	<p>PT546</p> 	<p>Hydraulic Element Fits: International Equipment Replaces: International 406669-R1, 406705-R91 O.D.: 2 7/8 (73.0) I.D.: 1 3/16 (30.2) One End Height: 5 19/32 (142.1) A. Gskt: [1] Attached O-Ring: [1] Included</p>
<p>PT539</p> 	<p>Hydraulic Element Contains: Reinforced Centertube Fits: Komatsu, Samsung Equipment Replaces: Komatsu 1756-02-7380 O.D.: 5 1/8 (130.2) I.D.: 3 3/8 (85.7) Height: 11 9/16 (293.7)</p>	<p>PT548</p> 	<p>Steering Element Notes: Inside-Out Flow Direction Fits: Case, Ford, New Holland Equipment Replaces: Ford EDPN-3K758-A O.D.: 3 15/16 (100.0) I.D.: 1 1/16 (27.0) Height: 1 3/8 (34.9) End Seals: [2] Attached</p>
<p>P540</p> 	<p>Full-Flow Lube Element Fits: Lister, Petter Engines Replaces: Lister 268678; Petter 268378 O.D.: 1 31/32 (50.0) I.D.: 29/32 (23.0) Height: 2 1/8 (54.0) O. Gskt: G431 End Seals: [2] Attached</p>	<p>PT549</p> 	<p>Transmission Element Fits: Allis Chalmers, Case, Fiat-Allis, Ford, Galion, International, John Deere, Massey Ferguson, Owatonna Equipment Replaces: Allis Chalmers 10049229; Case D52932; International 630939-C91; Massey Ferguson 1088695-M91; Owatonna 42532521 O.D.: 3 7/16 (87.3) I.D.: 1 3/16 (30.2) One End Height: 5 11/16 (144.5) A. Gskt: [1] Attached F. Gskt: G402</p>













Measurements Are Shown In Inches And (Millimeters)

WARNING: These products can expose you to chemicals, including Diisononyl Phthalate, Carbon black extracts, Nickel, 1,3 Butadiene, Ethylene Oxide, Epichlorohydrin, which are known to the State of California to cause cancer, and Bisphenol, Ethylene Glycol, Ethylene Oxide, 1,3 Butadiene, Epichlorohydrin, which are known to the State of California to cause birth defects or other reproductive harm. For more information go to www.P65Warnings.ca.gov.

<p>PT550-10 Hydraulic Element Fits: Insley Shovels Replaces: Insley H8412; Marvel M3251-5110 O.D.: 4 1/2 (114.3) I.D.: 2 1/4 (57.2) Height: 15 (381.0) I.Gskt: [2] Included F. Gskt: G260 Related To: PT288-HD10 (Single-Length Version)</p> 	<p>PT560 KIT Kit of 2 Hydraulic Elements Contains: Reinforced Centertube Fits: Case Tractors Replaces: Case A44012 KIT O.D.: 4 17/32 (115.1) I.D.: 1/2 (12.7) & 2 9/32 (57.9) Height: 7 1/16 (179.4) F. Gskt: [1] Included End Seals: [1] Attached Each Element Grommets: [1] Attached Each Element</p> 
<p>PT551-10 Hydraulic Element Fits: CMI, Driltech, Gomaco, LeRoi, Lorain Equipment Replaces: Insley H8357, H8409; Schroeder BB10 O.D.: 5 (127.0) I.D.: 3 1/4 (82.6) Height: 18 5/16 (465.1) End Seals: [2] Attached</p> 	<p>PT561 Hydraulic Element Notes: Inside-Out Flow Direction Replaces: John Deere AT63548 O.D.: 4 1/2 (114.3) I.D.: 2 1/4 (57.2) Height: 8 1/16 (204.8) O. Gskt: G400</p> 
<p>PT554 Hydraulic Element Fits: Clark Lift Trucks Replaces: Clark 1618480, 1810437 O.D.: 4 1/2 (114.3) I.D.: 1 29/32 (48.4) Height: 10 3/16 (258.8) F. Gskt: [2] ES1092, [1] Included O. Gskt: G236-A Related To: PT207, PT207-10, PT207-HD, PT207-HD10 (Short Versions) PT573 (Long Version)</p> 	<p>PT562-10 Hydraulic Element Fits: Insley Shovels Replaces: Insley H5898 O.D.: 3 3/8 (85.7) I.D.: 1 7/8 (47.6) Height: 7 7/16 (188.9) I.Gskt: [2] Included</p> 
<p>P555 Hydraulic Element Notes: Inside-Out Flow Direction Fits: Kobelco, LeTourneau-Westinghouse, WABCO Equipment Replaces: LeTourneau DA2980; WABCO WA9652 O.D.: 5 1/8 (130.2) I.D.: 3 3/8 (85.7) Height: 9 1/4 (235.0) A. Gskt: [1] Attached</p> 	<p>PT563 Hydraulic Element Notes: NOT interchangeable with PT566. Fits: Allis Chalmers, John Deere Equipment Replaces: Allis Chalmers 70269922; John Deere AH76991 O.D.: 5 (127.0) I.D.: 2 13/16 (71.4) Height: 9 (228.6) O-Ring: [2] Included End Seals: [2] Attached</p> 
<p>BT556-10 Hydraulic Spin-on Fits: John Deere, Owatonna Loaders Replaces: John Deere GG17031266; Owatonna 17031266 Thread: 1 1/8 -16 O.D.: 4 1/4 (108.0) Height: 10 7/16 (265.1) I.Gskt: [1] Included Related To: B76 (Lube Version)</p> 	<p>BT564 Full-Flow Lube Spin-on Fits: Allis Chalmers, Bantam, Bomag, Champion, Fiat-Allis, Freeman, New Idea Equipment Replaces: Allis Chalmers 4023548-3; New Idea 731607 Thread: 1 -16 O.D.: 4 1/4 (108.0) Height: 5 13/16 (147.6) I.Gskt: G381-A Related To: BT440 (Long Version)</p> 
<p>PT558 Oval Hydraulic Element Fits: International Wheel Tractors Replaces: International 388080-R93, 388084-R93 O.D.: 4 5/8 (117.5) to 7 1/4 (184.2) I.D.: 1 1/2 (38.1) & 2 7/8 (73.0) Height: 2 17/32 (64.3) A. Gskt: [1] Attached F. Gskt: [2] Included</p> 	<p>PT565 Hydraulic Element Fits: Case, International Equipment Replaces: International 530144-R92 O.D.: 5 (127.0) I.D.: 2 13/16 (71.4) Height: 3 (76.2) A. Gskt: [2] Attached F. Gskt: [1] Included Related To: PT8907-MPG (Glass Media Version)</p> 

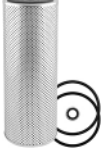
Measurements Are Shown In Inches And (Millimeters)

WARNING: These products can expose you to chemicals, including Diisononyl Phthalate, Carbon black extracts, Nickel, 1,3 Butadiene, Ethylene Oxide, Epichlorohydrin, which are known to the State of California to cause cancer, and Bisphenol, Ethylene Glycol, Ethylene Oxide, 1,3 Butadiene, Epichlorohydrin, which are known to the State of California to cause birth defects or other reproductive harm. For more information go to www.P65Warnings.ca.gov.

<p>PT566</p> 	<p>Hydraulic Element Notes: NOT interchangeable with PT563. Fits: Case, Dresser, International Equipment Replaces: International 623017-C1 O.D.: 5 (127.0) I.D.: 2 13/16 (71.4) Height: 9 (228.6) A. Gskt: [2] Attached</p>	<p>BF577</p>  <p>Primary Fuel Spin-on Contains: Integral Post Seal Thread: 1 -14 O.D.: 3 11/16 (93.7) Height: 8 25/32 (223.0) I.Gskt: G401</p>
<p>PT567</p> 	<p>Hydraulic Element Fits: Equipment with Ripley Hydraulic Systems Replaces: Ripley 4P13 O.D.: 3 3/4 (95.3) I.D.: 1 31/32 (50.0) One End Height: 7 13/16 (198.4) A. Gskt: [1] Attached</p>	<p>PT578</p>  <p>Hydraulic Element Fits: International Equipment Replaces: International 541275-R1, 547412-R91 O.D.: 5 (127.0) I.D.: 2 13/16 (71.4) Height: 4 13/16 (122.2) O-Ring: [1] Included</p>
<p>PT567-10</p> 	<p>Hydraulic Element Fits: Equipment with Ripley Hydraulic Systems Replaces: Ripley 8P13 O.D.: 3 3/4 (95.3) I.D.: 1 31/32 (50.0) One End Height: 7 13/16 (198.4) A. Gskt: [1] Attached</p>	<p>PT579</p>  <p>Hydraulic Element Fits: Gradall, LeRoi, Lorain, Northwest, Prentice Equipment Replaces: Gradall 86671045; Lorain D87282A O.D.: 4 1/4 (108.0) I.D.: 3 1/8 (79.4) Height: 9 23/32 (246.9) A. Gskt: [2] Attached</p>
<p>PT568</p> 	<p>Hydraulic Element Notes: Inside-Out Flow Direction Fits: Timberjack Logging Equipment Replaces: Timberjack 205882 O.D.: 5 1/8 (130.2) I.D.: 13/32 (10.3) & 3 3/8 (85.7) Height: 9 3/32 (231.0) A. Gskt: [2] G120-A Related To: PT90 (As Specified in Applications)</p>	<p>BF582</p>  <p>Secondary Fuel Spin-on Notes: CAUTION: Furnished O-Ring must be installed to seal. Part of BF897 KIT. Fits: Allis Chalmers, Case, Fiat-Allis, Grimmer Schmidt Equipment Replaces: Case A58713 Thread: 15/16 -16 O.D.: 3 11/16 (93.7) Height: 5 13/32 (137.3) I.Gskt: G401 O-Ring: ES24-B</p>
<p>PT571</p> 	<p>Hydraulic Element Contains: Reinforced Centertube Fits: Allis Chalmers, Fiat-Allis Equipment Replaces: Allis Chalmers 669434 KIT, 676022 Element O.D.: 4 7/16 (112.7) I.D.: 1 3/4 (44.4) Height: 12 3/4 (323.8) A. Gskt: [2] Attached F. Gskt: [3] Included</p>	<p>BF583</p>  <p>Fuel Spin-on Contains: Integral Post Seal Fits: Caterpillar, Oliver Engines; CMI, Dynapac, Gradall, International, New Holland, Steiger, Wiggins Equipment Replaces: Caterpillar 1R0710 Thread: 15/16 -16 O.D.: 3 11/16 (93.7) Height: 5 3/8 (136.5) I.Gskt: G381-A</p>
<p>PT573</p> 	<p>Hydraulic Element Fits: Clark Lift Trucks, Loaders Replaces: Clark 1810528, 1810889 O.D.: 4 1/2 (114.3) I.D.: 1 29/32 (48.4) Height: 12 1/4 (311.2) F. Gskt: [2] ES1092, G417 Related To: PT207, PT207-10, PT207-HD, PT207-HD10 PT554 (Short Versions)</p>	<p>BF584</p>  <p>Fuel Spin-on Notes: Can be used with FB46185 base. Contains: Integral Post Seal Fits: Caterpillar Paving Equipment Thread: 1 -14 O.D.: 4 1/4 (108.0) Height: 10 7/16 (265.1) I.Gskt: G381-A Related To: BF1218 (Fuel/Water Separator Version)</p>

Measurements Are Shown In Inches And (Millimeters)

WARNING: These products can expose you to chemicals, including Diisononyl Phthalate, Carbon black extracts, Nickel, 1,3 Butadiene, Ethylene Oxide, Epichlorohydrin, which are known to the State of California to cause cancer, and Bisphenol, Ethylene Glycol, Ethylene Oxide, 1,3 Butadiene, Epichlorohydrin, which are known to the State of California to cause birth defects or other reproductive harm. For more information go to www.P65Warnings.ca.gov.

BF584-B Fuel Spin-on (Boxed Version)
Contains: Integral Post Seal
Fits: Caterpillar Paving Equipment
Thread: 1 -14
O.D.: 4 1/4 (108.0)
Height: 10 7/16 (265.1)
I.Gskt: G381-A
Related To: BF1218 (Fuel/Water Separator Version)



BF587-D Secondary Fuel Spin-on with Drain
Fits: Atlas-Copco Compressors; Deutz, Volvo-Penta Engines; Case, Deutz, Dresser, Fendt, Ford, Galion, Hough, International, John Deere, New Holland Equipment; Fiat, M.A.N. Trucks
Replaces: Deutz 2133943; International 3132428-R91; Volvo-Penta 8385932
Thread: M16 x 1.5
O.D.: 3 1/32 (77.0)
Height: 6 1/8 (155.6)
I.Gskt: G449-B
Related To: BF5587-D (with Trapped O-Ring)



BF585 Fuel Spin-on
Fits: Ford, Ottawa Trucks
Replaces: Ford D3HZ-9155-A, D3HZ-9365-A
Thread: 1 -14
O.D.: 3 11/16 (93.7)
Height: 5 11/32 (135.7)
I.Gskt: [1] Included



BF588 Secondary Fuel Spin-on
Notes: Use BF7629 on International Engines having a single fuel filter.
Contains: Integral Post Seal
Fits: Allis Chalmers, Case, Dresser, Galion, Hough, John Deere, Oliver Equipment; International Engines, Equipment
Replaces: International 672603-C2, 672603-C3
Thread: 7/8 -14
O.D.: 4 1/4 (108.0)
Height: 7 11/32 (186.5)
I.Gskt: G381-A



BF586 Primary Fuel Spin-on
Fits: Atlas Copco Compressors; Deutz Engines; Deutz, Hanomag, International Equipment
Replaces: Deutz 2133558; International 3136187-R91
Thread: M16 x 1.5
O.D.: 3 1/32 (77.0)
Height: 5 27/32 (148.4)
I.Gskt: G449-B



BF591 Secondary Fuel Spin-on
Notes: CAUTION: Furnished O-Ring must be installed on post for seal.
Contains: Integral Post Seal
Fits: Case, Drott Equipment
Replaces: Case A77220
Thread: 15/16 -16
O.D.: 3 11/16 (93.7)
Height: 7 3/16 (182.6)
I.Gskt: G401
O-Ring: ES24-B



BF586-D Primary Fuel Spin-on with Drain
Fits: Atlas Copco Compressors; Deutz Engines; Deutz, Hanomag, International Equipment
Replaces: Deutz 2133558; International 3136187-R91
Thread: M16 x 1.5
O.D.: 3 1/32 (77.0)
Height: 5 27/32 (148.4)
I.Gskt: G449-B



BF592 Primary Fuel Spin-on
Notes: Can be used with FB1301 base.
Fits: Detroit Diesel Engines
Replaces: Detroit Diesel 23518527
Thread: 1 -12
O.D.: 3 11/16 (93.7)
Height: 4 11/32 (110.3)
I.Gskt: [1] Included
Related To: BF5800 (Long Version)



BF587 Secondary Fuel Spin-on
Fits: Atlas-Copco Compressors; Deutz, Volvo-Penta Engines; Case, Deutz, Dresser, Fendt, Ford, Galion, Hough, International, John Deere, New Holland Equipment; Fiat, M.A.N. Trucks
Replaces: Deutz 2133943; International 3132428-R91; Volvo-Penta 8385932
Thread: M16 x 1.5
O.D.: 3 1/32 (77.0)
Height: 6 1/8 (155.6)
I.Gskt: G449-B



BF593 Secondary Fuel Spin-on
Notes: Can be used with FB1302 base.
Contains: Integral Post Seal
Fits: Detroit Diesel Engines
Replaces: GMC 23518526, 23518669
Thread: 13/16 -12
O.D.: 3 23/32 (94.5)
Height: 4 13/32 (111.9)
I.Gskt: [1] Included













Measurements Are Shown In Inches And (Millimeters)

WARNING: These products can expose you to chemicals, including Diisononyl Phthalate, Carbon black extracts, Nickel, 1,3 Butadiene, Ethylene Oxide, Epichlorohydrin, which are known to the State of California to cause cancer, and Bisphenol, Ethylene Glycol, Ethylene Oxide, 1,3 Butadiene, Epichlorohydrin, which are known to the State of California to cause birth defects or other reproductive harm. For more information go to www.P65Warnings.ca.gov.

<p>F594-F</p> 	<p>Fuel Element with Bail Handle Replaces: Deutz R2H4115 O.D.: 4 5/32 (105.6) I.D.: 3/4 (19.0) Height: 6 23/32 (170.7) A. Gskt: [2] Attached</p>	<p>PF598-10</p>  <p>Fuel/Water Separator with Bail Handle Fits: Racor 500 Series Housings Replaces: Racor 2010 Series O.D.: 3 7/32 (81.8) I.D.: 5/8 (15.9) Height: 2 3/4 (69.9) F. Gskt: G458, [1] Included Grommets: [2] Attached</p>
<p>PF594</p> 	<p>Primary Fuel Element Fits: Deutz Diesel Engines Replaces: Deutz W2H4115 O.D.: 3 15/16 (100.0) I.D.: 23/32 (18.3) Height: 6 5/8 (168.3) Grommets: [2] Attached</p>	<p>PF598-30</p>  <p>Fuel/Water Separator with Bail Handle Fits: Racor 500 Series Housings Replaces: Racor 2010 Series O.D.: 3 7/32 (81.8) I.D.: 5/8 (15.9) Height: 2 3/4 (69.9) F. Gskt: G458, [1] Included Grommets: [2] Attached</p>
<p>BT595</p> 	<p>Full-Flow Lube or Hydraulic Spin-on Fits: Caterpillar Lift Trucks; Cummins Engines Replaces: Caterpillar 91-7336 Thread: 1 1/8 -16 O.D.: 3 11/16 (93.7) Height: 7 3/16 (182.6) I.Gskt: G401</p>	<p>PF599</p>  <p>Fuel/Water Separator Element Fits: Racor 200 Series Housings Replaces: Racor 2000 Series O.D.: 1 3/4 (44.4) I.D.: 15/32 (11.9) One End Height: 2 27/32 (72.2) I.Gskt: [1] Included O. Gskt: G467, G468</p>
<p>BF596</p> 	<p>Fuel Spin-on Contains: Integral Post Seal Fits: Cummins Engines; Euclid, Komatsu Equipment; International, Kenworth, Mack Trucks Replaces: Cummins 3313306 Thread: 1 1/4 -12 O.D.: 4 21/32 (118.3) Height: 11 7/32 (285.0) I.Gskt: G498-A Related To: BF1216 (Fuel/Water Separator Version)</p>	<p>PF599-10</p>  <p>Fuel/Water Separator Element Fits: Racor 200 Series Housings Replaces: Racor 2000 Series O.D.: 1 3/4 (44.4) I.D.: 15/32 (11.9) One End Height: 2 27/32 (72.2) I.Gskt: [1] Included O. Gskt: G467, G468</p>
<p>BF597</p> 	<p>Fuel Spin-on with Drain Notes: CAUTION: Furnished O-Ring must be installed on post for seal. Fits: Allis Chalmers, Fiat-Allis, New Idea Equipment Replaces: Allis Chalmers 4321716, 4321716-5 Thread: 15/16 -16 O.D.: 3 11/16 (93.7) Height: 7 17/32 (191.3) I.Gskt: G401 O-Ring: ES24-B</p>	<p>PA602</p>  <p>Air Element Fits: Chevrolet, Ford, Jeep Automotive; Continental, Hercules, Kohler Engines Replaces: Continental RD6F453; Diamond Reo 2325H2; Ford ECB-9601-A; Hercules 260820; International 863725-C91 O.D.: 9 1/16 (230.2) I.D.: 6 3/4 (171.5) Height: 3 5/8 (92.1)</p>
<p>PF598</p> 	<p>Fuel/Water Separator with Bail Handle Fits: Racor 500 Series Housings Replaces: Racor 2010 Series O.D.: 3 7/32 (81.8) I.D.: 5/8 (15.9) Height: 2 3/4 (69.9) F. Gskt: G458, [1] Included Grommets: [2] Attached</p>	<p>PA604</p>  <p>Air Element Fits: International Engines Replaces: International 118791-R91 O.D.: 9 1/16 (230.2) I.D.: 6 3/4 (171.5) Height: 3 7/8 (98.4)</p>
		<p>B605</p>  <p>Full-Flow Lube Spin-on Fits: Hitachi Equipment; Nissan, Volvo Engines, Trucks Replaces: Nissan 15201-Z9007, FL201-Z9010; Volvo 422994 Thread: 1 1/8 -16 O.D.: 4 1/4 (108.0) Height: 5 27/32 (148.4) I.Gskt: [1] Included</p>

Measurements Are Shown In Inches And (Millimeters)

WARNING: These products can expose you to chemicals, including Diisononyl Phthalate, Carbon black extracts, Nickel, 1,3 Butadiene, Ethylene Oxide, Epichlorohydrin, which are known to the State of California to cause cancer, and Bisphenol, Ethylene Glycol, Ethylene Oxide, 1,3 Butadiene, Epichlorohydrin, which are known to the State of California to cause birth defects or other reproductive harm. For more information go to www.P65Warnings.ca.gov.

<p>BT606-MPG Maximum Performance Glass Hydraulic Spin-on Fits: Sullair Compressors Replaces: Sullair 250025-524 Thread: 31/32 -20 O.D.: 3 21/32 (92.9) Height: 5 5/8 (142.9) I.Gskt: G381-A</p> 	<p>BF614 Fuel Spin-on Notes: Can be used with FB46185 base. Fits: American Hoist & Derrick, Aveling-Barford, Caterpillar, CMI, Demag, Driltech, Grove, Steiger, Vermeer Equipment; Caterpillar Engines; Chevrolet, Ford, Freightliner, GMC, International, Kenworth, Mack, Replaces: Caterpillar 1R0712 Thread: 1 -14 O.D.: 3 11/16 (93.7) Height: 10 1/2 (266.7) I.Gskt: G381-A Related To: BF7587 (High Efficiency Version)</p> 
<p>PA607 Air Element Fits: AMC, Chrysler Light-Duty Trucks Replaces: AMC 3191205; Chrysler 8991451 O.D.: 10 (254.0) Top 10 1/4 (260.3) I.D.: 7 5/8 (193.7) Height: 3 1/4 (82.6)</p> 	<p>PA615 Air Element Fits: AMC, Chrysler, Jeep Automotive, Light-Duty Trucks Replaces: Chrysler J8992661; Jeep 999103 O.D.: 10 1/16 (255.6) I.D.: 7 21/32 (194.5) Height: 2 3/4 (69.9)</p> 
<p>BT610-MPG Maximum Performance Glass Lube Spin-on Contains: Integral Post Seal Fits: Sullair Compressors Replaces: Sullair 250025-526 Thread: 1 1/4 -11 BSP-PL O.D.: 4 5/8 (117.5) Height: 11 9/32 (286.5) I.Gskt: G498-A</p> 	<p>PA616 Air Element Contains: Integral Post Seal Flame Retardant Media Fits: Cummins Engines; Hyster Equipment Replaces: Cummins 3001690; Hyster 202951 O.D.: 10 7/32 (259.6) I.D.: 7/16 (11.1) & 7 7/8 (200.0) Height: 12 (304.8) Related To: PA1913 (Closed End Version for Use in Donaldson Housing)</p> 
<p>BT611-MPG Maximum Performance Glass Lube Spin-on Contains: Integral Post Seal Fits: Sullair Compressors Replaces: Sullair 250025-525 Thread: 1 1/4 -11 BSP-PL O.D.: 4 5/8 (117.5) Height: 6 9/32 (159.5) I.Gskt: G498-A</p> 	<p>PA617 Air Element Contains: Integral Post Seal Flame Retardant Media Fits: Autocar Trucks; Cummins Engines; Gradall, Hyster Equipment Replaces: Autocar 860393; Gradall 106338 O.D.: 9 (228.6) I.D.: 7/16 (11.1) & 6 5/8 (168.3) Height: 10 (254.0) A. Gskt: [1] Attached Related To: PA1700 (Heavy-Duty Version for Use in Fram Housing)</p> 
<p>PA612 Air Element Fits: Chrysler Automotive Replaces: Chrysler 1739549, 1739649 O.D.: 8 (203.2) I.D.: 5 3/4 (146.0) Height: 3 1/2 (88.9)</p> 	<p>PA618 Air Element Notes: Used as Cab Air on Massey Ferguson applications. Fits: Caterpillar, Clark, Hough, Ingersoll-Rand, Marion, Massey Ferguson Equipment; Diamond Reo Trucks Use With: PA618 FOAM Replaces: Caterpillar 4L8465 O.D.: 10 7/32 (259.6) I.D.: 5 1/2 (139.7) Height: 12 (304.8)</p> 
<p>PA613 Oval Air Element Fits: Chrysler Automotive Replaces: Chrysler 1739546 O.D.: 6 3/8 (161.9) to 11 1/8 (282.6) I.D.: 4 1/8 (104.8) & 8 7/8 (225.4) Height: 3 1/2 (88.9)</p> 	













Measurements Are Shown In Inches And (Millimeters)

WARNING: These products can expose you to chemicals, including Diisononyl Phthalate, Carbon black extracts, Nickel, 1,3 Butadiene, Ethylene Oxide, Epichlorohydrin, which are known to the State of California to cause cancer, and Bisphenol, Ethylene Glycol, Ethylene Oxide, 1,3 Butadiene, Epichlorohydrin, which are known to the State of California to cause birth defects or other reproductive harm. For more information go to www.P65Warnings.ca.gov.

<p>PA618 FOAM</p> 	<p>Foam Blanket for PA618 Use With: PA618 Length: 34 1/4 (870.0) Width: 11 1/2 (292.1)</p>	<p>PA634</p> 	<p>Air Element Contains: Flame Retardant Media Fits: Caterpillar Lift Trucks; Continental, Kohler Engines; Divco Trucks Replaces: Caterpillar 33-3660; Continental F600F428; Divco 6426 O.D.: 6 3/8 (161.9) Flange: 6 5/8 (168.3) I.D.: 5 (127.0) Height: 3 (76.2)</p>
<p>PA618-S</p> 	<p>Air Element Fits: Caterpillar, CMI, Grove Equipment Replaces: Caterpillar 4L9852 O.D.: 10 7/32 (259.6) I.D.: 6 1/16 (154.0) One End Height: 12 (304.8) A. Gskt: [1] Attached</p>	<p>PA638</p> 	<p>Air Element Fits: International Equipment Replaces: International 204514-R91 O.D.: 9 1/8 (231.8) I.D.: 6 7/8 (174.6) Height: 6 5/8 (168.3)</p>
<p>PA621</p> 	<p>Air Element Contains: Flame Retardant Media Fits: Chevrolet Trucks; EVO Trash Compactors Replaces: GMC 5645166 O.D.: 10 1/32 (254.8) I.D.: 8 17/32 (216.7) Height: 3 (76.2)</p>	<p>PA639</p> 	<p>Air Element Fits: Allis Chalmers, Caterpillar, LeTourneau-Westinghouse Equipment; Gardner Denver Compressors Replaces: Allis Chalmers 70622893; Caterpillar 5M4118; Gardner Denver 2010500 O.D.: 10 1/2 (266.7) I.D.: 5 5/32 (131.0) & 7 3/4 (196.9) Height: 10 1/2 (266.7) A. Gskt: [2] Attached O. Gskt: [2] G31-AF</p>
<p>PA625</p> 	<p>Air Element Fits: GMC Engines, Trucks Replaces: GMC 25041181 O.D.: 11 5/16 (287.3) I.D.: 8 17/32 (216.7) Height: 3 1/16 (77.8)</p>	<p>PA640</p> 	<p>Air Element Contains: Flame Retardant Media Fits: Chevrolet Automotive; Clark, Eaton Lift Trucks; Ingersoll-Rand, Minneapolis-Moline Equipment; Thermo King Refrigeration Units Replaces: Clark 668788; Thermo King 11-1282 O.D.: 4 13/32 (111.9) I.D.: 2 15/16 (74.6) Height: 7 1/32 (178.6)</p>
<p>PA631</p> 	<p>Air Element Fits: Buick, Cadillac, Chevrolet, Oldsmobile, Pontiac Automotive Replaces: GMC 6421030 O.D.: 17 5/16 (439.7) Flange: 18 5/16 (465.1) I.D.: 14 15/16 (379.4) Height: 2 3/16 (55.6)</p>	<p>PA641</p> 	<p>Air Element Contains: Integral Post Seal Flame Retardant Media Fits: Caterpillar Engines; Diamond Reo Trucks; Gradall, Link-Belt Equipment Replaces: Caterpillar 5L5035; Diamond Reo 302106PS; White 884310 O.D.: 6 5/8 (168.3) I.D.: 1/4 (6.4) & 4 1/4 (108.0) Height: 7 7/8 (200.0) A. Gskt: [1] Attached End Seals: [1] Attached</p>
<p>PA632</p> 	<p>Oval Air Element Fits: Ford Automotive Replaces: Ford EDK-9601-A O.D.: 9 23/32 (246.9) 20 23/32 (526.3) I.D.: 7 5/16 (185.7) & 18 5/16 (465.1) Height: 1 3/4 (44.4)</p>	<p>PA642</p> 	<p>Air Element Fits: AMC; Dodge, Ford Trucks, Vans; Jeep; Plymouth Voyager Replaces: AMC 3190562; Ford 3CAZ-9601-A; International 332623-C91; Jeep J3190562 O.D.: 9 11/16 (246.1) I.D.: 7 15/16 (201.6) Height: 2 1/4 (57.2)</p>
<p>PA633(2)</p> 	<p>Set of 2 Draft Tube Air Breathers Fits: Ford Trucks; Clark, Grove, Seamaster Equipment Replaces: Ford C2TZ-6768-A O.D.: 3 7/8 (98.4) I.D.: 2 1/2 (63.5) Height: 1 5/8 (41.3)</p>		













Measurements Are Shown In Inches And (Millimeters)

WARNING: These products can expose you to chemicals, including Diisononyl Phthalate, Carbon black extracts, Nickel, 1,3 Butadiene, Ethylene Oxide, Epichlorohydrin, which are known to the State of California to cause cancer, and Bisphenol, Ethylene Glycol, Ethylene Oxide, 1,3 Butadiene, Epichlorohydrin, which are known to the State of California to cause birth defects or other reproductive harm. For more information go to www.P65Warnings.ca.gov.

<p>PA643 Air Breather Element Fits: Adams, Clark, Euclid, Hymac, Koehring, LeTourneau-Marathon, LeTourneau-Westinghouse, Massey Ferguson, Michigan, Versatile, Yale Equipment; Kenworth, Mack Trucks Replaces: Clark 945345; Euclid 123716; LeTourneau VF2049 O.D.: 2 7/8 (73.0) I.D.: 1 3/8 (34.9) Height: 2 11/16 (68.3)</p> 	<p>PA651 Cab Air Element Fits: Allis Chalmers, Case, Ford, Massey Ferguson, New Holland Equipment Replaces: Allis Chalmers 11433412; Case F22437; Ford C7NN-19N551-A; Massey Ferguson 1032944-M1 O.D.: 9 1/8 (231.8) I.D.: 6 7/8 (174.6) Height: 7 7/32 (183.4)</p> 
<p>PA644 Air Breather Element Fits: Euclid, Hitachi, Terex Equipment; GMC Engines Replaces: Euclid 9023871; GMC 6483993 O.D.: 3 1/16 (77.8) I.D.: 1 9/16 (39.7) Height: 3 5/8 (92.1)</p> 	<p>PA652 Air Element Contains: Flame Retardant Media Fits: Allis Chalmers, Continental, Pettibone-Mulliken Equipment Replaces: Allis Chalmers 49881320; Continental F600F432; Pettibone Y400F404; Worthington FLR218 O.D.: 6 (152.4) I.D.: 4 5/8 (117.5) Height: 3 7/8 (98.4)</p> 
<p>PA645 Air Element Fits: Allis Chalmers, Broyt, Caterpillar, Consolidated, Gardner Denver, Michigan Equipment Replaces: Allis Chalmers 70620717; Caterpillar 7M2654; Gardner Denver 2008185 O.D.: 12 13/16 (325.4) I.D.: 5 29/32 (150.0) & 8 11/32 (211.9) Height: 11 17/32 (292.9) A. Gskt: [2] Attached O. Gskt: G34-AF</p> 	<p>PA653 Air Element Fits: American LaFrance Trucks; International Engines Replaces: American LaFrance 303E5852; Daimler 2732031; International 156073-C91 O.D.: 6 (152.4) I.D.: 4 5/8 (117.5) Height: 8 9/16 (217.5)</p> 
<p>PA648 Air Element Fits: GM Automotive, Light-Duty Trucks, Vans Replaces: GMC 5648003 O.D.: 9 3/4 (247.7) I.D.: 7 15/16 (201.6) Height: 3 (76.2)</p> 	<p>PA654 Air Element Fits: Ford Engines; FWD Corporation Trucks Replaces: Ford C0TZ-9601-A O.D.: 12 1/4 (311.2) I.D.: 9 7/16 (239.7) Height: 5 3/16 (131.8)</p> 
<p>PA649 Air Element Fits: Cushman, GMC, Outboard Marine Corporation Engines Replaces: Cushman 111316; GMC 6420249; Outboard Marine Corporation 111949 O.D.: 5 3/8 (136.5) I.D.: 3 13/16 (96.8) Height: 3 1/8 (79.4)</p> 	<p>PA655 Air Element Contains: Integral Post Seal Flame Retardant Media Fits: International Buses, Engines, Trucks Replaces: International 150868-R91 O.D.: 8 1/16 (204.8) I.D.: 7/16 (11.1) & 5 3/4 (146.0) Height: 7 5/8 (193.7) A. Gskt: [1] Attached End Seals: [1] Attached</p> 
<p>PA650 Air Element Fits: Chrysler Automotive, Light-Duty Trucks, Vans Replaces: Chrysler 2463980 O.D.: 8 (203.2) Top 8 1/4 (209.6) I.D.: 6 1/2 (165.1) Height: 3 (76.2)</p> 	<p>PA656 Air Element Fits: Athey, Bros Equipment; Cummins Engines; ERF Trucks Replaces: Cummins 650051 O.D.: 8 7/8 (225.4) I.D.: 4 11/32 (110.3) Height: 10 (254.0)</p> 

Measurements Are Shown In Inches And (Millimeters)

WARNING: These products can expose you to chemicals, including Diisononyl Phthalate, Carbon black extracts, Nickel, 1,3 Butadiene, Ethylene Oxide, Epichlorohydrin, which are known to the State of California to cause cancer, and Bisphenol, Ethylene Glycol, Ethylene Oxide, 1,3 Butadiene, Epichlorohydrin, which are known to the State of California to cause birth defects or other reproductive harm. For more information go to www.P65Warnings.ca.gov.

<p>PA657 Air Element Fits: Ford Light-Duty Trucks, Vans Replaces: Ford C4OZ-9601-A O.D.: 8 13/32 (213.5) I.D.: 6 19/32 (167.5) Height: 3 1/4 (82.6) Related To: PA2107 (with Foam Wrap)</p> 	<p>PT670-E Full-Flow Lube or Hydraulic Element without Furnished Gaskets Contains: Reinforced Centertube Fits: Caterpillar, DMI, Komatsu, KW-Dart, Unit Rig, WABCO Equipment Replaces: Caterpillar 1R0659; Deutz 1161212; Komatsu 611-4505-100 O.D.: 3 15/16 (100.0) I.D.: 1 19/32 (40.5) Height: 9 9/32 (235.7) O. Gskt: G115-MSB, G342, G435 End Seals: [2] Attached</p> 
<p>PA658 Air Element Fits: Chrysler Automotive; GMC Light-Duty Trucks, Vans; Jeep Replaces: GMC 5648136 O.D.: 9 11/16 (246.1) I.D.: 8 3/16 (208.0) Height: 1 7/8 (47.6) Related To: PA1680 (Long Version)</p> 	<p>PA671 Air Element for Purolator Housing Contains: Flame Retardant Media Fits: Chrysler Trucks; Jeep Replaces: Chrysler 2120933 O.D.: 10 7/32 (259.6) I.D.: 5 1/2 (139.7) Height: 6 (152.4)</p> 
<p>PA662 Air Element Contains: Integral Post Seal Flame Retardant Media Fits: Purolator Optional Filter Housings; Sullair Compressors Replaces: Mack 81SD14 O.D.: 8 1/16 (204.8) I.D.: 1/4 (6.4) & 5 3/4 (146.0) Height: 4 (101.6) A. Gskt: [1] Attached F. Gskt: [1] Included</p> 	<p>PA671-1 Air Element for Fram Housing Fits: Chrysler, Mack Engines Replaces: Mack 3076145756 O.D.: 10 1/4 (260.3) I.D.: 7 3/8 (187.3) Height: 6 (152.4)</p> 
<p>PA666 Outer Air Element Fits: Case, Caterpillar, Clark, Galion Equipment Use With: PA1726 Replaces: Case L32943; Caterpillar 4L4134; Clark 1566067; Galion D63931 O.D.: 12 1/16 (306.4) I.D.: 7 11/16 (195.3) Height: 15 (381.0)</p> 	<p>PA675 Air Element Contains: Flame Retardant Media Fits: Clark Lift Trucks; Onan Engines, Generators Replaces: Clark 1800562; Fiat 2019740; Onan 140B495 O.D.: 4 1/4 (108.0) I.D.: 3 (76.2) Height: 3 5/16 (84.1)</p> 
<p>PA669 Air Element with Bail Handle Contains: Integral Post Seal Flame Retardant Media Fits: Hyster, Ingersoll-Rand, LeRoi Equipment Replaces: Hyster 118643; LeRoi H43435; Pettibone 8326 O.D.: 5 15/16 (150.8) I.D.: 1/4 (6.4) & 3 1/4 (82.6) Height: 4 (101.6) A. Gskt: [1] Attached O. Gskt: G1086-AF</p> 	<p>PT676 Hydraulic Element Fits: Aveling-Barford, Hymac, Kalmar, Moxy Equipment Replaces: Fairey-Arlon 370L210 O.D.: 3 11/16 (93.7) I.D.: 1 7/8 (47.6) Height: 7 27/32 (199.2) F. Gskt: [1] Included O-Ring: [1] Attached</p> 
<p>PT670 Full-Flow Lube or Hydraulic Element with Furnished Gaskets Contains: Reinforced Centertube Fits: American Hoist & Derrick, Caterpillar, Clark, Gardner Denver, Koehring, Komatsu, LeRoi, Link-Belt Equipment Replaces: Caterpillar 1R0659; Deutz 1161212; Komatsu 611-4505-100 O.D.: 3 15/16 (100.0) I.D.: 1 19/32 (40.5) Height: 9 9/32 (235.7) F. Gskt: G171, G214, [1] Included O. Gskt: G115-MSB, G342, G435 End Seals: [2] Attached Related To: PT7332 (with Metal Wrapper)</p> 	<p>PA677 Air Element Fits: Bolens, Briggs & Stratton, Kohler Engines Replaces: Briggs & Stratton 296186; International 385163-R91; Kohler 236840 O.D.: 4 1/4 (108.0) I.D.: 3 (76.2) Height: 1 1/2 (38.1)</p> 

Measurements Are Shown In Inches And (Millimeters)

WARNING: These products can expose you to chemicals, including Diisononyl Phthalate, Carbon black extracts, Nickel, 1,3 Butadiene, Ethylene Oxide, Epichlorohydrin, which are known to the State of California to cause cancer, and Bisphenol, Ethylene Glycol, Ethylene Oxide, 1,3 Butadiene, Epichlorohydrin, which are known to the State of California to cause birth defects or other reproductive harm. For more information go to www.P65Warnings.ca.gov.

PA678 Air Element
Fits: Lawn & Garden Tractors with Kohler, Tecumseh Engines
Replaces: Kohler 235116, 4708302; Tecumseh 10059, 32008
O.D.: 6 1/16 (154.0)
I.D.: 4 5/8 (117.5)
Height: 1 15/16 (49.2)



PA680 Cab Air Element
Fits: Hough Loaders; International, John Deere, Massey Ferguson Equipment with Excello Cabs
Replaces: Case K963803; Hough 87924-C1; Wayne 6049133
O.D.: 7 (177.8)
I.D.: 4 7/8 (123.8)
Height: 4 7/16 (112.7)



PT682 Hydraulic Element
Fits: Hymac Equipment
Replaces: Hymac 2700210
O.D.: 4 31/32 (126.2)
I.D.: 13/32 (10.3) & 3 5/8 (92.1)
Height: 8 9/32 (210.3)



PT683 Wire Backed Hydraulic Element
Replaces: Fairey-Arlon 370L310
O.D.: 3 21/32 (92.9)
I.D.: 1 1/4 (31.8) & 1 7/8 (47.6)
Height: 12 15/32 (316.7)
I.Gskt: [1] Included
O-Ring: [1] Included
Spring: [1] Included



PT685-MPG Hydraulic Element
Fits: Ford Loaders
O.D.: 3 3/32 (78.6)
I.D.: 1 11/16 (42.9)
Height: 8 3/16 (208.0)
O-Ring: [1] Attached



PA691 Air Element
Fits: AMC, Fiat, Lada, Renault Automotive
Replaces: Renault 8983500079
O.D.: 9 (228.6)
I.D.: 7 1/2 (190.5)
Height: 2 15/32 (62.7)



PT691 Hydraulic Element
Fits: Iveco, Kassbohrer, M.A.N., Mercedes-Benz Buses; DAF, Iveco, M.A.N., Mercedes-Benz, R.V.I., Volvo Trucks
Replaces: Bosch 1-457-429-165; Deutz 1267900; Volvo 323139
O.D.: 3 9/32 (83.3)
I.D.: 17/32 (13.5)
Height: 4 9/16 (115.9)
Grommets: [2] Attached



PA693 Air Element
Fits: Chrysler Automotive, Light-Duty Trucks, Vans
Replaces: Chrysler 2402677
O.D.: 12 3/4 (323.8)
I.D.: 11 (279.4)
Height: 3 1/2 (88.9)



PT694 Hydraulic Element
Notes: Inside-Out Flow Direction
Fits: John Deere Equipment
Replaces: John Deere AT78046
O.D.: 4 3/8 (111.1)
I.D.: 2 7/16 (61.9) One End
Height: 16 (406.4)

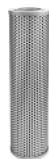

PA696 Air Element
Fits: David Brown Tractors
Replaces: Davis 913601
O.D.: 5 3/4 (146.0)
I.D.: 3 1/2 (88.9)
Height: 2 9/16 (65.1)



PA697 Air Element
Fits: BMW Motorcycles; Mercedes-Benz Trucks, Vans; Stihl Saws
Replaces: BMW 13720043524
O.D.: 3 7/8 (98.4)
I.D.: 2 11/32 (59.5)
Height: 2 3/4 (69.9)



PA699 Air Element
Fits: CompAir Compressors
Replaces: Joy RA221375
O.D.: 6 13/16 (173.0)
I.D.: 5 1/16 (128.6)
Height: 3 1/16 (77.8)





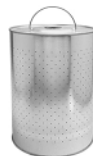







C704-L Vac-Cel By-Pass Lube Element with Bail Handle
Fits: Ag-Chem, Allis Chalmers, Fiat-Allis, Hymac, Versatile Equipment; Luber-finer Model 500 Housing
Replaces: GMC 25010761; Komatsu 667-150-5300; Mack 485GB3116P1; Volvo 1695007
O.D.: 7 11/16 (195.3)
I.D.: 7/8 (22.2)
Height: 10 (254.0)
O. Gskt: ES1376, ES1377, G155, G157, G238, G252, G309-B













Measurements Are Shown In Inches And (Millimeters)

WARNING: These products can expose you to chemicals, including Diisononyl Phthalate, Carbon black extracts, Nickel, 1,3 Butadiene, Ethylene Oxide, Epichlorohydrin, which are known to the State of California to cause cancer, and Bisphenol, Ethylene Glycol, Ethylene Oxide, 1,3 Butadiene, Epichlorohydrin, which are known to the State of California to cause birth defects or other reproductive harm. For more information go to www.P65Warnings.ca.gov.

<p>P706-M</p> 	<p>Dual-Flow Lube Element with Bail Handle Notes: Inside-Out Flow Direction Fits: Mack Trucks Replaces: Mack 236GB311A; WGB S118CP O.D.: 7 1/2 (190.5) I.D.: 23/32 (18.3) Height: 14 15/16 (379.4) A. Gskt: [2] Attached O. Gskt: G157</p>	<p>PT716</p> 	<p>In-Line Hydraulic Filter Fits: Hyster, Toyota Lift Trucks Replaces: Hyster 313796, 1360557; Toyota 67502-20540-71 O.D.: 4 13/16 (122.2) Inlet: 1 Outlet: 1 Height: 7 7/8 (200.0) Related To: PT8435-MPG (Maximum Performance Glass Version with 25 PSI By-Pass Valve)</p>
<p>PT707-HD</p> 	<p>Hydraulic Element Fits: Allis Chalmers, Big Bud, Schroeder, WABCO Equipment Replaces: Allis Chalmers 1900201; Caterpillar 9Y4522; Komatsu 145-491-1580; Schroeder K-Series O.D.: 3 15/16 (100.0) I.D.: 1 19/32 (40.5) Height: 9 9/32 (235.7) O. Gskt: G417 Grommets: [2] Attached Related To: PT757, PT757-10 (Double-Length Versions)</p>	<p>PF717</p> 	<p>Fuel Element Fits: Daewoo, Ford, Gehl, John Deere, Kobelco, Komatsu, Kubota, Massey Ferguson, Mustang, New Holland, Takeuchi, Thomas, Yanmar Equipment Replaces: Ford SBA130366060; John Deere T111383; Kubota 15521-43160 O.D.: 1 31/32 (50.0) I.D.: 25/32 (19.8) Height: 3 1/2 (88.9)</p>
<p>PT707-HD10</p> 	<p>Hydraulic Element Fits: Bantam, Caterpillar, Lorain, Massey Ferguson, Schroeder Equipment Replaces: Allis Chalmers 1900201; Caterpillar 9Y4522; Komatsu 145-491-1580; Schroeder K-Series O.D.: 3 15/16 (100.0) I.D.: 1 19/32 (40.5) Height: 9 9/32 (235.7) O. Gskt: G417 Grommets: [2] Attached Related To: PT757, PT757-10 (Double-Length Versions)</p>	<p>P718-5</p> 	<p>Hydraulic Element Fits: Hilco Optional Housings O.D.: 6 (152.4) I.D.: 2 5/8 (66.7) Height: 16 (406.4) End Seals: [2] Attached</p>
<p>PT707-HD3</p> 	<p>Hydraulic Element Fits: Gardner Denver, Ingersoll-Rand, Timbco Equipment Replaces: Allis Chalmers 1900201; Caterpillar 9Y4522; Komatsu 145-491-1580; Schroeder K-Series O.D.: 3 15/16 (100.0) I.D.: 1 19/32 (40.5) Height: 9 9/32 (235.7) O. Gskt: G417 Grommets: [2] Attached Related To: PT757, PT757-10 (Double-Length Versions)</p>	<p>BF719</p> 	<p>Fuel Spin-on Fits: Iveco, R.V.I. Trucks Replaces: Renault 870175600, 947718018 Thread: 3/4 -16 O.D.: 3 11/16 (93.7) Height: 4 3/8 (111.1) I.Gskt: G324-A</p>
<p>PT708-HD</p> 	<p>Hydraulic Element Fits: Komatsu Equipment Replaces: Komatsu 281-16-11290 O.D.: 3 15/16 (100.0) I.D.: 1 5/8 (41.3) Height: 9 1/4 (235.0) End Seals: [2] Attached</p>	<p>BF720</p> 	<p>Fuel Spin-on Contains: Integral Post Seal Fits: Caterpillar, Kobelco, MDI, Mitsubishi Equipment Replaces: Caterpillar 96-6396; Kobelco 2451U-1722A; Mitsubishi ME035829 Thread: M20 x 1.5 O.D.: 3 11/16 (93.7) Height: 4 3/8 (111.1) I.Gskt: G324-A</p>
<p>P721</p> 	<p>Full-Flow Lube Element Fits: Claas Combines; M.A.N., R.V.I. Trucks; Mercedes-Benz Buses, Trucks; Zettelmeyer Equipment Replaces: Claas 1334990; M.A.N. 81-05504-0025; Mercedes-Benz 3521800209; Zettelmeyer 2132170 O.D.: 4 1/2 (114.3) I.D.: 2 1/4 (57.2) Height: 7 11/16 (195.3)</p>		

Measurements Are Shown In Inches And (Millimeters)

WARNING: These products can expose you to chemicals, including Diisononyl Phthalate, Carbon black extracts, Nickel, 1,3 Butadiene, Ethylene Oxide, Epichlorohydrin, which are known to the State of California to cause cancer, and Bisphenol, Ethylene Glycol, Ethylene Oxide, 1,3 Butadiene, Epichlorohydrin, which are known to the State of California to cause birth defects or other reproductive harm. For more information go to www.P65Warnings.ca.gov.

<p>PT722</p>  <p>Hydraulic Element Fits: Broyt Excavators; Poclain, Volvo Loaders Replaces: Volvo 6210359-3 O.D.: 4 31/32 (126.2) I.D.: 13/32 (10.3) & 3 5/8 (92.1) Height: 11 7/16 (290.5) Grommets: [1] Attached Related To: PT8414-MPG (Maximum Performance Glass Version)</p>	<p>PT727-HD10</p>  <p>Hydraulic Element Fits: Bomag, Schroeder Equipment Replaces: Schroeder A10 O.D.: 3 (76.2) I.D.: 1 (25.4) Height: 4 7/8 (123.8) O-Ring: [2] Attached</p>
<p>P723</p>  <p>Full-Flow Lube Element Contains: Reinforced Centertube Fits: Furukawa, Hino, Hitachi, Kawasaki, Kobelco, Koehring, Link-Belt, Sakai Equipment; Hino, Nissan Trucks; Isuzu Engines Replaces: Hino 15607-1410; Hitachi 4092039; Isuzu 1-87810-075-01; Nissan 15208-Z9025 O.D.: 3 15/16 (100.0) I.D.: 1/2 (12.7) & 2 1/4 (57.2) Height: 6 1/2 (165.1) F. Gskt: [2] Included</p>	<p>PT728-MPG</p>  <p>Maximum Performance Glass Hydraulic Element Fits: John Deere Equipment Replaces: John Deere AT67957 O.D.: 2 7/8 (73.0) I.D.: 1 1/8 (28.6) Height: 3 5/8 (92.1) A. Gskt: [2] Attached</p>
<p>PT725-MPG</p>  <p>Maximum Performance Glass Hydraulic Element Fits: Barber-Greene, John Deere Equipment Replaces: John Deere AT120544 O.D.: 4 1/2 (114.3) I.D.: 2 1/4 (57.2) One End Height: 9 11/16 (246.1) I.Gskt: [1] Included</p>	<p>PT729</p>  <p>Transmission Element Fits: Bobcat Loaders Replaces: Clark 233333 O.D.: 6 (152.4) I.D.: 2 5/32 (54.8) Height: 17 5/32 (435.8) I.Gskt: [2] Included F. Gskt: G206, [1] Included</p>
<p>PT727-DL</p>  <p>Double-Length Hydraulic Element Fits: Schroeder Equipment Replaces: Schroeder AA25 O.D.: 3 (76.2) I.D.: 1 (25.4) Height: 9 13/16 (249.2) O-Ring: [2] Included</p>	<p>BT732</p>  <p>Glass Hydraulic Spin-on Notes: Can be used with OB8711, OB8712, OB8720, OB8721, OB8722, OB8724, OB8731, OB8732, OB8741, OB8742, OB8743, OB8744, OB8745, OB8746 bases. Fits: Caterpillar Paving Equipment Replaces: Caterpillar 8T7478 Thread: 1 3/8 -12 O.D.: 3 3/4 (95.3) Height: 6 1/8 (155.6) I.Gskt: [1] Included</p>
<p>PT727-HD</p>  <p>Hydraulic Element Fits: Bomag, Schroeder Equipment Replaces: Schroeder A25 O.D.: 3 (76.2) I.D.: 1 (25.4) Height: 4 7/8 (123.8) O-Ring: [2] Attached</p>	<p>BT735</p>  <p>Hydraulic Spin-on Contains: 30 PSID By-Pass Valve Fits: Atlas-Weyhausen, Bomag, Demag, Kramer, Liebherr, Moxly, V.M.E., Volvo Equipment Replaces: Volvo 4787923-4 Thread: 1 -12 O.D.: 3 23/32 (94.5) Height: 8 7/32 (208.8) I.Gskt: G401 Related To: BT739 (with Adapter)</p>

Measurements Are Shown In Inches And (Millimeters)

WARNING: These products can expose you to chemicals, including Diisononyl Phthalate, Carbon black extracts, Nickel, 1,3 Butadiene, Ethylene Oxide, Epichlorohydrin, which are known to the State of California to cause cancer, and Bisphenol, Ethylene Glycol, Ethylene Oxide, 1,3 Butadiene, Epichlorohydrin, which are known to the State of California to cause birth defects or other reproductive harm. For more information go to www.P65Warnings.ca.gov.

PT737 Hydraulic Element
Fits: Ingersoll-Rand, Jaeger, Joy Equipment; Schroeder Hydraulic Systems
Replaces: Schroeder J25
O.D.: 3 17/32 (89.7)
I.D.: 1 5/8 (41.3)
Height: 9 1/4 (235.0)
End Seals: [2] Attached



C750-E 750 Size Depth-Pack By-Pass Lube Element with Bail Handle
Notes: To convert to spin-on, use OB1308 and B7577.
 C750-L has 1.5 pounds additional media.
Fits: Allis Chalmers, Clark, Demag, Fiat-Allis, Foden, Hymac, Komatsu, M.A.N., Steiger, Volvo Equipment; Luber-finer Model 750 Housing and All Model 750 Housings Except Stay Ready Housing
Replaces: Luber-finer 750, 750B, 750M1C, 2091, 3118, 3730
O.D.: 7 23/32 (196.1)
I.D.: 29/32 (23.0)
Height: 15 3/32 (383.4)
O. Gskt: ES1376, ES1377, G155, G157, G238, G252, G309-B
Related To: C750-L (1.5 pounds more media)
 F7500 (Fuel Version)
 P7500 (Extended Life Version)



PT737-10 Hydraulic Element
Fits: Ingersoll-Rand, Jaeger, Joy Equipment; Schroeder Hydraulic Systems
Replaces: Schroeder J10
O.D.: 3 17/32 (89.7)
I.D.: 1 5/8 (41.3)
Height: 9 1/4 (235.0)
End Seals: [2] Attached



C750-L 750 Size Vac-Cel By-Pass Lube Element with Bail Handle
Notes: To convert to spin-on, use OB1308 and B7577.
 C750-L has 1.5 pounds additional media.
Fits: Allis Chalmers, Clark, Demag, Fiat-Allis, Foden, Hymac, Komatsu, M.A.N., Steiger, Volvo Equipment; Luber-finer Model 750 Housing and All Model 750 Housings Except Stay Ready Housing
Replaces: Luber-finer 750, 750B, 750M1C, 2091, 3118, 3730
O.D.: 7 23/32 (196.1)
I.D.: 29/32 (23.0)
Height: 15 3/32 (383.4)
O. Gskt: ES1376, ES1377, G155, G157, G238, G252, G309-B
Related To: C750-E (Different amount of media)
 F7500 (Fuel Version)
 P7500 (Extended Life Version)



V738-O Vac-Cel Dual-Stage Full-Flow Lube Sock
Fits: Oliver, Winslow Equipment
Replaces: Joy 243211; Oliver 175526AS; Winslow CP738O
O.D.: 3 5/8 (92.1)
I.D.: 19/32 (15.1) & 1 1/16 (27.0)
Height: 7 3/16 (182.6)
F. Gskt: G127, [1] Included



C750-L SINGLE Individually Boxed Version of C750-L
Notes: To convert to spin-on, use OB1308 and B7577.
Fits: Allis Chalmers, Clark, Demag, Fiat-Allis, Foden, Hymac, Komatsu, M.A.N., Steiger, Volvo Equipment; Luber-finer Model 750 Housing and All Model 750 Housings Except Stay Ready Housing
Replaces: Luber-finer 750, 750B, 750M1C, 2091, 3118, 3730
O.D.: 7 23/32 (196.1)
I.D.: 29/32 (23.0)
Height: 15 3/32 (383.4)
O. Gskt: ES1376, ES1377, G155, G157, G238, G252, G309-B
Related To: F7500 (Fuel Version)
 P7500 (Extended Life Version)



BT739 Transmission Spin-on
Contains: 30 PSID By-Pass Valve
 Stud Thread: M24 x 1.5
Fits: Case, John Deere, Moxy Equipment
Replaces: John Deere AT102377, AT140030
Thread: 1 -12
O.D.: 3 23/32 (94.5)
Height: 8 7/8 (225.4)
I.Gskt: G401
Related To: BT735 (without Adapter)













C740-S Wound Cotton Glycol Sock
Replaces: Stay Ready SRPSP68
O.D.: 3 1/16 (77.8)
I.D.: 1 11/16 (42.9)
Height: 7 9/32 (184.9)















Measurements Are Shown In Inches And (Millimeters)

WARNING: These products can expose you to chemicals, including Diisononyl Phthalate, Carbon black extracts, Nickel, 1,3 Butadiene, Ethylene Oxide, Epichlorohydrin, which are known to the State of California to cause cancer, and Bisphenol, Ethylene Glycol, Ethylene Oxide, 1,3 Butadiene, Epichlorohydrin, which are known to the State of California to cause birth defects or other reproductive harm. For more information go to www.P65Warnings.ca.gov.

<p>PT751</p>  <p>Hydraulic Element Notes: Inside-Out Flow Direction Contains: Standpipe Fits: Hyster Lift Trucks Replaces: Hyster 190786 O.D.: 4 (101.6) I.D.: 1 1/4 (31.8) & 1 9/16 (39.7) Height: 14 7/8 (377.8) I.Gskt: [1] Included</p>	<p>PT760-10</p>  <p>Hydraulic Element Notes: Inside-Out Flow Direction Fits: Allis Chalmers, Case, Dresser, Galion, Massey Ferguson Equipment Replaces: Allis Chalmers 2698561; Case S232253; Galion D141064; Ingersoll-Rand 35290444 O.D.: 4 3/8 (111.1) I.D.: 23/32 (18.3) & 2 7/16 (61.9) Height: 8 (203.2) O. Gskt: G439 Grommets: [1] Attached</p>
<p>PT752</p>  <p>Hydraulic Element Contains: Reinforced Centertube Replaces: Clark 2526831 O.D.: 4 3/8 (111.1) I.D.: 2 13/32 (61.1) Height: 16 1/16 (408.0) A. Gskt: [2] Attached</p>	<p>PT760-25</p>  <p>Hydraulic Element Notes: Inside-Out Flow Direction Fits: Allis Chalmers, Galion, Ingersoll-Rand, Massey Ferguson Equipment Replaces: Galion D136601; Ingersoll-Rand 35328509; Massey Ferguson 1051399-M91 O.D.: 4 3/8 (111.1) I.D.: 23/32 (18.3) & 2 7/16 (61.9) Height: 8 (203.2) O. Gskt: G439 Grommets: [1] Attached</p>
<p>PT753</p>  <p>Hydraulic Element Fits: Case Equipment Replaces: Fairey-Arlon TXX12-R-10 O.D.: 8 (203.2) I.D.: 9/16 (14.3) & 6 3/16 (157.2) Height: 21 1/2 (546.1) I.Gskt: [1] Included F. Gskt: [2] Included</p>	<p>PT761</p>  <p>Hydraulic Element Fits: Ingersoll-Rand, Massey Ferguson Equipment Replaces: Ingersoll-Rand 35280825 O.D.: 4 3/8 (111.1) I.D.: 2 7/16 (61.9) Height: 8 1/16 (204.8) A. Gskt: [2] Attached</p>
<p>PT757</p>  <p>Hydraulic Element Fits: Schroeder Hydraulic Systems Replaces: Schroeder KK Series O.D.: 3 15/16 (100.0) I.D.: 1 19/32 (40.5) Height: 18 1/2 (469.9) Grommets: [2] Attached Related To: PT707, PT707-10 (Single-Length Versions)</p>	<p>PT763</p>  <p>Hydraulic Element Notes: Inside-Out Flow Direction Fits: Grove Cranes; Ingersoll-Rand Equipment Replaces: Grove 9437100156; Ingersoll-Rand 35997352 O.D.: 4 3/8 (111.1) I.D.: 23/32 (18.3) & 2 7/16 (61.9) Height: 16 1/16 (408.0) A. Gskt: [1] Attached Grommets: [1] Attached</p>
<p>PT757-10</p>  <p>Hydraulic Element Fits: Schroeder Hydraulic Systems Replaces: Schroeder KK Series O.D.: 3 15/16 (100.0) I.D.: 1 19/32 (40.5) Height: 18 1/2 (469.9) Grommets: [2] Attached Related To: PT707, PT707-10 (Single-Length Versions)</p>	<p>PT764</p>  <p>Hydraulic Element Fits: Ingersoll-Rand Compressors Replaces: Ingersoll-Rand 35280809 O.D.: 4 3/8 (111.1) I.D.: 2 13/32 (61.1) Height: 5 (127.0) A. Gskt: [2] Attached</p>



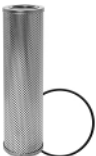









Measurements Are Shown In Inches And (Millimeters)

WARNING: These products can expose you to chemicals, including Diisononyl Phthalate, Carbon black extracts, Nickel, 1,3 Butadiene, Ethylene Oxide, Epichlorohydrin, which are known to the State of California to cause cancer, and Bisphenol, Ethylene Glycol, Ethylene Oxide, 1,3 Butadiene, Epichlorohydrin, which are known to the State of California to cause birth defects or other reproductive harm. For more information go to www.P65Warnings.ca.gov.













<p>PT765</p>  <p>Hydraulic Element Notes: Inside-Out Flow Direction Fits: Ingersoll-Rand Compressors Replaces: Ingersoll-Rand 50469055 O.D.: 4 3/8 (111.1) I.D.: 23/32 (18.3) & 2 13/32 (61.1) Height: 5 (127.0) A. Gskt: [1] Attached Grommets: [1] Attached</p>	<p>BT774</p>  <p>Hydraulic Spin-on Fits: Dresser, Hough Equipment Replaces: International 1106643-C1, 1106643-C2 Thread: 3 -8 O.D.: 5 (127.0) Height: 12 1/4 (311.2)</p>
<p>PT766</p>  <p>Hydraulic Element Notes: Inside-Out Flow Direction Fits: Case, Drott Equipment Replaces: Case S111605 O.D.: 4 3/8 (111.1) I.D.: 23/32 (18.3) & 2 13/32 (61.1) Height: 13 1/32 (331.0) A. Gskt: [1] Attached Grommets: [1] Attached</p>	<p>BT775</p>  <p>Hydraulic Spin-on Fits: Dresser, Hough Equipment Replaces: International 1103462-C1, 1103462-C2 Thread: 3 -8 O.D.: 5 (127.0) Height: 8 13/16 (223.8)</p>
<p>PT767</p>  <p>Hydraulic Element Notes: Inside-Out Flow Direction Fits: Case Equipment; Ingersoll-Rand Compressors Replaces: Ingersoll-Rand 50693886 O.D.: 4 3/8 (111.1) I.D.: 23/32 (18.3) & 2 7/16 (61.9) Height: 16 1/16 (408.0) A. Gskt: [1] Attached Grommets: [1] Attached</p>	<p>PT776-MPG</p>  <p>Maximum Performance Glass Hydraulic Element Notes: Inside-Out Flow Direction Replaces: Gardner Denver 2109093 O.D.: 4 3/8 (111.1) I.D.: 3/4 (19.1) & 2 7/16 (61.9) Height: 8 1/16 (204.8) A. Gskt: [1] Attached F. Gskt: [1] Washer O-Ring: [2] Included Grommets: [1] Attached</p>
<p>PT768</p>  <p>Hydraulic Element Notes: Inside-Out Flow Direction Fits: Case, New Holland, Versatile Tractors Replaces: Versatile 63297 O.D.: 4 13/32 (111.9) I.D.: 23/32 (18.3) & 2 7/16 (61.9) Height: 16 1/16 (408.0) A. Gskt: [1] Attached Grommets: [1] Attached</p>	<p>PT777</p>  <p>Hydraulic Element Notes: Inside-Out Flow Direction Replaces: Ingersoll-Rand 39123211 O.D.: 4 3/8 (111.1) I.D.: 5/8 (15.9) & 23/32 (18.3) Height: 8 (203.2) A. Gskt: [1] Attached O-Ring: [1] Included Grommets: [1] Attached</p>
<p>PT772</p>  <p>Hydraulic Element Notes: Inside-Out Flow Direction Fits: Case, Drott, Michigan Equipment Replaces: Case S111118; Clark 960641 O.D.: 4 3/8 (111.1) I.D.: 23/32 (18.3) & 2 13/32 (61.1) Height: 13 1/32 (331.0) A. Gskt: [1] Attached Grommets: [1] Attached</p>	<p>BT778</p>  <p>Hydraulic Spin-on Contains: 15 PSID Front-End Check Valve 30 PSID By-Pass Valve Fits: Allis Chalmers, Deutz Equipment Replaces: Deutz 4305722 Thread: 1 -12 O.D.: 3 11/16 (93.7) Height: 8 23/32 (221.5) I.Gskt: G381-A</p>
<p>PT773-MPG</p>  <p>Maximum Performance Glass Hydraulic Element Notes: Inside-Out Flow Direction Replaces: Ingersoll-Rand 35330133 O.D.: 4 3/8 (111.1) I.D.: 3/4 (19.0) & 2 7/16 (61.9) Height: 16 1/16 (408.0) A. Gskt: [1] Included O-Ring: [1] Included Grommets: [1] Attached</p>	<p>BT779</p>  <p>Transmission Spin-on Fits: Caterpillar Equipment Replaces: Caterpillar 9T1119 Thread: 13/16 -16 O.D.: 3 11/16 (93.7) Height: 2 29/32 (73.8) I.Gskt: G401</p>

Measurements Are Shown In Inches And (Millimeters)

WARNING: These products can expose you to chemicals, including Diisononyl Phthalate, Carbon black extracts, Nickel, 1,3 Butadiene, Ethylene Oxide, Epichlorohydrin, which are known to the State of California to cause cancer, and Bisphenol, Ethylene Glycol, Ethylene Oxide, 1,3 Butadiene, Epichlorohydrin, which are known to the State of California to cause birth defects or other reproductive harm. For more information go to www.P65Warnings.ca.gov.

<p>BF781</p>  <p>Primary Fuel Spin-on with Drain Notes: Can be used with FB1301 base. Contains: Drain Hose Adapter Fits: GMC Buses, Light-Duty Trucks, Vans; Detroit Diesel Engines; Generac RV Generators Replaces: GMC 25011285 Thread: 1 -12 O.D.: 3 11/16 (93.7) Height: 6 1/8 (155.6) I.Gskt: [1] Included</p>	<p>BF788</p>  <p>Secondary Fuel Spin-on Notes: CAUTION: Furnished O-Ring must be installed on post for seal. Contains: Standpipe Fits: Case, Consolidated Diesel, Cummins Engines; Komatsu Equipment Replaces: Case J903640; Cummins 3903640 Thread: M16 x 1.5 O.D.: 3 1/32 (77.0) Height: 4 27/32 (123.0) I.Gskt: G449-B O-Ring: [1] Included</p>
<p>BF782</p>  <p>Secondary Fuel Spin-on Contains: Integral Post Seal Fits: GMC Buses, Light-Duty Trucks, Vans; Detroit Diesel Engines Replaces: GMC 25011214 Thread: M16 x 1.5 O.D.: 3 (76.2) Height: 4 27/32 (123.0) I.Gskt: G449-B</p>	<p>BF789</p>  <p>Fuel Spin-on Fits: Ford Light-Duty Trucks; Gehl, John Deere, Kohler, Thomas, Westerbeke Equipment Replaces: Ford E3TZ-9155-B Thread: M20 x 1.5 O.D.: 3 11/16 (93.7) Height: 3 7/8 (98.4) I.Gskt: G381-A</p>
<p>BF783</p>  <p>Secondary Fuel Spin-on Fits: Allis Chalmers, Astra, Benfra, Fiat-Allis, New Holland Equipment; Iveco Buses, Engines, Trucks Replaces: Fiat 1909103 Thread: 3/4 -16 O.D.: 4 1/4 (108.0) Height: 7 11/32 (186.5) I.Gskt: G381-A</p>	<p>BF790</p>  <p>Fuel Spin-on Fits: Atlas Copco, Bandit, Bobcat, Bomag, Case, Demag, Ditch Witch, Dynapac, Grove, International, Manitou, Vermeer, Volvo Equipment; Deutz, MWM Engines Replaces: Bosch 1-457-434-069; Deutz 1161341; Melroe-Bobcat 4121609 Thread: M16 x 1.5 O.D.: 3 1/32 (77.0) Height: 3 15/32 (88.1) I.Gskt: G449-B Related To: BF7915 (Short Version)</p>
<p>BF784</p>  <p>Primary Fuel Spin-on Notes: Can be used with FB1309 base. Contains: Integral Post Seal Fits: American Hoist & Derrick, Demag, Dresser, Komatsu, Terex Equipment; Detroit Diesel Engines Replaces: Detroit Diesel 23518528 Thread: 1 1/4 -12 O.D.: 4 21/32 (118.3) Height: 9 1/2 (241.3) I.Gskt: [1] Included</p>	<p>BF791</p>  <p>Fuel/Water Separator Spin-on Fits: Crusader, Mercruiser, Volvo-Penta Engines Replaces: Mercruiser 3560494 Thread: 11/16 -16 O.D.: 3 11/16 (93.7) Height: 3 7/8 (98.4) I.Gskt: G381-A</p>
<p>BF785</p>  <p>Secondary Fuel Spin-on Notes: Can be used with FB1310 base. Contains: Integral Post Seal Fits: American Hoist & Derrick, Demag, Dresser, Komatsu, Terex Equipment; Detroit Diesel Engines Thread: 1 1/16 -16 O.D.: 4 21/32 (118.3) Height: 9 1/2 (241.3) I.Gskt: [1] Included</p>	<p>BF791-O</p>  <p>Fuel/Water Separator with Open Port for Bowl Contains: Port Thread: 3 1/4-10 Fits: Quicksilver Outboard Applications Replaces: Racor S3213 Thread: 11/16 -16 O.D.: 3 25/32 (96.0) Height: 4 1/32 (102.4) F. Gskt: [2] Included O-Ring: [1] Included</p>
<p>BF786</p>  <p>Fuel Spin-on Contains: Integral Post Seal Fits: Ford Light-Duty Trucks, Vans; International Diesel Engines Replaces: International 1804459-C1 Thread: 7/8 -14 O.D.: 4 1/4 (108.0) Height: 4 11/16 (119.1) I.Gskt: G381-A</p>	<p>BF792</p>  <p>Fuel Spin-on Contains: Integral Post Seal Fits: Caterpillar, Kobelco, MDI, Mitsubishi Equipment Replaces: Mitsubishi ME016823 Thread: M20 x 1.5 O.D.: 3 23/32 (94.5) Height: 3 7/8 (98.4) I.Gskt: G324-A</p>

Measurements Are Shown In Inches And (Millimeters)
WARNING: These products can expose you to chemicals, including Diisononyl Phthalate, Carbon black extracts, Nickel, 1,3 Butadiene, Ethylene Oxide, Epichlorohydrin, which are known to the State of California to cause cancer, and Bisphenol, Ethylene Glycol, Ethylene Oxide, 1,3 Butadiene, Epichlorohydrin, which are known to the State of California to cause birth defects or other reproductive harm. For more information go to www.P65Warnings.ca.gov.

<p>BF794 In-Line Fuel Filter Fits: Chrysler Automotive, Vans Replaces: Chrysler 4443462 O.D.: 2 5/32 (54.8) Inlet: 5/16 Outlet: 5/16 Length: 4 (101.6)</p> 	<p>PF804 Fuel Element Fits: Detroit Diesel Engines; Gorman Rupp Pumps Replaces: GMC 6438498 O.D.: 3 7/16 (87.3) I.D.: 7/16 (11.1) & 1/2 (12.7) Height: 5 23/32 (145.3) F. Gskt: [1] Included Grommets: [2] Attached</p> 
<p>BF795 In-Line Fuel Filter Fits: Chrysler Automotive, Vans Replaces: Chrysler 4443463 O.D.: 2 5/16 (58.7) Inlet: 5/16 Outlet: 5/16 Length: 4 11/32 (110.3)</p> 	<p>BF805 In-Line Fuel Filter Fits: Chevrolet, GEO, Isuzu, Subaru, Toyota Automotive, Light-Duty Trucks, Vans Replaces: Toyota 23300-34100 O.D.: 3 1/8 (79.4) Inlet: 5/16 Outlet: 5/16 Length: 2 1/4 (57.2)</p> 
<p>BF797 Fuel Spin-on Fits: Iveco, R.V.I. Trucks Replaces: Renault 3036404 Thread: 3/4 -16 O.D.: 3 11/16 (93.7) Height: 5 3/8 (136.5) I.Gskt: G381-A</p> 	<p>BF806 Box-Style Fuel/Water Separator Fits: Buick, Cadillac, Chevrolet, Oldsmobile, Pontiac Diesel Automotive, Light-Duty Trucks, Vans; GMC Light-Duty Diesel Trucks Replaces: GMC 25010487 Inlet: 3/8 Outlet: 1/4 Length: 4 3/8 (111.1) Width: 3 9/32 (83.3) Height: 2 5/8 (66.7)</p> 
<p>BF798 Fuel Spin-on Contains: Integral Post Seal Fits: Case, Caterpillar, Hitachi, Kobelco, Link-Belt, Mitsubishi, Tadano Equipment Replaces: Caterpillar 96-9625; Kobelco 2451U-2112; Mitsubishi ME056280 Thread: M24 x 1.5 O.D.: 3 11/16 (93.7) Height: 6 9/16 (166.7) I.Gskt: [1] Included</p> 	<p>PF807 Fuel Element Fits: John Deere Tractors Replaces: John Deere AT11929T, AT20541T O.D.: 3 1/32 (77.0) I.D.: 23/32 (18.3) One End Height: 4 (101.6) F. Gskt: [1] Included Grommets: [1] Attached</p> 
<p>BF799 Fuel Spin-on Contains: Integral Post Seal Fits: Caterpillar Equipment Replaces: Caterpillar 1R0715, 8N3080 Thread: 1 3/8 -16 O.D.: 5 3/8 (136.5) Height: 12 3/32 (307.2) I.Gskt: [1] Included</p> 	<p>PF809 Fuel Element with Bail Handle Fits: Allis Chalmers, Case, Caterpillar, Continental, Euclid, Massey Ferguson, Oliver Equipment Replaces: Allis Chalmers 43711640; Case 73220; Massey Ferguson 1006589-M92 O.D.: 4 7/32 (107.2) I.D.: 1/2 (12.7) Height: 4 7/8 (123.8) F. Gskt: G104 Grommets: [2] Attached Related To: P41 (By-Pass Lube Version)</p> 
<p>PF802 Fuel Element Fits: Allis Chalmers Tractors; Detroit Diesel Engines Replaces: Allis Chalmers 853361; GMC 853695 O.D.: 2 7/8 (73.0) I.D.: 1/2 (12.7) & 1 (25.4) Height: 4 7/32 (107.2) A. Gskt: [2] Attached F. Gskt: [1] Included</p> 	<p>PF810 Fuel Element Fits: Allis Chalmers, Caterpillar, Clark, Waukesha Engines, Equipment Replaces: Allis Chalmers 43711650; Clark 944475; Waukesha 151137 O.D.: 3 (76.2) I.D.: 1 1/16 (27.0) Height: 7 13/16 (198.4) A. Gskt: [2] Attached F. Gskt: [3] Included O. Gskt: G344</p> 

Measurements Are Shown In Inches And (Millimeters)

WARNING: These products can expose you to chemicals, including Diisononyl Phthalate, Carbon black extracts, Nickel, 1,3 Butadiene, Ethylene Oxide, Epichlorohydrin, which are known to the State of California to cause cancer, and Bisphenol, Ethylene Glycol, Ethylene Oxide, 1,3 Butadiene, Epichlorohydrin, which are known to the State of California to cause birth defects or other reproductive harm. For more information go to www.P65Warnings.ca.gov.

PF811 Fuel Element with Bail Handle
Fits: Kawasaki Loaders; Komatsu Equipment
Replaces: Komatsu 6610-72-8600
O.D.: 5 (127.0)
I.D.: 3 1/32 (24.6)
Height: 9 31/32 (253.2)
F. Gskt: [1] Included
Grommets: [2] Attached



PF818 Fuel Element
Fits: Bennett Fuel Pumps
Replaces: Bennett A3119
O.D.: 2 1/4 (57.2)
I.D.: 1 1/16 (27.0) One End
Height: 3 31/32 (100.8)
A. Gskt: [1] Attached



BF812 Can-Type Fuel Filter
Fits: Massey Ferguson Equipment; Perkins Engines
Replaces: Massey Ferguson 1896202-M91; Perkins 26560097
O.D.: 3 15/32 (88.1)
I.D.: 3/4 (19.0)
Height: 5 13/32 (137.3)
F. Gskt: [2] Included
O-Ring: [2] Included
End Seals: [1] Attached
Related To: BF825, BF874, BF884 (Short Versions)



PF819 Fuel Element
Fits: Mack Engines, Trucks
Replaces: Mack 237GB13
O.D.: 3 15/16 (100.0)
I.D.: 7/8 (22.2)
Height: 6 7/32 (158.0)
A. Gskt: [2] Attached
F. Gskt: G106, [1] Included



PF814 Fuel Element
Fits: John Deere Equipment
Replaces: John Deere AR28611R, AR44077
O.D.: 3 7/16 (87.3)
I.D.: 23/32 (18.3) One End
Height: 4 3/16 (106.4)
F. Gskt: [1] Included
O. Gskt: G406
Grommets: [1] Attached



PF820-S Fuel Element
Fits: David Brown, Massey Ferguson Equipment; Dorman, Lister, Perkins, Petter Engines
Replaces: Dorman 73130020; Massey Ferguson 1845766-M1; Perkins 26540183
O.D.: 2 7/8 (73.0)
I.D.: 1 5/16 (33.3)
Height: 3 5/16 (84.1)
F. Gskt: G147-A, G161
Related To: P176 (Full-Flow Lube Version)



PF816 Fuel Element
Fits: Ford, Perkins, Westerbeke Marine Engines; J.C. Bamford, Landini, Massey Ferguson Equipment
Replaces: Ford EPN-99062-A; Massey Ferguson 1850450-M2
O.D.: 2 15/16 (74.6)
I.D.: 1 1/4 (31.8)
Height: 3 1/8 (79.4)
F. Gskt: G147-A, G161, [1] Included
End Seals: [2] Attached



PF821-S Fuel Element
Fits: Flexible, Ford, International Trucks; Cummins Engines; Euclid, Hough, Michigan, Oliver Equipment
Replaces: Allis Chalmers BM33761; Cummins BM33761; Ford EDL-9176-A; International 3054750-R91
O.D.: 3 15/16 (100.0)
I.D.: 23/32 (18.3)
Height: 4 13/16 (122.2)
F. Gskt: G104
End Seals: [2] Included



PF816-S Fuel Element
Fits: Atlas Copco Compressors; Ford, Perkins Engines; Hymac, Hyster, Massey Ferguson, Timberjack Equipment
Replaces: Ford E1ADDN-99162-B2; Hyster 985220; Perkins 30497; Timberjack 402540
O.D.: 2 7/8 (73.0)
I.D.: 15/16 (23.8)
Height: 3 1/16 (77.8)
F. Gskt: G147-A



PF822 Fuel Element
Fits: Cummins Engines; Euclid, P & H Harnischfeger Equipment
Replaces: Cummins C44758; Mack 236GB238; White 609673FS
O.D.: 3 15/16 (100.0)
I.D.: 1 1/16 (27.0)
Height: 5 31/32 (151.6)
F. Gskt: G106
End Seals: [2] Included
Related To: P82 (Lube Version) PT243, PT82-HD10 (Hydraulic Versions)



Measurements Are Shown In Inches And (Millimeters)

WARNING: These products can expose you to chemicals, including Diisononyl Phthalate, Carbon black extracts, Nickel, 1,3 Butadiene, Ethylene Oxide, Epichlorohydrin, which are known to the State of California to cause cancer, and Bisphenol, Ethylene Glycol, Ethylene Oxide, 1,3 Butadiene, Epichlorohydrin, which are known to the State of California to cause birth defects or other reproductive harm. For more information go to www.P65Warnings.ca.gov.

PF823

Fuel Element



Contains: Reinforced Centertube
Fits: Bucyrus-Erie, Caterpillar, Clark, Gardner Denver Equipment; Kenworth, Peterbilt Trucks
Replaces: Caterpillar 9H4729, 9H8792, 9M9641
O.D.: 3 5/16 (84.1)
I.D.: 1 1/16 (27.0)
Height: 6 1/2 (165.1)
A. Gskt: [2] Attached
F. Gskt: [2] 7B-7635
Related To: PF824 (Different Gasket)

PF826

Fuel Element



Contains: Reinforced Centertube
Fits: Mack Trucks
Replaces: Mack 237GB29, 237GB29-A
O.D.: 3 15/16 (100.0)
I.D.: 1 1/16 (27.0)
Height: 6 1/4 (158.8)
A. Gskt: [2] Attached
F. Gskt: [1] Included

PF823-E

Fuel Element



Contains: Reinforced Centertube
Fits: Caterpillar, DMI, Unit Rig, WABCO Equipment
Replaces: Caterpillar 4H8792
O.D.: 3 5/16 (84.1)
I.D.: 1 1/16 (27.0)
Height: 6 1/2 (165.1)
A. Gskt: [2] Attached
Related To: PF823 (with Furnished Gaskets)

PF827

Fuel Element



Fits: Chrysler, GM Automotive, Light-Duty Trucks; Ford, International Heavy-Duty Trucks; Hobart, Huber, Hyster, International, Lorain, New Holland Equipment; Waukesha Engines
Replaces: Clark 999478; GMC 854606; Hyster 97372; International 998429-R91; New Holland 500660; Versatile 608T119
O.D.: 2 1/16 (52.4)
I.D.: 7/16 (11.1)
Height: 3 15/32 (88.1)
F. Gskt: G204-A
Grommets: [1] Attached

PF824

Fuel Element



Contains: Reinforced Centertube
Fits: American Hoist & Derrick, Caterpillar, Gardner Denver, Gradall, Koehring, Link-Belt Equipment; Atlas Copco Compressors; Caterpillar Diesel Engines, Trucks; Clark Shovels
Replaces: Caterpillar 9H4729
O.D.: 3 5/16 (84.1)
I.D.: 1 1/16 (27.0)
Height: 6 1/2 (165.1)
A. Gskt: [2] Attached
F. Gskt: 5M-954
O. Gskt: 1S-9133 (For use with Stacked Elements)
Related To: PF823 (Different Gaskets)

PF828

Secondary Fuel Element



Fits: Clark, Galion, Hough, International, Massey Ferguson Equipment; International, Mack Engines
Replaces: Galion 85832; International 610309-C91; Mack 483GB215
O.D.: 3 3/16 (81.0)
I.D.: 1 1/16 (27.0)
Height: 4 1/2 (114.3)
A. Gskt: [2] Attached
F. Gskt: G106

BF825

Can-Type Fuel Filter



Fits: Agco, Akerman, Allis Chalmers, Bobcat, Case, Caterpillar, Fiat, Ford, Hesston, International, J.C. Bamford, John Deere, Kubota, Massey Ferguson, New Holland, Oliver, Perkins, White Equipment
Replaces: Allis Chalmers 1919100; Case K915319; Ford E7NN-9176-AA; International 757836-R91; Massey Ferguson 1013891-M1; New Holland 505776; Perkins 868014
O.D.: 3 7/16 (87.3)
I.D.: 3/4 (19.0)
Height: 2 13/16 (71.4)
F. Gskt: ES1049, [2] G233-A, G233-B
O-Ring: [1] Included
O. Gskt: ES3063 (IHC Installations)
Related To: BF812, BF874, BF884 (Long Versions)

PF829(2)

Set of 2 Fuel Elements



Contains: Reinforced Centertube
Fits: Caterpillar Equipment
Replaces: Caterpillar 9H1252
O.D.: 3 5/16 (84.1)
I.D.: 1 1/16 (27.0)
Height: 6 1/2 (165.1)
A. Gskt: [2] Attached on Each Element
F. Gskt: [1] Included

BF830

In-Line Fuel Filter



Notes: OBSOLETE. Availability Limited to Dealer Stock.
Fits: Subaru Automotive
Replaces: Subaru 74207-2040
O.D.: 3 3/16 (81.0)
Inlet: 5/16
Outlet: 5/16
Length: 5 1/8 (130.2)

Measurements Are Shown In Inches And (Millimeters)

WARNING: These products can expose you to chemicals, including Diisononyl Phthalate, Carbon black extracts, Nickel, 1,3 Butadiene, Ethylene Oxide, Epichlorohydrin, which are known to the State of California to cause cancer, and Bisphenol, Ethylene Glycol, Ethylene Oxide, 1,3 Butadiene, Epichlorohydrin, which are known to the State of California to cause birth defects or other reproductive harm. For more information go to www.P65Warnings.ca.gov.

PF831 Fuel Element
Fits: ERF Trucks; Gardner Denver Compressors; Leyland Buses, Trucks; Lister, Rolls-Royce Diesel Engines
Replaces: Gardner Denver GFF310; Leyland GRS05516; Rolls-Royce OD3928; Transicold 25-50110-09
O.D.: 2 7/8 (73.0)
I.D.: 1 5/16 (33.3)
Height: 5 1/2 (139.7)
F. Gskt: [1] Included



BF833 In-Line Fuel Filter
Fits: Dodge, Jeep, Nissan Automotive; Bobcat, Case, Caterpillar, Gehl, Grove, John Deere, Mitsubishi, New Holland Equipment
Replaces: Case D59949; Caterpillar 9Y4444; Chrysler 2455808; GMC 25055223; John Deere AM116178, AM116304; Mitsubishi MB554970; New Holland 269212; Nissan 16400-A0600, 16400-A0601
O.D.: 1 29/32 (48.4)
Inlet: 1/4
Outlet: 1/4
Length: 4 1/16 (103.2)



BF833-K2 In-Line Fuel Filter with Clamps and Hoses
Contains: [4] Clamps
 [2] Hoses
Fits: Dodge, Jeep, Nissan Automotive; Bobcat, Case, Caterpillar, Gehl, Grove, John Deere, Mitsubishi, New Holland Equipment
Replaces: Case D59949; Caterpillar 9Y4444; Chrysler 2455808; GMC 25055223; John Deere AM116178, AM116304; Mitsubishi MB554970; New Holland 269212; Nissan 16400-A0600, 16400-A0601
O.D.: 1 29/32 (48.4)
Inlet: 1/4
Outlet: 1/4
Length: 4 1/16 (103.2)



F834-F Felt Fuel Element with Handle
Fits: Mercedes-Benz, R.V.I. Buses, Trucks
Replaces: Mercedes-Benz 3524700092
O.D.: 2 11/16 (68.3)
I.D.: 29/32 (23.0)
Height: 4 1/2 (114.3)
F. Gskt: [1] Included
Grommets: [2] Attached



PF834 Fuel Element with Bail Handle
Fits: Deutz, Mercedes-Benz Diesel Engines; M.A.N. Buses, Trucks
Replaces: Deutz Q05H4115; Mercedes-Benz 926901
O.D.: 2 9/16 (65.1)
I.D.: 1/2 (12.7)
Height: 4 9/32 (108.7)
F. Gskt: [2] Included
O. Gskt: G233-B
Grommets: [2] Attached



BF836 In-Line Fuel Filter
Fits: GMC Engines
Replaces: GMC 25055360
O.D.: 1 29/32 (48.4)
Inlet: 3/8
Outlet: 3/8
Length: 3 7/8 (98.4)



BF836-K3 In-Line Fuel Filter with Clamps and Hoses
Contains: [4] Clamps
 [2] Hoses
Fits: GMC Engines
Replaces: GMC 25055360
O.D.: 1 29/32 (48.4)
Inlet: 3/8
Outlet: 3/8
Length: 3 7/8 (98.4)



BF836-K4 In-Line Fuel Filter with Clamps
Contains: [4] Clamps
Fits: GMC Engines
Replaces: GMC 25055360
O.D.: 1 29/32 (48.4)
Inlet: 3/8
Outlet: 3/8
Length: 3 7/8 (98.4)



BF837 In-Line Fuel Filter
Fits: Ford, Honda, Mazda, Subaru, Toyota Automotive, Light-Duty Trucks
Replaces: Ford E8BZ-9155-A; GMC 25055660; Honda 16900-SA-5000; Mazda E508-13-470
O.D.: 4 1/16 (103.2)
Inlet: 5/16
Outlet: 5/16
Length: 2 5/16 (58.7)



BF838-F2 Can-Type Fuel Filter
Fits: Case, Ford, Minneapolis-Moline, Oliver, White Equipment
Replaces: Case A39937; Ford C3TZ-9365-B; Stanadyne 26001A; White 609689FS
O.D.: 3 7/16 (87.3)
I.D.: 3/4 (19.0)
Height: 2 13/16 (71.4)
F. Gskt: [2] Included
O-Ring: [1] Included



PF838 Fuel Element
Fits: Carrier-Transicold Refrigeration Units; David Brown, International, Massey Ferguson, Oliver Equipment; Perkins, Rolls-Royce Engines
Replaces: Carrier-Transicold 11649; David Brown 62594; International 844644-R91; Massey Ferguson 1021351-M1; Perkins 33425
O.D.: 3 5/16 (84.1)
I.D.: 5/8 (15.9) & 13/16 (20.6)
Height: 2 3/4 (69.9)
A. Gskt: [1] Included
F. Gskt: G153
O-Ring: [1] Included



Measurements Are Shown In Inches And (Millimeters)

WARNING: These products can expose you to chemicals, including Diisononyl Phthalate, Carbon black extracts, Nickel, 1,3 Butadiene, Ethylene Oxide, Epichlorohydrin, which are known to the State of California to cause cancer, and Bisphenol, Ethylene Glycol, Ethylene Oxide, 1,3 Butadiene, Epichlorohydrin, which are known to the State of California to cause birth defects or other reproductive harm. For more information go to www.P65Warnings.ca.gov.

BT839



Hydraulic Spin-on

Notes: Can be used with OB1317, OB1318, OB1319, OB1320 bases.

Fits: Bobcat, Ford, Toro, Vermeer, Versatile Equipment; Cross, Gresen, Michigan Fluid Power Hydraulic Systems

Replaces: Cross 1A9023; Gresen 8057000; Michigan Fluid Power 201026

Thread: 1 -12

O.D.: 3 11/16 (93.7)

Height: 5 13/32 (137.3)

I.Gskt: G401

Related To: BT452 (with By-Pass Valve)
BT8420 (Stainless Steel Mesh Version)
BT8428-MPG (Maximum Performance Glass Version)

BT839-10



Hydraulic Spin-on

Notes: Can be used with OB1317, OB1318, OB1319, OB1320 bases.

Fits: Bobcat, Ford, Toro, Vermeer, Versatile Equipment; Cross, Gresen, Michigan Fluid Power Hydraulic Systems

Replaces: Cross 1A9023; Gresen 8057000; Michigan Fluid Power 201026

Thread: 1 -12

O.D.: 3 11/16 (93.7)

Height: 5 13/32 (137.3)

I.Gskt: G401

Related To: BT452 (with By-Pass Valve)
BT8420 (Stainless Steel Mesh Version)
BT8428-MPG (Maximum Performance Glass Version)

BF840



In-Line Fuel Filter

Fits: Chrysler, GMC Automotive; Case, International, Massey Ferguson Equipment

Replaces: Chrysler 5214626; Ford A780X-9155-AA; GMC 94020398; Isuzu 8-78107-910; Case D139225; Massey Ferguson 800848-M91

O.D.: 1 29/32 (48.4)

Inlet: 5/16

Outlet: 5/16

Length: 4 5/32 (105.6)

Related To: BF840-K1 (w/Clamps, Hoses)
BF7736 (Plastic Version)

BF840-K1



In-Line Fuel Filter with Clamps and Hoses

Contains: [4] Clamps
[2] Hoses

Fits: Chrysler, GMC Automotive; Case, International, Massey Ferguson Equipment

Replaces: Chrysler 5214626; Ford A780X-9155-AA; GMC 94020398; Isuzu 8-78107-910; Massey Ferguson 800848-M91

O.D.: 1 29/32 (48.4)

Inlet: 5/16

Outlet: 5/16

Length: 4 5/32 (105.6)

Related To: BF840 (Filter Only)
BF7736 (Plastic Version)

VT842-O



Off-Highway Vac-Cel Full-Flow Lube Sock

Fits: Oliver, White Equipment; Waukesha Engines

Replaces: Oliver 156149AS; Waukesha 493009; White 872946

O.D.: 3 1/8 (79.4)

I.D.: 1 1/16 (27.0)

Height: 7 3/4 (196.9)

F. Gskt: G115-A, G243-A

O. Gskt: G127

Related To: V852-O (By-Pass Version)

BF843



In-Line Fuel Filter

Fits: Ford Automotive; John Deere, Melroe Equipment

Replaces: Ford C0DZ-9155-A; John Deere T19743T

O.D.: 2 (50.8)

Inlet: 1/8-27

Outlet: 1/2-20

Length: 3 7/16 (87.3)

F844-A



Cotton and Fiber Primary Fuel Sock

Notes: To convert to spin-on, use FB1309 base and BF784.

Fits: Detroit Diesel Engines

Replaces: GMC 5574980, 6438518

O.D.: 4 (101.6)

I.D.: 1 1/2 (38.1)

Height: 9 (228.6)

F. Gskt: ES1001, G115-A

F845-A



Automatic Wound Sisal Primary Fuel Sock

Notes: To convert to spin-on, use FB1301 base and BF5800.

Contains: Reinforced Centertube

O.D.: 2 7/8 (73.0)

I.D.: 1 1/4 (31.8)

Height: 8 7/16 (214.3)

F. Gskt: ES1034, [2] Included

PF845



Primary Fuel Element

Notes: To convert to spin-on, use FB1301 base and BF5800.

Contains: Reinforced Centertube

Fits: GMC, International, Mack, Peterbilt, Western Star Buses, Trucks

Replaces: GMC 9717391; International 998446-R91

O.D.: 2 7/8 (73.0)

I.D.: 13/32 (10.3) & 1 3/16 (30.2)

Height: 8 5/16 (211.1)

A. Gskt: [2] Attached

F. Gskt: [3] Included

Measurements Are Shown In Inches And (Millimeters)

WARNING: These products can expose you to chemicals, including Diisononyl Phthalate, Carbon black extracts, Nickel, 1,3 Butadiene, Ethylene Oxide, Epichlorohydrin, which are known to the State of California to cause cancer, and Bisphenol, Ethylene Glycol, Ethylene Oxide, 1,3 Butadiene, Epichlorohydrin, which are known to the State of California to cause birth defects or other reproductive harm. For more information go to www.P65Warnings.ca.gov.

PF846 Secondary Fuel Element
Notes: To convert to spin-on, use FB1310 base and BF785.
Fits: Detroit Diesel Engines
Replaces: GMC 6437284
O.D.: 4 17/32 (115.1)
I.D.: 1 11/16 (17.5)
Height: 8 1/4 (209.6)
A. Gskt: [1] Attached
F. Gskt: ES1034, G143
Grommets: [2] Attached



PF847 Fuel Element
Fits: J.C. Bamford Equipment; Lister, Petter Engines
Replaces: J.C. Bamford S1246; Lister 201-13117; Petter 284539
O.D.: 2 1/4 (57.2)
I.D.: 9/32 (7.1) & 27/32 (21.4)
Height: 1 15/32 (37.3)
F. Gskt: G103, [3] Included



PT849 Hydraulic Element
Fits: Case, Caterpillar, Clark, Hough, International, John Deere, Michigan, New Holland Equipment
Replaces: Case F88379; Clark 789644; International 876949-C91; John Deere AE25453; New Holland 270565
O.D.: 2 7/8 (73.0)
I.D.: 7/16 (11.1) & 1 3/16 (30.2)
Height: 4 3/8 (111.1)
A. Gskt: [1] Attached
F. Gskt: G255
Grommets: [1] Attached



PT849-10 Hydraulic Element
Fits: Case, Caterpillar, Clark, Hough, International, John Deere, Michigan, New Holland Equipment
Replaces: Case F88379; Caterpillar 5J8879; Clark 789644; International 876949-C91; John Deere AE25453; New Holland 270565
O.D.: 2 7/8 (73.0)
I.D.: 7/16 (11.1) & 1 3/16 (30.2)
Height: 4 3/8 (111.1)
A. Gskt: [1] Attached
F. Gskt: G255
Grommets: [1] Attached



V852-O Vac-Cel By-Pass Lube Sock
Fits: Oliver Equipment
Replaces: Oliver 165928AS
O.D.: 4 1/8 (104.8)
I.D.: 1 1/16 (27.0)
Height: 8 (203.2)
F. Gskt: G115-A
Related To: V842-O (Full-Flow Version)



BF853 In-Line Fuel Filter
Fits: GMC, Jaguar, Land Rover Automotive, Light-Duty Trucks
Replaces: GMC 25171792
O.D.: 2 5/16 (58.7)
Inlet: M16 x 1.5
Outlet: M16 x 1.5
Length: 4 7/16 (112.7)



BF855 Box-Style Secondary Fuel/Water Separator
Fits: GMC Light-Duty Trucks; Onan Engines
Replaces: GMC 25011763; Joy 19005224; Stanadyne 23248
Length: 4 5/8 (117.5)
Width: 2 27/32 (72.2)
Height: 2 15/32 (62.7)
F. Gskt: [1] Included



BF856 Box-Style Fuel/Water Separator
Fits: GMC Light-Duty Trucks with Diesel Engines
Replaces: GMC 10149549; Stanadyne 24262
Length: 6 11/32 (161.1)
Width: 3 9/32 (83.3)
Height: 2 21/32 (67.5)
Grommets: [4] Attached



PF857 Fuel Element
Fits: Ford, GMC Automotive, Light-Duty Trucks; Gray, Mercruiser Marine Engines
Replaces: Ford B5A-9365-A; GMC 854982; Gray G80084
O.D.: 1 3/4 (44.4)
I.D.: 15/32 (11.9)
Height: 1 1/16 (27.0)
F. Gskt: [1] Included



BF858 In-Line Fuel Filter
Fits: Cadillac Automotive
Replaces: GMC 5651944
O.D.: 2 9/32 (57.9)
Inlet: 5/8-18
Outlet: 3/8
Length: 4 3/4 (120.7)



PF859 Fuel Element
Fits: AMC, Dodge, Ford, International, Jeep Light-Duty Trucks; Interceptor, Mercruiser, Palmer Marine Engines; International Equipment
Replaces: Chrysler 3173674; Ford C3TA-9162-A; International 918472-R1; Jeep J8990953; Mercruiser B3549088
O.D.: 1 3/8 (34.9)
I.D.: 9/16 (14.3) One End
Height: 1 7/8 (47.6)
F. Gskt: [2] Included













PF860 Fuel Element
Fits: GMC, White Trucks
Replaces: GMC 854435; White 871646
O.D.: 2 7/8 (73.0)
I.D.: 17/32 (13.5)
Height: 2 1/8 (54.0)
A. Gskt: [2] Attached
F. Gskt: [1] Included



Measurements Are Shown In Inches And (Millimeters)

WARNING: These products can expose you to chemicals, including Diisononyl Phthalate, Carbon black extracts, Nickel, 1,3 Butadiene, Ethylene Oxide, Epichlorohydrin, which are known to the State of California to cause cancer, and Bisphenol, Ethylene Glycol, Ethylene Oxide, 1,3 Butadiene, Epichlorohydrin, which are known to the State of California to cause birth defects or other reproductive harm. For more information go to www.P65Warnings.ca.gov.

<p>PF861</p>  <p>Fuel Element Fits: Datsun, Nissan, TCM Lift Trucks; International Light-Duty Trucks Replaces: Nissan 16403-37700 O.D.: 2 15/16 (74.6) I.D.: 5/8 (15.9) Height: 2 7/32 (56.4) F. Gskt: ES1036, ES3063, [3] Included</p>	<p>BF868</p>  <p>In-Line Fuel Filter Fits: GMC Automotive Replaces: GMC 250055481 O.D.: 2 5/32 (54.8) Inlet: 3/8 Outlet: M16 x 1.5 Length: 4 7/8 (123.8)</p>
<p>BF862</p>  <p>Secondary Fuel Spin-on with Removal Nut Notes: CAUTION: Furnished O-Ring must be installed on post for seal. Fits: Case, Davis, Drott Equipment Replaces: Case A39867 Thread: 15/16 -16 O.D.: 3 11/16 (93.7) Height: 4 23/32 (119.9) I.Gskt: G401 O-Ring: ES24-B</p>	<p>PF869</p>  <p>Fuel Element Fits: Purolator PAGR50 Through PAGR200 Housings Replaces: Purolator 8001716, 8003100 O.D.: 3 15/16 (100.0) I.D.: 1 21/32 (42.1) Height: 12 1/4 (311.2) A. Gskt: [2] Attached</p>
<p>BF863</p>  <p>Primary Fuel Spin-on with Removal Nut Fits: Case, Davis, Drott Equipment Replaces: Case A39868 Thread: 13/16 -18 O.D.: 3 11/16 (93.7) Height: 4 11/16 (119.1) I.Gskt: G401</p>	<p>PF872</p>  <p>Fuel Element Fits: Bobcat, Hitachi, Kubota Equipment Replaces: Kubota 15231-43560, 15231-43560-1, 15231-43560-2 O.D.: 1 1/8 (28.6) I.D.: 1/2 (12.7) One End Height: 3 7/16 (87.3)</p>
<p>PF864</p>  <p>Fuel Element with 12 Bolt Holes on Flange Fits: Cadillac, Chevrolet, Oldsmobile Automotive Replaces: GMC 8449253 O.D.: 1 3/8 (34.9) Flange 1 13/16 (46.0) I.D.: 15/32 (11.9) One End Height: 1 5/16 (33.3)</p>	<p>BF873</p>  <p>In-Line Fuel Filter Replaces: Toyota 23300-15010 O.D.: 3 1/8 (79.4) Inlet: 9/32 Outlet: 9/32 Length: 2 9/32 (57.9)</p>
<p>BF865</p>  <p>In-Line Fuel Filter Contains: 1/4 Inch Universal Vapor Diverter Fits: Chrysler Automotive Replaces: Chrysler 3870548, 4041540 O.D.: 1 31/32 (50.0) Inlet: 5/16 Outlet: 5/16 Length: 3 15/16 (100.0) Related To: BF865-K (w/Clamps and Hoses)</p>	<p>BF874</p>  <p>Can-Type Fuel Filter Fits: Hercules Engines; Oliver, Winpower Equipment; Quincy, Sullair Compressors Replaces: Hercules 266536; Stanadyne 16637 O.D.: 3 15/32 (88.1) I.D.: 3/4 (19.0) Height: 3 13/16 (96.8) I.Gskt: [1] Included F. Gskt: [2] Included O-Ring: [2] Included Related To: BF812, BF884 (Long Versions) BF825 (Short Version)</p>
<p>BF865-K</p>  <p>In-Line Fuel Filter with Clamps and Hoses Contains: 1/4 Inch Universal Vapor Diverter [5] Clamps [2] Hoses Fits: Chrysler Automotive Replaces: Chrysler 3870548, 4041540 O.D.: 1 31/32 (50.0) Inlet: 5/16 Outlet: 5/16 Length: 3 15/16 (100.0) Related To: BF865 (w/o Clamps and Hoses)</p>	<p>BF876</p>  <p>Secondary Fuel Spin-on Contains: Integral Post Seal Fits: Iveco, Mack, Scania-Vabis Trucks; R.V.I. Buses, Trucks Replaces: Iveco 4733112; Mack 483GB441 Thread: 7/8 -16 O.D.: 4 1/4 (108.0) Height: 7 11/32 (186.5) I.Gskt: G381-A</p>
<p>PF866</p>  <p>Suction Side Fuel Element Fits: Ferrari Automotive Replaces: Alfa Romeo 105500460000 O.D.: 2 9/16 (65.1) I.D.: 17/32 (13.5) & 11/16 (17.5) Height: 2 31/32 (75.4) A. Gskt: [2] Attached F. Gskt: [1] Included</p>	

Measurements Are Shown In Inches And (Millimeters)

WARNING: These products can expose you to chemicals, including Diisononyl Phthalate, Carbon black extracts, Nickel, 1,3 Butadiene, Ethylene Oxide, Epichlorohydrin, which are known to the State of California to cause cancer, and Bisphenol, Ethylene Glycol, Ethylene Oxide, 1,3 Butadiene, Epichlorohydrin, which are known to the State of California to cause birth defects or other reproductive harm. For more information go to www.P65Warnings.ca.gov.

BF877 Primary Fuel Spin-on
Contains: Integral Post Seal
Fits: Mack, Scania-Vabis Trucks; R.V.I. Buses, Trucks
Replaces: Mack 483GB444
Thread: 13/16 -18
O.D.: 4 1/4 (108.0)
Height: 7 11/32 (186.5)
I.Gskt: G381-A
Related To: BF1219 (Fuel/Water Separator Version)



BF879 Screw-in Carburetor In-Line Fuel Filter
Contains: [1] Hose
 [1] Clamp
Fits: AMC, Ford Automotive, Trucks; Massey Ferguson, Ottawa Equipment; Onan Generators
Replaces: AMC 3193898, 8992430; Ford C7AE-9155-A; Jeep J8992430; Massey Ferguson 521248-M91; Onan 149-1353
O.D.: 1 (25.4)
Inlet: 3/8
Outlet: 1/8-27
Length: 2 5/8 (66.7)



BF880-FP Fuel Spin-on with Fill Port
Contains: Integral Post Seal
 Port Thread: 1 1/4-10
Fits: Davco Fuel Pro 321 Housings
Replaces: Davco 4807329
Thread: 1 -14
O.D.: 4 1/4 (108.0)
Height: 7 29/32 (200.8)
I.Gskt: [1] Included



BF881 In-Line Fuel Filter
Fits: GMC Light-Duty Trucks
Replaces: GMC 25055032
O.D.: 1 7/16 (36.5)
Inlet: 5/16
Outlet: 5/16
Length: 3 15/32 (88.1)



PF882 Fuel Element
Fits: ACDelco Housings; Carrier Refrigeration Units; Perkins Engines
Replaces: Carrier 29-11705-80; Perkins 26560088
O.D.: 2 7/8 (73.0)
I.D.: 27/32 (21.4)
Height: 6 13/16 (173.0)
F. Gskt: G147-A



PF883 Fuel Element
Fits: Wix Housings
Replaces: Wix 24390
O.D.: 3 1/32 (77.0)
I.D.: 23/32 (18.3) One End
Height: 6 (152.4)
O. Gskt: G247
Grommets: [1] Attached



BF884 Can-Type Fuel Filter
Fits: Agco, Ford, Hanomag, J.C. Bamford, Massey Ferguson, New Holland, Same, Volvo Equipment; Bedford, Pegaso, R.V.I. Buses, Trucks
Replaces: Ford 78GB-9150-AA; Massey Ferguson 3621009-M1
O.D.: 3 15/32 (88.1)
I.D.: 3/4 (19.0)
Height: 4 7/16 (112.7)
F. Gskt: [2] Included
O-Ring: [2] Included
End Seals: [1] Attached
Related To: BF812 (Long Version)
 BF825, BF874 (Short Versions)



BF885 In-Line Fuel Filter
Fits: Audi, Volkswagen, Volvo Automotive, Light-Duty Trucks
Replaces: Audi 441204511C; Fiat 82434499; Volkswagen 431133511D; Volvo 12760500
O.D.: 3 1/8 (79.4)
Inlet: M14 x 1.5
Outlet: M12 x 1.5
Length: 5 11/32 (135.7)
F. Gskt: [4] Copper Washers



BF886 In-Line Fuel Filter
Contains: 1/4 Inch Universal Vapor Diverter
 [6] Clamps
 [2] Hoses
Fits: AMC, Chrysler, GMC, Jeep Automotive, Light-Duty Trucks
Replaces: Jeep J8121753
O.D.: 1 31/32 (50.0)
Inlet: 5/16
Outlet: 5/16
Length: 3 15/16 (100.0)



BF888 Secondary Fuel Spin-on
Contains: Integral Post Seal
Fits: Ag-Chem, Dresser, Galion, Hough, International, Thermo King Equipment
Replaces: Galion 120301; International 359251-C1, 674293-C1; Thermo King 11-3855
Thread: 7/8 -14
O.D.: 3 11/16 (93.7)
Height: 8 11/16 (220.7)
I.Gskt: G381-A



BF890 In-Line Fuel Filter
Fits: AMC, Jeep, Renault Automotive
Replaces: AMC 8933000076
O.D.: 3 1/16 (77.8)
Inlet: 3/8
Outlet: 5/16
Length: 6 1/16 (154.0)



BF891 Primary Fuel/Water Separator Spin-on with Drain
Notes: Can be used with FB46185 base.
Contains: Integral Post Seal
Fits: Dresser, Hough, International Equipment
Replaces: International 702255-C1
Thread: 1 -14
O.D.: 3 11/16 (93.7)
Height: 5 11/16 (144.5)
I.Gskt: G381-A



Measurements Are Shown In Inches And (Millimeters)

WARNING: These products can expose you to chemicals, including Diisononyl Phthalate, Carbon black extracts, Nickel, 1,3 Butadiene, Ethylene Oxide, Epichlorohydrin, which are known to the State of California to cause cancer, and Bisphenol, Ethylene Glycol, Ethylene Oxide, 1,3 Butadiene, Epichlorohydrin, which are known to the State of California to cause birth defects or other reproductive harm. For more information go to www.P65Warnings.ca.gov.

BF892 Primary Fuel/Water Separator Spin-on with Drain



Notes: Can be used with FB46185 base.
Contains: Integral Post Seal
Fits: Agco, Allis Chalmers, Case-International, Fiat-Allis, International, White Equipment
Replaces: Allis Chalmers 74394407; International 702256-C1
Thread: 1 -14
O.D.: 3 11/16 (93.7)
Height: 9 1/32 (229.4)
I.Gskt: G381-A

BF896 Primary Fuel Spin-on with Drain



Notes: Part of BF897 KIT.
Fits: Carrier Refrigeration Units; Case, Drott, Grimmer Schmidt Equipment
Replaces: Carrier 30-00301; Case A58712
Thread: 13/16 -18
O.D.: 3 11/16 (93.7)
Height: 5 21/32 (143.7)
I.Gskt: G401

PF893 Carburetor Fuel Element



Fits: GM Automotive, Gas Engines; Crusader, Flagship Marine Engines
Replaces: GMC 5651920
O.D.: 1 1/16 (17.5)
I.D.: 9/32 (7.1) One End
Height: 1 1/32 (26.2)
Related To: PF893-RV (with Roll-Over Valve)

BF897 KIT Set of Primary and Secondary Fuel Spin-ons



Notes: On BF582 (Secondary), Furnished O-Ring must be installed on post for seal.
Contains: [1] BF896
 [1] BF582
Fits: Case, David Brown, Drott Equipment
Replaces: Case A41745
BF896 (Primary)
Thread: 13/16 -18
O.D.: 3 11/16 (93.7)
Height: 5 21/32 (143.7)
I.Gskt: G401
BF582 (Secondary)
O.D. 3 11/16
I.D. Thread: 15/16-16
Height 5 13/32
O-Ring G401

PF893-RV Carburetor Fuel Element with Roll-Over Valve



Fits: GM Automotive, Gas Engines; Crusader, Flagship Marine Engines
Replaces: GMC 5651920
O.D.: 1 1/16 (17.5)
I.D.: 9/32 (7.1) One End
Height: 1 1/32 (26.2)
Related To: PF893 (without Roll-Over Valve)

SF898 Sintered Bronze Fuel Element



Fits: Ford, GMC Automotive, Light-Duty Trucks
Replaces: Ford D9PZ-9155-A; GMC 5651924
O.D.: 5/8 (15.9)
I.D.: 7/32 (5.6) One End
Height: 25/32 (19.8)

PF894 Carburetor Fuel Element



Fits: Buick, Chevrolet, Pontiac Automotive, Gas Engines; GMC Light-Duty Trucks
Replaces: GMC 5651921
O.D.: 1 1/16 (17.5)
I.D.: 9/32 (7.1) One End
Height: 2 1/32 (51.6)
Related To: PF894-RV (with Roll-Over Valve)

PF899 Fuel Element



Contains: Reinforced Centertube
Replaces: GMC 3317990
O.D.: 3 15/16 (100.0)
I.D.: 7/8 (22.2)
Height: 6 7/32 (158.0)
A. Gskt: [2] Attached
F. Gskt: G257

PF894-RV Carburetor Fuel Element with Roll-Over Valve



Fits: Buick, Chevrolet, Pontiac Automotive, Gas Engines; GMC Light-Duty Trucks
Replaces: GMC 5651921
O.D.: 1 1/16 (17.5)
I.D.: 9/32 (7.1) One End
Height: 2 1/32 (51.6)
Related To: PF894 (without Roll-Over Valve)

BF900 Fuel Spin-on



Fits: Agco, Bomag, Case, Claas, Deutz-Allis, Iveco, Poclain, Terex Equipment; DAF Buses, Trucks
Replaces: Bomag N9675; Claas 1780340; DAF 247139; Deutz 1174422; Iveco 1902133; Poclain 1050595
Thread: M16 x 1.5
O.D.: 3 11/16 (93.7)
Height: 5 3/8 (136.5)
I.Gskt: G381-A

Measurements Are Shown In Inches And (Millimeters)

WARNING: These products can expose you to chemicals, including Diisononyl Phthalate, Carbon black extracts, Nickel, 1,3 Butadiene, Ethylene Oxide, Epichlorohydrin, which are known to the State of California to cause cancer, and Bisphenol, Ethylene Glycol, Ethylene Oxide, 1,3 Butadiene, Epichlorohydrin, which are known to the State of California to cause birth defects or other reproductive harm. For more information go to www.P65Warnings.ca.gov.

PF902 Secondary Fuel Element
Fits: Cummins, GMC Engines; Euclid Road Building Equipment
Replaces: Cummins 146823; Euclid 9044268; GMC 5574508
O.D.: 3 (76.2)
I.D.: 1 1/16 (27.0)
Height: 7 13/16 (198.4)
A. Gskt: [2] Attached
F. Gskt: [3] Included
O. Gskt: ES1032



F908-A Wound Cotton Primary Fuel Sock
Fits: Detroit Diesel Engines
Replaces: GMC 6436839
O.D.: 5 1/2 (139.7)
I.D.: 2 15/32 (62.7)
Height: 10 (254.0)
F. Gskt: ES1066, [1] Included



PF902-S Railroad Fuel Element
Fits: E.M.D. Locomotives
Replaces: Clark 60024229
O.D.: 3 (76.2)
I.D.: 1 1/16 (27.0)
Height: 7 13/16 (198.4)
A. Gskt: [2] Attached
O. Gskt: ES1032



BF909 Dual-Stage Box-Style Glass Fuel/Water Separator
Notes: BF959 may be used in place of BF909. Do NOT substitute BF909 for the metal version. Often a companion to BF912.
Contains: Air Bleed Vent Water Drain with Window
Fits: Allis Chalmers, Caterpillar, John Deere, Minneapolis-Moline, Oliver, Vermeer, White Equipment; Joy, Ingersoll-Rand Compressors
Replaces: Allis Chalmers 4024232; John Deere AR50041; Stanadyne 18786; White 20-0006803
Length: 4 15/16 (125.4)
Width: 3 11/16 (93.7)
Height: 3 11/32 (84.9)



PT903 Hydraulic Steering Element
Notes: Inside-Out Flow Direction. 2 Quart Capacity
Fits: International, Kenworth, Mack, Peterbilt, Volvo Trucks
Replaces: Case 279294C92; International 379294-C92; Mack 9424LF634; Volvo 874487
O.D.: 3 15/32 (88.1)
I.D.: 29/32 (23.0) & 1 15/32 (37.3)
Height: 2 25/32 (70.6)
F. Gskt: G115-A
End Seals: [2] Attached
Related To: P951 (without Furnished Gasket)



PF910 Secondary Fuel Element
Fits: Allis Chalmers Equipment
Replaces: Allis Chalmers 4052172
O.D.: 3 (76.2)
I.D.: 1 1/16 (27.0)
Height: 7 13/16 (198.4)
A. Gskt: [2] Attached
F. Gskt: [3] Included



PF906 Secondary Fuel Element
Notes: To convert to spin-on, use FB1302 and BF593.
Fits: Detroit Diesel Engines
Replaces: GMC 3290851
O.D.: 3 (76.2)
I.D.: 1 1/16 (27.0)
Height: 3 5/8 (92.1)
A. Gskt: [2] Attached
F. Gskt: [4] Included, [1] Metal Washer
O. Gskt: G344



BF912 Box-Style Glass Fuel/Water Separator/Coalescer
Notes: Often a companion to BF909.
Fits: Ag-Chem, Allis Chalmers, Caterpillar, Dynapac, John Deere, Koehring, Link-Belt, New Holland Equipment; Ford, GMC, International, Kenworth, Mack, White Trucks
Replaces: Allis Chalmers 4024223; Caterpillar 6N7617; John Deere AR86755; Stanadyne 19797; White 40-0002519
Length: 4 15/16 (125.4)
Width: 3 11/16 (93.7)
Height: 3 11/32 (84.9)



PF907 Fuel Element
Fits: Allis Chalmers Equipment
Replaces: Allis Chalmers 59898
O.D.: 3 (76.2)
I.D.: 1 1/16 (27.0)
Height: 7 23/32 (196.1)
A. Gskt: [2] Attached
F. Gskt: [2] Included, [2] Loose Seals



PF913 Fuel Element
Fits: E.M.D. Locomotives
Replaces: GMC 8363264
O.D.: 2 1/2 (63.5)
 Flange 2 7/8 (73.0)
I.D.: 27/32 (21.4) One End
Height: 4 1/4 (108.0)
A. Gskt: [1] Attached



Measurements Are Shown In Inches And (Millimeters)

WARNING: These products can expose you to chemicals, including Diisononyl Phthalate, Carbon black extracts, Nickel, 1,3 Butadiene, Ethylene Oxide, Epichlorohydrin, which are known to the State of California to cause cancer, and Bisphenol, Ethylene Glycol, Ethylene Oxide, 1,3 Butadiene, Epichlorohydrin, which are known to the State of California to cause birth defects or other reproductive harm. For more information go to www.P65Warnings.ca.gov.

BF914

Set of Filter Base and Spin-on for Fuel Storage Tank



Contains: [1] BF915 Fuel Filter
[1] FB1307 Base
BF915
Thread: 1 -12
O.D.: 3 11/16 (93.7)
Height: 7 7/16 (188.9)
FB1307
O.D.: 3 3/4 (95.3)
I.D. Inlet: 1 In. NPT
Height: 2 21/32 (67.5)

BF915

Fuel Storage Tank Spin-on with Drain



Notes: Part of BF914.
Can be used with FB1307 base.
Replaces: Cim-Tek 700-02
Thread: 1 -12
O.D.: 3 11/16 (93.7)
Height: 7 7/16 (188.9)
I.Gskt: G381-A
Related To: BF956 (with Water Absorbent Media)

F916-C

Wound Cotton Primary Fuel Sock



Notes: To convert to spin-on, use FB1301 base and BF592.
Fits: Allis Chalmers Equipment; Detroit Diesel Engines
Replaces: Allis Chalmers 4055533; Detroit Diesel 5192854
O.D.: 2 7/8 (73.0)
I.D.: 1 (25.4)
Height: 5 3/4 (146.0)
F. Gskt: [4] Included

PF916

Primary Fuel or Hydraulic Element



Notes: To convert to spin-on, use FB1301 base and BF592 or BF7774.
Fits: AgChem, Allis Chalmers, Case, Fiat-Allis, Kato, Vermeer Equipment; Detroit Diesel Engines; Thermo King Refrigeration Units
Replaces: Case 9980AB; Detroit Diesel 5192845
O.D.: 3 (76.2)
I.D.: 1 1/16 (27.0)
Height: 5 5/8 (142.9)
A. Gskt: [2] Attached
F. Gskt: [4] Included
O. Gskt: ES1032

BF918-K

In-Line Fuel Filter with Clamps and Hoses



Contains: 1/4 Inch Universal Vapor Diverter
[6] Clamps
[3] Hoses
Fits: Dodge, Plymouth Automotive
Replaces: Chrysler 5214692
O.D.: 1 1/2 (38.1)
Inlet: 5/16
Outlet: 5/16
Length: 3 7/16 (87.3)

F919-C

Wound Cotton Fuel or Hydraulic Sock



Fits: Caterpillar Engines, Equipment
Replaces: Caterpillar 2A5886
O.D.: 1 3/4 (44.4)
I.D.: 7/16 (11.1)
Height: 7 7/8 (200.0)
O. Gskt: 7B-7635, 7B-8017

BF920

Nylon Screen Screw-in Carburetor Fuel Filter



Fits: Ford Automotive
Replaces: Ford E0ZE-9155-BA
O.D.: 1 11/32 (34.1)
Inlet: 1/2-20
Outlet: 1/8-27
Height: 1 15/16 (49.2)

PF924

Fuel Element



Fits: Purolator PAG25D Series Housings
Replaces: GMC 8164725, 8302891
O.D.: 2 7/8 (73.0)
I.D.: 1 13/32 (35.7)
Height: 10 (254.0)
End Seals: [2] Attached

PF926

Fuel or Hydraulic Element



Fits: Cooper-Bessemer
Replaces: Cooper-Bessemer P227815
O.D.: 2 9/16 (65.1)
I.D.: 1 1/16 (27.0)
Height: 9 3/4 (247.7)
A. Gskt: [2] Attached

BF928

In-Line Fuel Filter



Fits: Chrysler, Hyundai, Isuzu, Mitsubishi, Nissan Automotive; Nissan Lift Trucks
Replaces: Chrysler MB129591; Hyundai 3191021000; Isuzu 8-94250-176-1; Mitsubishi MB052676; Nissan 16400-C6400
O.D.: 2 3/4 (69.9)
Inlet: 11/32
Outlet: 11/32
Length: 3 19/32 (91.3)

BF929

In-Line Fuel Filter



Fits: Mazda Automotive
Replaces: Mazda N326-20-490
O.D.: 2 13/16 (71.4)
Inlet: 5/16
Outlet: 5/16
Length: 6 17/32 (165.9)

BF930













In-Line Fuel Filter



Contains: 1/4 Inch Universal Vapor Diverter
[6] Clamps
[3] Hoses
Fits: Chrysler Automotive
Replaces: Chrysler 4241824
O.D.: 1 1/4 (31.8)
Inlet: 5/16
Outlet: 5/16
Length: 3 15/32 (88.1)











Measurements Are Shown In Inches And (Millimeters)

WARNING: These products can expose you to chemicals, including Diisononyl Phthalate, Carbon black extracts, Nickel, 1,3 Butadiene, Ethylene Oxide, Epichlorohydrin, which are known to the State of California to cause cancer, and Bisphenol, Ethylene Glycol, Ethylene Oxide, 1,3 Butadiene, Epichlorohydrin, which are known to the State of California to cause birth defects or other reproductive harm. For more information go to www.P65Warnings.ca.gov.

<p>BF932 In-Line Fuel Filter Fits: Nissan, Toyota Automotive; Nissan, TCM Lift Trucks Replaces: Nissan 16400-E3001; TCM 16400-E3000; Toyota 23300-24050 O.D.: 1 7/8 (47.6) Inlet: 9/32 Outlet: 9/32 Length: 3 17/32 (89.7)</p> 	<p>BF939 Secondary Fuel Spin-on with Drain Fits: Allmand Equipment; Onan Engines Replaces: Onan 122B326 Thread: 3/8 -24 O.D.: 3 7/16 (87.3) Height: 4 13/16 (122.2) I.Gskt: [1] Included A. Gskt: [1] Included F. Gskt: ES1001</p> 
<p>BF933 In-Line Fuel Filter Fits: Chevrolet, Mazda, Nissan, Toyota Automotive Replaces: GMC 25175542; Nissan 16400-D0100; Toyota 23300-25020 O.D.: 4 1/16 (103.2) Inlet: 9/32 Outlet: 9/32 Length: 2 1/4 (57.2)</p> 	<p>BF940 Fuel Spin-on Fits: Allis Chalmers, Kubota, Massey Ferguson Equipment; Yanmar Engines Replaces: Allis Chalmers 2098616; Kubota 15221-43081 Thread: M20 x 1.5 O.D.: 3 (76.2) Height: 2 27/32 (72.2) I.Gskt: [1] Included</p> 
<p>PF935 Primary Fuel Element Fits: Caterpillar Equipment Replaces: Caterpillar 5M7650, 9M2341 O.D.: 2 1/4 (57.2) I.D.: 13/32 (10.3) Height: 3 (76.2) O. Gskt: ES1030, G323</p> 	<p>BF941 Fuel Spin-on Replaces: Komatsu 600-311-8220 Thread: 3/4 -16 O.D.: 3 1/32 (77.0) Height: 5 13/16 (147.6) I.Gskt: [1] Included Related To: BF954 (Short Version)</p> 
<p>PF936 2-Section Fuel/Water Separator Element Contains: Grommet Seal Between Sections Fits: Fram Housing FCS1136 Replaces: Fram CCS1136 O.D.: 3 3/32 (78.6) I.D.: 9/16 (14.3) Height: 3 13/16 (96.8) A. Gskt: [2] Attached F. Gskt: G344</p> 	<p>PF942 Fuel/Water Coalescer Element Fits: Cerlist, Cruisair, Cummins Engines; Fram FCS1133PL Housing Use With: PF943 Replaces: Cerlist 151222904; Cummins 136198 O.D.: 2 7/8 (73.0) I.D.: 1 1/16 (27.0) Height: 7 19/32 (192.9) A. Gskt: [2] Attached F. Gskt: G344, [1] Included</p> 
<p>PF937 Fuel Element Fits: Bolens, Ford, John Deere, Komatsu, Massey Ferguson, Takeuchi, Yanmar Equipment Replaces: Bolens 1862499; Ford SBA130366040; John Deere CH15553; Komatsu 104-500-5571; Massey Ferguson 3283343-M1; Yanmar 104500-55710 O.D.: 1 3/8 (34.9) I.D.: 1/2 (12.7) One End Height: 2 23/32 (69.1) O-Ring: [1] Included</p> 	<p>PF943 Fuel/Water Separator Element Fits: Case, Cerlist, Cruisair, Cummins Engines; Fram FCS1133PL Housing Use With: PF942 Replaces: Cerlist 1512903; Cummins 136197 O.D.: 2 7/8 (73.0) I.D.: 1 1/16 (27.0) Height: 4 13/16 (122.2) A. Gskt: [2] Attached F. Gskt: G344, [1] Included</p> 
<p>BF938 Primary Fuel Spin-on with Drain Fits: Allmand Equipment; Onan Engines Replaces: Onan 122B325 Thread: 7/16 -20 O.D.: 3 7/16 (87.3) Height: 4 13/16 (122.2) I.Gskt: [1] Included F. Gskt: ES1001</p> 	<p>PF945 Fuel or Hydraulic Element Fits: Frigiking, Hyster, Michigan, Minneapolis-Moline Equipment; Fram FBM1110PL Housings Replaces: Frigiking 5100154; Hyster 201641 O.D.: 2 7/8 (73.0) I.D.: 9/16 (14.3) & 21/32 (16.7) Height: 2 9/16 (65.1) A. Gskt: [2] Attached F. Gskt: [1] Included</p> 

Measurements Are Shown In Inches And (Millimeters)

WARNING: These products can expose you to chemicals, including Diisononyl Phthalate, Carbon black extracts, Nickel, 1,3 Butadiene, Ethylene Oxide, Epichlorohydrin, which are known to the State of California to cause cancer, and Bisphenol, Ethylene Glycol, Ethylene Oxide, 1,3 Butadiene, Epichlorohydrin, which are known to the State of California to cause birth defects or other reproductive harm. For more information go to www.P65Warnings.ca.gov.

<p>PF946</p>  <p>Secondary Fuel Element with Bail Handle Fits: Allis Chalmers, Ingersoll-Rand, International Equipment Replaces: Allis Chalmers 138267; International 367378-R91 O.D.: 2 7/8 (73.0) I.D.: 3/4 (19.0) & 13/16 (20.6) Height: 4 1/16 (103.2) F. Gskt: [3] Included</p>	<p>F950-F</p>  <p>Felt Fuel Element with Bail Handle Fits: Akerman, Claas, Demag, Liebherr Equipment; Kassbohrer, Mercedes-Benz, Scania, Volvo Buses, Trucks Replaces: Liebherr 550770208; Mercedes-Benz 4220920005 O.D.: 3 1/4 (82.6) I.D.: 17/32 (13.5) Height: 5 5/8 (142.9) F. Gskt: [1] Included Grommets: [2] Attached</p>
<p>PF947</p>  <p>Primary Fuel Element with Bail Handle Fits: Allis Chalmers, Ingersoll-Rand, International Equipment; Kohler Generators Replaces: Allis Chalmers 40487894; International 368278-R91 O.D.: 2 7/8 (73.0) I.D.: 9/16 (14.3) & 1/2 (12.7) Height: 4 (101.6) F. Gskt: [3] Included Grommets: [2] Attached</p>	<p>F950-F WO</p>  <p>Felt Fuel Element with Bail Handle Notes: DISCONTINUED. Replaced by F950-F (includes Gaskets). Fits: Claas Combines; Iveco, M.A.N., R.V.I. Buses, Trucks Replaces: Claas 133035, 1330350 O.D.: 3 3/16 (81.0) I.D.: 1/2 (12.7) Height: 5 5/8 (142.9) Grommets: [2] Attached</p>
<p>BF948</p>  <p>Fuel Spin-on Notes: CAUTION: Do NOT use for John Deere applications. CAUTION: Furnished D-Ring must be installed on post for seal. Can be used with FB1311 base. Fits: Cummins Engines; Hino Trucks Replaces: Cummins 154711; Fleetguard FF104 Thread: 1 -14 O.D.: 3 11/16 (93.7) Height: 4 3/8 (111.1) I.Gskt: G381-A O-Ring: ES24-D Related To: BF957 (Extended Life, Long Version) BF7557, BF7558 (Extended Life Versions)</p>	<p>PF950</p>  <p>Fuel Element Fits: Atlas Copco, Daewoo, Deutz, International, Michigan Equipment; Iveco, M.A.N., Mercedes-Benz, Scania-Vabis, Volvo Buses, Trucks Replaces: Deutz 1289054; International 3059245-R91; Mercedes-Benz 4777901; Volvo 233239 O.D.: 2 7/8 (73.0) I.D.: 7/16 (11.1) Height: 5 9/16 (141.3) F. Gskt: G332 Grommets: [2] Attached</p>
<p>BF948-JD</p>  <p>Fuel Spin-on with Drain Notes: CAUTION: Furnished End Seal must be installed on post for seal. Fits: John Deere Loaders, Tractors ONLY Replaces: John Deere AR21627R Thread: 1 -14 O.D.: 3 11/16 (93.7) Height: 4 11/16 (119.1) I.Gskt: G381-A F. Gskt: [1] Included</p>	<p>PT951</p>  <p>Power Steering Element Notes: Inside-Out Flow Direction Fits: Galion Equipment; International, Mack Buses, Trucks Replaces: Galion 255027; International 279294-C92; Mack 485GB3160 O.D.: 3 15/32 (88.1) I.D.: 29/32 (23.0) & 1 15/32 (37.3) Height: 2 25/32 (70.6) O. Gskt: G115-A End Seals: [2] Attached Related To: PT903 (with Furnished Gasket)</p>
<p>PF949</p>  <p>Fuel or Lube Element with Bail Handle Fits: Chicago-Pneumatic Compressors; Cooper-Bessemer Engines; Euclid, Hyster Equipment Replaces: Euclid 9040974; Hyster 235872 O.D.: 6 1/32 (153.2) I.D.: 1 (25.4) Height: 14 1/2 (368.3) F. Gskt: G102-A, G210 End Seals: [2] Attached</p>	<p>PF952</p>  <p>Fuel Element Replaces: Cuno CF31 O.D.: 2 7/8 (73.0) I.D.: 1 1/16 (27.0) Height: 19 1/2 (495.3) F. Gskt: G237 End Seals: [2] Attached Related To: F911-DL (Wound Cotton Version)</p>

Measurements Are Shown In Inches And (Millimeters)

WARNING: These products can expose you to chemicals, including Diisononyl Phthalate, Carbon black extracts, Nickel, 1,3 Butadiene, Ethylene Oxide, Epichlorohydrin, which are known to the State of California to cause cancer, and Bisphenol, Ethylene Glycol, Ethylene Oxide, 1,3 Butadiene, Epichlorohydrin, which are known to the State of California to cause birth defects or other reproductive harm. For more information go to www.P65Warnings.ca.gov.

F953-F Felt Fuel Element
Fits: Claas Combines; Iveco, M.A.N. Buses, Trucks; Deutz Engines
Replaces: Deutz 1168403
O.D.: 2 3/4 (69.9)
I.D.: 7/16 (11.1)
Height: 4 17/32 (115.1)
A. Gskt: [2] Attached
F. Gskt: [1] Included



BF954 Fuel Spin-on
Fits: Isuzu, Toyota Trucks; Case, Ford, Hitachi, John Deere, Kobelco, Komatsu Equipment; Isuzu Engines; Nissan Lift Trucks
Replaces: Isuzu 1-3240-018; John Deere GV10809; Nissan 16403-Z7000
Thread: 3/4 -16
O.D.: 3 1/16 (77.8)
Height: 3 7/16 (87.3)
I.Gskt: [1] Included
Related To: BF941 (Long Version)



BF955 Fuel Storage Tank Spin-on
Notes: Can be used with FB1307, FB46183 bases.
Fits: Purolator Optional Filter Housings
Replaces: Cim-Tek 700-10; Purolator F54725, F71601
Thread: 1 -12
O.D.: 3 11/16 (93.7)
Height: 5 3/8 (136.5)
I.Gskt: G381-A
Related To: BF971 (Long Version)



BF955 KIT Fuel Filter Kit Assembly
Notes: Post Thread: 1-12
Contains: [1] BF955
 [1] FB1307
Inlet: 1 In. NPT
Outlet: 1 In. NPT



BF956 Fuel Storage Tank Spin-on
Notes: Can be used with FB1307, FB46183 bases.
Contains: Water Absorbent Media
Fits: Fuel Pumps; Fuel Storage Tanks
Replaces: Cim-Tek 700-14
Thread: 1 -12
O.D.: 3 11/16 (93.7)
Height: 5 3/8 (136.5)
I.Gskt: G381-A
Related To: BF915 (Standard Media Version)



BF957 Fuel Spin-on
Notes: CAUTION: Furnished D-Ring must be installed on post for seal.
 Can be used with FB1311 base.
Fits: Cummins Engines
Replaces: Cummins 158172
Thread: 1 -14
O.D.: 3 11/16 (93.7)
Height: 5 7/16 (138.1)
I.Gskt: G381-A
O-Ring: ES24-D
Related To: BF948 (Short Version)
 BF1212 (Fuel/Water Separator Version)
 BF7557, BF7558 (Extended Life Versions)



BF957-D Fuel Spin-on with Drain
Notes: CAUTION: Furnished D-Ring must be installed on post for seal.
 Can be used with FB1311 base.
Fits: Cummins Engines
Replaces: Cummins 154789
Thread: 1 -14
O.D.: 3 11/16 (93.7)
Height: 5 7/16 (138.1)
I.Gskt: G381-A
O-Ring: ES24-D
Related To: BF948 (Short Version)
 BF1212 (Fuel/Water Separator Version)
 BF7557, BF7558 (Extended Life Versions)



BF958 Storage Tank Fuel/Water Separator Spin-on with Drain
Fits: Fuel Pumps, Fuel Storage Tanks
Replaces: Amoco A08, AO8; Cim-Tek 700-04
Thread: 1 3/8 -12
O.D.: 3 11/16 (93.7)
Height: 7 7/16 (188.9)
I.Gskt: [1] Included



BF959 Dual-Stage Box-Style Metal Fuel Filter
Notes: Heavy-duty metal version of BF909.
 Do NOT substitute BF909.
Contains: Air Bleed Vent
 Water Drain
Fits: Allis Chalmers, John Deere Equipment
Replaces: Allis Chalmers 4036432; John Deere AR86745, RE27091; Stanadyne 22177
Length: 5 1/8 (130.2)
Width: 3 11/16 (93.7)
Height: 3 7/32 (81.8)



P960 By-Pass Lube Element with Bail Handle
Fits: Deutz Engines
Replaces: Deutz 155150610
O.D.: 2 7/8 (73.0)
I.D.: 1/2 (12.7) & 9/16 (14.3)
Height: 4 1/4 (108.0)
F. Gskt: [1] Included
Grommets: [2] Attached



Measurements Are Shown In Inches And (Millimeters)

WARNING: These products can expose you to chemicals, including Diisononyl Phthalate, Carbon black extracts, Nickel, 1,3 Butadiene, Ethylene Oxide, Epichlorohydrin, which are known to the State of California to cause cancer, and Bisphenol, Ethylene Glycol, Ethylene Oxide, 1,3 Butadiene, Epichlorohydrin, which are known to the State of California to cause birth defects or other reproductive harm. For more information go to www.P65Warnings.ca.gov.

BF962

Fuel Spin-on



Notes: CAUTION: Furnished O-Ring must be installed on post for seal.
Fits: Allis Chalmers, Fiat-Allis Equipment
Replaces: Allis Chalmers 4025230; Fiat-Allis 40289456
Thread: 15/16 -16
O.D.: 3 11/16 (93.7)
Height: 5 3/8 (136.5)
I.Gskt: G381-A
O-Ring: [1] Included

BF971

Fuel Storage Tank Spin-on



Notes: Can be used with FB1307 base.
Fits: EMD Locomotive; Fuel Storage Tanks
Replaces: Cim-Tek 700-03
Thread: 1 -12
O.D.: 3 11/16 (93.7)
Height: 7 1/8 (181.0)
I.Gskt: G381-A
Related To: BF955 (Short Version)

PF963

Fuel Element



Fits: Komatsu Equipment
Replaces: Komatsu 611-073-6130
O.D.: 3 7/16 (87.3)
I.D.: 19/32 (15.1)
Height: 5 5/8 (142.9)
F. Gskt: [1] Included
Grommets: [2] Attached

BF974-D

Fuel Spin-on with Drain



Fits: Galion Graders
Replaces: Galion D73246
Thread: 13/16 -16
O.D.: 3 11/16 (93.7)
Height: 7 7/16 (188.9)
I.Gskt: G381-A

BF966

In-Line Fuel Filter



Contains: [2] Plastic Retainer Clips
Fits: Ford, Lincoln, Mercury Automotive
Replaces: Ford E9TZ-9B072-CA
O.D.: 3 1/8 (79.4)
Inlet: 5/16
Outlet: 5/16
Length: 5 13/16 (147.6)

B975

Full-Flow Lube Spin-on



Notes: Do NOT use on Case, Deutz or International applications.
 See application sections and B167, B236, BT261, B262.
Contains: Anti-Drainback Valve
 8 PSID By-Pass Valve
Fits: Akerman, Broyt Equipment; Thermo King Refrigeration Units; Volvo Buses, Equipment, Trucks
Replaces: Carrier 70-000011; Thermo King 11-4565; Volvo 423135, 423135-3
Thread: 1 -12
O.D.: 3 11/16 (93.7)
Height: 7 1/8 (181.0)
I.Gskt: G381-A

PF967

Primary Fuel Element



Fits: Clark, Michigan Equipment
Replaces: Clark 945444, 945624
O.D.: 3 (76.2)
I.D.: 1 1/16 (27.0)
Height: 5 5/8 (142.9)
A. Gskt: [2] Attached
F. Gskt: G264-A, G299

BF976

Secondary Fuel Spin-on



Contains: Integral Post Seal
Fits: Mack Trucks
Replaces: Mack 483GB431
Thread: 1 1/16 -16
O.D.: 4 1/4 (108.0)
Height: 10 7/16 (265.1)
I.Gskt: [1] Included

BF968

Fuel Spin-on



Fits: International Engines
Replaces: International 392301-R91
Thread: 5/8 -11
O.D.: 3 11/16 (93.7)
Height: 5 3/8 (136.5)
I.Gskt: G381-A

BF978

Secondary Fuel Spin-on



Notes: Can be used with FB46185 base.
Contains: Integral Post Seal
Fits: International Engines, Equipment
Replaces: International 702253-C1, 703419-C91
Thread: 1 -14
O.D.: 3 11/16 (93.7)
Height: 8 23/32 (221.5)
I.Gskt: G381-A

BF970

Fuel Spin-on



Notes: Do NOT use on Cummins engines.
 Can be used with FB46185 base.
Contains: Integral Post Seal
Fits: Caterpillar, International, Link-Belt, New Holland Equipment
Replaces: Caterpillar 1P2299
Thread: 1 -14
O.D.: 3 11/16 (93.7)
Height: 7 1/8 (181.0)
I.Gskt: G381-A
Related To: BF1214 (Fuel/Water Separator Version)

Measurements Are Shown In Inches And (Millimeters)

WARNING: These products can expose you to chemicals, including Diisononyl Phthalate, Carbon black extracts, Nickel, 1,3 Butadiene, Ethylene Oxide, Epichlorohydrin, which are known to the State of California to cause cancer, and Bisphenol, Ethylene Glycol, Ethylene Oxide, 1,3 Butadiene, Epichlorohydrin, which are known to the State of California to cause birth defects or other reproductive harm. For more information go to www.P65Warnings.ca.gov.

BF979 Primary Fuel Spin-on
Notes: Can be used with FB46185 base.
Contains: Integral Post Seal
Fits: International Engines
Replaces: International 702251-C1, 703420-C91
Thread: 1 -14
O.D.: 3 11/16 (93.7)
Height: 8 23/32 (221.5)
I.Gskt: G381-A
Related To: BF1225 (Fuel/Water Separator Version)



BF988 Fuel Spin-on
Fits: Deutz, Volvo Engines; R.V.I. Trucks
Replaces: Bosch 1-457-434-062; Deutz 1180597; Volvo 4669875
Thread: M16 x 1.5
O.D.: 3 1/32 (77.0)
Height: 4 27/32 (123.0)
I.Gskt: G449-B
Related To: BF1221 (Fuel/Water Separator Version)



BF980 Fuel Spin-on
Fits: DAF Buses, Trucks
Replaces: DAF 247138
Thread: M16 x 1.5
O.D.: 3 11/16 (93.7)
Height: 8 1/8 (206.4)
I.Gskt: G381-A



BF989 Nylon Screen In-Line Fuel Filter
Contains: [4] Clamps
 [2] Hoses
Fits: Ford Automotive, Light-Duty Trucks; International, Versatile, Wheel Horse Equipment
Replaces: Ford D1FZ-9155-A, D2RY-9155-A, D3FZ-9155-A; Motorcraft FG44A
O.D.: 15/16 (23.8)
Inlet: 5/16
Outlet: 5/16
Length: 3 1/32 (77.0)



PF981 Fuel Element
Fits: Case, Hitachi, John Deere, Komatsu, Kubota, Mustang, Takeuchi, Yanmar Equipment
Replaces: John Deere CH10479; Komatsu YM12455055700; Kubota 16271-43560; Yanmar 124550-55700
O.D.: 1 3/8 (34.9)
I.D.: 1/2 (12.7) One End
Height: 3 1/2 (88.9)
I.Gskt: [1] Included
O-Ring: [1] Included



BF991 Primary Fuel Spin-on
Contains: Integral Post Seal
Fits: Thermo King Refrigeration Units; International Equipment, Trucks
Replaces: Carrier 20-113692; International 702143-C1; Thermo King 11-3692
Thread: 1 -14
O.D.: 3 11/16 (93.7)
Height: 7 1/8 (181.0)
I.Gskt: G381-A



BF984 Primary Fuel Spin-on
Contains: Integral Post Seal
Fits: Hino, Nissan Trucks; International Engines
Replaces: International 625625-C1
Thread: 1 -14
O.D.: 3 11/16 (93.7)
Height: 5 5/16 (134.9)
I.Gskt: G381-A



BF992 Secondary Fuel Spin-on
Contains: Integral Post Seal
Fits: Thermo King Refrigeration Units
Replaces: Carrier 20-113693; Thermo King 11-3726
Thread: 7/8 -14
O.D.: 3 11/16 (93.7)
Height: 5 3/8 (136.5)
I.Gskt: [1] Included



PF986 Fuel Element with Bail Handle
Fits: Komatsu Equipment; Volvo-Penta, Yanmar Engines
Replaces: Volvo 6604946, 6643218
O.D.: 2 9/16 (65.1)
I.D.: 7/16 (11.1) & 1/2 (12.7)
Height: 2 5/8 (66.7)
Grommets: [2] Attached



BF995 Nylon Screen Screw-in Carburetor Fuel Filter
Fits: Ford Automotive
Replaces: Ford D7TE-9155-A
O.D.: 31/32 (24.6)
Inlet: 5/16
Outlet: 1/8-27
Height: 2 5/16 (58.7)



PF987 Fuel Element
Fits: Bennett Fuel Pumps
Replaces: Bennett 3112
O.D.: 3 15/16 (100.0)
I.D.: 1 5/8 (41.3) One End
Height: 4 1/2 (114.3)





P996 Full-Flow Lube Element
Notes: If a conversion kit is already installed, or if originally equipped with element-type, use P999-HD.
Contains: Two-Way 8 PSID By-Pass Valve
Replaces: Nugent lube bag without a kit and without switching lines because of Baldwins two-way by-pass valve.
O.D.: 5 1/16 (128.6)
I.D.: 1 1/16 (17.5) & 1 1/4 (31.8)
Height: 12 5/32 (308.8)
A. Gskt: [1] Attached
Spring: [1] Attached
O. Gskt: G164-A, G263, G269, G281





Measurements Are Shown In Inches And (Millimeters)

WARNING: These products can expose you to chemicals, including Diisononyl Phthalate, Carbon black extracts, Nickel, 1,3 Butadiene, Ethylene Oxide, Epichlorohydrin, which are known to the State of California to cause cancer, and Bisphenol, Ethylene Glycol, Ethylene Oxide, 1,3 Butadiene, Epichlorohydrin, which are known to the State of California to cause birth defects or other reproductive harm. For more information go to www.P65Warnings.ca.gov.

PF997 Fuel Element

Fits: Lister Engines
Replaces: Lister 201-13116
O.D.: 2 5/32 (54.8)
I.D.: 9/32 (7.1) & 29/32 (23.0)
Height: 3 19/32 (91.3)
F. Gskt: [3] Included
O-Ring: [2] Included

BF1045 In-Line Fuel Filter

Contains: [2] Plastic Retainer Clips
Fits: Buick Roadmaster, Cadillac Fleetwood Brougham, Chevrolet Caprice, Impala
Replaces: GMC 25121978
O.D.: 2 9/32 (57.9)
Inlet: 3/8
Outlet: 3/8
Length: 6 15/32 (164.3)

P998 Full-Flow Lube Element

Contains: Reinforced Centertube
Fits: Cummins Engines
Replaces: Cummins 173174
O.D.: 4 3/4 (120.7)
I.D.: 11/16 (17.5) & 1 9/16 (39.7)
Height: 7 1/2 (190.5)
O. Gskt: G354
End Seals: [2] Attached

BF1046 In-Line Fuel Filter

Contains: [2] Plastic Retainer Clips
Fits: Chevrolet, Saturn Automotive; GMC Light-Duty Trucks, Express Vans
Replaces: GMC 25121468
O.D.: 2 9/32 (57.9)
Inlet: 3/8
Outlet: 3/8
Length: 6 13/32 (162.7)

P999-HD Heavy-Duty Full-Flow Lube Element

Notes: To convert to spin-on use OB1368 or OB1369 base and B96
CAUTION: When converting from bag-type with any conversion kit, lines must be switched so oil flows outside-in (see P996 for Baldwin solution)
Contains: Reinforced Centertube
Fits: Cummins Engines
Replaces: Cummins 256843
O.D.: 4 31/32 (126.2)
I.D.: 11/16 (17.5) & 1 9/16 (39.7)
Height: 9 11/16 (246.1)
O. Gskt: G164-A, G263, G269, G278, G336
End Seals: [2] Attached

BF1047 In-Line Fuel Filter

Notes: Reverse Flow
Fits: Volvo Trucks
Replaces: Volvo 3507416-0, 9142658
O.D.: 3 5/16 (84.1)
Inlet: 5/16
Outlet: 5/16
Length: 7 17/32 (191.3)

BF1008 In-Line Fuel Filter

Fits: Dodge Dakota, Ramcharger
Replaces: Chrysler 52004611, 52018646
O.D.: 2 5/32 (54.8)
Inlet: 5/16
Outlet: 5/16
Length: 6 3/8 (161.9)

BF1048 In-Line Fuel Filter

Fits: Subaru Baja, Forester, Impreza, Legacy, SVX
Replaces: Subaru 42072-AA011, 42072-AA120, 42072-PA010
O.D.: 3 3/8 (85.7)
Inlet: 5/16
Outlet: 5/16
Length: 4 7/8 (123.8)

V1044-O Vac-Cel Dual-Stage Full-Flow Lube Sock

Fits: WhiteGMC Trucks
Replaces: White 883451
O.D.: 4 1/8 (104.8)
I.D.: 1 1/4 (31.8)
Height: 9 3/4 (247.7)
F. Gskt: G115-A

BF1049 In-Line Fuel Filter

Fits: Acura SLX; Chevrolet LUV; Honda Passport; Isuzu Amigo, Rodeo, Trooper
Replaces: Isuzu 8-25053-640, 8-25121-778-0
O.D.: 2 5/16 (58.7)
Inlet: 5/16
Outlet: 5/16
Length: 5 15/32 (138.9)













BF1050 In-Line Fuel Filter

Fits: Geo Prizm; Toyota Automotive
Replaces: Toyota 23300-19295
O.D.: 2 3/4 (69.9)
Inlet: M14 x 1.5
Outlet: M12 x 1 1/4
Length: 4 9/32 (108.7)
F. Gskt: [2] Copper Washers

BF1052 Wire Cloth In-Line Fuel Filter

Fits: Case Excavators, Loaders
Replaces: Case D145357
O.D.: 1 29/32 (48.4)
Inlet: 3/8
Outlet: 3/8
Length: 3 13/16 (96.8)

Measurements Are Shown In Inches And (Millimeters)

WARNING: These products can expose you to chemicals, including Diisononyl Phthalate, Carbon black extracts, Nickel, 1,3 Butadiene, Ethylene Oxide, Epichlorohydrin, which are known to the State of California to cause cancer, and Bisphenol, Ethylene Glycol, Ethylene Oxide, 1,3 Butadiene, Epichlorohydrin, which are known to the State of California to cause birth defects or other reproductive harm. For more information go to www.P65Warnings.ca.gov.

<p>BF1053 In-Line Fuel Filter Contains: 5/16 Inch Return Line Steel Braided Ground Wire Fits: Chrysler Automotive Replaces: Chrysler 4682370 O.D.: 1 29/32 (48.4) Inlet: 3/8 Outlet: 5/16 Length: 36 (914.4)</p> 	<p>BF1102 Fuel Spin-on Contains: Anti-Drainback Valve Standpipe Fits: ERF, Leyland Trucks; Rolls-Royce Engines Replaces: Rolls-Royce OD19596 Thread: M24 x 1.5 O.D.: 3 11/16 (93.7) Height: 7 3/16 (182.6) I.Gskt: G401 O. Gskt: ES24-B</p> 
<p>BF1056 Fuel Spin-on Fits: Mercedes-Benz Buses, Trucks Replaces: Mercedes-Benz 10920501 Thread: M14 x 1.5 O.D.: 3 1/32 (77.0) Height: 3 15/32 (88.1) I.Gskt: G449-B</p> 	<p>BF1104 In-Line Fuel Filter Fits: Isuzu, Nissan Automotive Replaces: Nissan 16400-F5100 O.D.: 2 17/32 (64.3) Inlet: 5/16 Outlet: 5/16 Length: 4 11/16 (119.1)</p> 
<p>BF1057 In-Line Fuel Filter Fits: Chrysler Automotive Replaces: Chrysler 4495780, 4495781, 4636686, 4636687 O.D.: 2 5/32 (54.8) Inlet: 5/16 Outlet: 5/16 Length: 4 5/16 (109.5)</p> 	<p>BF1105 In-Line Fuel Filter Fits: Ford, Isuzu, Jaguar, Nissan Automotive Replaces: Ford F3XY-9155-F; Nissan 16400-N8601 O.D.: 3 1/8 (79.4) Inlet: 5/16 Outlet: 5/16 Length: 5 3/8 (136.5)</p> 
<p>BF1058 In-Line Fuel Filter Fits: 1995-96 Dodge, Plymouth Neon Replaces: Chrysler 4495950, 4546679; Wix 33346 O.D.: 2 5/32 (54.8) Inlet: 3/8 Outlet: [2] 5/16 Length: 9 17/32 (242.1)</p> 	<p>BF1110 Fuel Spin-on Contains: Integral Post Seal Fits: Caterpillar, John Deere, Mitsubishi Equipment Replaces: Mitsubishi 34462-00300 Thread: M20 x 1.5 O.D.: 3 1/32 (77.0) Height: 4 3/32 (104.0) I.Gskt: [1] Included</p> 
<p>BF1061 In-Line Fuel Filter Fits: Mitsubishi, Toyota Automotive Replaces: Toyota 23300-74260, 23300-79495 O.D.: 2 9/16 (65.1) Inlet: M14 x 1.5 Outlet: M12 x 1 1/4 Length: 4 1/32 (102.4) F. Gskt: [2] Metal Washers</p> 	<p>BF1120 In-Line Fuel Filter Fits: 1988-91 Honda Civic, 1989-91 CRX Replaces: Honda 16900-SH3-A30; Wix 33330 O.D.: 3 13/32 (86.5) Inlet: M12 x 1.25 Outlet: M12 x 1.25 Length: 3 7/8 (98.4) F. Gskt: [4] Metal Washers</p> 
<p>BF1100 In-Line Fuel Filter Fits: Chrysler, Dodge, Geo, Hyundai, Mitsubishi, Suzuki, Toyota Automotive Replaces: Chrysler MB504732, MB504750; Suzuki 15410-61A00; Toyota 23300-19175, 23300-49145, 23300-69025, 23300-79055 O.D.: 2 3/4 (69.9) Inlet: M12 x 1 1/4 Outlet: M12 x 1 1/4 Length: 4 29/32 (124.6) F. Gskt: [4] Metal Washers</p> 	<p>BF1123 In-Line Fuel Filter Replaces: Isuzu 8-94125-784-0 O.D.: 2 7/16 (61.9) Inlet: 5/16 Outlet: 5/16 Length: 4 13/16 (122.2)</p> 

Measurements Are Shown In Inches And (Millimeters)

WARNING: These products can expose you to chemicals, including Diisononyl Phthalate, Carbon black extracts, Nickel, 1,3 Butadiene, Ethylene Oxide, Epichlorohydrin, which are known to the State of California to cause cancer, and Bisphenol, Ethylene Glycol, Ethylene Oxide, 1,3 Butadiene, Epichlorohydrin, which are known to the State of California to cause birth defects or other reproductive harm. For more information go to www.P65Warnings.ca.gov.

<p>BF1140 In-Line Fuel Filter Fits: Subaru, Toyota Automotive Replaces: Subaru 7420-23020 O.D.: 3 5/32 (80.2) Inlet: 5/16 Outlet: 5/16 Length: 2 9/32 (57.9)</p> 	<p>BF1171 In-Line Fuel Filter Contains: [1] Plastic Retainer Clip Fits: GM Automotive Replaces: GMC 25121293 O.D.: 2 5/32 (54.8) Inlet: 3/8 Outlet: M16 x 1.5 Length: 5 3/8 (136.5)</p> 
<p>BF1148 In-Line Fuel Filter Fits: Hyundai, Kia, Toyota Automotive Replaces: Toyota 23300-65010 O.D.: 2 3/4 (69.9) Inlet: M14 x 1.5 Outlet: M14 x 1.5 Length: 4 9/32 (108.7)</p> 	<p>BF1172 In-Line Fuel Filter Contains: [1] 12 Inch Length of 3/8 Inch Fuel Line [1] Plastic Retainer Clip Fits: Buick Century; Oldsmobile Cutlass Ciera; Pontiac Automotive Replaces: GMC 10140514, 25121656 O.D.: 2 5/32 (54.8) Inlet: 3/8 Outlet: 3/8 Length: 6 15/32 (164.3)</p> 
<p>BF1150 In-Line Fuel Filter Fits: Suzuki Automotive Replaces: Suzuki 15410-80000 O.D.: 3 5/16 (84.1) Inlet: 5/16 Outlet: 5/16 Length: 2 15/16 (74.6)</p> 	<p>BF1173 Wire Cloth In-Line Fuel Strainer Notes: Inside-Out Flow Direction Fits: Cummins Engines; Case, Caterpillar, Gradall, New Holland, Vermeer, Volvo Equipment Replaces: Cummins 3826094 O.D.: 1 29/32 (48.4) Inlet: 3/8 Outlet: 3/8 Length: 3 13/16 (96.8)</p> 
<p>BF1160 Primary In-Line Fuel Filter Fits: Honda Automotive Replaces: Honda 16900-SE0-004 O.D.: 2 25/32 (70.6) Inlet: 5/16 Outlet: 5/16 Length: 2 19/32 (65.9)</p> 	<p>BF1174 In-Line Fuel Filter Contains: [2] Plastic Retainer Clips Fits: Chevrolet, Pontiac Automotive Replaces: GMC 10091791 O.D.: 2 5/32 (54.8) Inlet: 3/8 Outlet: 3/8 Length: 6 5/16 (160.3)</p> 
<p>BF1163 In-Line Fuel Filter Fits: Nissan Automotive Replaces: Nissan 16400-72L00 O.D.: 2 17/32 (64.3) Inlet: 5/16 Outlet: 5/16 Length: 5 (127.0)</p> 	<p>BF1177 In-Line Fuel Filter Fits: Mercedes-Benz Automotive Replaces: Mercedes-Benz 24770701 O.D.: 3 13/32 (86.5) Inlet: M12 x 1.5 Outlet: M14 x 1.5 Length: 5 23/32 (145.3) F. Gskt: [2] Washers</p> 
<p>BF1166 In-Line Fuel Filter Contains: [2] Plastic Retainer Clips Fits: Ford Pickups, Vans Replaces: Ford F0TZ-9155-B O.D.: 3 1/8 (79.4) Inlet: 5/16 Outlet: 5/16 Length: 6 25/32 (172.2)</p> 	<p>BF1178 In-Line Fuel Filter Fits: Chrysler, Mitsubishi Automotive Replaces: Mitsubishi MB433774 O.D.: 2 1/8 (54.0) Inlet: 5/16 Outlet: 5/16 Length: 2 15/16 (74.6)</p> 
<p>BF1170 In-Line Fuel Filter Contains: [2] Plastic Retainer Clips Fits: Ford Automotive Replaces: Ford F1SZ-9155-A O.D.: 2 7/32 (56.4) Inlet: 5/16 Outlet: 3/8 Length: 6 3/8 (161.9)</p> 	

Measurements Are Shown In Inches And (Millimeters)

WARNING: These products can expose you to chemicals, including Diisononyl Phthalate, Carbon black extracts, Nickel, 1,3 Butadiene, Ethylene Oxide, Epichlorohydrin, which are known to the State of California to cause cancer, and Bisphenol, Ethylene Glycol, Ethylene Oxide, 1,3 Butadiene, Epichlorohydrin, which are known to the State of California to cause birth defects or other reproductive harm. For more information go to www.P65Warnings.ca.gov.

BF1179 Universal In-Line Fuel Filter
Fits: Chrysler, Daihatsu, Mitsubishi, Toyota Automotive, Light-Duty Trucks
Replaces: Mitsubishi MB504753, MB658689; Toyota 23030-74020, 23300-19045
O.D.: 2 3/4 (69.9)
Inlet: M14 x 1.5
Outlet: M12 x 1 1/4
Length: 4 3/8 (111.1)
F. Gskt: [2] Metal Washers



BF1181 In-Line Fuel Filter
Fits: Chrysler Automotive
Replaces: Chrysler 4554040
O.D.: 2 5/32 (54.8)
Inlet: 3/8
Outlet: 5/16
Length: 6 13/32 (162.7)



BF1182 In-Line Fuel Filter
Fits: Dodge Vans, Viper
Replaces: Chrysler 4708317, 52019023, 52020016
O.D.: 2 5/32 (54.8)
Inlet: 5/16
Outlet: 5/16
Length: 6 1/4 (158.8)



BF1184 In-Line Fuel Filter
Contains: [2] Plastic Retainer Clips
Fits: Ford Escort, Thunderbird; Mercury Cougar
Replaces: Ford E9SZ-9155-A; Motorcraft FG862
O.D.: 2 1/4 (57.2)
Inlet: 5/16
Outlet: 5/16
Length: 6 (152.4)



BF1185 In-Line Fuel Filter
Contains: [2] Plastic Retainer Clips
Fits: Daewoo, GMC Automotive
Replaces: GMC 25121129
O.D.: 2 3/16 (55.6)
Inlet: 5/16
Outlet: 5/16
Length: 6 5/16 (160.3)



BF1186 In-Line Fuel Filter
Notes: OBSOLETE. Availability Limited to Dealer Stock.
Fits: Geo, Isuzu Automotive
Replaces: GMC 25121141, 25121150, 25121160
O.D.: 2 5/32 (54.8)
Inlet: M14 x 1.5
Outlet: M14 x 1.5
Length: 4 7/16 (112.7)



BF1191 In-Line Fuel Filter
Fits: Toyota Automotive
Replaces: Toyota 23300-39035
O.D.: 2 3/4 (69.9)
Inlet: M12 x 1 1/4
Outlet: M12 x 1 1/4
Length: 4 13/32 (111.9)
F. Gskt: [4] Copper Washers



BF1193 In-Line Fuel Filter
Fits: Acura Integra, Honda Accord, Civic
Replaces: Honda 16010-ST5-931
O.D.: 2 15/16 (74.6)
Inlet: M14 x 1.5
Outlet: M12 x 1 1/4
Length: 4 7/16 (112.7)
F. Gskt: [2] Metal Washers



BF1195 In-Line Fuel Filter
Fits: Alfa Romeo, Audi, BMW, Land Rover, Mercedes-Benz, Renault, Volkswagen Automotive
Replaces: BMW 13321269231, 13321269548, 13321270038, 13329063165
O.D.: 3 3/16 (81.0)
Inlet: 5/16
Outlet: 5/16
Length: 6 1/4 (158.8)



BF1199 In-Line Fuel Filter
Fits: Dodge Monaco, Eagle Premier, Jeep Grand Cherokee
Replaces: Chrysler 33003007, 8933003007
O.D.: 2 5/8 (66.7)
Inlet: 3/8
Outlet: 5/16
Length: 6 9/16 (166.7)



BF1201 Fuel/Water Separator Element with Drain
Fits: GMC Trucks
Replaces: GMC 10154635
O.D.: 2 9/16 (65.1)
I.D.: 3/4 (19.0)
Height: 5 15/32 (138.9)
Grommets: [1] Attached



BF1204 Secondary Fuel/Water Separator Spin-on with Drain
Notes: Inside-Out Flow Direction
Contains: Integral Post Seal
Sensor Port Thread: 1/2-20
Fits: Ford Diesel Engines
Thread: 1 -14
O.D.: 3 11/16 (93.7)
Height: 6 1/16 (154.0)
I.Gskt: [1] Included
Related To: BF1204-O (with Open Port)
 BF1204-SP (with Sensor Port)



BF1204-O Fuel/Water Separator Spin-on with Open End for Bowl
Contains: Bowl Thread: 1 1/4-10
 Integral Post Seal
Fits: Racor 225R Assembly
Replaces: Racor R26S
Thread: 1 -14
O.D.: 3 3/4 (95.3)
Height: 4 11/16 (119.1)
F. Gskt: [1] Included
O-Ring: [1] Included
Related To: BF1204 (Drain Version)
 BF1204-SP (Sensor Port Version)



Measurements Are Shown In Inches And (Millimeters)

WARNING: These products can expose you to chemicals, including Diisononyl Phthalate, Carbon black extracts, Nickel, 1,3 Butadiene, Ethylene Oxide, Epichlorohydrin, which are known to the State of California to cause cancer, and Bisphenol, Ethylene Glycol, Ethylene Oxide, 1,3 Butadiene, Epichlorohydrin, which are known to the State of California to cause birth defects or other reproductive harm. For more information go to www.P65Warnings.ca.gov.

BF1204-SP

Secondary Fuel/Water Separator Spin-on with Drain and Sensor Port



Notes: Inside-Out Flow Direction.
May use OP8752 to plug Sensor Port.
Contains: Integral Post Seal
Sensor Port Thread: 1/2-20
Fits: Ford Diesel Engines
Thread: 1 -14
O.D.: 3 11/16 (93.7)
Height: 6 1/16 (154.0)
I.Gskt: [1] Included
F. Gskt: [1] Included
Related To: BF1204 (with Drain)
BF1204-O (with Open Port)

BF1205

Primary Fuel/Water Separator Spin-on with Drain



Notes: Inside-Out Flow Direction
Contains: Integral Post Seal
Sensor Port Thread: 1/2-20
Fits: Ford, John Deere Engines
Replaces: Ford E7HZ-9N184-B,
E8HT-9J288-AA
Thread: 1 -14
O.D.: 3 11/16 (93.7)
Height: 6 1/16 (154.0)
I.Gskt: [1] Included
Related To: BF1205-SP (with Sensor Port)

BF1205-SP

Primary Fuel/Water Separator Spin-on with Drain and Sensor Port



Notes: Inside-Out Flow Direction.
May use OP8752 to plug Sensor Port.
Contains: Integral Post Seal
Sensor Port Thread: 1/2-20
Fits: Ford, John Deere Engines
Replaces: Ford E7HZ-9N184-B,
E8HT-9J288-AA
Thread: 1 -14
O.D.: 3 11/16 (93.7)
Height: 6 1/16 (154.0)
I.Gskt: [1] Included
F. Gskt: [1] Included
Related To: BF1205 (with Drain)

BF1210

Fuel/Water Separator Spin-on with Drain



Notes: Inside-Out Flow Direction
Fits: Cummins Engines
Replaces: Fleetguard FS19540; Luber-finer
LFP2000C
Thread: 15/16 -16
O.D.: 4 1/4 (108.0)
Height: 11 11/32 (288.1)
I.Gskt: G401

BF1211

Fuel Spin-on with Drain



Notes: Inside-Out Flow Direction
Replaces: Luber-finer LFP2100C
Thread: 15/16 -16
O.D.: 4 1/4 (108.0)
Height: 8 17/32 (216.7)
I.Gskt: G401

BF1212

Fuel/Water Separator Spin-on with Drain



Notes: CAUTION: Furnished D-Ring must be installed on post for seal.
Can be used with FB1311 base.
Fits: Cummins Engines
Use With: BF1212 FOAM
Replaces: Cummins 3308638
Thread: 1 -14
O.D.: 3 11/16 (93.7)
Height: 7 7/16 (188.9)
I.Gskt: G381-A
F. Gskt: ES24-D
Related To: BF957, BF957-D (Fuel Versions)
BF7798-SP (Sensor Port Version)
BF7798-O (Open Port Version)

BF1212 FOAM

Foam Wrap for BF1212



Use With: BF1212
O.D.: 4 5/8 (117.5)
Height: 8 (203.2)

BF1213

Fuel/Water Separator Spin-on with Drain



Fits: Detroit Diesel Engines
Replaces: ACDelco TP1009
Thread: 1 -12
O.D.: 3 11/16 (93.7)
Height: 7 13/32 (188.1)
I.Gskt: [1] Included

BF1214

Fuel/Water Separator Spin-on with Drain



Notes: Can be used with FB46185 base.
Contains: Integral Post Seal
Fits: Caterpillar Engines
Replaces: Fleetguard FS1214
Thread: 1 -14
O.D.: 3 11/16 (93.7)
Height: 7 13/32 (188.1)
I.Gskt: G381-A
Related To: BF970 (Fuel Version)

BF1215











In-Line Fuel/Water Separator with Water Relief Valve



Fits: Volkswagen Golf, Jetta
Replaces: Volkswagen 191127401A
O.D.: 3 3/8 (85.7)
Inlet: 5/16
Outlet: 5/16
Length: 6 5/8 (168.3)

Measurements Are Shown In Inches And (Millimeters)

WARNING: These products can expose you to chemicals, including Diisononyl Phthalate, Carbon black extracts, Nickel, 1,3 Butadiene, Ethylene Oxide, Epichlorohydrin, which are known to the State of California to cause cancer, and Bisphenol, Ethylene Glycol, Ethylene Oxide, 1,3 Butadiene, Epichlorohydrin, which are known to the State of California to cause birth defects or other reproductive harm. For more information go to www.P65Warnings.ca.gov.

<p>BF1216</p>  <p>Fuel/Water Separator Spin-on with Drain Notes: Can be used with FB1306 base. Contains: Integral Post Seal Fits: Cummins Engines Replaces: Cummins 3309437 Thread: 1 1/4 -12 O.D.: 4 11/16 (119.1) Height: 12 3/32 (307.2) I.Gskt: [1] Included Related To: BF596 (Fuel Version)</p>	<p>BF1222</p>  <p>Fuel/Water Separator Spin-on with Drain Contains: Integral Post Seal Fits: Ford Engines Replaces: Ford E8TZ-9N184-A Thread: 1 -14 O.D.: 4 9/32 (108.7) Height: 5 1/4 (133.4) A. Gskt: [1] Included Related To: BF1222-O (with Open Port) BF1222-SP (with Sensor Port)</p>
<p>BF1217</p>  <p>Fuel/Water Separator Spin-on with Drain Fits: Iveco EuroCargo, EuroStar, EuroTech Series Trucks Replaces: Iveco 1907539 Thread: M14 x 1.5 O.D.: 3 11/16 (93.7) Height: 7 11/32 (186.5) I.Gskt: [1] Included</p>	<p>BF1222-O</p>  <p>Fuel/Water Separator Spin-on with Open End for Bowl Contains: Bowl Thread: 3-12 Integral Post Seal Fits: Ford Engines Replaces: Ford F2TZ-9N-184-A; Motorcraft FD3375 Thread: 1 -14 O.D.: 4 1/4 (108.0) Height: 4 1/8 (104.8) A. Gskt: [1] Included O-Ring: [1] Included Related To: BF1222 (with Drain) BF1222-SP (with Sensor Port)</p>
<p>BF1218</p>  <p>Fuel/Water Separator Spin-on with Drain Notes: Can be used with FB46185 base. Contains: Integral Post Seal Fits: Caterpillar Engines Replaces: Fleetguard FS1218 Thread: 1 -14 O.D.: 4 1/4 (108.0) Height: 11 5/16 (287.3) I.Gskt: G401 Related To: BF584 (Fuel Version)</p>	<p>BF1222-SP</p>  <p>Fuel/Water Separator Spin-on with Drain and Sensor Port Notes: May use OP8751 to plug Sensor Port. Contains: Integral Post Seal Sensor Port Thread: 7/16-20 Fits: Ford Engines Replaces: Ford E8TZ-9N184-A Thread: 1 -14 O.D.: 4 9/32 (108.7) Height: 5 1/4 (133.4) A. Gskt: [1] Included F. Gskt: [1] Included Related To: BF1222 (with Drain) BF1222-O (with Open Port)</p>
<p>BF1219</p>  <p>Fuel/Water Separator Spin-on with Drain Contains: Integral Post Seal Fits: Mack Trucks Replaces: Mack 483GB433B Thread: 13/16 -18 O.D.: 4 1/4 (108.0) Height: 8 1/8 (206.4) I.Gskt: G381-A Related To: BF877 (Fuel Version)</p>	<p>BF1223</p>  <p>Fuel/Water Separator Spin-on with Drain Contains: Integral Post Seal Fits: Carrier-Transcold, Ford, Hino Trucks; Ingersoll-Rand Compressors Replaces: Carrier 30-01079; Ford F1HZ-9365-A Thread: 1 -14 O.D.: 4 1/4 (108.0) Height: 6 25/32 (172.2) A. Gskt: [1] Included Related To: BF1223-O (with Open Port for Bowl) BF1223-SP (with Sensor Port) BF1224 (without Drain or Sensor Port)</p>
<p>BF1220</p>  <p>Fuel/Water Separator Spin-on with Drain Notes: CAUTION: Furnished D-Ring must be installed on post for seal. Can be used with FB46185 base. Contains: Integral Post Seal Fits: Case, International Equipment Replaces: Racor B32004, S3204 Thread: 1 -14 O.D.: 3 11/16 (93.7) Height: 6 3/16 (157.2) I.Gskt: G381-A F. Gskt: ES24-D</p>	<p>BF1223-O</p>  <p>Fuel/Water Separator Spin-on with Open End for Bowl Contains: Bowl Thread: 3 3/4-10 Integral Post Seal Fits: Ford Trucks Replaces: Ford F1HZ-9365-A; Motorcraft FD3368 Thread: 1 -14 O.D.: 4 1/4 (108.0) Height: 5 7/32 (132.6) A. Gskt: [1] Included F. Gskt: [2] Included Related To: BF1223 (Drain Version) BF1223-SP (Sensor Port Version)</p>
<p>BF1221</p>  <p>Fuel/Water Separator Spin-on with Drain Contains: Standpipe Fits: Deutz, Volvo Engines Replaces: Fleetguard FS1221 Thread: M16 x 1.5 O.D.: 3 1/32 (77.0) Height: 6 21/32 (169.1) I.Gskt: G449-B Related To: BF988 (Fuel Version) BF1232 (Sensor Port Version)</p>	

Measurements Are Shown In Inches And (Millimeters)

WARNING: These products can expose you to chemicals, including Diisononyl Phthalate, Carbon black extracts, Nickel, 1,3 Butadiene, Ethylene Oxide, Epichlorohydrin, which are known to the State of California to cause cancer, and Bisphenol, Ethylene Glycol, Ethylene Oxide, 1,3 Butadiene, Epichlorohydrin, which are known to the State of California to cause birth defects or other reproductive harm. For more information go to www.P65Warnings.ca.gov.

BF1223-SP

Fuel/Water Separator Spin-on with Drain and Sensor Port



Notes: May use OP8750 to plug Sensor Port.
Contains: Integral Post Seal
 Sensor Port Thread: 9/16-18
Fits: Carrier-Transcold, Ford, Hino Trucks; Ingersoll-Rand Compressors
Replaces: Carrier 30-01079; Ford F1HZ-9365-A
Thread: 1 -14
O.D.: 4 1/4 (108.0)
Height: 6 25/32 (172.2)
A. Gskt: [1] Included
O-Ring: [1] Included
Related To: BF1223-O (Open Port Version) BF1223 (Drain Version)

BF1224

Fuel/Water Separator Spin-on



Contains: Integral Post Seal
Fits: Carrier-Transcold Refrigeration Units
Replaces: Carrier 30-01090-00
Thread: 1 -14
O.D.: 4 1/4 (108.0)
Height: 5 29/32 (150.0)
I.Gskt: [1] Included
Related To: BF1223 (Drain Version) BF1223-O (Open End Version) BF1223-SP (Drain and Sensor Port Version)

BF1225

Fuel/Water Separator Spin-on with Drain



Notes: Can be used with FB46185 base.
Contains: Integral Post Seal
Fits: Case Combines
Replaces: GMC 25011691
Thread: 1 -14
O.D.: 3 11/16 (93.7)
Height: 7 3/8 (187.3)
I.Gskt: G381-A
Related To: BF979 (Fuel Version)

BF1226

Fuel/Water Separator Spin-on with Drain



Notes: CAUTION: Furnished O-Ring must be installed on post for seal.
Contains: Standpipe
Fits: Cummins Engines
Replaces: Cummins 3903202
Thread: M16 x 1.5
O.D.: 3 1/32 (77.0)
Height: 5 11/16 (144.5)
I.Gskt: G449-B
O-Ring: [1] Included

BF1231

Fuel/Water Separator Spin-on with Drain



Contains: Integral Post Seal
Fits: Ford, New Holland Equipment
Replaces: Ford 87840136
Thread: 1 -14
O.D.: 4 5/16 (109.5)
Height: 6 25/32 (172.2)
I.Gskt: [1] Included

BF1232

Fuel/Water Separator Spin-on with Sensor Port



Contains: Integral Post Seal
 Sensor Port Thread: 1 1/4-10
Fits: 1989-93 Dodge Pickup with 5.9L Diesel Engine
Replaces: Chrysler 4429107
Thread: M16 x 1.5
O.D.: 3 1/32 (77.0)
Height: 4 11/16 (119.1)
I.Gskt: G449-B
O-Ring: [2] Included
Related To: BF1221 (without Sensor Port)

BF1233

Fuel/Water Separator Spin-on with Sensor Port



Contains: Sensor Port Thread: 1 1/4-10
Fits: Dodge Light-Duty, Peterbilt Trucks
Replaces: Chrysler 4741689
Thread: M20 x 1.5
O.D.: 3 11/16 (93.7)
Height: 4 3/8 (111.1)
I.Gskt: G401
F. Gskt: [2] Included

BF1239

Fuel/Water Separator Spin-on



Contains: Water Absorbent Media
Fits: Various Fuel Islands
Replaces: Cim-Tek 700-23, 700-68
Thread: 1 1/2 -16
O.D.: 5 1/16 (128.6)
Height: 10 3/4 (273.1)
F. Gskt: G369-B
O. Gskt: G286-C, G369-V, G372, G447, G483, G704, G710

BF1240

Fuel/Water Separator Spin-on with Drain



Notes: Can be used with FB46185 base.
Contains: Integral Post Seal
Fits: John Deere Scrapers
Replaces: John Deere AT77587
Thread: 1 -14
O.D.: 4 1/4 (108.0)
Height: 6 25/32 (172.2)
I.Gskt: G401

V1240-C

Vac-Cel By-Pass Lube Sock



Fits: Hall-Scott, Hercules Equipment; Waukesha Engines
Replaces: Hall-Scott 6412240A; Hercules 7611970
O.D.: 4 1/8 (104.8)
I.D.: 1 1/16 (27.0)
Height: 12 (304.8)
F. Gskt: G115-A

BF1248

Fuel/Water Separator Spin-on with Drain



Notes: CAUTION: Furnished O-Ring must be installed on post for seal.
Contains: Integral Post Seal
Fits: Komatsu Engines, Equipment
Replaces: Komatsu 600-311-8293
Thread: 1 -14
O.D.: 3 11/16 (93.7)
Height: 5 5/8 (142.9)
I.Gskt: G381-A
F. Gskt: ES3028

Measurements Are Shown In Inches And (Millimeters)

WARNING: These products can expose you to chemicals, including Diisononyl Phthalate, Carbon black extracts, Nickel, 1,3 Butadiene, Ethylene Oxide, Epichlorohydrin, which are known to the State of California to cause cancer, and Bisphenol, Ethylene Glycol, Ethylene Oxide, 1,3 Butadiene, Epichlorohydrin, which are known to the State of California to cause birth defects or other reproductive harm. For more information go to www.P65Warnings.ca.gov.

BF1249



Fuel/Water Separator Spin-on with Drain

Notes: CAUTION: Furnished D-Ring must be installed on post for seal.

Can be used with FB1311 base.

Fits: Blue Bird, Ford, Freightliner, International Buses, Trucks; Hamm Rollers; Hyundai, Liebherr Equipment; Optional on Cummins Engines

Replaces: Alliance ABPN/N10G-FS1242; Bomag 31701061, 31701062; Cummins 3355903, 3353904; Hamm 1236385; John Deere RE61554; Kobelco YN02PU1004S002; Liebherr 7381816; Massey Ferguson 108615W1, 108614W91; Nissan FL6442N

Thread: 1 -14

O.D.: 3 11/16 (93.7)

Height: 8 29/32 (226.2)

I.Gskt: G381-A

F. Gskt: ES24-D

Related To: BF1249-O (Open Port Version)

BF1249-SP (Sensor Port Version)

BF1393-SP (High Efficiency Version)

BF1252



Primary Fuel/Water Separator Spin-on with Drain

Notes: CAUTION: Furnished D-Ring must be installed on post for seal.

Can be used with FB1311 base.

Fits: Blue Bird Buses

Replaces: Racor S3230

Thread: 1 -14

O.D.: 3 11/16 (93.7)

Height: 7 13/32 (188.1)

I.Gskt: G381-A

F. Gskt: ES24-D

BF1253



Fuel/Water Separator Spin-on with Drain

Notes: Inside-Out Flow Direction

Fits: Racor 220 Series Fuel/Water Separators

Replaces: Racor R24S

Thread: 1 -14

O.D.: 3 11/16 (93.7)

Height: 5 7/32 (132.6)

I.Gskt: [1] Included

BF1249-O



Fuel/Water Separator Spin-on with Open End for Bowl

Notes: CAUTION: Furnished O-Ring must be installed on Post for seal.

Contains: Integral Post Seal

Bowl Thread: 1 1/4-10

Fits: Blue Bird, Ford, Freightliner, International Buses, Trucks; Hamm Rollers; Hyundai, Liebherr Equipment; Optional on Cummins Engines

Replaces: Nissan FL6442N

Thread: 1 -14

O.D.: 3 21/32 (92.9)

Height: 6 5/8 (168.3)

I.Gskt: ES24-D

O-Ring: [1] Included

Related To: BF1249 (Standard Version)

BF1249-SP (Sensor Port Version)

BF1256



Primary Fuel/Water Separator Spin-on with Drain

Contains: Integral Post Seal

Fits: Mack Trucks

Replaces: Mack 483GB472M

Thread: M22 x 1.5

O.D.: 4 1/4 (108.0)

Height: 9 15/16 (252.4)

I.Gskt: [1] Included

BF1257



Fuel/Water Separator Spin-on with Drain

Contains: Integral Post Seal

Fits: Bobcat Loaders; Cummins Engines; Gehl Equipment

Replaces: Clark 6647773; Melroe-Bobcat 6667352

Thread: M16 x 1.5

O.D.: 3 (76.2)

Height: 4 7/32 (107.2)

I.Gskt: G449-B

BF1249-SP



Fuel/Water Separator Spin-on with Drain and Sensor Port

Notes: CAUTION: Furnished D-Ring must be installed on post for seal.

Can be used with FB1311 base.

May use OP8752 to plug Sensor Port.

Contains: Sensor Port Thread: 1/2-20

Fits: Blue Bird, Ford, Freightliner, International Buses, Trucks; Hamm Rollers; Hyundai, Liebherr Equipment; Optional on Cummins Engines

Replaces: Alliance ABPN/N10G-FS1242; Bomag 31701062; Cummins 3355903, 3353904; Hamm 1236385; John Deere RE61554; Kobelco YN02PU1004S002; Liebherr 7381816; Massey Ferguson 108615W1, 108614W91; Nissan FL6442N

Thread: 1 -14

O.D.: 3 11/16 (93.7)

Height: 8 29/32 (226.2)

I.Gskt: G381-A

F. Gskt: ES24-D

Related To: BF1249 (Standard Version)

BF1249-O (Open Port Version)

BF1258



Fuel/Water Separator Spin-on with Drain

Notes: CAUTION: Furnished D-Ring must be installed on post for seal.

Can be used with FB1311 base.

Contains: Standpipe

Fits: Case, Daewoo Equipment; Peterbilt Trucks; Cummins N14 Plus Engines

Replaces: Fleetguard FS1001

Thread: 1 -14

O.D.: 3 11/16 (93.7)

Height: 7 7/16 (188.9)

I.Gskt: G381-A

F. Gskt: ES24-D

Measurements Are Shown In Inches And (Millimeters)



WARNING: These products can expose you to chemicals, including Diisononyl Phthalate, Carbon black extracts, Nickel, 1,3 Butadiene, Ethylene Oxide, Epichlorohydrin, which are known to the State of California to cause cancer, and Bisphenol, Ethylene Glycol, Ethylene Oxide, 1,3 Butadiene, Epichlorohydrin, which are known to the State of California to cause birth defects or other reproductive harm. For more information go to www.P65Warnings.ca.gov.

BF1259



Fuel/Water Separator Spin-on with Drain
Notes: CAUTION: Furnished D-Ring must be installed on post for seal.
 Can be used with FB1311 base.
Contains: Standpipe
Fits: Caterpillar, Cummins Engines; Euclid Rear Dumps; Kenworth, Volvo Trucks; Versatile Tractors
Replaces: Cummins 3329289; Fleetguard FS1000
Thread: 1 -14
O.D.: 3 11/16 (93.7)
Height: 9 17/32 (242.1)
I.Gskt: G381-A
F. Gskt: ES24-D

BF1261



Fuel/Water Separator Spin-on with Drain
Fits: Lister-Petter Engines
Replaces: Lister-Petter 75118100
Thread: M16 x 1.5
O.D.: 3 (76.2)
Height: 4 7/32 (107.2)
I.Gskt: G449-B
F. Gskt: [1] Included

BF1262



Fuel/Water Separator Spin-on with Drain
Contains: Integral Post Seal
Fits: Cummins Engines
Replaces: Cummins 3089916; Fleetguard FS1006
Thread: 1 1/4 -12
O.D.: 4 21/32 (118.3)
Height: 12 1/16 (306.4)
I.Gskt: [1] Included

BF1265



Fuel/Water Separator Spin-on with Drain
Contains: Integral Post Seal
Fits: John Deere Combines, Loaders, Tractors
Replaces: Caterpillar 133-5673; John Deere RE502203
Thread: 1 -14
O.D.: 4 9/32 (108.7)
Height: 11 5/16 (287.3)
I.Gskt: [1] Included
Related To: BF1395-O (Open Port Version)
 BF1395-SP (Sensor Port Version)

BF1266



Fuel/Water Separator Spin-on with Drain
Notes: CAUTION: Furnished D-Ring must be installed on post for seal.
Fits: Detroit Diesel Engines
Replaces: GMC 12542374; Racor S3212
Thread: 1 -12
O.D.: 3 11/16 (93.7)
Height: 6 5/32 (156.4)
I.Gskt: [1] Included
F. Gskt: ES24-D
Related To: BF1278-O (Open Port Version)

BF1267



Fuel/Water Separator Spin-on with Drain
Fits: Onan Generators; Toro Greensmaster Mowers with Mitsubishi Engines
Replaces: Onan 149-2106; Toro 63-8300
Thread: M16 x 1.5
O.D.: 3 1/32 (77.0)
Height: 3 1/8 (79.4)
I.Gskt: [1] Included

BF1268



Suction Line Fuel/Water Separator Spin-on with Drain
Contains: Integral Post Seal
Fits: Chevrolet, Ford, Freightliner Trucks; Caterpillar Engines
Replaces: Caterpillar 175-2949
Thread: 1 -14
O.D.: 3 11/16 (93.7)
Height: 7 3/8 (187.3)
A. Gskt: G381-A

BF1269



Fuel/Water Separator Spin-on with Drain
Fits: DAF Trucks
Replaces: DAF 1319159
Thread: M16 x 1.5
O.D.: 3 1/32 (77.0)
Height: 5 7/32 (132.6)
I.Gskt: G449-B

BF1270-SP



Fuel/Water Separator Spin-on with Drain and Sensor Port
Notes: CAUTION: Furnished O-Ring must be installed on post for seal.
Contains: Sensor Port Thread: 1/2-20
Replaces: Teledyne 504598
Thread: 1 -14
O.D.: 3 11/16 (93.7)
Height: 6 1/16 (154.0)
I.Gskt: [1] Included
O-Ring: [1] Included

BF1271



Fuel/Water Separator Spin-on with Sensor Port
Notes: CAUTION: Furnished O-Ring must be installed on post for seal.
Contains: Sensor Port Thread: 1 1/4-10
 Integral Post Seal
Fits: Cummins ISB Series Engines
Replaces: Cummins 3942533
Thread: M20 x 1.5
O.D.: 3 11/16 (93.7)
Height: 5 3/8 (136.5)
I.Gskt: G401
O-Ring: [1] Included
End Seals: [1] Included

BF1272-SPS



Fuel/Water Separator Spin-on with Drain, Sensor Port and Reusable Sensor
Notes: CAUTION: Furnished D-Ring must be installed on post for seal.
 For use with Delphi oval sensor.
 Not interchangeable with BF1293-SPS.
Contains: Sensor Port Thread: M14 x 2.0
 Standpipe
Fits: Cummins Engines
Replaces: Case J800394; Cummins 3800394; Donaldson P551022; Fleetguard FS1022
Thread: 1 -14
O.D.: 3 11/16 (93.7)
Height: 9 15/32 (240.5)
I.Gskt: G381-A
F. Gskt: ES24-D

Measurements Are Shown In Inches And (Millimeters)

WARNING: These products can expose you to chemicals, including Diisononyl Phthalate, Carbon black extracts, Nickel, 1,3 Butadiene, Ethylene Oxide, Epichlorohydrin, which are known to the State of California to cause cancer, and Bisphenol, Ethylene Glycol, Ethylene Oxide, 1,3 Butadiene, Epichlorohydrin, which are known to the State of California to cause birth defects or other reproductive harm. For more information go to www.P65Warnings.ca.gov.

BF1273-SP Fuel/Water Separator Spin-on with Drain and Sensor Port



Contains: Integral Post Seal
Sensor Port Thread: 1/2-20
Fits: Nissan UD Trucks
Replaces: Nissan 16400-Z5511
Thread: 1 -14
O.D.: 4 1/4 (108.0)
Height: 6 9/16 (166.7)
I.Gskt: G401
O-Ring: [1] Included

BF1277-SP Fuel/Water Separator Spin-on with Drain and Sensor Port



Notes: May use OP8753 to plug Sensor Port.
For service, retain reusable sensor from BF1277-SPS, and attach to BF1277-SP.
Contains: Sensor Port Thread: M14 x 2.0
Fits: Cummins ISX, Signature 600 Engines
Replaces: Case 419858A1, 441701A1; Manitowoc A047930
Thread: M85 x 2.0
O.D.: 4 21/32 (118.3)
Height: 11 5/8 (295.3)
I.Gskt: [1] Included
O-Ring: [1] Included
Related To: BF1277-SPS (with Sensor Port and Reusable Sensor)

BF1274-SP Fuel/Water Separator Spin-on with Drain and Sensor Port



Notes: May use OP8753 to plug Sensor Port.
For service, retain reusable sensor from BF1274-SPS, and attach to BF1274-SP.
Contains: Sensor Port Thread: M14 x 2.0
Fits: Cummins Signature 600 Engines
Replaces: Cummins 3331096; Fleetguard FS1007
Thread: M85 x 2.0
O.D.: 4 21/32 (118.3)
Height: 11 5/8 (295.3)
I.Gskt: [1] Included
O-Ring: [1] Included
Related To: BF1274-SPS (with Sensor Port and Reusable Sensor)

BF1277-SPS Fuel/Water Separator Spin-on with Drain, Sensor Port and Reusable Sensor



Notes: For service, retain reusable sensor from BF1277-SPS, and attach to BF1277-SP.
Contains: Sensor Port Thread: M14 x 2.0
Fits: Cummins ISX, Signature 600 Engines
Replaces: Caterpillar 3964605; Cummins 3101872, 4010651; Fleetguard FS1040
Thread: M85 x 2.0
O.D.: 4 21/32 (118.3)
Height: 11 5/8 (295.3)
I.Gskt: [1] Included
Related To: BF1277-SP (with Sensor Port)

BF1274-SPS Fuel/Water Separator Spin-on with Drain, Sensor Port and Reusable Sensor



Notes: May use OP8753 to plug Sensor Port.
For service, retain reusable sensor from BF1274-SPS, and attach to BF1274-SP.
Contains: Sensor Port Thread: M14 x 2.0
Fits: Cummins Signature 600 Engines
Replaces: Cummins 3331096; Fleetguard FS1007
Thread: M85 x 2.0
O.D.: 4 21/32 (118.3)
Height: 11 5/8 (295.3)
I.Gskt: [1] Included
Related To: BF1274-SP (with Sensor Port)

BF1278 Fuel/Water Separator Spin-on with Drain



Fits: Ingersoll-Rand Compressors
Replaces: Ingersoll-Rand 54468178
Thread: 1 -12
O.D.: 3 11/16 (93.7)
Height: 6 7/32 (158.0)
I.Gskt: [1] Included
Related To: BF1278-O (Open End)

BF1275 Fuel/Water Separator Spin-on with Drain



Contains: Integral Post Seal
Fits: Equipment with Cummins B3.3 Engine Requiring a Fuel/Water Separator
Replaces: Fleetguard FS19594
Thread: 3/4 -16
O.D.: 3 1/32 (77.0)
Height: 5 11/16 (144.5)
I.Gskt: G449-B

BF1278-O Fuel/Water Separator Spin-on with Open End for Bowl



Contains: Bowl Thread: M80 x 2.5
Integral Post Seal
Fits: Ingersoll-Rand Compressors
Replaces: Ingersoll-Rand 54468178
Thread: 1 -12
O.D.: 3 11/16 (93.7)
Height: 4 1/8 (104.8)
F. Gskt: [2] Included
Related To: BF1278 (Drain Version)

BF1276 Fuel/Water Separator Spin-on with Drain



Notes: CAUTION: Furnished O-Ring must be installed on post for seal.
Fits: R.V.I. Trucks
Replaces: Renault 7701030546
Thread: M16 x 1.5
O.D.: 3 1/32 (77.0)
Height: 6 21/32 (169.1)
I.Gskt: G449-B
O-Ring: [1] Included











BF1279 Fuel/Water Separator Spin-on with Drain



Notes: CAUTION: Furnished O-Ring must be installed on post for seal.
Fits: Freightliner Argosy, Century Class, Condor
Replaces: Alliance ABP/32FRT02, RA1320RFRT02; Racor RA132FRT02
Thread: 1 -14
O.D.: 3 23/32 (94.5)
Height: 7 15/16 (201.6)
I.Gskt: G381-A
F. Gskt: [1] Included

Measurements Are Shown In Inches And (Millimeters)

WARNING: These products can expose you to chemicals, including Diisononyl Phthalate, Carbon black extracts, Nickel, 1,3 Butadiene, Ethylene Oxide, Epichlorohydrin, which are known to the State of California to cause cancer, and Bisphenol, Ethylene Glycol, Ethylene Oxide, 1,3 Butadiene, Epichlorohydrin, which are known to the State of California to cause birth defects or other reproductive harm. For more information go to www.P65Warnings.ca.gov.

<p>BF1280</p>  <p>Fuel/Water Separator Spin-on with Drain Notes: CAUTION: Furnished O-Ring must be installed on post for seal. Fits: Cummins Engines Replaces: Cummins 3925274 Thread: 13/16 -18 O.D.: 3 11/16 (93.7) Height: 6 1/4 (158.8) I.Gskt: G401 F. Gskt: [1] Included Related To: BF7879 (without Drain)</p>	<p>BF1283</p>  <p>Fuel/Water Separator Spin-on with Drain Contains: Integral Post Seal Fits: Caterpillar Equipment, Industrial, Marine, Truck Engines; Racor 4120 Series Replaces: Caterpillar 129-0373; Racor R120S Thread: 1 -14 O.D.: 4 9/32 (108.7) Height: 11 7/32 (285.0) I.Gskt: [1] Included Related To: BF1283-SP (Sensor Port Version) BF1283-O (Open Port Version)</p>
<p>BF1281</p>  <p>Primary Fuel/Water Separator Spin-on with Drain Contains: Integral Post Seal Fits: Primary Fuel for Racor 4120 Series Fuel/Water Separators Replaces: Racor R120P Thread: 1 -14 O.D.: 4 9/32 (108.7) Height: 11 5/16 (287.3) F. Gskt: [1] Included Related To: BF1281-O (Open Port Version)</p>	<p>BF1283-O</p>  <p>Fuel/Water Separator Spin-on with Open End for Bowl Contains: Bowl Thread: M95 x 2.5 Integral Post Seal Fits: Caterpillar Equipment, Industrial, Marine, Truck Engines; Racor 4120 Series Replaces: Racor R120S; Donaldson P550175; Fleetguard FS1071 Thread: 1 -14 O.D.: 4 13/32 (111.9) Height: 8 19/32 (218.3) A. Gskt: [1] Included F. Gskt: [1] Included Related To: BF1283 (Drain Version) BF1283-SP (Sensor Port Version)</p>
<p>BF1281-O</p>  <p>Primary Fuel/Water Separator Spin-on with Open End for Bowl Contains: Bowl Thread: M95 x 2.5 Integral Post Seal Fits: Primary Fuel for Racor 4120 Series Fuel/Water Separators Replaces: Racor R120P; Donaldson P550177; Fleetguard FS19754 Thread: 1 -14 O.D.: 4 13/32 (111.9) Height: 8 19/32 (218.3) A. Gskt: [1] Included F. Gskt: [1] Included Related To: BF1281 (with Drain)</p>	<p>BF1283-SP</p>  <p>Fuel/Water Separator Spin-on with Sensor Port and Drain Notes: CAUTION: Furnished O-Ring must be installed on post for seal. May use OP8752 to plug Sensor Port. Contains: Sensor Port Thread: 1/2-20UNF-2B Integral Post Seal Fits: Detroit Diesel Series 60 Engines Replaces: Alliance ABP/N122-R50407 Thread: 1 -14 O.D.: 4 9/32 (108.7) Height: 11 5/16 (287.3) I.Gskt: [1] Included O-Ring: [1] Included Related To: BF1283 (Drain Version) BF1283-O (Open Port Version)</p>
<p>BF1282</p>  <p>Fuel/Water Separator Spin-on with Drain Notes: CAUTION: Furnished D-Ring must be installed on post for seal. Can be used with FB1311 base. Fits: Cummins M11 Engines; Komatsu Equipment Replaces: Cummins 3843447; Komatsu 1304800-H1 Thread: 1 -14 O.D.: 3 11/16 (93.7) Height: 6 5/32 (156.4) I.Gskt: G381-A F. Gskt: ES24-D Related To: BF1282-O (Open Port Version)</p>	<p>BF1285-SP</p>  <p>Fuel/Water Separator Spin-on with Sensor Port and Drain Contains: Integral Post Seal Sensor Port Thread: 1/2-20 Fits: John Deere Equipment Replaces: John Deere RE519608 Thread: 1 -12 O.D.: 4 9/32 (108.7) Height: 11 7/32 (285.0) I.Gskt: [1] Included O-Ring: [1] Included</p>
<p>BF1282-O</p>  <p>Fuel/Water Separator Spin-on with Open End for Bowl Notes: CAUTION: Furnished D-Ring must be installed on post for seal. Contains: Bowl Thread: 1 1/4-2B Fits: Agco, Komatsu Equipment; Case Dump Trucks; Cummins Engines Replaces: Fleetguard FS1241 Thread: 1 -14 O.D.: 3 21/32 (92.9) Height: 4 19/32 (116.7) A. Gskt: [1] Included F. Gskt: ES24-D O-Ring: [1] Included Related To: BF1282 (with Drain)</p>	<p>BF1286</p>  <p>Fuel/Water Separator Spin-on with Drain Contains: Integral Post Seal Fits: Mack Engines Replaces: Mack 483GB477M Thread: M30 x 1.5 O.D.: 4 1/4 (108.0) Height: 8 11/32 (211.9) I.Gskt: [1] Included</p>

Measurements Are Shown In Inches And (Millimeters)

WARNING: These products can expose you to chemicals, including Diisononyl Phthalate, Carbon black extracts, Nickel, 1,3 Butadiene, Ethylene Oxide, Epichlorohydrin, which are known to the State of California to cause cancer, and Bisphenol, Ethylene Glycol, Ethylene Oxide, 1,3 Butadiene, Epichlorohydrin, which are known to the State of California to cause birth defects or other reproductive harm. For more information go to www.P65Warnings.ca.gov.

BF1287-O Fuel/Water Separator Spin-on with Open End for Bowl
Contains: Bowl Thread: M95 x 2.5
 Integral Post Seal
Fits: Komatsu HD465-7, HD605-7 Dump Trucks
Replaces: Komatsu 600-311-3210, 600-319-3240
Thread: 1 1/4 -12
O.D.: 4 7/8 (123.8)
Height: 9 29/32 (251.6)
A. Gskt: [1] Attached
F. Gskt: [1] Included



BF1293-SPS Fuel/Water Separator Spin-on with Drain, Sensor Port and Reusable Sensor
Notes: CAUTION: Furnished O-Ring must be installed on post for seal.
 For use with Deutz square sensor.
 NOT Interchangeable with BF1272-SPS.
Contains: Sensor Port Thread: M14 x 2.0
 Standpipe
Fits: Cummins Engines
Replaces: Cummins 3406889; Donaldson P551003; Fleetguard FS1003
Thread: 1 -14
O.D.: 3 11/16 (93.7)
Height: 10 1/32 (254.8)
I.Gskt: G381-A
F. Gskt: ES24-D



BF1288-O Fuel/Water Separator Spin-on with Open End for Bowl
Contains: Bowl Thread: M95 x 2.5
 Integral Post Seal
Fits: Komatsu Dump Trucks, Equipment
Replaces: Komatsu 600-311-4510, 600-319-4500
Thread: 1 1/4 -12
O.D.: 4 7/8 (123.8)
Height: 9 29/32 (251.6)
A. Gskt: [1] Included
F. Gskt: [1] Included
Related To: BF1357 (Drain Version)



BF1294-O Fuel/Water Separator Spin-on with Open End for Bowl
Contains: Bowl Thread: 3 3/4-10 2B
 Integral Post Seal
Replaces: Scania 1518512; SF-Filter SK3360
Thread: 1 -14
O.D.: 4 1/4 (108.0)
Height: 7 5/32 (181.8)
A. Gskt: [1] Included
F. Gskt: [1] Included



BF1289-SP Fuel/Water Separator Spin-on with Drain and Sensor Port
Contains: Sensor Port Thread: M12 x 1.75
Fits: Caterpillar, Challenger, Perkins Equipment
Replaces: Agco 529435D1; Caterpillar 2715076, 3087298; Perkins 2656F853
Thread: M22 x 1.5
O.D.: 3 11/16 (93.7)
Height: 7 15/16 (201.6)
I.Gskt: [1] Included
O-Ring: [1] Included



BF1296-O Fuel Spin-on with Open End for Bowl
Contains: Bowl Thread: B80 x 3 8A Metric
 Buttress
Fits: Doosan Equipment
Replaces: Parker China Division WBF219B1; Sinotruk 13050733
Thread: 1 -14
O.D.: 4 1/4 (108.0)
Height: 6 13/32 (162.7)
A. Gskt: [1] Included
O-Ring: [1] Included



PF1291 Water Sensor Element
Fits: Wix 24843 Assembly
Replaces: Cim-Tek EHS30, 300-07; Fleetguard FS1286; Wix 24844
O.D.: 4 17/32 (115.1)
I.D.: 1/2 (12.7) & 1 3/32 (27.8)
Height: 9 3/16 (233.4)
F. Gskt: [2] Included, [1] Metal Washer
Grommets: [1] Attached



BF1297-O Fuel Spin-on with Open End for Bowl
Contains: Bowl Thread: B80 x 3 8A Metric
 Buttress
 Integral Post Seal
Replaces: Parker China Division WBF219H; Weichai Power 61230080088
Thread: 1 -14
O.D.: 4 9/32 (108.7)
Height: 9 3/32 (231.0)
A. Gskt: [1] Included
O-Ring: [1] Included



BF1292-O Fuel/Water Separator Spin-on with Open End for Bowl
Contains: Bowl Thread: M95 x 2.5
 Integral Post Seal
Fits: Deutz Engines; Deutz-Fahr, Fendt Tractors; Iveco Trucks
Replaces: Deutz 4291642; Fendt F339202060120; Iveco 42549295; Mercedes-Benz 4771602, A0004771602; Racor R90TDMAX
Thread: 1 -14
O.D.: 4 5/32 (105.6)
Height: 6 5/16 (160.3)
A. Gskt: [1] Included
F. Gskt: [1] Included













BF1298-O Fuel/Water Separator Spin-on with Open End for Bowl
Contains: Bowl Thread: M95 x 2.5
 Integral Post Seal
Replaces: Foton Lovol 1105111500002; CAMC 1125A86D-010; Parker China Division CX1014A
Thread: 1 -14
O.D.: 4 1/4 (108.0)
Height: 6 5/32 (156.4)
A. Gskt: [1] Included
O-Ring: [1] Included



Measurements Are Shown In Inches And (Millimeters)

WARNING: These products can expose you to chemicals, including Diisononyl Phthalate, Carbon black extracts, Nickel, 1,3 Butadiene, Ethylene Oxide, Epichlorohydrin, which are known to the State of California to cause cancer, and Bisphenol, Ethylene Glycol, Ethylene Oxide, 1,3 Butadiene, Epichlorohydrin, which are known to the State of California to cause birth defects or other reproductive harm. For more information go to www.P65Warnings.ca.gov.

<p>BF1299-O</p> 	<p>Fuel/Water Separator Spin-on with Open End for Bowl</p> <p>Contains: Bowl Thread: 3 3/4-10 2B Integral Post Seal</p> <p>Replaces: Yuchai Watyuan 612630080205</p> <p>Thread: 1 -14</p> <p>O.D.: 4 1/4 (108.0)</p> <p>Height: 7 13/16 (198.4)</p> <p>A. Gskt: [1] Included</p> <p>F. Gskt: [1] Included</p>	<p>FB1307</p> 	<p>Fuel Storage Tank Filter Base</p> <p>Notes: Part of BF914</p> <p>Contains: Threaded Stud: 1-12</p> <p>Use With: BF915, BF955, BF956, BF971</p> <p>O.D.: 3 3/4 (95.3)</p> <p>Inlet: 1 In. NPT</p> <p>Outlet: 1 In. NPT</p> <p>Height: 2 21/32 (67.5)</p>
<p>FB1301</p> 	<p>Primary Fuel Filter Base for Detroit Diesel Engines</p> <p>Notes: Converts F845-A, PF845, F916-C or PF916 from element to spin-on.</p> <p>Contains: Threaded Stud: 1-12</p> <p>Use With: BF592, BF781, BF5800, BF5813, BF7774</p> <p>O.D.: 4 11/16 (119.1)</p> <p>Inlet: [1] 3/8-18 In. NPT</p> <p>Outlet: [2] 3/8-18 In. NPT</p> <p>Height: 3 3/32 (78.6)</p>	<p>OB1308</p> 	<p>By-Pass Lube Filter Base for Cummins and Other Engines</p> <p>Notes: Converts element to spin-on, or can be installed as an auxiliary filter for additional protection.</p> <p>Contains: Threaded Stud: 1 3/8-16</p> <p>Use With: B7577</p> <p>O.D.: 5 7/32 (132.6)</p> <p>Inlet: 3/8</p> <p>Outlet: 3/8</p> <p>Height: 4 23/32 (119.9)</p>
<p>FB1302</p> 	<p>Secondary Fuel Filter Base for Detroit Diesel Engines</p> <p>Notes: Converts PF906 from element to spin-on.</p> <p>Contains: Threaded Stud: 13/16-12</p> <p>Use With: BF593, BF5810</p> <p>O.D.: 4 11/16 (119.1)</p> <p>Inlet: [1] 1/4-18 In. NPT</p> <p>Outlet: [2] 1/4-18 In. NPT</p> <p>Height: 3 3/32 (78.6)</p>	<p>FB1309</p> 	<p>Primary Fuel Filter Base for Detroit Diesel Engines</p> <p>Notes: Converts F844-A from element to spin-on.</p> <p>Contains: Threaded Stud: 1 1/4-12</p> <p>Use With: BF784</p> <p>O.D.: 5 1/2 (139.7)</p> <p>Inlet: 1/2-14 NPSF</p> <p>Outlet: [2] 1/2-14 NPSF</p> <p>Height: 2 23/32 (69.1)</p>
<p>OB1303</p> 	<p>Full-Flow Lube Filter Base for Detroit Diesel Engines</p> <p>Notes: Converts P20-HD from element to spin-on.</p> <p>Contains: Threaded Stud: 1 1/2-12 Lock Plate</p> <p>Use With: B95, B96</p> <p>O.D.: 5 1/32 (127.8)</p> <p>Height: 3 1/2 (88.9)</p> <p>F. Gskt: [4] Included</p>	<p>FB1310</p> 	<p>Secondary Fuel Filter Base for Detroit Diesel Engines</p> <p>Notes: Converts PF846 from element to spin-on.</p> <p>Contains: Threaded Stud: 1 1/16-16</p> <p>Use With: BF785</p> <p>O.D.: 5 1/2 (139.7)</p> <p>Inlet: 3/8-18 NPSF & 1/2-14 NPSF</p> <p>Outlet: [4] 3/8-18 NPSF</p> <p>Height: 2 13/16 (71.4)</p>
<p>OB1305</p> 	<p>By-Pass Lube Filter Base</p> <p>Contains: Threaded Stud: 5/8-18</p> <p>Use With: B50, B164, BT341</p> <p>O.D.: 4 1/4 (108.0)</p> <p>Inlet: 1/8 In. NPT</p> <p>Outlet: 1/8 In. NPT</p> <p>Height: 2 3/4 (69.9)</p>	<p>FB1311</p> 	<p>Fuel/Water Separator Base</p> <p>Notes: This base requires the D-Ring, furnished with filter, for installation. Permits the addition of a remote mount fuel/water separator spin-on to most equipment. This is standard Cummins engine fuel filter mount.</p> <p>Contains: Bracket Bolt Holes 3/8-16 UNC-2B Threaded Stud: 1-14</p> <p>Use With: BF948, BF957, BF957-D, BF1212, BF1249, BF1252, BF1258, BF1259, BF1282, BF5801, BF5812, BF7557, BF7558</p> <p>O.D.: 3 19/32 (91.3)</p> <p>Inlet: 7/8-14</p> <p>Outlet: 7/8-14</p> <p>Height: 1 15/16 (49.2)</p>
<p>FB1306</p> 	<p>Fuel Filter Base</p> <p>Contains: Threaded Stud: 1 1/4-12</p> <p>Use With: BF1216</p> <p>Replaces: Fleetguard 3302367S</p> <p>Inlet: 7/8-14</p> <p>Outlet: 7/8-14</p> <p>Height: 5 7/32 (132.6)</p>		

Measurements Are Shown In Inches And (Millimeters)

WARNING: These products can expose you to chemicals, including Diisononyl Phthalate, Carbon black extracts, Nickel, 1,3 Butadiene, Ethylene Oxide, Epichlorohydrin, which are known to the State of California to cause cancer, and Bisphenol, Ethylene Glycol, Ethylene Oxide, 1,3 Butadiene, Epichlorohydrin, which are known to the State of California to cause birth defects or other reproductive harm. For more information go to www.P65Warnings.ca.gov.

OB1313

Hydraulic Filter Base



Notes: This base requires the use of the G286-C gasket (furnished with BT387, BT387-10, BT388, BT388-10 and BT8424-MPG, optional on others) for installation of the filters listed below. For use on the suction side.
Contains: 3 PSID By-Pass Valve
 Threaded Stud: 1 1/2-16
 Threaded Stud: 1 1/4-11 BSP
Use With: BT287, BT287-10, BT287-3, BT351, BT387, BT387-10, BT388, BT388-10, BT389, BT389-10, BT8368, BT8423
O.D.: 5 1/2 (139.7)
Inlet: 1 1/4 NPT
Outlet: 1 1/4 NPT
Height: 5 5/16 (134.9)

OB1314

Hydraulic Filter Base



Notes: This base requires the use of the G286-C gasket (furnished with BT387, BT387-10, BT388, BT388-10 and BT8424-MPG, optional on others) for installation of the filters listed below. For use on the return side.
Contains: 25 PSID By-Pass Valve
 Threaded Stud: 1 1/2-16
 Threaded Stud: 1 1/4-11 BSP
Use With: BT287, BT287-10, BT287-3, BT351, BT387, BT387-10, BT388, BT388-10, BT389, BT389-10, B7011, BT8307-MPG, BT8308-MPG, BT8308-MPG KIT, BT8309-MPG, BT8310-MPG, BT8368, BT8421-MPG, BT8422-MPG, BT8423
O.D.: 5 1/2 (139.7)
Inlet: 1 1/4 In. NPT
Outlet: 1 1/4 In. NPT
Height: 5 5/16 (134.9)

OB1315

Hydraulic Filter Base



Notes: This base requires the use of the G286-C gasket (furnished with BT387, BT387-10, BT388, BT388-10 and BT8424-MPG, optional on others) for installation of the filters listed below. For use on the suction side.
Contains: 5 PSID By-Pass Valve
 Threaded Stud: 1 1/2-16
 Threaded Stud: 1 1/4-11 BSP
Use With: BT287, BT287-10, BT287-3, BT351, BT387, BT387-10, BT388, BT388-10, BT389, BT389-10, B7011, BT8368, BT8423
O.D.: 5 13/32 (137.3)
Inlet: 1 5/8-12 In. SAE
Outlet: 1 5/8-12 In. SAE
Height: 5 5/16 (134.9)

OB1316

Hydraulic Filter Base



Notes: This base requires the use of the G286-C gasket (furnished with BT387, BT387-10, BT388, BT388-10 and BT8424-MPG, optional on others) for installation of the filters listed below. For use on the return side.
Contains: 25 PSID By-Pass Valve
 Threaded Stud: 1 1/2-16
 Threaded Stud: 1 1/4-11 BSP
Use With: BT287, BT287-10, BT287-3, BT351, BT387, BT387-10, BT388, BT388-10, BT389, BT389-10, B7011, BT8307-MPG, BT8308-MPG, BT8308-MPG KIT, BT8309-MPG, BT8310-MPG, BT8368, BT8421-MPG, BT8422-MPG, BT8423, BT842
O.D.: 5 13/32 (137.3)
Inlet: 1 5/8-12 In. SAE
Outlet: 1 5/8-12 In. SAE
Height: 5 5/16 (134.9)

OB1317

Hydraulic Filter Base



Notes: Has [2] 1/8 In. NPT indicator ports that are designed to accept the VG1325 vacuum gauge.
 Top-mount bracket holes can be used for easy installation.
 For use on suction side.
Contains: 5 PSID By-Pass Valve
 Threaded Stud: 1-12
Use With: BT839, BT839-10, BT8420
O.D.: 3 3/4 (95.3)
Inlet: 3/4-14 NPT
Outlet: 3/4-14 NPT
Height: 3 (76.2)

OB1318

Hydraulic Filter Base



Notes: Has [2] 1/8 In. NPT indicator ports that are designed to accept the PG1326 pressure gauge.
 Top-mount bracket holes can be used for easy installation. For use on return side.
Contains: 25 PSID By-Pass Valve
 Threaded Stud: 1-12
Use With: BT839, BT839-10, BT8420, BT8428-MPG, BT8443
O.D.: 3 (76.2)
Inlet: 3/4 In. NPT
Outlet: 3/4 In. NPT
Height: 3 3/4 (95.3)

OB1319

Hydraulic Filter Base



Notes: Has [2] 1/8 In. NPT indicator ports that are designed to accept the VG1325 vacuum gauge.
 Top-mount bracket holes can be used for easy installation.
 For use on suction side.
Contains: 5 PSID By-Pass Valve
 Threaded Stud: 1-12
Use With: BT839, BT839-10, BT8420
O.D.: 3 3/4 (95.3)
Inlet: 1 1/16-12 ORB
Outlet: 1 1/16-12 ORB
Height: 3 (76.2)

Measurements Are Shown In Inches And (Millimeters)

WARNING: These products can expose you to chemicals, including Diisononyl Phthalate, Carbon black extracts, Nickel, 1,3 Butadiene, Ethylene Oxide, Epichlorohydrin, which are known to the State of California to cause cancer, and Bisphenol, Ethylene Glycol, Ethylene Oxide, 1,3 Butadiene, Epichlorohydrin, which are known to the State of California to cause birth defects or other reproductive harm. For more information go to www.P65Warnings.ca.gov.

OB1320

Hydraulic Filter Base



Notes: Has [2] 1/8 In. NPT indicator ports that are designed to accept the PG1326 pressure gauge.
Top-mount bracket holes can be used for easy installation. For use on return side.
Contains: 25 PSID By-Pass Valve
Threaded Stud: 1-12
Use With: BT839, BT839-10, BT8420, BT8428-MPG, BT8443
O.D.: 3 3/4 (95.3)
Inlet: 1 1/16-12 ORB
Outlet: 1 1/16-12 ORB
Height: 3 (76.2)

VG1325

Vacuum Gauge



Notes: This 0-30 vacuum gauge is for use with a 3-5 PSI by-pass filter base.
Mounts directly to base with 1/8" In. NPT.
Replaces: Donaldson P777021

PG1326

Pressure Gauge



Notes: This pressure gauge is for use with a 25 PSI by-pass filter base.
Mounts directly to base with 1/8 Inch NPT.
The indicator is 2 inches in diameter and measures 0-60 psi.
Replaces: Donaldson P777004

BF1329

Fuel/Water Separator Spin-on with Drain



Contains: Integral Post Seal
Fits: Racor 690R Series Assemblies; Scania, Volvo Trucks
Replaces: Racor R90P; John Deere RE500186
Thread: 1 -14
O.D.: 4 9/32 (108.7)
Height: 8 1/8 (206.4)
I.Gskt: [1] Included
Related To: BF1329-SP (SP Thd. 9/16-18)
BF1339-SP (SP Thd. 1/2-20)
BF46072 (Bowl Version)
BF46083-O (Open End for Bowl Version)

BF1329-SP

Fuel/Water Separator Spin-on with Drain and Sensor Port



Notes: May use OP8750 to plug Sensor Port.
Contains: Integral Post Seal
Sensor Port Thread: 9/16-18
Fits: Racor 690R Series Assemblies; Scania, Volvo Trucks
Replaces: Racor R90P; GMC 23514654; John Deere RE500186
Thread: 1 -14
O.D.: 4 9/32 (108.7)
Height: 8 1/8 (206.4)
I.Gskt: [1] Included
O-Ring: [1] Included
Related To: BF1329 (Drain Version)
BF1339-SP (SP Thd. 1/2-20)
BF46072 (Bowl Version)
BF46083-O (Open Port Version)

BF1330-SP

Fuel/Water Separator Spin-on with Drain and Sensor Port



Notes: CAUTION: Furnished O-Ring must be installed on post for seal.
Contains: Integral Post Seal
Sensor Port Thread: 9/16-18
Fits: Detroit Diesel Engines
Replaces: Detroit Diesel 23514654
Thread: 1 -14
O.D.: 4 9/32 (108.7)
Height: 8 1/8 (206.4)
I.Gskt: [1] Included
O-Ring: [1] Included

BF1339-SP

Fuel/Water Separator Spin-on with Drain and Sensor Port



Notes: CAUTION: Furnished O-Ring must be installed on post for seal.
Contains: Integral Post Seal
Sensor Port Thread: 1/2-20
Fits: Freightliner, Volvo Buses, Trucks; Racor 690R Series Assemblies
Replaces: Racor R90P
Thread: 1 -14
O.D.: 4 9/32 (108.7)
Height: 8 1/8 (206.4)
I.Gskt: [1] Included
O-Ring: [1] Included
Related To: BF1329-SP (SP Thd. 9/16-18)
BF9898-O (Open Port Version)
BF46083-O (Bowl Version)
BF1329 (Drain Version)

BF1345

Fuel/Water Separator Spin-on with Drain



Contains: Integral Post Seal
Fits: International Engines
Replaces: International 1618385-C91, 1677004-C91
Thread: 1 -14
O.D.: 4 1/4 (108.0)
Height: 6 9/16 (166.7)
I.Gskt: [1] Included
Related To: BF1345-O (Open Port Version)
BF1345-SP (Sensor Port Version)

Measurements Are Shown In Inches And (Millimeters)

WARNING: These products can expose you to chemicals, including Diisononyl Phthalate, Carbon black extracts, Nickel, 1,3 Butadiene, Ethylene Oxide, Epichlorohydrin, which are known to the State of California to cause cancer, and Bisphenol, Ethylene Glycol, Ethylene Oxide, 1,3 Butadiene, Epichlorohydrin, which are known to the State of California to cause birth defects or other reproductive harm. For more information go to www.P65Warnings.ca.gov.

BF1345-O

Fuel/Water Separator Spin-on with Open End for Bowl



Contains: Bowl Thread: 3-12
Fits: International Engines, Trucks
Replaces: International 1618385-C91; Donaldson P550729
Thread: 1 -14
O.D.: 4 1/4 (108.0)
Height: 5 9/32 (134.1)
F. Gskt: [1] Included
O-Ring: [1] Included
Related To: BF1345 (Standard Version) BF1345-SP (Sensor Port Version)

BF1345-SP

Fuel/Water Separator Spin-on with Drain and Sensor Port



Notes: May use OP8751 to plug Sensor Port.
Contains: Integral Post Seal
 Sensor Port Thread: 7/16-20
Fits: International Engines
Replaces: International 1618385-C91, 1677004-C91
Thread: 1 -14
O.D.: 4 1/4 (108.0)
Height: 6 9/16 (166.7)
I.Gskt: [1] Included
F. Gskt: [1] Included
Related To: BF1345 (Drain Version) BF1345-O (Open Port Version)

BF1346

Fuel/Water Separator Spin-on with Drain



Contains: Integral Post Seal
Fits: Ford, Freightliner, International, Sterling, Western Star Trucks; Mercedes-Benz Engines; Racor Housings
Replaces: International 1685159-C91
Thread: 1 -14
O.D.: 4 1/4 (108.0)
Height: 8 9/32 (210.3)
I.Gskt: [1] Included
Related To: BF1346-SP (Sensor Port Version) BF1346-O (Open Port Version)

BF1346-O

Fuel/Water Separator Spin-on with Open End for Bowl



Contains: Bowl Thread: M95 x 2.5
 Integral Post Seal
Fits: Ford, Freightliner, International, Sterling, Western Star Trucks; Mercedes-Benz Engines; Racor Housings
Replaces: Racor S3226P; Donaldson P550554; Fleetguard FS19593
Thread: 1 -14
O.D.: 4 1/4 (108.0)
Height: 6 5/16 (160.3)
A. Gskt: [1] Included
F. Gskt: [1] Included
Related To: BF1346 (Drain Version) BF1346-SP (Sensor Port Version)

BF1346-SP

Fuel/Water Separator Spin-on with Drain and Sensor Port



Notes: May use OP8752 to plug Sensor Port.
Contains: Integral Post Seal
 Sensor Port Thread: 1/2-20
Fits: Ford, Freightliner, International, Sterling, Western Star Trucks; Mercedes-Benz Engines; Racor Housings
Replaces: Alliance ABP/N122-S3226FL02; International 1685159-C91
Thread: 1 -14
O.D.: 4 1/4 (108.0)
Height: 8 9/32 (210.3)
I.Gskt: [1] Included
O-Ring: [1] Included
Related To: BF1346 (Drain Version) BF1346-O (Open Port Version)

BF1347

Fuel/Water Separator Spin-on with Drain



Contains: Integral Post Seal
Fits: Optional Fuel/Water Separator on Various Truck Engines with Maximum Flow Rate of 75 GPH (U.S.)
Replaces: Alliance ABP/N122-S3226FL01; Racor S3226T
Thread: 1 -14
O.D.: 4 1/4 (108.0)
Height: 8 9/32 (210.3)
I.Gskt: [1] Included
Related To: BF1347-O (Open Port Version)

BF1347-O

Fuel/Water Separator Spin-on with Open End for Bowl



Contains: Bowl Thread 3.75-10 UNS-2B
 Integral Post Seal
Fits: Freightliner Chassis; Freightliner, International, Kenworth Trucks; Thomas Buses
Replaces: Racor S3226T; AC Delco TP1348; Donaldson P551034; Fleetguard FS19933, FS19798; Wix 33813
Thread: 1 -14 UNS-2B
O.D.: 4 3/8 (111.1)
Height: 6 7/32 (158.0)
F. Gskt: [2] Included
Related To: BF1347 (Drain Version)

BF1348

Fuel/Water Separator Spin-on with Drain



Contains: Integral Post Seal
Fits: Blue Bird Buses; Freightliner, Hino, Peterbilt Trucks; Racor 325 Series
Replaces: Racor S3225P
Thread: 1 -14
O.D.: 4 5/16 (109.5)
Height: 6 25/32 (172.2)
I.Gskt: [1] Included
Related To: BF1348-O (Open Port Version) BF1348-SP (Sensor Port Version)

Measurements Are Shown In Inches And (Millimeters)

WARNING: These products can expose you to chemicals, including Diisononyl Phthalate, Carbon black extracts, Nickel, 1,3 Butadiene, Ethylene Oxide, Epichlorohydrin, which are known to the State of California to cause cancer, and Bisphenol, Ethylene Glycol, Ethylene Oxide, 1,3 Butadiene, Epichlorohydrin, which are known to the State of California to cause birth defects or other reproductive harm. For more information go to www.P65Warnings.ca.gov.

BF1348-O Fuel/Water Separator Spin-on with Open End for Bowl



Contains: Bowl Thread: M95 x 2.5
Integral Post Seal
Fits: Blue Bird Buses; Freightliner, Hino, Peterbilt Trucks; Racor 325 Series
Replaces: Racor S3225P
Thread: 1 -14
O.D.: 4 1/4 (108.0)
Height: 5 3/16 (131.8)
A. Gskt: [1] Included
O-Ring: [1] Included
Related To: BF1348 (Standard Version)
BF1348-SP (Sensor Port Version)

BF1348-SP Fuel/Water Separator Spin-on with Drain and Sensor Port



Notes: May use OP8752 to plug Sensor Port.
Contains: Integral Post Seal
Sensor Port Thread: 1/2-20
Fits: Blue Bird Buses; Freightliner, Hino, Peterbilt Trucks; Racor 325 Series
Replaces: Racor S3225P
Thread: 1 -14
O.D.: 4 5/16 (109.5)
Height: 6 25/32 (172.2)
I.Gskt: [1] Included
O-Ring: [1] Included
Related To: BF1348 (Drain Version)
BF1348-O (Open Port Version)

BF1349 Fuel/Water Separator Spin-on with Drain



Contains: Integral Post Seal
Fits: Cummins Engines; Volvo Trucks
Replaces: Racor R90T
Thread: 1 -14
O.D.: 4 9/32 (108.7)
Height: 8 7/32 (208.8)
I.Gskt: [1] Included

BF1350-SP Fuel/Water Separator Spin-on with Drain and Sensor Port



Notes: CAUTION: Furnished O-Ring must be installed on post for seal.
Contains: Sensor Port Thread: 1/2-20
Fits: Caterpillar Engines; Equipment
Replaces: Caterpillar 146-6695
Thread: 1 -14
O.D.: 3 11/16 (93.7)
Height: 7 13/16 (198.4)
I.Gskt: [1] Included
O-Ring: [1] Included
Related To: BF46030-O (Open Port Version)

BF1352-SPS Fuel/Water Separator Spin-on with Drain, Sensor Port and Reusable Sensor



Notes: CAUTION: Furnished D-Ring must be installed on post for seal.
Contains: Sensor Port Thread: M14 x 2.0
Fits: Agco, Hesston, Hyundai, Massey Ferguson Equipment; Cummins B4.5, B5.9L, QSB4.5 Engines
Replaces: Cummins 3991498; Fleetguard FS19616
Thread: M20 x 1.5
O.D.: 3 11/16 (93.7)
Height: 7 3/8 (187.3)
I.Gskt: [1] Included
F. Gskt: [1] Included

BF1353-SPS Fuel/Water Separator Spin-on with Drain, Sensor Port and Sensor



Contains: Integral Post Seal
Sensor Port Thread: M14 x 2.0
Fits: John Deere Engines, Equipment, Trucks
Replaces: John Deere RE522372; Fleetguard FS19688
Thread: 1 -12
O.D.: 4 1/4 (108.0)
Height: 11 11/16 (296.9)
I.Gskt: [1] Included

BF1354-SPS Primary Fuel/Water Separator Spin-on with Drain, Sensor Port and Reusable Sensor



Contains: Integral Post Seal
Sensor Port Thread: M14 x 2.0
Fits: John Deere Engines, Equipment, Trucks
Replaces: John Deere RE531703; Donaldson P550668; Fleetguard FS19701
Thread: 1 -14
O.D.: 4 1/4 (108.0)
Height: 11 11/16 (296.9)
I.Gskt: [1] Included

BF1355 Fuel/Water Separator Spin-on with Drain



Contains: Integral Post Seal
Fits: Thermo King Refrigeration Units; Volvo Trucks
Thread: 1 1/4 -12
O.D.: 4 11/16 (119.1)
Height: 8 29/32 (226.2)
I.Gskt: [1] Included
Related To: BF1355-SP (Sensor Port Version)
BF1355-O (Open Port Version)

BF1355-O Fuel/Water Separator Spin-on with Open End for Bowl



Contains: Bowl Thread: M95 x 2.5
Integral Post Seal
Fits: Volvo VN Series, VN730, VNL300, VNL430, VNL730 Trucks
Replaces: Racor S3238P; Thermo King 11-9982, Volvo 85104856
Thread: 1 1/4 -12
O.D.: 4 7/8 (123.8)
Height: 6 5/16 (160.3)
A. Gskt: [1] Included
F. Gskt: [1] Included
Related To: BF1355 (Drain Version)
BF1355-SP (Sensor Port Version)

Measurements Are Shown In Inches And (Millimeters)

WARNING: These products can expose you to chemicals, including Diisononyl Phthalate, Carbon black extracts, Nickel, 1,3 Butadiene, Ethylene Oxide, Epichlorohydrin, which are known to the State of California to cause cancer, and Bisphenol, Ethylene Glycol, Ethylene Oxide, 1,3 Butadiene, Epichlorohydrin, which are known to the State of California to cause birth defects or other reproductive harm. For more information go to www.P65Warnings.ca.gov.

BF1355-SP Fuel/Water Separator Spin-on with Drain and Sensor Port



Notes: May use OP8752 to plug Sensor Port.
Contains: Integral Post Seal
 Sensor Port Thread: 1/2-20
Fits: Thermo King Refrigeration Units; Volvo Trucks
Replaces: Racor S3238P; Thermo King 11-9982
Thread: 1 1/4 -12
O.D.: 4 11/16 (119.1)
Height: 8 7/8 (225.4)
I.Gskt: [1] Included
O-Ring: [1] Included
Related To: BF1355 (Drain Version)
 BF1355-O (Open Port Version)

BF1359-SP Fuel/Water Separator Spin-on with Drain and Sensor Port



Notes: CAUTION: Furnished O-Ring must be installed on post for seal.
Contains: Integral Post Seal
 Sensor Port Thread: 1/2-20
Fits: Volvo Dump Trucks, Loaders
Thread: 1 -14
O.D.: 4 1/4 (108.0)
Height: 11 1/8 (282.6)
I.Gskt: [1] Included
O-Ring: [1] Included
Related To: BF1391-O (Open Port Version)

BF1356 Fuel/Water Separator Spin-on with Drain



Fits: Cummins Engines
Replaces: Cummins 3991350; Fleetguard FS19608
Thread: M20 x 1.5
O.D.: 3 11/16 (93.7)
Height: 7 13/32 (188.1)
I.Gskt: G381-A
F. Gskt: [1] Included
End Seals: [1] Included

BF1360 Fuel/Water Separator Spin-on with Drain



Contains: Integral Post Seal
Fits: Hino Trucks
Replaces: Hino 23401-1700
Thread: 1 -14
O.D.: 4 9/32 (108.7)
Height: 8 7/32 (208.8)
I.Gskt: [1] Included
Related To: BF1360-O (Open Port Version)
 BF1360-SP (Sensor Port Version)

BF1357 Fuel/Water Separator Spin-on with Drain



Contains: Integral Post Seal
Fits: Komatsu Equipment
Replaces: Komatsu 600-311-3410, 600-319-3400
Thread: 1 1/4 -12
O.D.: 4 11/16 (119.1)
Height: 12 3/32 (307.2)
I.Gskt: [1] Included
Related To: BF1288-O (Open Port Version)

BF1360-O Fuel/Water Separator Spin-on with Open End for Bowl



Contains: Bowl Thread: 3 3/4-10 Buttress
Fits: Blue Bird All-American, Vision Buses
Replaces: Racor R90S; Donaldson P551854; Fleetguard FS20028
Thread: 1 -14
O.D.: 4 9/32 (108.7)
Height: 5 21/32 (143.7)
F. Gskt: [2] Included
Related To: BF1360 (Standard Version)
 BF1360-SP (Sensor Port Version)

BF1358-O Fuel/Water Separator Spin-on with Open End for Bowl



Contains: Integral Post Seal
 Bowl Thread: 3 3/4-10
Fits: Volvo Dump Trucks, Equipment
Replaces: Volvo 11110474, 11110668
Thread: 1 -14
O.D.: 4 13/32 (111.9)
Height: 8 19/32 (218.3)
A. Gskt: [1] Included
F. Gskt: [1] Included
Related To: BF1358-SP (Sensor Port Version)

BF1360-SP Fuel/Water Separator Spin-on with Drain and Sensor Port



Notes: CAUTION: Furnished O-Ring must be installed on post for seal.
 May use OP8752 to plug Sensor Port.
Contains: Integral Post Seal
 Sensor Port Thread: 1/2-20
Fits: Blue Bird Buses; Caterpillar, Cummins Engines
Replaces: Racor R90S
Thread: 1 -14
O.D.: 4 9/32 (108.7)
Height: 8 1/8 (206.4)
I.Gskt: [1] Included
O-Ring: [1] Included
Related To: BF1360 (Standard Version)
 BF1360-O (Open Port Version)

BF1358-SP Fuel/Water Separator Spin-on with Drain and Sensor Port



Notes: CAUTION: Furnished O-Ring must be installed on post for seal.
Contains: Integral Post Seal
 Sensor Port Thread: 9/16-18
Fits: Volvo Dump Trucks, Equipment
Replaces: Volvo 11110474, 11110668
Thread: 1 -14
O.D.: 4 9/32 (108.7)
Height: 11 (279.4)
I.Gskt: [1] Included
O-Ring: [1] Included
Related To: BF1358-O (Open Port Version)

BF1361 Fuel Spin-on with Drain



Fits: Case-International Tractors
Replaces: Case 47128205; New Holland 19305811
Thread: M14 x 1.5
O.D.: 3 11/16 (93.7)
Height: 4 11/16 (119.1)
I.Gskt: G381-A

Measurements Are Shown In Inches And (Millimeters)

WARNING: These products can expose you to chemicals, including Diisononyl Phthalate, Carbon black extracts, Nickel, 1,3 Butadiene, Ethylene Oxide, Epichlorohydrin, which are known to the State of California to cause cancer, and Bisphenol, Ethylene Glycol, Ethylene Oxide, 1,3 Butadiene, Epichlorohydrin, which are known to the State of California to cause birth defects or other reproductive harm. For more information go to www.P65Warnings.ca.gov.

BF1362

Fuel Spin-on with Drain



Fits: Freightliner, Sterling Trucks
Replaces: Alliance ABP/N122-R50404;
 Fleetguard FS19807; Racor R50404
Thread: 1 -14
O.D.: 4 1/4 (108.0)
Height: 6 13/16 (173.0)
I.Gskt: [1] Included

BF1363

Fuel Spin-on with Drain



Fits: Doppstadt AK430 Shredder with
 Mercedes-Benz OM501LA Engine
Replaces: Mercedes-Benz A0004771302,
 4771302
Thread: 1 -14
O.D.: 4 1/4 (108.0)
Height: 11 7/32 (285.0)
I.Gskt: [1] Included

BF1365

Fuel/Water Separator Spin-on with Drain



Fits: Iveco Trucks
Replaces: Iveco 2992662; Mann & Hummel
 WK950/19
Thread: M16 x 1.5
O.D.: 3 11/16 (93.7)
Height: 7 13/32 (188.1)
I.Gskt: G381-A

BF1366-O

Fuel/Water Separator Spin-on with Open End
 for Bowl



Contains: Bowl Thread: M80 x 2.5
 Integral Post Seal
Fits: R.V.I., Volvo Trucks
Replaces: Volvo 20998367; Donaldson
 P559628; Fleetguard FS19735
Thread: 1 -14
O.D.: 3 21/32 (92.9)
Height: 5 5/8 (142.9)
A. Gskt: [1] Included
O-Ring: [1] Included

BF1367

Fuel/Water Separator Spin-on with Drain



Fits: Iveco Engines
Replaces: Iveco 504048025; New Holland
 87803192, 87803196; Fleetguard FS19597
Thread: M16 x 1.5
O.D.: 3 1/32 (77.0)
Height: 6 21/32 (169.1)
I.Gskt: G449-B
F. Gskt: [1] Included

OB1368

Full-Flow Lube Filter Base for Cummins
 Engines



Notes: Converts P999-HD from element to
 spin-on.
Contains: Threaded Stud: 1 1/2-12
 [1] Instruction Sheet
Fits: 1968 and Earlier Cummins Engines
Use With: B96, B196, B205
O.D.: 6 5/8 (168.3)
Height: 4 1/4 (108.0)
F. Gskt: [1] Capscrew, [3] Included, [2]
 Washers

BF1370

Fuel/Water Separator Spin-on with Drain



Contains: Integral Post Seal
Fits: New Holland Equipment
Replaces: New Holland 8446332
Thread: 1 -14
O.D.: 4 5/16 (109.5)
Height: 6 25/32 (172.2)
I.Gskt: [1] Included

BF1371

Fuel/Water Separator Spin-on with Drain and
 Sensor Port



Notes: CAUTION: Furnished O-Ring must be
 installed on post for seal.
 Remove rubber paint plug before installation.
Contains: Sensor Port Thread: M10 x 1.5
Fits: Case Loaders, Tractors
Replaces: Case 87803182; Cummins 2830359;
 Fleetguard FS19772
Thread: M16 x 1.5
O.D.: 3 11/16 (93.7)
Height: 7 31/32 (202.4)
I.Gskt: G401
O-Ring: [1] Included

BF1372

Fuel/Water Separator Spin-on with Drain



Contains: Integral Post Seal
Fits: Liebherr Equipment; M.A.N. Trucks
Replaces: Liebherr 7008775, 7382048; M.A.N.
 51.12503.0040; Donaldson P550498; Fleetguard
 FS19599
Thread: M16 x 1.5
O.D.: 3 1/32 (77.0)
Height: 5 29/32 (150.0)
I.Gskt: [1] Included

BF1373-SP

Fuel/Water Separator Spin-on with Drain and
 Sensor Port



Contains: Integral Post Seal
 Sensor Port Thread: 1/2-20
Fits: Freightliner Trucks
Replaces: Alliance ABP/N122-R50419,
 ABP/N122-S3226FL01; Freightliner
 ABPS3226FL01
Thread: 1 -14
O.D.: 4 9/32 (108.7)
Height: 8 1/8 (206.4)
I.Gskt: [1] Included
O-Ring: [1] Included
Related To: BF46098-O (Open End Version)

Measurements Are Shown In Inches And (Millimeters)

WARNING: These products can expose you to chemicals, including Diisononyl Phthalate, Carbon black extracts, Nickel, 1,3 Butadiene, Ethylene Oxide, Epichlorohydrin, which are known to the State of California to cause cancer, and Bisphenol, Ethylene Glycol, Ethylene Oxide, 1,3 Butadiene, Epichlorohydrin, which are known to the State of California to cause birth defects or other reproductive harm. For more information go to www.P65Warnings.ca.gov.

BF1374-SP Fuel/Water Separator Spin-on with Drain and Sensor Port
Contains: Sensor Port Thread: 9/16-18
Fits: Caterpillar Excavators, Material Handlers
Replaces: Caterpillar 1R0781
Thread: 1 -14
O.D.: 4 1/4 (108.0)
Height: 9 7/32 (234.2)
I.Gskt: [1] Included
O-Ring: [1] Included



BF1375 Fuel Spin-on with Drain
Contains: Integral Post Seal
Fits: Freightliner Coronado, CC132, FLD Trucks with Detroit Diesel Series 60 Engine
Replaces: Alliance ABP/N122-R50422
Thread: 1 -14
O.D.: 4 9/32 (108.7)
Height: 9 31/32 (253.2)
I.Gskt: [1] Included



BF1376 Fuel Spin-on with Drain
Fits: Freightliner, Sterling Trucks with Caterpillar Engines
Replaces: Alliance ABP/N12232FRT02
Thread: 1 -14
O.D.: 3 11/16 (93.7)
Height: 7 13/32 (188.1)
I.Gskt: G381-A
F. Gskt: [1] Included



BF1377 Fuel/Water Separator Spin-on with Drain
Fits: Freightliner Coronado, CC132 with Detroit Diesel Series 60 Engine
Replaces: Alliance ABP/N122-R50416
Thread: 1 -14
O.D.: 4 1/4 (108.0)
Height: 9 31/32 (253.2)
I.Gskt: [1] Included



BF1378-SPS Fuel/Water Separator Spin-on with Sensor Port, Drain and Reusable Sensor
Notes: CAUTION: Furnished D-Ring must be installed on post for seal.
 May use OP8753 to plug Sensor Port.
Contains: Sensor Port Thread: M14 x 2.0
Fits: Cummins, Paccar Engines; Freightliner, Kenworth, Peterbilt Trucks
Replaces: Cummins 4934879; Fleetguard FS1065
Thread: 1 -14
O.D.: 3 23/32 (94.5)
Height: 10 1/32 (254.8)
I.Gskt: G381-A
O-Ring: ES24-D



BF1379 Fuel/Water Separator Spin-on with Drain and Sensor Port
Notes: Inside-Out Flow Direction
Contains: Integral Post Seal
 Sensor Port Thread: 1/2-20
Fits: Next Generations UCM1 Generators; Truck Gen Hybrid, UCRV 1-3.5, UCT 1-3.5 Auxilliary Power Units
Replaces: Racor R12S; Fleetguard FS19628
Thread: M18 x 1.5
O.D.: 3 1/32 (77.0)
Height: 4 19/32 (116.7)
I.Gskt: [1] Included
Related To: BF1379-O (with Open End for Bowl)



BF1379-O Fuel/Water Separator with Open End for Bowl
Notes: Inside-Out Flow Direction
Contains: Bowl Thread 2 3/8 - 10 BSW
Fits: Idlebuster, Truck Gen Auxiliary Power Units (APUs); Next Generations Generators all with Kubota Eng's.
Replaces: Ditch Witch 159047; Racor R12S, R12SUL; Fleetguard FS19628; Fram PS10975; Luber-finer LFF8676; Wix 33582, 533582
Thread: M18 x 1.5
O.D.: 3 1/32 (77.0)
Height: 2 3/8 (60.2)
F. Gskt: [1] Included
O-Ring: [1] Included
Related To: BF1379 (with Drain and Sensor Port)



BF1380 Fuel/Water Separator Spin-on with Drain and Sensor Port
Notes: Inside-Out Flow Direction
Contains: Integral Post Seal
 Sensor Port Thread: 1/2-20
Fits: Ampac P33/24 Compactor; Powerpac APUC, APUC, Power Tech Auxilliary Power Units; Toro Reelmaster Mowers
Replaces: Racor R12T; Fleetguard FS19802
Thread: M18 x 1.5
O.D.: 3 1/32 (77.0)
Height: 4 19/32 (116.7)
I.Gskt: [1] Included
Related To: BF1380-O (with Open End for Bowl)













BF1380-O Fuel/Water Separator Spin-on with Open End for Bowl
Notes: Inside-Out Flow Direction
Fits: Ampac P33/24 Compactor w/Lister LPA2 Engine; Bandit Industries 2100SP Stump Grinder w/Lombardini 6LBDL1.25910 Engine; Idlebuster Auxiliary Power Unit w/Kubota Z482 Engine; Power Tech Auxilliary Power Units Models w/Cat C0.5 Eng., Kubota Z482 Engine
Replaces: Racor R12T
Thread: M18 x 1.5
O.D.: 3 (75.9)
Height: 2 7/16 (62.3)
A. Gskt: [1] Included
F. Gskt: [1] Included
O-Ring: [1] Included
Related To: BF1380 (with Drain and Sensor Port)



Measurements Are Shown In Inches And (Millimeters)

WARNING: These products can expose you to chemicals, including Diisononyl Phthalate, Carbon black extracts, Nickel, 1,3 Butadiene, Ethylene Oxide, Epichlorohydrin, which are known to the State of California to cause cancer, and Bisphenol, Ethylene Glycol, Ethylene Oxide, 1,3 Butadiene, Epichlorohydrin, which are known to the State of California to cause birth defects or other reproductive harm. For more information go to www.P65Warnings.ca.gov.

<p>BF1381</p> 	<p>Fuel/Water Separator Spin-on with Drain and Sensor Port</p> <p>Notes: Inside-Out Flow Direction</p> <p>Contains: Integral Post Seal</p> <p>Sensor Port Thread: 1/2-20</p> <p>Fits: Genie S100, S105, S120, S125 Lifts; Volvo VHD430 Trucks</p> <p>Replaces: Racor R12P; Donaldson P551768; Fleetguard FS19627</p> <p>Thread: M18 x 1.5</p> <p>O.D.: 3 1/32 (77.0)</p> <p>Height: 4 19/32 (116.7)</p> <p>I.Gskt: [1] Included</p> <p>Related To: BF1381-O (with Open end for Bowl)</p>	<p>O-Ring: [1] Included</p> <hr/> <p>BF1385-SPS</p>  <p>Fuel/Water Separator Spin-on with Drain, Sensor Port and Reusable Sensor</p> <p>Contains: Sensor Port Thread: M14 x 2.0</p> <p>Fits: Case Equipment; Cummins Engines</p> <p>Replaces: Case 87356193; Cummins 3973233; Fleetguard FS19732; SF-Filter SK3183</p> <p>Thread: 1 -14</p> <p>O.D.: 3 11/16 (93.7)</p> <p>Height: 7 3/8 (187.3)</p> <p>I.Gskt: G381-A</p> <p>F. Gskt: ES24-D</p>
<p>BF1381-O</p> 	<p>Fuel/Water Separator Spin-on with Open End for Bowl</p> <p>Notes: Bowl Thread: 2 3/8</p> <p>Fits: Genie S100, S105, S120, S125 Lifts; Volvo VHD430 Trucks</p> <p>Replaces: Racor R12P; Donaldson P551768; Fleetguard FS19627</p> <p>Thread: M18 x 1.5</p> <p>O.D.: 3 3/32 (78.6)</p> <p>Height: 2 15/32 (62.7)</p> <p>F. Gskt: [1] Included</p> <p>O-Ring: [1] Included</p> <p>Related To: BF1381 (Drain Version)</p>	<p>BF1386-O</p>  <p>Fuel/Water Separator Spin-on with Open End for Bowl</p> <p>Contains: Bowl Thread: M80 x 2.5</p> <p>Integral Post Seal</p> <p>Fits: Mack, Volvo Engines, Trucks</p> <p>Replaces: Mack 21017305; Volvo 20879806</p> <p>Thread: 1 -14</p> <p>O.D.: 4 1/4 (108.0)</p> <p>Height: 5 3/16 (131.8)</p> <p>F. Gskt: [1] Included</p> <p>O-Ring: [1] Included</p>
<p>BF1382-SP</p> 	<p>Fuel/Water Separator Spin-on with Drain and Sensor Port</p> <p>Contains: Sensor Port Thread: 9/16-18</p> <p>Fits: Challenger Tractors</p> <p>Replaces: Caterpillar 1R0771</p> <p>Thread: 1 -14</p> <p>O.D.: 4 1/4 (108.0)</p> <p>Height: 9 3/8 (238.1)</p> <p>I.Gskt: [1] Included</p> <p>O-Ring: [1] Included</p>	<p>BF1387-O</p>  <p>Fuel/Water Separator Spin-on with Open End for Bowl</p> <p>Contains: Bowl Thread: M80 x 2.5</p> <p>Integral Post Seal</p> <p>Fits: Volvo Engines, Trucks</p> <p>Replaces: Volvo 20879812</p> <p>Thread: 1 -14</p> <p>O.D.: 4 1/4 (108.0)</p> <p>Height: 6 5/16 (160.3)</p> <p>A. Gskt: [1] Included</p> <p>O-Ring: [1] Included</p>
<p>BF1383-O</p> 	<p>Fuel/Water Separator Spin-on with Open End for Bowl</p> <p>Contains: Bowl Thread: B80 x 3 8A Metric Buttress</p> <p>Fits: DAF Engines, Trucks; Doosan, Terex Equipment</p> <p>Replaces: M.A.N. 51.12501.7288, 51.12503.0052; Daewoo K1006529; Parker China Division WBF219</p> <p>Thread: 1 -14</p> <p>O.D.: 4 9/32 (108.7)</p> <p>Height: 9 3/32 (231.0)</p> <p>A. Gskt: [1] Included</p> <p>O-Ring: [1] Included</p>	<p>BF1388-O</p>  <p>Fuel/Water Separator Spin-on with Open End for Bowl</p> <p>Contains: Bowl Thread: M95 x 2.5</p> <p>Integral Post Seal</p> <p>Fits: R.V.I., Volvo Trucks</p> <p>Replaces: R.V.I. 7420851191; Volvo 20853583; Racor R60P-D-MAX; Fleetguard FS19895</p> <p>Thread: 1 -14</p> <p>O.D.: 4 1/4 (108.0)</p> <p>Height: 5 1/8 (130.2)</p> <p>A. Gskt: [1] Included</p> <p>F. Gskt: [1] Included</p> <p>O-Ring: [1] Included</p>
<p>BF1384-SP</p> 	<p>Fuel/Water Separator Spin-on with Drain and Sensor Port</p> <p>Notes: CAUTION: Furnished D-Ring must be installed on post for seal.</p> <p>Contains: Sensor Port Thread: 1/2-20</p> <p>Fits: Mack Trucks with MP7, MP8 Engines</p> <p>Replaces: Mack 20539578</p> <p>Thread: 1 -14</p> <p>O.D.: 3 11/16 (93.7)</p> <p>Height: 7 13/16 (198.4)</p> <p>I.Gskt: [1] Included</p> <p>F. Gskt: [1] Included</p>	<p>BF1389-O</p>  <p>Fuel/Water Separator Spin-on with Open End for Bowl</p> <p>Contains: Bowl Thread: 3 3/4-10 2B Buttress</p> <p>Integral Post Seal</p> <p>Fits: Volvo Engines, Trucks</p> <p>Replaces: Volvo 20381204; Racor R45T; Donaldson P550746; Fleetguard FS19734</p> <p>Thread: 1 -14</p> <p>O.D.: 4 1/4 (108.0)</p> <p>Height: 3 17/32 (89.7)</p> <p>A. Gskt: [1] Included</p> <p>F. Gskt: [1] Included</p>

Measurements Are Shown In Inches And (Millimeters)

WARNING: These products can expose you to chemicals, including Diisononyl Phthalate, Carbon black extracts, Nickel, 1,3 Butadiene, Ethylene Oxide, Epichlorohydrin, which are known to the State of California to cause cancer, and Bisphenol, Ethylene Glycol, Ethylene Oxide, 1,3 Butadiene, Epichlorohydrin, which are known to the State of California to cause birth defects or other reproductive harm. For more information go to www.P65Warnings.ca.gov.

BF1390-O Fuel/Water Separator Spin-on with Open End for Bowl



Contains: Bowl Thread: 3 3/4-10 2B Buttress Integral Post Seal
Fits: Volvo Trucks
Replaces: Racor R90T; Volvo 20450423; Fleetguard FS19551
Thread: 1 -14
O.D.: 4 11/32 (110.3)
Height: 6 3/16 (157.2)
A. Gskt: [1] Included
F. Gskt: [1] Included

BF1394-SP Fuel/Water Separator Spin-on with Drain and Sensor Port



Contains: Sensor Port Thread: M14 x 2.0
Fits: Komatsu Equipment
Replaces: Komatsu 600-311-3610, 600-311-3620, 600-319-3610, 600-319-3620
Thread: 1 -14
O.D.: 3 11/16 (93.7)
Height: 8 7/8 (225.4)
I.Gskt: G401

BF1391-O Fuel/Water Separator Spin-on with Open End for Bowl



Contains: Bowl Thread: M95 x 2.5 Integral Post Seal
Fits: Mercedes-Benz Engines, Trucks
Replaces: Mercedes-Benz 4771302, A0004771302; Racor R160TDMAX; Fleetguard FS19914
Thread: 1 -14
O.D.: 4 1/4 (108.0)
Height: 8 21/32 (219.9)
A. Gskt: [1] Included
F. Gskt: [1] Included
Related To: BF1359-SP (Sensor Port Version)

BF1395-O Fuel/Water Separator Spin-on with Open End for Bowl



Contains: Bowl Thread: M95 x 2.5 Integral Post Seal
Fits: Freightliner Cascadia with Detroit Diesel Series 60 Engine
Replaces: Alliance ABPN122R50421; Racor R120T; Donaldson P551075
Thread: 1 -14
O.D.: 4 13/32 (111.9)
Height: 8 19/32 (218.3)
A. Gskt: [1] Included
F. Gskt: [1] Included
Related To: BF1395-SP (Sensor Port Version) BF1265 (Drain Version)

BF1392-SPS KIT Fuel/Water Separator Element with Drain, Sensor Port and Reusable Sensor



Notes: Replacement Element is PF1392.
Fits: Dodge Light-Duty Trucks, Sterling Bullet all with 6-408 (6.7L) Turbo Diesel Engine
Replaces: Chrysler 5183410AA; Mopar 4936025
O.D.: 4 15/32 (113.5)
I.D.: 3/4 (19.0) One End
Height: 9 3/16 (233.4)
O-Ring: [1] Included
Grommets: [1] Attached

BF1395-SP Fuel/Water Separator Spin-on with Drain and Sensor Port



Notes: CAUTION: Furnished O-Ring must be installed on post for seal.
Contains: Integral Post Seal Sensor Port Thread: 1/2-20
Fits: Freightliner Trucks
Replaces: Alliance ABP/N122R50421; Freightliner RD591300
Thread: 1 -14
O.D.: 4 9/32 (108.7)
Height: 11 7/32 (285.0)
I.Gskt: G579
O-Ring: [1] Included
Related To: BF1395-O (with Open End for Bowl)

PF1392 Fuel Element



Fits Inside: BF1392-SPS KIT
Fits: Dodge Light-Duty Trucks, Sterling Bullet all with 6-408 (6.7L) Turbo Diesel Engine
Replaces: Chrysler 68061634AA; Cummins 5257768
O.D.: 3 27/32 (97.6)
I.D.: 1 3/16 (30.2) One End
Height: 5 29/32 (150.0)
O-Ring: [1] Included
Grommets: [1] Attached

BF1396 Fuel/Water Separator Spin-on with Drain



Fits: M.A.N. Engines
Replaces: M.A.N. 51.12503.0059, 51.12503.0060
Thread: M16 x 1.5
O.D.: 3 1/32 (77.0)
Height: 5 29/32 (150.0)
I.Gskt: [1] Included

BF1393-SP High Efficiency Fuel/Water Separator Spin-on with Drain and Sensor Port



Notes: CAUTION: Furnished O-Ring must be installed on post for seal.
 Can be used with FB1311 base.
Contains: Integral Post Seal Sensor Port Thread: 1/2-20
Replaces: Fleetguard FS1015
Thread: 1 -14
O.D.: 3 11/16 (93.7)
Height: 8 13/16 (223.8)
I.Gskt: G381-A
O-Ring: [2] Included
Related To: BF1249, BF1249-SP (Standard Versions)

Measurements Are Shown In Inches And (Millimeters)

WARNING: These products can expose you to chemicals, including Diisononyl Phthalate, Carbon black extracts, Nickel, 1,3 Butadiene, Ethylene Oxide, Epichlorohydrin, which are known to the State of California to cause cancer, and Bisphenol, Ethylene Glycol, Ethylene Oxide, 1,3 Butadiene, Epichlorohydrin, which are known to the State of California to cause birth defects or other reproductive harm. For more information go to www.P65Warnings.ca.gov.

BF1397-SP

Fuel/Water Separator Spin-on with Drain and Sensor Port



Notes: CAUTION: Furnished O-Ring must be installed on post for seal.
Contains: Sensor Port Thread: 9/16-18 Standpipe
Fits: Caterpillar Equipment
Replaces: Caterpillar 326-1643
Thread: 1 -14
O.D.: 4 1/4 (108.0)
Height: 9 11/32 (237.3)
I.Gskt: [1] Included
F. Gskt: [1] Included
O-Ring: [1] Included

BF1398-O

Fuel/Water Separator Spin-on with Open End for Bowl



Notes: Inside-Out Flow Direction
Contains: Bowl Thread: M80 x 2.5 Integral Post Seal
Fits: Volvo Trucks with D6B Engine
Replaces: Volvo 20386080; Racor R25P; Fleetguard FS19704
Thread: 1 -14
O.D.: 3 21/32 (92.9)
Height: 5 5/8 (142.9)
A. Gskt: [1] Included
O-Ring: [1] Included

BF1399-SP

Fuel/Water Separator Spin-on with Drain and Sensor Port



Notes: CAUTION: Furnished O-Ring must be installed on post for seal.
Contains: Sensor Port Thread: 9/16-18 Standpipe
Fits: Caterpillar Equipment
Replaces: Caterpillar 326-1644
Thread: 1 -14
O.D.: 4 1/4 (108.0)
Height: 7 5/8 (193.7)
I.Gskt: [1] Included
F. Gskt: [1] Included
O-Ring: [1] Included

B1400

Lube Spin-on



Contains: Anti-Drainback Valve
 14 PSID By-Pass Valve
Fits: Ford, Kia, Honda, Mazda, Nissan, Subaru Automotive, Light-Duty Trucks; Kawasaki Motorcycles
Replaces: Mazda B6Y1-14-302, FEY0-14-302
Thread: M20 x 1.5
O.D.: 2 21/32 (67.5)
Height: 2 5/8 (66.7)
I.Gskt: [1] Included
Related To: B1402, B1431 (Long Versions)

B1402

Lube Spin-on



Contains: Anti-Drainback Valve
 14 PSID By-Pass Valve
Fits: Dodge, Eagle, Ford, Honda, Infiniti, Mazda, Mitsubishi, Nissan, Plymouth Automotive
Replaces: Chrysler MD135737; Ford F32Z-6731-A; Mazda JEYO-14-302; Nissan 15208-31U00
Thread: M20 x 1.5
O.D.: 2 9/16 (65.1)
Height: 3 1/2 (88.9)
I.Gskt: [1] Included
Related To: B1400 (Short Version)
 B1431 (Long Version)

BD1403

Dual-Flow Lube Spin-on



Contains: Integral Post Seal
Fits: Caterpillar Excavators, Lift Trucks; Mitubishi Engines, Excavators, Trucks; Nissan Trucks
Replaces: Mitsubishi ME074013, ME074235
Thread: M36 x 1.5
O.D.: 5 1/8 (130.2)
Height: 8 21/32 (219.9)
I.Gskt: [1] Included

B1405

Lube Spin-on



Contains: Anti-Drainback Valve
 20 PSID By-Pass Valve
Fits: Toyota Automotive
Replaces: Toyota 90915-20002
Thread: 3/4 -16
O.D.: 3 1/32 (77.0)
Height: 3 1/2 (88.9)
I.Gskt: G449-B

B1406

Lube Spin-on



Contains: Anti-Drainback Valve
Fits: Infiniti, Nissan Automotive
Replaces: Nissan 15208-53J00
Thread: 3/4 -16
O.D.: 2 11/16 (68.3)
Height: 3 1/2 (88.9)
I.Gskt: [1] Included

B1407

Lube Spin-on



Contains: Anti-Drainback Valve
Fits: Ford, Gehl, Snorkel Equipment
Replaces: Ford 77BM-6714-C1A; Toyota 90915-YZZB5
Thread: 3/4 -16
O.D.: 3 1/32 (77.0)
Height: 3 1/2 (88.9)
I.Gskt: G449-B

B1410













Lube Spin-on



Contains: Anti-Drainback Valve
 8 PSID By-Pass Valve
Fits: Cub Cadet, Ford, Grasshopper, John Deere Lawn Tractors with Kohler Engines
Replaces: Kohler 1205001
Thread: 3/4 -16
O.D.: 3 (76.2)
Height: 2 7/8 (73.0)
I.Gskt: G449-B

Measurements Are Shown In Inches And (Millimeters)

WARNING: These products can expose you to chemicals, including Diisononyl Phthalate, Carbon black extracts, Nickel, 1,3 Butadiene, Ethylene Oxide, Epichlorohydrin, which are known to the State of California to cause cancer, and Bisphenol, Ethylene Glycol, Ethylene Oxide, 1,3 Butadiene, Epichlorohydrin, which are known to the State of California to cause birth defects or other reproductive harm. For more information go to www.P65Warnings.ca.gov.

<p>B1413</p>  <p>Lube Spin-on Contains: 8 PSID By-Pass Valve Fits: Harley-Davidson Motorcycles; Mazda Automotive Replaces: Harley-Davidson 63805-80A Thread: 3/4 -16 O.D.: 3 (76.2) Height: 3 1/2 (88.9) I.Gskt: G449-B</p>	<p>B1425</p>  <p>Lube Spin-on Contains: Anti-Drainback Valve 20 PSID By-Pass Valve Fits: Acura, Honda, Isuzu Automotive, Light-Duty Trucks Replaces: Isuzu 8-94456-741-1, 8-97140-666-0 Thread: M20 x 1.5 O.D.: 3 1/32 (77.0) Height: 3 7/16 (87.3) I.Gskt: [1] Included</p>
<p>B1416</p>  <p>Lube Spin-on Contains: Anti-Drainback Valve 14 PSID By-Pass Valve Front End Check Valve Fits: Ford, Mazda Automotive Replaces: Ford F8CA-6731-AA Thread: 3/4 -16 O.D.: 2 29/32 (73.8) Height: 4 27/32 (123.0) I.Gskt: [1] Included</p>	<p>B1428</p>  <p>Lube Spin-on Contains: Anti-Drainback Valve Fits: Chevrolet, GM Automotive, Light-Duty Trucks Replaces: GMC 25160561 Thread: 13/16 -16 O.D.: 3 11/16 (93.7) Height: 5 11/32 (135.7) I.Gskt: [1] Included Related To: B6 (without Anti-Drainback Valve)</p>
<p>P1418</p>  <p>Lube Element with Bail Handle Fits: Mercedes-Benz Automotive Replaces: Mercedes-Benz 11849125, 1191800009 O.D.: 2 25/32 (70.6) I.D.: 3/8 (9.5) & 27/32 (21.4) Height: 6 1/32 (153.2) F. Gskt: [3] Included Grommets: [2] Attached</p>	<p>B1429</p>  <p>Lube Spin-on Contains: Anti-Drainback Valve 30 PSID By-Pass Valve Fits: Audi, Volkswagen Automotive Replaces: Volkswagen 78115561J Thread: 3/4 -16 O.D.: 3 11/16 (93.7) Height: 4 7/16 (112.7) I.Gskt: G401</p>
<p>P1419</p>  <p>Lube Element Fits: Mercedes-Benz Automotive Replaces: Mercedes-Benz 1041800109, 1041840225, 1041840325, 1041840425 O.D.: 2 7/16 (61.9) I.D.: 27/32 (21.4) One End Height: 6 9/32 (159.5) A. Gskt: [1] Attached O-Ring: [1] Included</p>	<p>B1430</p>  <p>Lube Spin-on Contains: Anti-Drainback Valve 20 PSID By-Pass Valve Fits: Geo Tracker Replaces: GMC 2501441 Thread: 3/4 -16 O.D.: 3 (76.2) Height: 4 1/16 (103.2) I.Gskt: [1] Included</p>
<p>B1421</p>  <p>Lube Spin-on Contains: Anti-Drainback Valve 14 PSID By-Pass Valve Fits: Acura, Honda Automotive Replaces: Honda 15400-P0H-305, 15400-PR3-406 Thread: M20 x 1.5 O.D.: 3 1/32 (77.0) Height: 3 7/16 (87.3) I.Gskt: [1] Included</p>	<p>B1431</p>  <p>Lube Spin-on Contains: Anti-Drainback Valve 14 PSID By-Pass Valve Fits: Mitsubishi Automotive Replaces: Mitsubishi AW343979, MD352627 Thread: M20 x 1.5 O.D.: 2 21/32 (67.5) Height: 4 (101.6) I.Gskt: [1] Included Related To: B1400, B1402 (Short Versions)</p>
<p>B1422</p>  <p>Lube Spin-on Contains: Anti-Drainback Valve 20 PSID By-Pass Valve Fits: Acura Automotive Replaces: Honda 15400-PL2-004, 15400-PL2-005, 15400-PL2-305 Thread: M22 x 1.5 O.D.: 3 1/32 (77.0) Height: 3 1/2 (88.9) I.Gskt: G449-B</p>	<p>B1432</p>  <p>Lube Spin-on Contains: Anti-Drainback Valve Fits: Chevrolet, GMC Light-Duty Trucks Replaces: GMC 25014748 Thread: 13/16 -16 O.D.: 3 (76.2) Height: 4 3/32 (104.0) I.Gskt: G449-B</p>

Measurements Are Shown In Inches And (Millimeters)

WARNING: These products can expose you to chemicals, including Diisononyl Phthalate, Carbon black extracts, Nickel, 1,3 Butadiene, Ethylene Oxide, Epichlorohydrin, which are known to the State of California to cause cancer, and Bisphenol, Ethylene Glycol, Ethylene Oxide, 1,3 Butadiene, Epichlorohydrin, which are known to the State of California to cause birth defects or other reproductive harm. For more information go to www.P65Warnings.ca.gov.

P1433

Lube Element



Fits: Cadillac, Oldsmobile Automotive
Replaces: GMC 25177917
O.D.: 2 1/8 (54.0)
I.D.: 23/32 (18.3)
Height: 3 13/16 (96.8)
O-Ring: [1] Included
Grommets: [2] Attached

P1443

Lube Element



Fits: Dodge, Freightliner Sprinter Vans;
 Mercedes-Benz Automotive, Light-Duty Trucks,
 Vans
Replaces: Chrysler 5086301AA; Mann &
 Hummel HU7181, HU7181X, HU7184;
 Mercedes-Benz 1121800009, 1121840025,
 A1121840225
O.D.: 2 17/32 (64.3)
I.D.: 1 1/4 (31.8)
Height: 4 9/16 (115.9)
O-Ring: [6] Included

B1434

Lube Spin-on



Notes: Can be used with OB40079 base.
Contains: Anti-Drainback Valve
 20 PSID By-Pass Valve
Fits: Volvo Automotive
Replaces: Volvo 35178573
Thread: 3/4 -16
O.D.: 3 11/16 (93.7)
Height: 3 1/4 (82.6)
I.Gskt: G381-A

B1444

Lube Spin-on



Contains: 8 PSID By-Pass Valve
Fits: Subaru Outback, Outback Sport, Tribeca
Replaces: Subaru SOA51-65109
Thread: M20 x 1.5
O.D.: 3 (76.2)
Height: 2 27/32 (72.2)
I.Gskt: [1] Included

B1435

Lube Spin-on



Contains: Anti-Drainback Valve
 20 PSID By-Pass Valve
Fits: Jaguar, Land Rover, Lincoln Automotive,
 Light-Duty Trucks
Replaces: Ford XW4Z-6731-BA
Thread: 1 -12
O.D.: 3 (76.2)
Height: 4 27/32 (123.0)
I.Gskt: G449-B

B1446

Lube Spin-on



Contains: 20 PSID By-Pass Valve
Fits: Chevrolet, Isuzu Light-Duty Trucks;
 Hitachi, Kobelco Equipment
Replaces: Isuzu 8-97049-708-1, X132010140
Thread: M20 x 1.5
O.D.: 3 23/32 (94.5)
Height: 3 27/32 (97.6)
I.Gskt: [1] Included
O-Ring: [3] Included

B1438

Lube Spin-on



Contains: Anti-Drainback Valve
Fits: Chevrolet, GMC Light-Duty Trucks with
 7.4L, 8.1L Engines
Replaces: GMC 25324052
Thread: 13/16 -16
O.D.: 3 11/16 (93.7)
Height: 3 3/16 (81.0)
I.Gskt: [1] Included

B1447

Lube Spin-on



Contains: 14 PSID By-Pass Valve
Fits: Land Rover Freelander
Replaces: Land Rover AHU2880, CDU1268,
 LPW100230
Thread: 13/16 -16
O.D.: 3 1/32 (77.0)
Height: 4 1/8 (104.8)
I.Gskt: G449-B

P1440

Lube Element



Fits: Cadillac, Saturn Automotive
Replaces: GMC 90536362; Saturn 21018826
O.D.: 2 7/16 (61.9)
I.D.: 1 7/32 (31.0) One End
Height: 3 3/32 (78.6)
A. Gskt: [1] Attached
O-Ring: [1] Included

P1510

Lube Element



Fits: E.M.D. Cageless Series
Replaces: E.M.D. 8345482
O.D.: 6 1/2 (165.1)
I.D.: 1 15/32 (37.3) One End
Height: 29 3/8 (746.1)
End Seals: [1] Included

B1441

Lube Spin-on



Contains: Anti-Drainback Valve
 15 PSID By-Pass Valve
Fits: Chevrolet, GMC Light-Duty Trucks
Replaces: GMC 97214983; Isuzu 8-97214-983-1
Thread: 13/16 -16
O.D.: 3 11/16 (93.7)
Height: 5 5/16 (134.9)
I.Gskt: [1] Included

P1511













Lube Element



Fits: Industrial Engines
Replaces: Alco 16011911
O.D.: 6 13/32 (162.7)
I.D.: 1 15/32 (37.3) One End
Height: 33 7/8 (860.4)
Spring: [1] Attached











Measurements Are Shown In Inches And (Millimeters)

WARNING: These products can expose you to chemicals, including Diisononyl Phthalate, Carbon black extracts, Nickel, 1,3 Butadiene, Ethylene Oxide, Epichlorohydrin, which are known to the State of California to cause cancer, and Bisphenol, Ethylene Glycol, Ethylene Oxide, 1,3 Butadiene, Epichlorohydrin, which are known to the State of California to cause birth defects or other reproductive harm. For more information go to www.P65Warnings.ca.gov.

<p>V1520-R Vac-Cel Lube Sock with Bail Pull Fits: Nugent Filter Housings Replaces: Alco 1601198 O.D.: 6 3/16 (157.2) I.D.: 1 23/32 (43.7) Height: 30 1/2 (774.7) I.Gskt: [2] Included</p> 	<p>P1565 Lube Element Notes: Inside-Out Flow Direction Replaces: Vokes B62966 O.D.: 2 13/16 (71.4) I.D.: 13/32 (10.3) & 1 5/16 (33.3) Height: 6 5/32 (156.4) A. Gskt: [1] Attached</p> 
<p>V1542-C Vac-Cel Full-Flow Lube Sock Fits: Winslow Filter Housings Replaces: Winslow 1542 Series O.D.: 3 3/4 (95.3) Height: 15 1/2 (393.7)</p> 	<p>P1566 Lube Element Notes: OBSOLETE. Availability Limited to Dealer Stock. Inside-Out Flow Direction Replaces: Vokes B60942 O.D.: 2 27/32 (72.2) I.D.: 13/32 (10.3) & 1 11/32 (34.1) Height: 3 29/32 (99.2) A. Gskt: [1] Attached</p> 
<p>V1544-T Sisal Sock for Filtering Liquids at High Flow Rates Fits: Hyco, Winslow Filter Housings Replaces: Winslow 1544 Series O.D.: 3 3/4 (95.3) I.D.: 1 1/16 (27.0) Height: 15 (381.0)</p> 	<p>P1567 Lube Element Replaces: Vokes C6323149, C6370462 O.D.: 6 (152.4) I.D.: 2 25/32 (70.6) Height: 12 1/4 (311.2) A. Gskt: [2] Attached</p> 
<p>V1560 Crankcase Emission Absorber Fits: Various Oil Field Equipment Replaces: Nelson 88465A O.D.: 6 1/2 (165.1) I.D.: 3 3/4 (95.3) Height: 32 (812.8)</p> 	<p>P1568 Lube Element Replaces: Vokes 6360110, C6360230, C6370064 O.D.: 8 13/16 (223.8) I.D.: 4 1/16 (103.2) Height: 13 7/32 (335.8) O-Ring: [2] Attached</p> 
<p>P1561 Lube Element Replaces: Vokes 6360109, C6360229, C6370812 O.D.: 6 5/8 (168.3) I.D.: 3 13/32 (86.5) Height: 17 3/32 (434.2) O-Ring: [2] Attached</p> 	<p>P1575 Lube Element Notes: OBSOLETE. Availability Limited to Dealer Stock. Inside-Out Flow Direction Replaces: Vokes B63331 O.D.: 3 21/32 (92.9) I.D.: 5/8 (15.9) & 1 23/32 (43.7) Height: 3 29/32 (99.2) A. Gskt: [1] Attached</p> 
<p>P1562 Lube Element Replaces: Vokes C6360112, C6360232, C6370012 O.D.: 8 13/16 (223.8) I.D.: 4 1/16 (103.2) Height: 18 7/32 (462.8) O-Ring: [2] Attached</p> 	
<p>P1563 Lube Element Replaces: Vokes B6352910 O.D.: 5 29/32 (150.0) I.D.: 2 13/16 (71.4) Height: 6 7/8 (174.6) A. Gskt: [2] Attached</p> 	

Measurements Are Shown In Inches And (Millimeters)

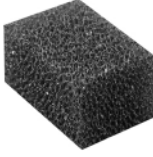
WARNING: These products can expose you to chemicals, including Diisononyl Phthalate, Carbon black extracts, Nickel, 1,3 Butadiene, Ethylene Oxide, Epichlorohydrin, which are known to the State of California to cause cancer, and Bisphenol, Ethylene Glycol, Ethylene Oxide, 1,3 Butadiene, Epichlorohydrin, which are known to the State of California to cause birth defects or other reproductive harm. For more information go to www.P65Warnings.ca.gov.

<p>P1577</p> 	<p>Lube Element Notes: Inside-Out Flow Direction Replaces: Vokes B62982 O.D.: 3 21/32 (92.9) I.D.: 21/32 (16.7) & 1 23/32 (43.7) Height: 8 31/32 (227.8) A. Gskt: [1] Attached</p>	<p>PA1602</p> 	<p>Air Element Fits: Purolator AF100 Series Housings Replaces: Deutz 3476295; GMC 1553686 O.D.: 6 5/8 (168.3) I.D.: 4 1/4 (108.0) Height: 7 7/8 (200.0)</p>
<p>PF1584</p> 	<p>Fuel Element Replaces: Vokes C6360352 O.D.: 8 25/32 (223.0) I.D.: 4 3/32 (104.0) Height: 18 5/32 (461.2) O-Ring: [2] Attached</p>	<p>PA1603</p> 	<p>Air Breather Element Fits: Chevrolet, GMC Trucks; Kohler Engines Replaces: GMC 2325376; Kohler 24908 O.D.: 2 15/16 (74.6) I.D.: 1 7/8 (47.6) Height: 2 9/16 (65.1)</p>
<p>PF1585</p> 	<p>Fuel Element Replaces: Vokes B6436169 O.D.: 3 21/32 (92.9) I.D.: 21/32 (16.7) & 2 5/32 (54.8) Height: 8 31/32 (227.8) A. Gskt: [1] Attached</p>	<p>PA1606</p> 	<p>Air Element Contains: Flame Retardant Media Replaces: GMC 6488318 O.D.: 10 7/32 (259.6) I.D.: 7 7/8 (200.0) Height: 7 1/2 (190.5)</p>
<p>PF1587</p> 	<p>Fuel Element Notes: OBSOLETE. Availability Limited to Dealer Stock. Replaces: Vokes B6436168 O.D.: 3 21/32 (92.9) I.D.: 5/8 (15.9) & 1 23/32 (43.7) Height: 3 7/8 (98.4) A. Gskt: [1] Attached</p>	<p>PA1607</p> 	<p>Air Element Contains: Flame Retardant Media Replaces: GMC 6488322 O.D.: 10 7/32 (259.6) I.D.: 7 7/8 (200.0) Height: 11 15/32 (291.3)</p>
<p>PA1600</p> 	<p>Poly Foam Air Breather Fits: GMC Buses, Trucks; Various Air Compressors Replaces: Bendix 239262; Cummins 299365; GMC 9028042 Length: 2 1/2 (63.5) Width: 1 3/4 (44.4) Height: 1 3/8 (34.9)</p>	<p>LL1608</p> 	<p>Long Life Air Element Notes: Inside-Out Flow Direction Contains: Flame Retardant Media Fits: Bray, Case, Galion, International Equipment Replaces: Case L10327; International 124010-R1 O.D.: 6 5/8 (168.3) I.D.: 4 1/4 (108.0) One End Height: 9 (228.6) Related To: PA1608 (Standard Media Version)</p>

Measurements Are Shown In Inches And (Millimeters)

WARNING: These products can expose you to chemicals, including Diisononyl Phthalate, Carbon black extracts, Nickel, 1,3 Butadiene, Ethylene Oxide, Epichlorohydrin, which are known to the State of California to cause cancer, and Bisphenol, Ethylene Glycol, Ethylene Oxide, 1,3 Butadiene, Epichlorohydrin, which are known to the State of California to cause birth defects or other reproductive harm. For more information go to www.P65Warnings.ca.gov.

PA1608 Air Element
Notes: Inside-Out Flow Direction
Contains: Flame Retardant Media
Fits: Bray, Case, Galion, International Equipment
Replaces: Case L10327; International 124010-R1
O.D.: 6 5/8 (168.3)
I.D.: 4 1/4 (108.0) One End
Height: 9 (228.6)
Related To: LL1608 (Long-Life Media Version)



LL1614 Long Life Air Element
Notes: Inside-Out Flow Direction
Fits: Allis Chalmers, Caterpillar, Dynapac, Franklin, Galion, J.C. Bamford Equipment; Gardner Denver, Sullair Compressors
Replaces: Allis Chalmers 71132849; Continental SD802F546; Galion 79266
O.D.: 8 1/4 (209.6)
I.D.: 1/2 (12.7) & 5 3/4 (146.0)
Height: 11 (279.4)
F. Gskt: [1] Included
Related To: PA1614 (Standard Media Version)



PA1609 Outer Air Element with Lift Tabs
Fits: Allis Chalmers, Ford Equipment
Use With: PA2306
Replaces: Allis Chalmers 70630088; Ford C9NN-9601-A
O.D.: 6 (152.4)
I.D.: 3 5/8 (92.1) One End
Height: 14 3/16 (360.4)
A. Gskt: [1] Attached



PA1614 Air Element
Notes: Inside-Out Flow Direction
Fits: Allis Chalmers, Caterpillar, Dynapac, Franklin, Galion, J.C. Bamford Equipment; Gardner Denver, Sullair Compressors
Replaces: Allis Chalmers 71132849; Continental SD802F546; Galion 79266
O.D.: 8 1/4 (209.6)
I.D.: 1/2 (12.7) & 5 3/4 (146.0)
Height: 11 (279.4)
F. Gskt: [1] Included
Related To: LL1614 (Long-Life Media Version)



PA1610 Air Element with Lift Tabs
Fits: Drott, International Equipment
Replaces: Drott 76237; International 321595-R91
O.D.: 6 (152.4)
I.D.: 3 5/8 (92.1) One End
Height: 18 5/16 (465.1)
A. Gskt: [1] Attached



LL1615 Long Life Outer Air Element
Fits: Caterpillar Equipment
Use With: PA1647, PA2719, [PA2736]
Replaces: Caterpillar 4M8047, 8N5389
O.D.: 9 1/4 (235.0)
I.D.: 4 27/32 (123.0) One End
Height: 12 1/2 (317.5)
A. Gskt: [1] Attached
Related To: PA1615 (Standard Media Version)
 PA1615XP (Extreme Performance Nano Version)



PA1613 Air Element
Notes: Inside-Out Flow Direction
Fits: Allis Chalmers, International, Yale & Towne Equipment
Replaces: Allis Chalmers 630418; International D58575; White 866520
O.D.: 8 1/4 (209.6)
I.D.: 1/2 (12.7) & 5 3/4 (146.0)
Height: 9 (228.6)
F. Gskt: [1] Included



PA1615 Outer Air Element
Fits: Caterpillar Equipment
Use With: PA1647, PA2719, PA2736
Replaces: Caterpillar 4M8047, 8N5389
O.D.: 9 1/4 (235.0)
I.D.: 4 27/32 (123.0) One End
Height: 12 1/2 (317.5)
A. Gskt: [1] Attached
Related To: LL1615 (Long-Life Media Version)
 PA1615XP (Extreme Performance Nano Version)



PA1613-S Air Element
Notes: Inside-Out Flow Direction
Fits: Allis Chalmers, International, Yale & Towne Equipment
Replaces: International 968718-R91
O.D.: 8 1/4 (209.6)
I.D.: 5 3/4 (146.0) One End
Height: 9 (228.6)



PA1615XP Extreme Performance Nano Outer Air Element
Fits: Caterpillar Equipment
Use With: PA1647, PA2719, PA2736
Replaces: Caterpillar 4M8047, 8N5389
O.D.: 9 1/4 (235.0)
I.D.: 4 27/32 (123.0) One End
Height: 12 1/2 (317.5)
A. Gskt: [1] Attached
Related To: LL1615 (Long-Life Media Version)
 PA1615 (Standard Media Version)



PA1618 Air Element
Fits: Hyster Lift Trucks; OBAC Optional Filter Housings
Replaces: GMC 6424682; OBAC HOB1004
O.D.: 10 7/32 (259.6)
I.D.: 5 1/2 (139.7)
Height: 4 (101.6)



Measurements Are Shown In Inches And (Millimeters)

WARNING: These products can expose you to chemicals, including Diisononyl Phthalate, Carbon black extracts, Nickel, 1,3 Butadiene, Ethylene Oxide, Epichlorohydrin, which are known to the State of California to cause cancer, and Bisphenol, Ethylene Glycol, Ethylene Oxide, 1,3 Butadiene, Epichlorohydrin, which are known to the State of California to cause birth defects or other reproductive harm. For more information go to www.P65Warnings.ca.gov.

PA1619

Air Element



Fits: Case Equipment; Ford Engines
Replaces: Case A15483
O.D.: 10 7/32 (259.6)
I.D.: 5 1/2 (139.7)
Height: 5 (127.0)
F. Gskt: [3] Included

PA1620

Air Element



Fits: Case Equipment
Replaces: Case A14956, A15903
O.D.: 10 7/32 (259.6)
I.D.: 5 1/2 (139.7)
Height: 8 3/16 (208.0)
A. Gskt: [2] Attached

PA1620-S

Air Element



Fits: Caterpillar Engines
Replaces: Caterpillar 4L9851
O.D.: 10 7/32 (259.6)
I.D.: 6 1/16 (154.0) One End
Height: 7 27/32 (199.2)
A. Gskt: [1] Attached

LL1621-2

Long Life Air Element with 2-Inch Pleats



Notes: Inside-Out Flow Direction
Fits: Austin-Western, Aveling-Barford, Dresser, Euclid, Galion, Hancock, Hough, J.C. Bamford, Versatile, Washington Iron Works, Yale Equipment
Replaces: Versatile 6017725; Yale 512556805
O.D.: 10 7/32 (259.6)
I.D.: 1/2 (12.7) & 6 1/16 (154.0)
Height: 9 (228.6)
F. Gskt: [1] Included
Related To: PA1621-2 (Standard Media Version)

PA1621

Air Element



Notes: Inside-Out Flow Direction
Fits: Euclid, Hough, Versatile Equipment
Replaces: International 155209; White 882681
O.D.: 10 7/32 (259.6)
I.D.: 1/2 (12.7) & 7 7/8 (200.0)
Height: 9 (228.6)
F. Gskt: [1] Included

PA1621-2

Air Element with 2-Inch Pleats



Notes: Inside-Out Flow Direction
Fits: Austin-Western, Aveling-Barford, Dresser, Euclid, Galion, Hancock, Hough, J.C. Bamford, Versatile, Washington Iron Works, Yale Equipment
Replaces: Versatile 6017725; Yale 512556805
O.D.: 10 7/32 (259.6)
I.D.: 1/2 (12.7) & 6 1/16 (154.0)
Height: 9 (228.6)
F. Gskt: [1] Included
Related To: LL1621-2 (Long-Life Media Version)

PA1625

Air Element



Fits: Caterpillar, Michigan Equipment
Replaces: Caterpillar 9M8373
O.D.: 11 21/32 (296.1)
I.D.: 6 1/8 (155.6) & 8 31/32 (227.8)
Height: 10 1/2 (266.7)
A. Gskt: [2] Attached
O. Gskt: [2] G37-AF

LL1626-2

Long Life Air Element with 2-Inch Pleats



Notes: Inside-Out Flow Direction
Fits: Euclid, Hough Equipment
Replaces: Euclid 9038805; International 425615-R91
O.D.: 12 1/8 (308.0)
I.D.: 1/2 (12.7) & 7 11/16 (195.3)
Height: 10 (254.0)
F. Gskt: [1] Included
Related To: PA1626-2 (Standard Media Version)

PA1626

Air Element



Notes: Inside-Out Flow Direction
Fits: Euclid, Hough Equipment
Replaces: Euclid 9228197; International 425970-R91
O.D.: 12 1/32 (305.6)
I.D.: 1/2 (12.7) & 9 1/4 (235.0)
Height: 10 (254.0)
F. Gskt: [1] Included

PA1626-2

Air Element with 2-Inch Pleats



Notes: Inside-Out Flow Direction
Fits: Euclid, Hough Equipment
Replaces: Euclid 9038805; International 425615-R91
O.D.: 12 1/8 (308.0)
I.D.: 1/2 (12.7) & 7 11/16 (195.3)
Height: 10 (254.0)
F. Gskt: [1] Included
Related To: LL1626-2 (Long-Life Media Version)

PA1627











Rocker Arm Air Breather Element



Fits: Cummins Engines
Replaces: Cummins 255180
O.D.: 5 (127.0)
I.D.: 2 5/8 (66.7)
Height: 1 5/16 (33.3)

Measurements Are Shown In Inches And (Millimeters)

WARNING: These products can expose you to chemicals, including Diisononyl Phthalate, Carbon black extracts, Nickel, 1,3 Butadiene, Ethylene Oxide, Epichlorohydrin, which are known to the State of California to cause cancer, and Bisphenol, Ethylene Glycol, Ethylene Oxide, 1,3 Butadiene, Epichlorohydrin, which are known to the State of California to cause birth defects or other reproductive harm. For more information go to www.P65Warnings.ca.gov.

<p>PA1629-S Air Element Fits: Caterpillar Engines Replaces: Caterpillar 4L9853 O.D.: 13 13/16 (350.8) I.D.: 9 1/2 (241.3) One End Height: 12 1/8 (308.0) A. Gskt: [1] Attached</p> 	<p>PA1632 Air Element Fits: GMC Engines; Ingersoll-Rand Compressors Replaces: GMC 6422964; Ingersoll-Rand 40070 O.D.: 16 5/8 (422.3) I.D.: 12 (304.8) Height: 16 (406.4)</p> 
<p>LL1630-2 Long Life Air Element with 2-Inch Pleats Notes: Inside-Out Flow Direction Fits: Caterpillar, Cummins Engines; Compair, Consolidated, Gardner Denver, Ingersoll-Rand, Joy Compressors Replaces: Caterpillar 9L3420; Cummins 130752; GMC 247059 O.D.: 13 13/16 (350.8) I.D.: 1/2 (12.7) & 9 1/2 (241.3) Height: 14 (355.6) F. Gskt: [1] Included Related To: PA1630-2 (Standard Media Version)</p> 	<p>PA1633 Air Element Fits: Caterpillar Equipment, Industrial, Marine, Starter Engines Replaces: Caterpillar 8M3120 O.D.: 4 1/4 (108.0) I.D.: 1 5/8 (41.3) One End Height: 4 3/4 (120.7) A. Gskt: [1] Attached</p> 
<p>PA1630 Air Element Notes: Inside-Out Flow Direction Fits: Allis Chalmers, Euclid Equipment Replaces: Allis Chalmers 43790692; Euclid 9175490 O.D.: 13 27/32 (351.6) I.D.: 1/2 (12.7) & 11 1/8 (282.6) Height: 14 (355.6) F. Gskt: [1] Included Related To: PA1706 (with Attached Gasket)</p> 	<p>LL1634 Long Life Outer Air Element Fits: Caterpillar Truck Engines, Equipment Use With: PA1675, PA2310, PA2737 Replaces: Caterpillar 4M9334, 8N5317; General Motors 6421540; Mitsubishi 4574070210; Poclair P2050509 O.D.: 11 1/8 (282.6) I.D.: 6 23/32 (170.7) One End Height: 13 1/2 (342.9) A. Gskt: [1] Attached Related To: PA1634 (Standard Media Version) PA1634XP (Extreme Performance Nano Version)</p> 
<p>PA1630-2 Air Element with 2-Inch Pleats Notes: Inside-Out Flow Direction Fits: Caterpillar, Cummins Engines; Compair, Consolidated, Gardner Denver, Ingersoll-Rand, Joy Compressors Replaces: Caterpillar 9L3420; Cummins 130752; GMC 247059 O.D.: 13 13/16 (350.8) I.D.: 1/2 (12.7) & 9 1/2 (241.3) Height: 14 (355.6) F. Gskt: [1] Included Related To: LL1630-2 (Long-Life Media Version)</p> 	<p>PA1634 Outer Air Element Fits: Caterpillar Truck Engines, Equipment Use With: PA1675, PA2310, PA2737 Replaces: Caterpillar 4M9334, 8N5317; General Motors 6421540; Mitsubishi 4574070210; Poclair P2050509 O.D.: 11 1/8 (282.6) I.D.: 6 23/32 (170.7) One End Height: 13 1/2 (342.9) A. Gskt: [1] Attached Related To: LL1634 (Long-Life Media Version) PA1634XP (Extreme Performance Nano Version)</p> 
<p>PA1631-S Air Element Fits: Caterpillar Engines Replaces: Caterpillar 5L1203 O.D.: 13 13/16 (350.8) I.D.: 9 1/2 (241.3) One End Height: 18 1/8 (460.4) A. Gskt: [1] Attached</p> 	<p>PA1634XP Extreme Performance Nano Outer Air Element Fits: Caterpillar Truck Engines, Equipment Use With: PA1675, PA2310, PA2737 Replaces: Caterpillar 4M9334, 8N5317; General Motors 6421540; Mitsubishi 4574070210; Poclair P2050509 O.D.: 11 1/8 (282.6) I.D.: 6 23/32 (170.7) One End Height: 13 1/2 (342.9) A. Gskt: [1] Attached Related To: LL1634 (Long-Life Media Version) PA1634 (Standard Media Version)</p> 

Measurements Are Shown In Inches And (Millimeters)

WARNING: These products can expose you to chemicals, including Diisononyl Phthalate, Carbon black extracts, Nickel, 1,3 Butadiene, Ethylene Oxide, Epichlorohydrin, which are known to the State of California to cause cancer, and Bisphenol, Ethylene Glycol, Ethylene Oxide, 1,3 Butadiene, Epichlorohydrin, which are known to the State of California to cause birth defects or other reproductive harm. For more information go to www.P65Warnings.ca.gov.

PA1635

Air Element



Fits: Allis Chalmers, Case, Hough, John Bean Equipment
Replaces: Allis Chalmers 4824451; Case L48583
O.D.: 5 1/4 (133.4)
I.D.: 2 5/8 (66.7) One End
Height: 8 (203.2)

PA1637-FN

Air Element with Fins



Fits: Clark, Euclid, Grove, Hitachi, Koehring, Link-Belt, Michigan, Vermeer Equipment; Hino, International, Kenworth, Mitsubishi Trucks
Replaces: Clark 941089; International 877600-C9; Kenworth 944809
O.D.: 11 1/8 (282.6)
 Fins 13 3/4 (349.3)
I.D.: 5/8 (15.9) & 6 23/32 (170.7)
Height: 12 1/2 (317.5)
A. Gskt: [1] Attached
F. Gskt: [1] Included
Related To: LL1637-FN (Long-Life Media Version)

LL1636-FN

Long Life Air Element with Fins



Fits: Allis Chalmers, Case, Caterpillar, Hitachi, Hough, Ingersoll-Rand, John Deere, Michigan Equipment; Mitsubishi Trucks
Replaces: Allis Chalmers 24472812; Case L35913; John Deere AR30644
O.D.: 7 15/16 (201.6)
 Fins 10 1/16 (255.6)
I.D.: 1/2 (12.7) & 3 9/16 (90.5)
Height: 10 1/4 (260.3)
A. Gskt: [1] Attached
F. Gskt: [1] Included
Related To: PA1636-FN (Standard Media Version)

PA1639

Air Element



Fits: Craftsman, John Deere, Lambert, Pennsylvania Lawn & Garden Equipment; Mercedes-Benz Trucks
Replaces: GMC 6486857; John Deere AM31000; Mercedes-Benz 942804
O.D.: 4 13/32 (111.9)
I.D.: 2 15/16 (74.6)
Height: 5 (127.0)

PA1636-FN

Air Element with Fins



Fits: Allis Chalmers, Case, Caterpillar, Hitachi, Hough, Ingersoll-Rand, John Deere, Michigan Equipment; Mitsubishi Trucks
Replaces: Allis Chalmers 24472812; Case L35913; John Deere AR30644
O.D.: 7 15/16 (201.6)
 Fins 10 1/16 (255.6)
I.D.: 1/2 (12.7) & 3 9/16 (90.5)
Height: 10 1/4 (260.3)
A. Gskt: [1] Attached
F. Gskt: [1] Included
Related To: LL1636-FN (Long-Life Media Version)

PA1641

Air Element



Fits: GMC Engines
Replaces: GMC 6484302
O.D.: 13 27/32 (351.6)
I.D.: 1/2 (12.7) & 11 1/8 (282.6)
Height: 7 1/2 (190.5)
A. Gskt: [1] Attached
F. Gskt: [1] Included

LL1637-FN

Long Life Air Element with Fins



Fits: Clark, Euclid, Grove, Hitachi, Koehring, Link-Belt, Michigan, Vermeer Equipment; Hino, International, Kenworth, Mitsubishi Trucks
Replaces: Clark 941089; International 877600-C9; Kenworth 944809
O.D.: 11 1/8 (282.6)
 Fins 13 3/4 (349.3)
I.D.: 5/8 (15.9) & 6 23/32 (170.7)
Height: 12 1/2 (317.5)
A. Gskt: [1] Attached
F. Gskt: [1] Included
Related To: PA1637-FN (Standard Media Version)

LL1642-2

Long Life Air Element with 2-Inch Pleats



Notes: Inside-Out Flow Direction
Fits: Austin-Western, Gardner Denver, KW-Dart Equipment; Kenworth Trucks
Replaces: Gardner Denver 5B345; GMC 6424683; Kenworth 461396
O.D.: 12 1/32 (305.6)
I.D.: 9/16 (14.3) & 7 11/16 (195.3)
Height: 13 (330.2)
F. Gskt: [1] Included
Related To: PA1642-2 (Standard Media Version)

PA1642-2

Air Element with 2-Inch Pleats



Notes: Inside-Out Flow Direction
Fits: Austin-Western, Gardner Denver, KW-Dart Equipment; Kenworth Trucks
Replaces: Gardner Denver 5B345; GMC 6424683; Kenworth 461396
O.D.: 12 1/32 (305.6)
I.D.: 9/16 (14.3) & 7 11/16 (195.3)
Height: 13 (330.2)
F. Gskt: [1] Included
Related To: LL1642-2 (Long-Life Media Version)

Measurements Are Shown In Inches And (Millimeters)

WARNING: These products can expose you to chemicals, including Diisononyl Phthalate, Carbon black extracts, Nickel, 1,3 Butadiene, Ethylene Oxide, Epichlorohydrin, which are known to the State of California to cause cancer, and Bisphenol, Ethylene Glycol, Ethylene Oxide, 1,3 Butadiene, Epichlorohydrin, which are known to the State of California to cause birth defects or other reproductive harm. For more information go to www.P65Warnings.ca.gov.

PA1643 Air Element
Replaces: Euclid 9192471; GMC 9038908
O.D.: 13 27/32 (351.6)
I.D.: 1/2 (12.7) & 11 1/8 (282.6)
Height: 14 (355.6)
F. Gskt: [1] Included



PA1646 Air Element
Replaces: Donaldson P107643
O.D.: 9 7/32 (234.2)
I.D.: 21/32 (16.7) & 4 27/32 (123.0)
Height: 10 1/2 (266.7)
A. Gskt: [1] Attached
F. Gskt: [1] Included



PA1644 Air Element with Lift Tab
Contains: Flame Retardant Media
Fits: Allis Chalmers, Caterpillar, Hyster, International Equipment
Replaces: Allis Chalmers 23589378; Hyster 23471906; International 391852-R92; Towmotor 343008
O.D.: 3 9/16 (90.5)
I.D.: 2 1/32 (51.6) One End
Height: 11 (279.4)
A. Gskt: [1] Attached



PA1646-FN Air Element with Fins
Fits: Case, Caterpillar, Dresser, Drott, Galion, Grove, Hitachi, Hydro-Ax, Koehring, Michigan Equipment; Iveco, R.V.I. Trucks
Replaces: Case A60743; Caterpillar 9Y6834; Drott 221313; Galion D73499; Hitachi D911762; Iveco 9917881
O.D.: 9 7/32 (234.2)
Fins: 11 5/8 (295.3)
I.D.: 21/32 (16.7) & 4 27/32 (123.0)
Height: 10 1/2 (266.7)
A. Gskt: [1] Attached
F. Gskt: [1] Included
Related To: LL1646-FN (Long-Life Media Version)



F1645-DS Special Vac-Cel Fuel Sock
Fits: Winslow 1645 Series Housings
Replaces: Winslow W1645T
O.D.: 4 1/4 (108.0)
I.D.: 1 1/16 (27.0)
Height: 16 (406.4)
F. Gskt: G140-A Included with V1645-C Only



PA1647 Inner Air Element with 6 Bolts
Fits Inside: LL1615, PA1615, PA1615XP
Fits: Caterpillar Equipment
Replaces: Caterpillar 2S1285
O.D.: 4 3/4 (120.7)
Flange: 7 5/16 (185.7)
I.D.: 3 5/8 (92.1) One End
Height: 12 (304.8)
A. Gskt: [1] Attached
F. Gskt: [1] Included



V1645-C Vac-Cel Full-Flow Lube Sock
Fits: Winslow 1645 Series Housings
Replaces: Winslow W1645T
O.D.: 4 1/4 (108.0)
I.D.: 1 1/16 (27.0)
Height: 16 (406.4)
F. Gskt: G140-A



PA1648 Air Element
Contains: Flame Retardant Media
Fits: Allis Chalmers Lift Trucks
Replaces: Allis Chalmers 49931583
O.D.: 6 13/32 (162.7)
Top: 6 21/32 (169.1)
I.D.: 4 3/32 (104.0)
Height: 3 (76.2)



LL1646-FN Long Life Air Element with Fins
Fits: Case, Caterpillar, Dresser, Drott, Galion, Grove, Hitachi, Hydro-Ax, Koehring, Michigan Equipment; Iveco, R.V.I. Trucks
Replaces: Case A60743; Caterpillar 9Y6834; Drott 221313; Galion D73499; Hitachi D911762; Iveco 9917881
O.D.: 9 7/32 (234.2)
Fins: 11 5/8 (295.3)
I.D.: 21/32 (16.7) & 4 27/32 (123.0)
Height: 10 1/2 (266.7)
A. Gskt: [1] Attached
F. Gskt: [1] Included
Related To: PA1646-FN (Standard Media Version)



LL1649 Long Life Air Element
Notes: Inside-Out Flow Direction
Fits: Caterpillar, Cummins Engines; Euclid, Terex, Volvo Equipment
Replaces: Caterpillar 6L3313; Cummins 707664; Euclid 9395885; Terex 9030854; Volvo 79230041
O.D.: 13 13/16 (350.8)
I.D.: 1/2 (12.7) & 9 1/2 (241.3)
Height: 16 (406.4)
F. Gskt: [1] Included
Related To: PA1649 (Standard Media Version)



Measurements Are Shown In Inches And (Millimeters)

WARNING: These products can expose you to chemicals, including Diisononyl Phthalate, Carbon black extracts, Nickel, 1,3 Butadiene, Ethylene Oxide, Epichlorohydrin, which are known to the State of California to cause cancer, and Bisphenol, Ethylene Glycol, Ethylene Oxide, 1,3 Butadiene, Epichlorohydrin, which are known to the State of California to cause birth defects or other reproductive harm. For more information go to www.P65Warnings.ca.gov.

PA1649 Air Element
Notes: Inside-Out Flow Direction
Fits: Caterpillar, Cummins Engines; Euclid, Terex, Volvo Equipment
Replaces: Caterpillar 6L3313; Cummins 707664; Euclid 9395885; Terex 9030854; Volvo 79230041
O.D.: 13 13/16 (350.8)
I.D.: 1/2 (12.7) & 9 1/2 (241.3)
Height: 16 (406.4)
F. Gskt: [1] Included
Related To: LL1649 (Long-Life Media Version)



PA1661(3) Set of 3 Air Elements
Fits: California Custom Accessories
Replaces: California Custom PC15658
O.D.: 4 (101.6)
I.D.: 2 3/4 (69.9)
Height: 2 1/32 (51.6)



PA1650-FN Air Element with Fins
Fits: Dresser, International Loaders, Tractors
Replaces: International 343731-R91
O.D.: 7 15/16 (201.6)
 Fins 10 1/16 (255.6)
I.D.: 1/2 (12.7) & 3 9/16 (90.5)
Height: 16 3/8 (415.9)
A. Gskt: [1] Attached
F. Gskt: [1] Included



PA1663 Outer Air Element
Fits: Case Equipment
Use With: PA1664
Replaces: Case A17741
O.D.: 12 1/16 (306.4)
I.D.: 7 13/16 (198.4)
Height: 10 7/16 (265.1)
A. Gskt: [2] Attached



PA1653 Air Compressor Element
Fits: Joy Compressors
Replaces: Joy 1222941
O.D.: 6 7/8 (174.6)
I.D.: 5 1/8 (130.2)
Height: 7 (177.8)
Related To: PA2102 (for Engine Air)



PA1664 Inner Air Element
Fits Inside: PA1663
Fits: Case Equipment
Replaces: Case A17742
O.D.: 6 5/8 (168.3)
I.D.: 4 1/4 (108.0)
Height: 9 13/16 (249.2)
A. Gskt: [2] Attached



V1656-O Vac-Cel Dual-Stage Full-Flow Orlon Lube Sock
Notes: For use with high heat applications.
Fits: Clark, Gradall, Grove Equipment; Waukesha Engines
Replaces: Waukesha 167602B
O.D.: 4 1/2 (114.3)
I.D.: 1 1/16 (27.0)
Height: 16 (406.4)
F. Gskt: G144
Related To: C133-W, C133-OW (Double-Length Versions)



PA1666 Conical-Shaped Air Element
Fits: Ariens, Bush Hog, Craftsman, Cub Cadet, Ford, International, John Deere, Lambert, Lawn Boy Lawn & Garden Equipment
Replaces: International 488619-R1; John Deere AM30900; Lawn Boy 10063; Tecumseh 30727
O.D.: 2 31/32 (75.4)
 to 3 3/4 (95.3)
I.D.: 2 1/32 (51.6) One End
Height: 2 1/8 (54.0)



V1656-T Vac-Cel Dual-Stage Full-Flow Cotton Lube Sock
Notes: Use V1656-O for use with high heat applications.
Fits: Clark, Gradall, Grove Equipment; Waukesha Engines
Replaces: Waukesha 167602B
O.D.: 4 1/2 (114.3)
I.D.: 1 1/16 (27.0)
Height: 16 (406.4)
F. Gskt: G144
Related To: C133-W, C133-OW (Double-Length Versions)



LL1667-FN Long Life Outer Air Element with Fins
Fits: Allis Chalmers, Benford, Bobcat, Case, Ditch Witch, Fiat, Ford, Hesston, International, John Deere, Komatsu, Kubota, New Holland, Versatile Equipment
Use With: PA2489 on Melroe Equipment
Replaces: Allis Chalmers 74996245; Case A59998; International 204002-H1; John Deere AH19852
O.D.: 5 3/16 (131.8)
 Fins 6 3/8 (161.9)
I.D.: 21/32 (16.7) & 2 5/8 (66.7)
Height: 11 1/2 (292.1)
A. Gskt: [1] Attached
F. Gskt: G103-N
Related To: PA1667-FN (Standard Media Version)



PA1657 Air Element
Fits: GMC, Isuzu, Nissan Automotive, Light-Duty Trucks
Replaces: GMC 94213709; Isuzu 8-94206-007-0
O.D.: 10 1/8 (257.2)
I.D.: 7 15/16 (201.6)
Height: 2 3/8 (60.3)



Measurements Are Shown In Inches And (Millimeters)

WARNING: These products can expose you to chemicals, including Diisononyl Phthalate, Carbon black extracts, Nickel, 1,3 Butadiene, Ethylene Oxide, Epichlorohydrin, which are known to the State of California to cause cancer, and Bisphenol, Ethylene Glycol, Ethylene Oxide, 1,3 Butadiene, Epichlorohydrin, which are known to the State of California to cause birth defects or other reproductive harm. For more information go to www.P65Warnings.ca.gov.

PA1667-FN



Outer Air Element with Fins
Fits: Allis Chalmers, Benford, Bobcat, Case, Ditch Witch, Fiat, Ford, Hesston, International, John Deere, Komatsu, Kubota, New Holland, Versatile Equipment
Use With: PA2489 on Melroe Equipment
Replaces: Allis Chalmers 74996245; Case A59998; International 204002-H1; John Deere AH19852
O.D.: 5 3/16 (131.8)
 Fins 6 3/8 (161.9)
I.D.: 2 1/32 (16.7) & 2 5/8 (66.7)
Height: 11 1/2 (292.1)
A. Gskt: [1] Attached
F. Gskt: G103-N
Related To: LL1667-FN (Long-Life Media Version)

LL1669



Long Life Outer Air Element
Fits: Caterpillar Equipment
Use With: PA1670, PA2733, PA2739
Replaces: Caterpillar 7M9045, 8N5316
O.D.: 11 1/8 (282.6)
I.D.: 6 23/32 (170.7) One End
Height: 16 1/2 (419.1)
A. Gskt: [1] Attached
Related To: PA1669 (Standard Media Version)

PA1669



Outer Air Element
Fits: Caterpillar Equipment
Use With: PA1670, PA2733, PA2739
Replaces: Caterpillar 7M9045, 8N5316
O.D.: 11 1/8 (282.6)
I.D.: 6 23/32 (170.7) One End
Height: 16 1/2 (419.1)
A. Gskt: [1] Attached
Related To: LL1669 (Long-Life Media Version)

PA1670



Inner Air Element with 8 Bolts
Notes: On Caterpillar using a Fleetguard or Heavy Duty Air conversion bracket, use PA2739.
Fits Inside: LL1669, PA1669
Fits: Caterpillar Equipment
Replaces: Caterpillar 2S1287
O.D.: 6 1/4 (158.8)
 Flange 9 1/16 (230.2)
I.D.: 4 5/8 (117.5) One End
Height: 16 (406.4)
A. Gskt: [1] Attached
F. Gskt: G42-AF

PA1673



Outer Air Element
Fits: Caterpillar Equipment
Use With: PA1674, PA3471
Replaces: Caterpillar 4M9378, 7W3920
O.D.: 8 3/8 (212.7)
I.D.: 4 (101.6) One End
Height: 10 1/2 (266.7)
A. Gskt: [1] Attached

PA1674



Inner Air Element with 6 Bolts
Fits Inside: PA1673
Fits: Caterpillar Equipment
Replaces: Caterpillar 2S1288, 9M1829
O.D.: 3 3/4 (95.3)
 Flange 6 11/16 (169.9)
I.D.: 2 5/8 (66.7) One End
Height: 10 3/32 (256.4)
A. Gskt: [1] Attached
F. Gskt: [1] Included

PA1675



Inner Air Element with 8 Bolts
Fits Inside: LL1634, PA1634, PA1634XP
Fits: Caterpillar Equipment
Replaces: Caterpillar 2S1286
O.D.: 6 1/4 (158.8)
 Flange 9 1/16 (230.2)
I.D.: 4 5/8 (117.5) One End
Height: 13 3/32 (332.6)
A. Gskt: [1] Attached
F. Gskt: [1] Included

LL1676-FN



Long Life Air Element with Fins
Fits: Cummins, Waukesha Engines
Replaces: Cummins 156773; Waukesha 163631
O.D.: 12 1/32 (305.6)
 Fins 15 3/4 (400.0)
I.D.: 17/32 (13.5) & 7 11/16 (195.3)
Height: 14 1/2 (368.3)
A. Gskt: [1] Attached
F. Gskt: [1] Included
Related To: PA1676-FN (Standard Media Version)

PA1676-FN



Air Element with Fins
Fits: Cummins, Waukesha Engines
Replaces: Cummins 156773; Waukesha 163631
O.D.: 12 1/32 (305.6)
 Fins 15 3/4 (400.0)
I.D.: 17/32 (13.5) & 7 11/16 (195.3)
Height: 14 1/2 (368.3)
A. Gskt: [1] Attached
F. Gskt: [1] Included
Related To: LL1676-FN (Long-Life Media Version)

PA1679



Air Breather Element
Fits: Caterpillar Equipment, Starter Engines
Replaces: Caterpillar 8M3119
O.D.: 3 1/8 (79.4)
I.D.: 1 1/2 (38.1)
Height: 3 3/4 (95.3)
A. Gskt: [2] Attached

PA1680



Air Element
Fits: GM Automotive, Light-Duty Trucks, Vans; Jeep Vehicles
Replaces: GMC 3902837; Jeep 948516
O.D.: 9 21/32 (245.3)
I.D.: 8 1/4 (209.6)
Height: 3 9/16 (90.5)
Related To: PA658 (Short Version)

Measurements Are Shown In Inches And (Millimeters)

WARNING: These products can expose you to chemicals, including Diisononyl Phthalate, Carbon black extracts, Nickel, 1,3 Butadiene, Ethylene Oxide, Epichlorohydrin, which are known to the State of California to cause cancer, and Bisphenol, Ethylene Glycol, Ethylene Oxide, 1,3 Butadiene, Epichlorohydrin, which are known to the State of California to cause birth defects or other reproductive harm. For more information go to www.P65Warnings.ca.gov.

LL1681-FN



Long Life Outer Air Element with Fins
Fits: GMC, Mack Trucks; Allis Chalmers, Case, Caterpillar, John Deere Equipment
Use With: PA2321, PA2570
Replaces: GMC 6424690; Mack 2MD455AP2
O.D.: 6 3/32 (154.8)
 Fins 7 13/16 (198.4)
I.D.: 3/4 (19.0) & 3 15/32 (88.1)
Height: 12 3/8 (314.3)
A. Gskt: [1] Attached
F. Gskt: G103-N
Related To: PA1681-FN (Standard Media Version)

PA1681-FN



Outer Air Element with Fins
Fits: GMC, Mack Trucks; Allis Chalmers, Case, Caterpillar, John Deere Equipment
Use With: PA2321, PA2570
Replaces: GMC 6424690; Mack 2MD455AP2
O.D.: 6 3/32 (154.8)
 Fins 7 13/16 (198.4)
I.D.: 3/4 (19.0) & 3 15/32 (88.1)
Height: 12 3/8 (314.3)
A. Gskt: [1] Attached
F. Gskt: G103-N
Related To: LL1681-FN (Long-Life Media Version)

PA1682



Air Element with Lift Tab
Fits: Allis Chalmers Equipment
Replaces: Allis Chalmers 236650
O.D.: 5 1/2 (139.7)
I.D.: 3 1/8 (79.4) One End
Height: 14 1/4 (362.0)
A. Gskt: [1] Attached

PA1683



Outer Air Element with Lift Tab
Contains: Flame Retardant Media
Fits: Allis Chalmers, Ford, International, Massey Ferguson Equipment
Use With: PA1809
Replaces: Allis Chalmers 237395; Ford E6NN9B618AB; Massey Ferguson 1026191-M91
O.D.: 4 1/2 (114.3)
I.D.: 2 1/4 (57.2) One End
Height: 10 3/4 (273.1)
A. Gskt: [1] Attached

PA1684



Outer Air Element with Lift Bar
Contains: Flame Retardant Media
Fits: Allis Chalmers, Bobcat, Caterpillar, Hyster, International, John Deere Equipment; Bobcat Loaders
Use With: PA1809
Replaces: Allis Chalmers 235449; Case S63738; Caterpillar 65-6140; John Deere AH19853
O.D.: 4 1/2 (114.3)
I.D.: 2 1/4 (57.2) One End
Height: 12 5/8 (320.7)
A. Gskt: [1] Attached

PA1686



Inner Air Element
Fits Inside: PA1687
Fits: Bobcat Loaders; Case Equipment
Replaces: Case L31277; Clark 1804278
O.D.: 8 1/16 (204.8)
I.D.: 5 3/4 (146.0)
Height: 15 1/4 (387.3)

PA1687



Outer Air Element
Fits: Case Equipment
Use With: PA1686
Replaces: Case L31276; Clark 1805389
O.D.: 14 5/32 (359.6)
I.D.: 9 1/2 (241.3)
Height: 15 15/16 (404.8)

PA1688



Air Element
Contains: Flame Retardant Media
Fits: Caterpillar Lift Trucks
Replaces: Caterpillar 35-8896; GMC 25041709
O.D.: 2 15/16 (74.6)
 Flange 3 1/4 (82.6)
I.D.: 2 (50.8) One End
Height: 3 15/16 (100.0)

PA1689



Air Element
Replaces: White 3399-H2, 877834
O.D.: 7 5/16 (185.7)
I.D.: 5 5/16 (134.9)
Height: 6 1/2 (165.1)
A. Gskt: [2] Attached

LL1690-FN



Long Life Air Element with Fins
Notes: Outer element on some applications.
Fits: Allis Chalmers, Benford, Bobcat, Case, Case-International, Clark, Ford, Gehl, John Deere, Komatsu, Kubota Equipment; Thermo King Refrigeration Units
Use With: PA2861, PA4740
Replaces: Allis Chalmers 2103129; Case 542276; Caterpillar 9Y6839; Clark 1642645
O.D.: 4 3/32 (104.0)
 Fins 5 1/8 (130.2)
I.D.: 25/32 (19.8) & 2 15/32 (62.7)
Height: 10 11/32 (262.7)
A. Gskt: [1] Attached
F. Gskt: G103-N
Related To: PA1690-FN (Standard Media Version)

Measurements Are Shown In Inches And (Millimeters)

WARNING: These products can expose you to chemicals, including Diisononyl Phthalate, Carbon black extracts, Nickel, 1,3 Butadiene, Ethylene Oxide, Epichlorohydrin, which are known to the State of California to cause cancer, and Bisphenol, Ethylene Glycol, Ethylene Oxide, 1,3 Butadiene, Epichlorohydrin, which are known to the State of California to cause birth defects or other reproductive harm. For more information go to www.P65Warnings.ca.gov.

PA1690-FN Air Element with Fins
Notes: Outer element on some applications.
Fits: Allis Chalmers, Benford, Bobcat, Case, Case-International, Clark, Ford, Gehl, John Deere, Komatsu, Kubota Equipment; Thermo King Refrigeration Units
Use With: PA2861, PA4740
Replaces: Allis Chalmers 2103129; Case 542276; Caterpillar 9Y6839; Clark 1642645
O.D.: 4 3/32 (104.0)
Fins: 5 1/8 (130.2)
I.D.: 25/32 (19.8) & 2 15/32 (62.7)
Height: 10 11/32 (262.7)
A. Gskt: [1] Attached
F. Gskt: G103-N
Related To: LL1690-FN (Long-Life Media Version)



PA1699-FN Air Element with Fins
Fits: Allis Chalmers, Case Equipment
Replaces: Allis Chalmers 239622; Case A59586
O.D.: 6 3/32 (154.8)
Fins: 7 13/16 (198.4)
I.D.: 25/32 (19.8) & 3 15/32 (88.1)
Height: 14 15/32 (367.5)
A. Gskt: [1] Attached
F. Gskt: G103-N



PA1692 Air Element with Lift Tab
Fits: Dresser, Drott, Elgin, International, Wayne Equipment
Replaces: Drott 71405; Elgin 7075795; International 338744-R91; Wayne 47180
O.D.: 5 1/2 (139.7)
I.D.: 3 1/8 (79.4) One End
Height: 17 1/4 (438.2)
A. Gskt: [1] Attached



PA1700 Dual-Stage Air Element with Blanket and Screen
Fits: Autocar, Brockway, Diamond Reo Trucks; Allis Chalmers, Caterpillar, Gradall, Hyster Equipment
Replaces: Allis Chalmers 4051919; Brockway 22115; Towmotor 633075
O.D.: 8 11/32 (211.9)
I.D.: 3 7/8 (98.4) One End
Height: 9 11/16 (246.1)
Related To: PA617 (Standard Version)



PA1696 Air Element
Fits: Austin, MG Automotive
Replaces: Leyland 17H2538
O.D.: 5 (127.0)
I.D.: 3 9/16 (90.5)
Height: 3 11/16 (93.7)



PA1701 Dual-Stage Air Element with Blanket and Screen
Fits: Diamond Reo Trucks; Allis Chalmers Equipment
Use With: PA1701 FOAM
Replaces: Allis Chalmers 4051918; Hough 165935-H1
O.D.: 9 9/16 (242.9)
I.D.: 5 1/8 (130.2) One End
Height: 11 19/32 (294.5)
Related To: PA1913 (Other Housings) PA2627 (Both Ends Open)



PA1697 Air Element
Fits: MG Automotive
Replaces: Austin-Healey 37H732
O.D.: 4 5/16 (109.5)
I.D.: 2 7/8 (73.0)
Height: 3 11/16 (93.7)



PA1701 ELE Air Element
Fits: Diamond Reo Trucks; Allis Chalmers Equipment
Use With: PA1701 FOAM
Replaces: Allis Chalmers 4051918; Hough 165935-H1
O.D.: 9 9/16 (242.9)
I.D.: 5 1/8 (130.2) One End
Height: 11 19/32 (294.5)
Related To: PA1913 (Other Housings) PA2627 (Both Ends Open)



PA1698 Air Element
Contains: Flame Retardant Media
Replaces: Donaldson P133672, P133708
O.D.: 8 1/16 (204.8)
I.D.: 5 3/4 (146.0)
Height: 4 (101.6)



PA1701 FOAM Foam Blanket for PA1701 ELE
Use With: PA1701 ELE
Length: 29 (736.6)
Width: 10 1/2 (266.7)
Height: 1 (25.4)



PA1702 Dual-Stage Air Element with Blanket and Screen
Fits: Cummins, Waukesha Engines; Ingersoll-Rand Compressors
Use With: PA1702 FOAM
Replaces: Allis Chalmers 4052520; Cummins 3001692; Waukesha 163972B
O.D.: 12 15/32 (316.7)
I.D.: 7 7/8 (200.0) One End
Height: 16 (406.4)



PA1702 FOAM Foam Blanket for PA1702
Use With: PA1702
Length: 37 1/2 (952.5)
Width: 15 3/4 (400.0)
Height: 1 (25.4)



Measurements Are Shown In Inches And (Millimeters)
WARNING: These products can expose you to chemicals, including Diisononyl Phthalate, Carbon black extracts, Nickel, 1,3 Butadiene, Ethylene Oxide, Epichlorohydrin, which are known to the State of California to cause cancer, and Bisphenol, Ethylene Glycol, Ethylene Oxide, 1,3 Butadiene, Epichlorohydrin, which are known to the State of California to cause birth defects or other reproductive harm. For more information go to www.P65Warnings.ca.gov.

PA1703 Dual-Stage Air Element with Blanket and Screen
Fits: Caterpillar Engines
Replaces: Caterpillar 4L8465
O.D.: 9 15/16 (252.4)
I.D.: 5 1/2 (139.7)
Height: 12 (304.8)



PA1709 Cab Air Element
Fits: International, Steiger Equipment
Replaces: International 383711-R94; Steiger 64-084
O.D.: 6 3/32 (154.8)
I.D.: 3/4 (19.0) & 3 15/32 (88.1)
Height: 16 1/4 (412.8)
A. Gskt: [1] Attached
F. Gskt: G103-N



PA1704 Air Compressor Breather Element
Fits: Bendix-Westinghouse Air Compressors; Brockway, Caterpillar, GMC, Kenworth, Mack Trucks
Replaces: Bendix-Westinghouse 243009; Brockway 243009; Caterpillar 9L2169; GMC 2495698
O.D.: 3 (76.2)
I.D.: 1 5/8 (41.3)
Height: 1 3/8 (34.9)



PA1710 Air Element
Fits: International Wheel Tractors
Replaces: International 383732-R93
O.D.: 6 3/32 (154.8)
I.D.: 3/4 (19.0) & 3 15/32 (88.1)
Height: 11 1/4 (285.8)
A. Gskt: [1] Attached
F. Gskt: G103-N



PA1705-2 Air Element with 2-Inch Pleats
Fits: Dresser, Hough, International Equipment
Replaces: International 346777-R91
O.D.: 12 1/32 (305.6)
I.D.: 17/32 (13.5) & 7 11/16 (195.3)
Height: 10 3/8 (263.5)
A. Gskt: [1] Attached
F. Gskt: [1] Included
Related To: LL1626-2, PA1626-2 (without Attached Gasket)



PA1712 Air Element
Fits: Burns, Cub Cadet, Ford, Gilson, Jacobsen, John Deere, Lambert, Massey Ferguson, Roper, Springfield Lawn & Garden Tractors; Kohler, Tecumseh Engines; Ingersoll-Rand Compressors
Replaces: John Deere AM30800; Kohler 231847; Tecumseh-Lauson 31925; Massey Ferguson 231847
O.D.: 4 13/32 (111.9)
I.D.: 2 15/16 (74.6)
Height: 2 3/8 (60.3)



PA1706 Air Element
Notes: Inside-Out Flow Direction
Fits: Atlas Copco, Hough, International Equipment
Replaces: Atlas Copco 16193784; International 346779-R91
O.D.: 13 25/32 (350.0)
I.D.: 1/2 (12.7) & 9 7/16 (239.7)
Height: 14 1/2 (368.3)
A. Gskt: [1] Attached
F. Gskt: [1] Included
Related To: PA1630 (without Attached Gasket) PA1706XP (Extreme Performance Nano Version)



PA1718 Air Element
Fits: Lister-Petter, Rolls-Royce Engines
Replaces: Lister-Petter 20126010
O.D.: 5 1/2 (139.7)
I.D.: 3 1/4 (82.6)
Height: 4 1/2 (114.3)



PA1707-FN Air Element with Fins
Fits: International, Minneapolis-Moline, Oliver, White Combines, Tractors
Replaces: International 399631-R91; Oliver 158613A5; White 20-7002170
O.D.: 5 1/4 (133.4)
I.D.: 21/32 (16.7) & 2 5/8 (66.7)
Height: 14 1/4 (362.0)
A. Gskt: [1] Attached
F. Gskt: G103-N



PA1719 Air Element
Fits: Case, David Brown, Eddison Equipment; Lister Engines
Replaces: Case K922630; David Brown 922630; Lister 194010
O.D.: 8 1/4 (209.6)
I.D.: 5 7/8 (149.2)
Height: 3 15/16 (100.0)



PA1721 Air Element
Replaces: Gardner Denver 2010265
O.D.: 5 3/4 (146.0)
I.D.: 4 1/8 (104.8)
Height: 5 31/32 (151.6)















PA1721 Air Element
Replaces: Gardner Denver 2010265
O.D.: 5 3/4 (146.0)
I.D.: 4 1/8 (104.8)
Height: 5 31/32 (151.6)



Measurements Are Shown In Inches And (Millimeters)

WARNING: These products can expose you to chemicals, including Diisononyl Phthalate, Carbon black extracts, Nickel, 1,3 Butadiene, Ethylene Oxide, Epichlorohydrin, which are known to the State of California to cause cancer, and Bisphenol, Ethylene Glycol, Ethylene Oxide, 1,3 Butadiene, Epichlorohydrin, which are known to the State of California to cause birth defects or other reproductive harm. For more information go to www.P65Warnings.ca.gov.

<p>PA1726 Inner Air Element Fits Inside: PA666 Fits: Galion Graders; Optional Purolator Housings Replaces: Purolator 6659367 O.D.: 6 5/8 (168.3) I.D.: 4 1/4 (108.0) Height: 14 1/2 (368.3)</p> 	<p>PA1753-FN Air Element with Fins Fits: John Deere Equipment Replaces: John Deere AH69798 O.D.: 6 3/32 (154.8) Fins: 7 13/16 (198.4) I.D.: 3/4 (19.0) & 3 15/32 (88.1) Height: 10 13/32 (264.3) A. Gskt: [1] Attached F. Gskt: G103-N</p> 
<p>PA1735 Air Element Fits: AMC, Chrysler, Ford, International Automotive, Light-Duty Trucks Replaces: Chrysler 8992873; Ford C7AF-9600-N O.D.: 10 1/16 (255.6) I.D.: 7 21/32 (194.5) Height: 2 3/8 (60.3)</p> 	<p>PA1754 Air Element with Lift Tab Fits: Bantam, Bros, Dresser, Drott, International, Wayne Equipment Replaces: GMC 6483853; International 603889-C91; White 1739647 O.D.: 7 (177.8) I.D.: 4 13/32 (111.9) One End Height: 20 1/4 (514.4) A. Gskt: [1] Attached</p> 
<p>PA1748 Air Element Fits: Gravely Tractors Replaces: Gravely L823D, L832E, 13042P1 O.D.: 3 11/16 (93.7) I.D.: 2 3/16 (55.6) Height: 4 1/8 (104.8)</p> 	<p>PA1755-FN Air Element with Fins Fits: Allis Chalmers Equipment Replaces: Allis Chalmers 3038732-9 O.D.: 7 15/16 (201.6) Fins: 10 1/16 (255.6) I.D.: 1/2 (12.7) & 3 9/16 (90.5) Height: 13 3/8 (339.7) A. Gskt: [1] Attached F. Gskt: [1] Included</p> 
<p>PA1749-FN Air Element with Fins Fits: GMC Trucks; Murphy Diesel Engines Replaces: GMC 5197106; Murphy MD24618 O.D.: 7 15/16 (201.6) Fins: 10 1/16 (255.6) I.D.: 1/2 (12.7) & 3 9/16 (90.5) Height: 12 1/4 (311.2) A. Gskt: [1] Attached F. Gskt: [1] Included</p> 	<p>PA1757 Air Breather Element Fits: Jay Tampers Replaces: Davey 200595 O.D.: 3 7/16 (87.3) I.D.: 2 3/8 (60.3) Height: 2 1/16 (52.4)</p> 
<p>PA1750-FN Air Element with Fins Fits: Hino, International, Mitsubishi Trucks Replaces: GMC 6486936; Hino 17801-1150; International 381667-C91; Mitsubishi 30930-35100 O.D.: 9 7/32 (234.2) Fins: 11 5/8 (295.3) I.D.: 5/8 (15.9) & 4 27/32 (123.0) Height: 10 3/8 (263.5) A. Gskt: [1] Attached F. Gskt: [1] Included</p> 	<p>PA1758 Air Element Contains: Flame Retardant Media Fits: GM Automotive, Light-Duty Trucks Replaces: GMC 6424140 O.D.: 13 7/8 (352.4) I.D.: 11 5/8 (295.3) Height: 3 (76.2)</p> 
<p>PA1752-FN Air Element with Fins Fits: John Deere Tractors Replaces: John Deere AH19848 O.D.: 5 1/4 (133.4) Fins: 6 3/8 (161.9) I.D.: 21/32 (16.7) & 2 5/8 (66.7) Height: 9 3/8 (238.1) A. Gskt: [1] Attached F. Gskt: G103-N</p> 	<p>PA1763 Air Breather Element Fits: Galion Equipment Replaces: Galion D59585 O.D.: 2 7/32 (56.4) I.D.: 1 1/32 (26.2) Height: 2 5/16 (58.7)</p> 

Measurements Are Shown In Inches And (Millimeters)

WARNING: These products can expose you to chemicals, including Diisononyl Phthalate, Carbon black extracts, Nickel, 1,3 Butadiene, Ethylene Oxide, Epichlorohydrin, which are known to the State of California to cause cancer, and Bisphenol, Ethylene Glycol, Ethylene Oxide, 1,3 Butadiene, Epichlorohydrin, which are known to the State of California to cause birth defects or other reproductive harm. For more information go to www.P65Warnings.ca.gov.

PA1765 Panel Air Element
Notes: Do NOT use in cab air ventilation systems.
Fits: Atlas Copco Compressors; Caterpillar Industrial, Marine Engines
Use With: PA1765 FOAM
Replaces: Caterpillar 6L4714
Length: 24 (609.6)
Width: 24 (609.6)
Height: 2 9/16 (65.1)
A. Gskt: [1] Attached

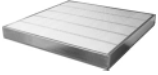

PA1765 FOAM Foam Blanket for PA1765
Use With: PA1765
Length: 26 (660.4)
Width: 24 (609.6)



PA1768 Air Element
Fits: Joy Compressors
Replaces: Joy 1224040
O.D.: 11 1/8 (282.6)
I.D.: 3/8 (9.5) & 6 3/16 (157.2)
Height: 18 1/8 (460.4)
A. Gskt: [1] Attached
F. Gskt: [1] Included, [1] Wing Bolt



PA1769 Air Element with Lift Bar
Fits: International, Michigan Equipment
Replaces: Eaton 509081800
O.D.: 7 (177.8)
I.D.: 4 3/8 (111.1) One End
Height: 9 1/4 (235.0)
A. Gskt: [1] Attached



PA1771 Tube-Type Air Filter
Contains: 4 Tubes--2 x 2
Fits: Bobcat Loaders; Farr Optional Housings; Lister Engines
Replaces: Farr P4
Length: 8 1/16 (204.8)
Width: 6 (152.4)
Height: 6 (152.4)



PA1772 Tube-Type Air Filter
Contains: 6 Tubes--2 x 3
Fits: Blaw-Knox, CMI Equipment; Farr Optional Housings
Replaces: Farr P6
Length: 8 1/4 (209.6)
Width: 5 31/32 (151.6)
Height: 8 1/8 (206.4)



PA1773 Tube-Type Air Filter
Contains: 9 Tubes--3 x 3
Fits: Farr Optional Housings
Replaces: Farr P9
Length: 8 5/16 (211.1)
Width: 8 5/16 (211.1)
Height: 8 1/16 (204.8)



PA1774 Tube-Type Air Filter
Contains: 12 Tubes--3 x 4
Fits: Dynahoe, Pettibone Equipment; Farr Optional Housings
Replaces: Farr P12
Length: 10 9/16 (268.3)
Width: 8 1/4 (209.6)
Height: 8 1/16 (204.8)



PA1775 Tube-Type Air Filter
Contains: 12 Tubes--2 x 6
Fits: Allis Chalmers, Blaw-Knox Equipment; Farr Optional Housings
Replaces: Farr P12-26
Length: 15 3/16 (385.8)
Width: 5 15/16 (150.8)
Height: 8 5/32 (207.2)



PA1776 Tube-Type Air Filter
Contains: 16 Tubes--4 x 4
Fits: Dresser, International, Taylor, Timberjack Equipment; Farr Optional Housings
Replaces: Farr P16
Length: 10 9/16 (268.3)
Width: 10 9/16 (268.3)
Height: 8 1/8 (206.4)



PA1777 Tube-Type Air Filter
Contains: 16 Tubes--2 x 8
Fits: Clark, Michigan Equipment; Farr Optional Housings
Replaces: Farr P16-28
Length: 19 27/32 (504.0)
Width: 5 31/32 (151.6)
Height: 8 5/32 (207.2)



PA1778 Tube-Type Air Filter
Contains: 20 Tubes--4 x 5
Fits: Farr Optional Housings; Taylor Equipment
Replaces: Farr P20
Length: 12 13/16 (325.4)
Width: 10 9/16 (268.3)
Height: 8 5/32 (207.2)

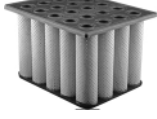

Measurements Are Shown In Inches And (Millimeters)

WARNING: These products can expose you to chemicals, including Diisononyl Phthalate, Carbon black extracts, Nickel, 1,3 Butadiene, Ethylene Oxide, Epichlorohydrin, which are known to the State of California to cause cancer, and Bisphenol, Ethylene Glycol, Ethylene Oxide, 1,3 Butadiene, Epichlorohydrin, which are known to the State of California to cause birth defects or other reproductive harm. For more information go to www.P65Warnings.ca.gov.

PA1779 Tube-Type Air Filter
Contains: 24 Tubes--4 x 8
Fits: Allis Chalmers, Clark, Dresser, Euclid, International, Massey Ferguson Equipment; Farr Optional Housings
Replaces: Farr P24
Length: 15 3/16 (385.8)
Width: 10 9/16 (268.3)
Height: 8 5/32 (207.2)



PA1780 Tube-Type Air Filter
Contains: 24 Tubes--3 x 8
Fits: Dodge, Leyland Trucks; Farr Optional Housings; Rolls-Royce Engines
Replaces: Farr P24-38
Length: 19 7/8 (504.8)
Width: 8 1/4 (209.6)
Height: 8 5/32 (207.2)

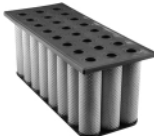

PA1781 Tube-Type Air Filter
Contains: 32 Tubes--4 x 8
Fits: Allis Chalmers, International, Michigan, M-R-S Equipment; Farr Optional Housings; Ingersoll-Rand Compressors
Replaces: Farr P32
Length: 19 7/8 (504.8)
Width: 10 9/16 (268.3)
Height: 8 5/32 (207.2)



PA1782 Tube-Type Air Filter
Contains: 40 Tubes--5 x 8
Fits: Allis Chalmers, International, Michigan, Equipment; Farr Optional Housings; Ingersoll-Rand, Sullair Compressors
Replaces: Farr P40
Length: 19 29/32 (505.6)
Width: 12 25/32 (324.6)
Height: 8 5/32 (207.2)

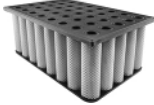

PA1783 Tube-Type Air Filter
Contains: 48 Tubes--6 x 8
Fits: Allis Chalmers, Caterpillar, CMI, Michigan Equipment; Cummins Engines; Dodge Trucks; Farr Optional Housings
Replaces: Farr P48
Length: 19 7/8 (504.8)
Width: 15 7/32 (386.6)
Height: 8 5/32 (207.2)

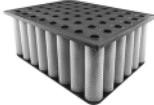

PA1784 Tube-Type Air Filter
Contains: 64 Tubes--8 x 8
Fits: Euclid, International, Kawasaki, WABCO Equipment; Farr Optional Housings
Replaces: Farr P64
Length: 19 13/16 (503.2)
Width: 19 13/16 (503.2)
Height: 8 1/8 (206.4)

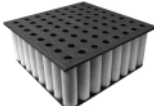

PA1786 Air Element
Fits: GMC, International Buses, Trucks
Replaces: GMC 3906250
O.D.: 12 15/16 (328.6)
I.D.: 10 7/16 (265.1)
Height: 3 (76.2)



PA1787 Air Element
Fits: Chrysler Industrial Engines; Cleveland Equipment
Replaces: GMC 6487076
O.D.: 6 3/32 (154.8)
I.D.: 7/16 (11.1) & 2 31/32 (75.4)
Height: 8 7/8 (225.4)
A. Gskt: [1] Attached
F. Gskt: [1] Included



PA1788 Air Element
Fits: Cummins Engines; Yale & Towne Cranes, Loaders
Replaces: Vortex VF120A; Yale 6952220
O.D.: 8 7/8 (225.4)
I.D.: 7/16 (11.1) & 5 (127.0)
Height: 10 1/8 (257.2)
A. Gskt: [1] Attached
F. Gskt: [1] Included



PA1789 Air Element
Fits: Mack Trucks
Replaces: GMC 6486928
O.D.: 10 3/8 (263.5)
I.D.: 1/2 (12.7) & 5 1/2 (139.7)
Height: 10 3/8 (263.5)
A. Gskt: [1] Attached
F. Gskt: [1] Included



PA1790 Air Element
Fits: International Trucks
Replaces: GMC 6488334; International 397549-C91
O.D.: 11 7/8 (301.6)
I.D.: 7/16 (11.1) & 7 1/8 (181.0)
Height: 13 3/8 (339.7)
A. Gskt: [1] Attached
F. Gskt: [1] Included













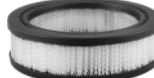

PA1794-FN Outer Air Element with Fins
Fits: John Deere Equipment
Use With: PA1921, PA2622
Replaces: John Deere AR39799
O.D.: 6 27/32 (173.8)
I.D.: 21/32 (16.7) & 4 5/32 (105.6)
Height: 10 1/2 (266.7)
A. Gskt: [1] Attached
F. Gskt: G103-N



Measurements Are Shown In Inches And (Millimeters)

WARNING: These products can expose you to chemicals, including Diisononyl Phthalate, Carbon black extracts, Nickel, 1,3 Butadiene, Ethylene Oxide, Epichlorohydrin, which are known to the State of California to cause cancer, and Bisphenol, Ethylene Glycol, Ethylene Oxide, 1,3 Butadiene, Epichlorohydrin, which are known to the State of California to cause birth defects or other reproductive harm. For more information go to www.P65Warnings.ca.gov.

<p>PA1795 Air Element Fits: Air Refiner ARH27 Housing Replaces: Air Refiner ARP27 O.D.: 9 1/8 (231.8) I.D.: 6 7/8 (174.6) Height: 12 (304.8)</p> 	<p>PA1809 Inner Air Element Fits Inside: PA1683, PA1684, PA2331, PA2431, PA2496 Fits: Caterpillar, Ford, Massey Ferguson Equipment Replaces: Ford E6NN-9R500-DA O.D.: 2 1/8 (54.0) Flange 2 11/32 (59.5) I.D.: 5/8 (15.9) & 1 7/8 (47.6) Height: 9 7/8 (250.8) F. Gskt: [1] Included O-Ring: [1] Attached</p> 
<p>PA1797 Inner Air Element Notes: Flange contains [9] bolt holes. Fits Inside: PA1815 Fits: Caterpillar Equipment Replaces: Caterpillar 3S4745 O.D.: 8 5/8 (219.1) Flange 12 (304.8) I.D.: 6 31/32 (177.0) One End Height: 15 11/32 (389.7) A. Gskt: [1] Attached</p> 	<p>PA1810 Air Element Replaces: Cummins 701645 O.D.: 9 5/8 (244.5) I.D.: 5 3/8 (136.5) Height: 12 3/16 (309.6) A. Gskt: [2] Attached</p> 
<p>PA1798 Air Element Notes: Sometimes used as Cab Air on Steiger Tractors. Fits: Chevrolet, GMC Buses, Trucks; Steiger Tractors Replaces: GMC 6423239 O.D.: 11 5/16 (287.3) I.D.: 8 17/32 (216.7) Height: 5 9/16 (141.3) Related To: PA1800 (with Foam Wrap)</p> 	<p>PA1814 Air Element Fits: Fiat, Triumph Automotive Replaces: Fiat 4110530 O.D.: 6 7/8 (174.6) I.D.: 5 1/8 (130.2) Height: 2 (50.8)</p> 
<p>PA1800 Air Element with Foam Wrap Notes: Sometimes used as Cab Air on Ford, Steiger Equipment. Fits: Ford, Steiger Equipment; GMC Buses, Trucks Replaces: Ford SFD54304; GMC 8877141 O.D.: 12 (304.8) I.D.: 8 17/32 (216.7) Height: 5 9/16 (141.3) Related To: PA1798 (without Foam Wrap)</p> 	<p>PA1815 Outer Air Element with Lid Fits: Caterpillar Equipment Use With: PA1797, PA2625 Replaces: Caterpillar 5S4282 O.D.: 13 5/8 (346.1) Lid 16 7/16 (417.5) I.D.: 15/16 (23.8) & 9 15/16 (252.4) Height: 16 5/32 (410.4) A. Gskt: [2] Attached</p> 
<p>PA1802 Air Element Fits: BMW, Ford Automotive, Light-Duty Trucks Replaces: Ford E4TE-9601-AA O.D.: 11 13/16 (300.0) I.D.: 9 13/16 (249.2) Height: 2 1/8 (54.0)</p> 	<p>PA1816 Outer Air Element with Lid Fits: Caterpillar Equipment Use With: PA1817 Replaces: Caterpillar 4S8833 O.D.: 12 3/4 (323.8) Lid 14 17/32 (369.1) I.D.: 15/16 (23.8) & 8 11/32 (211.9) Height: 9 13/16 (249.2) A. Gskt: [2] Attached F. Gskt: [1] Included</p> 
<p>PA1805 Air Element Fits: Allmand Equipment with Optional United Housings Replaces: United 250A13 O.D.: 6 11/32 (161.1) I.D.: 4 5/32 (105.6) Height: 3 1/32 (77.0)</p> 	<p>PA1817 Inner Air Element with 8 Bolt Holes Fits Inside: PA1816 Fits: Caterpillar Equipment Replaces: Caterpillar 4S8834 O.D.: 7 5/8 (193.7) Flange 10 1/4 (260.3) I.D.: 6 (152.4) One End Height: 8 25/32 (223.0) A. Gskt: [1] Attached</p> 
<p>PA1806 Tube-Type Air Filter Contains: 18 Tubes--3 x 6 Fits: Allis Chalmers Tractors; Farr Optional Housings Replaces: Allis Chalmers 70644042; Farr P18 Length: 15 3/16 (385.8) Width: 8 1/4 (209.6) Height: 8 1/8 (206.4)</p> 	

Measurements Are Shown In Inches And (Millimeters)

WARNING: These products can expose you to chemicals, including Diisononyl Phthalate, Carbon black extracts, Nickel, 1,3 Butadiene, Ethylene Oxide, Epichlorohydrin, which are known to the State of California to cause cancer, and Bisphenol, Ethylene Glycol, Ethylene Oxide, 1,3 Butadiene, Epichlorohydrin, which are known to the State of California to cause birth defects or other reproductive harm. For more information go to www.P65Warnings.ca.gov.

PA1818 Outer Air Element with Lid
Fits: Caterpillar Equipment
Use With: PA1819, PA2738
Replaces: Caterpillar 4S8337
O.D.: 12 3/4 (323.8)
 Lid 14 17/32 (369.1)
I.D.: 15/16 (23.8) & 8 3/8 (212.7)
Height: 14 1/2 (368.3)
A. Gskt: [2] Attached



PA1824 Outer Air Element
Fits: Dresser, International Equipment
Use With: PA1825
Replaces: International 606860-C91
O.D.: 9 7/32 (234.2)
I.D.: 4 27/32 (123.0) One End
Height: 18 3/8 (466.7)
A. Gskt: [1] Attached



PA1819 Inner Air Element with 8 Bolt Holes
Fits Inside: PA1818
Fits: Caterpillar Equipment
Replaces: Caterpillar 4S8340
O.D.: 7 5/8 (193.7)
 Flange 10 1/4 (260.3)
I.D.: 6 (152.4) One End
Height: 13 15/32 (342.1)
A. Gskt: [1] Attached



PA1825 Inner Air Element with 8 Bolts
Fits Inside: PA1824
Fits: Dresser, International Equipment
Replaces: International 606861-C91
O.D.: 4 9/16 (115.9)
 Flange 7 (177.8)
I.D.: 3 3/8 (85.7) One End
Height: 17 1/32 (432.6)
A. Gskt: [1] Attached



PA1821 Air Element
Fits: Massey Ferguson Tractors
Replaces: Massey Ferguson 1029945-M92
O.D.: 4 3/32 (104.0)
I.D.: 3/8 (9.5) & 2 15/32 (62.7)
Height: 9 3/8 (238.1)
A. Gskt: [1] Attached
F. Gskt: [1] Included, [1] Wing Bolt



PA1826 Inner Air Element with 8 Bolts
Fits Inside: PA1827
Fits: International Equipment
Replaces: International 390643-R91
O.D.: 4 9/16 (115.9)
 Flange 7 (177.8)
I.D.: 3 3/8 (85.7) One End
Height: 15 (381.0)
A. Gskt: [1] Attached



PA1822-FN Outer Air Element with Fins
Fits: J.C. Bamford, Massey Ferguson, Oliver Equipment
Use With: PA2305
Replaces: Massey Ferguson 726199-M1; Oliver 159089A
O.D.: 6 3/32 (154.8)
 Fins 7 13/16 (198.4)
I.D.: 3/4 (19.0) & 3 15/32 (88.1)
Height: 15 5/16 (388.9)
A. Gskt: [1] Attached
F. Gskt: G103-N
Related To: PA2418-FN (Different Gasket)



PA1827 Outer Air Element
Fits: International Equipment
Use With: PA1826
Replaces: International 390642-R91
O.D.: 9 7/32 (234.2)
I.D.: 4 27/32 (123.0) One End
Height: 16 3/8 (415.9)
A. Gskt: [1] Attached



PA1823 Air Element
Fits: International Payhaulers
Replaces: International 606029-C91
O.D.: 11 1/8 (282.6)
I.D.: 5/8 (15.9) & 6 23/32 (170.7)
Height: 18 1/2 (469.9)
A. Gskt: [1] Attached
F. Gskt: [1] Included



PA1828 Air Element
Fits: Ford Automotive
Replaces: Ford C7SF-9601-A
O.D.: 13 9/32 (337.3)
I.D.: 11 9/32 (286.5)
Height: 2 7/32 (56.4)



PA1830-FN Air Element with Fins
Fits: International Tractors
Replaces: International 381344-R91
O.D.: 5 1/4 (133.4)
 Fins 6 3/8 (161.9)
I.D.: 21/32 (16.7) & 2 5/8 (66.7)
Height: 10 1/4 (260.3)
A. Gskt: [1] Attached
F. Gskt: G103-N



Measurements Are Shown In Inches And (Millimeters)

WARNING: These products can expose you to chemicals, including Diisononyl Phthalate, Carbon black extracts, Nickel, 1,3 Butadiene, Ethylene Oxide, Epichlorohydrin, which are known to the State of California to cause cancer, and Bisphenol, Ethylene Glycol, Ethylene Oxide, 1,3 Butadiene, Epichlorohydrin, which are known to the State of California to cause birth defects or other reproductive harm. For more information go to www.P65Warnings.ca.gov.

PA1831 Air Element
Fits: Massey Ferguson Tractors; Perkins Engines
Replaces: Massey Ferguson 1028094-M91
O.D.: 6 1/16 (154.0)
I.D.: 3/8 (9.5) & 3 15/32 (88.1)
Height: 15 1/2 (393.7)
A. Gskt: [1] Attached
F. Gskt: [1] Included, [1] Wing Bolt



PA1841 Air Element
Fits: Chevrolet, GMC Light-Duty Trucks
Replaces: GMC 6485194
O.D.: 10 1/8 (257.2)
I.D.: 7 1/2 (190.5)
Height: 3 1/8 (79.4)



PA1832 Air Element
Fits: Petter Engines; V.M.E. Loaders; Volvo Equipment
Replaces: Petter ZFP35/6
O.D.: 5 1/2 (139.7)
I.D.: 3 1/4 (82.6)
Height: 2 5/16 (58.7)



PA1845 Air Element
Fits: Ford Trucks
Replaces: Ford C7TZ-9601-D
O.D.: 9 3/4 (247.7)
I.D.: 7/16 (11.1) & 5 1/4 (133.4)
Height: 13 29/32 (353.2)
A. Gskt: [1] Attached
F. Gskt: [1] Included, [1] Wing Bolt



PA1834 Air Element
Fits: Benford Equipment; Petter Engines
Replaces: Petter AAF449/6
O.D.: 3 17/32 (89.7)
I.D.: 2 (50.8)
Height: 2 (50.8)



LL1846 Long Life Outer Air Element
Fits: Chevrolet, Ford, GMC, Nissan, R.V.I., Scania Trucks; Allis Chalmers, Euclid, Fiat-Allis, Grove, Koehring, Michigan, WABCO Equipment
Use With: PA1880
Replaces: Allis Chalmers 659386; Euclid 9232508; Fiat 70198780; Ford D0HZ-9601-H; GMC 6489643
O.D.: 12 1/8 (308.0)
I.D.: 5/8 (15.9) & 7 11/16 (195.3)
Height: 18 1/2 (469.9)
A. Gskt: [1] Attached
F. Gskt: G103-N
Related To: PA1846 (Standard Version)
 PA1846XP (Extreme Performance Nano Version)



PA1836 Inner Air Element
Fits Inside: PA1837-FN, PA2338-FN
Fits: International Equipment
Replaces: International 392516-R91
O.D.: 5 1/4 (133.4)
I.D.: 5/8 (15.9) & 4 1/8 (104.8)
Height: 13 3/8 (339.7)
A. Gskt: [1] Attached
F. Gskt: [1] Included



PA1846 Outer Air Element
Fits: Chevrolet, Ford, GMC, Nissan, R.V.I., Scania Trucks; Allis Chalmers, Euclid, Fiat-Allis, Grove, Koehring, Michigan, WABCO Equipment
Use With: PA1880
Replaces: Allis Chalmers 659386; Euclid 9232508; Fiat 70198780; Ford D0HZ-9601-H; GMC 6489643
O.D.: 12 1/8 (308.0)
I.D.: 5/8 (15.9) & 7 11/16 (195.3)
Height: 18 1/2 (469.9)
A. Gskt: [1] Attached
F. Gskt: G103-N
Related To: LL1846 (Long-Life Media Version)
 PA1846XP (Extreme Performance Nano Version)



PA1837-FN Outer Air Element with Fins
Fits: International Equipment
Use With: PA1836
Replaces: International 392517-R91
O.D.: 7 15/16 (201.6)
 Fins 10 1/16 (255.6)
I.D.: 5 3/8 (136.5) One End
Height: 14 5/16 (363.5)
A. Gskt: [1] Attached



PA1846XP Extreme Performance Nano Outer Air Element
Fits: Chevrolet, Ford, GMC, Nissan, R.V.I., Scania Trucks; Allis Chalmers, Euclid, Fiat-Allis, Grove, Koehring, Michigan, WABCO Equipment
Use With: PA1880
Replaces: Allis Chalmers 659386; Euclid 9232508; Fiat 70198780; Ford D0HZ-9601-H; GMC 6489643
O.D.: 12 1/8 (308.0)
I.D.: 5/8 (15.9) & 7 11/16 (195.3)
Height: 18 1/2 (469.9)
A. Gskt: [1] Attached
F. Gskt: G103-N
Related To: LL1846 (Long-Life Media Version)
 PA1846 (Standard Media Version)















PA1840 Air Element
Replaces: Ford C5TF-9600-Y
O.D.: 9 7/32 (234.2)
I.D.: 5/8 (15.9) & 4 27/32 (123.0)
Height: 10 3/32 (256.4)
A. Gskt: [1] Attached
F. Gskt: [1] Included
Related To: PA2412 (with Air Restriction Gauge Fitting)



Measurements Are Shown In Inches And (Millimeters)

WARNING: These products can expose you to chemicals, including Diisononyl Phthalate, Carbon black extracts, Nickel, 1,3 Butadiene, Ethylene Oxide, Epichlorohydrin, which are known to the State of California to cause cancer, and Bisphenol, Ethylene Glycol, Ethylene Oxide, 1,3 Butadiene, Epichlorohydrin, which are known to the State of California to cause birth defects or other reproductive harm. For more information go to www.P65Warnings.ca.gov.

<p>PA1847-FN Outer Air Element with Fins Fits: Joy Compressors Use With: PA1880 Replaces: Joy 1224974 O.D.: 12 (304.8) Fins 15 3/4 (400.0) I.D.: 5/8 (15.9) & 7 11/16 (195.3) Height: 18 9/16 (471.5) A. Gskt: [1] Attached F. Gskt: G103-N</p> 	<p>PA1857 Air Element Fits: Worthington Compressors Replaces: Worthington FLR313 O.D.: 5 3/4 (146.0) I.D.: 4 1/4 (108.0) Height: 4 1/8 (104.8)</p> 
<p>PA1848 Air Element Fits: Ford Trucks Replaces: Ford C7TZ-9601-C O.D.: 8 9/32 (210.3) I.D.: 3/8 (9.5) & 4 7/16 (112.7) Height: 11 1/2 (292.1) A. Gskt: [1] Attached F. Gskt: [1] Included, [1] Wing Bolt</p> 	<p>PA1858 Air Element Fits: Bolens, Lockwood, Richmond Equipment; Wisconsin Engines Replaces: Wisconsin LO175B O.D.: 4 3/16 (106.4) I.D.: 1 15/16 (49.2) Height: 4 1/8 (104.8)</p> 
<p>PA1849 Air Element with Lift Tab Fits: Case Equipment Replaces: Case D46062 O.D.: 7 (177.8) I.D.: 4 13/32 (111.9) One End Height: 12 5/8 (320.7) A. Gskt: [1] Attached</p> 	<p>PA1859 Air Element Fits: Benford, Bolens, Midland Equipment; Wisconsin Engines Replaces: Wisconsin LO173B O.D.: 3 9/16 (90.5) I.D.: 2 1/8 (54.0) Height: 4 3/16 (106.4)</p> 
<p>PA1850-FN Air Element with Fins Fits: Clark, Huber Equipment Replaces: Clark 1990272 O.D.: 6 3/32 (154.8) Fins 7 13/16 (198.4) I.D.: 3/4 (19.0) & 3 15/32 (88.1) Height: 16 1/4 (412.8) A. Gskt: [1] Attached F. Gskt: G103-N</p> 	<p>PA1860 Air Element Replaces: Worthington ELM13 O.D.: 7 15/16 (201.6) I.D.: 6 9/32 (159.5) Height: 4 3/16 (106.4)</p> 
<p>PA1851 Air Element Fits: Barber-Greene, Winpower Equipment; Hercules Engines Replaces: GMC 6486930; White 40-0000619 O.D.: 7 5/16 (185.7) I.D.: 7/16 (11.1) & 3 1/2 (88.9) Height: 10 3/8 (263.5) A. Gskt: [1] Attached F. Gskt: G39-AF</p> 	<p>PA1861 Air Element Fits: Chicago-Pneumatic, Sullair Compressors Replaces: Sullair 40099 O.D.: 9 3/4 (247.7) I.D.: 6 1/16 (154.0) Height: 3 11/16 (93.7)</p> 
<p>PA1852 Air Element Fits: Mercedes-Benz, Opel Automotive Replaces: BMW 13720642102; Mercedes-Benz 947704; Opel 834252 O.D.: 5 7/8 (149.2) Top 6 1/2 (165.1) I.D.: 3 1/2 (88.9) Height: 4 9/32 (108.7)</p> 	<p>PA1863 Air Element Replaces: International 308504-C91 O.D.: 12 1/32 (305.6) I.D.: 17/32 (13.5) & 7 11/16 (195.3) Height: 14 1/2 (368.3) A. Gskt: [1] Attached F. Gskt: [1] Included Related To: PA1676-FN (with Fins)</p> 

Measurements Are Shown In Inches And (Millimeters)

WARNING: These products can expose you to chemicals, including Diisononyl Phthalate, Carbon black extracts, Nickel, 1,3 Butadiene, Ethylene Oxide, Epichlorohydrin, which are known to the State of California to cause cancer, and Bisphenol, Ethylene Glycol, Ethylene Oxide, 1,3 Butadiene, Epichlorohydrin, which are known to the State of California to cause birth defects or other reproductive harm. For more information go to www.P65Warnings.ca.gov.

PA1864-FN Outer Air Element with Fins
Fits: Joy Compressors
Use With: PA2455
Replaces: Joy 519002
O.D.: 11 1/8 (282.6)
 Fins 13 3/4 (349.3)
I.D.: 5/8 (15.9) & 6 23/32 (170.7)
Height: 15 1/2 (393.7)
A. Gskt: [1] Attached
F. Gskt: G103-N



V1874-T Vac-Cel Full-Flow Lube Sock
Fits: Waukesha Engines; Winslow Optional Filter Housings
Replaces: Winslow 1874 Series
O.D.: 6 1/2 (165.1)
I.D.: 2 3/4 (69.9)
Height: 17 (431.8)
O. Gskt: G206



PA1865-FN Air Element with Fins
Fits: Allis Chalmers, Bolens, Case, Ford, Gehl, John Deere, Kubota, Vermeer, Yanmar Equipment
Replaces: Allis Chalmers 70246364; Bolens 1872002; Case D82571; John Deere M73009; Kubota 15227-87481
O.D.: 3 1/4 (82.6)
 Fins 4 1/4 (108.0)
I.D.: 13/32 (10.3) & 1 27/32 (46.8)
Height: 7 1/4 (184.2)
A. Gskt: [1] Attached
F. Gskt: [1] Included



PA1875 Air Element
Fits: Master Equipment
Replaces: Master C6001
O.D.: 3 7/16 (87.3)
I.D.: 2 3/8 (60.3)
Height: 3 1/2 (88.9)



PA1866 Air Element
Contains: Flame Retardant Media
Fits: Cummins Engines
Replaces: Cummins 209892
O.D.: 9 5/8 (244.5)
I.D.: 5 (127.0)
Height: 6 9/16 (166.7)
A. Gskt: [2] Attached
Related To: PA1867 (Long Version)



PA1877 Air Element
Replaces: Mack 2MD49303A; White 27-074455
O.D.: 12 1/32 (305.6)
I.D.: 17/32 (13.5) & 7 11/16 (195.3)
Height: 12 1/2 (317.5)
A. Gskt: [1] Attached
F. Gskt: [1] Included



PA1867 Air Element
Contains: Flame Retardant Media
Fits: Cummins Engines
Replaces: Cummins 209893
O.D.: 9 5/8 (244.5)
I.D.: 5 (127.0)
Height: 8 1/16 (204.8)
A. Gskt: [2] Attached
Related To: PA1866 (Short Version)



PA1880 Inner Air Element
Fits Inside: LL1846, PA1846, PA1846XP, PA1847-FN, PA2478
Fits: Allis Chalmers, Euclid, Fiat-Allis, International, Kobelco, Komatsu, Terex Equipment; Gardner Denver, Ingersoll-Rand Compressors
Replaces: Allis Chalmers 1975888; International 511967-C91; Kobelco 2446U-212-S2
O.D.: 7 5/16 (185.7)
 Flange Gasket 8 15/32 (215.1)
I.D.: 11/16 (17.5) & 6 3/16 (157.2)
Height: 17 19/32 (446.9)
A. Gskt: [1] Attached
F. Gskt: G103-N



PA1868 Air Element
Fits: Atlas Copco Compressors
Replaces: Atlas Copco 1619-1613
O.D.: 6 7/16 (163.5)
I.D.: 4 1/16 (103.2)
Height: 10 1/2 (266.7)
A. Gskt: [2] Attached



PA1881 Air Element
Fits: Diamond Reo Buses, Trucks
Replaces: Diamond Reo 3107361-H2
O.D.: 11 1/8 (282.6)
I.D.: 5/8 (15.9) & 6 23/32 (170.7)
Height: 13 3/8 (339.7)
A. Gskt: [1] Attached
F. Gskt: G103-N



PA1873 Air Element
Replaces: Worthington FLR319
O.D.: 7 7/8 (200.0)
I.D.: 6 1/8 (155.6)
Height: 5 3/16 (131.8)



Measurements Are Shown In Inches And (Millimeters)

WARNING: These products can expose you to chemicals, including Diisononyl Phthalate, Carbon black extracts, Nickel, 1,3 Butadiene, Ethylene Oxide, Epichlorohydrin, which are known to the State of California to cause cancer, and Bisphenol, Ethylene Glycol, Ethylene Oxide, 1,3 Butadiene, Epichlorohydrin, which are known to the State of California to cause birth defects or other reproductive harm. For more information go to www.P65Warnings.ca.gov.

PA1882



Outer Air Element

Fits: Iveco Trucks; Hitachi, John Deere, Massey Ferguson Equipment
Use With: PA2570
Replaces: Iveco 9985779; John Deere AT65088; Massey Ferguson 1030543-M91
O.D.: 6 3/32 (154.8)
I.D.: 3/4 (19.0) & 3 15/32 (88.1)
Height: 12 15/32 (316.7)
A. Gskt: [1] Attached
F. Gskt: G103-N

PA1883-FN



Air Element with Fins

Fits: Case, John Deere Tractors
Replaces: Case D73225; John Deere AR44774
O.D.: 5 1/4 (133.4)
 Fins 6 3/8 (161.9)
I.D.: 2 1/32 (16.7) & 2 5/8 (66.7)
Height: 13 3/8 (339.7)
A. Gskt: [1] Attached
F. Gskt: G103-N

LL1884



Long Life Outer Air Element

Fits: Allis Chalmers, Case, Caterpillar, Daewoo, Doosan, Drott, Fiat-Allis, Grove, Hitachi, J.C. Bamford, Massey Ferguson, New Holland, Volvo Equipment; Foden, Ford Europe, Iveco, Leyland, R.V.I. Buses, Trucks
Use With: PA1911
Replaces: Ag-Chem 721237023A; Case S231996; Drott 609421; Fiat 1909136; J.C. Bamford 32/201602
O.D.: 9 7/32 (234.2)
I.D.: 2 1/32 (16.7) & 4 27/32 (123.0)
Height: 13 1/2 (342.9)
A. Gskt: [1] Attached
F. Gskt: G103-N
Related To: PA1941-FN (with Fins)
 PA1874 (Standard Media Version)
 PA1884XP (Extreme Performance Nano Version)

PA1884



Outer Air Element

Fits: Allis Chalmers, Case, Caterpillar, Daewoo, Doosan, Drott, Fiat-Allis, Grove, Hitachi, J.C. Bamford, Massey Ferguson, New Holland, Volvo Equipment; Foden, Ford Europe, Iveco, Leyland, R.V.I. Buses, Trucks
Use With: PA1911
Replaces: Ag-Chem 721237023A; Case S231996; Drott 609421; Fiat 1909136; J.C. Bamford 32/201602
O.D.: 9 7/32 (234.2)
I.D.: 2 1/32 (16.7) & 4 27/32 (123.0)
Height: 13 1/2 (342.9)
A. Gskt: [1] Attached
F. Gskt: G103-N
Related To: PA1941-FN (with Fins)
 LL1884 (Long-Life Media Version)
 PA1884XP (Extreme Performance Nano Version)

PA1884XP



Extreme Performance Nano Outer Air Element

Fits: Allis Chalmers, Case, Caterpillar, Daewoo, Doosan, Drott, Fiat-Allis, Grove, Hitachi, J.C. Bamford, Massey Ferguson, New Holland, Volvo Equipment; Foden, Ford Europe, Iveco, Leyland, R.V.I. Buses, Trucks
Use With: PA1911
Replaces: Ag-Chem 721237023A; Case S231996; Drott 609421; Fiat 1909136; J.C. Bamford 32/201602
O.D.: 9 7/32 (234.2)
I.D.: 2 1/32 (16.7) & 4 27/32 (123.0)
Height: 13 1/2 (342.9)
A. Gskt: [1] Attached
F. Gskt: G103-N
Related To: PA1941-FN (with Fins)
 LL1884 (Long-Life Media Version)
 PA1874 (Standard Media Version)

LL1885



Long Life Outer Air Element

Fits: Ag-Chem, Allis Chalmers, Caterpillar, Fiat-Allis, Gradall, Hitachi, John Deere, Kobelco, Komatsu, Massey Ferguson, Mitsubishi, New Holland Equipment; Foden, Iveco, Leland, M.A.N., Mitsubishi, R.V.I. Buses, Trucks
Use With: PA1893
Replaces: Ag-Chem 702455; Case L56041; Fiat-Allis 70662618; Hitachi 4237663; Iveco 1901902; Komatsu 600-181-3800
O.D.: 11 1/8 (282.6)
I.D.: 5/8 (15.9) & 6 23/32 (170.7)
Height: 16 1/2 (419.1)
A. Gskt: [1] Attached
F. Gskt: G103-N
Related To: PA1862 (Standard Media Version)
 PA1885XP (Extreme Performance Nano Version)

PA1885



Outer Air Element

Fits: Ag-Chem, Allis Chalmers, Caterpillar, Fiat-Allis, Gradall, Hitachi, John Deere, Kobelco, Komatsu, Massey Ferguson, Mitsubishi, New Holland Equipment; Foden, Iveco, Leyland, M.A.N., Mitsubishi, R.V.I. Buses, Trucks
Use With: PA1893
Replaces: Ag-Chem 702455; Case L56041; Fiat-Allis 70662618; Hitachi 4237663; Iveco 1901902; Komatsu 600-181-3800
O.D.: 11 1/8 (282.6)
I.D.: 5/8 (15.9) & 6 23/32 (170.7)
Height: 16 1/2 (419.1)
A. Gskt: [1] Attached
F. Gskt: G103-N
Related To: LL1885 (Long-Life Media Version)
 PA1885XP (Extreme Performance Nano Version)

Measurements Are Shown In Inches And (Millimeters)

WARNING: These products can expose you to chemicals, including Diisononyl Phthalate, Carbon black extracts, Nickel, 1,3 Butadiene, Ethylene Oxide, Epichlorohydrin, which are known to the State of California to cause cancer, and Bisphenol, Ethylene Glycol, Ethylene Oxide, 1,3 Butadiene, Epichlorohydrin, which are known to the State of California to cause birth defects or other reproductive harm. For more information go to www.P65Warnings.ca.gov.

PA1885XP



Extreme Performance Nano Outer Air Element
Fits: Ag-Chem, Allis Chalmers, Caterpillar, Fiat-Allis, Gradall, Hitachi, John Deere, Kobelco, Komatsu, Massey Ferguson, Mitsubishi, New Holland Equipment; Foden, Iveco, Leyland, M.A.N., Mitsubishi, R.V.I. Buses, Trucks
Use With: PA1893
Replaces: Ag-Chem 702455; Case L56041; Fiat-Allis 70662618; Hitachi 4237663; Iveco 1901902; Komatsu 600-181-3800
O.D.: 11 1/8 (282.6)
I.D.: 5/8 (15.9) & 6 23/32 (170.7)
Height: 16 1/2 (419.1)
A. Gskt: [1] Attached
F. Gskt: G103-N
Related To: LL1885 (Long-Life Media Version) PA1885 (Standard Media Version)

PA1886XP



Extreme Performance Nano Outer Air Element
Fits: Case, Drott, Liebherr Excavators; Champion Graders; Euclid Equipment; Hino, Iveco Trucks; Hough Loaders; Ingersoll-Rand Drills; New Holland, Versatile Tractors
Use With: PA1904, PA3832
Replaces: Allis Chalmers 663856; Euclid 4003970; International 619763-C91; Iveco 1901780; John Deere AT69308; Liebherr 5604682; New Holland V30924; Terex 9038899
O.D.: 12 1/8 (308.0)
I.D.: 29/32 (23.0) & 7 11/16 (195.3)
Height: 16 1/2 (419.1)
A. Gskt: [1] Attached
F. Gskt: [1] Included
O. Gskt: G225-AF
Related To: LL1886 (Long-Life Media Version) PA1886 (Standard Media Version)

LL1886



Long Life Outer Air Element
Fits: Case, Drott, Liebherr Excavators; Champion Graders; Euclid Equipment; Hino, Iveco Trucks; Hough Loaders; Ingersoll-Rand Drills; New Holland, Versatile Tractors
Use With: PA1904, PA3832
Replaces: Allis Chalmers 663856; Euclid 4003970; International 619763-C91; Iveco 1901780; John Deere AT69308; Liebherr 5604682; New Holland V30924; Terex 9038899
O.D.: 12 1/8 (308.0)
I.D.: 29/32 (23.0) & 7 11/16 (195.3)
Height: 16 1/2 (419.1)
A. Gskt: [1] Attached
F. Gskt: [1] Included
O. Gskt: G225-AF
Related To: PA1886 (Standard Media Version) PA1886XP (Extreme Performance Nano Version)

PA1888



Air Element
Replaces: White 892007
O.D.: 7 (177.8)
I.D.: 4 3/8 (111.1)
Height: 6 (152.4)

PA1889



Air Element
Fits: Ingersoll-Rand Compressors
Replaces: Ingersoll-Rand 35103217
O.D.: 7 7/8 (200.0)
I.D.: 4 1/8 (104.8)
Height: 3 (76.2)

PA1886



Outer Air Element
Fits: Case, Drott, Liebherr Excavators; Champion Graders; Euclid Equipment; Hino, Iveco Trucks; Hough Loaders; Ingersoll-Rand Drills; New Holland, Versatile Tractors
Use With: PA1904, PA3832
Replaces: Allis Chalmers 663856; Euclid 4003970; International 619763-C91; Iveco 1901780; John Deere AT69308; Liebherr 5604682; New Holland V30924; Terex 9038899
O.D.: 12 1/8 (308.0)
I.D.: 29/32 (23.0) & 7 11/16 (195.3)
Height: 16 1/2 (419.1)
A. Gskt: [1] Attached
F. Gskt: [1] Included
O. Gskt: G225-AF
Related To: LL1886 (Long-Life Media Version) PA1886XP (Extreme Performance Nano Version)

PA1891



Cab Air Element
Contains: Flame Retardant Media
Fits: Toyota Lift Trucks
Replaces: Toyota 17801-23020
O.D.: 7 (177.8)
I.D.: 4 7/8 (123.8)
Height: 4 5/8 (117.5)

PA1892-FN



Air Element with Fins
Fits: Chevrolet, GMC Trucks; Cummins Engines
Replaces: GMC 8994738
O.D.: 11 1/8 (282.6)
Fins: 13 3/4 (349.3)
I.D.: 5/8 (15.9) & 6 23/32 (170.7)
Height: 8 1/2 (215.9)
A. Gskt: [1] Attached
F. Gskt: [1] Included

Measurements Are Shown In Inches And (Millimeters)

WARNING: These products can expose you to chemicals, including Diisononyl Phthalate, Carbon black extracts, Nickel, 1,3 Butadiene, Ethylene Oxide, Epichlorohydrin, which are known to the State of California to cause cancer, and Bisphenol, Ethylene Glycol, Ethylene Oxide, 1,3 Butadiene, Epichlorohydrin, which are known to the State of California to cause birth defects or other reproductive harm. For more information go to www.P65Warnings.ca.gov.

PA1893



Inner Air Element

Fits Inside: LL1885, PA1885, PA1885XP, PA1979-FN
Fits: Ag-Chem, Allis Chalmers, Broyt, Caterpillar, Fiat-Allis, Grove, Hitachi, John Deere, Komatsu, Massey Ferguson, Michigan, Vermeer Equipment
Replaces: Ag-Chem 702463; Fiat-Allis 70662618; John Deere AU43090; Massey Ferguson 1495414-M91
O.D.: 6 13/32 (162.7)
 Flange 7 1/2 (190.5)
I.D.: 5/8 (15.9) & 5 1/4 (133.4)
Height: 16 (406.4)
A. Gskt: [1] Attached
F. Gskt: [1] Included

LL1895



Long Life Outer Air Element

Fits: Euclid, Michigan, Poclain, Steiger, Terex, Vermeer Equipment
Use With: PA1906
Replaces: Clark 1564734; Euclid 4005113; Steiger 45-213; Terex 4001155
O.D.: 10 7/32 (259.6)
I.D.: 15/16 (23.8) & 6 1/16 (154.0)
Height: 14 1/2 (368.3)
A. Gskt: [1] Attached
F. Gskt: [1] Included
Related To: PA1895 (Standard Media Version)

LL1894



Long Life Outer Air Element

Fits: Caterpillar, Dresser, Euclid, Ingersoll-Rand, Kawasaki, Michigan, Steiger, Terex, Volvo, WABCO Equipment
Use With: PA1905
Replaces: Caterpillar 8L5897; Euclid 9035866; Gardner Denver 166392; Terex 9035992
O.D.: 13 13/16 (350.8)
I.D.: 15/16 (23.8) & 9 1/2 (241.3)
Height: 18 1/2 (469.9)
A. Gskt: [1] Attached
F. Gskt: [1] Included
Related To: PA1894 (Standard Media Version)
 PA1894XP (Extreme Performance Nano Version)
 PA2749 (with Boot and Bail Handle)

PA1895



Outer Air Element

Fits: Euclid, Michigan, Poclain, Steiger, Terex, Vermeer Equipment
Use With: PA1906
Replaces: Clark 1564734; Euclid 4005113; Steiger 45-213; Terex 4001155
O.D.: 10 7/32 (259.6)
I.D.: 15/16 (23.8) & 6 1/16 (154.0)
Height: 14 1/2 (368.3)
A. Gskt: [1] Attached
F. Gskt: [1] Included
Related To: LL1895 (Long-Life Media Version)

PA1894



Outer Air Element

Fits: Caterpillar, Dresser, Euclid, Ingersoll-Rand, Kawasaki, Michigan, Steiger, Terex, Volvo, Wabco Equipment
Use With: PA1905
Replaces: Caterpillar 8L5897; Euclid 9035866; Gardner Denver 166392; Terex 9035992
O.D.: 13 13/16 (350.8)
I.D.: 15/16 (23.8) & 9 1/2 (241.3)
Height: 18 1/2 (469.9)
A. Gskt: [1] Attached
F. Gskt: [1] Included
Related To: LL1894 (Long-Life Media Version)
 PA1894XP (Extreme Performance Nano Version)
 PA2749 (with Boot and Bail Handle)

PA1896



Air Element

Replaces: GMC 6487818
O.D.: 13 13/16 (350.8)
I.D.: 1/2 (12.7) & 9 1/2 (241.3)
Height: 8 7/8 (225.4)
A. Gskt: [1] Attached
F. Gskt: [1] Included

PA1897



Inner Air Element

Fits Inside: PA1898
Fits: International Wheel Tractors
Replaces: International 398519-R91
O.D.: 4 1/8 (104.8)
I.D.: 13/32 (10.3) & 3 (76.2)
Height: 14 5/8 (371.5)
A. Gskt: [1] Attached
F. Gskt: [1] Included, [1] Wing Nut

PA1894XP



Extreme Performance Nano Outer Air Element

Fits: Caterpillar, Dresser, Euclid, Ingersoll-Rand, Kawasaki, Michigan, Steiger, Terex, Volvo, Wabco Equipment
Use With: PA1905
Replaces: Caterpillar 8L5897; Euclid 9035866; Gardner Denver 166392; Terex 9035992
O.D.: 13 13/16 (350.8)
I.D.: 15/16 (23.8) & 9 1/2 (241.3)
Height: 18 1/2 (469.9)
A. Gskt: [1] Attached
F. Gskt: [1] Included
Related To: LL1894 (Long-Life Media Version)
 PA1894 (Standard Media Version)
 PA2749 (with Boot and Bail Handle)

PA1898



Outer Air Element with Bail Handle

Fits: International Wheel Tractors
Use With: PA1897
Replaces: International 401270-R1
O.D.: 6 5/8 (168.3)
 Flange Gasket 6 7/8 (174.6)
I.D.: 4 1/4 (108.0) One End
Height: 15 7/16 (392.1)
A. Gskt: [1] Attached

Measurements Are Shown In Inches And (Millimeters)

WARNING: These products can expose you to chemicals, including Diisononyl Phthalate, Carbon black extracts, Nickel, 1,3 Butadiene, Ethylene Oxide, Epichlorohydrin, which are known to the State of California to cause cancer, and Bisphenol, Ethylene Glycol, Ethylene Oxide, 1,3 Butadiene, Epichlorohydrin, which are known to the State of California to cause birth defects or other reproductive harm. For more information go to www.P65Warnings.ca.gov.

PA1899 Inner Air Element
Fits Inside: PA1900
Fits: Elgin Sweepers; International Wheel Tractors
Replaces: International 398513-R91
O.D.: 4 1/8 (104.8)
I.D.: 13/32 (10.3) & 3 1/16 (77.8)
Height: 12 1/4 (311.2)
A. Gskt: [1] Attached
F. Gskt: [1] Included, [1] Wing Nut



PA1904 Inner Air Element
Fits Inside: LL1886, PA1886, PA1886XP
Fits: Allis Chalmers, Case, Dresser, Drott, Euclid, Hough, International, John Deere, Liebherr, New Holland, Terex, Vermeer, Versatile Equipment
Replaces: Euclid 4003970; Gardner Denver 175246; International 619763-C91; Versatile 30927
O.D.: 7 5/8 (193.7)
I.D.: 7/8 (22.2) & 6 1/16 (154.0)
Height: 15 13/32 (391.3)
A. Gskt: [1] Attached
F. Gskt: [1] Included



PA1900 Outer Air Element with Bail Handle
Fits: Elgin Sweepers; International Wheel Tractors
Use With: PA1899
Replaces: International 401269-R1
O.D.: 6 5/8 (168.3)
 Flange Gasket 6 7/8 (174.6)
I.D.: 4 1/4 (108.0) One End
Height: 12 7/8 (327.0)
A. Gskt: [2] Attached



PA1905 Inner Air Element
Fits Inside: LL1894, PA1894, PA1894XP, PA2749
Fits: Caterpillar, Dresser, Euclid, Hitachi, Michigan, Steiger, Volvo, WABCO Equipment
Replaces: Caterpillar 8L5897; Euclid 4005102; Hitachi 4206273; Steiger 45-253
O.D.: 8 5/8 (219.1)
I.D.: 15/16 (23.8) & 7 1/32 (178.6)
Height: 17 1/32 (432.6)
A. Gskt: [1] Attached
F. Gskt: G110-AF



PA1901 Air Element
Fits: Mercedes-Benz, Porsche Automotive; Akerman Excavators; Volvo Loaders
Replaces: Volvo 7820580
O.D.: 6 (152.4)
I.D.: 3 1/2 (88.9)
Height: 8 5/8 (219.1)



PA1906 Inner Air Element
Fits Inside: LL1895, PA1895
Fits: Euclid, Michigan, Poclain, Steiger, Terex, Vermeer Equipment
Replaces: Euclid 4000823; Terex 9038408
O.D.: 5 15/16 (150.8)
I.D.: 15/16 (23.8) & 4 27/32 (123.0)
Height: 12 1/2 (317.5)
A. Gskt: [1] Attached
F. Gskt: [1] Included



LL1902-FN Long Life Outer Air Element with Fins
Fits: Mercedes-Benz Trucks; Akerman, Allis Chalmers, Case, Daewoo, Dynapac, John Deere, Kawasaki, Komatsu, Michigan, White Equipment
Use With: PA1912, PA1981, PA1982
Replaces: Allis Chalmers 666432; Case R36360; Daewoo 24749020; John Deere AR45784
O.D.: 7 15/16 (201.6)
 Fins 10 (254.0)
I.D.: 11/16 (17.5) & 5 3/8 (136.5)
Height: 16 5/16 (414.3)
A. Gskt: [1] Attached
F. Gskt: G103-N
Related To: PA1902-FN (Standard Media Version)



PA1907-FN Outer Air Element with Fins
Fits: John Deere, Massey Ferguson Equipment
Use With: PA2535
Replaces: John Deere AM102746; Massey Ferguson 103262-M91
O.D.: 4 3/32 (104.0)
 Fins 5 1/8 (130.2)
I.D.: 25/32 (19.8) & 2 15/32 (62.7)
Height: 9 5/16 (236.5)
A. Gskt: [1] Attached
F. Gskt: G103-N



PA1902-FN Outer Air Element with Fins
Fits: Mercedes-Benz Trucks; Akerman, Allis Chalmers, Case, Daewoo, Dynapac, John Deere, Kawasaki, Komatsu, Michigan, White Equipment
Use With: PA1912, PA1981, PA1982
Replaces: Allis Chalmers 666432; Case R36360; Daewoo 24749020; John Deere AR45784
O.D.: 7 15/16 (201.6)
 Fins 10 (254.0)
I.D.: 11/16 (17.5) & 5 3/8 (136.5)
Height: 16 5/16 (414.3)
A. Gskt: [1] Attached
F. Gskt: G103-N
Related To: LL1902-FN (Long-Life Media Version)



PA1909 Air Breather Element
Fits: Bendix, Midland Air Compressors; GMC, International Trucks
Replaces: Bendix 100783; GMC 2457476; Midland 100696A
O.D.: 2 13/16 (71.4)
I.D.: 1 5/16 (33.3)
Height: 1 (25.4)



Measurements Are Shown In Inches And (Millimeters)

WARNING: These products can expose you to chemicals, including Diisononyl Phthalate, Carbon black extracts, Nickel, 1,3 Butadiene, Ethylene Oxide, Epichlorohydrin, which are known to the State of California to cause cancer, and Bisphenol, Ethylene Glycol, Ethylene Oxide, 1,3 Butadiene, Epichlorohydrin, which are known to the State of California to cause birth defects or other reproductive harm. For more information go to www.P65Warnings.ca.gov.

PA1911



Inner Air Element

Fits Inside: LL1884, PA1844, PA1884XP, PA2788, PA3629
Fits: Ag-Chem, Allis Chalmers, Case, Caterpillar, Clark, Daewoo, Fiat-Allis, Hitachi, International, J.C. Bamford, Kobelco, Komatsu, Massey Ferguson, Mitsubishi, New Holland, Steiger Equipment
Replaces: Allis Chalmers 3053290; Case P850561; Caterpillar 6I6582; Clark 1518700; Daewoo 24746025; International 530751-R1; Massey Ferguson 1495439-M91; Steiger 9003
O.D.: 4 19/32 (116.7)
 Flange 5 3/4 (146.0)
I.D.: 5/8 (15.9) & 3 7/16 (87.3)
Height: 13 (330.2)
A. Gskt: [1] Attached
F. Gskt: G103-N

PA1912



Inner Air Element

Fits Inside: LL1902-FN, PA1902-FN, PA2523, PA2641, PA4650-FN
Fits: Allis Chalmers, Case, Daewoo, Dynapac, Kobelco, Komatsu, White Equipment; Cummins, Detroit Diesel, Deutz, Fiat, International Engines
Replaces: Allis Chalmers 3053289; Case R36360; White 31-2755077
O.D.: 4 9/16 (115.9)
 Flange 5 3/4 (146.0)
I.D.: 2 1/32 (16.7) & 3 7/16 (87.3)
Height: 15 21/32 (397.7)
A. Gskt: [1] Attached
F. Gskt: G103-N

PA1913



Air Element

Fits: Donaldson EDG130010 Housing
Replaces: FWD Corporation 10175493; Oshkosh 17230F
O.D.: 10 3/8 (263.5)
I.D.: 7 13/16 (198.4) One End
Height: 12 (304.8)
Related To: PA616, PA1701 ELE (Other Housings)

PA1915



Air Breather Element for Hydraulic Reservoir

Fits: Mack Electra Haul
Replaces: International 427781
O.D.: 2 15/16 (74.6)
I.D.: 1 15/16 (49.2)
Height: 2 3/16 (55.6)

PA1916



Air Compressor Element

Fits: Ingersoll-Rand, Joy, Sullair Compressors
Replaces: Ingersoll-Rand 35104793; Joy 1224813; Sullair 40899
O.D.: 9 3/4 (247.7)
I.D.: 6 1/16 (154.0)
Height: 5 13/32 (137.3)

PA1919-FN



Air Element with Fins

Fits: Allis Chalmers Tractors
Replaces: Allis Chalmers 2565687
O.D.: 7 15/16 (201.6)
 Fins 10 1/16 (255.6)
I.D.: 1/2 (12.7) & 3 9/16 (90.5)
Height: 9 3/8 (238.1)
A. Gskt: [1] Attached
F. Gskt: [1] Included

PA1920



Air Element

Replaces: Autocar 6GT0330; Diamond Reo 10392-H2
O.D.: 12 1/32 (305.6)
I.D.: 5/8 (15.9) & 7 11/16 (195.3)
Height: 13 3/8 (339.7)
A. Gskt: [1] Attached
F. Gskt: G103-N

PA1921



Inner Air Element

Fits Inside: PA1794-FN
Fits: John Deere Equipment
Replaces: John Deere AT25219
O.D.: 4 3/32 (104.0)
I.D.: 25/32 (19.8) & 2 15/32 (62.7)
Height: 7 5/16 (185.7)
A. Gskt: [1] Attached
F. Gskt: G103-N

PA1922



Air Element

Replaces: Blue Bird 2105773
O.D.: 9 7/32 (234.2)
I.D.: 21/32 (16.7) & 4 27/32 (123.0)
Height: 8 5/16 (211.1)
A. Gskt: [1] Attached
F. Gskt: G103-N
Related To: PA1922-FN (with Fins)

PA1922-FN



Air Element with Fins

Fits: Caterpillar Engines; Chevrolet, Ford, GMC Buses, Trucks
Replaces: Caterpillar 7W7419; Ford C8HZ-9601-A; GMC 8994760
O.D.: 9 7/32 (234.2)
 Fins 11 5/8 (295.3)
I.D.: 21/32 (16.7) & 4 27/32 (123.0)
Height: 8 5/16 (211.1)
A. Gskt: [1] Attached
F. Gskt: G103-N
Related To: PA1922 (without Fins)

Measurements Are Shown In Inches And (Millimeters)

WARNING: These products can expose you to chemicals, including Diisononyl Phthalate, Carbon black extracts, Nickel, 1,3 Butadiene, Ethylene Oxide, Epichlorohydrin, which are known to the State of California to cause cancer, and Bisphenol, Ethylene Glycol, Ethylene Oxide, 1,3 Butadiene, Epichlorohydrin, which are known to the State of California to cause birth defects or other reproductive harm. For more information go to www.P65Warnings.ca.gov.

PA1926 Outer Air Element
Fits: John Deere Equipment
Use With: PA2413
Replaces: John Deere AR43605
O.D.: 6 7/8 (174.6)
I.D.: 3 1/2 (88.9) One End
Height: 12 3/8 (314.3)
A. Gskt: [1] Attached



PA1940 Air Element
Fits: Iveco Trucks; John Deere Tractors
Replaces: Iveco 1902040; John Deere AR46976
O.D.: 6 7/8 (174.6)
I.D.: 2 1/32 (16.7) & 3 1/2 (88.9)
Height: 14 3/8 (365.1)
A. Gskt: [1] Attached
F. Gskt: G103-N



PA1932 Air Element
Replaces: Ford C8AZ-9601-C
O.D.: 9 7/32 (234.2)
I.D.: 2 1/32 (16.7) & 4 27/32 (123.0)
Height: 11 1/2 (292.1)
A. Gskt: [1] Attached
F. Gskt: G103-N



PA1941-FN Outer Air Element with Fins
Fits: John Deere, Komatsu Equipment
Use With: PA1967
Replaces: John Deere AT27824; Komatsu 381-980-7031
O.D.: 9 7/32 (234.2)
 Fins 11 5/8 (295.3)
I.D.: 2 1/32 (16.7) & 4 27/32 (123.0)
Height: 13 1/2 (342.9)
A. Gskt: [1] Attached
F. Gskt: G103-N
Related To: LL1884, PA1874, PA1884XP (without Fins)



PA1934 Air Element
Fits: Joy Compressors; Perkins Engines
Replaces: Joy 1222940
O.D.: 7 7/8 (200.0)
I.D.: 6 1/8 (155.6)
Height: 8 1/32 (204.0)



PA1945 Air Element with Lift Bar
Fits: International Wheel Tractors
Replaces: International 403889-R1
O.D.: 5 1/4 (133.4)
I.D.: 2 1/4 (57.2) One End
Height: 10 13/16 (274.6)
A. Gskt: [1] Attached



PA1936 Outer Air Element
Fits: Dresser, Hough, International Equipment; Quincy Compressors
Use With: PA1937
Replaces: International 702672-C1; Quincy 21098
O.D.: 12 1/2 (317.5)
I.D.: 3/4 (19.0) & 7 1/2 (190.5)
Height: 27 1/2 (698.5)
A. Gskt: [1] Attached
F. Gskt: [1] Included



PA1946 Air Element
Fits: WABCO AVC Compressors
Replaces: WABCO H43-534
O.D.: 4 3/16 (106.4)
I.D.: 1 15/16 (49.2)
Height: 5 3/4 (146.0)

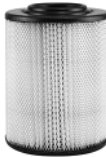

PA1937 Inner Air Element
Fits Inside: PA1936
Fits: Dresser, Hough, International Equipment; Quincy Compressors
Replaces: International 702673-C1; Quincy 21099
O.D.: 7 3/8 (187.3)
I.D.: 3/4 (19.0) & 6 1/8 (155.6)
Height: 25 7/8 (657.2)
A. Gskt: [1] Attached
F. Gskt: G103-N



PA1949 Air Element
Fits: Joy, Sullair Compressors
Replaces: Sullair 40186
O.D.: 7 7/8 (200.0)
I.D.: 4 1/8 (104.8)
Height: 4 (101.6)



PA1951 Air Element
Replaces: Joy 543048
O.D.: 5 11/16 (144.5)
I.D.: 2 (50.8)
Height: 3 1/4 (82.6)



PA1951 Air Element
Replaces: Joy 543048
O.D.: 5 11/16 (144.5)
I.D.: 2 (50.8)
Height: 3 1/4 (82.6)



Measurements Are Shown In Inches And (Millimeters)

WARNING: These products can expose you to chemicals, including Diisononyl Phthalate, Carbon black extracts, Nickel, 1,3 Butadiene, Ethylene Oxide, Epichlorohydrin, which are known to the State of California to cause cancer, and Bisphenol, Ethylene Glycol, Ethylene Oxide, 1,3 Butadiene, Epichlorohydrin, which are known to the State of California to cause birth defects or other reproductive harm. For more information go to www.P65Warnings.ca.gov.

PA1952



Air Element

Fits: Joy, Sullair Compressors
Replaces: Joy 1225150; Sullair 40406
O.D.: 12 1/16 (306.4)
I.D.: 3/8 (9.5) & 6 3/32 (154.8)
Height: 21 1/16 (535.0)
A. Gskt: [1] Attached
F. Gskt: [1] Included

PA1963



Air Element

Contains: Flame Retardant Media
Fits: Datsun Lift Trucks
Replaces: Nissan 16546-48200
O.D.: 6 5/16 (160.3)
I.D.: 3 11/16 (93.7)
Height: 5 (127.0)
O. Gskt: [2] G120-A

PA1953



Air Element

Fits: Air Maze Housings; Joy Compressors
Replaces: Air Maze CD1623503-826
O.D.: 12 1/16 (306.4)
I.D.: 3/8 (9.5) & 6 3/32 (154.8)
Height: 21 1/16 (535.0)
A. Gskt: [1] Attached
F. Gskt: [1] Included

PA1967



Inner Air Element

Fits Inside: PA1941-FN, PA2304-FN, PA2351, PA2421
Fits: Agco, Case, John Deere, Massey Ferguson, Vermeer, White Equipment
Replaces: Agco 72163296; Case A47136; John Deere AT34895; Massey Ferguson 3385734-M1; Vermeer 100489009; White 168698-AS
O.D.: 4 9/16 (115.9)
I.D.: 21/32 (16.7) & 3 7/16 (87.3)
Height: 11 1/4 (285.8)
A. Gskt: [1] Attached
F. Gskt: G103-N

PA1956-FN



Outer Air Element with Fins

Fits: Case Loaders
Use With: PA1957
Replaces: Case L32512
O.D.: 11 1/8 (282.6)
Fins: 13 3/4 (349.3)
I.D.: 5/8 (15.9) & 6 3/4 (171.5)
Height: 9 3/8 (238.1)
A. Gskt: [1] Attached
F. Gskt: G103-N

PA1969

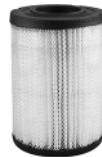

Air Element

Fits: Davis, Ditch Witch, International, John Deere, New Holland Equipment; Wisconsin Engines
Replaces: Ditch Witch 195352; International 405716-R1; Wisconsin LO185
O.D.: 4 3/16 (106.4)
I.D.: 1 15/16 (49.2)
Height: 6 1/8 (155.6)

PA1957



Inner Air Element

Fits Inside: PA1956-FN
Fits: Case Loaders
Replaces: Case L32513
O.D.: 6 3/8 (161.9)
Flange Gasket: 7 1/2 (190.5)
I.D.: 5/8 (15.9) & 5 1/4 (133.4)
Height: 9 (228.6)
A. Gskt: [1] Attached
F. Gskt: G103-N

PA1972



Air Element

Fits: International Equipment; Iveco Trucks
Replaces: International 529373-R1
O.D.: 6 7/8 (174.6)
I.D.: 21/32 (16.7) & 3 1/2 (88.9)
Height: 14 3/8 (365.1)
A. Gskt: [1] Attached
F. Gskt: G103-N

PA1960

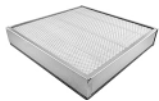

Panel Air Element

Notes: Sometimes used as Cab Air on John Deere Combines.
Fits: Caterpillar Engines, Equipment; John Deere Combines
Replaces: Caterpillar 6L8485
Length: 15 (381.0)
Width: 15 (381.0)
Height: 2 9/16 (65.1)
A. Gskt: [1] Attached

PA1973



Air Element

Contains: Flame Retardant Media
Fits: Datsun, Nissan, TCM Lift Trucks
Replaces: Nissan 16546-19900; TCM 20801-03121
O.D.: 5 23/32 (145.3)
I.D.: 3 1/16 (77.8)
Height: 3 1/8 (79.4)

PA1961

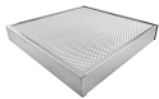











Cab Air Element

Fits: Allis Chalmers, John Deere Equipment
Replaces: John Deere AH66302
Length: 15 (381.0)
Width: 15 (381.0)
Height: 2 3/16 (55.6)













Measurements Are Shown In Inches And (Millimeters)

WARNING: These products can expose you to chemicals, including Diisononyl Phthalate, Carbon black extracts, Nickel, 1,3 Butadiene, Ethylene Oxide, Epichlorohydrin, which are known to the State of California to cause cancer, and Bisphenol, Ethylene Glycol, Ethylene Oxide, 1,3 Butadiene, Epichlorohydrin, which are known to the State of California to cause birth defects or other reproductive harm. For more information go to www.P65Warnings.ca.gov.

<p>PA1975 Outer Air Element Fits: Case, Dresser, New Holland, Steiger, Versatile Tractors Use With: PA1976, PA2672 Replaces: Steiger 13-898; Versatile 63971 O.D.: 13 13/16 (350.8) I.D.: 15/16 (23.8) & 9 1/2 (241.3) Height: 22 1/2 (571.5) A. Gskt: [1] Attached F. Gskt: [1] Included O. Gskt: G285-AF Related To: PA2675 (with Boot)</p> 	<p>PA1981 Inner Air Element Fits Inside: LL1902-FN, PA1902-FN, PA3675, PA3849 Fits: Fiat-Allis, International, John Deere, Liebherr, Oliver, White Equipment Replaces: International 920803-C91; John Deere T46317; White 166277-AS O.D.: 4 9/16 (115.9) I.D.: 21/32 (16.7) & 3 7/16 (87.3) Height: 15 3/8 (390.5) A. Gskt: [1] Attached F. Gskt: G103-N</p> 
<p>PA1976 Inner Air Element Fits Inside: PA1975, PA2675 Fits: Allis Chalmers, Dresser, Euclid, Fiat Allis, Terex Equipment Replaces: Allis Chalmers 70690304; Fiat Allis 70686821; Terex 9036293 O.D.: 8 5/8 (219.1) I.D.: 15/16 (23.8) & 7 1/16 (179.4) Height: 21 1/32 (534.2) A. Gskt: [1] Attached F. Gskt: [1] Included</p> 	<p>PA1982 Inner Air Element Fits Inside: LL1902-FN, PA1902-FN, PA1989-FN Fits: Case, John Deere Equipment Replaces: Case A62255; John Deere AR45785 O.D.: 5 1/4 (133.4) I.D.: 5/8 (15.9) & 4 1/8 (104.8) Height: 11 1/4 (285.8) A. Gskt: [1] Attached F. Gskt: G103-N</p> 
<p>PA1977-FN Air Element with Fins Fits: Ford Buses, Trucks Replaces: Ford DOHZ-9601-B O.D.: 11 1/8 (282.6) Fins 13 3/4 (349.3) I.D.: 5/8 (15.9) & 6 3/4 (171.5) Height: 10 3/8 (263.5) A. Gskt: [1] Attached F. Gskt: G103-N</p> 	<p>PA1985 Air Element Fits: Jay Tamper; Wacker Equipment Replaces: Wacker 2-5308 O.D.: 3 (76.2) I.D.: 1 5/8 (41.3) Height: 3 (76.2)</p> 
<p>PA1978-FN Air Element with Fins Fits: Ford Trucks Replaces: Ford DOHZ-9601-C O.D.: 11 1/8 (282.6) Fins 13 3/4 (349.3) I.D.: 5/8 (15.9) & 6 3/4 (171.5) Height: 14 3/8 (365.1) A. Gskt: [1] Attached F. Gskt: G103-N</p> 	<p>PA1986 Air Element Fits: Ford Trucks Replaces: Motorcraft FA1008 O.D.: 9 1/16 (230.2) I.D.: 4 15/16 (125.4) Height: 10 5/16 (261.9) A. Gskt: [2] Included F. Gskt: G39-AF</p> 
<p>PA1979-FN Outer Air Element with Fins Fits: Ford Trucks Use With: PA1893 Replaces: Ford DOHZ-9601-A O.D.: 11 1/8 (282.6) Fins 13 3/4 (349.3) I.D.: 5/8 (15.9) & 6 3/4 (171.5) Height: 16 3/8 (415.9) A. Gskt: [1] Attached F. Gskt: G103-N</p> 	<p>PA1986-K Air Element with Reusable Lid-Fin Assembly Replaces: Motorcraft FA1008 O.D.: 9 1/16 (230.2) Lid 12 3/8 (314.3) I.D.: 3/8 (9.5) & 4 15/16 (125.4) Height: 10 3/8 (263.5) A. Gskt: [2] Attached F. Gskt: G39-AF Related To: PA1986 (Filter only)</p> 
<p>PA1980-FN Air Element with Fins Fits: Ford Buses, Trucks Use With: PA30026 Replaces: Ford DOHZ-9601-F O.D.: 12 (304.8) Fins 15 3/4 (400.0) I.D.: 5/8 (15.9) & 7 11/16 (195.3) Height: 10 3/8 (263.5) A. Gskt: [1] Attached F. Gskt: G103-N</p> 	













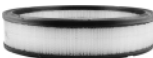

Measurements Are Shown In Inches And (Millimeters)

WARNING: These products can expose you to chemicals, including Diisononyl Phthalate, Carbon black extracts, Nickel, 1,3 Butadiene, Ethylene Oxide, Epichlorohydrin, which are known to the State of California to cause cancer, and Bisphenol, Ethylene Glycol, Ethylene Oxide, 1,3 Butadiene, Epichlorohydrin, which are known to the State of California to cause birth defects or other reproductive harm. For more information go to www.P65Warnings.ca.gov.

<p>PA1987 Air Element  Replaces: Wix 42773 O.D.: 9 1/16 (230.2) I.D.: 4 15/16 (125.4) Height: 9 5/16 (236.5) A. Gskt: [2] Attached F. Gskt: G39-AF</p>	<p>PA1997 Outer Air Element  Fits: Massey Ferguson, Minneapolis-Moline, Oliver Equipment Use With: PA1998, PA2469 Replaces: Massey Ferguson 1038944-M91 O.D.: 7 5/8 (193.7) Boot 8 5/8 (219.1) I.D.: 4 1/4 (108.0) One End Height: 16 3/8 (415.9) A. Gskt: [1] Attached</p>
<p>PA1989-FN Outer Air Element with Fins  Fits: Case Tractors Use With: PA1982 Replaces: Case A43264 O.D.: 7 15/16 (201.6) Fins 10 1/16 (255.6) I.D.: 11/16 (17.5) & 5 3/8 (136.5) Height: 13 1/4 (336.5) A. Gskt: [1] Attached F. Gskt: G103-N</p>	<p>PA1998 Inner Air Element  Fits Inside: PA1997, PA2495, PA2523 Fits: Massey Ferguson, Minneapolis-Moline, Oliver, White Equipment Replaces: Massey Ferguson 1038945-M91; White 20-7000316 O.D.: 4 1/8 (104.8) Flange 4 5/8 (117.5) I.D.: 25/32 (19.8) & 3 11/16 (93.7) Height: 14 27/32 (377.0) A. Gskt: [1] Attached F. Gskt: G103-N</p>
<p>LL1992 Long Life Air Element  Fits: Ford Trucks Replaces: Ford D5HZ-9601-B O.D.: 12 1/32 (305.6) I.D.: 5/8 (15.9) & 7 11/16 (195.3) Height: 16 3/8 (415.9) A. Gskt: [1] Attached F. Gskt: G103-N</p>	<p>PA2001 Air Element  Fits: Atlas Copco Compressors; Petter Engines Use With: PA2001 FOAM Replaces: Atlas Copco 16191269; Petter CF4223LT O.D.: 5 1/2 (139.7) I.D.: 3 1/4 (82.6) Height: 4 23/32 (119.9)</p>
<p>PA1992-FN Air Element with Fins  Replaces: International 407172-C91; White 27-074987 O.D.: 12 1/32 (305.6) Fins 15 3/4 (400.0) I.D.: 5/8 (15.9) & 7 11/16 (195.3) Height: 16 3/8 (415.9) A. Gskt: [1] Attached F. Gskt: G103-N</p>	<p>PA2001 FOAM Foam Blanket for PA2001  Use With: PA2001 Length: 17 1/8 (435.0) Width: 4 1/2 (114.3) Height: 1/2 (12.7)</p>
<p>PA1995 Outer Air Element with Bail Handles and Lid  Fits: John Deere Tractors Use With: PA1996 Replaces: John Deere AR51431 O.D.: 13 7/8 (352.4) Lid 15 1/16 (382.6) I.D.: 11/16 (17.5) & 7 7/16 (188.9) Height: 7 1/4 (184.2) A. Gskt: [2] Attached F. Gskt: G103-N</p>	<p>PA2002 Air Element  Fits: Ford Automotive, Light-Duty Trucks, Vans Replaces: Ford E4TE-9601-EA O.D.: 13 9/32 (337.3) I.D.: 11 9/32 (286.5) Height: 2 25/32 (70.6)</p>
<p>PA1996 Inner Air Element  Fits Inside: PA1995, PA2343 Fits: Case, John Deere, Oliver, White Equipment Replaces: Case A44186; John Deere AR53502, AR64624 O.D.: 6 7/8 (174.6) I.D.: 5/8 (15.9) & 4 3/16 (106.4) Height: 6 3/16 (157.2) A. Gskt: [1] Attached F. Gskt: G103-N</p>	<p>PA2005 Air Element  Fits: Ford Automotive, Light-Duty Trucks Replaces: Ford E4ZE-9601-AA O.D.: 10 7/8 (276.2) I.D.: 9 (228.6) Height: 2 3/16 (55.6)</p> <p>PA2006 Air Element  Fits: GM Automotive, Light-Duty Trucks Replaces: GMC 6484963 O.D.: 11 13/16 (300.0) I.D.: 9 13/16 (249.2) Height: 2 1/2 (63.5)</p>

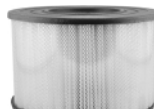
Measurements Are Shown In Inches And (Millimeters)

WARNING: These products can expose you to chemicals, including Diisononyl Phthalate, Carbon black extracts, Nickel, 1,3 Butadiene, Ethylene Oxide, Epichlorohydrin, which are known to the State of California to cause cancer, and Bisphenol, Ethylene Glycol, Ethylene Oxide, 1,3 Butadiene, Epichlorohydrin, which are known to the State of California to cause birth defects or other reproductive harm. For more information go to www.P65Warnings.ca.gov.

<p>PA2007 Air Element Fits: GM Automotive Replaces: GMC 6484294 O.D.: 10 3/4 (273.1) I.D.: 8 5/8 (219.1) Height: 2 9/16 (65.1)</p> 	<p>PA2036 Air Element O.D.: 6 11/16 (169.9) I.D.: 4 15/16 (125.4) Height: 2 3/8 (60.3)</p> 
<p>PA2008 Air Element Fits: GM Automotive, Light-Duty Trucks, Vans Replaces: GMC 6484235 O.D.: 11 13/16 (300.0) I.D.: 9 13/16 (249.2) Height: 3 15/32 (88.1)</p> 	<p>PA2037 Air Element Fits: Toyota Automotive Replaces: Toyota 17801-22010 O.D.: 7 7/16 (188.9) I.D.: 4 9/32 (108.7) Height: 2 3/4 (69.9)</p> 
<p>PA2009 Air Element Fits: Cadillac Automotive Replaces: GMC 6483644 O.D.: 12 5/16 (312.7) I.D.: 10 13/16 (274.6) Height: 2 5/8 (66.7)</p> 	<p>PA2038 Air Element with Wire Reinforced Media Fits: Ingersoll-Rand Compressors Replaces: Ingersoll-Rand 32012957 O.D.: 4 13/32 (111.9) I.D.: 3 1/32 (77.0) Height: 4 25/32 (121.4)</p> 
<p>PA2010 Air Element Fits: Chrysler Automotive, Light-Duty Trucks, Vans Replaces: Chrysler 2863349; Ford E3ZZ-9601-B O.D.: 12 3/4 (323.8) I.D.: 11 (279.4) Height: 2 3/4 (69.9)</p> 	<p>SA2039 Crankcase Breather Filter in Plastic Housing Contains: 9/16 Inch Fitting [1] Metal Clip Fits: Ford Automotive, Light-Duty Trucks, Vans Replaces: Ford D1AZ-6D695-A Length: 3 15/16 (100.0) Width: 1 23/32 (43.7)</p> 
<p>PA2023 Air Element Fits: Porsche, Saab Automotive Replaces: Saab-Scania 800181 O.D.: 6 7/32 (158.0) I.D.: 4 27/32 (123.0) Height: 3 1/32 (77.0)</p> 	<p>PA2041 Panel Air Element Fits: Geo, Toyota Automotive Replaces: GMC 25098522; Toyota 17801-74020 Length: 12 5/32 (308.8) Width: 6 1/8 (155.6) Height: 1 21/32 (42.1)</p> 
<p>PA2024 Air Element Fits: Ford Automotive, Light-Duty Trucks Replaces: Ford D0GY-9601-A O.D.: 13 (330.2) I.D.: 11 9/32 (286.5) Height: 2 1/2 (63.5)</p> 	<p>PA2042 Air Element Fits: Toyota Automotive, Light-Duty Trucks Replaces: Toyota 17801-60040 O.D.: 8 29/32 (226.2) I.D.: 4 9/32 (108.7) Height: 5 23/32 (145.3)</p> 
<p>SA2027 Poly Foam Oil Vapor Emission Filter Fits: GM Automotive, Light-Duty Trucks, Vans Replaces: GMC 6484966 Width: 1 25/32 (45.2) Height: 1 5/8 (41.3)</p> 	<p>PA2044 Air Element Fits: BMW Motorcycles Replaces: BMW 13721254382 O.D.: 5 1/16 (128.6) I.D.: 3 1/16 (77.8) Height: 4 1/2 (114.3)</p> 
<p>PA2031 Air Element Fits: Mazda, Nissan, Subaru Automotive; Nissan, TCM Lift Trucks Replaces: Nissan 16546-18000; Subaru 42145-4110; TCM 16546-L3200 O.D.: 9 (228.6) I.D.: 6 7/8 (174.6) Height: 1 15/16 (49.2)</p> 	

Measurements Are Shown In Inches And (Millimeters)

WARNING: These products can expose you to chemicals, including Diisononyl Phthalate, Carbon black extracts, Nickel, 1,3 Butadiene, Ethylene Oxide, Epichlorohydrin, which are known to the State of California to cause cancer, and Bisphenol, Ethylene Glycol, Ethylene Oxide, 1,3 Butadiene, Epichlorohydrin, which are known to the State of California to cause birth defects or other reproductive harm. For more information go to www.P65Warnings.ca.gov.

SA2047 Crankcase Breather Filter in Plastic Housing
Contains: 5/8 Inch Fitting
Fits: Ford Light-Duty Trucks, Vans
Replaces: Ford F4TZ-9D695-A
Width: 2 5/8 (66.7)
Height: 1 1/4 (31.8)



PA2050 Air Element
Replaces: Imperial Machine Products FI-5
O.D.: 6 5/8 (168.3)
I.D.: 5 (127.0)
Height: 2 1/16 (52.4)



PA2051 Air Element
Fits: Ford Automotive, Light-Duty Trucks, Vans
Replaces: Ford D2AZ-9601-A
O.D.: 11 3/16 (284.2)
I.D.: 9 1/16 (230.2)
Height: 2 11/16 (68.3)



PA2052 Air Element
Fits: Dodge, Plymouth Light-Duty Trucks, Vans
Replaces: Chrysler 3614353; GMC 6487801
O.D.: 10 7/8 (276.2)
I.D.: 9 (228.6)
Height: 3 17/32 (89.7)



PA2053 Air Element
Fits: GM Automotive
Replaces: GMC 7988027
O.D.: 5 3/4 (146.0)
I.D.: 3 1/2 (88.9)
Height: 2 5/32 (54.8)



PA2061 Air Element
Fits: International Trucks
Replaces: International 446661-C1, 446910-C1
O.D.: 12 5/8 (320.7)
I.D.: 9 3/4 (247.7)
Height: 5 (127.0)



PA2063 Air Element
Fits: John Deere Lawn & Garden Equipment; New Holland Loaders; Onan Engines
Replaces: John Deere AM106953; Onan 140-2628
O.D.: 7 29/32 (200.8)
I.D.: 6 1/2 (165.1)
Height: 2 1/8 (54.0)



PA2064 Air Element
Fits: Bolens, Ford, Husky, Hustler, Jacobsen Lawn & Garden Tractors, Mowers; Kohler Engines
Replaces: Kohler 277138
O.D.: 6 (152.4)
I.D.: 4 5/8 (117.5)
Height: 4 1/16 (103.2)
Related To: PA2067 (Short Version)



PA2065 Air Element
Fits: BMW, Toyota Automotive, Light-Duty Trucks
Replaces: Toyota 17801-41060
O.D.: 12 7/16 (315.9)
I.D.: 9 3/8 (238.1)
Height: 2 (50.8)



PA2067 Air Element
Fits: Allis Chalmers, Ariens, Case, Cub Cadet, Ford, Jacobsen, Power King, Simplicity Lawn & Garden Mowers, Tractors; Kohler, Onan Engines
Use With: PA2067 FOAM
Replaces: Allis Chalmers 2067783; Kohler 4508302; Onan 140-1216
O.D.: 6 (152.4)
I.D.: 4 5/8 (117.5)
Height: 3 1/8 (79.4)
Related To: PA2064 (Long Version)



PA2067 FOAM Foam Blanket for PA2067
Use With: PA2067
O.D.: 6 5/32 (156.4)
I.D.: 5 11/16 (144.5)
Height: 2 27/32 (72.2)



PA2068 Air Element
Fits: Allis Chalmers, Cub Cadet, Dixon, Ford, Power King Lawn & Garden Mowers, Tractors; International Wheel Tractors; Kohler Engines
Use With: PA2068 FOAM
Replaces: International 117210-C1; Kohler 4708301
O.D.: 7 (177.8)
I.D.: 5 9/16 (141.3)
Height: 1 25/32 (45.2)
Related To: PA2069 (Long Version)



PA2068 FOAM Foam Blanket for PA2068
Use With: PA2068
O.D.: 6 23/32 (170.7)
I.D.: 6 7/32 (158.0)
Height: 1 25/32 (45.2)



PA2069 Air Element
Fits: Bolens, Cub Cadet, Ford, John Deere Lawn & Garden Tractors; Kohler Engines
Use With: PA2069 FOAM
Replaces: John Deere M47494; Kohler 4708303
O.D.: 7 (177.8)
I.D.: 5 9/16 (141.3)
Height: 2 15/32 (62.7)
Related To: PA2068 (Short Version)



PA2069 FOAM Foam Blanket for PA2069
Use With: PA2069
O.D.: 6 5/8 (168.3)
I.D.: 6 7/32 (158.0)
Height: 2 3/16 (55.6)

















PA2070 Air Element
Replaces: Atlas Copco 1503-0188
O.D.: 5 5/32 (131.0)
I.D.: 3 3/8 (85.7)
Height: 1 13/32 (35.7)
Related To: PA2071 (Long Version)





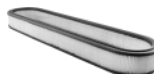









Measurements Are Shown In Inches And (Millimeters)

WARNING: These products can expose you to chemicals, including Diisononyl Phthalate, Carbon black extracts, Nickel, 1,3 Butadiene, Ethylene Oxide, Epichlorohydrin, which are known to the State of California to cause cancer, and Bisphenol, Ethylene Glycol, Ethylene Oxide, 1,3 Butadiene, Epichlorohydrin, which are known to the State of California to cause birth defects or other reproductive harm. For more information go to www.P65Warnings.ca.gov.

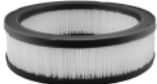
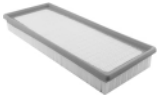
<p>PA2071 Air Element Fits: Atlas Copco Compressors Replaces: Atlas Copco 1503-0189 O.D.: 5 5/32 (131.0) I.D.: 3 3/8 (85.7) Height: 1 15/16 (49.2) Related To: PA2070 (Short Version)</p> 	<p>PA2081 Air Element Fits: Mercedes-Benz Automotive Replaces: Mercedes-Benz 10949504 O.D.: 11 5/16 (287.3) I.D.: 8 17/32 (216.7) Height: 3 3/8 (85.7)</p> 
<p>PA2072 Air Element Fits: Atlas Copco Compressors Replaces: Atlas Copco 1503-0190 O.D.: 5 31/32 (151.6) I.D.: 3 15/32 (88.1) Height: 2 25/32 (70.6)</p> 	<p>PA2083 Air Element Fits: Dodge, Plymouth Automotive Replaces: Chrysler 5240668 O.D.: 4 13/32 (111.9) I.D.: 2 15/16 (74.6) Height: 5 3/4 (146.0)</p> 
<p>PA2073 Air Element with Foam Wrap Fits: GMC Light-Duty Trucks, Vans Replaces: GMC 8996118 O.D.: 13 7/8 (352.4) I.D.: 11 5/8 (295.3) Height: 4 (101.6) Related To: PA2079 (without Foam Wrap)</p> 	<p>SA2084 Crankcase Breather Filter in Plastic Housing Fits: Ford Automotive, Light-Duty Trucks, Vans Replaces: Ford D7FZ-9D695-A Width: 1 13/32 (35.7) Height: 2 7/8 (73.0)</p> 
<p>PA2074 Air Element Fits: Ford Automotive, Light-Duty Trucks Replaces: Ford D7FZ-9601-A O.D.: 11 7/32 (285.0) I.D.: 9 3/8 (238.1) Height: 1 23/32 (43.7)</p> 	<p>SA2085 Crankcase Breather Filter in Plastic Housing Contains: 1/2 Inch Fitting [1] Metal Clip Fits: Ford Automotive, Light-Duty Trucks, Vans Replaces: Ford D8AZ-9D695-A Width: 1 31/32 (50.0) F. Gskt: [1] Foam Washer</p> 
<p>PA2075 Air Element Fits: Ford, Honda, Mazda Automotive, Light-Duty Trucks Replaces: Ford D7ZZ-9601-A; Honda 17220-PC2611 O.D.: 11 3/32 (281.8) I.D.: 8 1/2 (215.9) Height: 2 3/16 (55.6)</p> 	<p>PA2091 Air Element Fits: GMC Light-Duty Trucks, Vans Replaces: GMC 8997890 O.D.: 11 13/16 (300.0) I.D.: 9 13/16 (249.2) Height: 5 7/16 (138.1) Related To: PA2148 (with Foam Wrap)</p> 
<p>PA2076 Oblong Air Element Fits: GM Automotive Replaces: GMC 8996555 O.D.: 9 3/8 (238.1) to 10 9/16 (268.3) I.D.: 7 7/8 (200.0) & 9 1/16 (230.2) to Height: 2 1/8 (54.0)</p> 	<p>PA2092 Air Element Fits: Ford, International Light-Duty Trucks, Vans Replaces: Ford E7TZ-9600-A; International 446661-C2 O.D.: 11 7/16 (290.5) I.D.: 8 5/8 (219.1) Height: 5 (127.0) Related To: PA2115 (with Foam Wrap)</p> 
<p>PA2077 Air Element Fits: GM Automotive, Light-Duty Trucks, Vans Replaces: GMC 8996587 O.D.: 10 1/32 (254.8) I.D.: 8 17/32 (216.7) Height: 2 1/4 (57.2)</p> 	<p>PA2093 Oblong Air Element Replaces: Tecnocar A202 O.D.: 5 1/2 (139.7) to 24 1/4 (615.9) I.D.: 4 1/16 (103.2) & 22 27/32 (580.2) Height: 2 9/16 (65.1)</p> 
<p>PA2079 Air Element Fits: GM Automotive, Light-Duty Trucks Replaces: GMC 8997189 O.D.: 13 7/8 (352.4) I.D.: 11 5/8 (295.3) Height: 4 (101.6) Related To: PA2073 (with Foam Wrap)</p> 	<p>PA2094 Rectangular Air Element Fits: Ferrari Automotive Replaces: Ferrari 108545 O.D.: 12 3/8 (314.3) to 14 9/16 (369.9) I.D.: 11 1/32 (280.2) & 13 1/4 (336.5) Height: 2 1/8 (54.0)</p> 

Measurements Are Shown In Inches And (Millimeters)

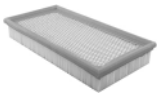
WARNING: These products can expose you to chemicals, including Diisononyl Phthalate, Carbon black extracts, Nickel, 1,3 Butadiene, Ethylene Oxide, Epichlorohydrin, which are known to the State of California to cause cancer, and Bisphenol, Ethylene Glycol, Ethylene Oxide, 1,3 Butadiene, Epichlorohydrin, which are known to the State of California to cause birth defects or other reproductive harm. For more information go to www.P65Warnings.ca.gov.

<p>PA2095 Air Element Fits: Kellogg Compressors Replaces: Kellogg 55669 O.D.: 9 3/4 (247.7) I.D.: 7 1/4 (184.2) Height: 4 (101.6)</p> 	<p>PA2104 Panel Air Element Fits: Chrysler Automotive, Light-Duty Trucks, Vans Replaces: Chrysler 4227087, 4306113, 4342801 Length: 8 1/16 (204.8) Width: 5 1/4 (133.4) Height: 1 5/8 (41.3)</p> 
<p>PA2096 Air Element Fits: Benford Equipment; Lister Engines Replaces: Lister 366-6227; Rootes 5058925 O.D.: 5 19/32 (142.1) I.D.: 4 (101.6) Height: 2 15/32 (62.7)</p> 	<p>PA2106 Air Element Fits: GMC, Isuzu Automotive, Light-Duty Trucks Replaces: GMC 25040929; Isuzu 8-25040-929-0 O.D.: 9 11/16 (246.1) I.D.: 8 3/16 (208.0) Height: 2 13/16 (71.4) Related To: PA4135 (with Foam Wrap)</p> 
<p>PA2099 Air Element Fits: Renault Automotive Replaces: Renault 7701005514 O.D.: 4 31/32 (126.2) I.D.: 3 11/32 (84.9) Height: 6 11/16 (169.9)</p> 	<p>PA2107 Air Element with Foam Wrap Fits: Ford Light-Duty Trucks, Vans Replaces: Ford E0TZ-9601-B O.D.: 9 (228.6) I.D.: 6 1/2 (165.1) Height: 3 1/4 (82.6) Related To: PA657 (without Foam Wrap)</p> 
<p>PA2100 Air Element Fits: Sullair Compressors Replaces: Sullair 40187 O.D.: 8 1/32 (204.0) I.D.: 5 5/16 (134.9) Height: 4 3/16 (106.4)</p> 	<p>PA2109 Air Element Fits: GM Automotive, Light-Duty Trucks Replaces: GMC 25040881 O.D.: 8 1/2 (215.9) I.D.: 6 15/16 (176.2) Height: 2 7/16 (61.9)</p> 
<p>PA2101A Panel Air Element Fits: Audi, Chrysler, Eagle, Jeep Volkswagen Automotive, Light-Duty Trucks; Case-International, Liebherr Equipment; Volvo Trucks Replaces: Chrysler 53006317; Volkswagen 34133837 Length: 13 3/16 (335.0) Width: 5 11/32 (135.7) Height: 1 21/32 (42.1)</p> 	<p>PA2110 Air Element with Foam Wrap Fits: GM Automotive Replaces: GMC 25041208 O.D.: 13 7/8 (352.4) I.D.: 11 5/8 (295.3) Height: 2 5/8 (66.7)</p> 
<p>PA2102 Air Element Contains: Flame Retardant Media Replaces: Impco F1-15 O.D.: 6 7/8 (174.6) I.D.: 5 1/8 (130.2) Height: 5 13/16 (147.6) Related To: PA1653 (for Compressor Air)</p> 	<p>PA2113 Air Element Fits: GMC Light-Duty Trucks Replaces: GMC 25041542 O.D.: 10 1/32 (254.8) I.D.: 8 17/32 (216.7) Height: 2 1/2 (63.5)</p> 
<p>PA2103 Panel Air Element Fits: Audi, Chrysler, Ford, Volkswagen Automotive, Light-Duty Trucks Replaces: Chrysler 4342800; Ford E59Z-9601-A; Volkswagen 49133843 Length: 10 3/4 (273.1) Width: 5 1/4 (133.4) Height: 1 19/32 (40.5)</p> 	<p>PA2114 Air Element Fits: Ford Bronco, Ranger Replaces: Ford E37E-9601-BB O.D.: 9 11/16 (246.1) I.D.: 7 15/16 (201.6) Height: 2 3/32 (53.2)</p> 
	<p>PA2115 Air Element with Foam Wrap Fits: Ford Light-Duty Trucks, Vans Replaces: Ford E3TZ-9601-C O.D.: 11 7/16 (290.5) I.D.: 8 5/8 (219.1) Height: 5 (127.0) Related To: PA2092 (without Foam Wrap)</p> 

Measurements Are Shown In Inches And (Millimeters)

WARNING: These products can expose you to chemicals, including Diisononyl Phthalate, Carbon black extracts, Nickel, 1,3 Butadiene, Ethylene Oxide, Epichlorohydrin, which are known to the State of California to cause cancer, and Bisphenol, Ethylene Glycol, Ethylene Oxide, 1,3 Butadiene, Epichlorohydrin, which are known to the State of California to cause birth defects or other reproductive harm. For more information go to www.P65Warnings.ca.gov.

<p>PA2116 Air Element Fits: International Buses, Trucks Replaces: International 588213-C1 O.D.: 11 7/16 (290.5) I.D.: 8 5/8 (219.1) Height: 7 (177.8)</p> 	<p>PA2136 Air Element Notes: Inside-Out Flow Direction Fits: GM Automotive Replaces: GMC 25043504 O.D.: 5 3/4 (146.0) I.D.: 3 5/8 (92.1) Height: 6 (152.4)</p> 
<p>PA2117 Air Element Fits: Chrysler, Mitsubishi Light-Duty Trucks Replaces: Chrysler MD604880 O.D.: 10 1/4 (260.3) I.D.: 8 (203.2) Height: 2 7/16 (61.9)</p> 	<p>PA2138 Panel Air Element Fits: GM Automotive Replaces: GMC 25043334 Length: 9 17/32 (242.1) Width: 4 1/2 (114.3) Height: 1 1/4 (31.8)</p> 
<p>PA2121 Panel Air Element Fits: Nissan, Subaru Automotive Replaces: Nissan 16546-N4200; Subaru SOA51-65101 Length: 10 5/8 (269.9) Width: 6 3/32 (154.8) Height: 1 3/8 (34.9)</p> 	<p>PA2139 Air Element Fits: Gardner Denver Compressors Use With: PA2139 FOAM Replaces: Gardner Denver 2008219 O.D.: 5 1/8 (130.2) I.D.: 3 3/8 (85.7) Height: 5 7/32 (132.6)</p> 
<p>PA2124 Air Element Fits: Chevrolet, Toyota Automotive Replaces: GMC 94840272; Toyota 17801-15010 O.D.: 11 17/32 (292.9) I.D.: 8 3/4 (222.3) Height: 1 19/32 (40.5)</p> 	<p>PA2139 FOAM Foam Blanket for PA2139 Use With: PA2139 O.D.: 5 1/2 (139.7) I.D.: 4 7/8 (123.8) Height: 5 (127.0)</p> 
<p>PA2125 Air Element Fits: Toyota Automotive, Light-Duty Trucks, Lift Trucks Replaces: Toyota 17801-25010, 17801-31010 O.D.: 9 23/32 (246.9) I.D.: 6 7/8 (174.6) Height: 2 1/4 (57.2)</p> 	
<p>PA2127 Panel Air Element Fits: Ford, Mercury Automotive Replaces: Ford E43Z-9601-C Length: 7 7/8 (200.0) Width: 7 (177.8) Height: 1 19/32 (40.5)</p> 	<p>PA2140 Air Element Fits: GM Automotive Replaces: GMC 8994941 O.D.: 5 (127.0) I.D.: 3 9/16 (90.5) Height: 5 5/16 (134.9)</p> 
<p>PA2134 Air Element Fits: GM Automotive Replaces: GMC 25043119 O.D.: 5 3/4 (146.0) I.D.: 3 1/2 (88.9) Height: 4 15/16 (125.4)</p> 	<p>PA2147 Air Element Fits: Honda Automotive Replaces: Honda 17220-PEO-661 O.D.: 10 3/8 (263.5) I.D.: 7 13/16 (198.4) Height: 1 23/32 (43.7)</p> 
<p>PA2135 Panel Air Element Fits: Isuzu, Nissan, Subaru Automotive, Trucks Replaces: Isuzu 8-94132-678-0; Nissan 16546-V0100; Subaru 16546-AA020 Length: 11 1/16 (281.0) Width: 6 9/16 (166.7) Height: 1 5/16 (33.3)</p> 	<p>PA2148 Air Element with Foam Wrap Fits: GMC Light-Duty Trucks, Vans, Trucks Replaces: GMC 25043585 O.D.: 11 13/16 (300.0) I.D.: 9 13/16 (249.2) Height: 5 7/16 (138.1) Related To: PA2091 (without Foam Wrap)</p> 











Measurements Are Shown In Inches And (Millimeters)

WARNING: These products can expose you to chemicals, including Diisononyl Phthalate, Carbon black extracts, Nickel, 1,3 Butadiene, Ethylene Oxide, Epichlorohydrin, which are known to the State of California to cause cancer, and Bisphenol, Ethylene Glycol, Ethylene Oxide, 1,3 Butadiene, Epichlorohydrin, which are known to the State of California to cause birth defects or other reproductive harm. For more information go to www.P65Warnings.ca.gov.

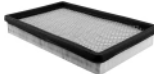
<p>PA2149 Panel Air Element Fits: Ford Automotive Replaces: Ford E6SZ-9601-B Length: 11 9/32 (286.5) Width: 8 29/32 (226.2) Height: 1 19/32 (40.5)</p> 	<p>PA2160 Panel Air Element Fits: GM Automotive, Light-Duty Trucks, Vans Replaces: GMC 25095333 Length: 7 5/8 (193.7) Width: 6 1/32 (153.2) Height: 1 17/32 (38.9)</p> 
<p>PA2150 Panel Air Element Fits: Ford, Mazda Automotive, Light-Duty Trucks Replaces: Ford E6AZ-9601-B Length: 11 7/32 (285.0) Width: 6 1/8 (155.6) Height: 1 7/32 (31.0)</p> 	<p>PA2162 Air Element Fits: GM Automotive Replaces: GMC 25096829 O.D.: 5 3/8 (136.5) I.D.: 3 13/16 (96.8) Height: 4 15/16 (125.4)</p> 
<p>PA2152 Panel Air Element Fits: Ford Automotive, Light-Duty Trucks Replaces: Ford E5TZ-9601-B Length: 11 7/32 (285.0) Width: 7 17/32 (191.3) Height: 1 25/32 (45.2)</p> 	<p>PA2163 Panel Air Element Fits: Dodge Light-Duty Trucks; Jeep Briarwood, Cherokee; Mitsubishi Automotive Replaces: AMC 8953004383; Chrysler 53004383 Length: 13 17/32 (343.7) Width: 6 21/32 (169.1) Height: 1 19/32 (40.5)</p> 
<p>PA2153 Air Element Fits: Chevrolet, Pontiac Automotive Replaces: GMC 25095707 O.D.: 5 3/4 (146.0) I.D.: 3 1/2 (88.9) Height: 3 31/32 (100.8)</p> 	<p>PA2164 Panel Air Element Fits: Ford Light-Duty Trucks, Vans Replaces: Ford E7TZ-9601-B Length: 12 27/32 (326.2) Width: 5 7/8 (149.2) Height: 1 21/32 (42.1)</p> 
<p>PA2154 Air Element Replaces: Chrysler 4306393 O.D.: 9 11/16 (246.1) I.D.: 7 1/2 (190.5) Height: 2 15/16 (74.6)</p> 	<p>PA2167 Air Element Fits: Toyota Automotive Replaces: Toyota 17801-22000-71 O.D.: 7 3/8 (187.3) I.D.: 4 5/16 (109.5) Height: 3 1/2 (88.9)</p> 
<p>PA2156 Air Element Fits: Toyota Automotive, Light-Duty Trucks Replaces: Toyota 17801-41110, 17801-54060 O.D.: 7 7/16 (188.9) I.D.: 4 9/32 (108.7) Height: 5 1/2 (139.7)</p> 	<p>PA2168 Panel Air Element Fits: Toyota Automotive, Light-Duty Trucks, Vans Replaces: Toyota 17801-70010 Length: 10 1/4 (260.3) Width: 6 3/4 (171.5) Height: 2 (50.8)</p> 
<p>PA2158 Oval Air Element Fits: Chrysler Automotive Replaces: Chrysler 4288009 O.D.: 7 9/32 (184.9) to 8 27/32 (224.6) I.D.: 5 23/32 (145.3) & 7 9/32 (184.9) Height: 2 7/32 (56.4)</p> 	<p>PA2169 Panel Air Element Fits: Daihatsu Charade; Toyota Camry, Corolla Replaces: Daihatsu 17801-87104-000; Toyota 17801-01020, 17801-74010 Length: 8 13/16 (223.8) Width: 6 5/8 (168.3) Height: 1 31/32 (50.0)</p> 
<p>SA2159 Crankcase Breather Filter Contains: [1] Metal Clip Fits: Ford Automotive, Light-Duty Trucks, Vans Replaces: Ford E5TZ-9D695-A Width: 2 3/8 (60.3) Height: 1 1/4 (31.8) F. Gskt: [1] Included</p> 	<p>PA2171 Air Element Fits: Toyota Automotive, Light-Duty Trucks Replaces: Toyota 17801-70020 O.D.: 8 19/32 (218.3) Height: 2 23/32 (69.1)</p> 

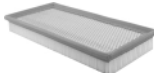
Measurements Are Shown In Inches And (Millimeters)

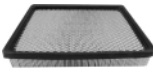
WARNING: These products can expose you to chemicals, including Diisononyl Phthalate, Carbon black extracts, Nickel, 1,3 Butadiene, Ethylene Oxide, Epichlorohydrin, which are known to the State of California to cause cancer, and Bisphenol, Ethylene Glycol, Ethylene Oxide, 1,3 Butadiene, Epichlorohydrin, which are known to the State of California to cause birth defects or other reproductive harm. For more information go to www.P65Warnings.ca.gov.

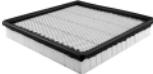
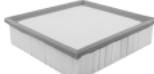
<p>PA2178 Panel Air Element Fits: GM Automotive Replaces: GMC 25042562 Length: 15 7/8 (403.2) Width: 7 27/32 (199.2) Height: 1 19/32 (40.5)</p> 	<p>PA2193 Air Element Fits: GM Automotive Replaces: GMC 25096763 O.D.: 5 (127.0) I.D.: 3 9/16 (90.5) Height: 6 13/16 (173.0)</p> 
<p>PA2181 Panel Air Element Fits: Volvo Automotive Replaces: Volvo 463505, 463505-8 Length: 13 1/16 (331.8) Width: 6 15/32 (164.3) Height: 1 15/32 (37.3)</p> 	<p>PA2194 Oval Air Element Fits: Chrysler, Eagle, Hyundai, Mitsubishi Automotive Replaces: Hyundai 28177-32520; Mitsubishi MD603932 O.D.: 7 13/16 (198.4) Flange 8 1/16 (204.8) I.D.: 5 9/32 (134.1) & 4 3/8 (111.1) Height: 6 7/8 (174.6) A. Gskt: [1] Attached</p> 
<p>PA2182 Air Element Fits: Isuzu Impulse Replaces: Isuzu 5-14215-023-0 O.D.: 6 13/32 (162.7) I.D.: 3 1/32 (77.0) Height: 4 1/8 (104.8)</p> 	<p>PA2196 Panel Air Element Fits: Buick, Oldsmobile, Pontiac, Cadillac, Chevrolet Automotive Replaces: GMC 25097453 Length: 11 1/2 (292.1) Width: 7 1/32 (178.6) Height: 1 21/32 (42.1)</p> 
<p>PA2183 Air Element Fits: Chrysler Light-Duty Trucks Replaces: Chrysler 4428325 O.D.: 7 15/16 (201.6) I.D.: 7/16 (11.1) & 4 5/8 (117.5) Height: 9 9/16 (242.9) A. Gskt: [1] Attached F. Gskt: [1] Included</p> 	<p>PA2200 Panel Air Element Fits: Ford Automotive Replaces: Ford F5RZ-9601-B Length: 12 19/32 (319.9) Width: 5 29/32 (150.0) Height: 1 5/8 (41.3)</p> 
<p>PA2188 Air Element Fits: Dodge Dakota, Ramcharger Vans Replaces: Chrysler 4307787; Wix 546152, 46152 O.D.: 13 (330.2) I.D.: 9 1/8 (231.8) Height: 2 21/32 (67.5)</p> 	<p>PA2204 Panel Air Element Fits: Honda Accord Replaces: Honda 17220-PT2-000 Length: 9 21/32 (245.3) Width: 5 7/16 (138.1) Height: 1 9/16 (39.7)</p> 
<p>PA2189 Panel Air Element Fits: Buick, Cadillac, Chevrolet, Oldsmobile, Pontiac Automotive Replaces: GMC 25096932 Length: 10 19/32 (269.1) Width: 7 7/8 (200.0) Height: 1 21/32 (42.1)</p> 	<p>PA2207 Air Element Notes: OBSOLETE. Availability Limited to Dealer Stock. Fits: Toyota Tercel Replaces: Toyota 17801-10030 O.D.: 10 3/32 (256.4) Height: 1 13/16 (46.0)</p> 
<p>PA2191 Panel Air Element Fits: Ford Thunderbird; Mercury Cougar Replaces: Ford E9SE-9601-AB Length: 9 17/32 (242.1) Width: 9 17/32 (242.1) Height: 1 9/16 (39.7)</p> 	<p>PA2208 Panel Air Element Fits: Audi, Jaguar, Porsche, Volkswagen, Volvo Automotive, Light-Duty Trucks Replaces: Audi 21129620; Porsche 29129620A; Volkswagen 39129620A; Volvo 12573051 Length: 8 3/8 (212.7) Width: 8 3/8 (212.7) Height: 2 7/32 (56.4)</p> 

Measurements Are Shown In Inches And (Millimeters)

WARNING: These products can expose you to chemicals, including Diisononyl Phthalate, Carbon black extracts, Nickel, 1,3 Butadiene, Ethylene Oxide, Epichlorohydrin, which are known to the State of California to cause cancer, and Bisphenol, Ethylene Glycol, Ethylene Oxide, 1,3 Butadiene, Epichlorohydrin, which are known to the State of California to cause birth defects or other reproductive harm. For more information go to www.P65Warnings.ca.gov.

PA2212 Panel Air Element
Fits: Mazda Light-Duty Trucks, Vans
Replaces: Mazda JF01-13-Z00
Length: 9 9/32 (235.7)
Width: 7 15/16 (201.6)
Height: 1 9/16 (39.7)



PA2214 Panel Air Element
Fits: Isuzu, Mazda, Toyota Automotive, Light-Duty Trucks, Vans
Replaces: Isuzu 8-94376-353-0; Mazda JE48-13-Z50; Toyota 17801-35020
Length: 9 27/32 (250.0)
Width: 6 11/16 (169.9)
Height: 2 (50.8)



PA2215 Air Element
Fits: Suzuki Samurai
Replaces: Suzuki 13780-83000
O.D.: 7 9/32 (184.9)
I.D.: 4 21/32 (118.3)
Height: 4 13/32 (111.9)
A. Gskt: [2] Attached



PA2216 Air Element
Fits: Chevrolet, Geo, Pontiac, Suzuki Automotive
Replaces: GMC 96055471; Suzuki 13780-860A0
O.D.: 9 5/8 (244.5)
Height: 1 5/8 (41.3)



PA2218 Panel Air Element
Fits: GM Automotive
Replaces: GMC 25097917
Length: 13 3/4 (349.3)
Width: 4 5/32 (105.6)
Height: 1 19/32 (40.5)



PA2220 Panel Air Element
Fits: Ford Escort, Mercury Tracer, Mazda Miata, MX5
Replaces: Ford F1CZ-9601-A; Mazda B6S7-13-Z40; Wix 546097, 46097
Length: 9 7/8 (250.8)
Width: 5 29/32 (150.0)
Height: 1 7/16 (36.5)

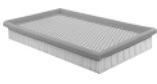

PA2221 Panel Air Element
Fits: Clark Lift Trucks
Replaces: Clark 2373789
Length: 8 1/2 (215.9)
Width: 8 1/2 (215.9)
Height: 1 5/8 (41.3)

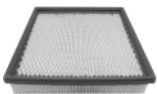

PA2222 Panel Air Element
Fits: Briggs & Stratton Engines; Cub Cadet Mowers; John Deere Lawn & Garden Tractors
Replaces: Briggs & Stratton 491588
Length: 5 5/32 (131.0)
Width: 4 7/16 (112.7)
Height: 25/32 (19.8)



PA2223 Air Element
Fits: Briggs & Stratton Engines
Use With: PA2223 FOAM
Replaces: Briggs & Stratton 393957
O.D.: 4 1/4 (108.0)
I.D.: 2 (50.8)
Height: 3 3/4 (95.3)



PA2223 FOAM Foam Blanket for PA2223
Use With: PA2223
O.D.: 4 1/32 (102.4)
I.D.: 3 17/32 (89.7)
Height: 3 23/32 (94.5)



PA2224 Air Element
Fits: Briggs & Stratton Engines
Replaces: Briggs & Stratton 390492
O.D.: 3 13/16 (96.8)
I.D.: 1 5/16 (33.3)
Height: 2 7/8 (73.0)



PA2225 Air Element
Fits: Briggs & Stratton Engines
Replaces: Briggs & Stratton 396424
O.D.: 2 3/4 (69.9)
I.D.: 3/16 (4.8) & 1 1/4 (31.8)
Height: 2 3/4 (69.9)



PA2226 Air Element
Fits: Briggs & Stratton Engines; Cub Cadet, John Deere, Simplicity, Toro Lawn & Garden Tractors
Replaces: Briggs & Stratton 394018
O.D.: 6 29/32 (175.4)
I.D.: 5 9/16 (141.3)
Height: 2 1/4 (57.2)



PA2228 Panel Air Element
Fits: Lincoln Mark VIII
Replaces: Ford F3LY-9601-A; Wix 46052
Length: 8 29/32 (226.2)
Width: 8 3/16 (208.0)
Height: 1 25/32 (45.2)

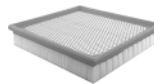



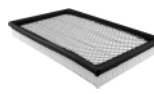





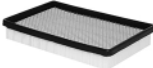

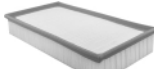

PA2230 Panel Air Element
Fits: Chrysler, Eagle Automotive
Replaces: Chrysler 4573031
Length: 12 7/16 (315.9)
Width: 7 1/32 (178.6)
Height: 1 7/16 (36.5)

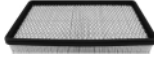





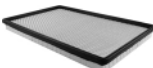





Measurements Are Shown In Inches And (Millimeters)

WARNING: These products can expose you to chemicals, including Diisononyl Phthalate, Carbon black extracts, Nickel, 1,3 Butadiene, Ethylene Oxide, Epichlorohydrin, which are known to the State of California to cause cancer, and Bisphenol, Ethylene Glycol, Ethylene Oxide, 1,3 Butadiene, Epichlorohydrin, which are known to the State of California to cause birth defects or other reproductive harm. For more information go to www.P65Warnings.ca.gov.

<p>PA2231 Panel Air Element Fits: GM, Saturn Automotive, Vans Replaces: GMC 25099149 Length: 9 5/16 (236.5) Width: 7 3/32 (180.2) Height: 1 19/32 (40.5)</p> 	<p>PA2243 Panel Air Element Fits: Chevrolet, Mazda, Toyota Automotive Replaces: Mazda KJ01-13-A40, KJ01-13-Z40; Toyota 17801-02030, 17801-15070 Length: 10 1/2 (266.7) Width: 6 23/32 (170.7) Height: 1 21/32 (42.1)</p> 
<p>PA2232 Panel Air Element with Foam Pad Fits: GMC Light-Duty Trucks, Vans Replaces: GMC 25099849 Length: 15 31/32 (405.6) Width: 7 29/32 (200.8) Height: 2 5/32 (54.8)</p> 	<p>PA2244 Panel Air Element Fits: Volvo Automotive Replaces: Volvo 9186262-3 Length: 13 13/16 (350.8) Width: 7 9/32 (184.9) Height: 2 3/16 (55.6)</p> 
<p>PA2233 Oval Air Element with Foam Wrap Fits: Ford Light-Duty Trucks Replaces: Ford F5TZ-9601-A O.D.: 6 7/32 (158.0) to 12 31/32 (329.4) I.D.: 3 5/32 (80.2) & 9 7/8 (250.8) Height: 6 1/32 (153.2)</p> 	<p>PA2256 Air Breather Element Fits: Midland Compressors Replaces: Midland 100696E O.D.: 4 (101.6) I.D.: 1 11/32 (34.1) Height: 1 3/8 (34.9)</p> 
<p>PA2234 Panel Air Element Fits: Dodge Light-Duty Trucks Replaces: Chrysler 53040025 Length: 13 3/4 (349.3) Width: 5 3/16 (131.8) Height: 2 5/16 (58.7)</p> 	<p>PA2257 Panel Air Element Fits: Chevrolet, GMC, Isuzu Automotive, Light-Duty Trucks, Vans Replaces: GMC 25098463 Length: 11 17/32 (292.9) Width: 6 1/32 (153.2) Height: 1 5/8 (41.3)</p> 
<p>PA2235 Panel Air Element Notes: OBSOLETE. Availability Limited to Dealer Stock. Fits: BMW Automotive Replaces: BMW 13721726916 Length: 13 (330.2) Width: 5 7/8 (149.2) Height: 2 3/16 (55.6)</p> 	<p>PA2258 Oval Air Element Fits: Lauson-Tecumseh Engines Replaces: Tecumseh 33268 O.D.: 2 23/32 (69.1) to 4 15/32 (113.5) I.D.: 1 15/32 (37.3) & 3 7/32 (81.8) Height: 2 5/16 (58.7)</p> 
<p>PA2237 Panel Air Element Notes: Uses 2 filters per application. Fits: Ford Vans Replaces: Ford F5UZ-9601-A Length: 11 1/4 (285.8) Width: 6 19/32 (167.5) Height: 1 21/32 (42.1)</p> 	<p>PA2260 Air Element Replaces: Vortex VF57 O.D.: 5 3/4 (146.0) I.D.: 4 7/32 (107.2) Height: 12 3/32 (307.2)</p> 
<p>PA2240 Air Element Fits: Ford, Mazda Light-Duty Trucks, Vans Replaces: Ford F57Z-9601-A; Mazda ZZM2-23-603 O.D.: 6 1/2 (165.1) Flange 6 29/32 (175.4) I.D.: 3 3/32 (78.6) One End Height: 7 15/32 (189.7)</p> 	<p>PA2300 Outer Air Element Fits: Dresser, International, John Deere Equipment Use With: PA2301 Replaces: International 624977-C91; John Deere AE30508 O.D.: 10 3/8 (263.5) Boot 11 (279.4) I.D.: 15/16 (23.8) & 6 1/32 (153.2) Height: 16 1/2 (419.1) A. Gskt: [2] Attached F. Gskt: [1] Included</p> 
<p>PA2241 Panel Air Element Fits: Chevrolet Automotive Replaces: GMC 25096933 Length: 17 5/16 (439.7) Width: 10 19/32 (269.1) Height: 1 17/32 (38.9)</p> 	













Measurements Are Shown In Inches And (Millimeters)

WARNING: These products can expose you to chemicals, including Diisononyl Phthalate, Carbon black extracts, Nickel, 1,3 Butadiene, Ethylene Oxide, Epichlorohydrin, which are known to the State of California to cause cancer, and Bisphenol, Ethylene Glycol, Ethylene Oxide, 1,3 Butadiene, Epichlorohydrin, which are known to the State of California to cause birth defects or other reproductive harm. For more information go to www.P65Warnings.ca.gov.

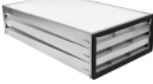
<p>PA2301 Inner Air Element Fits Inside: PA2300 Fits: Dresser, International, John Deere Equipment Replaces: International 624978-C91; John Deere AE30507 O.D.: 5 3/4 (146.0) I.D.: 15/16 (23.8) & 4 13/16 (122.2) Height: 14 5/16 (363.5) A. Gskt: [1] Attached F. Gskt: [1] Included</p> 	<p>PA2306 Inner Air Element Fits Inside: PA1609 Fits: Ford Tractors Replaces: Ford C9NN-9R500-A O.D.: 3 17/32 (89.7) I.D.: 7/16 (11.1) & 2 3/8 (60.3) Height: 14 (355.6) F. Gskt: [1] Included, [1] Wing Nut</p> 
<p>PA2302-FN Outer Air Element with Fins Fits: Dresser, International Equipment Use With: PA2303 Replaces: International 622036-C91 O.D.: 6 7/8 (174.6) Fins: 8 3/4 (222.3) I.D.: 21/32 (16.7) & 4 3/16 (106.4) Height: 14 5/16 (363.5) A. Gskt: [1] Included F. Gskt: G103-N</p> 	<p>PA2307 Outer Air Element with Lift Bar Notes: Reuse OEM boot. Fits: Ford Tractors Use With: PA2308 Replaces: Ford D0NN-9601-A O.D.: 7 (177.8) I.D.: 4 19/32 (116.7) One End Height: 14 7/16 (366.7) A. Gskt: [1] Attached</p> 
<p>PA2303 Inner Air Element Fits Inside: PA2302-FN Fits: Dresser, International Equipment Replaces: International 622041-C91 O.D.: 4 3/32 (104.0) I.D.: 3/4 (19.0) & 2 15/32 (62.7) Height: 13 7/16 (341.3) A. Gskt: [1] Attached F. Gskt: G103-N</p> 	<p>PA2308 Inner Air Element Fits Inside: PA2307, PA2433 Fits: Ford, Versatile Tractors Replaces: Ford D2NN-9R500-B; Versatile 24574 O.D.: 4 17/32 (115.1) I.D.: 7/16 (11.1) & 3 7/16 (87.3) Height: 13 9/16 (344.5) F. Gskt: [1] Included, [1] Wing Nut</p> 
<p>PA2304-FN Outer Air Element with Fins Fits: John Deere, Minneapolis-Moline, Oliver, White Equipment Use With: PA1967 Replaces: John Deere AT43867; Oliver 303002128 O.D.: 7 31/32 (202.4) Fins: 9 29/32 (251.6) I.D.: 11/16 (17.5) & 5 3/8 (136.5) Height: 12 1/2 (317.5) A. Gskt: [1] Attached F. Gskt: G103-N Related To: PA2351 (without Fins)</p> 	<p>PA2310 Inner Air Element with 8 Bolt Holes Fits Inside: LL1634, PA1634, PA1634XP Fits: Caterpillar Equipment Replaces: Caterpillar 9S9972 O.D.: 6 1/4 (158.8) Flange: 9 1/16 (230.2) I.D.: 4 5/8 (117.5) One End Height: 13 3/32 (332.6) A. Gskt: [1] Attached F. Gskt: [1] Included</p> 
<p>PA2305 Inner Air Element Fits Inside: PA1822-FN, LL2418-FN, PA2418-FN Fits: Case, Daewoo, Hough, John Deere, Komatsu Equipment Replaces: Daewoo 24749014; John Deere TH106446; Komatsu 300-181-9500 O.D.: 3 3/8 (85.7) I.D.: 11/16 (17.5) & 2 1/4 (57.2) Height: 13 1/4 (336.5) A. Gskt: [1] Attached F. Gskt: G103-N</p> 	<p>LL2312 Long Life Air Element Notes: Inside-Out Flow Direction Fits: Kenworth, Mack, Peterbilt, R.V.I. Trucks Replaces: GMC 15586905; Kenworth KW853M; Mack 2MD2147 O.D.: 10 3/8 (263.5) I.D.: 6 1/32 (153.2) One End Height: 22 13/16 (579.4) A. Gskt: [2] Attached F. Gskt: G21-AF O. Gskt: G499-AF Related To: PA2312 (Standard Media Version)</p> 

Measurements Are Shown In Inches And (Millimeters)

WARNING: These products can expose you to chemicals, including Diisononyl Phthalate, Carbon black extracts, Nickel, 1,3 Butadiene, Ethylene Oxide, Epichlorohydrin, which are known to the State of California to cause cancer, and Bisphenol, Ethylene Glycol, Ethylene Oxide, 1,3 Butadiene, Epichlorohydrin, which are known to the State of California to cause birth defects or other reproductive harm. For more information go to www.P65Warnings.ca.gov.

<p>PA2312</p> 	<p>Air Element Notes: Inside-Out Flow Direction Fits: Kenworth, Mack, Peterbilt, R.V.I. Trucks Replaces: GMC 15586905; Kenworth KW853M; Mack 2MD2147 O.D.: 10 3/8 (263.5) I.D.: 6 1/32 (153.2) One End Height: 22 13/16 (579.4) A. Gskt: [2] Attached F. Gskt: G21-AF O. Gskt: G499-AF Related To: LL2312 (Long-Life Media Version)</p>	<p>PA2317</p> 	<p>Air Element Notes: Inside-Out Flow Direction Fits: Brockway, Freightliner, GMC, Kenworth, Mack, Peterbilt Trucks Replaces: Brockway 534564; Caterpillar 7W7422; GMC 15529143; Mack 2MD2153 O.D.: 12 3/4 (323.8) I.D.: 8 11/32 (211.9) One End Height: 23 (584.2) A. Gskt: [2] Attached F. Gskt: G25-AF Related To: LL2317 (Long-Life Media Version)</p>
<p>PA2313</p> 	<p>DynaCell Panel Air Element Replaces: White 27-074049 Length: 22 3/4 (577.9) Width: 20 1/4 (514.4) Height: 3 9/32 (83.3) to 4 1/4 108.0</p>	<p>LL2318</p> 	<p>Long Life Outer Air Element Fits: International Equipment Use With: PA2319 Replaces: International 537337-R1 O.D.: 8 15/32 (215.1) Boot 9 7/16 (239.7) I.D.: 4 17/32 (115.1) One End Height: 15 1/2 (393.7) A. Gskt: [2] Attached Related To: PA2318 (Standard Media)</p>
<p>PA2314</p> 	<p>Outer Air Element with Bail Handle Fits: Elgin, Hough, International Equipment Use With: PA2332 Replaces: Elgin 7072935; International 529851-R2 O.D.: 6 3/32 (154.8) I.D.: 3 15/32 (88.1) One End Height: 15 5/16 (388.9) A. Gskt: [1] Attached Related To: PA2392 (Short Version)</p>	<p>PA2318</p> 	<p>Outer Air Element Fits: International Equipment Use With: PA2319 Replaces: International 537337-R1 O.D.: 8 15/32 (215.1) Boot 9 7/16 (239.7) I.D.: 4 17/32 (115.1) One End Height: 15 1/2 (393.7) A. Gskt: [2] Attached Related To: LL2318 (Long-Life Media)</p>
<p>PA2315</p> 	<p>DynaCell Panel Air Element Replaces: GMC 8469003 Length: 22 15/16 (582.6) Width: 14 (355.6) Height: 5 5/16 (134.9) to 6 7/32 158.0</p>	<p>PA2319</p> 	<p>Inner Air Element Fits Inside: LL2318, PA2318 Fits: International Equipment Replaces: International 537338-R2 O.D.: 4 15/32 (113.5) I.D.: 3/8 (9.5) & 3 7/16 (87.3) Height: 14 (355.6) A. Gskt: [1] Attached F. Gskt: [1] Included, [1] Wing Nut</p>
<p>PA2316</p> 	<p>Air Element Fits: Chevrolet, GMC Trucks Replaces: GMC 684743716 O.D.: 12 1/16 (306.4) I.D.: 5/8 (15.9) & 6 3/32 (154.8) Height: 14 1/4 (362.0) A. Gskt: [1] Attached F. Gskt: G103-N</p>	<p>PA2320-FN</p> 	<p>Outer Air Element with Fins Fits: Minneapolis-Moline, Oliver Tractors Use With: PA2321 Replaces: International 3115560-R91 O.D.: 6 3/32 (154.8) Fins 7 13/16 (198.4) I.D.: 3/4 (19.0) & 3 15/32 (88.1) Height: 13 1/2 (342.9) A. Gskt: [1] Attached F. Gskt: G103-N</p>
<p>LL2317</p> 	<p>Long Life Air Element Notes: Inside-Out Flow Direction Fits: Brockway, Freightliner, GMC, Kenworth, Mack, Peterbilt Trucks Replaces: Brockway 534564; Caterpillar 7W7422; GMC 15529143; Mack 2MD2153 O.D.: 12 3/4 (323.8) I.D.: 8 11/32 (211.9) One End Height: 23 (584.2) A. Gskt: [2] Attached F. Gskt: G25-AF Related To: PA2317 (Standard Media Version)</p>	<p>PA2321</p> 	<p>Inner Air Element Fits Inside: LL1681-FN, PA1681-FN, PA2320-FN Fits: Case Equipment; Oliver Tractors Replaces: Case D78336; White 30-3003477 O.D.: 3 3/8 (85.7) Flange 3 25/32 (96.0) I.D.: 21/32 (16.7) & 2 7/8 (73.0) Height: 11 1/16 (281.0) A. Gskt: [1] Attached F. Gskt: G103-N</p>

Measurements Are Shown In Inches And (Millimeters)

WARNING: These products can expose you to chemicals, including Diisononyl Phthalate, Carbon black extracts, Nickel, 1,3 Butadiene, Ethylene Oxide, Epichlorohydrin, which are known to the State of California to cause cancer, and Bisphenol, Ethylene Glycol, Ethylene Oxide, 1,3 Butadiene, Epichlorohydrin, which are known to the State of California to cause birth defects or other reproductive harm. For more information go to www.P65Warnings.ca.gov.

PA2322



Outer Air Element with Lift Bar
Fits: Massey Ferguson Wheel Tractors
Use With: PA2323
Replaces: Massey Ferguson 1039044-M91
O.D.: 5 5/16 (134.9)
I.D.: 3 13/32 (86.5) One End
Height: 14 3/16 (360.4)
A. Gskt: [1] Attached

PA2328



Air Element
Replaces: White 31-15782
O.D.: 11 1/16 (281.0)
 Flange 11 11/16 (296.9)
I.D.: 7 25/32 (197.6)
Height: 7 (177.8)

PA2323



Inner Air Element
Fits Inside: PA2322, PA2486
Fits: Massey Ferguson Wheel Tractors
Replaces: Massey Ferguson 1039045-M91
O.D.: 3 5/16 (84.1)
I.D.: 5/8 (15.9) & 2 1/4 (57.2)
Height: 13 21/32 (346.9)

PA2329

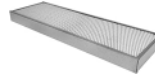

Cab Air Element
Fits: Massey Ferguson Equipment
Replaces: Massey Ferguson 525446-M1
Length: 29 (736.6)
Width: 9 1/4 (235.0)
Height: 2 3/16 (55.6)

LL2326



Long Life Air Element
Fits: Peterbilt Trucks
Replaces: White 27-088627; Donaldson EAF5057
O.D.: 12 3/4 (323.8)
 Boot Gasket 13 3/8 (339.7)
I.D.: 15/16 (23.8) & 8 3/8 (212.7)
Height: 17 1/2 (444.5)
A. Gskt: [2] Attached
F. Gskt: [1] Included
Related To: PA2326 (Standard Media Version)
 PA2326XP (Extreme Performance Nano Version)

LL2330



Long Life Outer Air Element
Fits: International Trucks
Use With: PA2579
Replaces: International 424700-C92
O.D.: 12 1/32 (305.6)
I.D.: 5/8 (15.9) & 7 11/16 (195.3)
Height: 15 5/16 (388.9)
A. Gskt: [1] Attached
F. Gskt: G103-N
Related To: PA2330 (Standard Media Version)

PA2326



Air Element
Fits: Peterbilt Trucks
Replaces: White 27-088627; Donaldson EAF5057
O.D.: 12 3/4 (323.8)
 Boot Gasket 13 3/8 (339.7)
I.D.: 15/16 (23.8) & 8 3/8 (212.7)
Height: 17 1/2 (444.5)
A. Gskt: [2] Attached
F. Gskt: [1] Included
Related To: LL2326 (Long-Life Media Version)
 PA2326XP (Extreme Performance Nano Version)

PA2330



Outer Air Element
Fits: International Trucks
Use With: PA2579
Replaces: International 424700-C92
O.D.: 12 1/32 (305.6)
I.D.: 5/8 (15.9) & 7 11/16 (195.3)
Height: 15 5/16 (388.9)
A. Gskt: [1] Attached
F. Gskt: G103-N
Related To: LL2330 (Long-Life Media Version)

PA2326XP



Extreme Performance Nano Air Element
Fits: Peterbilt Trucks
Replaces: White 27-088627; Donaldson EAF5057
O.D.: 12 3/4 (323.8)
 Boot Gasket 13 3/8 (339.7)
I.D.: 15/16 (23.8) & 8 3/8 (212.7)
Height: 17 1/2 (444.5)
A. Gskt: [2] Attached
F. Gskt: [1] Included
Related To: LL2326 (Long-Life Media Version)
 PA2326 (Standard Media Version)

PA2331



Outer Air Element with Lift Tab
Contains: Flame Retardant Media
Fits: Ford Equipment
Use With: PA1809
Replaces: Ford D0NN-9B618-A
O.D.: 4 1/2 (114.3)
 Boot 4 7/8 (123.8)
I.D.: 2 1/4 (57.2) One End
Height: 10 3/4 (273.1)
A. Gskt: [2] Attached











PA2332

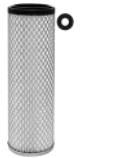

Inner Air Element
Fits Inside: PA2314, LL2418-FN, PA2418-FN, PA2524-FN, PA2541-FN, PA2551
Fits: Bobcat, Case, Dresser, Hough, International, Massey Ferguson, Melroe, New Holland Equipment; Spra-Coupe Sprayers
Replaces: Case P250566; International 406130-R91; Massey Ferguson 1037735-M91; Melroe 6598898; New Holland 377059
O.D.: 3 3/8 (85.7)
 Flange 3 25/32 (96.0)
I.D.: 21/32 (16.7) & 2 7/8 (73.0)
Height: 14 1/16 (357.2)
A. Gskt: [1] Attached
F. Gskt: G103-N

Measurements Are Shown In Inches And (Millimeters)

WARNING: These products can expose you to chemicals, including Diisononyl Phthalate, Carbon black extracts, Nickel, 1,3 Butadiene, Ethylene Oxide, Epichlorohydrin, which are known to the State of California to cause cancer, and Bisphenol, Ethylene Glycol, Ethylene Oxide, 1,3 Butadiene, Epichlorohydrin, which are known to the State of California to cause birth defects or other reproductive harm. For more information go to www.P65Warnings.ca.gov.

<p>LL2333 Long Life Air Element with Lid and 6 Bolt Holes Fits: Peterbilt Trucks Replaces: Donaldson P182006, P182099; Fleetguard AF872M, AF4871M O.D.: 13 13/16 (350.8) Lid 16 5/32 (410.4) I.D.: 7 7/16 (188.9) One End Height: 18 9/16 (471.5) A. Gskt: [2] Attached Related To: PA2333 (Standard Media Version)</p> 	<p>PA2340 Inner Air Element Fits Inside: PA2339 Fits: Case Equipment Replaces: Case A43735 O.D.: 6 7/8 (174.6) I.D.: 5/8 (15.9) & 5 9/16 (141.3) Height: 6 1/16 (154.0) A. Gskt: [1] Attached F. Gskt: [1] Included</p> 
<p>PA2333 Air Element with Lid and 6 Bolt Holes Fits: Freightliner, GMC, International Trucks Replaces: GMC 25096450; International 1685307-C1; White 22-0010240 O.D.: 13 13/16 (350.8) Lid 16 5/32 (410.4) I.D.: 9 1/2 (241.3) One End Height: 18 9/16 (471.5) A. Gskt: [2] Attached Related To: LL2333 (Long-Life Media Version)</p> 	<p>PA2341 Outer Air Element Fits: Massey Ferguson Wheel Tractors Use With: PA2342 Replaces: Massey Ferguson 1038946-M91 O.D.: 6 7/8 (174.6) Boot 7 7/16 (188.9) I.D.: 4 3/16 (106.4) One End Height: 14 5/8 (371.5) A. Gskt: [2] Attached</p> 
<p>PA2335 Air Element Replaces: United 250B18, 250B18-S O.D.: 4 13/32 (111.9) I.D.: 2 15/16 (74.6) Height: 4 3/4 (120.7)</p> 	<p>PA2342 Inner Air Element Fits Inside: PA2341 Fits: Massey Ferguson Wheel Tractors Replaces: Massey Ferguson 1038947-M91 O.D.: 4 3/32 (104.0) I.D.: 5/8 (15.9) & 3 1/8 (79.4) Height: 12 15/16 (328.6) F. Gskt: G40-AF</p> 
<p>PA2337 Air Element Fits: Atlas Copco Compressors Replaces: Atlas Copco 1030-1070 O.D.: 11 7/8 (301.6) I.D.: 7 1/2 (190.5) Height: 4 11/32 (110.3)</p> 	<p>PA2343 Outer Air Element Fits: Case, John Deere, Oliver, White Equipment Use With: PA1996 Replaces: John Deere AR64624; White 30-3089258 O.D.: 13 7/8 (352.4) I.D.: 5/8 (15.9) & 7 7/16 (188.9) Height: 6 29/32 (175.4) A. Gskt: [1] Attached F. Gskt: G103-N</p> 
<p>PA2338-FN Outer Air Element with Fins Fits: International Wheel Tractors Use With: PA1836 Replaces: International 537336-R1 O.D.: 7 15/16 (201.6) Fins 10 (254.0) I.D.: 5 3/8 (136.5) One End Height: 15 1/2 (393.7) A. Gskt: [1] Attached</p> 	<p>LL2344-FN Long Life Outer Air Element with Fins Fits: Case, Ford, Gehl, John Deere, New Holland, Thomas Equipment; Ingersoll-Rand Compressors Use With: PA2602 Replaces: Case R39392; Gehl 263638; John Deere MG221406; New Holland 221406 O.D.: 4 3/32 (104.0) Fins 5 1/8 (130.2) I.D.: 25/32 (19.8) & 2 15/32 (62.7) Height: 14 5/16 (363.5) A. Gskt: [1] Attached F. Gskt: G103-N Related To: PA2344-FN (Standard Media Version)</p> 
<p>PA2339 Outer Air Element with Lift Tabs Fits: Case Equipment Use With: PA2340 Replaces: Case A43734 O.D.: 11 5/8 (295.3) Boot 12 3/8 (314.3) I.D.: 7/16 (11.1) & 7 3/16 (182.6) Height: 7 5/16 (185.7) A. Gskt: [2] Attached F. Gskt: [1] Included</p> 	

Measurements Are Shown In Inches And (Millimeters)

WARNING: These products can expose you to chemicals, including Diisononyl Phthalate, Carbon black extracts, Nickel, 1,3 Butadiene, Ethylene Oxide, Epichlorohydrin, which are known to the State of California to cause cancer, and Bisphenol, Ethylene Glycol, Ethylene Oxide, 1,3 Butadiene, Epichlorohydrin, which are known to the State of California to cause birth defects or other reproductive harm. For more information go to www.P65Warnings.ca.gov.

PA2344-FN



Outer Air Element with Fins
Fits: Case, Ford, Gehl, John Deere, New Holland, Thomas Equipment; Ingersoll-Rand Compressors
Use With: PA2602
Replaces: Case R39392; Gehl 263638; John Deere MG221406; New Holland 221406
O.D.: 4 3/32 (104.0)
Fins: 5 1/8 (130.2)
I.D.: 25/32 (19.8) & 2 15/32 (62.7)
Height: 14 5/16 (363.5)
A. Gskt: [1] Attached
F. Gskt: G103-N
Related To: LL2344-FN (Long-Life Media Version)

PA2345



Outer Air Element with Bail Handle
Fits: Case, International, John Deere, New Holland Equipment
Use With: PA2346, PA2388
Replaces: International 640968-C91; John Deere AT49022; New Holland 614103
O.D.: 11 1/8 (282.6)
I.D.: 5/8 (15.9) & 6 3/4 (171.5)
Height: 20 1/2 (520.7)
A. Gskt: [1] Attached
F. Gskt: G103-N

PA2346



Inner Air Element
Fits Inside: PA2345
Fits: Case, International, New Holland Equipment
Replaces: International 923611-C91; New Holland 614104
O.D.: 6 3/8 (161.9)
Flange: 7 1/2 (190.5)
I.D.: 5/8 (15.9) & 5 1/4 (133.4)
Height: 20 (508.0)
A. Gskt: [1] Attached
F. Gskt: G103-N

PA2347



Air Element
Fits: Onan Engines
Replaces: Onan 140-B1071
O.D.: 4 5/8 (117.5)
Flange Gasket: 5 3/16 (131.8)
I.D.: 1 1/2 (38.1) One End
Height: 2 19/32 (65.9)
A. Gskt: [1] Attached

PA2349-FN



Air Element with Fins and Lift Tabs
Replaces: White 27-011685
O.D.: 13 7/8 (352.4)
Fins: 15 25/32 (400.8)
I.D.: 5/8 (15.9) & 7 7/16 (188.9)
Height: 10 3/8 (263.5)
A. Gskt: [1] Attached
F. Gskt: G103-N

PA2350

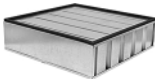

DynaCell Panel Air Element
Notes: Back is closed.
Fits: Ford, GMC Trucks; Cummins Engines
Replaces: Ford D8HZ-9601-C; GMC 6488476
Length: 19 (482.6)
Width: 19 (482.6)
Height: 5 3/8 (136.5)
Related To: PA2375 (Front and Back are Open)

PA2351



Outer Air Element
Fits: Dresser, International, John Deere Equipment
Use With: PA1967
Replaces: International 634269-C1; John Deere AT35155
O.D.: 7 31/32 (202.4)
I.D.: 11/16 (17.5) & 5 3/8 (136.5)
Height: 12 3/8 (314.3)
A. Gskt: [1] Attached
F. Gskt: G103-N
Related To: PA2304-FN (with Fins)

PA2352



Cab Air Element
Fits: John Deere Equipment
Replaces: John Deere AR49986
Length: 28 (711.2)
Width: 7 1/2 (190.5)
Height: 2 9/16 (65.1)
A. Gskt: [1] Attached
Related To: PA2353 (Thin Version)

PA2353



Cab Air Element
Fits: Allis Chalmers, Case, Ford, John Deere, Melroe, New Holland, Versatile Equipment; Spra-Coupe Sprayers
Replaces: Allis Chalmers 134692; Case F84818; Ford D2NN-19N-551A; John Deere AN112705; New Holland 70569300
Length: 28 (711.2)
Width: 7 1/2 (190.5)
Height: 2 3/16 (55.6)
Related To: PA2352 (Thick Version)

PA2354



Cab Air Element
Fits: Bell Equipment; Insley Shovels; Komatsu Dump Trucks
Replaces: Hinson 3000020
Length: 20 (508.0)
Width: 7 1/2 (190.5)
Height: 2 3/16 (55.6)
Related To: PA5315 (with Attached Gasket)

PA2356



Cab Air Element
Fits: Case, Caterpillar, Versatile Equipment
Replaces: Case T39515; Caterpillar 8S468; Versatile 15942
Length: 23 1/2 (596.9)
Width: 7 (177.8)
Height: 2 3/16 (55.6)

PA2357



Air Element
Notes: Inside-Out Flow Direction
Fits: Caterpillar, Cummins Engines; Kenworth Trucks
Replaces: Caterpillar 7W7421; GMC 8994222; Kenworth 21401091
O.D.: 12 3/4 (323.8)
I.D.: 8 3/8 (212.7) One End
Height: 27 (685.8)
A. Gskt: [2] Attached
F. Gskt: G25-AF
Related To: LL2317, PA2317 (Short Versions) PA2608 (with Bolt Hole)

Measurements Are Shown In Inches And (Millimeters)

WARNING: These products can expose you to chemicals, including Diisononyl Phthalate, Carbon black extracts, Nickel, 1,3 Butadiene, Ethylene Oxide, Epichlorohydrin, which are known to the State of California to cause cancer, and Bisphenol, Ethylene Glycol, Ethylene Oxide, 1,3 Butadiene, Epichlorohydrin, which are known to the State of California to cause birth defects or other reproductive harm. For more information go to www.P65Warnings.ca.gov.

LL2358



Long Life Outer Air Element
Fits: Caterpillar, DJB, Hough, Iveco Equipment
Use With: PA2359, PA2738
Replaces: Caterpillar 8N5495, 7W5495
O.D.: 11 1/2 (292.1)
I.D.: 8 1/16 (204.8) One End
Height: 13 1/2 (342.9)
A. Gskt: [1] Attached
Related To: PA2358 (Standard Media Version)

PA2358



Outer Air Element
Fits: Caterpillar, DJB, Hough, Iveco Equipment
Use With: PA2359, PA2738
Replaces: Caterpillar 8N5495, 7W5495
O.D.: 11 1/2 (292.1)
I.D.: 8 1/16 (204.8) One End
Height: 13 1/2 (342.9)
A. Gskt: [1] Attached
Related To: LL2358 (Long-Life Media Version)

PA2359



Inner Air Element with 8 Bolt Holes
Fits Inside: LL2358, PA2358
Fits: Caterpillar, DJB, Hough Equipment
Replaces: Caterpillar 1P7360
O.D.: 7 5/8 (193.7)
 Flange 10 1/4 (260.3)
I.D.: 6 (152.4) One End
Height: 13 1/2 (342.9)
A. Gskt: [1] Attached

LL2360-FN



Long Life Outer Air Element with Fins
Fits: Bobcat, Case, Ditch Witch, Gehl, Grove, J.C. Bamford, Mustang, New Holland, Vermeer, Vibromax Equipment; Ingersoll-Rand Compressors
Use With: PA2487
Replaces: Case A173290; Ditch Witch 195690; Grove 9304100077; Ingersoll-Rand 35291970; New Holland 266221
O.D.: 5 1/4 (133.4)
 Fins 6 3/8 (161.9)
I.D.: 21/32 (16.7) & 3 1/4 (82.6)
Height: 15 3/8 (390.5)
A. Gskt: [1] Attached
F. Gskt: G103-N
Related To: PA2360-FN (Standard Media Version)

PA2360-FN



Outer Air Element with Fins
Fits: Bobcat, Case, Ditch Witch, Gehl, Grove, J.C. Bamford, Mustang, New Holland, Vermeer, Vibromax Equipment; Ingersoll-Rand Compressors
Use With: PA2487
Replaces: Case A173290; Ditch Witch 195690; Grove 9304100077; Ingersoll-Rand 35291970; New Holland 266221
O.D.: 5 1/4 (133.4)
 Fins 6 3/8 (161.9)
I.D.: 21/32 (16.7) & 3 1/4 (82.6)
Height: 15 3/8 (390.5)
A. Gskt: [1] Attached
F. Gskt: G103-N
Related To: LL2360-FN (Long-Life Media Version)

LL2361



Long Life Outer Air Element
Fits: Allis Chalmers, Fiat-Allis, New Holland, Samsung Equipment
Use With: PA2362
Replaces: Allis Chalmers 70671838; Fiat 70671809; New Holland 703409
O.D.: 12 1/32 (305.6)
 Boot 12 3/4 (323.8)
I.D.: 15/16 (23.8) & 7 23/32 (196.1)
Height: 23 1/2 (596.9)
A. Gskt: [2] Attached
F. Gskt: [1] Metal Washer
Related To: PA2361 (Standard Media Version)
 PA2361XP (Extreme Performance Nano Version)

PA2361



Outer Air Element
Fits: Allis Chalmers, Fiat-Allis, New Holland, Samsung Equipment
Use With: PA2362
Replaces: Allis Chalmers 70671838; Fiat 70671809; New Holland 703409
O.D.: 12 1/32 (305.6)
 Boot Gasket 12 3/4 (323.9)
I.D.: 15/16 (23.8) & 7 23/32 (196.1)
Height: 23 1/2 (596.9)
A. Gskt: [2] Attached
F. Gskt: [1] Metal Washer
Related To: LL2361 (Long-Life Media Version)
 PA2361XP (Extreme Performance Nano Version)

PA2361XP





Extreme Performance Nano Outer Air Element
Fits: Allis Chalmers, Fiat-Allis, New Holland, Samsung Equipment
Use With: PA2362
Replaces: Allis Chalmers 70671838; Fiat 70671809; New Holland 703409
O.D.: 12 1/32 (305.6)
 Boot 12 3/4 (323.8)
I.D.: 15/16 (23.8) & 7 23/32 (196.1)
Height: 23 1/2 (596.9)
A. Gskt: [2] Attached
F. Gskt: [1] Metal Washer
Related To: LL2361 (Long-Life Media Version)
 PA2361 (Standard Media Version)

Measurements Are Shown In Inches And (Millimeters)

WARNING: These products can expose you to chemicals, including Diisononyl Phthalate, Carbon black extracts, Nickel, 1,3 Butadiene, Ethylene Oxide, Epichlorohydrin, which are known to the State of California to cause cancer, and Bisphenol, Ethylene Glycol, Ethylene Oxide, 1,3 Butadiene, Epichlorohydrin, which are known to the State of California to cause birth defects or other reproductive harm. For more information go to www.P65Warnings.ca.gov.

PA2362 Inner Air Element

Fits Inside: LL2361, PA2361
Fits: Allis Chalmers, Fiat-Allis, New Holland, Samsung Equipment
Replaces: Allis Chalmers 70671839; Fiat 70671809; New Holland 703408
O.D.: 7 5/8 (193.7)
I.D.: 7/8 (22.2) & 6 1/16 (154.0)
Height: 21 15/32 (545.3)
A. Gskt: [1] Attached
F. Gskt: [1] Included

PA2364 Inner Air Element

Fits Inside: LL2363, PA2363, PA2363XP, LL2453, PA2453, PA2453XP
Fits: Caterpillar, Euclid, Hitachi, KW-Dart, Terex, Unit Rig, WABCO Equipment
Replaces: Caterpillar 9Y7663; KW-Dart 3040562; Terex 6945658; WABCO VS122185
O.D.: 10 29/32 (277.0)
I.D.: 29/32 (23.0) & 8 5/32 (207.2)
Height: 22 3/16 (563.6)
A. Gskt: [1] Attached
F. Gskt: [1] Included

LL2363 Long Life Outer Air Element with Bail Handle

Fits: Caterpillar, Euclid, Hitachi, KW-Dart, Terex, Unit Rig, WABCO Equipment
Use With: PA2364
Replaces: Caterpillar 9Y6835; KW-Dart 3040562; Terex 6945659; WABCO VA2186
O.D.: 17 5/8 (447.7)
Boot 18 5/16 (465.1)
I.D.: 15/16 (23.8) & 11 (279.4)
Height: 23 17/32 (597.7)
A. Gskt: [2] Attached
F. Gskt: [1] Included
Related To: PA2363 (Standard Media Version)
 PA2363XP (Extreme Performance Nano Version)

PA2367 Outer Air Element

Fits: Galion, John Deere, Komatsu, New Holland Equipment; Onan Generators
Use With: PA2368
Replaces: John Deere AR57024; New Holland 279627; Onan 140-1969
O.D.: 9 3/32 (231.0)
I.D.: 1/2 (12.7) & 4 13/16 (122.2)
Height: 19 7/8 (504.8)
A. Gskt: [1] Attached
F. Gskt: [1] Included

PA2363 Outer Air Element with Bail Handle

Fits: Caterpillar, Euclid, Hitachi, KW-Dart, Terex, Unit Rig, WABCO Equipment
Use With: PA2364
Replaces: Caterpillar 9Y6835; KW-Dart 3040562; Terex 6945659; WABCO VA2186
O.D.: 17 5/8 (447.7)
Boot 18 5/16 (465.1)
I.D.: 15/16 (23.8) & 11 (279.4)
Height: 23 17/32 (597.7)
A. Gskt: [2] Attached
F. Gskt: [1] Included
Related To: LL2363 (Long-Life Media Version)
 PA2363XP (Extreme Performance Nano Version)

PA2368 Inner Air Element

Fits Inside: PA2367
Fits: Galion, John Deere, Komatsu, New Holland Equipment
Replaces: John Deere AR57025
O.D.: 4 21/32 (118.3)
I.D.: 5/8 (15.9) & 3 15/16 (100.0)
Height: 16 7/16 (417.5)
A. Gskt: [1] Attached
F. Gskt: G103-N

PA2363XP Extreme Performance Nano Outer Air Element with Lift Bar

Fits: Caterpillar, Euclid, Hitachi, KW-Dart, Terex, Unit Rig, WABCO Equipment
Use With: PA2364
Replaces: Caterpillar 9Y6835; KW-Dart 3040562; Terex 6945659; WABCO VA2186
O.D.: 17 5/8 (447.7)
Boot 18 5/16 (465.1)
I.D.: 15/16 (23.8) & 11 (279.4)
Height: 23 17/32 (597.7)
A. Gskt: [2] Attached
F. Gskt: [1] Included
Related To: LL2363 (Long-Life Media Version)
 PA2363 (Standard Media Version)











PA2369 Outer Air Element

Fits: Allis Chalmers, John Deere Equipment
Use With: PA2370
Replaces: Allis Chalmers 70263435; John Deere AR54336
O.D.: 7 11/32 (186.5)
I.D.: 7/16 (11.1) & 3 31/32 (100.8)
Height: 15 5/32 (385.0)
A. Gskt: [1] Attached
F. Gskt: [1] Included

PA2370 Inner Air Element

Fits Inside: PA2369
Fits: Allis Chalmers, John Deere Equipment
Replaces: Allis Chalmers 263434; John Deere AR54337
O.D.: 3 7/8 (98.4)
I.D.: 5/8 (15.9) & 3 3/16 (81.0)
Height: 13 3/16 (335.0)
A. Gskt: [1] Attached
F. Gskt: G103-N

PA2371 Outer Air Element

Fits: Case, Dresser, International Equipment
Use With: PA2372
Replaces: Case A47145
O.D.: 10 3/8 (263.5)
I.D.: 15/16 (23.8) & 6 1/32 (153.2)
Height: 12 1/2 (317.5)
A. Gskt: [1] Attached
F. Gskt: [2] Included

Measurements Are Shown In Inches And (Millimeters)

WARNING: These products can expose you to chemicals, including Diisononyl Phthalate, Carbon black extracts, Nickel, 1,3 Butadiene, Ethylene Oxide, Epichlorohydrin, which are known to the State of California to cause cancer, and Bisphenol, Ethylene Glycol, Ethylene Oxide, 1,3 Butadiene, Epichlorohydrin, which are known to the State of California to cause birth defects or other reproductive harm. For more information go to www.P65Warnings.ca.gov.

<p>PA2372</p>  <p>Inner Air Element Fits Inside: PA2371 Fits: Case, Dresser, International Equipment Replaces: Case A47146 O.D.: 5 31/32 (151.6) I.D.: 5/8 (15.9) & 4 27/32 (123.0) Height: 10 3/8 (263.5) A. Gskt: [1] Attached F. Gskt: G103-N</p>	<p>PA2378</p>  <p>Inner Air Element Fits Inside: PA2377 Fits: Hough, International Equipment Replaces: International 925762-C1 O.D.: 5 1/4 (133.4) I.D.: 5/8 (15.9) & 4 1/8 (104.8) Height: 19 7/16 (493.7) A. Gskt: [1] Attached F. Gskt: G103-N</p>
<p>PA2374</p>  <p>Air Element Fits: Gardner Denver Compressors Replaces: Gardner Denver 2010253 O.D.: 9 5/8 (244.5) I.D.: 3/8 (9.5) & 4 3/32 (104.0) Height: 15 1/16 (382.6) A. Gskt: [1] Attached F. Gskt: [1] Included</p>	<p>PA2379</p>  <p>Air Element Fits: Ford Trucks Replaces: Ford B4HF-9601-DA O.D.: 10 (254.0) Lid 12 (304.8) I.D.: 3/8 (9.5) & 4 15/16 (125.4) Height: 9 7/16 (239.7) A. Gskt: [2] Attached F. Gskt: G39-AF Related To: PA2379-K (with Reusable Lid Assembly)</p>
<p>PA2375</p>  <p>DynaCell Panel Air Element Notes: Open on both ends. Fits: Ford Trucks; Ingersoll-Rand Compressors Replaces: Ford D8HZ-9601-E; Ingersoll-Rand 35258177 Length: 19 (482.6) Width: 19 (482.6) Height: 5 3/8 (136.5) Related To: PA2350 (Back is Closed)</p>	<p>PA2379-K</p>  <p>Air Element with Reusable Lid Assembly Fits: Ford Trucks Replaces: Ford B4HF-9601-DA O.D.: 10 (254.0) Lid 12 (304.8) I.D.: 3/8 (9.5) & 4 15/16 (125.4) Height: 9 7/16 (239.7) A. Gskt: [2] Attached F. Gskt: G39-AF Related To: PA2379 (Filter only)</p>
<p>PA2376</p>  <p>Air Element Fits: International Engines Replaces: International 439723-C91 O.D.: 12 1/32 (305.6) I.D.: 5/8 (15.9) & 7 11/16 (195.3) Height: 19 31/32 (507.2) A. Gskt: [1] Attached F. Gskt: G103-N</p>	<p>PA2380-FN</p>  <p>Outer Air Element with Fins Fits: Allis Chalmers, Atlas-Weyhausen, Fiat-Allis, Hough, International, J.C. Bamford, John Deere, Massey Ferguson Equipment Use With: PA2381 Replaces: Allis Chalmers 1909128; Fiat 72099164; International 924779-C1; J.C. Bamford 32/203702; John Deere AE31723 O.D.: 5 1/4 (133.4) Fins 6 3/8 (161.9) I.D.: 21/32 (16.7) & 3 1/4 (82.6) Height: 12 15/32 (316.7) A. Gskt: [1] Attached F. Gskt: G103-N</p>
<p>PA2377</p>  <p>Outer Air Element Fits: Hough, International Equipment Use With: PA2378 Replaces: International 925761-C1 O.D.: 10 (254.0) I.D.: 3/8 (9.5) & 5 1/2 (139.7) Height: 20 7/8 (530.2) A. Gskt: [1] Attached F. Gskt: [1] Included</p>	<p>PA2381</p>  <p>Inner Air Element Fits Inside: PA2380-FN, PA2392, PA3778 Fits: Allis Chalmers, Fiat-Allis, Hough, International, J.C. Bamford, John Deere, Massey Ferguson Equipment Replaces: Allis Chalmers 1909129; Fiat 79022026; International 537335-R3; J.C. Bamford 32/203703; John Deere AE31724 O.D.: 2 31/32 (75.4) Flange 3 21/32 (92.9) I.D.: 5/8 (15.9) & 2 7/16 (61.9) Height: 11 1/8 (282.6) A. Gskt: [1] Attached F. Gskt: G39-AF</p>

Measurements Are Shown In Inches And (Millimeters)

WARNING: These products can expose you to chemicals, including Diisononyl Phthalate, Carbon black extracts, Nickel, 1,3 Butadiene, Ethylene Oxide, Epichlorohydrin, which are known to the State of California to cause cancer, and Bisphenol, Ethylene Glycol, Ethylene Oxide, 1,3 Butadiene, Epichlorohydrin, which are known to the State of California to cause birth defects or other reproductive harm. For more information go to www.P65Warnings.ca.gov.

PA2382 Air Element
Replaces: Blue Bird 3022107241
O.D.: 10 3/8 (263.5)
I.D.: 6 1/32 (153.2) One End
Height: 17 13/16 (452.4)
A. Gskt: [2] Attached
F. Gskt: G21-AF



PA2386 Outer Air Element with Lift Tab
Fits: New Holland, Versatile Tractors
Use With: PA2388
Replaces: New Holland V22930; Versatile 22930
O.D.: 10 17/32 (267.5)
 Boot 12 (304.8)
I.D.: 6 7/8 (174.6) One End
Height: 20 3/8 (517.5)
A. Gskt: [2] Attached



PA2383 Air Element
Fits: International Wheel Tractors
Replaces: International 529957-R1
O.D.: 5 7/16 (138.1)
 Boot 6 3/8 (161.9)
I.D.: 2 27/32 (72.2) One End
Height: 10 7/8 (276.2)
A. Gskt: [2] Attached



PA2387 Outer Air Element with Lift Tabs
Fits: Versatile Tractors
Use With: PA2388
Replaces: Versatile 15803
O.D.: 9 5/8 (244.5)
 Flange 11 1/2 (292.1)
I.D.: 6 3/16 (157.2) One End
Height: 20 7/16 (519.1)
A. Gskt: [2] Attached



LL2384 Long Life Outer Air Element
Fits: Caterpillar Equipment, Industrial Engines
Use With: PA2385, PA2625, PA2647, PA2735
Replaces: Caterpillar 1P8483, 8N5313
O.D.: 12 1/2 (317.5)
I.D.: 9 1/8 (231.8) One End
Height: 15 1/2 (393.7)
A. Gskt: [1] Attached
Related To: PA2384 (Standard Media Version)
 PA2384XP (Extreme Performance Nano Version)



PA2388 Inner Air Element
Fits Inside: PA2345, PA2386, PA2387
Fits: John Deere Equipment; New Holland, Versatile Tractors
Replaces: John Deere AT49021
O.D.: 6 1/8 (155.6)
I.D.: 1/2 (12.7) & 4 15/16 (125.4)
Height: 18 5/16 (465.1)
A. Gskt: [1] Attached
F. Gskt: G20-AF, [1] Wing Nut



PA2384 Outer Air Element
Fits: Caterpillar Equipment, Industrial Engines
Use With: PA2385, PA2625, PA2647, PA2735
Replaces: Caterpillar 1P8483, 8N5313
O.D.: 12 1/2 (317.5)
I.D.: 9 1/8 (231.8) One End
Height: 15 1/2 (393.7)
A. Gskt: [1] Attached
Related To: LL2384 (Long-Life Media Version)
 PA2384XP (Extreme Performance Nano Version)



PA2389-FN Air Element with Fins and Lift Tabs
Replaces: White 27-077288
O.D.: 13 7/8 (352.4)
 Fins 15 3/4 (400.0)
I.D.: 5/8 (15.9) & 7 7/16 (188.9)
Height: 12 1/2 (317.5)
A. Gskt: [1] Attached
F. Gskt: G103-N



PA2384XP Extreme Performance Nano Outer Air Element
Fits: Caterpillar Equipment, Industrial Engines
Use With: PA2385, PA2625, PA2647, PA2735
Replaces: Caterpillar 1P8483, 8N5313
O.D.: 12 1/2 (317.5)
I.D.: 9 1/8 (231.8) One End
Height: 15 1/2 (393.7)
A. Gskt: [1] Attached
Related To: LL2384 (Long-Life Media Version)
 PA2384 (Standard Media Version)



PA2390 Set of 2 DynaCell Panel Air Elements
Notes: Uses 2 filters per application.
Fits: Industrial Applications
Replaces: Farr C29360-2, R300
Each Filter:
Length: 45 3/8 (1152.5)
Width: 14 (355.6)
Height: 6 3/16 (157.2)

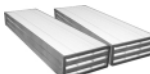

PA2385 Inner Air Element with 10 Bolt Holes
Fits Inside: LL2384, PA2384, PA2384XP, LL2609, PA2609
Fits: Caterpillar Equipment, Industrial Engines
Replaces: Caterpillar 1P8482, 7N1308
O.D.: 8 5/8 (219.1)
 Flange 11 3/8 (288.9)
I.D.: 6 31/32 (177.0) One End
Height: 15 1/4 (387.3)
A. Gskt: [1] Attached















PA2391 Outer Air Element
Fits: International Wheel Tractors
Use With: PA2489, PA2700
Replaces: International 529854-R2
O.D.: 5 7/16 (138.1)
 Boot 6 3/8 (161.9)
I.D.: 2 27/32 (72.2) One End
Height: 11 7/8 (301.6)
A. Gskt: [2] Attached















Measurements Are Shown In Inches And (Millimeters)

WARNING: These products can expose you to chemicals, including Diisononyl Phthalate, Carbon black extracts, Nickel, 1,3 Butadiene, Ethylene Oxide, Epichlorohydrin, which are known to the State of California to cause cancer, and Bisphenol, Ethylene Glycol, Ethylene Oxide, 1,3 Butadiene, Epichlorohydrin, which are known to the State of California to cause birth defects or other reproductive harm. For more information go to www.P65Warnings.ca.gov.

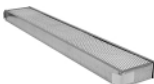
<p>PA2392</p>  <p>Outer Air Element with Bail Handle Fits: International Wheel Tractors Use With: PA2381 Replaces: International 537334-R1 O.D.: 6 3/32 (154.8) I.D.: 3 15/32 (88.1) One End Height: 13 5/16 (338.1) A. Gskt: [1] Attached Related To: PA2314 (Long Version)</p>	<p>PA2397</p>  <p>Inner Air Element Fits Inside: PA2396 Fits: Versatile Tractors Replaces: Versatile 22935 O.D.: 7 1/8 (181.0) I.D.: 17/32 (13.5) & 5 13/16 (147.6) Height: 18 1/4 (463.6) A. Gskt: [1] Attached F. Gskt: [1] Included</p>
<p>LL2393</p>  <p>Long Life Air Element with Lid and 6 Bolt Holes Fits: WhiteGMC Trucks Replaces: White 27-092086 O.D.: 12 3/4 (323.8) Lid 16 5/32 (410.4) I.D.: 7 7/16 (188.9) One End Height: 19 1/2 (495.3) A. Gskt: [2] Attached Related To: PA2393 (Standard Media Version)</p>	<p>PA2398</p>  <p>Air Element Fits: R.V.I. Trucks Replaces: Renault 5000819342 O.D.: 12 3/4 (323.8) I.D.: 8 11/32 (211.9) One End Height: 21 (533.4) A. Gskt: [2] Attached F. Gskt: G25-AF Related To: PA2437 (Short Version)</p>
<p>PA2393</p>  <p>Air Element with Lid and 6 Bolt Holes Fits: WhiteGMC Trucks Replaces: White 27-092086 O.D.: 12 3/4 (323.8) Lid 16 5/32 (410.4) I.D.: 7 7/16 (188.9) One End Height: 19 1/2 (495.3) A. Gskt: [2] Attached Related To: LL2398 (Long-Life Media Version)</p>	<p>PA2399</p>  <p>Air Element Fits: American LaFrance Trucks; Ingersoll-Rand Compressors Replaces: American LaFrance 1020900; Ingersoll-Rand 35253921 O.D.: 17 5/8 (447.7) I.D.: 15/16 (23.8) & 11 1/32 (280.2) Height: 8 1/32 (204.0) A. Gskt: [2] Attached F. Gskt: [1] Included</p>
<p>PA2394</p>  <p>Air Element with Lid and 6 Bolt Holes Fits: Allmand Equipment; International Trucks Replaces: International 417075-C91 O.D.: 13 7/8 (352.4) Lid 16 1/8 (409.6) I.D.: 7 7/16 (188.9) One End Height: 21 1/2 (546.1) A. Gskt: [2] Attached</p>	<p>PA2401</p>  <p>Outer Air Element Fits: Massey Ferguson Wheel Tractors Use With: PA2402 Replaces: Massey Ferguson 1041845-M91 O.D.: 7 15/16 (201.6) Boot 9 (228.6) I.D.: 11/16 (17.5) & 5 3/8 (136.5) Height: 13 3/8 (339.7) A. Gskt: [2] Attached F. Gskt: G103-N</p>
<p>PA2395</p>  <p>Set of 2 DynaCell Panel Air Elements Notes: Uses 2 filters per application. Fits: Industrial Applications Replaces: Farr C55445-1, RC250 Each Filter: Length: 36 7/16 (925.5) Width: 14 (355.6) Height: 6 3/16 (157.2)</p>	<p>PA2402</p>  <p>Inner Air Element Fits Inside: PA2401 Fits: Massey Ferguson Wheel Tractors Replaces: Massey Ferguson 1041846-M91 O.D.: 5 1/4 (133.4) I.D.: 5/8 (15.9) & 4 1/8 (104.8) Height: 12 1/4 (311.2) A. Gskt: [1] Attached F. Gskt: G103-N</p>
<p>PA2396</p>  <p>Outer Air Element with Lift Tabs Fits: Versatile Tractors Use With: PA2397 Replaces: Versatile 22934 O.D.: 12 1/16 (306.4) Boot 14 (355.6) I.D.: 7 11/16 (195.3) One End Height: 20 3/8 (517.5) A. Gskt: [2] Attached</p>	<p>PA2403</p>  <p>Outer Air Element with Lift Tabs Fits: Case Tractors Use With: PA2404 Replaces: Case A44694 O.D.: 12 1/16 (306.4) Boot 13 (330.2) I.D.: 5/8 (15.9) & 7 11/16 (195.3) Height: 7 1/8 (181.0) A. Gskt: [2] Attached F. Gskt: G103-N</p>

Measurements Are Shown In Inches And (Millimeters)

WARNING: These products can expose you to chemicals, including Diisononyl Phthalate, Carbon black extracts, Nickel, 1,3 Butadiene, Ethylene Oxide, Epichlorohydrin, which are known to the State of California to cause cancer, and Bisphenol, Ethylene Glycol, Ethylene Oxide, 1,3 Butadiene, Epichlorohydrin, which are known to the State of California to cause birth defects or other reproductive harm. For more information go to www.P65Warnings.ca.gov.

<p>PA2404 Inner Air Element Fits Inside: PA2403 Fits: Case Tractors Replaces: Case A44695 O.D.: 6 7/8 (174.6) I.D.: 2 1/32 (16.7) & 4 3/16 (106.4) Height: 5 1/4 (133.4) A. Gskt: [1] Attached F. Gskt: G103-N</p> 	<p>PA2411 Cab Air Element Fits: Ag-Chem, Hesston, International, Rickel Mfg. Equipment Replaces: International 537268-R1 Length: 38 (965.2) Width: 5 (127.0) Height: 2 3/16 (55.6)</p> 
<p>PA2405 Outer Air Element Fits: Atlas Copco Compressors; Bomag, Claas, Dynapac, Iveco, John Deere, Liebherr, Volvo Equipment; DAF, Iveco, Mercedes-Benz, R.V.I., Scania Buses, Trucks Use With: PA2835 Replaces: Atlas Copco 16192487; Bomag 5851012; Iveco 4776902; Mercedes-Benz 130941802; Volvo 7362224, 7362224-3 O.D.: 7 13/16 (198.4) I.D.: 1 1/32 (8.7) & 4 3/32 (104.0) Height: 14 3/4 (374.7) A. Gskt: [1] Attached F. Gskt: [1] Included</p> 	<p>PA2412 Air Element with Air Restriction Gauge Fitting Fits: Ford Buses, Trucks Replaces: Ford D2HZ-9601-A O.D.: 9 5/16 (236.5) I.D.: 1 7/32 (13.5) & 4 27/32 (123.0) Height: 10 7/16 (265.1) A. Gskt: [1] Attached F. Gskt: [1] Included Related To: PA1840 (without Air Restriction Gauge Fitting)</p> 
<p>PA2407 Cab Air Element Notes: If gasket is removed from International housing, use PA2619 instead. Fits: Case, International, John Deere, Minneapolis-Moline, Versatile, White Equipment Replaces: Case A42573; International 109215-C1; Versatile 105382; White 20-7000329 Length: 38 (965.2) Width: 6 (152.4) Height: 2 3/16 (55.6) Related To: PA2619 (with Attached Gasket)</p> 	<p>PA2413 Inner Air Element Fits Inside: PA1926, PA3698 Fits: Caterpillar Equipment; Mitsubishi Lift Trucks Replaces: Caterpillar 4N313, 4N0313 O.D.: 3 3/8 (85.7) I.D.: 1 1/16 (17.5) & 2 1/4 (57.2) Height: 10 1/4 (260.3) A. Gskt: [1] Attached F. Gskt: G103-N</p> 
<p>PA2408 Cab Air Element Fits: John Deere, White Equipment Replaces: John Deere AH80212 Length: 37 (939.8) Width: 6 (152.4) Height: 2 3/16 (55.6)</p> 	<p>PA2414 Outer Air Element Fits: Dresser, Hough, International Equipment Use With: PA2415 Replaces: International 672019-C1 O.D.: 12 1/32 (305.6) I.D.: 5/8 (15.9) & 7 11/16 (195.3) Height: 13 1/2 (342.9) F. Gskt: G103-N</p> 
<p>PA2409 Outer Air Element Fits: Dresser, Hough, International, Steiger Equipment Use With: PA2410 Replaces: International 680587-C2 O.D.: 12 1/32 (305.6) I.D.: 7/8 (22.2) & 7 11/16 (195.3) Height: 18 1/2 (469.9) A. Gskt: [1] Attached F. Gskt: G129-N</p> 	<p>PA2415 Inner Air Element Fits Inside: PA2414 Fits: Dresser, Hough, International Equipment Replaces: International 672020-C1 O.D.: 7 5/8 (193.7) I.D.: 5/8 (15.9) & 6 1/16 (154.0) Height: 12 3/8 (314.3) A. Gskt: [1] Attached F. Gskt: G103-N</p> 
<p>PA2410 Inner Air Element Fits Inside: PA2409, PA5751 Fits: Dresser, Gleaner, Hough, International, Massey Ferguson Steiger Equipment Replaces: International 681911-C91 O.D.: 7 5/8 (193.7) I.D.: 5/8 (15.9) & 6 1/16 (154.0) Height: 17 3/8 (441.3) A. Gskt: [1] Attached F. Gskt: G103-N</p> 	<p>PA2417-FN Air Element with Fins Fits: Grove Cranes Replaces: Grove 9304100069 O.D.: 12 1/16 (306.4) Fins: 13 3/4 (349.3) I.D.: 5/8 (15.9) & 5 11/16 (144.5) Height: 12 7/16 (315.9) A. Gskt: [1] Attached F. Gskt: G103-N</p> 

Measurements Are Shown In Inches And (Millimeters)

WARNING: These products can expose you to chemicals, including Diisononyl Phthalate, Carbon black extracts, Nickel, 1,3 Butadiene, Ethylene Oxide, Epichlorohydrin, which are known to the State of California to cause cancer, and Bisphenol, Ethylene Glycol, Ethylene Oxide, 1,3 Butadiene, Epichlorohydrin, which are known to the State of California to cause birth defects or other reproductive harm. For more information go to www.P65Warnings.ca.gov.

LL2418-FN



Long Life Outer Air Element with Fins
Fits: Allis Chalmers, Case, Caterpillar, Dresser, Fiat-Allis, John Deere, Kobelco, Komatsu, New Holland Equipment
Use With: PA2305, PA2332, PA2419
Replaces: Allis Chalmers 79011386; Case D56453; Caterpillar 7E0975; Fiat 73067507; Kobelco 2451U124-3A; Komatsu 600-181-9240
O.D.: 6 3/32 (154.8)
 Fins 7 13/16 (198.4)
I.D.: 3/4 (19.0) & 3 15/32 (88.1)
Height: 15 5/16 (388.9)
A. Gskt: [1] Attached
F. Gskt: G103-N
Related To: PA2418-FN (Standard Media Version)

PA2418-FN



Outer Air Element with Fins
Fits: Allis Chalmers, Case, Caterpillar, Dresser, Fiat-Allis, John Deere, Kobelco, Komatsu, New Holland Equipment
Use With: PA2305, PA2332, PA2419
Replaces: Allis Chalmers 79011386; Case D56453; Caterpillar 7E0975; Fiat 73067507; Kobelco 2451U124-3A; Komatsu 600-181-9240
O.D.: 6 3/32 (154.8)
 Fins 7 13/16 (198.4)
I.D.: 3/4 (19.0) & 3 15/32 (88.1)
Height: 15 5/16 (388.9)
A. Gskt: [1] Attached
F. Gskt: G103-N
Related To: LL2418-FN (Long-Life Media Version)

PA2419



Inner Air Element
Fits Inside: LL2418-FN, PA2418-FN, PA2420, PA2977-FN, PA3669-FN, PA3690, PA3751-FN, PA4697-FN
Fits: Allis Chalmers, Case, Caterpillar, Fiat-Allis, Hanomag, J.C. Bamford, Massey Ferguson, New Holland Equipment
Replaces: Allis Chalmers 79011387; Case L55204; Caterpillar 5W5890; Fiat 70257029; J.C. Bamford 32/202601; Massey Ferguson 1093683-M92
O.D.: 3 3/8 (85.7)
 Flange 4 5/32 (105.6)
I.D.: 5/8 (15.9) & 2 29/32 (73.8)
Height: 14 3/32 (358.0)
A. Gskt: [1] Attached
F. Gskt: G103-N

PA2420



Outer Air Element
Use With: PA2419
Replaces: Massey Ferguson 1428748-M91
O.D.: 6 3/32 (154.8)
I.D.: 3/4 (19.0) & 3 15/32 (88.1)
Height: 15 5/16 (388.9)
A. Gskt: [1] Attached
F. Gskt: G103-N

PA2421



Outer Air Element with Lift Bar
Fits: Agco, Case, John Deere, White Equipment
Use With: PA1967
Replaces: Agco 72162545; John Deere AT43963; White 20-7002186
O.D.: 9 7/32 (234.2)
I.D.: 5/8 (15.9) & 4 27/32 (123.0)
Height: 12 1/2 (317.5)
A. Gskt: [1] Attached
F. Gskt: G103-N

PA2422



Outer Air Element with Lift Bar
Fits: Allis Chalmers, Deutz, Fendt Tractors
Use With: PA3682, PA3684
Replaces: Deutz 2311565
O.D.: 6 15/32 (164.3)
I.D.: 3 11/32 (84.9) One End
Height: 8 1/4 (209.6)
A. Gskt: [1] Attached
Related To: PA2423 (Long Version)

PA2423



Outer Air Element with Lift Bar
Fits: Allis Chalmers, Bomag, Davis, Deutz Equipment
Use With: PA3683, PA3685
Replaces: Allis Chalmers 99100307; Deutz 2322855
O.D.: 6 15/32 (164.3)
I.D.: 3 11/32 (84.9) One End
Height: 13 3/32 (332.6)
A. Gskt: [1] Attached
Related To: PA2422 (Short Version)

LL2425



Long Life Air Element
Fits: Ag-Chem Equipment; Ford Trucks
Replaces: Ford D5HZ-9601-D
O.D.: 10 3/8 (263.5)
I.D.: 6 1/32 (153.2) One End
Height: 16 (406.4)
A. Gskt: [2] Attached
F. Gskt: G21-AF
O. Gskt: G499-AF
Related To: PA2425 (Standard Media Version)

PA2425



Air Element
Fits: Ag-Chem Equipment; Ford Trucks
Replaces: Ford D5HZ-9601-D
O.D.: 10 3/8 (263.5)
I.D.: 6 1/32 (153.2) One End
Height: 16 (406.4)
A. Gskt: [2] Attached
F. Gskt: G21-AF
O. Gskt: G499-AF
Related To: LL2425 (Long-Life Media Version)

Measurements Are Shown In Inches And (Millimeters)

WARNING: These products can expose you to chemicals, including Diisononyl Phthalate, Carbon black extracts, Nickel, 1,3 Butadiene, Ethylene Oxide, Epichlorohydrin, which are known to the State of California to cause cancer, and Bisphenol, Ethylene Glycol, Ethylene Oxide, 1,3 Butadiene, Epichlorohydrin, which are known to the State of California to cause birth defects or other reproductive harm. For more information go to www.P65Warnings.ca.gov.

LL2426-FN



Long Life Outer Air Element with Fins

Fits: Allis Chalmers, Atlas-Weyhausen, Clark, John Deere, Kobelco, Massey Ferguson, Michigan, Vermeer, Versatile Equipment
Use With: PA2427
Replaces: Clark 961000; Grove 9437100309; John Deere AZ25868; Kobelco 2446R277S5; Versatile V103344
O.D.: 6 7/8 (174.6)
Fins: 8 3/4 (222.3)
I.D.: 2 1/32 (16.7) & 4 3/16 (106.4)
Height: 16 3/8 (415.9)
A. Gskt: [1] Attached
F. Gskt: G103-N
Related To: PA2426-FN (Standard Media Version)

PA2426-FN



Outer Air Element with Fins

Fits: Allis Chalmers, Atlas-Weyhausen, Clark, John Deere, Kobelco, Massey Ferguson, Michigan, Vermeer, Versatile Equipment
Use With: PA2427
Replaces: Clark 961000; Grove 9437100309; John Deere AZ25868; Kobelco 2446R277S5; Versatile V103344
O.D.: 6 7/8 (174.6)
Fins: 8 3/4 (222.3)
I.D.: 2 1/32 (16.7) & 4 3/16 (106.4)
Height: 16 3/8 (415.9)
A. Gskt: [1] Attached
F. Gskt: G103-N
Related To: LL2426-FN (Long-Life Media Version)

PA2427



Inner Air Element

Fits Inside: LL2426-FN, PA2426-FN
Fits: Allis Chalmers, Atlas-Weyhausen, Clark, Grove, John Deere, Kobelco, Massey Ferguson, Michigan, New Holland, Vermeer, Versatile Equipment
Replaces: Clark 961001; John Deere AZ25867; Kobelco 2446R277S6; Versatile V90183
O.D.: 4 3/32 (104.0)
Flange: 4 25/32 (121.4)
I.D.: 25/32 (19.8) & 3 5/8 (92.1)
Height: 15 3/32 (383.4)
A. Gskt: [1] Attached
F. Gskt: G103-N

PA2428



Air Element

Replaces: International 472099-C1
O.D.: 12 1/16 (306.4)
I.D.: 5/8 (15.9) & 5 11/16 (144.5)
Height: 17 11/16 (449.3)
A. Gskt: [1] Attached
F. Gskt: G103-N
Related To: PA2429 (Short Version)

PA2429



Air Element

Fits: International, White GMC Trucks
Replaces: GMC 8995417; International 472088-C91
O.D.: 12 1/16 (306.4)
I.D.: 5/8 (15.9) & 5 11/16 (144.5)
Height: 15 11/16 (398.5)
A. Gskt: [1] Attached
F. Gskt: G103-N
Related To: PA2428 (Long Version)

PA2430



Air Element

Fits: Ford Buses, Trucks
Replaces: Ford D5HZ-9601-C
O.D.: 10 3/8 (263.5)
I.D.: 6 1/32 (153.2) One End
Height: 20 15/16 (531.8)
A. Gskt: [2] Attached
F. Gskt: G21-AF
O. Gskt: G499-AF
Related To: PA2425 (Short Version)

PA2431



Outer Air Element with Lift Bar

Fits: Ford, New Holland Equipment
Use With: PA1809, PA2432
Replaces: Ford D1NN-9601-A
O.D.: 6 11/16 (169.9)
Boot Gasket: 7 1/2 (190.5)
I.D.: 1/2 (12.7) & 3 3/4 (95.3)
Height: 15 5/16 (388.9)
A. Gskt: [2] Attached
F. Gskt: [1] Included

PA2432



Inner Air Element

Fits Inside: PA2431
Fits: Ford, New Holland Equipment
Replaces: Ford D1NN-9R500-A
O.D.: 3 5/8 (92.1)
I.D.: 1/2 (12.7) & 2 15/16 (74.6)
Height: 13 7/8 (352.4)
A. Gskt: [1] Attached
F. Gskt: [1] Included

PA2433



Outer Air Element with Lift Bar

Fits: Ford, Versatile Tractors
Use With: PA2308
Replaces: Ford D2NN-9601-A; Versatile 24575
O.D.: 7 15/16 (201.6)
Boot: 10 (254.0)
I.D.: 1/2 (12.7) & 4 5/8 (117.5)
Height: 14 1/2 (368.3)
A. Gskt: [2] Attached
F. Gskt: [1] Included

PA2434





Outer Air Element with Lift Tab

Fits: Allis Chalmers, Case-International, John Deere, New Idea Equipment
Use With: PA2435
Replaces: Allis Chalmers 70264739; International 67685-C92; John Deere AT44631; New Idea 730760
O.D.: 9 (228.6)
Boot Gasket: 10 (254.0)
I.D.: 5 11/16 (144.5) One End
Height: 16 9/16 (420.7)
A. Gskt: [2] Attached

Measurements Are Shown In Inches And (Millimeters)

WARNING: These products can expose you to chemicals, including Diisononyl Phthalate, Carbon black extracts, Nickel, 1,3 Butadiene, Ethylene Oxide, Epichlorohydrin, which are known to the State of California to cause cancer, and Bisphenol, Ethylene Glycol, Ethylene Oxide, 1,3 Butadiene, Epichlorohydrin, which are known to the State of California to cause birth defects or other reproductive harm. For more information go to www.P65Warnings.ca.gov.

PA2435 Inner Air Element

Fits Inside: PA2434, PA2569
Fits: Allis Chalmers, Case-International, Ford, John Deere, New Idea Equipment
Replaces: Allis Chalmers 70264740; Ford D5NN-9R500-C; International 67685-C92; John Deere AT44632; New Idea 730761
O.D.: 5 9/16 (141.3)
I.D.: 1/2 (12.7) & 4 13/32 (111.9)
Height: 15 21/32 (397.7)
F. Gskt: G20-AF, [1] Wing Nut

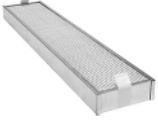
PA2439 Air Element

Notes: Inside-Out Flow Direction. Sometimes used with PA2438 in vertical housing.
Fits: Brockway, Mack Trucks
Replaces: Mack 57MD31
O.D.: 12 3/4 (323.8)
I.D.: 8 11/32 (211.9) One End
Height: 15 (381.0)
A. Gskt: [2] Attached
F. Gskt: G25-AF
O. Gskt: G422-AF
Related To: LL2439 (Long-Life Media Version)

PA2436 Cab Air Element with Pull Tabs

Fits: International Equipment; Stolper Fresh Air Blowers
Replaces: International 175568-C1
Length: 32 (812.8)
Width: 6 3/4 (171.5)
Height: 2 3/16 (55.6)

PA2440 Cab Air Element

Fits: Case-International, Hesston, Hough, Massey Ferguson, Michigan Equipment
Replaces: Case 8022345
Length: 33 (838.2)
Width: 6 1/2 (165.1)
Height: 2 3/16 (55.6)

PA2437 Air Element

Replaces: Brockway 221389
O.D.: 12 3/4 (323.8)
I.D.: 8 11/32 (211.9) One End
Height: 18 (457.2)
A. Gskt: [2] Attached
F. Gskt: G25-AF
Related To: PA2398 (Long Version)

PA2442 Outer Air Element

Fits: International, Massey Ferguson Equipment
Use With: PA2443
Replaces: International 702641-C1
O.D.: 10 (254.0)
I.D.: 3/8 (9.5) & 5 1/2 (139.7)
Height: 17 5/16 (439.7)
A. Gskt: [1] Attached
F. Gskt: [1] Included

PA2438 Inter-Cooler Air Element

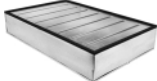
Notes: Inside-Out Flow Direction. Sometimes used with LL2439, PA2439 in vertical housing or PA2494 in horizontal housing.
Fits: Brockway, Mack Trucks
Replaces: Mack 57MD21
O.D.: 12 3/4 (323.8)
I.D.: 8 11/32 (211.9)
Height: 9 (228.6)
A. Gskt: [2] Attached
F. Gskt: G25-AF
O. Gskt: G422-AF

PA2443 Inner Air Element

Fits Inside: PA2442
Fits: International, Massey Ferguson Equipment
Replaces: International 702642-C1
O.D.: 5 1/4 (133.4)
I.D.: 21/32 (16.7) & 4 1/8 (104.8)
Height: 16 3/32 (408.8)
A. Gskt: [1] Attached
F. Gskt: G103-N

LL2439 Long Life Air Element

Notes: Inside-Out Flow Direction. Sometimes used with PA2438 in vertical housing.
Fits: Brockway, Mack Trucks
Replaces: Mack 57MD31
O.D.: 12 3/4 (323.8)
I.D.: 8 11/32 (211.9) One End
Height: 15 (381.0)
A. Gskt: [2] Attached
F. Gskt: G25-AF
O. Gskt: G422-AF
Related To: PA2439 (Standard Media Version)

PA2444 DynaCell Panel Air Element

Notes: Front is open, sides are closed.
Replaces: Farr C51800, T528; White 22-0010087
Length: 28 1/2 (723.9)
Width: 19 (482.6)
Height: 5 3/8 (136.5)
Related To: PA2564 (Both Sides Open)

PA2445 Outer Air Element

Fits: Case Equipment
Use With: PA2446
Replaces: Case A44804
O.D.: 13 7/8 (352.4)
I.D.: 11/16 (17.5) & 7 7/16 (188.9)
Height: 9 1/2 (241.3)
A. Gskt: [1] Attached
F. Gskt: G103-N

Measurements Are Shown In Inches And (Millimeters)

WARNING: These products can expose you to chemicals, including Diisononyl Phthalate, Carbon black extracts, Nickel, 1,3 Butadiene, Ethylene Oxide, Epichlorohydrin, which are known to the State of California to cause cancer, and Bisphenol, Ethylene Glycol, Ethylene Oxide, 1,3 Butadiene, Epichlorohydrin, which are known to the State of California to cause birth defects or other reproductive harm. For more information go to www.P65Warnings.ca.gov.

PA2446 Inner Air Element
Fits Inside: PA2445
Fits: Case Equipment
Replaces: Case A44805
O.D.: 6 7/8 (174.6)
I.D.: 21/32 (16.7) & 4 3/16 (106.4)
Height: 8 3/8 (212.7)
A. Gskt: [1] Attached
F. Gskt: G103-N



PA2452 Inner Air Element
Fits Inside: PA2451
Fits: Komatsu Equipment
Replaces: Komatsu 669-181-7310
O.D.: 4 9/16 (115.9)
 Flange 5 23/32 (145.3)
I.D.: 21/32 (16.7) & 3 7/16 (87.3)
Height: 14 23/32 (373.9)
A. Gskt: [1] Attached
F. Gskt: G103-N



LL2447-FN Long Life Air Element with Fins
Replaces: Donaldson P181066
O.D.: 13 7/8 (352.4)
 Fins 15 25/32 (400.8)
I.D.: 5/8 (15.9) & 9 1/2 (241.3)
Height: 14 3/8 (365.1)
A. Gskt: [1] Attached
F. Gskt: [1] Included
Related To: PA2447-FN (Standard Media Version)



LL2453 Long Life Outer Air Element with Bail Handle
Fits: Case, Caterpillar, Driltech, KW-Dart, Terex, WABCO Equipment; Euclid, Komatsu Trucks
Use With: PA2364, PA2454
Replaces: Caterpillar 1W3637; Driltech 103653; Euclid 9038350; Komatsu 581-021-2120; WABCO VJ5175
O.D.: 17 5/8 (447.7)
 Boot 18 5/16 (465.1)
I.D.: 15/16 (23.8) & 12 1/8 (308.0)
Height: 23 17/32 (597.7)
A. Gskt: [2] Attached
F. Gskt: [1] Included
Related To: PA2453 (Standard Media Version)
 PA2453XP (Extreme Performance Nano Version)



PA2447-FN Air Element with Fins
Replaces: Donaldson P181066
O.D.: 13 7/8 (352.4)
 Fins 15 25/32 (400.8)
I.D.: 5/8 (15.9) & 9 1/2 (241.3)
Height: 14 3/8 (365.1)
A. Gskt: [1] Attached
F. Gskt: [1] Included
Related To: LL2447-FN (Long-Life Media Version)



PA2453 Outer Air Element with Bail Handle
Fits: Case, Caterpillar, Driltech, KW-Dart, Terex, WABCO Equipment; Euclid, Komatsu Trucks
Use With: PA2364, PA2454
Replaces: Caterpillar 1W3637; Driltech 103653; Euclid 9038350; Komatsu 581-021-2120; WABCO VJ5175
O.D.: 17 5/8 (447.7)
 Boot 18 5/16 (465.1)
I.D.: 15/16 (23.8) & 12 1/8 (308.0)
Height: 23 17/32 (597.7)
A. Gskt: [2] Attached
F. Gskt: [1] Included
Related To: LL2453 (Long-Life Media Version)
 PA2453XP (Extreme Performance Nano Version)



PA2448 Cab Air Element
Fits: Allis Chalmers Tractors
Replaces: Allis Chalmers 579916
Length: 26 3/4 (679.4)
Width: 7 3/4 (196.9)
Height: 2 3/16 (55.6)



PA2450 DynaCell Panel Air Element
Fits: Blaw-Knox, Cedarapids Road Building Equipment; Ottawa Trucks
Replaces: Farr T512, C49261; Ottawa 99105821
Length: 15 (381.0)
Width: 11 1/2 (292.1)
Height: 5 1/2 (139.7)



PA2453XP Extreme Performance Nano Outer Air Element with Bail Handle
Fits: Case, Caterpillar, Driltech, KW-Dart, Terex, WABCO Equipment; Euclid, Komatsu Trucks
Use With: PA2364, PA2454
Replaces: Caterpillar 1W3637; Driltech 103653; Euclid 9038350; Komatsu 581-021-2120; WABCO VJ5175
O.D.: 17 5/8 (447.7)
 Boot 18 5/16 (465.1)
I.D.: 15/16 (23.8) & 12 1/8 (308.0)
Height: 23 17/32 (597.7)
A. Gskt: [2] Attached
F. Gskt: [1] Included
Related To: LL2453 (Long-Life Media Version)
 PA2453 (Standard Media Version)











PA2451 Outer Air Element
Fits: Komatsu Equipment
Use With: PA2452
Replaces: Komatsu 600-181-3300
O.D.: 9 7/32 (234.2)
I.D.: 21/32 (16.7) & 4 27/32 (123.0)
Height: 15 1/2 (393.7)
A. Gskt: [1] Attached
F. Gskt: G103-N



Measurements Are Shown In Inches And (Millimeters)

WARNING: These products can expose you to chemicals, including Diisononyl Phthalate, Carbon black extracts, Nickel, 1,3 Butadiene, Ethylene Oxide, Epichlorohydrin, which are known to the State of California to cause cancer, and Bisphenol, Ethylene Glycol, Ethylene Oxide, 1,3 Butadiene, Epichlorohydrin, which are known to the State of California to cause birth defects or other reproductive harm. For more information go to www.P65Warnings.ca.gov.

<p>PA2454</p> 	<p>Inner Air Element Fits Inside: PA2453, PA2453XP Fits: Case, Caterpillar, Driltech, KW-Dart, Terex, WABCO Equipment; Euclid, Komatsu Trucks Replaces: Caterpillar 1W3636; Driltech 103661; Euclid 9038349; Komatsu 581-021-2130; WABCO VJ5176 O.D.: 11 7/8 (301.6) I.D.: 7/8 (22.2) & 10 1/4 (260.3) Height: 22 1/2 (571.5) A. Gskt: [1] Attached F. Gskt: [1] Included</p>	<p>PA2456XP</p>  <p>Extreme Performance Nano Outer Air Element Fits: CMI, Grove, Insley, Michigan, Morbark Equipment; Ingersoll-Rand, Sullair Compressors Use With: PA2457 Replaces: Grove 9304100036; Ingersoll-Rand 35711209; Insley 453043; Sullair 48462 O.D.: 12 11/16 (322.3) Boot 12 25/32 (324.6) I.D.: 29/32 (23.0) & 8 3/8 (212.7) Height: 24 1/32 (610.4) A. Gskt: [2] Attached F. Gskt: [1] Included Related To: LL2456 (Long-Life Media Version) PA2456 (Standard Media Version)</p>
<p>PA2455</p> 	<p>Inner Air Element Fits Inside: PA1864-FN Fits: Joy Compressors Replaces: Joy 3606283-21 O.D.: 6 3/8 (161.9) Flange 7 1/2 (190.5) I.D.: 5/8 (15.9) & 5 1/4 (133.4) Height: 15 (381.0) A. Gskt: [1] Attached F. Gskt: G103-N</p>	<p>PA2457</p>  <p>Inner Air Element Fits Inside: LL2456, PA2456, PA2456XP Fits: CMI, Grove, Insley, Michigan, Morbark Equipment; Ingersoll-Rand, Sullair Compressors Replaces: Grove 9304100037; Ingersoll-Rand 35123520; Insley 914621; Sullair 48463 O.D.: 8 1/4 (209.6) I.D.: 15/16 (23.8) & 7 3/32 (180.2) Height: 22 3/8 (568.3) A. Gskt: [1] Attached F. Gskt: [1] Included</p>
<p>LL2456</p> 	<p>Long Life Outer Air Element Fits: CMI, Grove, Insley, Michigan, Morbark Equipment; Ingersoll-Rand, LeRoi, Sullair Compressors Use With: PA2457 Replaces: Grove 9304100036; Ingersoll-Rand 35711209; Insley 453043; Sullair 48462 O.D.: 12 11/16 (322.3) Boot 12 25/32 (324.6) I.D.: 29/32 (23.0) & 8 3/8 (212.7) Height: 24 1/32 (610.4) A. Gskt: [2] Attached F. Gskt: [1] Included Related To: PA2456 (Standard Media Version) PA2456XP (Extreme Performance Nano Version)</p>	<p>LL2458</p>  <p>Long Life Air Element Fits: Kenworth Trucks Replaces: GMC 25041399; Kenworth KW1600M O.D.: 13 7/8 (352.4) I.D.: 7 7/16 (188.9) One End Height: 27 (685.8) A. Gskt: [2] Attached F. Gskt: G145-AF Related To: PA2458 (Standard Media)</p>
<p>PA2456</p> 	<p>Outer Air Element Fits: CMI, Grove, Insley, Michigan, Morbark Equipment; Ingersoll-Rand, Sullair Compressors Use With: PA2457 Replaces: Grove 9304100036; Ingersoll-Rand 35711209; Insley 453043; Sullair 48462 O.D.: 12 11/16 (322.3) Boot 12 25/32 (324.6) I.D.: 29/32 (23.0) & 8 3/8 (212.7) Height: 24 1/32 (610.4) A. Gskt: [2] Attached F. Gskt: [1] Included Related To: LL2456 (Long-Life Media Version) PA2456XP (Extreme Performance Nano Version)</p>	<p>PA2458</p>  <p>Air Element Fits: Kenworth Trucks Replaces: GMC 25041399; Kenworth KW1600M O.D.: 13 7/8 (352.4) I.D.: 7 7/16 (188.9) One End Height: 27 (685.8) A. Gskt: [2] Attached F. Gskt: G145-AF Related To: LL2458 (Long-Life Version)</p>
	<p>PA2459</p>  <p>Outer Air Element with Lift Tabs Fits: White Equipment Use With: PA2460 Replaces: White 30-3071219 O.D.: 9 5/8 (244.5) I.D.: 6 3/16 (157.2) One End Height: 16 5/16 (414.3) A. Gskt: [1] Attached</p>	

Measurements Are Shown In Inches And (Millimeters)

WARNING: These products can expose you to chemicals, including Diisononyl Phthalate, Carbon black extracts, Nickel, 1,3 Butadiene, Ethylene Oxide, Epichlorohydrin, which are known to the State of California to cause cancer, and Bisphenol, Ethylene Glycol, Ethylene Oxide, 1,3 Butadiene, Epichlorohydrin, which are known to the State of California to cause birth defects or other reproductive harm. For more information go to www.P65Warnings.ca.gov.

PA2460 Inner Air Element
Fits Inside: PA2459
Fits: White Equipment
Replaces: White 30-3130509
O.D.: 6 1/8 (155.6)
I.D.: 17/32 (13.5) & 4 15/16 (125.4)
Height: 14 3/8 (365.1)
A. Gskt: [1] Attached
F. Gskt: [1] Included



PA2466 Outer Air Element
Fits: Case, Case-International, Furukawa, John Deere, Komatsu, Minneapolis-Moline, Oliver Equipment
Use With: PA2467
Replaces: Furukawa 550106009; International 932391-C1; Komatsu 381-982-8121
O.D.: 9 7/32 (234.2)
I.D.: 21/32 (16.7) & 5 27/32 (148.4)
Height: 18 3/8 (466.7)
A. Gskt: [1] Attached
F. Gskt: G103-N



PA2461 Outer Air Element
Fits: Hanomag, John Deere, Terex Equipment; R.V.I. Trucks
Use With: PA2462
Replaces: Hanomag 3074306-M1; John Deere AR70106
O.D.: 10 3/8 (263.5)
I.D.: 15/16 (23.8) & 6 1/32 (153.2)
Height: 20 3/8 (517.5)
A. Gskt: [1] Attached
F. Gskt: [1] Included



PA2467 Inner Air Element
Fits Inside: PA2466
Fits: Case, Case-International, Furukawa, John Deere, Komatsu, Minneapolis-Moline, Oliver Equipment
Replaces: Furukawa 550106008; International 932390-C1; Komatsu 381-928-8111
O.D.: 5 23/32 (145.3)
I.D.: 21/32 (16.7) & 4 19/32 (116.7)
Height: 16 3/8 (415.9)
A. Gskt: [1] Attached
F. Gskt: G103-N



PA2462 Inner Air Element
Fits Inside: PA2461
Fits: Hanomag, John Deere, Terex Equipment
Replaces: Hanomag 3074309-M1; John Deere AR70107
O.D.: 5 15/16 (150.8)
I.D.: 21/32 (16.7) & 4 27/32 (123.0)
Height: 18 3/8 (466.7)
A. Gskt: [1] Attached
F. Gskt: G103-N



PA2468 Air Element
Fits: GMC Buses, Trucks
Replaces: GMC 89946615
O.D.: 13 7/8 (352.4)
I.D.: 11/16 (17.5) & 7 7/16 (188.9)
Height: 18 1/2 (469.9)
A. Gskt: [1] Attached
F. Gskt: G103-N



PA2463 Cab Air Element
Notes: OBSOLETE. Availability Limited to Dealer Stock.
Fits: Allis Chalmers Optional Equipment
Replaces: Allis Chalmers 566900
Length: 28 (711.2)
Width: 6 3/4 (171.5)
Height: 2 3/16 (55.6)



PA2469 Inner Air Element
Fits Inside: PA1997
Fits: Massey Ferguson Equipment
Replaces: Massey Ferguson 1041911-M91
O.D.: 4 3/32 (104.0)
 Flange 4 13/16 (122.2)
I.D.: 3/4 (19.0) & 3 5/8 (92.1)
Height: 14 23/32 (373.9)
A. Gskt: [1] Attached
F. Gskt: G103-N



PA2464 Cab Air Element
Fits: Massey Ferguson Equipment
Replaces: Massey Ferguson 529760-M1
Length: 47 (1193.8)
Width: 6 (152.4)
Height: 2 9/16 (65.1)
A. Gskt: [1] Attached



PA2472 Air Element
Contains: Flame Retardant Media
Fits: Ford Buses, Trucks
Replaces: Ford E1HZ-9601-A
O.D.: 12 5/8 (320.7)
I.D.: 9 3/4 (247.7)
Height: 5 1/2 (139.7)



PA2465 Air Element with Bolt
Contains: Bolt Thread: 5/16-18
Fits: GMC, International Buses, Trucks
Replaces: GMC 25040533; International 470289-C1
O.D.: 10 3/8 (263.5)
I.D.: 6 1/32 (153.2) One End
Height: 10 1/2 (266.7)
A. Gskt: [1] Attached



PA2473 Air Element
Fits: International Buses, Trucks
Replaces: International 461236-C1
O.D.: 12 1/32 (305.6)
I.D.: 5/8 (15.9) & 7 11/16 (195.3)
Height: 8 1/2 (215.9)
A. Gskt: [1] Attached
F. Gskt: [1] Included



Measurements Are Shown In Inches And (Millimeters)

WARNING: These products can expose you to chemicals, including Diisononyl Phthalate, Carbon black extracts, Nickel, 1,3 Butadiene, Ethylene Oxide, Epichlorohydrin, which are known to the State of California to cause cancer, and Bisphenol, Ethylene Glycol, Ethylene Oxide, 1,3 Butadiene, Epichlorohydrin, which are known to the State of California to cause birth defects or other reproductive harm. For more information go to www.P65Warnings.ca.gov.

PA2474

Outer Air Element



Fits: Atlas Copco, CompAir Compressors; Bomag, John Deere, Kobelco, V.M.E., Volvo Equipment; DAF, Iveco, M.A.N., Mercedes-Benz, R.V.I., Scania, Volvo Buses, Trucks
Use With: PA2836
Replaces: Atlas Copco 1619279800; Bomag 5821018; DAF 112294; Iveco 1902465; Mercedes-Benz 130941702; Volvo 6644990,-1
O.D.: 8 15/16 (227.0)
I.D.: 1/2 (12.7) & 4 19/32 (116.7)
Height: 15 (381.0)
A. Gskt: [1] Attached
F. Gskt: [1] Included

PA2475

Outer Air Element



Fits: Atlas Copco Compressors; DAF, Iveco, M.A.N., Mercedes-Benz, Scania Buses, Trucks; Kobelco, Liebherr, New Holland, V.M.E., Volvo Equipment
Use With: PA2814
Replaces: Atlas Copco 16192799; Iveco 1901779; Liebherr 9367183; Mercedes-Benz 10947904; Volvo 47857487
O.D.: 9 17/32 (242.1)
I.D.: 1/2 (12.7) & 5 5/32 (131.0)
Height: 19 9/16 (496.9)
A. Gskt: [1] Attached
F. Gskt: [1] Included

PA2476

Air Element



Fits: Benford Equipment; Petter Engines
Replaces: Petter ACF499-6
O.D.: 3 5/8 (92.1)
I.D.: 1 31/32 (50.0)
Height: 2 27/32 (72.2)

PA2477

Air Element



Replaces: Petter BAF423
O.D.: 4 3/8 (111.1)
I.D.: 1 31/32 (50.0)
Height: 2 19/32 (65.9)

PA2478

Outer Air Element with Lid and Lift Tab



Fits: Komatsu Equipment
Use With: PA1880
Replaces: Komatsu 612-881-7320
O.D.: 12 1/16 (306.4)
 Lid 14 13/16 (376.2)
I.D.: 15/16 (23.8) & 7 11/16 (195.3)
Height: 18 1/2 (469.9)
A. Gskt: [2] Attached
F. Gskt: [1] Included

PA2479

Air Element



Fits: Chrysler-Nissan Industrial Engines
Replaces: Nissan 16546-90114
O.D.: 8 17/32 (216.7)
I.D.: 4 3/8 (111.1)
Height: 3 5/16 (84.1)

LL2482

Long Life Air Element



Notes: Inside-Out Flow Direction
Fits: GMC, Kenworth, Mack Trucks
Replaces: GMC 25040009
O.D.: 8 27/32 (224.6)
I.D.: 5 15/32 (138.9) One End
Height: 23 (584.2)
A. Gskt: [2] Attached
F. Gskt: G207-AF
O. Gskt: G472-AF
Related To: PA2482 (Standard Media Version)

PA2482

Air Element



Notes: Inside-Out Flow Direction
Fits: GMC, Kenworth, Mack Trucks
Replaces: GMC 25040009
O.D.: 8 27/32 (224.6)
I.D.: 5 15/32 (138.9) One End
Height: 23 (584.2)
A. Gskt: [2] Attached
F. Gskt: G207-AF
O. Gskt: G472-AF
Related To: LL2482 (Long-Life Media Version)

PA2483

Air Element



Fits: Ford Trucks
Replaces: Ford E1HZ-9601-B
O.D.: 12 19/32 (319.9)
I.D.: 8 9/32 (210.3)
Height: 5 1/2 (139.7)

PA2484

Air Element



Fits: Chicago-Pneumatic, Driltech Drills; Joy Compressors
Replaces: Driltech 221551
O.D.: 7 15/16 (201.6)
I.D.: 11/16 (17.5) & 3 9/16 (90.5)
Height: 16 1/2 (419.1)
A. Gskt: [1] Attached
F. Gskt: G103-N

PA2485











Cab Air Element



Fits: Agco, Deutz-Allis, Minneapolis-Moline, Oliver, White Equipment
Replaces: White 20-7000164
Length: 47 (1193.8)
Width: 7 (177.8)
Height: 2 3/16 (55.6)











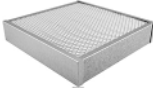

Measurements Are Shown In Inches And (Millimeters)

WARNING: These products can expose you to chemicals, including Diisononyl Phthalate, Carbon black extracts, Nickel, 1,3 Butadiene, Ethylene Oxide, Epichlorohydrin, which are known to the State of California to cause cancer, and Bisphenol, Ethylene Glycol, Ethylene Oxide, 1,3 Butadiene, Epichlorohydrin, which are known to the State of California to cause birth defects or other reproductive harm. For more information go to www.P65Warnings.ca.gov.

<p>PA2486</p>  <p>Outer Air Element with Lift Bar Fits: Massey Ferguson, Ramacher Equipment Use With: PA2323 Replaces: Massey Ferguson 1042216-M91 O.D.: 5 5/16 (134.9) I.D.: 5/8 (15.9) & 3 13/32 (86.5) Height: 14 3/8 (365.1) A. Gskt: [1] Attached</p>	<p>PA2491</p>  <p>Inner Air Element Fits Inside: PA2490 Fits: Quincy, Worthington Compressors Replaces: Quincy 120382; Worthington ELM89 O.D.: 7 3/8 (187.3) I.D.: 3/4 (19.0) & 6 1/8 (155.6) Height: 19 1/2 (495.3) A. Gskt: [1] Attached F. Gskt: G103-N</p>
<p>PA2487</p>  <p>Inner Air Element Fits Inside: LL2360-FN, PA2360-FN Fits: Bobcat, Bomag, Case, Davis, Ditch Witch, Gehl, J.C. Bamford, Massey Ferguson, New Holland, Vermeer, Versatile Equipment Replaces: Case A173291; Clark 6630940; Davis 87859; Ditch Witch 195809; J.C. Bamford 32/205703; Melroe-Bobcat 6630940; Versatile 51934 O.D.: 2 31/32 (75.4) Flange 3 5/8 (92.1) I.D.: 5/8 (15.9) & 2 7/16 (61.9) Height: 14 3/32 (358.0) A. Gskt: [1] Attached F. Gskt: G103-N</p>	<p>LL2493</p>  <p>Long Life Air Element Notes: Inside-Out Flow Direction Fits: Western Star Trucks Replaces: White 22-0054401 O.D.: 10 3/8 (263.5) I.D.: 6 1/32 (153.2) One End Height: 27 (685.8) A. Gskt: [2] Attached F. Gskt: G21-AF Related To: PA2493 (Standard Media Version)</p>
<p>PA2488-FN</p>  <p>Outer Air Element with Fins Fits: Bobcat Loaders; Massey Ferguson Equipment Use With: PA2489 Replaces: Fiat 71909139; Massey Ferguson 1043326-M91 O.D.: 5 1/4 (133.4) Fins 6 3/8 (161.9) I.D.: 2 1/32 (16.7) & 2 5/8 (66.7) Height: 11 1/4 (285.8) A. Gskt: [1] Attached F. Gskt: G103-N</p>	<p>PA2493</p>  <p>Air Element Notes: Inside-Out Flow Direction Fits: Western Star Trucks Replaces: White 22-0054401 O.D.: 10 3/8 (263.5) I.D.: 6 1/32 (153.2) One End Height: 27 (685.8) A. Gskt: [2] Attached F. Gskt: G21-AF Related To: LL2493 (Long-Life Media Version)</p>
<p>PA2489</p>  <p>Inner Air Element Fits Inside: LL1667-FN, PA1667-FN, PA2391, PA2488-FN, PA3791-FN Fits: Bobcat, Ditch Witch, Fiat, Ford, Hesston, John Deere, Kubota, Massey Ferguson, New Holland Equipment Replaces: Ditch Witch 195818; Fiat 1909138; John Deere RE45826; Kubota 17381-11181; Massey Ferguson 1043327-M91; New Holland 86504143 O.D.: 2 17/32 (64.3) Flange 3 3/32 (78.6) I.D.: 5/8 (15.9) & 2 5/32 (54.8) Height: 10 1/8 (257.2) A. Gskt: [1] Attached F. Gskt: G103-N</p>	<p>PA2494</p>  <p>Air Element Notes: Inside-Out Flow Direction. Sometimes used with PA2438 in horizontal housing. Replaces: Mack 57MD29301 O.D.: 12 3/4 (323.8) I.D.: 8 11/32 (211.9) Height: 15 (381.0) A. Gskt: [2] Attached F. Gskt: G25-AF</p>
<p>PA2490</p>  <p>Outer Air Element Fits: Quincy, Worthington Compressors Use With: PA2491 Replaces: Quincy 234583; Worthington ELM64 O.D.: 12 1/2 (317.5) I.D.: 13/32 (10.3) & 7 1/2 (190.5) Height: 21 1/4 (539.8) A. Gskt: [1] Attached F. Gskt: [1] Included</p>	<p>PA2495</p>  <p>Outer Air Element Fits: Minneapolis-Moline Tractors Use With: PA1998 Replaces: White 30-3108732 O.D.: 7 5/8 (193.7) Boot 8 5/8 (219.1) I.D.: 5/8 (15.9) & 4 1/4 (108.0) Height: 16 7/16 (417.5) A. Gskt: [2] Attached F. Gskt: G103-N</p>
<p>PA2496</p>  <p>Outer Air Element with Lift Bar Contains: Flame Retardant Media Fits: Massey Ferguson Equipment Use With: PA1809 Replaces: Massey Ferguson 1094056-M91 O.D.: 5 11/32 (135.7) I.D.: 7/16 (11.1) & 2 7/32 (56.4) Height: 10 11/16 (271.5) A. Gskt: [1] Attached F. Gskt: [1] Included</p>	











Measurements Are Shown In Inches And (Millimeters)

WARNING: These products can expose you to chemicals, including Diisononyl Phthalate, Carbon black extracts, Nickel, 1,3 Butadiene, Ethylene Oxide, Epichlorohydrin, which are known to the State of California to cause cancer, and Bisphenol, Ethylene Glycol, Ethylene Oxide, 1,3 Butadiene, Epichlorohydrin, which are known to the State of California to cause birth defects or other reproductive harm. For more information go to www.P65Warnings.ca.gov.

<p>PA2497 Cab Air Element Fits: Allis Chalmers Equipment Replaces: Allis Chalmers 246580 Length: 11 (279.4) Width: 11 (279.4) Height: 2 3/16 (55.6)</p> 	<p>PA2504 Outer Air Element Fits: Chevrolet, International, Isuzu, Nissan Trucks; Clark, Hitachi, Taylor Machine, Timberjack Equipment Use With: PA2545 Replaces: Clark 2521682; GMC 25043888; Hitachi 4147010 O.D.: 8 27/32 (224.6) I.D.: 15/16 (23.8) & 5 13/16 (147.6) Height: 13 1/2 (342.9) A. Gskt: [1] Attached F. Gskt: [1] Included</p> 
<p>PA2498 Pressurized Cab Air Element Fits: Caterpillar Crawler Tractors Replaces: Caterpillar 6P6664 O.D.: 6 7/8 (174.6) I.D.: 21/32 (16.7) & 4 3/16 (106.4) Height: 12 3/8 (314.3) A. Gskt: [1] Attached F. Gskt: [1] Included, [1] Wing Nut</p> 	<p>LL2507 Long Life Outer Air Element Fits: Benford, Terex Equipment Use With: PA2508 Replaces: GMC 9059570; Terex 9039993 O.D.: 17 5/8 (447.7) Boot 18 5/16 (465.1) I.D.: 13/32 (10.3) & 12 1/8 (308.0) Height: 19 17/32 (496.1) A. Gskt: [2] Attached F. Gskt: G39-AF Related To: PA2507 (Standard Media Version)</p> 
<p>PA2499 Cab Air Element Fits: Caterpillar Equipment Replaces: Caterpillar 6K9606 Length: 23 1/2 (596.9) Width: 7 1/8 (181.0) Height: 15/16 (23.8)</p> 	<p>PA2507 Outer Air Element Fits: Benford, Terex Equipment Use With: PA2508 Replaces: GMC 9059570; Terex 9039993 O.D.: 17 5/8 (447.7) Boot 18 5/16 (465.1) I.D.: 13/32 (10.3) & 12 1/8 (308.0) Height: 19 17/32 (496.1) A. Gskt: [2] Attached F. Gskt: G39-AF Related To: LL2507 (Long-Life Media Version)</p> 
<p>PA2500 Conical-Shaped Air Element Notes: Inside-Out Flow Direction Fits: Ford, GMC, International, WhiteGMC Trucks; Advance Mixer, Gradall Equipment Replaces: Ford F8HZ-9601-A; GMC 8997221; International 503634-C91; Mack 57MD29503 O.D.: 5 13/16 (147.6) to 8 11/16 (220.7) I.D.: 2 3/16 (55.6) One End Height: 29 (736.6) A. Gskt: [2] Attached F. Gskt: [1] Included Related To: PA2540 (Short Version)</p> 	<p>PA2508 Inner Air Element Fits Inside: LL2507, PA2507 Fits: Terex Tractors Replaces: GMC 9039992; Terex 9039992 O.D.: 11 7/8 (301.6) I.D.: 7/8 (22.2) & 10 1/4 (260.3) Height: 18 5/32 (461.2) A. Gskt: [1] Included F. Gskt: [1] Included</p> 
<p>PA2502 Cab Air Element Fits: Allis Chalmers, Egging Tractors Replaces: Allis Chalmers 3107280 Length: 23 1/2 (596.9) Width: 6 1/2 (165.1) Height: 2 3/16 (55.6)</p> 	<p>PA2509 Outer Air Element Fits: Agco, Allis Chalmers, Ford, Gleaner, Steiger Equipment Use With: PA2510 Replaces: Allis Chalmers 70269244; Ford SFD07-1011 O.D.: 10 3/8 (263.5) I.D.: 15/16 (23.8) & 6 1/32 (153.2) Height: 18 3/8 (466.7) A. Gskt: [1] Attached F. Gskt: [1] Included</p> 
<p>LL2503 Long Life Air Element Notes: Inside-Out Flow Direction Fits: GMC Trucks Replaces: GMC 25041712 O.D.: 8 27/32 (224.6) I.D.: 5 13/16 (147.6) One End Height: 29 (736.6) A. Gskt: [2] Attached O. Gskt: G207-AF Related To: PA2503 (Standard Media Version)</p> 	<p>PA2503 Air Element Notes: Inside-Out Flow Direction Fits: GMC Trucks Replaces: GMC 25041712 O.D.: 8 27/32 (224.6) I.D.: 5 13/16 (147.6) One End Height: 29 (736.6) A. Gskt: [2] Attached O. Gskt: G207-AF Related To: LL2503 (Long-Life Media Version)</p> 











Measurements Are Shown In Inches And (Millimeters)

WARNING: These products can expose you to chemicals, including Diisononyl Phthalate, Carbon black extracts, Nickel, 1,3 Butadiene, Ethylene Oxide, Epichlorohydrin, which are known to the State of California to cause cancer, and Bisphenol, Ethylene Glycol, Ethylene Oxide, 1,3 Butadiene, Epichlorohydrin, which are known to the State of California to cause birth defects or other reproductive harm. For more information go to www.P65Warnings.ca.gov.

<p>PA2510 Inner Air Element  Fits Inside: PA2509, PA2591 Fits: Agco, Allis Chalmers, Ford, Gleaner, Steiger Equipment Replaces: Allis Chalmers 279245; Case A45695; Ford SFD07-1010 O.D.: 5 15/16 (150.8) I.D.: 2 1/32 (16.7) & 4 27/32 (123.0) Height: 16 3/8 (415.9) A. Gskt: [1] Attached F. Gskt: G103-N</p>	<p>PA2516 Air Element  Fits: GMC Buses, Trucks Replaces: GMC 25040535 O.D.: 13 7/8 (352.4) I.D.: 7 7/16 (188.9) One End Height: 26 (660.4) A. Gskt: [2] Attached F. Gskt: G145-AF</p>
<p>PA2511 Outer Air Element  Fits: Dresser, International Equipment Use With: PA2512 Replaces: International 631421-C1 O.D.: 7 11/32 (186.5) I.D.: 7/16 (11.1) & 4 (101.6) Height: 14 3/4 (374.7) A. Gskt: [1] Attached F. Gskt: [1] Included</p>	<p>PA2517 Air Element with Lid and 6 Bolt Holes  Replaces: Ford D6HS-9601-B O.D.: 13 7/8 (352.4) Lid 16 1/8 (409.6) I.D.: 7 7/16 (188.9) One End Height: 13 17/32 (343.7) A. Gskt: [2] Attached</p>
<p>PA2512 Inner Air Element  Fits Inside: PA2511 Fits: Dresser, International Equipment Replaces: International 631422-C1 O.D.: 3 7/8 (98.4) I.D.: 5/8 (15.9) & 2 1/2 (63.5) Height: 12 1/16 (306.4) A. Gskt: [1] Attached F. Gskt: G103-N</p>	<p>LL2518 Long Life Outer Air Element  Fits: Ag-Chem, Terex Equipment; Ingersoll-Rand, Joy, Sullair Compressors Use With: PA2519 Replaces: Ag-Chem 718569; Euclid 9013550; Ingersoll-Rand 35355395; Joy 360628329; Sullair 46968 O.D.: 12 1/8 (308.0) Boot 12 13/16 (325.4) I.D.: 29/32 (23.0) & 7 11/16 (195.3) Height: 20 3/8 (517.5) A. Gskt: [2] Attached F. Gskt: [1] Included Related To: PA2518 (Standard Media Version) PA2518XP (Extreme Performance Nano Version)</p>
<p>PA2513 Outer Air Element with Lift Bar  Fits: Ford Equipment Use With: PA2514 Replaces: Ford D5NN-9601-B O.D.: 5 5/16 (134.9) Boot 5 3/4 (146.0) I.D.: 7/16 (11.1) & 3 1/16 (77.8) Height: 11 1/2 (292.1) A. Gskt: [2] Attached F. Gskt: [1] Included</p>	<p>PA2518 Outer Air Element  Fits: Ag-Chem, Terex Equipment; Ingersoll-Rand, Joy, Sullair Compressors Use With: PA2519 Replaces: Ag-Chem 718569; Euclid 9013550; Ingersoll-Rand 35355395; Joy 360628329; Sullair 46968 O.D.: 12 1/8 (308.0) Boot 12 13/16 (325.4) I.D.: 29/32 (23.0) & 7 11/16 (195.3) Height: 20 3/8 (517.5) A. Gskt: [2] Attached F. Gskt: [1] Included Related To: LL2518 (Long-Life Media Version) PA2518XP (Extreme Performance Nano Version)</p>
<p>PA2514 Inner Air Element  Fits Inside: PA2513 Fits: Ford Equipment Replaces: Ford D5NN-9R500-B O.D.: 2 15/16 (74.6) I.D.: 17/32 (13.5) & 2 13/32 (61.1) Height: 9 15/16 (252.4) A. Gskt: [2] Attached F. Gskt: [1] Included</p>	
<p>PA2515 Air Element  Fits: GMC Buses, Trucks Replaces: GMC 25177168 O.D.: 13 7/8 (352.4) I.D.: 7 7/16 (188.9) One End Height: 20 (508.0) A. Gskt: [2] Included F. Gskt: G145-AF</p>	

Measurements Are Shown In Inches And (Millimeters)

WARNING: These products can expose you to chemicals, including Diisononyl Phthalate, Carbon black extracts, Nickel, 1,3 Butadiene, Ethylene Oxide, Epichlorohydrin, which are known to the State of California to cause cancer, and Bisphenol, Ethylene Glycol, Ethylene Oxide, 1,3 Butadiene, Epichlorohydrin, which are known to the State of California to cause birth defects or other reproductive harm. For more information go to www.P65Warnings.ca.gov.

<p>PA2518XP</p> 	<p>Extreme Performance Nano Outer Air Element Fits: Ag-Chem, Terex Equipment; Ingersoll-Rand, Joy, Sullair Compressors Use With: PA2519 Replaces: Ag-Chem 718569; Euclid 9013550; Ingersoll-Rand 35355395; Joy 360628329; Sullair 46968 O.D.: 12 1/8 (308.0) Boot 12 13/16 (325.4) I.D.: 29/32 (23.0) & 7 11/16 (195.3) Height: 20 3/8 (517.5) A. Gskt: [2] Attached F. Gskt: [1] Included Related To: LL2518 (Long-Life Media Version) PA2518 (Standard Media Version)</p>	<p>PA2522</p> 	<p>Inner Air Element Fits Inside: LL2521, PA2521 Fits: International Trucks; Thomas Buses Replaces: International 482644-C1 O.D.: 5 15/16 (150.8) I.D.: 21/32 (16.7) & 4 27/32 (123.0) Height: 13 7/8 (352.4) A. Gskt: [1] Attached F. Gskt: G103-N</p>
<p>PA2519</p> 	<p>Inner Air Element Fits Inside: LL2518, PA2518, PA2518XP Fits: Terex Equipment; Ingersoll-Rand, Joy, Sullair Compressors Replaces: Ingersoll-Rand 46981; Joy 360628328; Terex 9031711 O.D.: 7 5/8 (193.7) I.D.: 7/8 (22.2) & 6 1/16 (154.0) Height: 18 3/8 (466.7) A. Gskt: [1] Attached F. Gskt: [1] Included</p>	<p>PA2523</p> 	<p>Outer Air Element Fits: Allis Chalmers, White Equipment; Ford Trucks Use With: PA1912, PA1998 Replaces: Allis Chalmers 1325203; Ford E6HZ-9601-A O.D.: 7 15/16 (201.6) I.D.: 11/16 (17.5) & 5 3/8 (136.5) Height: 16 1/2 (419.1) A. Gskt: [1] Attached F. Gskt: G103-N</p>
<p>PA2520</p> 	<p>Outer Air Element Fits: International Buses, Trucks Use With: PA2586 Replaces: International 478974-C1 O.D.: 10 3/8 (263.5) I.D.: 6 1/32 (153.2) One End Height: 12 3/8 (314.3) A. Gskt: [1] Attached</p>	<p>PA2524-FN</p> 	<p>Outer Air Element with Fins Fits: Case, Hough, International Equipment Use With: PA2332 Replaces: International 690049-C1 O.D.: 6 7/8 (174.6) Fins 8 3/4 (222.3) I.D.: 21/32 (16.7) & 3 1/2 (88.9) Height: 15 3/8 (390.5) A. Gskt: [1] Attached F. Gskt: G103-N</p>
<p>LL2521</p> 	<p>Long Life Outer Air Element with Lift Tab Fits: International, Kenworth, Mercedes-Benz, Peterbilt Trucks; Thomas Buses Use With: PA2522 Replaces: International 476741-C1 O.D.: 10 3/8 (263.5) I.D.: 6 1/32 (153.2) One End Height: 16 7/16 (417.5) A. Gskt: [1] Attached Related To: PA2521 (Standard Media Version)</p>	<p>LL2525</p> 	<p>Long Life Outer Air Element with Lift Tabs Fits: International Buses, Trucks Use With: PA2526, PA3480 Replaces: International 470186-C91 O.D.: 12 1/32 (305.6) 12 3/32 (307.2) I.D.: 7 11/16 (195.3) One End Height: 18 1/2 (469.9) A. Gskt: [1] Attached Related To: PA2525 (Standard Media Version)</p>
<p>PA2521</p> 	<p>Outer Air Element Fits: International, Kenworth, Mercedes-Benz, Peterbilt Trucks; Thomas Buses Use With: PA2522 Replaces: International 476741-C1 O.D.: 10 3/8 (263.5) I.D.: 6 1/32 (153.2) One End Height: 16 7/16 (417.5) A. Gskt: [1] Attached Related To: LL2521 (Long-Life Media Version)</p>	<p>PA2525</p> 	<p>Outer Air Element with Lift Tabs Fits: International Buses, Trucks Use With: PA2526, PA3480 Replaces: International 470186-C91 O.D.: 12 1/32 (305.6) 12 3/32 (307.2) I.D.: 7 11/16 (195.3) One End Height: 18 1/2 (469.9) A. Gskt: [1] Attached Related To: LL2525 (Long-Life Media Version)</p>
		<p>PA2526</p> 	<p>Inner Air Element Fits Inside: LL2525, PA2525 Fits: Fram Optional Housings; International Trucks Replaces: International 482646-C91; Fram CA1599SY O.D.: 7 5/8 (193.7) I.D.: 21/32 (16.7) & 6 1/16 (154.0) Height: 15 7/8 (403.2) A. Gskt: [1] Attached F. Gskt: G103-N</p>

Measurements Are Shown In Inches And (Millimeters)

WARNING: These products can expose you to chemicals, including Diisononyl Phthalate, Carbon black extracts, Nickel, 1,3 Butadiene, Ethylene Oxide, Epichlorohydrin, which are known to the State of California to cause cancer, and Bisphenol, Ethylene Glycol, Ethylene Oxide, 1,3 Butadiene, Epichlorohydrin, which are known to the State of California to cause birth defects or other reproductive harm. For more information go to www.P65Warnings.ca.gov.

PA2527 Air Element
Replaces: Caterpillar 3I0177; GMC 25096334
O.D.: 6 7/8 (174.6)
I.D.: 2 1/32 (16.7) & 3 1/2 (88.9)
Height: 13 7/16 (341.3)
A. Gskt: [1] Attached
F. Gskt: G103-N, [1] Wing Nut



PA2532 Air Element
Fits: Detroit Diesel Engines; GMC Trucks
Replaces: GMC 2030100
O.D.: 9 (228.6)
I.D.: 5 11/16 (144.5)
Height: 28 1/2 (723.9)
A. Gskt: [2] Attached
O. Gskt: G472-AF



PA2528 Air Element
Fits: Sullair Compressors
Replaces: Sullair 40853
O.D.: 8 1/2 (215.9)
I.D.: 7/16 (11.1) & 4 1/16 (103.2)
Height: 14 1/16 (357.2)
A. Gskt: [1] Attached
F. Gskt: [1] Included



PA2533 Air Element with Lid and 6 Bolt Holes
Fits: Ford Buses, Trucks
Replaces: Ford D5HZ-9601-A
O.D.: 12 1/32 (305.6)
 Lid 14 3/16 (360.4)
I.D.: 6 23/32 (170.7) One End
Height: 16 1/2 (419.1)
A. Gskt: [1] Attached



PA2529 Outer Air Element
Fits: John Deere, New Holland Equipment
Use With: PA2530
Replaces: John Deere AR80652
O.D.: 9 1/16 (230.2)
I.D.: 3/8 (9.5) & 5 3/8 (136.5)
Height: 19 5/8 (498.5)
A. Gskt: [1] Attached
F. Gskt: [1] Included



PA2534 Cab Air Element
Fits: Caterpillar, Elgin, Owatonna Equipment
Replaces: Caterpillar 8P5142; Thermo King 2052B70G01
Length: 17 (431.8)
Width: 10 (254.0)
Height: 2 3/16 (55.6)



PA2530 Inner Air Element
Fits Inside: PA2529
Fits: Hitachi, John Deere Equipment
Replaces: John Deere AR80653; Kobelco 2446U249S1
O.D.: 5 5/32 (131.0)
I.D.: 5/8 (15.9) & 4 1/32 (102.4)
Height: 16 5/32 (410.4)
A. Gskt: [1] Attached
F. Gskt: G103-N



PA2535 Inner Air Element
Fits Inside: PA1907-FN
Fits: Bobcat Loaders; Massey Ferguson Industrial Equipment, Wheel Tractors
Replaces: Massey Ferguson 523419-M91
O.D.: 2 3/8 (60.3)
 Flange 4 1/2 (114.3)
I.D.: 13/32 (10.3) & 2 (50.8)
Height: 8 15/32 (215.1)
A. Gskt: [2] Attached
F. Gskt: [1] Included



PA2531 Air Element
Fits: Detroit Diesel Engines; GMC Trucks
Replaces: GMC 2050330
O.D.: 9 (228.6)
I.D.: 5 11/16 (144.5)
Height: 22 19/32 (573.9)
A. Gskt: [2] Attached
O. Gskt: G472-AF



PA2536 Air Element
Contains: Flame Retardant Media
Fits: Nissan Automotive; Datsun, Nissan Lift Trucks
Replaces: Nissan 16546-76015, 16546-L3000
O.D.: 5 1/4 (133.4)
I.D.: 3/8 (9.5) & 2 27/32 (72.2)
Height: 6 23/32 (170.7)
F. Gskt: [1] Included













PA2538 Outer Air Element
Fits: Agco, Dresser, Hough, International, Massey Ferguson, White Equipment
Use With: PA2539
Replaces: International 935694-C1
O.D.: 10 3/8 (263.5)
I.D.: 2 1/32 (16.7) & 6 1/32 (153.2)
Height: 16 1/2 (419.1)
A. Gskt: [1] Attached
F. Gskt: G103-N



Measurements Are Shown In Inches And (Millimeters)

WARNING: These products can expose you to chemicals, including Diisononyl Phthalate, Carbon black extracts, Nickel, 1,3 Butadiene, Ethylene Oxide, Epichlorohydrin, which are known to the State of California to cause cancer, and Bisphenol, Ethylene Glycol, Ethylene Oxide, 1,3 Butadiene, Epichlorohydrin, which are known to the State of California to cause birth defects or other reproductive harm. For more information go to www.P65Warnings.ca.gov.

<p>PA2539</p>  <p>Inner Air Element Fits Inside: PA2538, PA2777 Fits: Agco, Case, Dresser, Hough, International Equipment Replaces: Case A171256; International 935693-C1 O.D.: 5 15/16 (150.8) I.D.: 2 1/32 (16.7) & 4 27/32 (123.0) Height: 14 1/2 (368.3) A. Gskt: [1] Attached F. Gskt: G103-N</p>	<p>PA2545</p>  <p>Inner Air Element Fits Inside: PA2504, PA2779 Fits: Ag-Chem, Caterpillar, Clark, Hitachi, Kawasaki, Timberjack Equipment; GMC, International, Isuzu, Nissan Buses, Trucks Replaces: GMC 94037809; Isuzu 1-14215-078-1; Nissan D6546-Z9006 O.D.: 5 11/16 (144.5) I.D.: 1 1/16 (17.5) & 4 19/32 (116.7) Height: 12 3/8 (314.3) A. Gskt: [1] Attached F. Gskt: G103-N</p>
<p>PA2540</p>  <p>Conical-Shaped Air Element Fits: GMC, Mack Trucks; Caterpillar Loaders Replaces: GMC 25040529; Mack 57MD27 O.D.: 5 3/4 (146.0) to 8 21/32 (219.9) I.D.: 5 3/16 (131.8) Height: 16 (406.4) A. Gskt: [2] Attached F. Gskt: [1] Included Related To: PA2500 (Long Version)</p>	<p>PA2546</p>  <p>Outer Air Element Fits: Dresser, Ford, Hitachi, John Deere Equipment Use With: PA2547 Replaces: John Deere AR79679 O.D.: 9 3/32 (231.0) I.D.: 1/2 (12.7) & 5 7/32 (132.6) Height: 17 (431.8) A. Gskt: [1] Attached F. Gskt: [1] Included</p>
<p>PA2541-FN</p>  <p>Outer Air Element with Fins Fits: Benfra, Demag, Fiat-Allis, Hanomag, Massey Ferguson, New Holland Equipment Use With: PA2332 Replaces: Benfra 40155; Demag 5150574; Fiat-Allis 79049791; Massey Ferguson 1428739-M91 O.D.: 5 1/4 (133.4) Fins 6 3/8 (161.9) I.D.: 2 1/32 (16.7) & 3 5/8 (92.1) Height: 15 15/32 (392.9) A. Gskt: [1] Attached F. Gskt: G103-N</p>	<p>PA2547</p>  <p>Inner Air Element Fits Inside: PA2546 Fits: Dresser, Hitachi, John Deere Equipment Replaces: John Deere AR79680 O.D.: 4 21/32 (118.3) I.D.: 2 1/32 (16.7) & 3 15/16 (100.0) Height: 14 19/32 (370.7) A. Gskt: [1] Attached F. Gskt: G103-N</p>
<p>PA2542</p>  <p>Outer Air Element with Lift Bars Fits: Dresser, International Equipment Use With: PA2543 Replaces: International 627114-C1 O.D.: 6 19/32 (167.5) I.D.: 3 21/32 (92.9) One End Height: 17 3/16 (436.6) A. Gskt: [1] Attached</p>	<p>PA2548</p>  <p>Air Element with Lid and Air Restriction Gauge Fitting Fits: Ford Trucks Replaces: Ford F6HZ-9601-B O.D.: 10 (254.0) Lid 12 (304.8) I.D.: 17/32 (13.5) & 4 15/16 (125.4) Height: 8 1/16 (204.8) A. Gskt: [1] Attached F. Gskt: [1] Washer</p>
<p>PA2544</p>  <p>Air Element with Lid and 6 Bolt Holes Fits: WhiteGMC Trucks Replaces: White 22-005009 O.D.: 13 7/8 (352.4) Lid 16 1/8 (409.6) I.D.: 7 7/16 (188.9) One End Height: 16 1/32 (407.2) A. Gskt: [2] Attached</p>	<p>PA2550</p>  <p>Air Element Fits: GMC Trucks Replaces: GMC 2054757 O.D.: 8 27/32 (224.6) I.D.: 5 15/32 (138.9) One End Height: 15 (381.0) A. Gskt: [2] Attached F. Gskt: G207-AF</p>

Measurements Are Shown In Inches And (Millimeters)

WARNING: These products can expose you to chemicals, including Diisononyl Phthalate, Carbon black extracts, Nickel, 1,3 Butadiene, Ethylene Oxide, Epichlorohydrin, which are known to the State of California to cause cancer, and Bisphenol, Ethylene Glycol, Ethylene Oxide, 1,3 Butadiene, Epichlorohydrin, which are known to the State of California to cause birth defects or other reproductive harm. For more information go to www.P65Warnings.ca.gov.

PA2551 Outer Air Element with Bail Handle
Fits: International Wheel Tractors
Use With: PA2332
Replaces: International 71912-C1
O.D.: 6 27/32 (173.8)
I.D.: 3 15/32 (88.1) One End
Height: 15 3/8 (390.5)
A. Gskt: [1] Attached



LL2557 Long Life Air Element
Fits: Caterpillar Industrial Engines
Replaces: Caterpillar 7N1225
O.D.: 10 3/8 (263.5)
I.D.: 6 1/32 (153.2) One End
Height: 9 1/2 (241.3)
A. Gskt: [1] Attached
Related To: PA2557 (Standard Media Version)



PA2552 Air Element
Replaces: International 466400-C1
O.D.: 12 5/8 (320.7)
I.D.: 8 13/32 (213.5)
Height: 8 5/8 (219.1)
A. Gskt: [2] Attached



PA2557 Air Element
Fits: Caterpillar Industrial Engines
Replaces: Caterpillar 7N1225
O.D.: 10 3/8 (263.5)
I.D.: 6 1/32 (153.2) One End
Height: 9 1/2 (241.3)
A. Gskt: [1] Attached
Related To: LL2557 (Long-Life Media Version)



PA2554 Panel Air Element
Notes: Do NOT use in cab air ventilation systems.
Fits: Caterpillar Industrial, Marine Engines
Use With: PA2554 FOAM
Replaces: Caterpillar 4N15, 4N0015
Length: 15 (381.0)
Width: 15 (381.0)
Height: 5 1/2 (139.7)



PA2558 Air Element
Fits: Mack Trucks
Replaces: Mack 2MD4004, 57MD32
O.D.: 8 27/32 (224.6)
I.D.: 11/16 (17.5) & 5 15/32 (138.9)
Height: 7 1/2 (190.5)
A. Gskt: [1] Attached
F. Gskt: G103-N



PA2554 FOAM Foam Blanket for PA2554
Use With: PA2554
Length: 24 (609.6)
Width: 15 (381.0)
Height: 1/2 (12.7)



LL2559 Long Life Air Element
Replaces: GMC 25041976
O.D.: 13 7/8 (352.4)
I.D.: 7 7/16 (188.9) One End
Height: 24 (609.6)
A. Gskt: [2] Attached
F. Gskt: G145-AF
Related To: PA2559 (Standard Media Version)



PA2555 Inter-Cooler Air Element
Notes: Sometimes used with PA2556.
Replaces: GMC 25042417; Mack 57MD29305P1
O.D.: 10 13/32 (264.3)
I.D.: 6 15/16 (176.2)
Height: 12 (304.8)
A. Gskt: [2] Attached



PA2559 Air Element
Replaces: GMC 25041976
O.D.: 13 7/8 (352.4)
I.D.: 7 7/16 (188.9) One End
Height: 24 (609.6)
A. Gskt: [2] Attached
F. Gskt: G145-AF
Related To: LL2559 (Long-Life Media Version)



PA2556 Inter-Cooler Air Element
Notes: Sometimes used with PA2555.
Replaces: GMC 25042415; Mack 57MD29305P2
O.D.: 10 3/8 (263.5)
I.D.: 6 1/32 (153.2)
Height: 15 (381.0)
A. Gskt: [2] Attached



LL2562 Long Life Outer Air Element with Bail Handle
Fits: Ingersoll-Rand Compressors; Hitachi, Koehring, Liebherr, Terex, Volvo, WABCO Equipment
Use With: PA2563
Replaces: Hitachi 4206272; Ingersoll-Rand 35298108; WABCO VE1062
O.D.: 14 11/16 (373.1)
I.D.: 29/32 (23.0) & 10 11/32 (262.7)
Height: 24 1/2 (622.3)
A. Gskt: [1] Attached
F. Gskt: [1] Included
Related To: PA2562 (Standard Media Version)
 PA2562XP (Extreme Performance Nano Version)



Measurements Are Shown In Inches And (Millimeters)

WARNING: These products can expose you to chemicals, including Diisononyl Phthalate, Carbon black extracts, Nickel, 1,3 Butadiene, Ethylene Oxide, Epichlorohydrin, which are known to the State of California to cause cancer, and Bisphenol, Ethylene Glycol, Ethylene Oxide, 1,3 Butadiene, Epichlorohydrin, which are known to the State of California to cause birth defects or other reproductive harm. For more information go to www.P65Warnings.ca.gov.

PA2562



Outer Air Element with Bail Handle
Fits: Ingersoll-Rand Compressors; Hitachi, Koehring, Liebherr, Terex, Volvo, Wabco Equipment
Use With: PA2563
Replaces: Hitachi 4206272; Ingersoll-Rand 35298108; WABCO VE1062
O.D.: 14 11/16 (373.1)
I.D.: 29/32 (23.0) & 10 11/32 (262.7)
Height: 24 1/2 (622.3)
A. Gskt: [1] Attached
F. Gskt: [1] Included
Related To: LL2562 (Long-Life Media Version) PA2562XP (Extreme Performance Nano Version)

PA2562XP



Extreme Performance Nano Outer Air Element with Bail Handle
Fits: Ingersoll-Rand Compressors; Hitachi, Koehring, Liebherr, Terex, Volvo, Wabco Equipment
Use With: PA2563
Replaces: Hitachi 4206272; Ingersoll-Rand 35298108; WABCO VE1062
O.D.: 14 11/16 (373.1)
I.D.: 29/32 (23.0) & 10 11/32 (262.7)
Height: 24 1/2 (622.3)
A. Gskt: [1] Attached
F. Gskt: [1] Included
Related To: LL2562 (Long-Life Media Version) PA2562 (Standard Media Version)

PA2563



Inner Air Element
Fits Inside: LL2562, PA2562, PA2562XP, PA2849
Fits: Caterpillar, Hitachi, Ingersoll-Rand, Koehring, Terex, Wabco Equipment
Replaces: Caterpillar 1N4864; Ingersoll-Rand 35298116; WABCO VE1061
O.D.: 10 1/4 (260.3)
I.D.: 29/32 (23.0) & 9 1/8 (231.8)
Height: 22 1/2 (571.5)
A. Gskt: [1] Attached
F. Gskt: [1] Included

PA2564

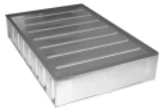

DynaCell Air Element Replacement
Notes: Both sides are open.
Replaces: Caterpillar 7C8343; Farr C49812, T528D; Ford D8HZ-9601-D; GMC 25040430; White 22-0050004
Length: 28 1/2 (723.9)
Width: 19 (482.6)
Height: 5 3/8 (136.5)
Related To: PA2444 (Sides are Closed)

PA2566



Air Element
Fits: Design Engineering Optional Equipment
Replaces: Design Engineering DEP1126
O.D.: 9 5/8 (244.5)
I.D.: 3/8 (9.5) & 5 (127.0)
Height: 10 5/32 (258.0)
A. Gskt: [1] Attached
F. Gskt: [1] Included

PA2567



Outer Air Element
Fits: White Equipment
Use With: PA2568
Replaces: White 30-3216535
O.D.: 9 1/16 (230.2)
I.D.: 15/16 (23.8) & 5 3/8 (136.5)
Height: 17 3/8 (441.3)
A. Gskt: [1] Attached
F. Gskt: [1] Included

PA2568



Inner Air Element
Fits Inside: PA2567
Fits: White Equipment
Replaces: White 30-3216543
O.D.: 5 1/4 (133.4)
I.D.: 5/8 (15.9) & 4 1/8 (104.8)
Height: 15 1/2 (393.7)
A. Gskt: [1] Included
F. Gskt: G103-N

PA2569



Outer Air Element with Lift Tab
Fits: Ford Tractors
Use With: PA2435
Replaces: Ford D5NN-9B618-B
O.D.: 9 (228.6)
Boot 10 (254.0)
I.D.: 1/2 (12.7) & 5 11/16 (144.5)
Height: 16 3/8 (415.9)
A. Gskt: [2] Attached
F. Gskt: [1] Included

PA2570



Inner Air Element
Fits Inside: LL1681-FN, PA1681-FN, PA1882, PA2666, PA2709
Fits: Bobcat, Gehl, John Deere Equipment; Tymo Sweepers
Replaces: Gehl 131853; John Deere AT44378
O.D.: 3 3/8 (85.7)
Flange 4 5/32 (105.6)
I.D.: 5/8 (15.9) & 2 29/32 (73.8)
Height: 11 3/32 (281.8)
A. Gskt: [1] Attached
F. Gskt: G103-N

PA2571



Air Element
Replaces: GMC 25041990, 25166966
O.D.: 12 3/4 (323.8)
I.D.: 8 11/32 (211.9) One End
Height: 17 (431.8)
A. Gskt: [2] Attached
F. Gskt: G25-AF

PA2572



Cab Air Element
Fits: Caterpillar Equipment
Replaces: Caterpillar 6P1290
Length: 25 1/2 (647.7)
Width: 6 1/16 (154.0)
Height: 2 3/16 (55.6)

Measurements Are Shown In Inches And (Millimeters)

WARNING: These products can expose you to chemicals, including Diisononyl Phthalate, Carbon black extracts, Nickel, 1,3 Butadiene, Ethylene Oxide, Epichlorohydrin, which are known to the State of California to cause cancer, and Bisphenol, Ethylene Glycol, Ethylene Oxide, 1,3 Butadiene, Epichlorohydrin, which are known to the State of California to cause birth defects or other reproductive harm. For more information go to www.P65Warnings.ca.gov.

PA2573 Outer Air Element
Fits: Ag-Chem, Dynapac, Tamrock, V.M.E., Volvo Equipment; Sullair Compressors
Use With: PA2574
Replaces: Ag-Chem 700282; Dynapac 499505; Sullair 46299; V.M.E. M12565177
O.D.: 13 13/16 (350.8)
I.D.: 15/16 (23.8) & 9 1/2 (241.3)
Height: 20 1/2 (520.7)
A. Gskt: [1] Attached
F. Gskt: G285-AF, [1] Included
Related To: PA2573XP (Extreme Performance Nano Version)



PA2573XP Extreme Performance Nano Outer Air Element
Fits: Ag-Chem, Dynapac, Tamrock, V.M.E., Volvo Equipment; Sullair Compressors
Use With: PA2574
Replaces: Ag-Chem 700282; Dynapac 499505; Sullair 46299; V.M.E. M12565177
O.D.: 13 13/16 (350.8)
I.D.: 15/16 (23.8) & 9 1/2 (241.3)
Height: 20 1/2 (520.7)
A. Gskt: [1] Attached
F. Gskt: G285-AF, [1] Included
Related To: PA2573 (Standard Media Version)



PA2574 Inner Air Element
Fits Inside: PA2573, PA2573XP
Fits: Ag-Chem, Dynapac, Tamrock, V.M.E., Volvo Equipment; Sullair Compressors
Replaces: Ag-Chem 700270; Dynapac 499509; Sullair 47523; V.M.E. M12565176
O.D.: 8 5/8 (219.1)
I.D.: 15/16 (23.8) & 7 1/16 (179.4)
Height: 18 1/2 (469.9)
A. Gskt: [1] Attached
F. Gskt: [1] Included



LL2575 Long Life Outer Air Element
Fits: Caterpillar Equipment, Lift Trucks
Use With: PA2576, PA2730
Replaces: Caterpillar 7N9028, 8N5504
O.D.: 8 3/8 (212.7)
I.D.: 4 (101.6) One End
Height: 5 27/32 (148.4)
A. Gskt: [1] Attached
Related To: PA2575 (Standard Media Version)



PA2575 Outer Air Element
Fits: Caterpillar Equipment
Use With: PA2576, PA2730
Replaces: Caterpillar 7N9028, 8N5504
O.D.: 8 3/8 (212.7)
I.D.: 4 (101.6) One End
Height: 5 27/32 (148.4)
A. Gskt: [1] Attached
Related To: LL2575 (Long-Life Media Version)



PA2576 Inner Air Element with 6 Bolts
Fits Inside: LL2575, PA2575
Fits: Caterpillar Equipment
Replaces: Caterpillar 7N9027
O.D.: 3 3/4 (95.3)
 Flange 6 11/16 (169.9)
I.D.: 2 5/8 (66.7) One End
Height: 5 1/8 (130.2)
F. Gskt: [1] Included



PA2577 Outer Air Element
Fits: GMC, Isuzu, Nissan Buses, Trucks; Hitachi, John Deere, Kobelco, Komatsu, Link-Belt, MDI/Yutani, Mitsubishi, Timberjack, Timbco Equipment
Use With: PA2578
Replaces: GMC 94048864; Hitachi 4288963; Isuzu 1-14214-126-0; John Deere T52223; Kobelco 2446U191-S3; Mitsubishi ME063130; Nissan 16546-96071; Timberjack 8410616
O.D.: 10 27/32 (275.4)
I.D.: 15/16 (23.8) & 6 1/2 (165.1)
Height: 15 1/2 (393.7)
A. Gskt: [1] Attached
F. Gskt: [1] Included



PA2578 Inner Air Element
Fits Inside: PA2577
Fits: GMC, Isuzu, Nissan Buses, Trucks; Hitachi, John Deere, Kobelco, Komatsu, MDI/Yutani, Timberjack, Timbco Equipment
Replaces: GMC 25096436; Isuzu 1-14215-125-1; John Deere T52224; Nissan 16546-96072
O.D.: 6 3/8 (161.9)
I.D.: 5/8 (15.9) & 5 9/32 (134.1)
Height: 14 3/8 (365.1)
A. Gskt: [1] Attached
F. Gskt: G103-N



PA2579 Inner Air Element
Fits Inside: LL2330, PA2330, PA2612
Fits: International Trucks
Replaces: GMC 25096133; International 530560-C1
O.D.: 7 3/16 (182.6)
I.D.: 21/32 (16.7) & 5 11/16 (144.5)
Height: 14 3/8 (365.1)
A. Gskt: [1] Attached
F. Gskt: G103-N



PA2580 Air Element
Contains: Flame Retardant Media
Fits: R.V.I. Trucks
Replaces: GMC 9093553
O.D.: 12 3/4 (323.8)
I.D.: 8 11/32 (211.9)
Height: 23 1/2 (596.9)
A. Gskt: [1] Attached













PA2581 Air Element
Fits: Cummins, Deutz, Perkins Engines; Ford Trucks; Leyland Buses
Replaces: Cummins 650931; Leyland 37H3737
O.D.: 7 15/16 (201.6)
I.D.: 11/16 (17.5) & 3 9/16 (90.5)
Height: 13 3/8 (339.7)
A. Gskt: [1] Attached
F. Gskt: G103-N



Measurements Are Shown In Inches And (Millimeters)

WARNING: These products can expose you to chemicals, including Diisononyl Phthalate, Carbon black extracts, Nickel, 1,3 Butadiene, Ethylene Oxide, Epichlorohydrin, which are known to the State of California to cause cancer, and Bisphenol, Ethylene Glycol, Ethylene Oxide, 1,3 Butadiene, Epichlorohydrin, which are known to the State of California to cause birth defects or other reproductive harm. For more information go to www.P65Warnings.ca.gov.

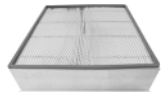
<p>LL2582 Long Life Outer Air Element Fits: Case, Champion, Hitachi, John Deere, Kawasaki, Kobelco, V.M.E., Volvo Equipment Use With: PA2583, PA3896 Replaces: Case 150783A1; Champion 37398; John Deere AT136708; Kawasaki 30981-70100 O.D.: 10 27/32 (275.4) I.D.: 15/16 (23.8) & 6 1/2 (165.1) Height: 20 1/2 (520.7) A. Gskt: [1] Attached F. Gskt: [1] Included Related To: PA2582 (Standard Media Version)</p> 	<p>PA2587 Outer Air Element Fits: Ford, Koehring, New Holland Equipment Use With: PA2588 Replaces: Ford D5NN-9B618-A; Koehring 8825161 O.D.: 5 5/16 (134.9) Boot 5 3/4 (146.0) I.D.: 7/16 (11.1) & 3 1/16 (77.8) Height: 14 21/32 (372.3) A. Gskt: [2] Attached F. Gskt: [1] Included</p> 
<p>PA2582 Outer Air Element Fits: Case, Champion, Hitachi, John Deere, Kawasaki, Kobelco, V.M.E., Volvo Equipment Use With: PA2583, PA3896 Replaces: Case 150783A1; Champion 37398; John Deere AT136708; Kawasaki 30981-70100 O.D.: 10 27/32 (275.4) I.D.: 15/16 (23.8) & 6 1/2 (165.1) Height: 20 1/2 (520.7) A. Gskt: [1] Attached F. Gskt: [1] Included Related To: LL2582 (Long-Life Media Version)</p> 	<p>PA2588 Inner Air Element Fits Inside: PA2587 Fits: Ford, Koehring, New Holland Equipment Replaces: Ford D6NN-9R500-B; Koehring 8825162 O.D.: 2 15/16 (74.6) I.D.: 1/2 (12.7) & 2 13/32 (61.1) Height: 13 3/8 (339.7) A. Gskt: [1] Attached F. Gskt: [1] Included</p> 
<p>PA2583 Inner Air Element Fits Inside: LL2582, PA2582 Fits: Case, Champion, FMC, Hitachi, John Deere, Kawasaki, Kobelco, Kubota, Volvo Equipment Replaces: Champion 37399; John Deere AT136707; Kubota 12499-11210 O.D.: 6 3/8 (161.9) I.D.: 5/8 (15.9) & 5 9/32 (134.1) Height: 19 1/2 (495.3) A. Gskt: [1] Attached F. Gskt: G103-N</p> 	<p>PA2589-FN Air Element with Fins Fits: Kubota Tractors Replaces: Kubota 70000-17500 O.D.: 6 3/32 (154.8) Fins 7 13/16 (198.4) I.D.: 1/2 (12.7) & 3 15/32 (88.1) Height: 6 3/32 (154.8) A. Gskt: [1] Attached F. Gskt: [1] Included</p> 
<p>PA2585 Air Element with Air Restriction Gauge Fitting Fits: Ford Buses, Trucks Replaces: Ford D6HZ-9601-A O.D.: 9 7/32 (234.2) 9 5/16 (236.5) I.D.: 17/32 (13.5) & 4 27/32 (123.0) Height: 9 1/32 (229.4) A. Gskt: [1] Attached F. Gskt: [1] Included</p> 	<p>PA2591 Outer Air Element with Lift Tab Fits: Case, International Tractors Use With: PA2510 Replaces: Case A45694 O.D.: 10 3/8 (263.5) Boot 11 (279.4) I.D.: 21/32 (16.7) & 6 1/32 (153.2) Height: 18 3/8 (466.7) A. Gskt: [2] Attached F. Gskt: G103-N, [1] Wing Nut</p> 
<p>PA2586 Inner Air Element Fits Inside: PA2520 Fits: Caterpillar Marine Engines; International Trucks Replaces: Caterpillar 8N5006 O.D.: 5 15/16 (150.8) I.D.: 21/32 (16.7) & 4 27/32 (123.0) Height: 9 5/8 (244.5) A. Gskt: [1] Attached</p> 	<p>PA2592 Air Element for Pressurized Cab Fits: Caterpillar Equipment Replaces: Caterpillar 2V0036, 2V36 O.D.: 6 5/8 (168.3) I.D.: 4 1/4 (108.0) One End Height: 9 9/32 (235.7) A. Gskt: [1] Attached</p> 
	<p>PA2593 Panel Air Element Replaces: International 947965-C2 Length: 19 1/2 (495.3) Width: 19 1/2 (495.3) Height: 5 9/16 (141.3)</p> 

Measurements Are Shown In Inches And (Millimeters)

WARNING: These products can expose you to chemicals, including Diisononyl Phthalate, Carbon black extracts, Nickel, 1,3 Butadiene, Ethylene Oxide, Epichlorohydrin, which are known to the State of California to cause cancer, and Bisphenol, Ethylene Glycol, Ethylene Oxide, 1,3 Butadiene, Epichlorohydrin, which are known to the State of California to cause birth defects or other reproductive harm. For more information go to www.P65Warnings.ca.gov.

PA2595 Outer Air Element with Lid
Replaces: White 22-0050010
O.D.: 12 3/4 (323.8)
 Lid 16 1/8 (409.6)
I.D.: 7 7/16 (188.9) One End
Height: 18 13/32 (467.5)
A. Gskt: [2] Attached



PA2604 Outer Air Element
Fits: LeRoi Compressors
Use With: PA2605
Replaces: LeRoi 43-654
O.D.: 11 1/2 (292.1)
I.D.: 13/32 (10.3) & 7 1/4 (184.2)
Height: 15 7/8 (403.2)
A. Gskt: [1] Attached
F. Gskt: [1] Included



PA2596 Air Element
Fits: Ford, GMC Buses, Trucks
Replaces: Ford E0HT-9600-B; GMC 25041370
O.D.: 12 3/32 (307.2)
I.D.: 8 11/16 (220.7)
Height: 8 (203.2)
A. Gskt: [2] Attached



PA2605 Inner Air Element
Fits Inside: PA261
Fits: Massey Ferguson Wheel Tractors
Replaces: Massey Ferguson 1044274-M91
O.D.: 6 7/8 (174.6)
I.D.: 21/32 (16.7) & 5 9/16 (141.3)
Height: 14 3/8 (365.1)
A. Gskt: [1] Attached
F. Gskt: G103-N



PA2598 Air Element
Fits: Design Engineering Optional Equipment
Replaces: Design Engineering DEP1226
O.D.: 9 11/32 (237.3)
I.D.: 3/8 (9.5) & 6 1/4 (158.8)
Height: 10 1/8 (257.2)
A. Gskt: [1] Attached
F. Gskt: [1] Included



PA2606 Outer Air Element with Lift Tab
Fits: Franklin Loggers
Use With: PA2607
Replaces: Franklin 1504917
O.D.: 9 (228.6)
 Boot 10 (254.0)
I.D.: 5 11/16 (144.5) One End
Height: 13 9/16 (344.5)
A. Gskt: [2] Attached



PA2599 Air Element
Fits: Ford, GMC Buses, Trucks
Replaces: Ford E0HZ-9601-B; GMC 25041372
O.D.: 12 1/32 (305.6)
I.D.: 6 23/32 (170.7)
Height: 8 (203.2)
A. Gskt: [2] Attached



PA2607 Inner Air Element
Fits Inside: PA2606
Fits: Franklin Loggers
Replaces: Franklin 1504918
O.D.: 5 9/16 (141.3)
I.D.: 13/32 (10.3) & 4 1/2 (114.3)
Height: 12 1/2 (317.5)
F. Gskt: G15-AF



PA2601 Cab Air Element
Fits: New Holland, Versatile Tractors
Replaces: New Holland V30986; Versatile 30986
Length: 44 (1117.6)
Width: 4 (101.6)
Height: 2 9/16 (65.1)
A. Gskt: [1] Attached



LL2608 Long Life Air Element
Fits: Peterbilt Trucks with Vortex Housing
Replaces: GMC 25096184; Vortex VF160R
O.D.: 12 3/4 (323.8)
I.D.: 21/32 (16.7) & 8 11/32 (211.9)
Height: 27 (685.8)
A. Gskt: [2] Attached
F. Gskt: [1] Included
Related To: PA2608 (Standard Media Version)















PA2602 Inner Air Element
Fits Inside: LL2344-FN, PA2344-FN
Fits: Case, Ford, Gehl, John Deere, New Holland, Thomas Equipment
Replaces: Case D82775; Ford 9809915; Gehl 263638; John Deere MG272744; New Holland 221688
O.D.: 2 3/8 (60.3)
 Flange 4 1/2 (114.3)
I.D.: 21/32 (16.7) & 2 (50.8)
Height: 13 1/4 (336.5)
A. Gskt: [2] Attached
F. Gskt: G103-N



Measurements Are Shown In Inches And (Millimeters)

WARNING: These products can expose you to chemicals, including Diisononyl Phthalate, Carbon black extracts, Nickel, 1,3 Butadiene, Ethylene Oxide, Epichlorohydrin, which are known to the State of California to cause cancer, and Bisphenol, Ethylene Glycol, Ethylene Oxide, 1,3 Butadiene, Epichlorohydrin, which are known to the State of California to cause birth defects or other reproductive harm. For more information go to www.P65Warnings.ca.gov.

<p>PA2608</p>  <p>Air Element Notes: Inside-Out Flow Direction Fits: Peterbilt Trucks; Vortox Housings Replaces: GMC 25096184; Vortox VF160R O.D.: 12 3/4 (323.8) I.D.: 21/32 (16.7) & 8 11/32 (211.9) Height: 27 (685.8) A. Gskt: [2] Attached F. Gskt: [1] Included Related To: LL2608 (Long-Life Media Version)</p>	<p>PA2613</p>  <p>Cab Air Element Fits: Caterpillar Equipment Replaces: Caterpillar 7G8116 O.D.: 6 3/32 (154.8) I.D.: 21/32 (16.7) & 3 15/32 (88.1) Height: 7 9/32 (184.9) A. Gskt: [1] Attached F. Gskt: [1] Wing Nut</p>
<p>LL2609</p>  <p>Long Life Outer Air Element Fits: Caterpillar Industrial Engines, Equipment Use With: PA2385, PA2625 Replaces: Caterpillar 1W2516 O.D.: 12 1/2 (317.5) I.D.: 9 1/8 (231.8) One End Height: 19 (482.6) A. Gskt: [1] Attached Related To: PA2609 (Standard Media Version)</p>	<p>PA2614</p>  <p>Outer Air Element with Lift Tab Fits: Massey Ferguson Wheel Tractors; Winpower Generators Use With: PA2615 Replaces: Massey Ferguson 1051374-M91 O.D.: 12 1/2 (317.5) I.D.: 13/32 (10.3) & 7 1/2 (190.5) Height: 22 1/4 (565.2) A. Gskt: [1] Attached F. Gskt: [1] Included</p>
<p>PA2609</p>  <p>Outer Air Element Fits: Caterpillar Industrial Engines, Equipment Use With: PA2385, PA2625 Replaces: Caterpillar 1W2516 O.D.: 12 1/2 (317.5) I.D.: 9 1/8 (231.8) One End Height: 19 (482.6) A. Gskt: [1] Attached Related To: LL2609 (Long-Life Media Version)</p>	<p>PA2615</p>  <p>Inner Air Element Fits Inside: PA2614 Fits: Massey Ferguson Wheel Tractors Replaces: Massey Ferguson 1051373-M91 O.D.: 7 3/8 (187.3) I.D.: 25/32 (19.8) & 6 1/8 (155.6) Height: 20 7/8 (530.2) A. Gskt: [1] Attached F. Gskt: G103-N</p>
<p>PA2610</p>  <p>Cab Air Element Fits: John Deere Equipment Replaces: John Deere AH115833 O.D.: 10 27/32 (275.4) I.D.: 21/32 (16.7) & 6 1/2 (165.1) Height: 7 1/2 (190.5) F. Gskt: G103-N</p>	<p>PA2616</p>  <p>Outer Air Element Fits: John Deere Graders Use With: PA2687 Replaces: Alliance ABPN10GAF1896M; Caterpillar 310331; General Motors 25177201; John Deere AT75035 O.D.: 10 3/8 (263.5) I.D.: 21/32 (16.7) & 6 1/32 (153.2) Height: 13 3/8 (339.7) A. Gskt: [1] Attached F. Gskt: G103-N Related To: PA2616XP (Extreme Performance Nano Version)</p>
<p>PA2611</p>  <p>Outer Air Element Fits: Massey Ferguson Wheel Tractors Use With: PA2605 Replaces: Massey Ferguson 1044273-M91 O.D.: 11 1/2 (292.1) I.D.: 13/32 (10.3) & 7 1/4 (184.2) Height: 15 11/16 (398.5) A. Gskt: [1] Attached F. Gskt: [1] Included</p>	<p>PA2616XP</p>  <p>Extreme Performance Nano Outer Air Element Fits: John Deere Graders Use With: PA2687 Replaces: Alliance ABPN10GAF1896M; Caterpillar 310331; General Motors 25177201; John Deere AT75035 O.D.: 10 3/8 (263.5) I.D.: 21/32 (16.7) & 6 1/32 (153.2) Height: 13 3/8 (339.7) A. Gskt: [1] Attached F. Gskt: G103-N Related To: PA2616 (Standard Media Version)</p>
<p>PA2612</p>  <p>Outer Air Element with Lift Tabs Fits: International Trucks Use With: PA2579 Replaces: International 494730-C91 O.D.: 12 1/32 (305.6) I.D.: 5/8 (15.9) & 7 11/16 (195.3) Height: 17 3/4 (450.9) A. Gskt: [2] Attached F. Gskt: G103-N</p>	<p>PA2617</p>  <p>Cab Air Element Fits: Case Equipment Replaces: Case F64318 Length: 38 (965.2) Width: 7 (177.8) Height: 2 3/16 (55.6)</p>

Measurements Are Shown In Inches And (Millimeters)

WARNING: These products can expose you to chemicals, including Diisononyl Phthalate, Carbon black extracts, Nickel, 1,3 Butadiene, Ethylene Oxide, Epichlorohydrin, which are known to the State of California to cause cancer, and Bisphenol, Ethylene Glycol, Ethylene Oxide, 1,3 Butadiene, Epichlorohydrin, which are known to the State of California to cause birth defects or other reproductive harm. For more information go to www.P65Warnings.ca.gov.

LL2618 Long Life Air Element with Lift Tabs
Fits: Cummins Engines
Replaces: Cummins 3013205
O.D.: 13 7/8 (352.4)
I.D.: 11/16 (17.5) & 7 7/16 (188.9)
Height: 18 1/2 (469.9)
A. Gskt: [1] Included
F. Gskt: G103-N
Related To: PA2618 (Standard Media Version)



PA2623 Conical-Shaped Air Element
Fits: Cummins Engines; International Trucks
Replaces: International 503647-C91
O.D.: 5 3/4 (146.0)
to 8 21/32 (219.9)
I.D.: 5 3/16 (131.8) One End
Height: 23 (584.2)
A. Gskt: [2] Attached
F. Gskt: [1] Included



PA2618 Air Element with Lift Tabs
Fits: Cummins Engines
Replaces: Cummins 3013205
O.D.: 13 7/8 (352.4)
I.D.: 11/16 (17.5) & 7 7/16 (188.9)
Height: 18 1/2 (469.9)
A. Gskt: [1] Included
F. Gskt: G103-N
Related To: LL2618 (Long-Life Media Version)



PA2624 Outer Air Element
Use With: PA2625
Replaces: Ingersoll-Rand 35254903
O.D.: 13 13/16 (350.8)
Boot 14 1/2 (368.3)
I.D.: 15/16 (23.8) & 9 1/2 (241.3)
Height: 15 1/2 (393.7)
A. Gskt: [2] Attached
F. Gskt: [1] Included



PA2619 Cab Air Element with Pull Tab
Fits: Case, International, New Holland, Versatile Equipment
Replaces: International 143481-C91; Versatile V105382
Length: 38 (965.2)
Width: 6 (152.4)
Height: 2 9/16 (65.1)
A. Gskt: [1] Attached
Related To: PA2407 (without Attached Gasket)



PA2625 Inner Air Element
Fits Inside: PA1815, LL2384, PA2384, PA2384XP, LL2609, PA2609, PA2624
Fits: Caterpillar Applications Converted from Flanged Air Systems Previously Using PA1797 or PA2385
Replaces: Ingersoll-Rand 35254895
O.D.: 8 5/8 (219.1)
I.D.: 15/16 (23.8) & 7 1/16 (179.4)
Height: 14 1/2 (368.3)
A. Gskt: [1] Attached
F. Gskt: [1] Included



PA2620 Outer Air Element with Lift Tab
Fits: Ford Tractors
Use With: PA2621
Replaces: Ford D8NN-9B618-AA
O.D.: 9 1/8 (231.8)
Boot 9 3/4 (247.7)
I.D.: 1/2 (12.7) & 5 13/16 (147.6)
Height: 18 1/2 (469.9)
A. Gskt: [2] Attached
F. Gskt: [1] Included, [1] Wing Nut



PA2626 Cab Air Element
Fits: Caterpillar Equipment
Replaces: Caterpillar 8P5343
Length: 23 1/2 (596.9)
Width: 6 (152.4)
Height: 2 3/16 (55.6)



PA2621 Inner Air Element
Fits Inside: PA2620, LL2688, PA2688
Fits: Case, Champion, Ford, Hitachi, John Deere, Komatsu, Volvo Equipment; Hino Trucks
Replaces: Case S238647; Ford D8NN-9R500-AA; Hino 17801-2460; John Deere AT81019; Komatsu 600-181-8370
O.D.: 5 23/32 (145.3)
I.D.: 11/16 (17.5) & 4 19/32 (116.7)
Height: 17 1/2 (444.5)
A. Gskt: [1] Attached
F. Gskt: G103-N



PA2627 Dual-Stage Air Element with Blanket and Screen
Replaces: Fram CA3440
O.D.: 9 9/16 (242.9)
I.D.: 5 1/8 (130.2)
Height: 11 19/32 (294.5)
Related To: PA1701 (One End Closed)

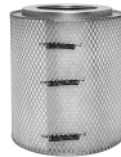

PA2622 Inner Air Element
Fits Inside: PA1794-FN
Fits: John Deere Tractors
Replaces: John Deere AL27160
O.D.: 3 3/8 (85.7)
Flange 4 5/32 (105.6)
I.D.: 21/32 (16.7) & 2 7/8 (73.0)
Height: 9 1/16 (230.2)
A. Gskt: [1] Attached
F. Gskt: [1] Included, [1] Wing Nut













PA2628 Air Element
Fits: Peterbilt Trucks
Replaces: GMC 25043068; Peterbilt 513200
O.D.: 9 1/2 (241.3)
I.D.: 6 1/2 (165.1)
Height: 28 1/2 (723.9)
A. Gskt: [2] Attached

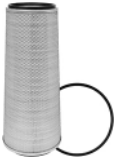

Measurements Are Shown In Inches And (Millimeters)

WARNING: These products can expose you to chemicals, including Diisononyl Phthalate, Carbon black extracts, Nickel, 1,3 Butadiene, Ethylene Oxide, Epichlorohydrin, which are known to the State of California to cause cancer, and Bisphenol, Ethylene Glycol, Ethylene Oxide, 1,3 Butadiene, Epichlorohydrin, which are known to the State of California to cause birth defects or other reproductive harm. For more information go to www.P65Warnings.ca.gov.

<p>PA2629</p>  <p>Outer Air Element with Lid Use With: PA2630 Replaces: GMC 25043813; Ingersoll-Rand 58179359; International 505633-C1 O.D.: 12 3/4 (323.8) Lid 16 1/8 (409.6) I.D.: 8 11/32 (211.9) One End Height: 19 17/32 (496.1) A. Gskt: [2] Attached</p>	<p>PA2634</p>  <p>Inner Air Element Fits Inside: PA2633-FN Fits: Case Equipment Replaces: Case A47033 O.D.: 4 3/32 (104.0) Flange 4 27/32 (123.0) I.D.: 25/32 (19.8) & 3 5/8 (92.1) Height: 13 3/32 (332.6) A. Gskt: [1] Attached F. Gskt: G103-N</p>
<p>PA2630</p>  <p>Inner Air Element Fits Inside: PA2629 Replaces: GMC 25096454; Ingersoll-Rand 58179367; International 501276-C1 O.D.: 8 1/4 (209.6) I.D.: 15/16 (23.8) & 7 1/8 (181.0) Height: 16 3/8 (415.9) A. Gskt: [1] Attached F. Gskt: [1] Included</p>	<p>PA2635-FN</p>  <p>Outer Air Element with Fins and Lid Fits: John Deere Tractors Use With: PA2644 Replaces: John Deere AL30394 O.D.: 6 11/32 (161.1) Lid 8 3/8 (212.7) I.D.: 5/8 (15.9) & 3 15/32 (88.1) Height: 14 5/8 (371.5) A. Gskt: [1] Attached F. Gskt: [1] Included, [1] Wing Nut</p>
<p>PA2631</p>  <p>Conical-Shaped Air Element Fits: Freightliner Buses, Trucks; New Flyer Transit Buses Replaces: Caterpillar 7C8320; GMC 8881300; International 594240-C1; Universal Coach T121022 O.D.: 9 25/32 (248.4) to 12 3/4 (323.8) I.D.: 8 11/32 (211.9) One End Height: 25 (635.0) A. Gskt: [2] Attached F. Gskt: G501-AF</p>	<p>PA2636</p>  <p>Air Element Contains: Flame Retardant Media Fits: Caterpillar Lift Trucks Replaces: Towmotor 348547 O.D.: 4 17/32 (115.1) I.D.: 2 1/4 (57.2) Height: 11 (279.4)</p>
<p>PA2632</p>  <p>Conical-Shaped Air Element Notes: Inside-Out Flow Direction Fits: Ford, Freightliner Buses, Trucks Replaces: Caterpillar 7C8318; Ford E2HZ-9601-A; GMC 25095857; Mack 57MD41M O.D.: 9 25/32 (248.4) to 12 3/4 (323.8) I.D.: 8 11/32 (211.9) One End Height: 29 (736.6) A. Gskt: [2] Attached F. Gskt: G501-AF</p>	<p>PA2637</p>  <p>Outer Air Element Fits: Case Tractors Replaces: Case A42758 O.D.: 6 5/8 (168.3) I.D.: 3/8 (9.5) & 4 11/32 (110.3) Height: 14 5/16 (363.5) A. Gskt: [1] Attached F. Gskt: [1] Included</p>
<p>PA2633-FN</p>  <p>Outer Air Element with Fins Fits: Case Equipment Use With: PA2634 Replaces: Case A47032 O.D.: 6 7/8 (174.6) Fins 8 13/16 (223.8) I.D.: 21/32 (16.7) & 4 3/16 (106.4) Height: 14 1/2 (368.3) A. Gskt: [1] Attached F. Gskt: G103-N</p>	<p>PA2638</p>  <p>Cab Air Element Fits: White Equipment Replaces: White 30-3175154 Length: 36 (914.4) Width: 6 1/2 (165.1) Height: 2 3/16 (55.6)</p>
	<p>PA2640</p>  <p>Outer Air Element Fits: Allis Chalmers Tractors Replaces: Allis Chalmers 259792 O.D.: 12 1/32 (305.6) I.D.: 5/8 (15.9) & 7 11/16 (195.3) Height: 19 1/2 (495.3) A. Gskt: [1] Attached F. Gskt: G103-N</p>

Measurements Are Shown In Inches And (Millimeters)

WARNING: These products can expose you to chemicals, including Diisononyl Phthalate, Carbon black extracts, Nickel, 1,3 Butadiene, Ethylene Oxide, Epichlorohydrin, which are known to the State of California to cause cancer, and Bisphenol, Ethylene Glycol, Ethylene Oxide, 1,3 Butadiene, Epichlorohydrin, which are known to the State of California to cause birth defects or other reproductive harm. For more information go to www.P65Warnings.ca.gov.

PA2641 Outer Air Element
Fits: Ford Trucks; Allis Chalmers, Deutz, Liebherr, Same, Yale Equipment
Use With: PA1912
Replaces: Deutz 4319263; Ford 83DB-9601-AA; Liebherr 7401993; Massey Ferguson 3074305-M1
O.D.: 9 7/32 (234.2)
I.D.: 2 1/32 (16.7) & 4 27/32 (123.0)
Height: 16 1/2 (419.1)
A. Gskt: [1] Included
F. Gskt: G103-N



PA2646 Inner Air Element
Fits Inside: PA2645
Fits: Massey Ferguson Wheel Tractors
Replaces: Massey Ferguson 1633720-M1
O.D.: 5 5/32 (131.0)
I.D.: 3/8 (9.5) & 4 1/32 (102.4)
Height: 11 1/2 (292.1)
A. Gskt: [1] Attached
F. Gskt: [1] Included



LL2642 Long Life Air Element
Fits: Ford Trucks
Replaces: Ford E2HZ-9601-B
O.D.: 13 7/8 (352.4)
I.D.: 1 11/16 (17.5) & 7 7/16 (188.9)
Height: 10 1/2 (266.7)
A. Gskt: [1] Attached
F. Gskt: G103-N
Related To: PA2642 (Standard Media Version)



PA2647 Inner Air Element with 10 Bolt Holes
Fits Inside: LL2384, PA2384, PA2384XP
Fits: Caterpillar Industrial, Marine Engines, Equipment; Ford Trucks
Replaces: Caterpillar 1W8161, 6N6444, 8N8934
O.D.: 8 5/8 (219.1)
 Flange 11 3/8 (288.9)
I.D.: 6 31/32 (177.0) One End
Height: 12 (304.8)
A. Gskt: [1] Attached



PA2642 Air Element
Fits: Ford Trucks
Replaces: Ford E2HZ-9601-B
O.D.: 13 7/8 (352.4)
I.D.: 1 11/16 (17.5) & 7 7/16 (188.9)
Height: 10 1/2 (266.7)
A. Gskt: [1] Attached
F. Gskt: G103-N
Related To: LL2642 (Long-Life Media Version)



PA2648 Air Element with Lid and 6 Bolt Holes
Fits: WhiteGMC Trucks
Replaces: White 22-0050013
O.D.: 13 7/8 (352.4)
 Lid 16 1/8 (409.6)
I.D.: 7 7/16 (188.9) One End
Height: 15 17/32 (394.5)
A. Gskt: [2] Attached



PA2643 Air Element
Replaces: White 22-0050012
O.D.: 12 1/32 (305.6)
I.D.: 6 23/32 (170.7)
Height: 16 (406.4)
A. Gskt: [2] Attached



PA2649 Air Element
Fits: Volvo Trucks
Replaces: Volvo 475975, 475975-1, 475975-9
O.D.: 7 15/16 (201.6)
I.D.: 7/16 (11.1) & 4 5/8 (117.5)
Height: 24 1/8 (612.8)
A. Gskt: [1] Included
F. Gskt: [1] Included



PA2644 Inner Air Element
Fits Inside: PA2635-FN
Fits: John Deere Tractors
Replaces: John Deere AL30395
O.D.: 3 3/8 (85.7)
 Flange 3 25/32 (96.0)
I.D.: 2 1/32 (16.7) & 2 7/8 (73.0)
Height: 13 1/16 (331.8)
A. Gskt: [1] Attached
F. Gskt: [1] Included, [1] Wing Nut



PA2650 Replacement for Ecolite Air Element in Disposable Housing
Fits: Freightliner, Kenworth Trucks
Replaces: Caterpillar 7C8339; Farr C71338-2 Series; GMC 25043580
O.D.: 11 1/32 (280.2)
Inlet: 10 23/32
Outlet: 7
Height: 25 7/8 (657.2)













PA2645 Outer Air Element with Lift Tab
Fits: Massey Ferguson Wheel Tractors
Use With: PA2646
Replaces: Massey Ferguson 1633719-M1
O.D.: 8 1/4 (209.6)
 Boot 9 1/8 (231.8)
I.D.: 3/8 (9.5) & 5 1/4 (133.4)
Height: 12 5/8 (320.7)
A. Gskt: [2] Attached



Measurements Are Shown In Inches And (Millimeters)

WARNING: These products can expose you to chemicals, including Diisononyl Phthalate, Carbon black extracts, Nickel, 1,3 Butadiene, Ethylene Oxide, Epichlorohydrin, which are known to the State of California to cause cancer, and Bisphenol, Ethylene Glycol, Ethylene Oxide, 1,3 Butadiene, Epichlorohydrin, which are known to the State of California to cause birth defects or other reproductive harm. For more information go to www.P65Warnings.ca.gov.

<p>PA2651 Outer Air Element Fits: Komatsu Equipment Use With: PA2652 Replaces: Komatsu 600-181-9220 O.D.: 8 1/4 (209.6) I.D.: 13/32 (10.3) & 4 3/16 (106.4) Height: 12 15/16 (328.6) A. Gskt: [1] Attached F. Gskt: [1] Included</p> 	<p>PA2656 Air Element Fits: GMC Buses, Trucks Replaces: GMC 15583321 O.D.: 10 3/8 (263.5) I.D.: 6 1/32 (153.2) One End Height: 10 1/2 (266.7) A. Gskt: [1] Attached</p> 
<p>PA2652 Inner Air Element Fits Inside: PA2651 Fits: Komatsu Equipment Replaces: Komatsu 600-181-9320 O.D.: 4 1/8 (104.8) I.D.: 21/32 (16.7) & 3 (76.2) Height: 11 9/16 (293.7) A. Gskt: [1] Attached F. Gskt: G103-N</p> 	<p>PA2657-FN Outer Air Element with Fins Fits: Case, Dresser, Hough, International, Oliver Equipment Use With: PA2700 Replaces: International 3125199-R1,-R2 O.D.: 5 1/4 (133.4) I.D.: 21/32 (16.7) & 2 3/4 (69.9) Height: 11 9/32 (286.5) A. Gskt: [1] Attached F. Gskt: G103-N</p> 
<p>PA2653 Outer Air Element Fits: Caterpillar Industrial, Marine Engines Use With: PA2653 FOAM, PA2848 Replaces: Caterpillar 8N6309 O.D.: 19 9/32 (489.7) I.D.: 12 7/8 (327.0) One End Height: 10 11/32 (262.7) A. Gskt: [1] Attached</p> 	<p>PA2658 Air Element Notes: Inside-Out Flow Direction Fits: GMC Buses, Trucks Replaces: GMC 25043235 O.D.: 9 1/2 (241.3) I.D.: 7/16 (11.1) & 6 1/2 (165.1) Height: 28 7/16 (722.3) A. Gskt: [2] Attached F. Gskt: G31-AF</p> 
<p>PA2653 FOAM Foam Blanket for PA2653 Use With: PA2653 Length: 60 5/16 (1531.9) Width: 9 1/2 (241.3) Height: 1/2 (12.7)</p> 	<p>PA2659 Air Element Fits: Volvo Buses, Trucks Replaces: Volvo 6872683, 6872683-5 O.D.: 7 15/16 (201.6) I.D.: 7/16 (11.1) & 4 5/8 (117.5) Height: 20 3/8 (517.5) A. Gskt: [1] Attached F. Gskt: [1] Included</p> 
<p>PA2654 Outer Air Element with Lift Bars Fits: Massey Ferguson Wheel Tractors Use With: PA2655 Replaces: Massey Ferguson 1051376-M91 O.D.: 11 1/2 (292.1) I.D.: 13/32 (10.3) & 7 1/4 (184.2) Height: 20 1/2 (520.7) A. Gskt: [1] Attached F. Gskt: [1] Included</p> 	<p>PA2660 Conical-Shaped Air Element Fits: Caterpillar, Cummins, Detroit Diesel Engines; Ford, International, Kenworth, Peterbilt Trucks Replaces: GMC 25096137 O.D.: 7 13/32 (188.1) to 10 13/32 (264.3) I.D.: 6 15/16 (176.2) One End Height: 28 1/2 (723.9) A. Gskt: [1] Attached</p> 
<p>PA2655 Inner Air Element Fits Inside: PA2654 Fits: Massey Ferguson Wheel Tractors Replaces: Massey Ferguson 1051375-M91 O.D.: 6 7/8 (174.6) I.D.: 5/8 (15.9) & 5 13/32 (137.3) Height: 19 1/16 (484.2) A. Gskt: [1] Attached F. Gskt: G103-N</p> 	

Measurements Are Shown In Inches And (Millimeters)

WARNING: These products can expose you to chemicals, including Diisononyl Phthalate, Carbon black extracts, Nickel, 1,3 Butadiene, Ethylene Oxide, Epichlorohydrin, which are known to the State of California to cause cancer, and Bisphenol, Ethylene Glycol, Ethylene Oxide, 1,3 Butadiene, Epichlorohydrin, which are known to the State of California to cause birth defects or other reproductive harm. For more information go to www.P65Warnings.ca.gov.

LL2661 Long Life Air Element
Fits: Volvo Trucks
Replaces: White 22-0013205
O.D.: 12 1/16 (306.4)
I.D.: 7 11/16 (195.3)
Height: 16 (406.4)
A. Gskt: [2] Attached
Related To: PA2661 (Standard Media Version)



PA2665 Inner Air Element
Fits Inside: PA2664
Fits: Komatsu Equipment
Replaces: Komatsu 600-181-2460
O.D.: 5 9/16 (141.3)
I.D.: 5/8 (15.9) & 4 7/32 (107.2)
Height: 10 25/32 (273.8)
A. Gskt: [1] Attached
F. Gskt: G103-N



PA2661 Air Element
Fits: Volvo Trucks
Replaces: White 22-0013205
O.D.: 12 1/16 (306.4)
I.D.: 7 11/16 (195.3)
Height: 16 (406.4)
A. Gskt: [2] Attached
Related To: LL2661 (Long-Life Media Version)



PA2666 Outer Air Element with Lift Bar
Notes: Sometimes used as Cab Air.
Fits: John Deere Equipment
Use With: PA2570
Replaces: John Deere AT65296, RE24619
O.D.: 6 7/8 (174.6)
I.D.: 2 1/32 (16.7) & 3 1/2 (88.9)
Height: 12 13/32 (315.1)
A. Gskt: [1] Attached
F. Gskt: G103-N



PA2662 Outer Air Element
Fits: Case Tractors
Use With: PA2678
Replaces: Case K200379
O.D.: 5 3/16 (131.8)
I.D.: 2 1/32 (16.7) & 3 7/32 (81.8)
Height: 11 1/2 (292.1)
A. Gskt: [1] Attached
F. Gskt: G103-N



LL2667 Long Life Outer Air Element
Fits: Komatsu Equipment
Use With: PA2668
Replaces: Komatsu 600-181-2300
O.D.: 9 5/8 (244.5)
I.D.: 2 1/32 (16.7) & 5 7/32 (132.6)
Height: 15 1/2 (393.7)
A. Gskt: [1] Attached
F. Gskt: G103-N
Related To: PA2667 (Standard Media Version)



PA2663-FN Air Element with Fins and Lift Tabs
Fits: Grove Equipment
Replaces: Grove 9304100072
O.D.: 13 13/16 (350.8)
 Fins 15 25/32 (400.8)
I.D.: 11/16 (17.5) & 9 1/2 (241.3)
Height: 18 1/2 (469.9)
A. Gskt: [1] Attached
F. Gskt: G103-N



PA2667 Outer Air Element
Fits: Komatsu Equipment
Use With: PA2668
Replaces: Komatsu 600-181-2300
O.D.: 9 5/8 (244.5)
I.D.: 2 1/32 (16.7) & 5 7/32 (132.6)
Height: 15 1/2 (393.7)
A. Gskt: [1] Attached
F. Gskt: G103-N
Related To: LL2667 (Long-Life Media Version)



PA2664 Outer Air Element
Fits: Komatsu Equipment
Use With: PA2665
Replaces: Komatsu 600-181-2450
O.D.: 9 3/4 (247.7)
I.D.: 5/8 (15.9) & 5 5/8 (142.9)
Height: 13 1/16 (331.8)
A. Gskt: [1] Attached
F. Gskt: G103-N



PA2668 Inner Air Element
Fits Inside: LL2667, PA2667
Fits: Komatsu Equipment
Replaces: Komatsu 600-181-2350
O.D.: 5 1/16 (128.6)
I.D.: 2 1/32 (16.7) & 3 13/16 (96.8)
Height: 13 19/32 (345.3)
A. Gskt: [1] Attached
F. Gskt: G103-N



PA2669-FN Outer Air Element with Fins
Fits: Allis Chalmers, Deutz, Fiat, Hesston Tractors
Use With: PA2670
Replaces: Deutz 4319257; Fiat 1909116
O.D.: 6 3/32 (154.8)
 Fins 7 13/16 (198.4)
I.D.: 3/4 (19.0) & 3 15/32 (88.1)
Height: 13 1/2 (342.9)
A. Gskt: [1] Attached
F. Gskt: G103-N



Measurements Are Shown In Inches And (Millimeters)

WARNING: These products can expose you to chemicals, including Diisononyl Phthalate, Carbon black extracts, Nickel, 1,3 Butadiene, Ethylene Oxide, Epichlorohydrin, which are known to the State of California to cause cancer, and Bisphenol, Ethylene Glycol, Ethylene Oxide, 1,3 Butadiene, Epichlorohydrin, which are known to the State of California to cause birth defects or other reproductive harm. For more information go to www.P65Warnings.ca.gov.

PA2670



Inner Air Element
Fits Inside: PA2669-FN, PA3779-FN, PA3852-FN
Fits: Allis Chalmers, Deutz, Fiat, Hesston, John Deere, New Holland Tractors
Replaces: Deutz 4319256; Fiat 1909117
O.D.: 3 3/8 (85.7)
 Flange 3 25/32 (96.0)
I.D.: 21/32 (16.7) & 2 7/8 (73.0)
Height: 12 1/16 (306.4)
A. Gskt: [1] Attached
F. Gskt: G103-N

PA2672



Inner Air Element
Fits Inside: PA1975
Fits: Case-International, New Holland, Steiger, Versatile Tractors
Replaces: Case 13899; New Holland V63972; Steiger 13-899; Versatile 63972
O.D.: 8 5/8 (219.1)
I.D.: 5/8 (15.9) & 7 1/16 (179.4)
Height: 21 (533.4)
A. Gskt: [1] Attached
F. Gskt: G103-N

PA2673



Outer Air Element with Lift Bar
Fits: Allis Chalmers, Case-International, Steiger Tractors
Use With: PA2674
Replaces: Allis Chalmers 264744
O.D.: 9 7/32 (234.2)
I.D.: 21/32 (16.7) & 5 27/32 (148.4)
Height: 17 1/2 (444.5)
A. Gskt: [1] Attached
F. Gskt: G103-N

PA2674



Inner Air Element
Fits Inside: PA2673
Fits: Allis Chalmers, Case-International, Steiger Tractors
Replaces: Allis Chalmers 264745; Steiger 90-6444T1
O.D.: 5 9/16 (141.3)
I.D.: 5/8 (15.9) & 4 7/16 (112.7)
Height: 15 9/16 (395.3)
A. Gskt: [1] Attached
F. Gskt: G103-N

PA2675



Outer Air Element
Fits: Allis Chalmers, Euclid, Fiat-Allis, Terex, Versatile Equipment
Use With: PA1976
Replaces: Allis Chalmers 686821; Euclid 9038907; Fiat 70686821
O.D.: 13 13/16 (350.8)
 Boot 14 1/2 (368.3)
I.D.: 15/16 (23.8) & 9 1/2 (241.3)
Height: 22 1/2 (571.5)
A. Gskt: [2] Attached
F. Gskt: [1] Included
Related To: PA1975 (without Boot)

LL2676



Long Life Outer Air Element
Fits: Fiat-Hitachi, Hitachi, John Deere, New Holland, Versatile Equipment; Komatsu Dump Trucks; Nissan Trucks
Use With: PA2708, PA3668
Replaces: Hino 17801-2490; John Deere AR95758; New Holland V95611
O.D.: 12 1/8 (308.0)
I.D.: 29/32 (23.0) & 7 11/16 (195.3)
Height: 19 1/2 (495.3)
A. Gskt: [1] Attached
F. Gskt: [1] Included
Related To: PA2676 (Standard Media Version) PA2676XP (Extreme Performance Nano Version)

PA2676



Outer Air Element
Fits: Fiat-Hitachi, Hitachi, John Deere, New Holland, Versatile Equipment; Komatsu Dump Trucks; Nissan Trucks
Use With: PA2708, PA3668
Replaces: Hino 17801-2490; John Deere AR95758; New Holland V95611
O.D.: 12 1/8 (308.0)
I.D.: 29/32 (23.0) & 7 11/16 (195.3)
Height: 19 1/2 (495.3)
A. Gskt: [1] Attached
F. Gskt: [1] Included
Related To: LL2676 (Long-Life Media Version) PA2676XP (Extreme Performance Nano Version)

PA2676XP



Extreme Performance Nano Outer Air Element
Fits: Fiat-Hitachi, Hitachi, John Deere, New Holland, Versatile Equipment; Komatsu Dump Trucks; Nissan Trucks
Use With: PA2708, PA3668
Replaces: Hino 17801-2490; John Deere AR95758; New Holland V95611
O.D.: 12 1/8 (308.0)
I.D.: 29/32 (23.0) & 7 11/16 (195.3)
Height: 19 1/2 (495.3)
A. Gskt: [1] Attached
F. Gskt: [1] Included
Related To: LL2676 (Long-Life Media Version) PA2676 (Standard Performance Nano Version)

PA2677



Conical-Shaped Air Element with Lid
Fits: Mack Trucks
Replaces: Mack 2191P13-8427
O.D.: 8 21/32 (219.9)
 Lid 9 13/16 (249.2)
I.D.: 21/32 (16.7) & 5 3/16 (131.8)
Height: 15 9/16 (395.3)
A. Gskt: [2] Attached
F. Gskt: G103-N, [1] Wing Nut

PA2678



Inner Air Element
Fits Inside: PA2662
Fits: Case Tractors
Replaces: Case K200380
O.D.: 2 15/16 (74.6)
I.D.: 7/16 (11.1) & 1 7/8 (47.6)
Height: 9 31/32 (253.2)
A. Gskt: [1] Attached
F. Gskt: [1] Included

Measurements Are Shown In Inches And (Millimeters)

WARNING: These products can expose you to chemicals, including Diisononyl Phthalate, Carbon black extracts, Nickel, 1,3 Butadiene, Ethylene Oxide, Epichlorohydrin, which are known to the State of California to cause cancer, and Bisphenol, Ethylene Glycol, Ethylene Oxide, 1,3 Butadiene, Epichlorohydrin, which are known to the State of California to cause birth defects or other reproductive harm. For more information go to www.P65Warnings.ca.gov.

PA2679 Air Element with Lid and 6 Bolt Holes



Replaces: Mack 57MD37M
O.D.: 13 7/8 (352.4)
Lid 16 5/32 (410.4)
I.D.: 7 7/16 (188.9) One End
Height: 22 17/32 (572.3)
A. Gskt: [2] Attached

PA2680 Air Element with Lid



Fits: Freightliner, Mack Trucks
Replaces: Mack 57MD42M
O.D.: 10 5/8 (269.9)
Lid 11 11/16 (296.9)
I.D.: 6 11/16 (169.9) One End
Height: 28 13/32 (721.5)
A. Gskt: [1] Attached

PA2684-FN Outer Air Element with Fins



Fits: Case, International Tractors
Use With: PA2689
Replaces: International 3125342-R1, 3125342-R2
O.D.: 6 3/32 (154.8)
Fins 7 13/16 (198.4)
I.D.: 3/4 (19.0) & 3 15/32 (88.1)
Height: 11 1/2 (292.1)
A. Gskt: [1] Attached
F. Gskt: G103-N

LL2685 Long Life Air Element



Fits: Autocar, Volvo, WhiteGMC Trucks
Replaces: White 22-0055039
O.D.: 13 13/16 (350.8)
I.D.: 9 1/2 (241.3) One End
Height: 16 (406.4)
A. Gskt: [1] Attached

PA2687 Inner Air Element



Fits Inside: PA2616, PA2616XP
Fits: John Deere Equipment
Replaces: John Deere AT75036
O.D.: 5 15/16 (150.8)
I.D.: 2 1/32 (16.7) & 4 27/32 (123.0)
Height: 11 3/8 (288.9)
A. Gskt: [1] Attached
F. Gskt: [1] Included

LL2688 Long Life Outer Air Element



Fits: Case, Caterpillar, Champion, Dresser, Drott, Hitachi, John Deere, Kawasaki, Kobelco, Komatsu, Volvo Equipment; Hino Trucks
Use With: PA2621
Replaces: Case S238646; Caterpillar 9Y6845; Dresser 1249057-H1; Hino 17801-2260; John Deere AT81018; Komatsu 600-181-8270
O.D.: 9 1/8 (231.8)
I.D.: 15/16 (23.8) & 5 13/16 (147.6)
Height: 18 1/2 (469.9)
A. Gskt: [1] Attached
F. Gskt: [1] Included
Related To: PA2688 (Standard Media Version)

PA2688 Outer Air Element



Fits: Case, Caterpillar, Champion, Dresser, Drott, Hitachi, John Deere, Kawasaki, Kobelco, Komatsu, Volvo Equipment; Hino Trucks
Use With: PA2621
Replaces: Case S238646; Caterpillar 9Y6845; Dresser 1249057-H1; Hino 17801-2260; John Deere AT81018; Komatsu 600-181-8270
O.D.: 9 1/8 (231.8)
I.D.: 15/16 (23.8) & 5 13/16 (147.6)
Height: 18 1/2 (469.9)
A. Gskt: [1] Attached
F. Gskt: [1] Included
Related To: LL2688 (Long-Life Media Version)

PA2689 Inner Air Element



Fits Inside: PA2684-FN, PA2970, PA3466-FN, PA3924-FN
Fits: Case, International, J.C. Bamford, John Deere, Massey Ferguson, Zetor Equipment
Replaces: J.C. Bamford 32/903202, 32/906802; Massey Ferguson 1096469-M91
O.D.: 3 3/8 (85.7)
Flange 4 5/32 (105.6)
I.D.: 11/16 (17.5) & 2 29/32 (73.8)
Height: 10 3/32 (256.4)
A. Gskt: [1] Attached
F. Gskt: G103-N

PA2690 Panel Air Element

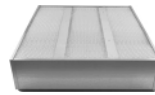

Fits: Waukesha Engines
Replaces: Waukesha 169180, 169180B, 169180H
Length: 19 7/16 (493.7)
Width: 19 7/16 (493.7)
Height: 5 5/16 (134.9)
A. Gskt: [1] Attached

PA2691 Panel Air Element

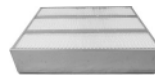

Fits: Waukesha Engines
Replaces: Waukesha 169180A, 169180C
Length: 25 7/16 (646.1)
Width: 19 7/16 (493.7)
Height: 5 5/8 (142.9)
A. Gskt: [2] Attached

PA2692 Panel Air Element

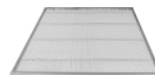

Fits: Waukesha Engines
Replaces: Waukesha 169180F
Length: 19 1/2 (495.3)
Width: 19 1/2 (495.3)
Height: 2 19/32 (65.9)

Measurements Are Shown In Inches And (Millimeters)

WARNING: These products can expose you to chemicals, including Diisononyl Phthalate, Carbon black extracts, Nickel, 1,3 Butadiene, Ethylene Oxide, Epichlorohydrin, which are known to the State of California to cause cancer, and Bisphenol, Ethylene Glycol, Ethylene Oxide, 1,3 Butadiene, Epichlorohydrin, which are known to the State of California to cause birth defects or other reproductive harm. For more information go to www.P65Warnings.ca.gov.

PA2693 Panel Air Element
Fits: Waukesha Engines
Replaces: Waukesha 169180G
Length: 25 1/2 (647.7)
Width: 19 1/2 (495.3)
Height: 2 5/32 (54.8)
A. Gskt: [1] Attached



PA2694 Tube-Type Air Filter
Contains: 25 Tubes--5 x 5
Fits: Waukesha Engines
Replaces: Waukesha 1691802
Length: 19 7/16 (493.7)
Width: 19 7/16 (493.7)
Height: 8 1/16 (204.8)
A. Gskt: [2] Attached



PA2698 Air Element
Notes: Inside-Out Flow Direction
Fits: Torit Air Cleaning Systems
Replaces: Torit 8PP18583-01
O.D.: 12 3/4 (323.8)
I.D.: 1 3/16 (30.2) & 8 11/32 (211.9)
Height: 22 1/2 (571.5)
A. Gskt: [1] Attached



PA2699 Air Element
Fits: Ingersoll-Rand Compressors
Replaces: Ingersoll-Rand 39708466
O.D.: 10 27/32 (275.4)
I.D.: 6 1/2 (165.1)
Height: 5 1/32 (127.8)
A. Gskt: [2] Attached



PA2700 Inner Air Element
Fits Inside: PA2391, PA2657-FN, PA2846-FN, PA2976-FN
Fits: Case, Fiat-Allis, International, Massey Ferguson, Zetor Equipment
Replaces: Fiat 700053475; International 3115569-R2; Massey Ferguson 3595519-M1
O.D.: 2 23/32 (69.1)
 Flange 3 21/32 (92.9)
I.D.: 21/32 (16.7) & 2 3/8 (60.3)
Height: 10 3/32 (256.4)
F. Gskt: [1] Included



PA2701 Outer Air Element with Lift Bar
Fits: Massey Ferguson Equipment with Perkins Engines
Use With: PA2702, PA2748
Replaces: Massey Ferguson 1670260-M1
O.D.: 4 5/8 (117.5)
 Boot 5 3/4 (146.0)
I.D.: 9/16 (14.3) & 3 1/32 (77.0)
Height: 9 11/32 (237.3)
A. Gskt: [2] Attached
F. Gskt: [1] Included



PA2702 Inner Air Element
Fits Inside: PA2701
Fits: Massey Ferguson Equipment with Perkins Engines
Replaces: Massey Ferguson 1670261-M1
O.D.: 2 15/16 (74.6)
I.D.: 7/16 (11.1) & 1 7/8 (47.6)
Height: 8 1/4 (209.6)
A. Gskt: [1] Attached
F. Gskt: [1] Included



PA2703 Conical-Shaped Air Element
Fits: Freightliner Trucks
Replaces: Nelson 84831S
O.D.: 7 13/32 (188.1)
 to 10 13/32 (264.3)
I.D.: 6 15/16 (176.2) One End
Height: 23 (584.2)
A. Gskt: [2] Attached
F. Gskt: G298-AF



PA2704 Air Element with Lid
Fits: Freightliner Trucks
Replaces: Caterpillar 9Y0307; GMC 25096292
O.D.: 10 5/8 (269.9)
 Lid 11 11/16 (296.9)
I.D.: 6 11/16 (169.9) One End
Height: 20 17/32 (521.5)
A. Gskt: [1] Attached



PA2705 Air Element with Lid
Fits: Freightliner, Kenworth, Peterbilt, Western Star Trucks
Replaces: White 22-0055064
O.D.: 10 5/8 (269.9)
 Lid 11 11/16 (296.9)
I.D.: 6 13/16 (173) One End
Height: 22 15/32 (570.7)
A. Gskt: [1] Attached



PA2706 Cab Air Element
Fits: John Deere Equipment
Replaces: John Deere AH92463
Length: 16 7/16 (417.5)
Width: 5 (127.0)
Height: 1 7/16 (36.5)

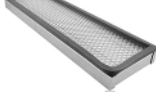

PA2707 Outer Air Element
Fits: Iveco, Volvo Buses, Trucks
Use With: PA2773
Replaces: Volvo 1542743-8, 1660619-1
O.D.: 12 1/32 (305.6)
I.D.: 17/32 (13.5) & 7 7/8 (200.0)
Height: 14 1/2 (368.3)
A. Gskt: [1] Attached
F. Gskt: [1] Included



Measurements Are Shown In Inches And (Millimeters)

WARNING: These products can expose you to chemicals, including Diisononyl Phthalate, Carbon black extracts, Nickel, 1,3 Butadiene, Ethylene Oxide, Epichlorohydrin, which are known to the State of California to cause cancer, and Bisphenol, Ethylene Glycol, Ethylene Oxide, 1,3 Butadiene, Epichlorohydrin, which are known to the State of California to cause birth defects or other reproductive harm. For more information go to www.P65Warnings.ca.gov.

PA2708 Inner Air Element
Fits Inside: LL2676, PA2676, PA2676XP
Fits: Ford, John Deere, New Holland, Versatile Equipment
Replaces: John Deere AR95759; New Holland V95612
O.D.: 7 5/8 (193.7)
I.D.: 2 1/32 (16.7) & 6 1/16 (154.0)
Height: 18 3/8 (466.7)
A. Gskt: [1] Attached
F. Gskt: G103-N



PA2713 Outer Air Element
Fits: Agco, Case-International, Steiger Equipment
Use With: PA2714
Replaces: Steiger 90-4203T1
O.D.: 12 1/32 (305.6)
I.D.: 15/16 (23.8) & 7 11/16 (195.3)
Height: 21 1/2 (546.1)
A. Gskt: [1] Attached



PA2709 Outer Air Element
Fits: John Deere Equipment
Use With: PA2570
Replaces: John Deere AT76215
O.D.: 7 11/32 (186.5)
I.D.: 7/16 (11.1) & 3 31/32 (100.8)
Height: 13 3/8 (339.7)
A. Gskt: [1] Attached
F. Gskt: [1] Included



PA2714 Inner Air Element
Fits Inside: PA2713
Fits: Agco, Case-International, Steiger Equipment
Replaces: Steiger 90-4204T1
O.D.: 7 5/8 (193.7)
I.D.: 2 1/32 (16.7) & 6 1/16 (154.0)
Height: 20 3/8 (517.5)
A. Gskt: [1] Attached



PA2710 Outer Air Element
Fits: Case, David Brown Tractors
Use With: PA2711
Replaces: Case K945043
O.D.: 6 3/32 (154.8)
I.D.: 3/4 (19.0) & 3 25/32 (96.0)
Height: 10 3/4 (273.1)
A. Gskt: [1] Attached
F. Gskt: G103-N



PA2715 Conical-Shaped Air Element
Fits: Freightliner, Kenworth, Mack Trucks
Replaces: Donaldson P154575
O.D.: 7 13/32 (188.1) to 10 13/32 (264.3)
I.D.: 6 15/16 (176.2) One End
Height: 22 1/2 (571.5)
A. Gskt: [1] Attached



PA2711 Inner Air Element
Fits Inside: PA2710
Fits: Case, David Brown Tractors
Replaces: Case K952344
O.D.: 3 11/16 (93.7)
I.D.: 7/16 (11.1) & 2 9/16 (65.1)
Height: 10 (254.0)
A. Gskt: [1] Attached
F. Gskt: [1] Included



PA2716 Outer Air Element
Fits: John Deere Equipment
Use With: PA2717
Replaces: John Deere AT68183
O.D.: 6 3/32 (154.8)
I.D.: 3/4 (19.0) & 3 15/32 (88.1)
Height: 10 3/8 (263.5)
A. Gskt: [1] Attached
F. Gskt: G103-N



PA2712 Air Element
Fits: GMC, Isuzu, Nissan Buses, Trucks; J.C. Bamford, Kubota Equipment
Replaces: GMC 94156052; Isuzu 8-934156-052-0; Kubota 15484-11210; Nissan 16546-T9031
O.D.: 7 15/16 (201.6)
I.D.: 7/8 (22.2) & 5 3/8 (136.5)
Height: 10 1/2 (266.7)
A. Gskt: [1] Attached
F. Gskt: [1] Included



PA2717 Inner Air Element
Notes: OBSOLETE. Availability Limited to Dealer Stock.
Fits Inside: PA2716
Fits: John Deere Equipment
Replaces: John Deere AT68184
O.D.: 2 31/32 (75.4) Flange 3 5/8 (92.1)
I.D.: 5/8 (15.9) & 2 13/32 (61.1)
Height: 9 3/32 (231.0)
A. Gskt: [1] Attached
F. Gskt: G103-N













Measurements Are Shown In Inches And (Millimeters)

WARNING: These products can expose you to chemicals, including Diisononyl Phthalate, Carbon black extracts, Nickel, 1,3 Butadiene, Ethylene Oxide, Epichlorohydrin, which are known to the State of California to cause cancer, and Bisphenol, Ethylene Glycol, Ethylene Oxide, 1,3 Butadiene, Epichlorohydrin, which are known to the State of California to cause birth defects or other reproductive harm. For more information go to www.P65Warnings.ca.gov.

<p>PA2718</p>  <p>Air Element with Lid Fits: International Trucks Replaces: International 1651566-C1 O.D.: 8 21/32 (219.9) Lid: 9 11/16 (246.1) I.D.: 5 3/16 (131.8) One End Height: 28 1/2 (723.9) A. Gskt: [1] Attached</p>	<p>PA2724</p>  <p>Replacement for Ecolite Air Element in Disposable Housing Fits: Farr Optional Filter Housings Replaces: Farr C71338-3 Series O.D.: 13 17/32 (343.7) Inlet: 10 23/32 Outlet: 7 Height: 25 7/8 (657.2)</p>
<p>PA2719</p>  <p>Inner Air Element with 8 Bolt Holes Fits Inside: LL1615, PA1615, PA1615XP Fits: Caterpillar Equipment Replaces: Caterpillar 8N4901 O.D.: 4 3/4 (120.7) Flange: 7 5/16 (185.7) I.D.: 3 5/8 (92.1) One End Height: 12 1/32 (305.6) A. Gskt: [1] Attached</p>	<p>PA2725</p>  <p>Air Element Contains: Flame Retardant Media Fits: Caterpillar Industrial Engines, Lift Trucks Replaces: Caterpillar 2W4246 O.D.: 6 5/8 (168.3) I.D.: 4 1/4 (108.0) Height: 5 7/16 (138.1) A. Gskt: [2] Attached</p>
<p>PA2721</p>  <p>Replacement for Ecolite Air Element in Disposable Housing Fits: Farr Optional Filter Housings Replaces: Farr C62891-1 Series O.D.: 9 25/32 (248.4) Inlet: 6 Outlet: 6 Height: 25 7/8 (657.2)</p>	<p>PA2726</p>  <p>Air Element Fits: Ford Buses, Trucks Replaces: Ford E7HZ-9601-A O.D.: 7 11/32 (186.5) I.D.: 7/16 (11.1) & 5 5/16 (134.9) Height: 23 1/2 (596.9) A. Gskt: [1] Attached F. Gskt: [1] Included</p>
<p>PA2722</p>  <p>Replacement for Ecolite Air Element in Disposable Housing Fits: Farr Optional Filter Housings Replaces: Farr C62891-2 Series O.D.: 11 1/32 (280.2) Inlet: 7 Outlet: 7 Height: 25 7/8 (657.2)</p>	<p>PA2727</p>  <p>Outer Air Element with Lift Bar Fits: Massey Ferguson Equipment Use With: PA2728 Replaces: Massey Ferguson 1678294-M1 O.D.: 5 3/16 (131.8) Boot: 5 7/8 (149.2) I.D.: 7/16 (11.1) & 2 31/32 (75.4) Height: 12 9/16 (319.1) A. Gskt: [2] Attached F. Gskt: [1] Included</p>
<p>PA2723</p>  <p>Replacement for Ecolite Air Element in Disposable Housing Fits: Farr Optional Filter Housings Replaces: Farr C62891-3 Series O.D.: 13 17/32 (343.7) Inlet: 7 Outlet: 7 Height: 25 7/8 (657.2)</p>	<p>PA2728</p>  <p>Inner Air Element Fits Inside: PA2727 Fits: Massey Ferguson Equipment Replaces: Massey Ferguson 1678295-M1 O.D.: 2 15/16 (74.6) I.D.: 7/16 (11.1) & 1 7/8 (47.6) Height: 11 9/16 (293.7) A. Gskt: [1] Attached F. Gskt: [1] Included</p>









Measurements Are Shown In Inches And (Millimeters)

WARNING: These products can expose you to chemicals, including Diisononyl Phthalate, Carbon black extracts, Nickel, 1,3 Butadiene, Ethylene Oxide, Epichlorohydrin, which are known to the State of California to cause cancer, and Bisphenol, Ethylene Glycol, Ethylene Oxide, 1,3 Butadiene, Epichlorohydrin, which are known to the State of California to cause birth defects or other reproductive harm. For more information go to www.P65Warnings.ca.gov.

<p>PA2729 Conical-Shaped Air Element Fits: Peterbilt Trucks Replaces: Donaldson P521598 O.D.: 9 25/32 (248.4) to 11 7/8 (301.6) I.D.: 7 3/8 (187.3) One End Height: 25 (635.0) A. Gskt: [2] Attached F. Gskt: G501-AF</p> 	<p>PA2735 Inner Air Element Fits Inside: LL2384, PA2384, PA2384XP Fits: Caterpillar Applications Converted from Flanged Air Systems Previously Using PA2647 O.D.: 8 5/8 (219.1) I.D.: 15/16 (23.8) & 7 1/16 (179.4) Height: 11 1/2 (292.1) A. Gskt: [1] Attached F. Gskt: [1] Included</p> 
<p>PA2730 Inner Air Element with 6 Bolt Holes Fits Inside: LL2575, PA2575 Fits: Caterpillar Equipment Replaces: Caterpillar 7W3754 O.D.: 3 15/16 (100.0) Flange 6 11/16 (169.9) I.D.: 2 11/32 (59.5) One End Height: 5 13/32 (137.3) A. Gskt: [1] Attached</p> 	<p>PA2736 Inner Air Element Fits Inside: LL1615, PA1615, PA1615XP Fits: Caterpillar Applications Converted from Flanged Air Systems Previously Using PA1647 or PA2719 O.D.: 4 3/4 (120.7) I.D.: 29/32 (23.0) & 3 5/8 (92.1) Height: 11 1/2 (292.1) A. Gskt: [1] Attached F. Gskt: [1] Included</p> 
<p>PA2731 Replacement for Ecolite Air Element in Disposable Housing Contains: Bleed Valve Fits: Kenworth Trucks Replaces: Farr C78897-1 Series O.D.: 13 17/32 (343.7) Inlet: 6 29/32 Outlet: 7 Height: 25 17/32 (648.5)</p> 	<p>PA2737 Inner Air Element Fits Inside: LL1634, PA1634, PA1634XP Fits: Caterpillar Applications Converted from Flanged Air Systems Previously Using PA1675 or PA2310 O.D.: 6 1/4 (158.8) I.D.: 29/32 (23.0) & 4 5/8 (117.5) Height: 12 3/8 (314.3) A. Gskt: [1] Attached F. Gskt: [1] Included</p> 
<p>PA2732 Conical-Shaped Air Element Notes: Inside-Out Flow Direction Fits: Freightliner, Peterbilt Trucks Replaces: Donaldson P522293 O.D.: 7 13/32 (188.1) to 10 13/32 (264.3) I.D.: 6 15/16 (176.2) One End Height: 29 (736.6) A. Gskt: [2] Included F. Gskt: G348-AF</p> 	<p>PA2738 Inner Air Element Fits Inside: PA1818, LL2358, PA2358 Fits: Caterpillar Applications Converted from Flanged Air Systems Previously Using PA1819 or PA2359 O.D.: 7 5/8 (193.7) I.D.: 7/8 (22.2) & 6 1/16 (154.0) Height: 12 1/2 (317.5) A. Gskt: [1] Attached F. Gskt: [1] Included</p> 
<p>PA2733 Inner Air Element with 8 Bolt Holes Fits Inside: LL1669, PA1669 Fits: Caterpillar Equipment Replaces: Caterpillar 8N6883 O.D.: 6 1/4 (158.8) Flange 9 1/16 (230.2) I.D.: 4 5/8 (117.5) One End Height: 16 7/32 (412.0) A. Gskt: [1] Attached</p> 	<p>PA2739 Inner Air Element Fits Inside: LL1669, PA1669 Fits: Caterpillar Applications Converted from Flanged Air Systems Previously Using PA1670 or PA2733 O.D.: 6 1/4 (158.8) I.D.: 29/32 (23.0) & 4 5/8 (117.5) Height: 14 1/2 (368.3) A. Gskt: [1] Attached F. Gskt: [1] Included</p> 
<p>PA2734 Air Element with 6 Bolt Holes Replaces: Donaldson P181185 O.D.: 13 13/16 (350.8) Lid 16 5/32 (410.4) I.D.: 9 1/2 (241.3) One End Height: 21 17/32 (546.9) A. Gskt: [2] Attached</p> 	<p>PA2740 Cab Air Element Fits: Caterpillar Equipment Replaces: Caterpillar 9G1518 O.D.: 6 7/8 (174.6) I.D.: 21/32 (16.7) & 4 3/16 (106.4) Height: 9 1/2 (241.3) A. Gskt: [1] Attached F. Gskt: [1] Wing Nut</p> 











Measurements Are Shown In Inches And (Millimeters)

WARNING: These products can expose you to chemicals, including Diisononyl Phthalate, Carbon black extracts, Nickel, 1,3 Butadiene, Ethylene Oxide, Epichlorohydrin, which are known to the State of California to cause cancer, and Bisphenol, Ethylene Glycol, Ethylene Oxide, 1,3 Butadiene, Epichlorohydrin, which are known to the State of California to cause birth defects or other reproductive harm. For more information go to www.P65Warnings.ca.gov.

<p>PA2742</p>  <p>Outer Air Element with Bail Handle Fits: American Grape Harvester Equipment; Atlas Copco Generators Use With: PA2743 Replaces: Air Maze CD1219610-826 O.D.: 10 (254.0) I.D.: 3/8 (9.5) & 5 7/8 (149.2) Height: 17 19/32 (446.9) A. Gskt: [1] Attached F. Gskt: [1] Included</p>	<p>PA2748</p>  <p>Inner Air Element Fits Inside: PA2701 Fits: Massey Ferguson Wheel Tractors Replaces: Massey Ferguson 1688093-M1 O.D.: 2 29/32 (73.8) I.D.: 15/32 (11.9) & 2 3/8 (60.3) Height: 8 1/8 (206.4) A. Gskt: [1] Attached End Seals: [1] Included</p>
<p>PA2743</p>  <p>Inner Air Element Fits Inside: PA2742 Fits: American Grape Harvester Equipment; Atlas Copco Generators Replaces: Air Maze CD1219610-830 O.D.: 5 11/16 (144.5) I.D.: 5/8 (15.9) & 4 15/16 (125.4) Height: 15 9/16 (395.3) A. Gskt: [1] Attached F. Gskt: [1] Washer</p>	<p>PA2749</p>  <p>Outer Air Element with Bail Handle Fits: Caterpillar Equipment Use With: PA1905 Replaces: Caterpillar 4W5716 O.D.: 13 13/16 (350.8) Boot 14 1/2 (368.3) I.D.: 15/16 (23.8) & 9 1/2 (241.3) Height: 18 1/2 (469.9) A. Gskt: [1] Attached, G285-AF F. Gskt: [1] Included Related To: LL1894 , PA1894 (without Boot and Bail Handle) PA1894XP (Extreme Performance Nano Version)</p>
<p>PA2744</p>  <p>Outer Air Element with Lift Tab Use With: PA2745 Replaces: Air Maze CD1628610-826 O.D.: 12 1/2 (317.5) I.D.: 13/32 (10.3) & 7 1/2 (190.5) Height: 27 1/16 (687.4) A. Gskt: [1] Attached F. Gskt: [1] Included</p>	<p>PA2750</p>  <p>Conical-Shaped Air Element Fits: Blue Bird Buses; ERF, Leyland Trucks Replaces: Leyland BBU8383; Nelson 70470N O.D.: 7 3/16 (182.6) to 8 1/4 (209.6) I.D.: 21/32 (16.7) & 4 23/32 (119.9) to Height: 18 1/2 (469.9) F. Gskt: G103-N</p>
<p>PA2745</p>  <p>Inner Air Element Fits Inside: PA2744 Replaces: Air Maze CD1628610-827 O.D.: 7 3/8 (187.3) I.D.: 25/32 (19.8) & 6 1/8 (155.6) Height: 25 3/4 (654.1) F. Gskt: G103-N</p>	<p>PA2751</p>  <p>Conical-Shaped Air Element Fits: Blue Bird Buses; Bedford, ERF, Foden, Leyland Trucks Replaces: Leyland BBU2734 O.D.: 7 15/16 (201.6) to 9 27/32 (250.0) I.D.: 11/16 (17.5) & 6 1/4 (158.8) to Height: 19 1/2 (495.3) A. Gskt: [1] Included F. Gskt: G103-N</p>
<p>PA2746</p>  <p>Outer Air Element with Lift Tab Use With: PA2747 Replaces: Air Maze CD1830610-826 O.D.: 13 7/8 (352.4) I.D.: 17/32 (13.5) & 10 (254.0) Height: 29 1/2 (749.3) F. Gskt: [1] Included</p>	<p>PA2752</p>  <p>Cab Air Element Fits: John Deere Equipment Replaces: John Deere AT73529 Length: 29 1/2 (749.3) Width: 5 (127.0) Height: 2 9/16 (65.1)</p>
<p>PA2747</p>  <p>Inner Air Element Fits Inside: PA2746 Replaces: Air Maze CD1830610-827 O.D.: 9 29/32 (251.6) I.D.: 17/32 (13.5) & 8 1/16 (204.8) Height: 28 1/4 (717.6) F. Gskt: [1] Included</p>	<p>PA2753</p>  <p>Cab Air Element Fits: Allis Chalmers Tractors Replaces: Allis Chalmers 1504385 Length: 26 (660.4) Width: 7 (177.8) Height: 2 9/16 (65.1)</p>











Measurements Are Shown In Inches And (Millimeters)

WARNING: These products can expose you to chemicals, including Diisononyl Phthalate, Carbon black extracts, Nickel, 1,3 Butadiene, Ethylene Oxide, Epichlorohydrin, which are known to the State of California to cause cancer, and Bisphenol, Ethylene Glycol, Ethylene Oxide, 1,3 Butadiene, Epichlorohydrin, which are known to the State of California to cause birth defects or other reproductive harm. For more information go to www.P65Warnings.ca.gov.

<p>PA2754</p>  <p>Air Element with Lift Bar Fits: Sullair Compressors Replaces: Sullair 250022-888 O.D.: 6 11/16 (169.9) I.D.: 1/2 (12.7) & 3 3/4 (95.3) Height: 11 11/32 (288.1) A. Gskt: [1] Attached F. Gskt: [1] Included</p>	<p>PA2763</p>  <p>Air Element Replaces: Leyland 10621312 O.D.: 8 1/8 (206.4) I.D.: 3 25/32 (96.0) Height: 7 1/8 (181.0)</p>
<p>PA2755</p>  <p>Air Element Fits: Mack Trucks Replaces: Mack 57MD44M O.D.: 8 27/32 (224.6) I.D.: 5 13/16 (147.6) Height: 28 1/2 (723.9) A. Gskt: [1] Attached</p>	<p>PA2767</p>  <p>Outer Air Element Fits: Claas, Fendt, International, John Deere, Kobelco, Liebherr Equipment; Iveco Trucks Use With: PA3686 Replaces: Iveco 1904581; John Deere AZ18968; Leyland BBU6549; Nelson 70604S O.D.: 5 7/8 (149.2) I.D.: 7/16 (11.1) & 2 13/16 (71.4) Height: 13 1/4 (336.5) A. Gskt: [1] Attached</p>
<p>PA2756</p>  <p>Conical-Shaped Air Element Fits: Blue Bird Buses; Ford Trucks Replaces: Blue Bird 4280574; Ford 81DB-9601-JB; Nelson 70469N O.D.: 5 15/16 (150.8) to 7 (177.8) I.D.: 21/32 (16.7) & 3 5/8 (92.1) Height: 15 1/2 (393.7) A. Gskt: [1] Attached F. Gskt: G103-N</p>	<p>PA2771</p>  <p>Replacement for Ecolite Air Element in Disposable Housing Fits: Akerman Excavators; Volvo Engines, Equipment Replaces: Volvo 823701 O.D.: 7 3/4 (196.9) I.D.: 4 (101.6) One End Height: 28 3/16 (716.0)</p>
<p>PA2757</p>  <p>Air Element Fits: Volvo Trucks Replaces: Volvo 1660375-5 O.D.: 10 5/8 (269.9) I.D.: 7/16 (11.1) & 6 1/4 (158.8) Height: 22 11/16 (576.3) A. Gskt: [1] Attached F. Gskt: [1] Included</p>	<p>PA2772</p>  <p>Outer Air Element Fits: 1993-96 Volkswagen Eurovan; Bomag, Demag, Fendt Equipment; Sullair Compressors Use With: PA3684 Replaces: Demag 29504476; Fendt 5821301; Volkswagen 44129620A O.D.: 6 15/32 (164.3) I.D.: 3 11/32 (84.9) One End Height: 9 3/8 (238.1) A. Gskt: [1] Attached</p>
<p>PA2761</p>  <p>Outer Air Element with Lid Fits: GMC, Isuzu, Mitsubishi Trucks Use With: PA3417 Replaces: GMC 94430250; Isuzu 8-94430-250-0; Mitsubishi ME033717 O.D.: 8 11/16 (220.7) Lid 10 3/8 (263.5) I.D.: 7/8 (22.2) & 5 11/32 (135.7) Height: 13 1/2 (342.9) A. Gskt: [2] Attached F. Gskt: [1] Included</p>	<p>PA2773</p>  <p>Inner Air Element Fits Inside: PA2707 Fits: Volvo Trucks Replaces: Volvo 1544298 O.D.: 7 25/32 (197.6) I.D.: 13/32 (10.3) & 6 15/16 (176.2) Height: 12 5/8 (320.7) A. Gskt: [1] Attached F. Gskt: G15-AF</p>
	<p>PA2774</p>  <p>Outer Air Element Fits: Volvo Buses, Trucks Use With: PA2775 Replaces: Volvo 1544449 O.D.: 13 13/16 (350.8) I.D.: 5/8 (15.9) & 8 9/32 (210.3) Height: 14 1/2 (368.3) A. Gskt: [1] Attached F. Gskt: [1] Included</p>

Measurements Are Shown In Inches And (Millimeters)

WARNING: These products can expose you to chemicals, including Diisononyl Phthalate, Carbon black extracts, Nickel, 1,3 Butadiene, Ethylene Oxide, Epichlorohydrin, which are known to the State of California to cause cancer, and Bisphenol, Ethylene Glycol, Ethylene Oxide, 1,3 Butadiene, Epichlorohydrin, which are known to the State of California to cause birth defects or other reproductive harm. For more information go to www.P65Warnings.ca.gov.

<p>PA2775</p>  <p>Inner Air Element Fits Inside: PA2774 Fits: Volvo Buses, Trucks Replaces: Volvo 1660903 O.D.: 7 13/16 (198.4) I.D.: 7/16 (11.1) & 6 17/32 (165.9) Height: 12 5/8 (320.7) A. Gskt: [1] Attached F. Gskt: [1] Included</p>	<p>PA2779</p>  <p>Outer Air Element Fits: Caterpillar, Link-Belt Equipment; GMC, Hino, Isuzu, Nissan Buses, Trucks Use With: PA2545 Replaces: Hino 17801-2280; Isuzu 1-14215-172-0; Nissan 16546-Z9004 O.D.: 9 1/8 (231.8) I.D.: 15/16 (23.8) & 5 13/16 (147.6) Height: 13 1/2 (342.9) A. Gskt: [1] Attached F. Gskt: [1] Included Related To: LL2779 (Long-Life Media Version)</p>
<p>PA2776</p>  <p>Outer Air Element Fits: Claas, Liebherr, V.M.E., Volvo Equipment; Iveco, M.A.N., Mercedes-Benz Trucks Use With: PA3494, PA3857 Replaces: Claas 709050; Iveco 1902129; Liebherr 5106191; M.A.N. 81.08304.0044; Mercedes-Benz 90940502; Volvo 11033128 O.D.: 11 15/16 (303.2) I.D.: 13/32 (10.3) & 7 17/32 (191.3) Height: 18 21/32 (473.9) A. Gskt: [1] Attached F. Gskt: [1] Included</p>	<p>PA2781</p>  <p>Outer Air Element Fits: Caterpillar Equipment Use With: PA2782, PA3551 Replaces: Caterpillar 7W9853 O.D.: 14 1/4 (362.0) I.D.: 9 29/32 (251.6) One End Height: 18 21/32 (473.9) A. Gskt: [1] Attached</p>
<p>PA2777</p>  <p>Outer Air Element Fits: Case, International Tractors; Cummins Engines Use With: PA2539 Replaces: Case A171255 O.D.: 9 29/32 (251.6) I.D.: 11/16 (17.5) & 6 1/16 (154.0) Height: 16 1/2 (419.1) A. Gskt: [1] Attached F. Gskt: G103-N</p>	<p>PA2782</p>  <p>Inner Air Element with 12 Bolt Holes Fits Inside: PA2781 Fits: Caterpillar Equipment Replaces: Caterpillar 7W9567 O.D.: 9 13/16 (249.2) Flange: 12 3/32 (307.2) I.D.: 8 1/8 (206.4) One End Height: 18 3/32 (459.6) A. Gskt: [1] Attached</p>
<p>PA2778-FN</p>  <p>Air Element with Fins Contains: Flame Retardant Media Fits: Komatsu Equipment; Nissan Lift Trucks Replaces: Nissan 16546-00H10 O.D.: 4 3/32 (104.0) Fins: 5 1/8 (130.2) I.D.: 25/32 (19.8) & 2 15/32 (62.7) Height: 7 23/32 (196.1) A. Gskt: [1] Attached F. Gskt: G103-N</p>	<p>PA2783</p>  <p>Air Element Fits: Caterpillar, Fiat-Allis, Hanomag, Liebherr, Trojan Equipment; R.V.I. Buses Replaces: Caterpillar 7E0973; Fiat 79042202; Hanomag 3074304-M1; Liebherr 7401179 O.D.: 7 5/8 (193.7) I.D.: 5/8 (15.9) & 4 1/4 (108.0) Height: 16 1/2 (419.1) A. Gskt: [1] Attached F. Gskt: G103-N Related To: LL2783 (Long-Life Media Version)</p>
<p>LL2779</p>  <p>Long Life Outer Air Element Fits: Caterpillar, Link-Belt Equipment; GMC, Hino, Isuzu, Nissan Buses, Trucks Use With: PA2545 Replaces: Hino 17801-2280; Isuzu 1-14215-172-0; Nissan 16546-Z9004 O.D.: 9 1/8 (231.8) I.D.: 15/16 (23.8) & 5 13/16 (147.6) Height: 13 1/2 (342.9) A. Gskt: [1] Attached F. Gskt: [1] Included Related To: PA2779 (Standard Media Version)</p>	<p>PA2784</p>  <p>Outer Air Element with Lid Fits: Daewoo, Kawasaki, Kobelco, Komatsu Equipment; Hino, Mitsubishi Trucks Use With: PA3578 Replaces: Hino 17801-2800; Kawasaki 30980-70070; Kobelco 2446R312S2; Komatsu 600-181-6820; Mitsubishi ME033603 O.D.: 8 11/16 (220.7) Lid: 10 3/8 (263.5) I.D.: 7/8 (22.2) & 5 11/32 (135.7) Height: 17 29/32 (454.8) A. Gskt: [2] Attached F. Gskt: [1] Included</p>

Measurements Are Shown In Inches And (Millimeters)

WARNING: These products can expose you to chemicals, including Diisononyl Phthalate, Carbon black extracts, Nickel, 1,3 Butadiene, Ethylene Oxide, Epichlorohydrin, which are known to the State of California to cause cancer, and Bisphenol, Ethylene Glycol, Ethylene Oxide, 1,3 Butadiene, Epichlorohydrin, which are known to the State of California to cause birth defects or other reproductive harm. For more information go to www.P65Warnings.ca.gov.

PA2785 Air Element with Lid
Fits: Volvo Trucks
Replaces: Volvo 6792554
O.D.: 7 3/8 (187.3)
 Lid 8 1/8 (206.4)
I.D.: 13/32 (10.3) & 4 11/16 (119.1)
Height: 23 1/4 (590.6)
A. Gskt: [2] Attached
F. Gskt: [1] Included



PA2791 Inner Air Element
Fits Inside: PA2790-FN, PA3859
Fits: Case, J.C. Bamford, New Holland Equipment
Replaces: J.C. Bamford 32/206003
O.D.: 2 23/32 (69.1)
 Flange Gasket 3 21/32 (92.9)
I.D.: 21/32 (16.7) & 2 3/8 (60.3)
Height: 12 1/32 (305.6)
A. Gskt: [1] Attached
F. Gskt: [1] Washer
End Seals: [1] Included



PA2786 Outer Air Element
Fits: Volvo Trucks
Use With: PA2787
Replaces: Volvo 1660600
O.D.: 10 3/16 (258.8)
I.D.: 13/32 (10.3) & 6 5/16 (160.3)
Height: 21 3/8 (542.9)
A. Gskt: [1] Attached
F. Gskt: [1] Included



PA2792 Outer Air Element
Fits: Allis Chalmers, Demag, Eicher, Fendt, Fiat, International Equipment
Use With: PA3687
Replaces: Allis Chalmers 99100059; Demag 99054; Eicher 1871933-M91; Fendt X810270073; Fiat 9293140; International 3146927-R91
O.D.: 5 (127.0)
I.D.: 11/32 (8.7) & 2 9/16 (65.1)
Height: 11 17/32 (292.9)
A. Gskt: [1] Attached
F. Gskt: G39-AF



PA2787 Inner Air Element
Fits Inside: PA2786
Fits: Volvo Trucks
Replaces: Volvo 1660601, 1665886
O.D.: 6 1/8 (155.6)
I.D.: 13/32 (10.3) & 4 15/16 (125.4)
Height: 20 1/2 (520.7)
A. Gskt: [1] Attached
F. Gskt: [1] Included



PA2793 Outer Air Element with Lift Tab
Fits: Massey Ferguson Wheel Tractors
Use With: PA2794
Replaces: Massey Ferguson 1055534-M91
O.D.: 8 1/2 (215.9)
I.D.: 7/16 (11.1) & 5 3/8 (136.5)
Height: 12 3/4 (323.8)
A. Gskt: [1] Attached
F. Gskt: [1] Included



PA2788 Outer Air Element with Lid
Fits: Case, Daewoo, Hitachi, Kobelco, Komatsu, MDI/Yutani Equipment
Use With: PA1911
Replaces: Case 161863A1; Hitachi 4129907; Kobelco 2447U242S2; Komatsu 600-181-6540
O.D.: 7 3/8 (187.3)
 Lid 9 9/32 (235.7)
I.D.: 21/32 (16.7) & 4 11/16 (119.1)
Height: 15 1/2 (393.7)
A. Gskt: [2] Attached
F. Gskt: G103-N



PA2794 Inner Air Element
Fits Inside: PA2793
Fits: Massey Ferguson Wheel Tractors
Replaces: Massey Ferguson 1055533-M91
O.D.: 5 1/4 (133.4)
I.D.: 5/8 (15.9) & 4 1/8 (104.8)
Height: 11 5/16 (287.3)
A. Gskt: [1] Attached
F. Gskt: G103-N



PA2789 Air Element
Fits: Ford Trucks
Replaces: Ford E8HZ-9601-A
O.D.: 13 7/8 (352.4)
I.D.: 11/16 (17.5) & 7 7/16 (188.9)
Height: 7 1/2 (190.5)
A. Gskt: [1] Attached
F. Gskt: G103-N



PA2796 Air Element
Fits: Pneumafil Dust Collectors
Replaces: Pneumafil A37536B-2
O.D.: 12 3/4 (323.8)
I.D.: 3/4 (19.0) & 8 3/8 (212.7)
Height: 29 3/4 (755.7)
A. Gskt: [1] Attached



PA2790-FN Outer Air Element with Fins and Lid
Fits: J.C. Bamford Equipment
Use With: PA2791
Replaces: J.C. Bamford 32/206002
O.D.: 5 1/4 (133.4)
 Lid 6 1/2 (165.1)
I.D.: 21/32 (16.7) & 2 27/32 (72.2)
Height: 14 1/16 (357.2)
A. Gskt: [1] Attached
F. Gskt: [1] Included, [1] Wing Nut



Measurements Are Shown In Inches And (Millimeters)

WARNING: These products can expose you to chemicals, including Diisononyl Phthalate, Carbon black extracts, Nickel, 1,3 Butadiene, Ethylene Oxide, Epichlorohydrin, which are known to the State of California to cause cancer, and Bisphenol, Ethylene Glycol, Ethylene Oxide, 1,3 Butadiene, Epichlorohydrin, which are known to the State of California to cause birth defects or other reproductive harm. For more information go to www.P65Warnings.ca.gov.

PA2797 Outer Air Element
Fits: Volvo Trucks
Use With: PA4627
Replaces: Volvo V1115700
O.D.: 12 3/4 (323.8)
I.D.: 8 11/32 (211.9) One End
Height: 16 21/32 (423.1)
A. Gskt: [2] Attached



PA2805 Replacement for Ecolite Air Element in Disposable Housing
Fits: LeRoi Compressors; Ditch Witch, Volvo, Wacker Equipment
Replaces: LeRoi 43-867-2
O.D.: 8 9/16 (217.5)
I.D.: 2 31/32 (75.4) One End
Height: 10 13/16 (274.6)



PA2798 Air Breather Element
Contains: Clamp
Fits: V.M.E., Volvo Equipment, Trucks
Replaces: Volvo 1586882-1
O.D.: 3 15/32 (88.1)
I.D.: 31/32 (24.6) One End
Height: 3 15/32 (88.1)
Grommets: [1] Attached
Related To: PA5700 (with Check Valve)



PA2806 Replacement for Ecolite Air Element in Disposable Housing
Fits: Godwin Pumps
Replaces: Donaldson C105004
O.D.: 10 9/16 (268.3)
I.D.: 4 1/4 (108.0) One End
Height: 11 13/16 (300.0)



PA2799 Air Element
Notes: Inside-Out Flow Direction
Fits: Torit Air Cleaning Systems
Replaces: Torit 8PP22269-00
O.D.: 12 3/4 (323.8)
I.D.: 8 11/32 (211.9)
Height: 26 1/2 (673.1)
A. Gskt: [1] Included



PA2807 Replacement for Ecolite Air Element in Disposable Housing
Replaces: Gehl 77628; John Deere AM100258
O.D.: 5 1/2 (139.7)
I.D.: 1 3/4 (44.4) One End
Height: 8 3/8 (212.7)



PA2801 Air Element with Lid
Fits: Scania Trucks
Replaces: Saab-Scania 370754
O.D.: 11 7/8 (301.6)
 Lid 15 1/32 (381.8)
I.D.: 13/32 (10.3) & 9 9/16 (242.9)
Height: 18 3/4 (476.3)
A. Gskt: [2] Attached



PA2812 Air Element with Lid
Fits: Mercedes-Benz Buses, Trucks
Replaces: Mercedes-Benz 10949304
O.D.: 10 7/8 (276.2)
 Lid 13 5/16 (338.1)
I.D.: 13/32 (10.3) & 5 1/4 (133.4)
Height: 10 (254.0)
A. Gskt: [2] Attached



PA2803 Replacement for Ecolite Air Element in Disposable Housing
Fits: Carrier-Transicold Refrigeration Units
Replaces: Carrier 30-01077-01
O.D.: 6 5/8 (168.3)
I.D.: 2 (50.8) One End
Height: 10 11/32 (262.7)



PA2813 Outer Air Element
Fits: DAF, Iveco, M.A.N., Scania Buses, Trucks
Use With: PA4809
Replaces: DAF 667078; Iveco 8122408
O.D.: 11 29/32 (302.4)
I.D.: 13/32 (10.3) & 7 17/32 (191.3)
Height: 14 7/8 (377.8)
A. Gskt: [1] Attached
F. Gskt: [1] Included



PA2804 Replacement for Ecolite Air Element in Disposable Housing
Fits: Thermo King Refrigeration Units
Replaces: Thermo King 11-5978, 11-7400
O.D.: 6 5/8 (168.3)
I.D.: 1 13/32 (35.7) One End
Height: 11 11/32 (288.1)



Measurements Are Shown In Inches And (Millimeters)

WARNING: These products can expose you to chemicals, including Diisononyl Phthalate, Carbon black extracts, Nickel, 1,3 Butadiene, Ethylene Oxide, Epichlorohydrin, which are known to the State of California to cause cancer, and Bisphenol, Ethylene Glycol, Ethylene Oxide, 1,3 Butadiene, Epichlorohydrin, which are known to the State of California to cause birth defects or other reproductive harm. For more information go to www.P65Warnings.ca.gov.

PA2814 Inner Air Element
Fits Inside: PA2475
Fits: DAF, Iveco, M.A.N., R.V.I., Volvo Buses, Trucks; Claas, Demag, Fendt, Liebherr, New Holland, V.M.E. Equipment
Replaces: DAF 691280; Demag 988765; Iveco 1909132; New Holland 430287; Volvo 4785749, 4785749-5
O.D.: 5 1/8 (130.2)
 Boot Gasket 5 9/16 (141.3)
I.D.: 11/16 (17.5) & 4 11/16 (119.1)
Height: 18 5/8 (473.1)
A. Gskt: [1] Attached
F. Gskt: [1] Included



PA2819 Replacement for Ecolite Air Element in Disposable Housing
Replaces: Donaldson ECB105003
O.D.: 10 9/16 (268.3)
Inlet: 4 15/32
Outlet: 4
Height: 11 13/16 (300.0)



PA2815 Air Element
Replaces: Cummins 3905326; Ingersoll-Rand 39824115; Onan 140-2660
O.D.: 8 1/2 (215.9)
I.D.: 3 (76.2) One End
Height: 12 3/8 (314.3)
Related To: PA3868 (with Flame Retardant Media)



PA2820 Air Element
Replaces: Donaldson ECB105006
O.D.: 10 1/2 (266.7)
I.D.: 4 (101.6) One End
Height: 11 7/8 (301.6)



PA2816 Replacement for Ecolite Air Element in Disposable Housing
Replaces: Donaldson ECB085008
O.D.: 8 9/16 (217.5)
Inlet: 3 15/32
Outlet: 4 11/32
Height: 9 27/32 (250.0)



PA2821 Air Element
Replaces: Donaldson ECB125003
O.D.: 12 1/2 (317.5)
I.D.: 6 (152.4) One End
Height: 16 3/8 (415.9)



PA2817 Air Element
Replaces: Donaldson ECB085009
O.D.: 8 1/2 (215.9)
I.D.: 3 (76.2) One End
Height: 4 3/8 (111.1)



PA2822 Replacement for Ecolite Air Element in Disposable Housing
Fits: Gehl Loaders
Replaces: Gehl 75986, 79388
O.D.: 5 1/2 (139.7)
I.D.: 1 3/4 (44.4) One End
Height: 8 3/8 (212.7)



PA2818 Air Element
Replaces: Donaldson ECB085011
O.D.: 8 1/2 (215.9)
I.D.: 4 (101.6) One End
Height: 12 3/8 (314.3)



PA2823 Replacement for Ecolite Air Element in Disposable Housing
Replaces: Jacobsen 330811
O.D.: 6 5/8 (168.3)
I.D.: 2 (50.8) One End
Height: 5 11/32 (135.7)



Measurements Are Shown In Inches And (Millimeters)

WARNING: These products can expose you to chemicals, including Diisononyl Phthalate, Carbon black extracts, Nickel, 1,3 Butadiene, Ethylene Oxide, Epichlorohydrin, which are known to the State of California to cause cancer, and Bisphenol, Ethylene Glycol, Ethylene Oxide, 1,3 Butadiene, Epichlorohydrin, which are known to the State of California to cause birth defects or other reproductive harm. For more information go to www.P65Warnings.ca.gov.

<p>PA2824</p>  <p>Replacement for Ecolite Air Element in Disposable Housing Fits: Godwin Pumps; Isuzu Engines Replaces: Donaldson C065002 O.D.: 6 5/8 (168.3) I.D.: 2 (50.8) One End Height: 8 27/32 (224.6)</p>	<p>PA2830</p>  <p>Replacement for Ecolite Air Element in Disposable Housing Fits: Godwin Pumps Replaces: LeRoi 438673 O.D.: 10 9/16 (268.3) I.D.: 4 1/4 (108.0) One End Height: 7 5/16 (185.7)</p>
<p>PA2825</p>  <p>Replacement for Ecolite Air Element in Disposable Housing Fits: Northern Lights Generators Replaces: Broderson 60012047 O.D.: 8 9/16 (217.5) I.D.: 2 1/2 (63.5) One End Height: 5 5/16 (134.9)</p>	<p>PA2831</p>  <p>Replacement for Ecolite Air Element in Disposable Housing Fits: Godwin Pumps Replaces: Fiat 73253513 O.D.: 12 9/16 (319.1) I.D.: 5 (127.0) One End Height: 12 5/16 (312.7)</p>
<p>PA2826</p>  <p>Replacement for Ecolite Air Element in Disposable Housing Fits: Godwin Pumps; Isuzu, John Deere Industrial Engines Replaces: Donaldson C085002 O.D.: 8 9/16 (217.5) I.D.: 2 1/2 (63.5) One End Height: 7 13/16 (198.4)</p>	<p>PA2832</p>  <p>Replacement for Ecolite Air Element in Disposable Housing Replaces: Ingersoll-Rand 8524575; Thermo King 11-6488 O.D.: 4 1/2 (114.3) I.D.: 1 1/2 (38.1) One End Height: 5 7/8 (149.2)</p>
<p>PA2827</p>  <p>Replacement for Ecolite Air Element in Disposable Housing Fits: Godwin Pumps Replaces: Cummins 3910946; Lister 3043 O.D.: 8 9/16 (217.5) I.D.: 3 1/4 (82.6) One End Height: 6 5/16 (160.3)</p>	<p>PA2833</p>  <p>Outer Air Element Fits: R.V.I. Trucks Use With: PA2834 Replaces: Renault 5000814797 O.D.: 12 1/8 (308.0) I.D.: 5/8 (15.9) & 7 11/16 (195.3) Height: 15 1/4 (387.3) A. Gskt: [1] Attached F. Gskt: G103-N</p>
<p>PA2828</p>  <p>Replacement for Ecolite Air Element in Disposable Housing Replaces: Donaldson C085005 O.D.: 8 19/32 (218.3) I.D.: 2 1/2 (63.5) One End Height: 6 3/8 (161.9)</p>	<p>PA2834</p>  <p>Inner Air Element Fits Inside: PA2833 Fits: John Deere Equipment; R.V.I. Trucks Replaces: Renault 5000814798 O.D.: 7 1/4 (184.2) Flange 8 13/32 (213.5) I.D.: 11/16 (17.5) & 6 3/16 (157.2) Height: 14 17/32 (369.1) A. Gskt: [1] Attached F. Gskt: G103-N</p>
<p>PA2829</p>  <p>Replacement for Ecolite Air Element in Disposable Housing Replaces: Isuzu X14210-031; LeRoi 43-867-1 O.D.: 8 9/16 (217.5) I.D.: 2 1/2 (63.5) One End Height: 10 13/16 (274.6)</p>	

Measurements Are Shown In Inches And (Millimeters)

WARNING: These products can expose you to chemicals, including Diisononyl Phthalate, Carbon black extracts, Nickel, 1,3 Butadiene, Ethylene Oxide, Epichlorohydrin, which are known to the State of California to cause cancer, and Bisphenol, Ethylene Glycol, Ethylene Oxide, 1,3 Butadiene, Epichlorohydrin, which are known to the State of California to cause birth defects or other reproductive harm. For more information go to www.P65Warnings.ca.gov.

PA2835



Inner Air Element

Fits Inside: PA2405
Fits: Bomag, Claas, Demag, Fendt, International, John Deere, Kobelco, Liebherr Equipment; DAF, Iveco, R.V.I. Buses, Trucks
Replaces: Bomag 5821014; Claas 1761680; Iveco 1902131; John Deere AZ30758
O.D.: 4 1/32 (102.4)
 Flange Gasket 4 13/32 (111.9)
I.D.: 1 1/16 (17.5) & 3 5/16 (84.1)
Height: 14 5/8 (371.5)
A. Gskt: [1] Attached
F. Gskt: [1] Included

PA2836



Inner Air Element

Fits Inside: PA2474
Fits: Atlas Copco, Compair Compressors; DAF, Iveco, M.A.N., R.V.I. Buses, Trucks; Bomag, John Deere, Kobelco, Liebherr, Volvo Equipment
Replaces: Atlas Copco 29000501; Bomag 5821019; Iveco 2243946; John Deere AZ26007; Liebherr 5601963; Volvo 4785746
O.D.: 4 13/32 (111.9)
 Flange Gasket 4 25/32 (121.4)
I.D.: 1 1/16 (17.5) & 3 11/16 (93.7)
Height: 14 15/16 (379.4)
A. Gskt: [1] Attached
F. Gskt: [1] Included

PA2837



Inner Air Element

Fits Inside: PA2845
Fits: Bomag, Claas, Demag, Fendt, Liebherr, V.M.E., Volvo Equipment; Iveco, M.A.N., R.V.I. Trucks
Replaces: Bomag 5821015; Claas 176169; Demag 39468640; Iveco 2415950; Liebherr 7361346; Volvo 4785611-7
O.D.: 3 9/32 (83.3)
 Flange Gasket 3 5/8 (92.1)
I.D.: 1 1/16 (17.5) & 2 27/32 (72.2)
Height: 13 7/16 (341.3)
A. Gskt: [1] Attached
F. Gskt: [1] Included

PA2838

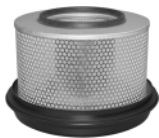

Air Element with Lid

Fits: Mercedes-Benz Buses, Trucks, Vans
Replaces: Mercedes-Benz 10948304
O.D.: 12 7/8 (327.0)
 Lid 15 1/4 (387.3)
I.D.: 13/32 (10.3) & 6 9/16 (166.7)
Height: 10 1/16 (255.6)
A. Gskt: [1] Attached
End Seals: [1] Attached

PA2839



Air Element with Lift Tabs

Fits: MCI, Prevost Buses
Replaces: Flxible 97342400210; TCM 9G3-37; Universal Coach T121009
O.D.: 15 3/32 (383.4)
 Boot 16 1/16 (408.0)
I.D.: 13/16 (20.6) & 8 21/32 (219.9)
Height: 15 15/16 (404.8)
A. Gskt: [2] Attached
F. Gskt: [1] Included

PA2840



Outer Air Element

Fits: Astra Dump Trucks with Iveco Engine; New Holland Equipment
Use With: PA3861
Replaces: Iveco 107029
O.D.: 12 1/8 (308.0)
I.D.: 21/32 (16.7) & 7 23/32 (196.1)
Height: 20 1/2 (520.7)
A. Gskt: [1] Attached
F. Gskt: [1] Included

PA2843



Air Element

Replaces: Air Refiner ARM18-1200; Donaldson P181200
O.D.: 10 3/8 (263.5)
I.D.: 6 1/32 (153.2) One End
Height: 10 1/2 (266.7)
A. Gskt: [1] Attached

PA2844



Cab Air Element

Fits: Caterpillar Crawler Tractors
Replaces: Caterpillar 7T1890
Length: 26 1/8 (663.6)
Width: 5 7/16 (138.1)
Height: 2 9/16 (65.1)
A. Gskt: [1] Attached

PA2845



Outer Air Element

Fits: Atlas Copco Compressors; Bomag, Claas, Demag, Fendt, Ford, John Deere, Liebherr, V.M.E., Volvo Equipment; Iveco, M.A.N., R.V.I. Buses, Trucks
Use With: PA2837, PA3601
Replaces: Atlas Copco 1619-2797; Bomag 5821013; Demag 964013; Ford A830X-9601-ABA; Iveco 1902127; John Deere AZ20623; Volvo 6644839
O.D.: 6 15/32 (164.3)
I.D.: 13/32 (10.3) & 3 5/8 (92.1)
Height: 13 3/4 (349.3)
A. Gskt: [1] Attached

PA2846-FN



Outer Air Element with Fins

Fits: Case, International Equipment
Use With: PA2700
Replaces: International 1265510-C1
O.D.: 5 1/4 (133.4)
 Fins 6 3/8 (161.9)
I.D.: 21/32 (16.7) & 3 1/4 (82.6)
Height: 11 3/8 (288.9)
A. Gskt: [1] Attached
F. Gskt: G103-N

PA2847



Air Element with Lid

Fits: Fendt, Hanomag, John Deere Equipment; Iveco, M.A.N., Mercedes-Benz, Volvo Buses, Trucks
Replaces: Hanomag 2872977-M1; Iveco 2164590; John Deere AZ23440; Mercedes-Benz 10941004; Volvo 500858
O.D.: 8 15/16 (227.0)
 Lid 10 15/16 (277.8)
I.D.: 13/32 (10.3) & 4 9/16 (115.9)
Height: 15 3/32 (383.4)
A. Gskt: [2] Included

Measurements Are Shown In Inches And (Millimeters)

WARNING: These products can expose you to chemicals, including Diisononyl Phthalate, Carbon black extracts, Nickel, 1,3 Butadiene, Ethylene Oxide, Epichlorohydrin, which are known to the State of California to cause cancer, and Bisphenol, Ethylene Glycol, Ethylene Oxide, 1,3 Butadiene, Epichlorohydrin, which are known to the State of California to cause birth defects or other reproductive harm. For more information go to www.P65Warnings.ca.gov.

PA2848 Inner Air Element
Fits Inside: PA2653
Fits: Caterpillar Generators, Industrial, Marine Engines
Replaces: Caterpillar 8N2556
O.D.: 12 25/32 (324.6)
 Flange 15 5/8 (396.9)
I.D.: 10 9/32 (261.1) One End
Height: 10 5/16 (261.9)
A. Gskt: [1] Attached



PA2855 Air Element
Fits: Torit Air Cleaning Systems
Replaces: Torit 8PP19215-01
O.D.: 12 3/4 (323.8)
I.D.: 17/32 (13.5) & 8 11/32 (211.9)
Height: 26 1/2 (673.1)
A. Gskt: [1] Attached
F. Gskt: [1] Included



PA2849 Outer Air Element with Bail Handle
Fits: Caterpillar Equipment
Use With: PA2563
Replaces: Caterpillar 4W5228
O.D.: 14 11/16 (373.1)
 Boot 15 3/8 (390.5)
I.D.: 29/32 (23.0) & 10 11/32 (262.7)
Height: 24 1/2 (622.3)
A. Gskt: [2] Attached
F. Gskt: [1] Included



PA2856 Air Element
Fits: Torit Air Cleaning Systems
Replaces: Torit 8PP21586-00
O.D.: 7 15/16 (201.6)
I.D.: 11/16 (17.5) & 3 9/16 (90.5)
Height: 16 1/2 (419.1)
A. Gskt: [1] Attached
F. Gskt: [1] Included



PA2851 Conical-Shaped Air Element
Fits: Mack Trucks
Replaces: Mack 57MD45M
O.D.: 7 13/32 (188.1)
 to 10 13/32 (264.3)
I.D.: 6 15/16 (176.2) One End
Height: 20 1/2 (520.7)
A. Gskt: [1] Included



PA2857 Air Element
Notes: Inside-Out Flow Direction
Fits: Torit Air Cleaning Systems
Replaces: Torit 8PP21347-00
O.D.: 12 3/4 (323.8)
I.D.: 17/32 (13.5) & 8 11/32 (211.9)
Height: 26 1/2 (673.1)
A. Gskt: [1] Attached
F. Gskt: [1] Included



PA2852 Outer Air Element
Fits: Dresser Motor Graders
Use With: PA2853
Replaces: Dresser 1249055-H1
O.D.: 10 27/32 (275.4)
I.D.: 15/16 (23.8) & 6 1/2 (165.1)
Height: 18 1/2 (469.9)
A. Gskt: [1] Attached
F. Gskt: [1] Included



PA2858 Air Element
Contains: Flame Retardant Media
Fits: Nissan Lift Trucks
Replaces: Nissan 16546-K4046B
O.D.: 7 (177.8)
I.D.: 3 21/32 (92.9)
Height: 5 (127.0)



PA2853 Inner Air Element
Fits Inside: PA2852
Fits: Dresser Motor Graders
Replaces: International 1249056-H1
O.D.: 6 3/8 (161.9)
I.D.: 5/8 (15.9) & 5 9/32 (134.1)
Height: 17 1/2 (444.5)
A. Gskt: [1] Attached
F. Gskt: G103-N



PA2859-FN Air Element with Fins
Fits: Case Tractors; DAF, Leyland Trucks
Replaces: Case K306535; Leyland MAK1629
O.D.: 7 15/16 (201.6)
 Fins 10 1/32 (254.8)
I.D.: 5/8 (15.9) & 5 5/16 (134.9)
Height: 13 7/16 (341.3)
A. Gskt: [1] Attached
F. Gskt: [1] Included, [1] Metal Washer



PA2854 Panel Air Element
Replaces: Tennant 81363
Length: 30 (762.0)
Width: 20 (508.0)
Height: 3 9/16 (90.5)



Measurements Are Shown In Inches And (Millimeters)

WARNING: These products can expose you to chemicals, including Diisononyl Phthalate, Carbon black extracts, Nickel, 1,3 Butadiene, Ethylene Oxide, Epichlorohydrin, which are known to the State of California to cause cancer, and Bisphenol, Ethylene Glycol, Ethylene Oxide, 1,3 Butadiene, Epichlorohydrin, which are known to the State of California to cause birth defects or other reproductive harm. For more information go to www.P65Warnings.ca.gov.

PA2860-FN Air Element with Fins
Replaces: Leyland RTC2478
O.D.: 5 1/4 (133.4)
Fins: 6 3/8 (161.9)
I.D.: 2 1/32 (16.7) & 2 5/8 (66.7)
Height: 8 15/32 (215.1)
A. Gskt: [1] Attached
F. Gskt: [1] Included



RS2863XP Extreme Performance Nano Radial Seal Outer Air Element
Fits: Caterpillar, Cummins Engines; Ford, Freightliner, GMC, Hino, IHC, Kenworth, Ottawa, Peterbilt, Sterling Trucks; John Deere Tractors; Massey Ferguson Combines
Use With: RS3501
Replaces: Ford F3HZ-9601-A; GMC 15619013; John Deere RE34962
O.D.: 9 9/32 (235.7)
I.D.: 5 5/32 (131.0) One End
Height: 12 3/4 (323.8)
Related To: RS2863 (Standard Media Version)



PA2861 Inner Air Element
Fits Inside: LL1690-FN, PA1690-FN
Fits: Hitachi, John Deere, Kubota, Yanmar Equipment
Replaces: John Deere CH12881; Kubota 15287-11490
O.D.: 2 7/16 (61.9)
I.D.: 2 1/32 (16.7) & 1 15/16 (49.2)
Height: 9 1/8 (231.8)
A. Gskt: [1] Attached
F. Gskt: G103-N



PA2865 Air Element with Lid
Fits: R.V.I. Trucks
Replaces: Renault 5000809894
O.D.: 9 3/16 (233.4)
Lid: 10 5/32 (258.0)
I.D.: 4 3/32 (104.0) One End
Height: 11 11/16 (296.9)
A. Gskt: [2] Attached



PA2862 Air Element
Fits: Guldner Lift Trucks
Replaces: Guldner 9830715
O.D.: 3 7/8 (98.4)
I.D.: 2 3/8 (60.3)
Height: 2 3/4 (69.9)



PA2866 Air Element
Fits: Hanomag, John Deere, Steyr-Daimler-Puch, Zettelmeyer Equipment; M.A.N. Trucks
Replaces: Deutz 2241034; M.A.N. 81.08304.0028; Zettelmeyer 2121270
O.D.: 7 25/32 (197.6)
Flange: 9 3/4 (247.7)
I.D.: 11/32 (8.7) & 4 1/16 (103.2)
Height: 14 13/16 (376.2)
A. Gskt: [1] Attached



PA2862 FOAM Foam Blanket for PA2862
Notes: OBSOLETE. Availability Limited to Dealer Stock.
Use With: PA2862
O.D.: 3 7/8 (98.4)
I.D.: 3 11/16 (93.7)
Height: 2 3/4 (69.9)



PA2867-FN Outer Air Element with Fins
Replaces: Donaldson P900509
O.D.: 13 7/8 (352.4)
Fins: 15 25/32 (400.8)
I.D.: 5/8 (15.9) & 9 1/2 (241.3)
Height: 14 11/16 (373.1)
A. Gskt: [1] Attached
F. Gskt: [1] Included













RS2863 Radial Seal Outer Air Element
Fits: Caterpillar, Cummins Engines; Ford, Freightliner, GMC, Hino, IHC, Kenworth, Ottawa, Peterbilt, Sterling Trucks; John Deere Tractors; Massey Ferguson Combines
Use With: RS3501
Replaces: Ford F3HZ-9601-A; GMC 15619013; John Deere RE34962
O.D.: 9 9/32 (235.7)
I.D.: 5 5/32 (131.0) One End
Height: 12 3/4 (323.9)
Related To: RS2863XP (Extreme Performance Nano Version)



PA2869 Air Element
Fits: Volvo Buses, Trucks
Replaces: Volvo 347436
O.D.: 8 17/32 (216.7)
I.D.: 11/32 (8.7) & 6 1/32 (153.2)
Height: 10 11/32 (262.7)
A. Gskt: [1] Attached



Measurements Are Shown In Inches And (Millimeters)
WARNING: These products can expose you to chemicals, including Diisononyl Phthalate, Carbon black extracts, Nickel, 1,3 Butadiene, Ethylene Oxide, Epichlorohydrin, which are known to the State of California to cause cancer, and Bisphenol, Ethylene Glycol, Ethylene Oxide, 1,3 Butadiene, Epichlorohydrin, which are known to the State of California to cause birth defects or other reproductive harm. For more information go to www.P65Warnings.ca.gov.

<p>PA2870-FN Air Element with Fins Fits: Air Refiner Housings; Ford Trucks Replaces: Air Refiner ARM90-0408 O.D.: 11 1/8 (282.6) Fins 13 13/16 (350.8) I.D.: 7/8 (22.2) & 6 23/32 (170.7) Height: 13 1/2 (342.9) A. Gskt: [1] Attached F. Gskt: [1] Included</p> 	<p>PA2877-FN Air Element with Fins Replaces: Isuzu 1-14215-196-0 O.D.: 6 1/16 (154.0) Fins 7 13/16 (198.4) I.D.: 1/2 (12.7) & 3 15/32 (88.1) Height: 12 3/8 (314.3) A. Gskt: [1] Attached F. Gskt: [1] Included</p> 
<p>PA2871 Air Element Fits: Air Refiner Housings; Ford Trucks Replaces: Air Refiner ARM90-0405 O.D.: 6 3/8 (161.9) Flange 7 1/2 (190.5) I.D.: 5/8 (15.9) & 5 1/4 (133.4) Height: 13 (330.2) A. Gskt: [1] Attached F. Gskt: [1] Included</p> 	<p>PA2878 Air Element Replaces: Ford 81DB-9601-DB; GMC 93152751 O.D.: 12 5/8 (320.7) I.D.: 8 17/32 (216.7) Height: 4 5/16 (109.5)</p> 
<p>PA2874 Replacement for Ecolite Air Element in Disposable Housing Contains: Bleed Valve Fits: Farr ECO-CM Housings; Freightliner Trucks Replaces: Farr C78105-000 O.D.: 11 (279.4) Inlet: 8 Outlet: 6 Height: 25 13/32 (645.3)</p> 	<p>PA2880 Air Element Fits: Hino Trucks Replaces: Hino 17801-2200 O.D.: 8 1/2 (215.9) I.D.: 7/8 (22.2) & 5 3/8 (136.5) Height: 12 7/8 (327.0) A. Gskt: [1] Attached F. Gskt: [1] Included</p> 
<p>PA2875 Replacement for Ecolite Air Element in Disposable Housing Fits: Farr Optional Filter Housings Replaces: Farr C71338-004 O.D.: 13 17/32 (343.7) Inlet: 10 23/32 Outlet: 7 Height: 19 13/16 (503.2)</p> 	<p>PA2881 Oblong Air Element Replaces: Nissan 16546-06J00 O.D.: 8 (203.2) to 14 9/16 (369.9) I.D.: 5 9/32 (134.1) & 11 13/16 (300.0) Height: 2 7/8 (73.0)</p> 
<p>PA2876 Replacement for Ecolite Air Element in Disposable Housing Fits: Farr Optional Filter Housings Replaces: Farr C71338-001 O.D.: 9 3/4 (247.7) Inlet: 10 23/32 Outlet: 6 Height: 25 7/8 (657.2)</p> 	<p>PA2884 Air Element Fits: Isuzu Trucks Replaces: Isuzu 8-94334-906-0 O.D.: 6 1/16 (154.0) I.D.: 3 7/8 (98.4) & 4 (101.6) Height: 6 3/8 (161.9) A. Gskt: [1] Attached</p> 
	<p>PA2885 Air Element Replaces: Nissan 16546-06J11 O.D.: 6 3/32 (154.8) I.D.: 3 15/32 (88.1) Height: 6 1/8 (155.6) A. Gskt: [2] Attached</p> 

Measurements Are Shown In Inches And (Millimeters)

WARNING: These products can expose you to chemicals, including Diisononyl Phthalate, Carbon black extracts, Nickel, 1,3 Butadiene, Ethylene Oxide, Epichlorohydrin, which are known to the State of California to cause cancer, and Bisphenol, Ethylene Glycol, Ethylene Oxide, 1,3 Butadiene, Epichlorohydrin, which are known to the State of California to cause birth defects or other reproductive harm. For more information go to www.P65Warnings.ca.gov.

PA2887-FN



Outer Air Element with Fins
Notes: OBSOLETE. Availability Limited to Dealer Stock.
Replaces: International 3244397-R1
O.D.: 7 31/32 (202.4)
I.D.: 11/16 (17.5) & 5 3/8 (136.5)
Height: 15 1/2 (393.7)
A. Gskt: [1] Attached
F. Gskt: [1] Included

PA2888



Air Element
Fits: Mercedes-Benz Trucks, Vans
Replaces: Mercedes-Benz 20947004
O.D.: 5 29/32 (150.0)
I.D.: 7/16 (11.1) & 2 25/32 (70.6)
Height: 12 (304.8)
A. Gskt: [2] Attached

PA2889



Inner Air Element
Notes: OBSOLETE. Availability Limited to Dealer Stock.
Fits Inside: PA2890
Fits: Massey Ferguson Wheel Tractors
Replaces: Massey Ferguson 1886638-M91
O.D.: 2 23/32 (69.1)
I.D.: 19/32 (15.1) & 1 31/32 (50.0)
Height: 8 (203.2)
F. Gskt: [1] Included

PA2890



Outer Air Element with Pull Tab
Notes: OBSOLETE. Availability Limited to Dealer Stock.
Fits: Massey Ferguson Wheel Tractors
Use With: PA2889
Replaces: Massey Ferguson 1886637-M91
O.D.: 4 19/32 (116.7)
I.D.: 21/32 (16.7) & 2 15/32 (62.7)
Height: 9 11/32 (237.3)
A. Gskt: [1] Attached
F. Gskt: [1] Washer

PA2891



Air Element
Fits: Iveco Buses, Trucks
Replaces: Iveco 1902128, 3168629
O.D.: 8 15/16 (227.0)
I.D.: 7/16 (11.1) & 4 19/32 (116.7)
Height: 11 5/8 (295.3)
A. Gskt: [1] Attached
F. Gskt: [1] Washer

PA2895



Air Element
Replaces: Mazda SLA2-13-Z40A
O.D.: 7 15/16 (201.6)
I.D.: 29/32 (23.0) & 4 31/32 (126.2)
Height: 8 15/32 (215.1)
A. Gskt: [1] Attached
F. Gskt: [1] Included

PA2896



Inner Air Element
Fits Inside: PA2897
Replaces: Donaldson P128486
O.D.: 4 19/32 (116.7)
I.D.: 21/32 (16.7) & 3 11/32 (84.9)
Height: 10 3/4 (273.1)
A. Gskt: [1] Attached
F. Gskt: [1] Included

PA2897



Outer Air Element with 2 Lift Bars
Use With: PA2896
Replaces: Rycro HDA5495
O.D.: 8 13/32 (213.5)
I.D.: 21/32 (16.7) & 5 25/32 (146.8)
Height: 12 3/8 (314.3)
A. Gskt: [1] Attached
F. Gskt: [1] Included

PA2900



Air Element
Replaces: Heavy Duty Air A02028
O.D.: 11 7/8 (301.6)
I.D.: 17/32 (13.5) & 7 1/8 (181.0)
Height: 26 1/2 (673.1)
A. Gskt: [1] Attached

PA2902



Outer Air Element
Fits: Caterpillar, Hitachi, John Deere, Kawasaki, Komatsu Equipment
Use With: PA2903
Replaces: Caterpillar 7Y1196; Hitachi 4240294; Kawasaki 3098170130; Komatsu 5610-21-2330
O.D.: 12 1/8 (308.0)
I.D.: 29/32 (23.0) & 7 11/16 (195.3)
Height: 24 1/2 (622.3)
A. Gskt: [1] Attached
F. Gskt: [1] Included











PA2903



Inner Air Element
Fits Inside: PA2902
Fits: Caterpillar, Hitachi, John Deere, Kawasaki, Komatsu Equipment
Replaces: Caterpillar 7Y1197; Hitachi 4240295; Kawasaki 3098170140; Komatsu 5610-21-2320
O.D.: 7 1/4 (184.2)
I.D.: 11/16 (17.5) & 6 3/16 (157.2)
Height: 23 1/2 (596.9)
A. Gskt: [1] Attached
F. Gskt: G103-N

Measurements Are Shown In Inches And (Millimeters)

WARNING: These products can expose you to chemicals, including Diisononyl Phthalate, Carbon black extracts, Nickel, 1,3 Butadiene, Ethylene Oxide, Epichlorohydrin, which are known to the State of California to cause cancer, and Bisphenol, Ethylene Glycol, Ethylene Oxide, 1,3 Butadiene, Epichlorohydrin, which are known to the State of California to cause birth defects or other reproductive harm. For more information go to www.P65Warnings.ca.gov.

<p>PA2904 Air Element Replaces: Isuzu 8-94135-886-0; Nissan 16546-T3400 O.D.: 6 3/32 (154.8) I.D.: 1/2 (12.7) & 3 15/32 (88.1) Height: 7 7/8 (200.0) A. Gskt: [1] Attached F. Gskt: [1] Included</p> 	<p>PA2913 Air Element Replaces: Isuzu 8-94107-690 O.D.: 6 3/32 (154.8) I.D.: 1/2 (12.7) & 3 15/32 (88.1) Height: 9 19/32 (243.7) A. Gskt: [1] Attached F. Gskt: [1] Included</p> 
<p>PA2905 Air Element with Lid Replaces: Fendt F135201090020; Volvo 4541565 O.D.: 5 (127.0) Lid 6 7/32 (158.0) I.D.: 11/32 (8.7) & 2 17/32 (64.3) Height: 11 17/32 (292.9) A. Gskt: [1] Attached End Seals: [1] Attached</p> 	<p>PA2914 Air Element Fits: Volvo Trucks Replaces: Volvo 1660376 O.D.: 10 5/8 (269.9) I.D.: 13/32 (10.3) & 7 1/4 (184.2) Height: 22 27/32 (580.2) A. Gskt: [2] Attached</p> 
<p>PA2906 Air Element Replaces: Mann & Hummel C15124/1 O.D.: 6 1/16 (154.0) I.D.: 3 1/2 (88.9) Height: 9 1/32 (229.4)</p> 	<p>PA2915 Air Element Fits: Volvo Trucks Replaces: Volvo 1660377, 16618084 O.D.: 6 7/8 (174.6) I.D.: 13/32 (10.3) & 5 7/16 (138.1) Height: 21 19/32 (548.5) A. Gskt: [1] Attached</p> 
<p>PA2909 Air Element with Lift Bars Replaces: Air Refiner ARM12-8487 O.D.: 8 1/4 (209.6) I.D.: 5/8 (15.9) & 5 3/4 (146.0) Height: 10 1/2 (266.7) A. Gskt: [1] Attached F. Gskt: [1] Included</p> 	<p>PA2932 Air Element Fits: Industrial Applications Replaces: Heavy Duty Air A02067 O.D.: 6 27/32 (173.8) I.D.: 7/16 (11.1) & 4 3/16 (106.4) Height: 9 (228.6) F. Gskt: [1] Included</p> 
<p>PA2912 Air Element Replaces: Knecht AG300 O.D.: 5 3/16 (131.8) I.D.: 1/2 (12.7) & 2 5/8 (66.7) Height: 6 25/32 (172.2) A. Gskt: [1] Attached F. Gskt: [1] Included</p> 	<p>PA2933 Air Element Notes: OBSOLETE. Availability Limited to Dealer Stock. Fits: Mining Drills Replaces: Heavy Duty Air A100195-192 O.D.: 1 31/32 (50.0) I.D.: 1 1/8 (28.6) Height: 1 13/16 (46.0)</p> 
	<p>PA2936 Panel Air Element Fits: Industrial Applications Replaces: Heavy Duty Air A7523 Length: 15 (381.0) Width: 7 (177.8) Height: 2 3/16 (55.6)</p> 

Measurements Are Shown In Inches And (Millimeters)

WARNING: These products can expose you to chemicals, including Diisononyl Phthalate, Carbon black extracts, Nickel, 1,3 Butadiene, Ethylene Oxide, Epichlorohydrin, which are known to the State of California to cause cancer, and Bisphenol, Ethylene Glycol, Ethylene Oxide, 1,3 Butadiene, Epichlorohydrin, which are known to the State of California to cause birth defects or other reproductive harm. For more information go to www.P65Warnings.ca.gov.

PA2938 Air Element

Fits: Industrial Applications
Replaces: Heavy Duty Air A3347
O.D.: 8 1/32 (204.0)
I.D.: 6 1/16 (154.0)
Height: 12 (304.8)
A. Gskt: [2] Attached

PA2946 Air Element

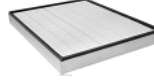
O.D.: 6 5/8 (168.3)
I.D.: 3/8 (9.5) & 4 1/4 (108.0)
Height: 15 17/32 (394.5)
A. Gskt: [1] Attached
F. Gskt: [1] Included

PA2942 Outer Air Element

Fits: Mercedes-Benz Trucks, Vans
Replaces: Mercedes-Benz 30944204
O.D.: 12 3/4 (323.8)
I.D.: 7/16 (11.1) & 6 5/16 (160.3)
Height: 10 1/16 (255.6)
A. Gskt: [1] Attached
F. Gskt: [1] Included

PA2947 Panel Air Element

Fits: American Lincoln Floor Cleaning Equipment
Replaces: American Lincoln 82404070
Length: 24 (609.6)
Width: 19 11/16 (500.1)
Height: 2 9/16 (65.1)
A. Gskt: [1] Attached

PA2944-FN Air Element with Fins

Fits: Ford, New Holland Equipment
Replaces: Ford E9NN-9601-EA, SBA314531126
O.D.: 4 3/32 (104.0)
 Fins 5 1/8 (130.2)
I.D.: 13/32 (10.3) & 2 15/32 (62.7)
Height: 10 5/16 (261.9)
A. Gskt: [1] Attached
F. Gskt: [1] Included

PA2948 Air Element

Replaces: Hino 17801-2440
O.D.: 7 1/2 (190.5)
I.D.: 4 1/8 (104.8)
Height: 11 13/32 (289.7)
A. Gskt: [1] Attached
F. Gskt: [1] Included

LL2945 Long Life Outer Air Element

Fits: John Deere, Tamrock Equipment; R.V.I., Volvo Buses, Trucks
Replaces: John Deere AZ39761; Renault 5000953712
O.D.: 12 1/32 (305.6)
I.D.: 5/8 (15.9) & 7 11/16 (195.3)
Height: 16 11/16 (423.9)
A. Gskt: [1] Attached
F. Gskt: G103-N
Related To: PA2945 (Standard Media Version)

PA2949-FN Air Element with Fins

Contains: Flame Retardant Media
Fits: Nissan Lift Trucks
Replaces: Nissan 16546-51H10B
O.D.: 5 1/4 (133.4)
 Fins 6 3/8 (161.9)
I.D.: 21/32 (16.7) & 2 27/32 (72.2)
Height: 9 1/2 (241.3)
A. Gskt: [1] Attached
F. Gskt: [1] Included

PA2945 Outer Air Element

Fits: John Deere, Tamrock Equipment; R.V.I., Volvo Buses, Trucks
Replaces: John Deere AZ39761; Renault 5000953712
O.D.: 12 1/32 (305.6)
I.D.: 5/8 (15.9) & 7 11/16 (195.3)
Height: 16 11/16 (423.9)
A. Gskt: [1] Attached
F. Gskt: G103-N
Related To: LL2945 (Long-Life Media Version)











PA2950 Air Element

Replaces: Air Refiner ARM913
O.D.: 9 7/32 (234.2)
I.D.: 29/32 (23.0) & 4 27/32 (123.0)
Height: 13 15/32 (342.1)
A. Gskt: [1] Attached
F. Gskt: [1] Included

PA2951 Air Element

Replaces: Air Refiner ARM13-7982
O.D.: 11 1/8 (282.6)
I.D.: 7/8 (22.2) & 6 23/32 (170.7)
Height: 16 1/2 (419.1)
A. Gskt: [1] Attached
F. Gskt: [1] Included

PA2951 Air Element

Replaces: Air Refiner ARM13-7982
O.D.: 11 1/8 (282.6)
I.D.: 7/8 (22.2) & 6 23/32 (170.7)
Height: 16 1/2 (419.1)
A. Gskt: [1] Attached
F. Gskt: [1] Included











Measurements Are Shown In Inches And (Millimeters)

WARNING: These products can expose you to chemicals, including Diisononyl Phthalate, Carbon black extracts, Nickel, 1,3 Butadiene, Ethylene Oxide, Epichlorohydrin, which are known to the State of California to cause cancer, and Bisphenol, Ethylene Glycol, Ethylene Oxide, 1,3 Butadiene, Epichlorohydrin, which are known to the State of California to cause birth defects or other reproductive harm. For more information go to www.P65Warnings.ca.gov.

<p>PA2952 Air Element Replaces: Air Refiner ARM13-7981 O.D.: 12 3/32 (307.2) I.D.: 7/8 (22.2) & 7 11/16 (195.3) Height: 18 1/2 (469.9) A. Gskt: [1] Attached F. Gskt: [1] Included</p> 	<p>PA2957 Inner Air Element Fits Inside: PA2956-FN Fits: Ford Trucks Replaces: Donaldson P900472; Motorcraft AFA107 O.D.: 8 1/4 (209.6) I.D.: 21/32 (16.7) & 7 1/8 (181.0) Height: 17 1/8 (435.0) A. Gskt: [1] Attached F. Gskt: G103-N</p> 
<p>PA2953 Air Element Replaces: Air Refiner ARM14-0925 O.D.: 9 7/32 (234.2) I.D.: 29/32 (23.0) & 4 27/32 (123.0) Height: 15 3/8 (390.5) A. Gskt: [1] Attached F. Gskt: [1] Included</p> 	<p>PA2958 Air Element Fits: Bedford Buses, Trucks Replaces: GMC 7964609 O.D.: 8 5/16 (211.1) I.D.: 6 1/32 (153.2) Height: 8 1/32 (204.0) A. Gskt: [1] Attached</p> 
<p>PA2954-FN Outer Air Element with Fins Replaces: Air Refiner ARM12-7172 O.D.: 7 15/16 (201.6) Fins 9 13/16 (249.2) I.D.: 11/16 (17.5) & 3 9/16 (90.5) Height: 10 3/8 (263.5) A. Gskt: [1] Attached F. Gskt: G103-N</p> 	<p>PA2959-FN Outer Air Element with Fins Fits: Ford Buses, Trucks Use With: PA2960 Replaces: Air Refiner ARM90-0023; Motorcraft AFA93 O.D.: 13 7/8 (352.4) Fins 15 25/32 (400.8) I.D.: 29/32 (23.0) & 9 1/2 (241.3) Height: 15 1/2 (393.7) A. Gskt: [1] Attached F. Gskt: [1] Included</p> 
<p>PA2955 Air Element with Lid Fits: Mercedes-Benz Trucks, Vans Replaces: Mercedes-Benz 29042404 O.D.: 12 7/8 (327.0) Lid 15 1/4 (387.3) I.D.: 13/32 (10.3) & 6 9/16 (166.7) Height: 14 1/32 (356.4) A. Gskt: [2] Attached</p> 	<p>PA2960 Inner Air Element Fits Inside: PA2959-FN Fits: Ford Buses, Trucks Replaces: Air Refiner ARM90-0024; Motorcraft AFA94 O.D.: 8 1/4 (209.6) I.D.: 21/32 (16.7) & 7 1/8 (181.0) Height: 14 3/8 (365.1) A. Gskt: [1] Attached F. Gskt: G103-N</p> 
<p>PA2956-FN Outer Air Element with Fins Fits: Ford Trucks Use With: PA2957 Replaces: Donaldson P900471; Motorcraft AFA106 O.D.: 13 13/16 (350.8) Fins 15 25/32 (400.8) I.D.: 29/32 (23.0) & 9 1/2 (241.3) Height: 18 13/32 (467.5) A. Gskt: [1] Attached F. Gskt: [1] Included</p> 	<p>PA2961-FN Outer Air Element with Fins Fits: Hino Buses, Trucks Replaces: Hino 17801-1580, 17801-1720 O.D.: 7 15/16 (201.6) Fins 9 31/32 (253.2) I.D.: 1/2 (12.7) & 3 13/16 (96.8) Height: 11 7/8 (301.6) A. Gskt: [1] Attached F. Gskt: [1] Included</p> 
	<p>PA2962 Air Element Replaces: Air Refiner ARM90-0556; Donaldson P900556 O.D.: 12 3/32 (307.2) I.D.: 7/8 (22.2) & 7 23/32 (196.1) Height: 23 1/2 (596.9) A. Gskt: [1] Attached F. Gskt: [1] Included</p> 

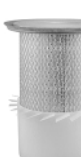
Measurements Are Shown In Inches And (Millimeters)

WARNING: These products can expose you to chemicals, including Diisononyl Phthalate, Carbon black extracts, Nickel, 1,3 Butadiene, Ethylene Oxide, Epichlorohydrin, which are known to the State of California to cause cancer, and Bisphenol, Ethylene Glycol, Ethylene Oxide, 1,3 Butadiene, Epichlorohydrin, which are known to the State of California to cause birth defects or other reproductive harm. For more information go to www.P65Warnings.ca.gov.

<p>PA2963 Air Element  Fits: Volvo Trucks Replaces: Volvo 6897063 O.D.: 10 5/8 (269.9) I.D.: 21/32 (16.7) & 7 1/4 (184.2) Height: 22 13/16 (579.4) A. Gskt: [1] Attached F. Gskt: G103-N</p>	<p>PA2971 Air Element  Replaces: Leyland ACU8498 O.D.: 9 5/32 (232.6) I.D.: 5/8 (15.9) & 4 7/8 (123.8) Height: 15 15/32 (392.9) F. Gskt: [1] Included, [1] Metal Washer</p>
<p>PA2964 Air Element  Fits: Volvo Trucks Replaces: Volvo 6897064 O.D.: 7 1/8 (181.0) I.D.: 21/32 (16.7) & 5 1/2 (139.7) Height: 21 9/16 (547.7) A. Gskt: [1] Attached F. Gskt: [1] Included</p>	<p>PA2973 Air Element  Fits: Torit Air Cleaning Systems Replaces: Torit 8PP22343-00 O.D.: 12 3/4 (323.8) I.D.: 8 11/32 (211.9) Height: 26 1/2 (673.1) A. Gskt: [1] Attached</p>
<p>PA2967 Air Element  Replaces: Air Refiner ARM13-8789; Donaldson P138789 O.D.: 7 1/4 (184.2) I.D.: 21/32 (16.7) & 6 3/16 (157.2) Height: 16 1/2 (419.1) A. Gskt: [1] Attached F. Gskt: [1] Included</p>	<p>PA2976-FN Outer Air Element with Fins and Lid  Fits: Fiat-Allis, Massey Ferguson Equipment; Lister Engines Use With: PA2700 Replaces: Fiat 79062702; Lister 36607282; Massey Ferguson 3310358-M1 O.D.: 6 13/32 (162.7) Lid 6 25/32 (172.2) I.D.: 5/8 (15.9) & 2 3/4 (69.9) Height: 12 (304.8) A. Gskt: [1] Attached, [1] Wing Nut</p>
<p>PA2968-FN Air Element with Fins and Lid  Fits: J.C. Bamford Equipment Replaces: J.C. Bamford 32/906801 O.D.: 6 25/32 (172.2) Lid 8 3/8 (212.7) I.D.: 5/8 (15.9) & 3 15/32 (88.1) Height: 11 1/2 (292.1) A. Gskt: [1] Attached, [1] Wing Nut</p>	<p>PA2977-FN Outer Air Element with Fins and Lid  Fits: J.C. Bamford Equipment Use With: PA2419 Replaces: J.C. Bamford 32/903601 O.D.: 6 3/32 (154.8) Lid 8 3/8 (212.7) I.D.: 21/32 (16.7) & 3 15/32 (88.1) Height: 15 1/2 (393.7) I.Gskt: [1] Included A. Gskt: [1] Attached F. Gskt: [1] Wing Nut</p>
<p>PA2970 Outer Air Element with Lid  Fits: J.C. Bamford Equipment Use With: PA2689 Replaces: J.C. Bamford 32/903201 O.D.: 6 15/16 (176.2) Lid 8 3/8 (212.7) I.D.: 5/8 (15.9) & 3 7/16 (87.3) Height: 11 9/16 (293.7) A. Gskt: [1] Attached F. Gskt: [1] Wing Nut</p>	<p>PA2978 Air Element  Fits: Benford Construction Equipment Replaces: Gardner L22045 O.D.: 5 1/2 (139.7) I.D.: 3 1/8 (79.4) Height: 4 27/32 (123.0)</p>

Measurements Are Shown In Inches And (Millimeters)

WARNING: These products can expose you to chemicals, including Diisononyl Phthalate, Carbon black extracts, Nickel, 1,3 Butadiene, Ethylene Oxide, Epichlorohydrin, which are known to the State of California to cause cancer, and Bisphenol, Ethylene Glycol, Ethylene Oxide, 1,3 Butadiene, Epichlorohydrin, which are known to the State of California to cause birth defects or other reproductive harm. For more information go to www.P65Warnings.ca.gov.

PA2980 Set of 2 Air Elements
Contains: Outer and Inner Elements
Replaces: Ford 2708E-9601-A
Outer
O.D.: 11 31/32 (304.0)
I.D.: 8 17/32 (216.7)
Height: 3 7/32 (81.8)
Inner
O.D. 6 21/32 (169.1)
I.D. 3 3/16 (81.0)
Height 3 7/16 (87.3)



HSG3078 Housing and Radial Seal Air Element
Notes: May use AB3349 Mounting Band.
Contains: RS3715 Radial Seal Air Element
 Dump Valve
Housing
O.D.: 5 17/32 (140.5)
Inlet: 1 3/4
Outlet: 1 7/8
Height: 10 11/16 (271.5)
RS3715
O.D. 3 17/32 (89.7)
I.D. 1 3/4 (44.5)
Height 7 (177.8)
Related To: HSG3077 (Horizontal Outlet)



PA2982 Air Element with 4 Bolt Holes in Flange
Fits: Volvo Trucks
Replaces: Volvo 1665563
O.D.: 10 5/32 (258.0)
 Flange 10 15/16 (277.8)
I.D.: 6 9/32 (159.5) One End
Height: 21 17/32 (546.9)
A. Gskt: [1] Attached



AB3349 Mounting Band
Contains: [1] Mounting Band
 [1] Bolt
 [1] Nut
 [1] Spring
 [1] Washer
Use With: HSG3077, HSG3078



PA2984 Air Element
Fits: Ford Trucks
Replaces: Ford 87HX-9601-AA
O.D.: 9 9/16 (242.9)
I.D.: 7 1/4 (184.2)
Height: 3 3/4 (95.3)



PA3404 Air Element
Fits: Torit ECB Housings
Replaces: Torit 8PP21028-00
O.D.: 12 25/32 (324.6)
I.D.: 17/32 (13.5) & 8 11/32 (211.9)
Height: 26 1/2 (673.1)
A. Gskt: [1] Attached
F. Gskt: [1] Included



PA2988 Air Element
Fits: Industrial Dust Collectors
Replaces: Farr C72518-001; Torit 8PP32582-00
O.D.: 12 3/4 (323.8)
 Flange 15 31/32 x 14 1/4 (405.6 x 362.0)
I.D.: 8 5/16 (211.1) One End
Height: 26 5/8 (676.3)
A. Gskt: [1] Attached
Related To: PA3580 (with Flame Retardant Media)



PA3405 Air Element with Lift Tab
Notes: OBSOLETE. Availability Limited to Dealer Stock.
Fits: Bedford Trucks
Replaces: GMC 91107151
O.D.: 6 15/32 (164.3)
 Flange Gasket 7 7/8 (200.0)
I.D.: 21/32 (16.7) & 3 7/8 (98.4)
Height: 14 11/32 (364.3)
A. Gskt: [2] Attached
F. Gskt: [2] Included



PA2989 Air Element
Fits: Industrial Dust Collectors
Replaces: Endustra 51013; Farr 84378; TDC 10000156
O.D.: 12 3/4 (323.8)
 Flange 15 31/32 x 14 7/32 (405.6 x 361.2)
I.D.: 8 5/16 (211.1) One End
Height: 22 5/8 (574.7)
A. Gskt: [1] Attached



PA3406-FN Air Element with Fins
Fits: White Equipment
Replaces: White 33-0032042
O.D.: 6 3/32 (154.8)
 Fins 7 13/16 (198.4)
I.D.: 3/4 (19.0) & 3 15/32 (88.1)
Height: 7 7/8 (200.0)
A. Gskt: [1] Attached
F. Gskt: G103-N













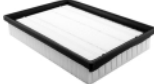

HSG3077 Housing and Radial Seal Air Element
Notes: May use AB3349 Mounting Band.
Contains: RS3715 Radial Seal Air Element
 Dump Valve
Housing
O.D.: 5 17/32 (140.5)
Inlet: 1 3/4
Outlet: 1 7/8
Height: 10 11/16 (271.5)
RS3715
O.D. 3 17/32 (89.7)
I.D. 1 3/4 (44.5)
Height 7 (177.8)
Related To: HSG3078 (Vertical Outlet)

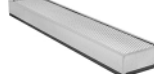











Measurements Are Shown In Inches And (Millimeters)

WARNING: These products can expose you to chemicals, including Diisononyl Phthalate, Carbon black extracts, Nickel, 1,3 Butadiene, Ethylene Oxide, Epichlorohydrin, which are known to the State of California to cause cancer, and Bisphenol, Ethylene Glycol, Ethylene Oxide, 1,3 Butadiene, Epichlorohydrin, which are known to the State of California to cause birth defects or other reproductive harm. For more information go to www.P65Warnings.ca.gov.

<p>PA3411-FN Air Element with Fins Replaces: Daihatsu 17801-87303; Toyota 17801-87304 O.D.: 6 1/16 (154.0) Fins 7 7/8 (200.0) I.D.: 1/2 (12.7) & 3 15/32 (88.1) Height: 8 9/32 (210.3) A. Gskt: [1] Attached F. Gskt: [1] Metal Washer</p> 	<p>PA3421 Panel Air Element Replaces: Donaldson P131231; Heavy Duty Air A1231 Length: 32 (812.8) Width: 9 (228.6) Height: 2 9/16 (65.1)</p> 
<p>PA3414 Cab Air Element Fits: V.M.E., Volvo Loaders, Trucks Replaces: Volvo 4771477 Length: 10 5/8 (269.9) Width: 7 13/32 (188.1) Height: 1 25/32 (45.2)</p> 	<p>PA3430 Inner Air Element Fits Inside: PA3439-FN Fits: Dresser Equipment Replaces: Dresser 1129112-C1 O.D.: 4 1/8 (104.8) I.D.: 21/32 (16.7) & 3 (76.2) Height: 14 1/4 (362.0) A. Gskt: [1] Attached F. Gskt: G103-N</p> 
<p>PA3415 Air Element with Lid Replaces: Isuzu 1-14215-156-0 O.D.: 7 3/8 (187.3) Lid 9 9/32 (235.7) I.D.: 21/32 (16.7) & 4 11/16 (119.1) Height: 11 5/16 (287.3) A. Gskt: [2] Attached F. Gskt: [1] Included</p> 	<p>PA3435-FN Air Element with Fins Fits: Manitou Equipment Use With: PA4881 Replaces: Manitou 177129 O.D.: 5 3/16 (131.8) Fins 6 3/8 (161.9) I.D.: 21/32 (16.7) & 2 5/8 (66.7) Height: 11 1/16 (281.0) A. Gskt: [1] Attached F. Gskt: [1] Included, [1] Wing Nut</p> 
<p>PA3416 Air Element Fits: Isuzu Trucks Replaces: Isuzu 1-14215-157-0 O.D.: 4 19/32 (116.7) Boot 5 13/16 (147.6) I.D.: 5/8 (15.9) & 3 7/16 (87.3) Height: 10 (254.0) A. Gskt: [1] Attached F. Gskt: [1] Included</p> 	<p>PA3438 Panel Air Element Fits: FMC Sweepers Replaces: FMC 304973 Length: 29 15/16 (760.4) Width: 6 (152.4) Height: 2 9/16 (65.1)</p> 
<p>PA3417 Inner Air Element Fits Inside: PA2761 Fits: Mitsubishi Trucks Replaces: Mitsubishi ME033773 O.D.: 5 1/4 (133.4) I.D.: 21/32 (16.7) & 4 1/8 (104.8) Height: 11 25/32 (299.2) A. Gskt: [1] Attached F. Gskt: [1] Included</p> 	<p>PA3439-FN Outer Air Element with Fins Fits: Dresser Equipment Use With: PA3430 Replaces: Dresser 1129111-C1, 1129111-C2 O.D.: 6 7/8 (174.6) Fins 8 3/4 (222.3) I.D.: 21/32 (16.7) & 4 3/16 (106.4) Height: 15 5/16 (388.9) A. Gskt: [1] Included F. Gskt: G103-N</p> 
<p>PA3419 Air Element Fits: Lister Engines Replaces: Lister-Petter 366-07188 O.D.: 5 7/8 (149.2) I.D.: 3 7/16 (87.3) Height: 2 7/8 (73.0) A. Gskt: [1] Attached</p> 	<p>PA3440 Cab Air Element Fits: Caterpillar Equipment Replaces: Caterpillar 6T0988 Length: 21 1/4 (539.8) Width: 5 29/32 (150.0) Height: 2 11/16 (68.3) A. Gskt: [1] Attached</p> 
<p>PA3420 Panel Air Element Replaces: Donaldson P123440 Length: 17 (431.8) Width: 8 (203.2) Height: 2 3/16 (55.6)</p> 	<p>PA3442 Panel Air Element Replaces: Pixall 6007-0024 Length: 31 (787.4) Width: 5 (127.0) Height: 2 3/16 (55.6)</p> 

Measurements Are Shown In Inches And (Millimeters)

WARNING: These products can expose you to chemicals, including Diisononyl Phthalate, Carbon black extracts, Nickel, 1,3 Butadiene, Ethylene Oxide, Epichlorohydrin, which are known to the State of California to cause cancer, and Bisphenol, Ethylene Glycol, Ethylene Oxide, 1,3 Butadiene, Epichlorohydrin, which are known to the State of California to cause birth defects or other reproductive harm. For more information go to www.P65Warnings.ca.gov.

<p>PA3446</p>  <p>Air Element Fits: R.V.I. Buses, Trucks Replaces: Renault 5000243970 O.D.: 8 7/8 (225.4) I.D.: 5/8 (15.9) & 4 1/8 (104.8) Height: 13 3/8 (339.7) A. Gskt: [1] Attached</p>	<p>PA3457</p>  <p>Air Element Fits: Bucyrus-Erie Blast Hole Drill Dust Collectors Replaces: Heavy Duty Air A07-200 O.D.: 5 11/16 (144.5) I.D.: 3 9/16 (90.5) Height: 4 27/32 (123.0) A. Gskt: [2] Attached</p>
<p>PA3447</p>  <p>Air Element with Lid Fits: Lister Engines Replaces: Lister 382-07898 O.D.: 6 11/32 (161.1) Lid 7 1/8 (181.0) I.D.: 11/16 (17.5) & 2 27/32 (72.2) Height: 12 (304.8) A. Gskt: [1] Attached F. Gskt: G103-N, [1] Wing Nut</p>	<p>PA3458</p>  <p>Air Element Fits: Torit DownFlo EAC Dust Collectors Replaces: Endustra 51053A; Torit 8PP23099-00 O.D.: 12 3/4 (323.8) I.D.: 8 11/32 (211.9) Height: 26 1/2 (673.1) A. Gskt: [1] Attached</p>
<p>PA3448</p>  <p>Outer Air Element with Lid Fits: Hino Trucks Use With: PA3657 Replaces: Hino 17801-2620 O.D.: 7 3/8 (187.3) Lid 9 9/32 (235.7) I.D.: 21/32 (16.7) & 4 11/16 (119.1) Height: 13 1/2 (342.9) A. Gskt: [2] Attached F. Gskt: G103-N</p>	<p>PA3460</p>  <p>Air Element Fits: Torit Air Cleaning Systems Replaces: Endustra 51049; Torit 8PP18803-00 O.D.: 7 15/16 (201.6) I.D.: 11/16 (17.5) & 3 9/16 (90.5) Height: 16 1/2 (419.1) A. Gskt: [1] Included F. Gskt: [1] Included</p>
<p>PA3452</p>  <p>Air Element Fits: Dust Collector Applications Replaces: Ingersoll-Rand 56958945; Tipton 128495, FC3R1001 O.D.: 10 3/8 (263.5) I.D.: 15/16 (23.8) & 6 1/16 (154.0) Height: 26 1/2 (673.1) A. Gskt: [1] Attached F. Gskt: [1] Included</p>	<p>PA3461</p>  <p>Air Element Fits: Torit DownFlo II Dust Collectors Replaces: Torit 8PP32537-00 O.D.: 13 13/16 (350.8) I.D.: 9 1/2 (241.3) Height: 26 1/2 (673.1) A. Gskt: [1] Attached</p>
<p>PA3453</p>  <p>Air Element Replaces: Fleetguard AF263 O.D.: 12 1/32 (305.6) I.D.: 7 7/8 (200.0) One End Height: 16 1/2 (419.1) A. Gskt: [1] Attached</p>	<p>PA3463</p>  <p>Air Element Notes: Inside-Out Flow Direction Fits: Torit DownFlo II Dust Collectors Replaces: Torit 8PP42057-00 O.D.: 13 13/16 (350.8) I.D.: 9 1/2 (241.3) Height: 26 1/2 (673.1) A. Gskt: [1] Attached Related To: PA3614 (with Flame Retardant Media)</p>

Measurements Are Shown In Inches And (Millimeters)

WARNING: These products can expose you to chemicals, including Diisononyl Phthalate, Carbon black extracts, Nickel, 1,3 Butadiene, Ethylene Oxide, Epichlorohydrin, which are known to the State of California to cause cancer, and Bisphenol, Ethylene Glycol, Ethylene Oxide, 1,3 Butadiene, Epichlorohydrin, which are known to the State of California to cause birth defects or other reproductive harm. For more information go to www.P65Warnings.ca.gov.

PA3464



Air Element
Fits: Quincy Compressors
Replaces: Quincy 23458-5
O.D.: 12 1/2 (317.5)
I.D.: 13/32 (10.3) & 7 1/2 (190.5)
Height: 22 1/2 (571.5)
A. Gskt: [1] Attached
F. Gskt: [1] Included

PA3471



Inner Air Element with 8 Bolt Holes
Fits Inside: PA1673
Fits: Caterpillar Equipment
Replaces: Caterpillar 7C1062
O.D.: 3 3/4 (95.3)
 Flange 6 11/16 (169.9)
I.D.: 2 5/8 (66.7) One End
Height: 10 1/16 (255.6)
A. Gskt: [1] Attached

PA3466-FN



Air Element with Fins
Notes: Sometimes used with PA2689 Inner Air Element
Fits: Massey Ferguson Equipment
Replaces: Massey Ferguson 1096468-M91
O.D.: 6 3/32 (154.8)
 Fins 7 13/16 (198.4)
I.D.: 3/4 (19.0) & 3 15/32 (88.1)
Height: 11 1/2 (292.1)
A. Gskt: [1] Attached
F. Gskt: G103-N

PA3472



Outer Air Element
Fits: John Deere Lawn & Garden Tractors
Use With: PA3565
Replaces: John Deere AM108242; Woodgate WGA1856
O.D.: 3 1/4 (82.6)
I.D.: 21/32 (16.7) & 2 1/8 (54.0)
Height: 7 1/2 (190.5)
A. Gskt: [1] Attached
F. Gskt: [1] Washer, [1] Wing Nut

PA3467



Air Element with Lift Tab
Fits: Bartco Equipment; Gardner Denver Compressors
Replaces: Gardner Denver 1157641
O.D.: 8 1/2 (215.9)
I.D.: 7/16 (11.1) & 5 3/8 (136.5)
Height: 15 1/4 (387.4)
A. Gskt: [1] Attached
F. Gskt: [1] Included

PA3472-FN



Outer Air Element with Fins
Fits: John Deere Equipment
Use With: PA3565
Replaces: John Deere AM108243
O.D.: 3 1/4 (82.6)
 Fins 4 1/4 (108.0)
I.D.: 21/32 (16.7) & 2 1/8 (54.0)
Height: 7 1/2 (190.5)
A. Gskt: [1] Attached
F. Gskt: G103-N

PA3469



Outer Air Element with Lift Tab
Fits: John Deere Tractors
Use With: PA3470
Replaces: John Deere RE46310
O.D.: 9 1/8 (231.8)
I.D.: 7/16 (11.1) & 5 13/16 (147.6)
Height: 17 (431.8)
A. Gskt: [1] Attached
F. Gskt: [1] Included

PA3473



Panel Air Element
Replaces: Donaldson P105958
Length: 10 (254.0)
Width: 10 (254.0)
Height: 2 9/16 (65.1)

PA3474



Air Element
Fits: Blue Bird Buses
Replaces: Blue Bird 4298501
O.D.: 9 7/32 (234.2)
I.D.: 21/32 (16.7) & 4 27/32 (123.0)
Height: 12 3/8 (314.3)
A. Gskt: [1] Attached
F. Gskt: G103-N

PA3470



Inner Air Element
Contains: Flame Retardant Media
Fits Inside: PA3469
Fits: John Deere Tractors
Replaces: John Deere RE46311
O.D.: 5 11/16 (144.5)
I.D.: 7/16 (11.1) & 4 13/32 (111.9)
Height: 15 (381.0)
A. Gskt: [1] Attached
F. Gskt: [1] Included

PA3475



Air Element
Fits: Ford Buses, Trucks
Replaces: Ford F1HZ-9601-A, F1HZ-9601-C
O.D.: 7 11/32 (186.5)
I.D.: 7/16 (11.1) & 5 3/8 (136.5)
Height: 13 7/8 (352.4)
A. Gskt: [1] Attached
F. Gskt: [1] Included

Measurements Are Shown In Inches And (Millimeters)

WARNING: These products can expose you to chemicals, including Diisononyl Phthalate, Carbon black extracts, Nickel, 1,3 Butadiene, Ethylene Oxide, Epichlorohydrin, which are known to the State of California to cause cancer, and Bisphenol, Ethylene Glycol, Ethylene Oxide, 1,3 Butadiene, Epichlorohydrin, which are known to the State of California to cause birth defects or other reproductive harm. For more information go to www.P65Warnings.ca.gov.

PA3476 Air Element
Fits: Kubota Equipment
Replaces: Kubota 15741-11080
O.D.: 4 3/32 (104.0)
 Flange 5 13/16 (147.6)
I.D.: 9/32 (7.1) & 2 1/2 (63.5)
Height: 10 5/16 (261.9)
A. Gskt: [2] Attached
F. Gskt: [1] Included



PA3477 Air Element with Lid
Fits: DAF, R.V.I., Scania, Volvo Buses, Trucks;
 Faun Frisch, Hanomag Equipment
Replaces: DAF 110376; Faun Frisch 746385;
 Hanomag 195946201; Scania 365727
O.D.: 9 17/32 (242.1)
 Lid 12 1/4 (311.2)
I.D.: 7/16 (11.1) & 5 5/32 (131.0)
Height: 19 3/8 (492.1)
A. Gskt: [2] Attached
F. Gskt: [1] Included



PA3478 Conical-Shaped Air Element
Replaces: GMC 25096444
O.D.: 5 13/16 (147.6)
 to 8 21/32 (219.9)
I.D.: 5 3/16 (131.8) One End
Height: 28 1/2 (723.9)
A. Gskt: [1] Attached
F. Gskt: [1] Included
Related To: PA3478XP (Extreme Performance
 Nano Version)



PA3478XP Extreme Performance Nano Conical-Shaped Air Element
Replaces: Donaldson P604430
O.D.: 5 13/16 (147.6)
 to 8 21/32 (219.9)
I.D.: 5 3/16 (131.8) One End
Height: 28 1/2 (723.9)
A. Gskt: [1] Attached
F. Gskt: [1] Included
Related To: PA3478 (Standard Media Version)



PA3479 Outer Air Element with Lid
Fits: Hitachi Equipment
Use With: PA3783
Replaces: Hitachi 4206098
O.D.: 7 31/32 (202.4)
 Lid 9 15/16 (252.4)
I.D.: 7/8 (22.2) & 5 1/4 (133.4)
Height: 10 15/16 (277.8)
A. Gskt: [1] Attached
F. Gskt: [1] Included



PA3480 Inner Air Element
Fits Inside: LL2525, PA2525
Fits: International Trucks
Replaces: International 1674319-C1
O.D.: 7 5/8 (193.7)
I.D.: 21/32 (16.7) & 6 1/16 (154.0)
Height: 15 7/8 (403.2)
A. Gskt: [1] Attached
F. Gskt: G103-N



PA3481 Cab Air Element
Fits: Crenlo Tractor Cabs
Replaces: Crenlo 80255
Length: 18 7/16 (468.3)
Width: 5 1/4 (133.4)
Height: 2 3/16 (55.6)



PA3482 Cab Air Element with Lift Tabs
Fits: Caterpillar Equipment, Off-Highway
 Trucks
Replaces: Caterpillar 2G1946, 9P5174
Length: 13 1/4 (336.5)
Width: 11 15/16 (303.2)
Height: 13/16 (20.6)

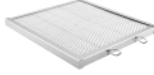

PA3483 Replacement for Ecolite Air Element in
 Disposable Housing
Fits: Volvo-Penta Industrial, Marine Engines
Replaces: Volvo 842280
O.D.: 7 3/4 (196.9)
I.D.: 4 (101.6) One End
Height: 12 15/16 (328.6)



PA3484 Outer Air Element with 4 Bolt Holes
Fits: Volvo Trucks
Use With: PA3865
Replaces: Volvo 1080918
O.D.: 10 21/32 (270.7)
 Flange 11 13/16 (300.0)
I.D.: 6 5/16 (160.3) One End
Height: 23 7/32 (589.8)
A. Gskt: [2] Attached



PA3486 Air Element
Fits: Ford Buses, Trucks
Replaces: Donaldson P150703
O.D.: 13 7/8 (352.4)
I.D.: 7 7/16 (188.9) One End
Height: 13 1/2 (342.9)
A. Gskt: [1] Attached













PA3487 Air Element with Bail Handle
Fits: Donaldson Air Cleaners; Elgin Sweepers
Replaces: Donaldson P525423
O.D.: 6 1/32 (153.2)
 Flange Gasket 7 3/32 (180.2)
I.D.: 3 15/32 (88.1) One End
Height: 15 3/8 (390.5)
A. Gskt: [2] Attached





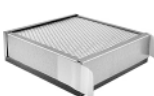









Measurements Are Shown In Inches And (Millimeters)

WARNING: These products can expose you to chemicals, including Diisononyl Phthalate, Carbon black extracts, Nickel, 1,3 Butadiene, Ethylene Oxide, Epichlorohydrin, which are known to the State of California to cause cancer, and Bisphenol, Ethylene Glycol, Ethylene Oxide, 1,3 Butadiene, Epichlorohydrin, which are known to the State of California to cause birth defects or other reproductive harm. For more information go to www.P65Warnings.ca.gov.

<p>PA3491 Outer Air Element Fits: Ford, New Holland Tractors Use With: PA3492 Replaces: Ford E9NN-9B618-BA; New Holland 82003726 O.D.: 8 1/8 (206.4) I.D.: 2 1/32 (16.7) & 3 3/4 (95.3) Height: 13 3/16 (335.0) A. Gskt: [2] Attached F. Gskt: [1] Included</p> 	<p>PA3498 Inner Air Element Fits Inside: PA3496 Fits: Sullair Compressors Replaces: Sullair 2250051-239 O.D.: 9 29/32 (251.6) I.D.: 13/16 (20.6) & 8 1/16 (204.8) Height: 23 1/2 (596.9) A. Gskt: [1] Included F. Gskt: [1] Included</p> 
<p>PA3492 Inner Air Element Fits Inside: PA3491, PA4683 Fits: Ford, New Holland Tractors Replaces: Ford E9NN-9R500-AB; New Holland 82008601 O.D.: 3 5/8 (92.1) Boot 4 7/16 (112.7) I.D.: 1/2 (12.7) & 3 (76.2) Height: 11 15/32 (291.3) A. Gskt: [1] Attached F. Gskt: [1] Included</p> 	<p>PA3499 Conical-Shaped Air Element Fits: ERF, Foden Trucks Replaces: ERF 990199; Foden Y05590000 O.D.: 10 3/8 (263.5) to 11 17/32 (292.9) I.D.: 2 1/32 (16.7) & 6 17/32 (165.9) Height: 19 1/2 (495.3) A. Gskt: [1] Attached F. Gskt: G103-N</p> 
<p>PA3493 Replacement for Ecolite Air Element in Disposable Housing Fits: Freightliner Chassis; Ottawa Trucks Replaces: Farr 114880-003A O.D.: 9 25/32 (248.4) Inlet: 6 Outlet: 5 Height: 19 7/16 (493.7)</p> 	<p>RS3501 Radial Seal Inner Air Element Fits Inside: RS2863, RS2863XP, RS30222XP Fits: Ford, GMC Trucks; John Deere, Magnum Equipment Replaces: GMC 12544543; Ford F3HZ-9R500-A; John Deere RE34963 O.D.: 5 1/4 (133.4) I.D.: 3 23/32 (94.5) One End Height: 12 1/32 (305.6)</p> 
<p>PA3494 Inner Air Element Fits Inside: PA2776 Fits: Claas Combines; Iveco, M.A.N. Trucks; Liebherr Cranes Replaces: Claas 722390; Iveco 1905620; M.A.N. 81.08405.0011 O.D.: 6 1/16 (154.0) Boot 6 3/8 (161.9) I.D.: 2 1/32 (16.7) & 5 19/32 (142.1) Height: 18 9/16 (471.5) A. Gskt: [1] Attached F. Gskt: [1] Included</p> 	<p>RS3502 Radial Seal Outer Air Element Fits: Caterpillar Equipment Use With: RS3503 Replaces: Caterpillar 6I2499 O.D.: 9 5/32 (232.6) I.D.: 4 5/8 (117.5) One End Height: 12 1/2 (317.5)</p> 
<p>PA3495 Cab Air Element Fits: Caterpillar Equipment Replaces: Caterpillar 7T8945 Length: 9 (228.6) Width: 9 (228.6) Height: 2 9/16 (65.1)</p> 	<p>RS3503 Radial Seal Inner Air Element Fits Inside: RS3502 Fits: Caterpillar Equipment Replaces: Caterpillar 6I2500 O.D.: 4 23/32 (119.9) I.D.: 3 3/16 (81.0) One End Height: 11 25/32 (299.2)</p> 
<p>PA3496 Outer Air Element with Bail Handle Fits: Sullair Compressors Use With: PA3498 Replaces: Sullair 2250051-238 O.D.: 15 1/8 (384.2) Boot 15 25/32 (400.8) I.D.: 13/16 (20.6) & 10 (254.0) Height: 24 1/2 (622.3) A. Gskt: [2] Included F. Gskt: [1] Included</p> 	











Measurements Are Shown In Inches And (Millimeters)

WARNING: These products can expose you to chemicals, including Diisononyl Phthalate, Carbon black extracts, Nickel, 1,3 Butadiene, Ethylene Oxide, Epichlorohydrin, which are known to the State of California to cause cancer, and Bisphenol, Ethylene Glycol, Ethylene Oxide, 1,3 Butadiene, Epichlorohydrin, which are known to the State of California to cause birth defects or other reproductive harm. For more information go to www.P65Warnings.ca.gov.

<p>RS3504</p>  <p>Radial Seal Outer Air Element Fits: Agco, Massey Ferguson Tractors; Caterpillar Equipment Use With: RS3505 Replaces: Caterpillar 6I2501 O.D.: 10 31/32 (278.6) I.D.: 5 13/16 (147.6) One End Height: 13 3/8 (339.7) Related To: RS3504XP (Extreme Performance Nano Version)</p>	<p>RS3508</p>  <p>Radial Seal Outer Air Element Fits: Caterpillar Equipment; Challenger Tractors; Wirtgen Equipment Use With: RS3509 Replaces: Caterpillar 122-1674; Wirtgen 162084 O.D.: 11 15/32 (291.3) I.D.: 7 1/8 (181.0) One End Height: 13 1/2 (342.9) Related To: RS3508XP (Extreme Performance Nano Version)</p>
<p>RS3504XP</p>  <p>Extreme Performance Nano Radial Seal Outer Air Element Fits: Agco, Massey Ferguson Tractors; Caterpillar Equipment Use With: RS3505 Replaces: Caterpillar 6I2501 O.D.: 10 31/32 (278.6) I.D.: 5 13/16 (147.6) One End Height: 13 3/8 (339.7) Related To: RS3504 (Standard Media Version)</p>	<p>RS3508XP</p>  <p>Extreme Performance Nano Radial Seal Outer Air Element Fits: Caterpillar Equipment; Challenger Tractors; Wirtgen Equipment Use With: RS3509 Replaces: Caterpillar 122-1674; Wirtgen 162084 O.D.: 11 15/32 (291.3) I.D.: 7 1/8 (181.0) One End Height: 13 1/2 (342.9) Related To: RS3508 (Standard Media Version)</p>
<p>RS3505</p>  <p>Radial Seal Inner Air Element Fits Inside: RS3504, RS3504XP Fits: Caterpillar Equipment Replaces: Caterpillar 6I2502 O.D.: 5 7/8 (149.2) I.D.: 4 1/8 (104.8) One End Height: 12 5/8 (320.7)</p>	<p>RS3509</p>  <p>Radial Seal Inner Air Element Fits Inside: RS3508, RS3508XP Fits: Caterpillar Equipment Replaces: Caterpillar 6I0274 O.D.: 7 1/4 (184.2) I.D.: 5 9/32 (134.1) One End Height: 13 3/16 (335.0)</p>
<p>RS3506</p>  <p>Radial Seal Outer Air Element Fits: Caterpillar, John Deere, Komatsu Equipment; Freightliner Buses Use With: RS3507, RS5392 Replaces: Caterpillar 6I2503 O.D.: 10 31/32 (278.6) I.D.: 5 13/16 (147.6) One End Height: 16 7/16 (417.5) Related To: RS3506XP (Extreme Performance Nano Version)</p>	<p>RS3510</p>  <p>Radial Seal Outer Air Element Fits: Caterpillar Equipment; Challenger Tractors Use With: RS3511 Replaces: Caterpillar 6I2505 O.D.: 12 13/32 (315.1) I.D.: 8 3/16 (208.0) One End Height: 15 1/2 (393.7) Related To: RS3510XP (Extreme Performance Nano Media)</p>
<p>RS3506XP</p>  <p>Extreme Performance Nano Radial Seal Outer Air Element Fits: Caterpillar, John Deere, Komatsu Equipment; Freightliner Buses Use With: RS3507, RS5392 Replaces: Caterpillar 6I2503 O.D.: 10 31/32 (278.6) I.D.: 5 13/16 (147.6) One End Height: 16 7/16 (417.5) Related To: RS3506 (Standard Media Version)</p>	<p>RS3510XP</p>  <p>Extreme Performance Nano Radial Seal Outer Air Element Fits: Caterpillar Equipment; Challenger Tractors Use With: RS3511 Replaces: Caterpillar 6I2505 O.D.: 12 13/32 (315.1) I.D.: 8 3/16 (208.0) One End Height: 15 1/2 (393.7) Related To: RS3510 (Standard Media Version)</p>
<p>RS3507</p>  <p>Radial Seal Inner Air Element Fits Inside: RS3506, RS3506XP Fits: Caterpillar Equipment Replaces: Caterpillar 6I2504 O.D.: 5 9/16 (141.3) I.D.: 4 13/32 (111.9) One End Height: 15 11/16 (398.5)</p>	<p>RS3511</p>  <p>Radial Seal Inner Air Element Fits Inside: RS3510, RS3510XP Fits: Caterpillar Equipment Replaces: Caterpillar 6I2506 O.D.: 8 5/16 (211.1) I.D.: 6 1/32 (153.2) One End Height: 15 7/32 (386.6)</p>



Measurements Are Shown In Inches And (Millimeters)

WARNING: These products can expose you to chemicals, including Diisononyl Phthalate, Carbon black extracts, Nickel, 1,3 Butadiene, Ethylene Oxide, Epichlorohydrin, which are known to the State of California to cause cancer, and Bisphenol, Ethylene Glycol, Ethylene Oxide, 1,3 Butadiene, Epichlorohydrin, which are known to the State of California to cause birth defects or other reproductive harm. For more information go to www.P65Warnings.ca.gov.

<p>RS3512</p>  <p>Radial Seal Outer Air Element Fits: Caterpillar Equipment Use With: RS3513 Replaces: Caterpillar 6I2507 O.D.: 12 13/32 (315.1) I.D.: 8 3/16 (208.0) One End Height: 15 1/2 (393.7)</p>	<p>RS3516</p>  <p>Radial Seal Outer Air Element Fits: Freightliner, Peterbilt Trucks Replaces: Donaldson P531026 O.D.: 9 9/32 (235.7) I.D.: 5 25/32 (146.8) One End Height: 23 7/16 (595.3) Related To: RS3516XP (Extreme Performance Nano Media)</p>
<p>RS3513</p>  <p>Radial Seal Inner Air Element Fits Inside: RS3512 Fits: Caterpillar Equipment Replaces: Caterpillar 6I2508 O.D.: 8 5/16 (211.1) I.D.: 6 1/32 (153.2) One End Height: 11 3/4 (298.5)</p>	<p>RS3516XP</p>  <p>Extreme Performance Nano Radial Seal Outer Air Element Fits: Freightliner, International, Peterbilt Trucks Replaces: Donaldson DBA5106 O.D.: 9 5/16 (236.5) I.D.: 5 3/4 (146.0) One End Height: 23 15/32 (595.9) Related To: RS3516 (Standard Version)</p>
<p>RS3514</p>  <p>Radial Seal Outer Air Element Fits: Caterpillar Equipment Use With: RS3515 Replaces: Caterpillar 6I2509 O.D.: 12 13/32 (315.1) I.D.: 8 3/16 (208.0) One End Height: 19 1/32 (483.4) Related To: RS3514XP (Extreme Performance Nano Version)</p>	<p>RS3517</p>  <p>Radial Seal Outer Air Element Fits: Ford, Freightliner Trucks; Case-International, Doosan, John Deere, Komatsu, New Holland Equipment Use With: RS3717 Replaces: Donaldson P532966 O.D.: 9 9/32 (235.7) I.D.: 5 5/32 (131.0) One End Height: 18 15/16 (481.0) Related To: RS3517XP (Extreme Performance Nano Version)</p>
<p>RS3514XP</p>  <p>Extreme Performance Nano Radial Seal Outer Air Element Fits: Caterpillar Equipment Use With: RS3515 Replaces: Caterpillar 6I2509 O.D.: 12 13/32 (315.1) I.D.: 8 3/16 (208.0) One End Height: 19 1/32 (483.4) Related To: RS3514 (Standard Media Version)</p>	<p>RS3517XP</p>  <p>Extreme Performance Nano Radial Seal Outer Air Element Fits: Ford, Freightliner Trucks; Case-International, Doosan, John Deere, Komatsu, New Holland Equipment Use With: RS3717 Replaces: Donaldson P532966 O.D.: 9 9/32 (235.7) I.D.: 5 5/32 (131.0) One End Height: 18 15/16 (481.0) Related To: RS3517 (Standard Media Version)</p>
<p>RS3515</p>  <p>Radial Seal Inner Air Element Fits Inside: RS3514, RS3514XP Fits: Caterpillar Equipment Replaces: Caterpillar 6I2510 O.D.: 8 5/16 (211.1) I.D.: 6 1/32 (153.2) One End Height: 15 7/32 (386.6)</p>	<p>RS3518</p>  <p>Radial Seal Outer Air Element Fits: Ford, Freightliner, International, Sterling, WhiteGMC Trucks Use With: RS3519 Replaces: Ford F1HZ-9601-B; GMC 25177196; International 3520400-C1; White 22-0013212 O.D.: 12 31/32 (329.4) I.D.: 6 13/16 (173.0) One End Height: 15 1/4 (387.3)</p>

Measurements Are Shown In Inches And (Millimeters)

WARNING: These products can expose you to chemicals, including Diisononyl Phthalate, Carbon black extracts, Nickel, 1,3 Butadiene, Ethylene Oxide, Epichlorohydrin, which are known to the State of California to cause cancer, and Bisphenol, Ethylene Glycol, Ethylene Oxide, 1,3 Butadiene, Epichlorohydrin, which are known to the State of California to cause birth defects or other reproductive harm. For more information go to www.P65Warnings.ca.gov.

<p>RS3518XP</p> 	<p>Extreme Performance Nano Radial Seal Outer Air Element Fits: Autocar, Ford, Freightliner, International, Peterbilt, Sterling, Volvo, White/GMC Trucks; Mercedes-Benz Latin America Buses; Taylor Sprayers Use With: RS3519 Replaces: Donaldson DBA5069; Fleetguard AF25139M O.D.: 12 31/32 (329.4) I.D.: 6 13/16 (173.0) One End Height: 15 1/4 (387.3) Related To: RS3518 (Standard Gasket Version)</p>	<p>RS3529</p> 	<p>Radial Seal Inner Air Element Fits Inside: RS3528 Fits: Caterpillar, Daewoo Equipment Replaces: Caterpillar 6I1451; Daewoo D141106 O.D.: 4 1/4 (108.0) I.D.: 2 3/4 (69.9) One End Height: 5 27/32 (148.4)</p>
<p>RS3519</p> 	<p>Radial Seal Inner Air Element Fits Inside: RS3518 Fits: Freightliner, Sterling, White/GMC Trucks Replaces: Air-Refiner ARM52-7683 O.D.: 6 7/8 (174.6) I.D.: 5 5/32 (131.0) One End Height: 14 13/32 (365.9)</p>	<p>RS3530</p> 	<p>Radial Seal Outer Air Element Fits: International Trucks; John Deere Equipment Use With: RS3531 Replaces: International 2005895-C1; John Deere RE63931 O.D.: 12 31/32 (329.4) I.D.: 6 13/16 (173.0) One End Height: 18 5/8 (473.1) Related To: RS3530XP (Extreme Performance Nano Media)</p>
<p>RS3520</p> 	<p>Radial Seal Outer Air Element Fits: Freightliner Trucks Use With: RS3521 Replaces: Donaldson P526678 O.D.: 9 9/32 (235.7) I.D.: 5 5/32 (131.0) One End Height: 15 (381.0)</p>	<p>RS3530XP</p> 	<p>Extreme Performance Nano Radial Seal Outer Air Element Fits: International Trucks; John Deere Equipment Use With: RS3531 Replaces: International 2005895-C1; John Deere RE63931 O.D.: 12 31/32 (329.4) I.D.: 6 13/16 (173.0) One End Height: 18 5/8 (473.1) Related To: RS3530 (Standard Media Version)</p>
<p>RS3521</p> 	<p>Radial Seal Inner Air Element Fits Inside: RS3520 Fits: Freightliner Trucks Replaces: Donaldson P529548 O.D.: 5 1/4 (133.4) I.D.: 3 23/32 (94.5) One End Height: 14 7/32 (361.2)</p>	<p>RS3531</p> 	<p>Radial Seal Inner Air Element Fits Inside: RS3530, RS3530XP Fits: International Buses, Trucks; John Deere Equipment Replaces: International 2022289-C1; John Deere RE63932 O.D.: 6 7/8 (174.6) I.D.: 5 5/32 (131.0) One End Height: 17 23/32 (450.1)</p>
<p>RS3528</p> 	<p>Radial Seal Outer Air Element Fits: Caterpillar, Daewoo Equipment Use With: RS3529 Replaces: Caterpillar 6I1450; Daewoo D141107 O.D.: 8 5/32 (207.2) I.D.: 4 3/16 (106.4) One End Height: 6 5/8 (168.3)</p>	<p>RS3532</p> 	<p>Radial Seal Outer Air Element Fits: John Deere Equipment Use With: RS3533 Replaces: John Deere RE34966 O.D.: 9 9/32 (235.7) I.D.: 5 5/32 (131.0) One End Height: 15 5/8 (396.9)</p>

Measurements Are Shown In Inches And (Millimeters)

WARNING: These products can expose you to chemicals, including Diisononyl Phthalate, Carbon black extracts, Nickel, 1,3 Butadiene, Ethylene Oxide, Epichlorohydrin, which are known to the State of California to cause cancer, and Bisphenol, Ethylene Glycol, Ethylene Oxide, 1,3 Butadiene, Epichlorohydrin, which are known to the State of California to cause birth defects or other reproductive harm. For more information go to www.P65Warnings.ca.gov.

RS3533 Radial Seal Inner Air Element
Fits Inside: RS3532
Fits: John Deere Equipment
Replaces: John Deere RE34967
O.D.: 5 1/4 (133.4)
I.D.: 3 23/32 (94.5) One End
Height: 14 27/32 (377.0)



RS3538 Radial Seal Outer Air Element
Fits: Hitachi, John Deere Equipment
Use With: RS3535
Replaces: Hitachi 4286128
O.D.: 9 9/32 (235.7)
I.D.: 5 5/32 (131.0) One End
Height: 14 19/32 (370.7)



RS3534 Radial Seal Outer Air Element
Contains: 4 5/8 Inch Dust Ejector Hole
Fits: Kenworth, Peterbilt, Western Star Trucks
Replaces: Donaldson P534925
O.D.: 12 3/32 (307.2)
I.D.: 7 3/8 (187.3) One End
Height: 25 13/16 (655.6)
F. Gskt: [2] Included



RS3539 Radial Seal Outer Air Element
Notes: Inside-Out Flow Direction
Contains: 3 3/4 Inch Dust Ejector Hole
Fits: Freightliner, Kenworth, Peterbilt, Western Star Trucks
Replaces: Donaldson P534816
O.D.: 11 13/32 (289.7)
I.D.: 3 25/32 (96.0) & 6 23/32 (170.7)
Height: 23 23/32 (602.5)
F. Gskt: G501-AF
Related To: RS3539XP (Extreme Performance Nano Version)



RS3535 Radial Seal Inner Air Element
Fits Inside: RS3538
Fits: Hitachi, John Deere Equipment
Replaces: Hitachi 4286130
O.D.: 5 1/4 (133.4)
I.D.: 3 23/32 (94.5) One End
Height: 13 27/32 (351.6)



RS3539XP Extreme Performance Nano Radial Seal Outer Air Element
Notes: Inside-Out Flow Direction
Contains: 3 3/4 Inch Dust Ejector Hole
Fits: Freightliner, Kenworth, Peterbilt, Western Star Trucks
Replaces: Donaldson EAF5100, DBA5100
O.D.: 11 13/32 (289.7)
I.D.: 3 25/32 (96.0) & 6 23/32 (170.7)
Height: 23 23/32 (602.5)
F. Gskt: G501-AF
Related To: RS3539 (Standard Media Version)



RS3536 Radial Seal Outer Air Element
Fits: Barber-Greene, Caterpillar Equipment
Use With: RS3537
Replaces: Caterpillar 102-9388
O.D.: 8 5/32 (207.2)
I.D.: 4 3/16 (106.4) One End
Height: 7 1/2 (190.5)



RS3540 Radial Seal Outer Air Element
Fits: Case, Caterpillar, Hitachi, John Deere Equipment
Use With: RS3541
Replaces: Caterpillar 135-5788; Hitachi 4283861
O.D.: 8 5/32 (207.2)
I.D.: 4 27/32 (123.0) One End
Height: 14 19/32 (370.7)



RS3537 Radial Seal Inner Air Element
Fits Inside: RS3536
Fits: Barber-Greene, Caterpillar Equipment
Replaces: Caterpillar 102-9387
O.D.: 4 1/4 (108.0)
I.D.: 2 3/4 (69.9) One End
Height: 6 21/32 (169.1)



RS3541 Radial Seal Inner Air Element
Fits Inside: RS3540
Fits: Case, Caterpillar, Hitachi, John Deere Equipment
Replaces: Caterpillar 135-5787; Hitachi 4287060
O.D.: 4 15/16 (125.4)
I.D.: 3 31/32 (100.8) One End
Height: 13 15/16 (354.0)



Measurements Are Shown In Inches And (Millimeters)

WARNING: These products can expose you to chemicals, including Diisononyl Phthalate, Carbon black extracts, Nickel, 1,3 Butadiene, Ethylene Oxide, Epichlorohydrin, which are known to the State of California to cause cancer, and Bisphenol, Ethylene Glycol, Ethylene Oxide, 1,3 Butadiene, Epichlorohydrin, which are known to the State of California to cause birth defects or other reproductive harm. For more information go to www.P65Warnings.ca.gov.

RS3542 Radial Seal Outer Air Element
Fits: Bobcat, Case, Caterpillar, Ford, J.C. Bamford, John Deere, Landini, Massey Ferguson, New Holland, Thomas, Volvo Equipment; Ingersoll-Rand Compressors
Use With: RS3543
Replaces: Case 222425A1; J.C. Bamford 32/919001; Massey Ferguson 3540046-M1; Melroe-Bobcat 6666375; Thomas 42402
O.D.: 5 13/32 (137.3)
I.D.: 3 3/16 (81.0) One End
Height: 12 31/32 (329.4)
Related To: RS4578 (Flame Retardant Media)



RS3548 Radial Seal Outer Air Element
Fits: Ford, GMC, Isuzu, Kenworth, Sterling Trucks; John Deere Equipment
Use With: RS3722
Replaces: John Deere RE51629
O.D.: 10 31/32 (278.6)
I.D.: 5 13/16 (147.6) One End
Height: 15 5/8 (396.9)
Related To: RS3548XP (Extreme Performance Nano Version)



RS3543 Radial Seal Inner Air Element
Fits Inside: RS3542
Fits: Bobcat, Case, Ford, J.C. Bamford, John Deere, Landini, Massey Ferguson, New Holland, Thomas, Volvo Equipment
Replaces: Case 222429A1; Fiat 1930588; John Deere AP33331; Massey Ferguson 3540047-M1; Melroe-Bobcat 6666376; New Holland 86982523; Thomas 42403
O.D.: 3 5/16 (84.1)
I.D.: 2 15/32 (62.7) One End
Height: 12 9/16 (319.1)



RS3548XP Extreme Performance Nano Radial Seal Outer Air Element
Fits: Ford, GMC, Isuzu, Kenworth, Sterling Trucks; John Deere Equipment
Use With: RS3722
Replaces: John Deere RE51629
O.D.: 10 31/32 (278.6)
I.D.: 5 13/16 (147.6) One End
Height: 15 5/8 (396.9)
Related To: RS3548 (Standard Media Version)



RS3544 Radial Seal Outer Air Element
Fits: Case, Caterpillar, Gehl, John Deere, New Holland, Vermeer, Volvo Equipment
Use With: RS3545
Replaces: Case 222421A1; Caterpillar 110-6326; Gehl L99453; John Deere AT171853; New Holland 86982524
O.D.: 6 1/2 (165.1)
I.D.: 3 9/16 (90.5) One End
Height: 14 1/32 (356.4)
Related To: RS5517 (Flame Retardant Media)



RS3549 Radial Seal Outer Air Element
Contains: Flame Retardant Media
Fits: Clark, John Deere Equipment
Use With: RS3703, RS3747
Replaces: Clark 2791707
O.D.: 5 1/32 (127.8)
I.D.: 3 5/32 (80.2) One End
Height: 12 5/16 (312.7)
Related To: RS3988 (without Flame Retardant Media)



RS3545 Radial Seal Inner Air Element
Fits Inside: RS3544, RS5517
Fits: Case, Caterpillar, Gehl, John Deere, New Holland, Vermeer, Volvo Equipment
Replaces: Case 222422A1; Caterpillar 110-6331; Gehl L99967; John Deere AT171854; New Holland 86982525
O.D.: 3 21/32 (92.9)
I.D.: 2 7/8 (73.0) One End
Height: 13 1/2 (342.9)



RS3550 Radial Seal Air Element
Fits: Dodge Light-Duty Trucks
Replaces: Chrysler 4713953
O.D.: 8 5/32 (207.2)
I.D.: 4 3/16 (106.4) One End
Height: 10 (254.0)



RS3547 Radial Seal Inner Air Element
Fits Inside: RS3954
Fits: Bomag, Gehl, New Holland Equipment
Replaces: Fiat 1930592; Gehl 321201111002
O.D.: 2 13/32 (61.1)
I.D.: 1 3/4 (44.4) One End
Height: 11 7/16 (290.5)



PA3551 Inner Air Element
Fits Inside: PA2781
Replaces: Fleetguard AF4771
O.D.: 9 11/16 (246.1)
I.D.: 21/32 (16.7) & 8 1/8 (206.4)
Height: 17 13/16 (452.4)
A. Gskt: [1] Attached
F. Gskt: G103-N









PA3554 Replacement for Ecolite Air Element in Disposable Housing
Fits: Farr Optional Housings
Replaces: Farr 114500-001
O.D.: 7 1/8 (181.0)
I.D.: 3 (76.2) One End
Height: 14 3/16 (360.4)













Measurements Are Shown In Inches And (Millimeters)

WARNING: These products can expose you to chemicals, including Diisononyl Phthalate, Carbon black extracts, Nickel, 1,3 Butadiene, Ethylene Oxide, Epichlorohydrin, which are known to the State of California to cause cancer, and Bisphenol, Ethylene Glycol, Ethylene Oxide, 1,3 Butadiene, Epichlorohydrin, which are known to the State of California to cause birth defects or other reproductive harm. For more information go to www.P65Warnings.ca.gov.

<p>PA3555</p>  <p>Replacement for Ecolite Air Element in Disposable Housing Fits: Farr Optional Housings Replaces: Farr 114500-002 O.D.: 8 1/8 (206.4) I.D.: 4 (101.6) One End Height: 17 3/16 (436.6)</p>	<p>PA3563</p>  <p>Air Element Contains: Flame Retardant Media Fits: Torit DownFlo EAC Environmental Dust Collectors Replaces: Torit 8PP40766-00 O.D.: 12 25/32 (324.6) I.D.: 8 11/32 (211.9) Height: 26 1/2 (673.1) A. Gskt: [1] Attached</p>
<p>PA3556</p>  <p>Replacement for Ecolite Air Element in Disposable Housing Fits: Farr Optional Housings Replaces: Farr 114500-003 O.D.: 9 5/8 (244.5) I.D.: 5 (127.0) One End Height: 20 1/8 (511.2)</p>	<p>PA3565</p>  <p>Inner Air Element Fits Inside: PA3472, PA3472-FN Fits: John Deere Lawn & Garden Mowers, Tractors Replaces: John Deere M94734 O.D.: 2 (50.8) Flange 3 1/8 (79.4) I.D.: 21/32 (16.7) & 1 17/32 (38.9) Height: 6 1/4 (158.8) A. Gskt: [1] Attached F. Gskt: G103-N</p>
<p>PA3557-FN</p>  <p>Outer Air Element with Fins Fits: John Deere Tractors Use With: PA3632 Replaces: John Deere AM108184 O.D.: 4 3/32 (104.0) Fins 5 1/8 (130.2) I.D.: 25/32 (19.8) & 2 15/32 (62.7) Height: 8 3/8 (212.7) A. Gskt: [1] Attached F. Gskt: G103-N</p>	<p>PA3566</p>  <p>Inner Air Element Fits Inside: PA3558, PA3688 Fits: R.V.I. Buses, Trucks Replaces: Renault 5010064372 O.D.: 6 3/8 (161.9) Flange 7 1/2 (190.5) I.D.: 5/8 (15.9) & 5 1/4 (133.4) Height: 14 7/8 (377.8) A. Gskt: [1] Attached F. Gskt: G103-N</p>
<p>PA3558</p>  <p>Outer Air Element Fits: R.V.I. Buses, Trucks Use With: PA3566 Replaces: Renault 5010064371 O.D.: 12 1/16 (306.4) I.D.: 11/16 (17.5) & 7 11/16 (195.3) Height: 15 11/16 (398.5) A. Gskt: [1] Attached F. Gskt: G103-N</p>	<p>PA3568</p>  <p>Air Element Fits: Wheelabrator Dust Collectors Replaces: Wheelabrator 833600882 O.D.: 12 3/4 (323.8) Flange 15 x 16 1/2 (381.0 x 419.1) I.D.: 8 3/8 (212.7) One End Height: 36 5/8 (930.3) A. Gskt: [1] Attached</p>
<p>PA3560</p>  <p>Air Element Notes: Inside-Out Flow Direction Fits: Wheelabrator Dust Collectors Replaces: TDC 10000045; Wheelabrator 661394 O.D.: 12 3/4 (323.8) Flange 13 7/8 (352.4) I.D.: 8 7/16 (214.3) One End Height: 26 5/8 (676.3) A. Gskt: [1] Attached</p>	<p>PA3569</p>  <p>Air Element Fits: Torit DownFlo II Dust Collectors Replaces: Heavy Duty Air A09268 O.D.: 13 13/16 (350.8) I.D.: 9 1/2 (241.3) Height: 28 1/2 (723.9) A. Gskt: [1] Attached</p>
<p>PA3562</p>  <p>Air Element Contains: Flame Retardant Media Replaces: Donaldson P823295 O.D.: 7 15/16 (201.6) I.D.: 11/16 (17.5) & 3 9/16 (90.5) Height: 20 1/4 (514.4) A. Gskt: [1] Attached F. Gskt: G103-N</p>	











Measurements Are Shown In Inches And (Millimeters)

WARNING: These products can expose you to chemicals, including Diisononyl Phthalate, Carbon black extracts, Nickel, 1,3 Butadiene, Ethylene Oxide, Epichlorohydrin, which are known to the State of California to cause cancer, and Bisphenol, Ethylene Glycol, Ethylene Oxide, 1,3 Butadiene, Epichlorohydrin, which are known to the State of California to cause birth defects or other reproductive harm. For more information go to www.P65Warnings.ca.gov.

<p>PA3572 Air Element Fits: M.A.N. Buses, Trucks Replaces: M.A.N. 90-80115.5191 O.D.: 9 17/32 (242.1) I.D.: 5 5/32 (131.0) One End Height: 19 1/2 (495.3) A. Gskt: [1] Attached</p> 	<p>PA3584 Air Element Fits: Gardner Denver Rock Drills; Tipton Filter Clone Dust Collectors Replaces: Tipton FC15-1001 O.D.: 16 5/8 (422.3) I.D.: 12 (304.8) Height: 25 (635.0) A. Gskt: [2] Attached</p> 
<p>PA3573 Air Element Replaces: Fixible 9754091 O.D.: 13 7/8 (352.4) I.D.: 9 13/32 (238.9) One End Height: 17 (431.8) A. Gskt: [2] Attached F. Gskt: [1] Included</p> 	<p>PA3587 Air Element Fits: Ingersoll-Rand Dust Collectors Replaces: Ingersoll-Rand 36858405 O.D.: 13 13/16 (350.8) I.D.: 9 1/2 (241.3) Height: 27 1/2 (698.5) A. Gskt: [1] Attached</p> 
<p>PA3576 Air Element Fits: Wheelabrator Dust Collectors Replaces: Wheelabrator 8036082 O.D.: 12 3/4 (323.8) Flange 13 7/8 (352.4) I.D.: 8 3/8 (212.7) One End Height: 36 5/8 (930.3) A. Gskt: [1] Attached</p> 	<p>PA3588 Air Element Contains: Flame Retardant Media Fits: Torit Dust Collectors Replaces: Torit 8PP25370-00 O.D.: 13 13/16 (350.8) I.D.: 9 1/2 (241.3) Height: 22 1/2 (571.5) A. Gskt: [1] Attached Related To: PA5699 (Different Media)</p> 
<p>PA3578 Inner Air Element Fits Inside: PA2784 Fits: Daewoo, Kawasaki, Komatsu Equipment; Mitsubishi Trucks Replaces: Komatsu 600-181-6730 O.D.: 5 1/4 (133.4) I.D.: 21/32 (16.7) & 4 1/8 (104.8) Height: 16 11/32 (415.1) A. Gskt: [1] Attached F. Gskt: G103-N</p> 	<p>PA3595 Air Element with Twist Lock Mounting Tabs Fits: Pneumafil ABB Dust Collectors Replaces: Pneumafil A38738C-2 O.D.: 12 3/4 (323.8) I.D.: 8 3/8 (212.7) One End Height: 34 5/8 (879.5) A. Gskt: [1] Attached</p> 
<p>PA3579 Air Element Notes: Inside-Out Flow Direction Fits: Torit Small TD Dust Collectors; Some Small Gas Turbines Replaces: Torit 8PP18583-00 O.D.: 12 3/4 (323.8) I.D.: 17/32 (13.5) & 8 11/32 (211.9) Height: 22 1/2 (571.5) A. Gskt: [1] Attached F. Gskt: [1] Included</p> 	<p>PA3597 Air Element Fits: Iveco Trucks Replaces: Iveco 1905983 O.D.: 9 9/16 (242.9) I.D.: 13/32 (10.3) & 5 3/16 (131.8) Height: 11 23/32 (297.7) A. Gskt: [1] Attached F. Gskt: [1] Washer</p> 
<p>PA3581 Air Element Fits: Torit Small TD Dust Collectors Replaces: Torit 8PP21967-00 O.D.: 7 15/16 (201.6) I.D.: 11/16 (17.5) & 3 9/16 (90.5) Height: 22 1/2 (571.5) A. Gskt: [1] Attached F. Gskt: [1] Included</p> 	













Measurements Are Shown In Inches And (Millimeters)

WARNING: These products can expose you to chemicals, including Diisononyl Phthalate, Carbon black extracts, Nickel, 1,3 Butadiene, Ethylene Oxide, Epichlorohydrin, which are known to the State of California to cause cancer, and Bisphenol, Ethylene Glycol, Ethylene Oxide, 1,3 Butadiene, Epichlorohydrin, which are known to the State of California to cause birth defects or other reproductive harm. For more information go to www.P65Warnings.ca.gov.

<p>PA3598 Air Element Contains: Flame Retardant Media Fits: Airflow PC Dust Collectors Replaces: Airflow 7FRO-2912 O.D.: 12 3/32 (307.2) I.D.: 7 11/16 (195.3) One End Height: 12 (304.8) A. Gskt: [1] Attached</p> 	<p>PA3605 Air Element Fits: M.A.N. Buses, Trucks Replaces: M.A.N. 90.80115.5196 O.D.: 8 15/16 (227.0) I.D.: 4 19/32 (116.7) One End Height: 15 (381.0) A. Gskt: [1] Attached</p> 
<p>PA3600 Air Element Fits: Hino Trucks Replaces: Hino 17801-2810 O.D.: 9 7/32 (234.2) I.D.: 21/32 (16.7) & 4 27/32 (123.0) Height: 18 1/2 (469.9) A. Gskt: [1] Attached F. Gskt: G103-N</p> 	<p>PA3606 Outer Air Element Fits: Claas, Liebherr, New Holland Equipment; Iveco, M.A.N. Trucks Use With: PA3787 Replaces: Claas 773670; M.A.N. 81.08401.6082 O.D.: 12 29/32 (327.8) I.D.: 13/32 (10.3) & 8 1/2 (215.9) Height: 24 1/4 (615.9) A. Gskt: [1] Attached F. Gskt: [1] Included</p> 
<p>PA3601 Inner Air Element Contains: Insert Thread: M16 x 2.0 Fits Inside: PA2845 Fits: John Deere Tractors Replaces: John Deere AL67195 O.D.: 3 11/32 (84.9) Flange 4 3/32 (104.0) I.D.: 5/8 (15.9) & 3 (76.2) Height: 9 1/4 (235.0)</p> 	<p>PA3607-FN Air Element with Fins Fits: Sullair Compressors Replaces: Sullair 2250044-537 O.D.: 6 3/32 (154.8) Fins 7 13/16 (198.4) I.D.: 3/4 (19.0) & 3 7/8 (98.4) Height: 12 1/2 (317.5) A. Gskt: [1] Attached F. Gskt: G103-N</p> 
<p>PA3602 Air Element Fits: Industrial Dust Collectors Replaces: Air Refiner ARM1416R O.D.: 13 13/16 (350.8) I.D.: 9 1/2 (241.3) Height: 15 3/4 (400.0)</p> 	<p>PA3608-FN Outer Air Element with Fins and Lid Contains: Flame Retardant Media Fits: Toyota Lift Trucks Replaces: Toyota 17808-23800-71 O.D.: 5 11/32 (135.7) Lid 7 27/32 (199.2) I.D.: 15/32 (11.9) & 2 5/8 (66.7) Height: 11 7/16 (290.5) A. Gskt: [2] Attached F. Gskt: [1] Included</p> 
<p>PA3604 Air Element Notes: Inside-Out Flow Direction Fits: Industrial Dust Collectors Replaces: Air Refiner ARM17057 O.D.: 13 27/32 (351.6) I.D.: 3/4 (19.0) & 11 1/8 (282.6) Height: 14 (355.6) F. Gskt: [1] Included</p> 	<p>PA3609 Outer Air Element Fits: Komatsu Equipment Use With: PA3610 Replaces: Komatsu 600-181-8210 O.D.: 8 1/2 (215.9) I.D.: 5/8 (15.9) & 4 5/32 (105.6) Height: 16 3/4 (425.5) A. Gskt: [1] Attached F. Gskt: G103-N Related To: PA4581 (One Closed End)</p> 
	<p>PA3611 Air Element Fits: Farr-Type D Dust Collectors Replaces: Farr 101400-1 O.D.: 12 3/4 (323.8) Flange 15 31/32 x 14 1/4 (405.6 x 362.0) I.D.: 8 5/16 (211.1) One End Height: 34 5/8 (879.5) A. Gskt: [1] Attached</p> 











Measurements Are Shown In Inches And (Millimeters)

WARNING: These products can expose you to chemicals, including Diisononyl Phthalate, Carbon black extracts, Nickel, 1,3 Butadiene, Ethylene Oxide, Epichlorohydrin, which are known to the State of California to cause cancer, and Bisphenol, Ethylene Glycol, Ethylene Oxide, 1,3 Butadiene, Epichlorohydrin, which are known to the State of California to cause birth defects or other reproductive harm. For more information go to www.P65Warnings.ca.gov.

<p>PA3612</p> 	<p>Air Element Fits: Atlas, Fendt, Guldner Equipment; Fiat Lift Trucks Replaces: Atlas Copco 16192867; Fiat 9292365; Guldner 9839012 O.D.: 4 3/8 (111.1) I.D.: 5/8 (15.9) & 1 15/16 (49.2) Height: 8 31/32 (227.8) A. Gskt: [1] Attached F. Gskt: [1] Included</p>	<p>PA3630-FN</p> 	<p>Outer Air Element with Fins Fits: Kobelco, MDI/Yutani Equipment Use With: PA3631 Replaces: Kobelco 2446R255-S5 O.D.: 6 7/8 (174.6) Fins 8 3/4 (222.3) I.D.: 2 1/32 (16.7) & 4 3/16 (106.4) Height: 20 1/2 (520.7) A. Gskt: [1] Attached F. Gskt: G103-N</p>
<p>PA3613</p> 	<p>Cab Air Element Fits: Komatsu Loaders Replaces: Komatsu 421-07-12312 Length: 10 (254.0) Width: 6 (152.4) Height: 2 3/16 (55.6)</p>	<p>PA3631</p> 	<p>Inner Air Element Fits Inside: PA3630-FN Fits: Kobelco, MDI/Yutani Equipment Replaces: Kobelco 2446R255-S6 O.D.: 4 3/32 (104.0) Flange 4 15/16 (125.4) I.D.: 25/32 (19.8) & 3 5/8 (92.1) Height: 19 5/16 (490.5) A. Gskt: [1] Attached F. Gskt: G103-N</p>
<p>PA3614</p> 	<p>Air Element Notes: Inside-Out Flow Direction Contains: Flame Retardant Media Fits: Torit DownFlo II Series Dust Collectors Replaces: Torit 8PP42058-00 O.D.: 13 13/16 (350.8) I.D.: 9 1/2 (241.3) Height: 26 1/2 (673.1) A. Gskt: [1] Attached Related To: PA3463 (Standard Media Version)</p>	<p>PA3632</p> 	<p>Inner Air Element Fits Inside: PA3557-FN Fits: John Deere Equipment Replaces: John Deere AM108185 O.D.: 2 3/8 (60.3) Flange 4 1/2 (114.3) I.D.: 2 1/32 (16.7) & 2 (50.8) Height: 7 3/16 (182.6) A. Gskt: [1] Attached F. Gskt: G103-N</p>
<p>PA3627</p> 	<p>Air Element Fits: Industrial Applications Replaces: Heavy Duty Air A1234-1 O.D.: 7 15/16 (201.6) I.D.: 1/2 (12.7) & 3 9/16 (90.5) Height: 10 1/2 (266.7) A. Gskt: [1] Attached F. Gskt: [1] Included</p>	<p>PA3633</p> 	<p>Air Element Fits: Caterpillar Generators Use With: PA3633 FOAM Replaces: Caterpillar 4W5452, 105-9741 O.D.: 22 (558.8) I.D.: 15 9/16 (395.3) One End Height: 24 3/4 (628.7) A. Gskt: [1] Attached</p>
<p>PA3628</p> 	<p>Woven Aluminum Air Element Fits: Industrial Applications Replaces: Heavy Duty Air A09214 O.D.: 6 23/32 (170.7) I.D.: 5 1/2 (139.7) Height: 2 3/4 (69.9)</p>	<p>PA3633 FOAM</p> 	<p>Foam Blanket for PA3633 Use With: PA3633 Replaces: Caterpillar 4W7103 Length: 68 13/16 (1747.8) Width: 23 1/2 (596.9)</p>
<p>PA3629</p> 	<p>Outer Air Element with Lid Fits: Caterpillar Equipment Use With: PA1911 Replaces: Caterpillar 417575, 96-4175 O.D.: 7 3/8 (187.3) Lid 9 9/32 (235.7) I.D.: 2 1/32 (16.7) & 4 11/16 (119.1) Height: 15 1/2 (393.7) A. Gskt: [2] Attached F. Gskt: G103-N</p>	<p>PA3636</p> 	<p>Air Element Fits: Hitachi Excavators Replaces: Hitachi 4206099 O.D.: 6 3/32 (154.8) I.D.: 3/4 (19.0) & 4 3/32 (104.0) Height: 12 3/8 (314.3) A. Gskt: [1] Attached F. Gskt: G103-N</p>

Measurements Are Shown In Inches And (Millimeters)

WARNING: These products can expose you to chemicals, including Diisononyl Phthalate, Carbon black extracts, Nickel, 1,3 Butadiene, Ethylene Oxide, Epichlorohydrin, which are known to the State of California to cause cancer, and Bisphenol, Ethylene Glycol, Ethylene Oxide, 1,3 Butadiene, Epichlorohydrin, which are known to the State of California to cause birth defects or other reproductive harm. For more information go to www.P65Warnings.ca.gov.

<p>PA3637 Air Element  Fits: Industrial Applications Replaces: Donaldson P150232 O.D.: 17 5/8 (447.7) I.D.: 11 1/32 (280.2) Height: 23 17/32 (597.7) A. Gskt: [1] Attached</p>	<p>PA3645 Air Element  Notes: Inside-Out Flow Direction Fits: Stork Model Laser Engraver O.D.: 9 7/32 (234.2) I.D.: 21/32 (16.7) & 4 27/32 (123.0) Height: 11 1/2 (292.1) A. Gskt: [1] Attached F. Gskt: G103-N</p>
<p>PA3638 Air Element  Fits: Wheelabrator Dust Collectors Replaces: Wheelabrator 213600881 O.D.: 12 25/32 (324.6) I.D.: 17/32 (13.5) & 8 11/32 (211.9) Height: 36 1/2 (927.1) A. Gskt: [1] Attached F. Gskt: [1] Included</p>	<p>PA3650 Outer Air Element with Lid  Contains: Flame Retardant Media Fits: Komatsu Equipment Use With: PA4548 Replaces: Komatsu 600-181-6350 O.D.: 4 7/8 (123.8) Lid 6 5/16 (160.3) I.D.: 21/32 (16.7) & 3 7/32 (81.8) Height: 10 1/4 (260.3) A. Gskt: [1] Attached F. Gskt: G103-N</p>
<p>PA3640 Air Element  Fits: Wheelabrator WTB-3 Tumbblast Machine Replaces: Wheelabrator 713200881 O.D.: 7 15/16 (201.6) I.D.: 11/16 (17.5) & 3 9/16 (90.5) Height: 32 1/2 (825.5) A. Gskt: [1] Attached F. Gskt: G103-N</p>	<p>PA3651-FN Outer Air Element with Fins and Lid  Contains: Flame Retardant Media Fits: Caterpillar Lift Trucks Replaces: Caterpillar 101-5412 O.D.: 4 3/32 (104.0) Lid 5 31/32 (151.6) I.D.: 5/8 (15.9) & 2 7/32 (56.4) Height: 9 1/8 (231.8) A. Gskt: [2] Attached F. Gskt: G103-N</p>
<p>PA3643 Hydraulic Tank Breather  Fits: Caterpillar Equipment, Off-Highway Trucks; Generac Generators Replaces: Caterpillar 8X4575 O.D.: 4 19/32 (116.7) I.D.: 1 5/8 (41.3) One End Height: 5 7/8 (149.2)</p>	<p>PA3652 Outer Air Element with Lid  Fits: Fiat-Allis, Liebherr Equipment Use With: PA3847 Replaces: Fiat 700052343; Liebherr 7403953 O.D.: 10 1/2 (266.7) Lid 12 1/2 (317.5) I.D.: 21/32 (16.7) & 6 (152.4) Height: 16 1/2 (419.1) A. Gskt: [1] Attached F. Gskt: [1] Included, [1] Wing Nut</p>
<p>PA3644 Conical-Shaped Air Element  Fits: Kenworth Trucks Replaces: Fleetguard AF25092M O.D.: 8 5/32 (207.2) to 10 7/8 (276.2) I.D.: 3 31/32 (100.8) & 6 23/32 (170.7) to Height: 24 3/4 (628.7) A. Gskt: [2] Attached</p>	<p>PA3653 Outer Air Element  Fits: Fiat-Allis Equipment Use With: PA3654 Replaces: Fiat 8322128 O.D.: 8 3/4 (222.3) I.D.: 6 1/16 (154.0) Height: 8 1/16 (204.8) A. Gskt: [2] Attached</p>
	<p>PA3654 Inner Air Element  Fits Inside: PA3653 Fits: Fiat-Allis Equipment Replaces: Fiat 8322129 O.D.: 5 3/8 (136.5) I.D.: 3 31/32 (100.0) Height: 6 7/8 (174.6) A. Gskt: [2] Attached</p>

Measurements Are Shown In Inches And (Millimeters)

WARNING: These products can expose you to chemicals, including Diisononyl Phthalate, Carbon black extracts, Nickel, 1,3 Butadiene, Ethylene Oxide, Epichlorohydrin, which are known to the State of California to cause cancer, and Bisphenol, Ethylene Glycol, Ethylene Oxide, 1,3 Butadiene, Epichlorohydrin, which are known to the State of California to cause birth defects or other reproductive harm. For more information go to www.P65Warnings.ca.gov.

PA3655

Outer Air Element



Fits: Ford, New Holland Equipment
Use With: PA3656
Replaces: New Holland 9846494
O.D.: 9 29/32 (251.6)
I.D.: 11/16 (17.5) & 6 1/16 (154.0)
Height: 16 (406.4)
A. Gskt: [1] Attached
F. Gskt: G103-N

PA3667-FN

Air Element with Fins



Contains: Flame Retardant Media
Fits: Toyota Lift Trucks
Replaces: Toyota 17752-20540-71
O.D.: 5 1/4 (133.4)
 Fins 6 3/8 (161.9)
I.D.: 21/32 (16.7) & 2 5/8 (66.7)
Height: 11 5/16 (287.3)
A. Gskt: [1] Attached
F. Gskt: G103-N
Related To: PA1667-FN (without Flame Retardant Media)

PA3656

Inner Air Element



Fits Inside: PA3655
Fits: Ford, New Holland Equipment
Replaces: New Holland 9846495
O.D.: 5 15/16 (150.8)
I.D.: 21/32 (16.7) & 4 29/32 (124.6)
Height: 15 (381.0)
A. Gskt: [1] Attached
F. Gskt: G103-N

PA3668

Inner Air Element



Fits Inside: LL2676, PA2676, PA2676XP
Fits: Hitachi, John Deere Equipment; Komatsu, Nissan Trucks
Replaces: Hitachi 4297294; John Deere AT201036
O.D.: 7 1/4 (184.2)
I.D.: 11/16 (17.5) & 6 3/16 (157.2)
Height: 18 1/2 (469.9)
A. Gskt: [1] Attached
F. Gskt: G103-N

PA3657

Inner Air Element



Fits Inside: PA3448
Fits: Hino Trucks
Replaces: Hino 17801-2610
O.D.: 4 9/16 (115.9)
 Flange 5 23/32 (145.3)
I.D.: 21/32 (16.7) & 3 7/16 (87.3)
Height: 12 (304.8)
A. Gskt: [1] Attached
F. Gskt: G103-N

PA3669-FN

Outer Air Element with Fins and Lid



Fits: Agco, Braud, Case, Ford, Massey Ferguson, Same, White Equipment
Use With: PA2419
Replaces: Case P1950555; New Holland 1930765; Same 242491300
O.D.: 6 3/32 (154.8)
 Lid 8 3/8 (212.7)
I.D.: 21/32 (16.7) & 3 15/32 (88.1)
Height: 15 1/2 (393.7)
A. Gskt: [1] Attached
F. Gskt: [1] Included, [1] Wing Nut

PA3658

Cab Air Element



Fits: Caterpillar Equipment
Replaces: Caterpillar 7T1889
Length: 23 1/2 (596.9)
Width: 6 (152.4)
Height: 2 9/16 (65.1)
A. Gskt: [1] Attached

PA3670

Outer Air Element with Lid



Contains: Flame Retardant Media
Fits: Komatsu Equipment
Use With: PA3985
Replaces: Komatsu 600-182-1320
O.D.: 6 3/32 (154.8)
 Lid 7 5/8 (193.7)
I.D.: 21/32 (16.7) & 3 15/32 (88.1)
Height: 12 3/8 (314.3)
A. Gskt: [2] Attached
F. Gskt: G103-N, [1] Wing Nut

PA3660-FN

Air Element with Fins



Fits: Mitsubishi Trucks
Replaces: Mitsubishi MB120298
O.D.: 7 15/16 (201.6)
 Fins 9 31/32 (253.2)
I.D.: 1/2 (12.7) & 4 31/32 (126.2)
Height: 7 3/8 (187.3)
A. Gskt: [1] Attached
F. Gskt: [1] Included

PA3671-FN

Outer Air Element with Fins



Contains: Flame Retardant Media
Fits: Kobelco, Komatsu Equipment
Use With: PA3672, PA3674
Replaces: Kobelco 2451U154-3N; Komatsu 600-181-7260
O.D.: 5 1/4 (133.4)
 Fins 6 11/32 (161.1)
I.D.: 21/32 (16.7) & 3 5/16 (84.1)
Height: 11 9/32 (286.5)
A. Gskt: [1] Attached
F. Gskt: G103-N

PA3664-FN



Outer Air Element with Fins and Lid



Fits: Bomag, Komatsu, Kubota Equipment
Replaces: Kubota 15852-11082
O.D.: 3 9/32 (83.3)
 Lid 5 (127.0)
I.D.: 13/32 (10.3) & 1 27/32 (46.8)
Height: 7 1/4 (184.2)
A. Gskt: [2] Attached
F. Gskt: [1] Included











Measurements Are Shown In Inches And (Millimeters)

WARNING: These products can expose you to chemicals, including Diisononyl Phthalate, Carbon black extracts, Nickel, 1,3 Butadiene, Ethylene Oxide, Epichlorohydrin, which are known to the State of California to cause cancer, and Bisphenol, Ethylene Glycol, Ethylene Oxide, 1,3 Butadiene, Epichlorohydrin, which are known to the State of California to cause birth defects or other reproductive harm. For more information go to www.P65Warnings.ca.gov.

<p>PA3672 Inner Air Element Fits Inside: PA3671-FN Replaces: Toyota 17804-23000-71 O.D.: 3 3/16 (81.0) I.D.: 15/32 (11.9) & 2 17/32 (64.3) Height: 10 3/8 (263.5) A. Gskt: [1] Attached F. Gskt: [1] Included</p> 	<p>PA3681 Air Element Fits: Mercedes-Benz Trucks, Vans Replaces: Mercedes-Benz 20947304 O.D.: 7 13/16 (198.4) I.D.: 11/32 (8.7) & 4 1/16 (103.2) Height: 10 1/32 (254.8) A. Gskt: [1] Attached</p> 
<p>PA3674 Inner Air Element Fits Inside: PA3671-FN Fits: Komatsu, Mitsubishi Equipment Replaces: Komatsu 600-181-7360; Mitsubishi 91461-11400 O.D.: 3 1/4 (82.6) I.D.: 21/32 (16.7) & 2 1/8 (54.0) Height: 9 17/32 (242.1) A. Gskt: [1] Attached F. Gskt: G103-N</p> 	<p>PA3682 Inner Air Element Fits Inside: PA2422 Fits: Deutz Tractors Replaces: Deutz 2379161, 4308634 O.D.: 2 11/16 (68.3) Flange 3 5/32 (80.2) I.D.: 5/8 (15.9) & 2 13/32 (61.1) Height: 7 27/32 (199.2) A. Gskt: [1] Attached</p> 
<p>PA3675 Outer Air Element with Lid Fits: Braud, Daewoo, Liebherr, Same Equipment Use With: PA1981 Replaces: Daewoo 94749001; Liebherr 7405233; Same 242493801 O.D.: 10 1/32 (254.8) Lid 10 7/8 (276.2) I.D.: 4 13/16 (122.2) One End Height: 16 1/2 (419.1) A. Gskt: [1] Attached F. Gskt: [1] Included, [1] Wing Nut</p> 	<p>PA3683 Inner Air Element Fits Inside: PA2423 Fits: Deutz Tractors Replaces: Deutz 2379163, 4308636 O.D.: 3 1/4 (82.6) Flange 3 17/32 (89.7) I.D.: 7/16 (11.1) & 2 3/4 (69.9) Height: 12 13/16 (325.4) A. Gskt: [1] Attached</p> 
<p>PA3676 Cab Air Element Replaces: GMC 25043797 Length: 24 (609.6) Width: 5 (127.0) Height: 2 3/16 (55.6)</p> 	<p>PA3684 Inner Air Element Fits Inside: PA2422, PA2772 Fits: Deutz, Eicher, Fendt Tractors Replaces: Fendt X810270072 O.D.: 3 11/32 (84.9) I.D.: 5/8 (15.9) & 2 27/32 (72.2) Height: 7 17/32 (191.3) A. Gskt: [1] Attached</p> 
<p>PA3679 Air Breather Element Fits: Volvo Trucks Replaces: Volvo 1082368-0 O.D.: 3 7/16 (87.3) I.D.: 31/32 (24.6) One End Height: 5 3/16 (131.8) A. Gskt: [1] Attached</p> 	<p>PA3685 Inner Air Element Fits Inside: PA2423 Fits: Bomag, Deutz Equipment Replaces: Deutz 2243522, 4930377 O.D.: 3 5/16 (84.1) I.D.: 5/8 (15.9) & 2 27/32 (72.2) Height: 12 5/16 (312.7) A. Gskt: [1] Attached</p> 
<p>PA3680 Foam Cab Air Element Fits: Caterpillar Equipment Replaces: Caterpillar 6P1319 Length: 10 11/16 (271.5) Width: 4 11/16 (119.1) Height: 4 3/16 (106.4)</p> 	

Measurements Are Shown In Inches And (Millimeters)

WARNING: These products can expose you to chemicals, including Diisononyl Phthalate, Carbon black extracts, Nickel, 1,3 Butadiene, Ethylene Oxide, Epichlorohydrin, which are known to the State of California to cause cancer, and Bisphenol, Ethylene Glycol, Ethylene Oxide, 1,3 Butadiene, Epichlorohydrin, which are known to the State of California to cause birth defects or other reproductive harm. For more information go to www.P65Warnings.ca.gov.

<p>PA3686 Inner Air Element Fits Inside: PA2767 Fits: Bomag, Claas, Fendt, Hanomag, International, Kobelco, Liebherr Equipment; Iveco Trucks Replaces: Deutz 4144897 O.D.: 2 9/16 (65.1) Boot 3 5/32 (80.2) I.D.: 21/32 (16.7) One End Height: 12 27/32 (326.2) A. Gskt: [1] Attached</p> 	<p>PA3691 Air Element Fits: Duraquip Equipment Replaces: Duraquip 90603; Guardian G119253 O.D.: 9 1/4 (235.0) I.D.: 9/16 (14.3) & 6 3/4 (171.5) Height: 24 1/2 (622.3) A. Gskt: [1] Attached F. Gskt: G103-N</p> 
<p>PA3687 Inner Air Element Fits Inside: PA2792 Fits: Atlas, Eicher, Fendt, Hough, International, Steyr-Daimler-Puch Equipment Replaces: International 3148080-R1; Steyr-Daimler-Benz 31100190019 O.D.: 2 13/32 (61.1) Boot 2 3/4 (69.9) I.D.: 21/32 (16.7) & 2 1/16 (52.4) Height: 11 3/16 (284.2) A. Gskt: [1] Attached F. Gskt: [1] Plastic Washer</p> 	<p>PA3697 Air Element Fits: Toyota Lift Trucks Replaces: Toyota 17801-20540, 17801-20540-71 O.D.: 10 7/32 (259.6) I.D.: 7 7/32 (183.4) One End Height: 1 13/16 (46.0) A. Gskt: [2] Attached</p> 
<p>PA3688 Outer Air Element Contains: Flame Retardant Media Fits: R.V.I. Trucks Use With: PA3566 Replaces: Renault 5010066304 O.D.: 12 1/16 (306.4) I.D.: 11/16 (17.5) & 7 11/16 (195.3) Height: 18 1/2 (469.9) A. Gskt: [1] Attached F. Gskt: G103-N</p> 	<p>PA3698 Outer Air Element Fits: Caterpillar Equipment Use With: PA2413 Replaces: Caterpillar 4N0326 O.D.: 6 27/32 (173.8) I.D.: 5/8 (15.9) & 3 15/32 (88.1) Height: 12 3/8 (314.3) A. Gskt: [1] Attached F. Gskt: G103-N</p> 
<p>PA3689 Air Element Fits: Komatsu Equipment Replaces: Komatsu 600-181-1680 O.D.: 6 3/8 (161.9) I.D.: 5/8 (15.9) & 5 9/32 (134.1) Height: 14 3/16 (360.4) A. Gskt: [1] Attached F. Gskt: G103-N</p> 	<p>PA3699 Outer Air Element Fits: R.V.I. Trucks Replaces: Renault 5000751674, 5010094092, 5010094146 O.D.: 11 1/8 (282.6) I.D.: 21/32 (16.7) & 6 23/32 (170.7) Height: 15 5/16 (388.9) A. Gskt: [1] Attached F. Gskt: G103-N</p> 
<p>PA3690 Outer Air Element with Lid Fits: Lister Engines; Massey Ferguson Tractors Use With: PA2419 Replaces: Lister 38207906; Massey Ferguson 1062501-M91 O.D.: 6 11/16 (169.9) Lid 8 13/32 (213.5) I.D.: 21/32 (16.7) & 3 15/32 (88.1) Height: 15 7/16 (392.1) A. Gskt: [1] Attached F. Gskt: [1] Rubber Washer, [1] Wing Nut</p> 	<p>RS3700 Radial Seal Outer Air Element Fits: Caterpillar Equipment Use With: RS3701 Replaces: Caterpillar 106-3969 O.D.: 14 7/32 (361.2) I.D.: 8 15/16 (227.0) One End Height: 18 11/32 (465.9) Related To: RS3700XP (Extreme Performance Nano Version)</p> 
	<p>RS3700XP Extreme Performance Nano Radial Seal Outer Air Element Fits: Caterpillar Equipment Use With: RS3701 Replaces: Caterpillar 106-3969 O.D.: 14 7/32 (361.2) I.D.: 8 15/16 (227.0) One End Height: 18 11/32 (465.9) Related To: RS3700 (Standard Media Version)</p> 

Measurements Are Shown In Inches And (Millimeters)

WARNING: These products can expose you to chemicals, including Diisononyl Phthalate, Carbon black extracts, Nickel, 1,3 Butadiene, Ethylene Oxide, Epichlorohydrin, which are known to the State of California to cause cancer, and Bisphenol, Ethylene Glycol, Ethylene Oxide, 1,3 Butadiene, Epichlorohydrin, which are known to the State of California to cause birth defects or other reproductive harm. For more information go to www.P65Warnings.ca.gov.

RS3701 Radial Seal Inner Air Element
Fits Inside: RS3700, RS3700XP
Fits: Caterpillar Equipment
Replaces: Caterpillar 106-3973
O.D.: 9 3/32 (231.0)
I.D.: 6 29/32 (175.4) One End
Height: 17 27/32 (453.2)



RS3707 Radial Seal Air Element
Fits: Chevrolet, GMC Light-Duty Trucks, Vans
Replaces: GMC 15998574, 25168081
O.D.: 6 1/2 (165.1)
I.D.: 3 9/16 (90.5) One End
Height: 11 1/32 (280.2)
Related To: RS3706 (Heavy-Duty Version)
 RS3735 (with Foam Wrap)



RS3703 Radial Seal Inner Air Element
Fits Inside: RS3549, RS3988
Fits: Bobcat, Case-International, Caterpillar, John Deere, Kubota, Mustang, Terex, Timberjack Equipment
Replaces: Case 133721-A1; Melroe-Bobcat 6666334; Owatonna 42035599
O.D.: 3 5/16 (84.1)
I.D.: 2 15/32 (62.7) One End
Height: 11 31/32 (304.0)



RS3708 Radial Seal Outer Air Element
Fits: Case Equipment
Use With: RS3709
Replaces: Case 128781A1
O.D.: 5 13/32 (137.3)
I.D.: 3 3/16 (81.0) One End
Height: 15 15/32 (392.9)



RS3704 Radial Seal Outer Air Element
Fits: Isuzu, Yanmar Engines; Bobcat, Caterpillar, John Deere, Komatsu, Kubota Equipment
Use With: RS3705
Replaces: John Deere M131802; Kubota TA040-93230; Melroe-Bobcat 6672467; Yanmar 119808-12520
O.D.: 4 1/8 (104.8)
I.D.: 2 5/16 (58.7) One End
Height: 10 13/16 (274.6)
Related To: RS3716 (with Flame Retardant Media)



RS3709 Radial Seal Inner Air Element
Fits Inside: RS3708, RS5395-FN
Fits: Case Equipment
Replaces: Case 128782A1
O.D.: 3 5/16 (84.1)
I.D.: 2 15/32 (62.7) One End
Height: 14 7/8 (377.8)



RS3705 Radial Seal Inner Air Element
Fits Inside: RS3704, RS3716
Fits: Isuzu, Yanmar Engines; Bobcat, Caterpillar, John Deere, Komatsu, Kubota Equipment
Replaces: Hitachi 4423981; John Deere M131803; Kubota TA040-93220; Melroe-Bobcat 6672468; Donaldson P822858
O.D.: 2 13/32 (61.1)
I.D.: 1 3/4 (44.4) One End
Height: 10 13/32 (264.3)



RS3710 Radial Seal Outer Air Element
Fits: Nissan Trucks
Use With: RS3711
Replaces: Nissan 16546-Z9100
O.D.: 10 29/32 (277.0)
I.D.: 6 25/32 (172.2) One End
Height: 14 23/32 (373.9)



RS3706 Radial Seal Heavy-Duty Air Element
Fits: Chevrolet, GMC Light-Duty Trucks, Vans
Replaces: GMC 15986275, 25168082
O.D.: 7 11/32 (186.5)
I.D.: 3 19/32 (91.3) One End
Height: 11 3/32 (281.8)
Related To: RS3707 (Standard Version)
 RS3735 (Standard Version with Foam Wrap)













RS3711 Radial Seal Inner Air Element
Fits Inside: RS3710
Fits: Nissan Trucks
Replaces: Nissan 16546-Z9101
O.D.: 6 7/8 (174.6)
I.D.: 6 1/2 (165.1) One End
Height: 14 1/32 (356.4)













Measurements Are Shown In Inches And (Millimeters)

WARNING: These products can expose you to chemicals, including Diisononyl Phthalate, Carbon black extracts, Nickel, 1,3 Butadiene, Ethylene Oxide, Epichlorohydrin, which are known to the State of California to cause cancer, and Bisphenol, Ethylene Glycol, Ethylene Oxide, 1,3 Butadiene, Epichlorohydrin, which are known to the State of California to cause birth defects or other reproductive harm. For more information go to www.P65Warnings.ca.gov.

<p>RS3712</p> 	<p>Radial Seal Outer Air Element Fits: Caterpillar Equipment Use With: RS3713 Replaces: Caterpillar 123-6856 O.D.: 14 7/32 (361.2) I.D.: 8 15/16 (227.0) One End Height: 15 17/32 (394.5)</p>	<p>RS3718</p> 	<p>Radial Seal Outer Air Element Fits: Case-International, John Deere, Steiger Equipment Use With: RS3719 Replaces: Case 132151A1; John Deere AT203050 O.D.: 10 31/32 (278.6) I.D.: 5 27/32 (148.4) One End Height: 21 5/8 (549.3)</p>
<p>RS3713</p> 	<p>Radial Seal Inner Air Element Fits Inside: RS3712 Fits: Caterpillar Equipment Replaces: Caterpillar 123-6856 O.D.: 9 3/32 (231.0) I.D.: 6 29/32 (175.4) One End Height: 15 7/32 (386.6)</p>	<p>RS3719</p> 	<p>Radial Seal Inner Air Element Fits Inside: RS3718 Fits: Case-International, John Deere, Steiger Equipment Replaces: Case 1321419A1; John Deere AT203051 O.D.: 5 29/32 (150.0) I.D.: 4 13/32 (111.9) One End Height: 21 1/16 (535.0)</p>
<p>RS3714</p> 	<p>Radial Seal Outer Air Element Fits: M.A.N. Trucks Use With: RS4549 Replaces: M.A.N. 81.08304.0083 O.D.: 11 29/32 (302.4) I.D.: 6 5/8 (168.3) One End Height: 19 3/32 (485.0)</p>	<p>RS3720</p> 	<p>Radial Seal Outer Air Element Fits: Case-International, Steiger Equipment Use With: RS3721 Replaces: Steiger 90-8300T1 O.D.: 12 13/32 (315.1) I.D.: 8 3/16 (208.0) One End Height: 21 5/8 (549.3)</p>
<p>RS3715</p> 	<p>Radial Seal Outer Air Element Notes: Also available in HSG3077 or HSG3078 Housings. Fits: Exmark Lawn & Garden Tractors; Bobcat, John Deere Equipment Use With: RS3930 Replaces: John Deere M113621 O.D.: 3 17/32 (89.7) I.D.: 1 3/4 (44.4) One End Height: 7 (177.8)</p>	<p>RS3721</p> 	<p>Radial Seal Inner Air Element Fits Inside: RS3720 Fits: Case-International, Steiger Tractors Replaces: Steiger 90-8301T1 O.D.: 8 5/16 (211.1) I.D.: 6 1/32 (153.2) One End Height: 20 31/32 (532.6)</p>
<p>RS3716</p> 	<p>Radial Seal Outer Air Element Contains: Flame Retardant Media Fits: TCM Lift Trucks Use With: RS3705 Replaces: TCM 5365172061 O.D.: 4 1/8 (104.8) I.D.: 2 5/16 (58.7) One End Height: 10 13/16 (274.6) Related To: RS3704 (without Flame Retardant Media)</p>	<p>RS3722</p> 	<p>Radial Seal Inner Air Element Fits Inside: RS3548, RS3548XP Fits: John Deere Equipment Replaces: John Deere RE51630 O.D.: 5 29/32 (150.0) I.D.: 4 13/32 (111.9) One End Height: 15 (381.0)</p>
<p>RS3717</p> 	<p>Radial Seal Inner Air Element Fits Inside: RS3517, RS3517XP Fits: Freightliner Trucks; John Deere, Komatsu Equipment Replaces: Donaldson P533781 O.D.: 5 1/4 (133.4) I.D.: 4 15/16 (125.4) One End Height: 18 7/32 (462.8)</p>		











Measurements Are Shown In Inches And (Millimeters)

WARNING: These products can expose you to chemicals, including Diisononyl Phthalate, Carbon black extracts, Nickel, 1,3 Butadiene, Ethylene Oxide, Epichlorohydrin, which are known to the State of California to cause cancer, and Bisphenol, Ethylene Glycol, Ethylene Oxide, 1,3 Butadiene, Epichlorohydrin, which are known to the State of California to cause birth defects or other reproductive harm. For more information go to www.P65Warnings.ca.gov.

<p>RS3724</p>  <p>Radial Seal Air Element Fits: Scania Trucks Replaces: Scania 1335679 O.D.: 11 29/32 (302.4) I.D.: 6 5/8 (168.3) One End Height: 17 19/32 (446.9)</p>	<p>RS3730</p>  <p>Radial Seal Air Element Fits: Freightliner Trucks Replaces: Vortox VF120W O.D.: 11 (279.4) I.D.: 5 13/16 (147.6) Height: 19 3/8 (492.1)</p>
<p>RS3726</p>  <p>Radial Seal Outer Air Element Fits: Scania Trucks Use With: RS5313 Replaces: Scania 1335678 O.D.: 11 29/32 (302.4) I.D.: 6 5/8 (168.3) One End Height: 20 23/32 (526.3)</p>	<p>RS3731</p>  <p>Radial Seal Outer Air Element Fits: Mitsubishi Trucks Use With: RS3732 Replaces: Mitsubishi ME073160, ME073597, ME073821 O.D.: 9 9/32 (235.7) I.D.: 5 5/32 (131.0) One End Height: 16 11/32 (415.1)</p>
<p>RS3727</p>  <p>Radial Seal Outer Air Element Fits: R.V.I. Trucks Replaces: Renault 5010230841 O.D.: 12 9/32 (311.9) I.D.: 6 31/32 (177.0) One End Height: 18 11/32 (465.9) Related To: RS5390 (Flame Retardant Media)</p>	<p>RS3732</p>  <p>Radial Seal Inner Air Element Fits Inside: RS3731; RS5546 Fits: Mitsubishi Trucks Replaces: Mitsubishi ME291563 O.D.: 5 1/4 (133.4) I.D.: 3 23/32 (94.5) One End Height: 15 23/32 (399.3)</p>
<p>RS3728</p>  <p>Radial Seal Outer Air Element Fits: R.V.I. Buses, Trucks Use With: RS3729 Replaces: Renault 5010230916 O.D.: 12 9/32 (311.9) I.D.: 6 31/32 (177.0) One End Height: 21 7/8 (555.6)</p>	<p>RS3733</p>  <p>Radial Seal Air Element Fits: Hino Trucks Replaces: Hino 17801-3000 O.D.: 9 9/32 (235.7) I.D.: 5 5/32 (131.0) One End Height: 13 23/32 (348.5)</p>
<p>RS3729</p>  <p>Radial Seal Inner Air Element Fits Inside: RS3728 Fits: R.V.I. Trucks Replaces: Renault 5010269584 O.D.: 6 7/8 (174.6) I.D.: 5 11/16 (144.5) One End Height: 21 1/8 (536.6)</p>	<p>RS3734</p>  <p>Radial Seal Outer Air Element Fits: Caterpillar, Agco, Case, John Deere, Komatsu, Liebherr, Massey Ferguson, New Holland, Volvo Equipment Use With: RS3885 Replaces: Caterpillar 130-4678; John Deere AT203469 O.D.: 8 5/32 (207.2) I.D.: 4 3/16 (106.4) One End Height: 16 9/16 (420.7) Related To: RS3734XP (Extreme Performance Nano Version)</p>

Measurements Are Shown In Inches And (Millimeters)

WARNING: These products can expose you to chemicals, including Diisononyl Phthalate, Carbon black extracts, Nickel, 1,3 Butadiene, Ethylene Oxide, Epichlorohydrin, which are known to the State of California to cause cancer, and Bisphenol, Ethylene Glycol, Ethylene Oxide, 1,3 Butadiene, Epichlorohydrin, which are known to the State of California to cause birth defects or other reproductive harm. For more information go to www.P65Warnings.ca.gov.

<p>RS3734XP</p> 	<p>Extreme Performance Nano Radial Seal Outer Air Element Fits: Caterpillar, Agco, Case, John Deere, Komatsu, Liebherr, Massey Ferguson, New Holland, Volvo Equipment Use With: RS3885 Replaces: Caterpillar 130-4678; John Deere AT203469 O.D.: 8 5/32 (207.2) I.D.: 4 3/16 (106.4) One End Height: 16 9/16 (420.7) Related To: RS3734 (Standard Media Version)</p>	<p>RS3739</p>  <p>Radial Seal Inner Air Element Fits Inside: RS3738 Fits: Ford Louisville Trucks Replaces: Ford F6HZ-9602-AA O.D.: 8 5/16 (211.1) I.D.: 6 1/32 (153.2) One End Height: 16 13/16 (427.0)</p>
<p>RS3735</p> 	<p>Radial Seal Air Element with Foam Wrap Fits: Chevrolet, GMC Light-Duty Trucks Replaces: GMC 25173426 O.D.: 7 9/32 (184.9) I.D.: 3 9/16 (90.5) One End Height: 11 1/32 (280.2) Related To: RS3707 (without Foam Wrap) RS3706 (Heavy-Duty Version without Foam Wrap)</p>	<p>RS3740</p>  <p>Radial Seal Outer Air Element Fits: Volvo Trucks Use With: RS3741 Replaces: Volvo 8076195 O.D.: 12 31/32 (329.4) I.D.: 7 3/4 (196.9) One End Height: 16 7/16 (417.5)</p>
<p>RS3736</p> 	<p>Radial Seal Outer Air Element Fits: Caterpillar Equipment Use With: RS3737 Replaces: Caterpillar 131-8822 O.D.: 9 9/32 (235.7) I.D.: 5 5/32 (131.0) One End Height: 13 1/2 (342.9)</p>	<p>RS3741</p>  <p>Radial Seal Inner Air Element Fits Inside: RS3740 Fits: Volvo Trucks Replaces: Volvo 8079756 O.D.: 7 7/8 (200.0) I.D.: 6 3/16 (157.2) One End Height: 15 21/32 (397.7)</p>
<p>RS3737</p> 	<p>Radial Seal Inner Air Element Fits Inside: RS3736 Fits: Caterpillar Equipment Replaces: Caterpillar 131-8821 O.D.: 5 1/4 (133.4) I.D.: 3 23/32 (94.5) One End Height: 12 23/32 (323.1)</p>	<p>RS3743</p>  <p>Radial Seal Air Element Notes: Inside-Out Flow Direction. Uses 2 filters per application (left/right housings). Contains: 3 3/32 (78.6) Inch Dust Evacuation Hole Fits: International Trucks Replaces: International 3507421-C1, 3517842-C1 O.D.: 9 21/32 (245.3) I.D.: 5 5/32 (131.0) Height: 23 17/32 (597.7) F. Gskt: [1] Included</p>
<p>RS3738</p> 	<p>Radial Seal Outer Air Element Fits: Ford Louisville Trucks Use With: RS3739 Replaces: Ford F6HZ-9601-CA O.D.: 13 15/32 (342.1) I.D.: 8 5/32 (207.2) One End Height: 17 3/4 (450.9)</p>	<p>RS3744</p>  <p>Radial Seal Outer Air Element Fits: Ag-Chem, Case, Caterpillar, Hitachi, J.C. Bamford, John Deere, Link-Belt, New Holland, Volvo Equipment; DAF Trucks Use With: RS3745 Replaces: DAF 1295090; John Deere AT175223 O.D.: 10 31/32 (278.6) I.D.: 5 13/16 (147.6) One End Height: 20 9/16 (522.3) Related To: RS3744XP (Extreme Performance Nano Version)</p>

Measurements Are Shown In Inches And (Millimeters)

WARNING: These products can expose you to chemicals, including Diisononyl Phthalate, Carbon black extracts, Nickel, 1,3 Butadiene, Ethylene Oxide, Epichlorohydrin, which are known to the State of California to cause cancer, and Bisphenol, Ethylene Glycol, Ethylene Oxide, 1,3 Butadiene, Epichlorohydrin, which are known to the State of California to cause birth defects or other reproductive harm. For more information go to www.P65Warnings.ca.gov.

RS3744XP Extreme Performance Nano Radial Seal Outer Air Element

Fits: Ag-Chem, Case, Caterpillar, Hitachi, J.C. Bamford, John Deere, Link-Belt, New Holland, Volvo Equipment; DAF Trucks
Use With: RS3745
Replaces: DAF 1295090; John Deere AT175223
O.D.: 10 31/32 (278.6)
I.D.: 5 13/16 (147.6) One End
Height: 20 9/16 (522.3)
Related To: RS3744 (Standard Media Version)

RS3750 Radial Seal Air Element

Fits: Kenworth, Peterbilt Trucks
Replaces: Donaldson P542101
O.D.: 10 29/32 (277.0)
I.D.: 6 25/32 (172.2) One End
Height: 15 21/32 (397.7)
Related To: RS3750XP (Extreme Performance)

RS3745 Radial Seal Inner Air Element

Fits Inside: RS3744, RS3744XP
Fits: Ag-Chem, Case, Caterpillar, Hitachi, John Deere, New Holland, Volvo Equipment
Replaces: John Deere AT175224
O.D.: 5 29/32 (150.0)
I.D.: 4 13/32 (111.9) One End
Height: 19 19/32 (497.7)

RS3750XP Extreme Performance Nano Radial Seal Air Element

Fits: Kenworth, Peterbilt Trucks
Replaces: Donaldson DBA5107
O.D.: 10 29/32 (277.1)
I.D.: 6 3/4 (171.7)
Height: 15 5/32 (384.8)
Related To: RS3750 (Standard Media)

RS3746 Radial Seal Cab Air Element

Fits: John Deere Tractors
Replaces: John Deere R119168
O.D.: 6 1/2 (165.1)
I.D.: 3 9/16 (90.5) One End
Height: 12 17/32 (318.3)

PA3752 Air Element with Lid

Notes: OBSOLETE. Availability Limited to Dealer Stock.
Fits: Bomag, Hamm, Zettelmeyer Equipment; Mercedes-Benz Buses, Trucks
Replaces: Hamm 278947; Mercedes-Benz 10949604; Zettelmeyer 20782411
O.D.: 6 17/32 (165.9)
Lid 7 13/16 (198.4)
I.D.: 11/32 (8.7) & 3 3/8 (85.7)
Height: 13 27/32 (351.6)
A. Gskt: [1] Attached

RS3747 Radial Seal Inner Air Element

Fits Inside: RS3549, RS4595
Fits: Clark Lift Trucks
Replaces: Toyota 17744-U2100-71
O.D.: 3 5/16 (84.1)
I.D.: 2 15/32 (62.7) One End
Height: 12 1/32 (305.6)

PA3753 Air Element

Notes: OBSOLETE. Availability Limited to Dealer Stock.
Fits: Mercedes-Benz Trucks, Vans
Replaces: Mercedes-Benz 30943904
O.D.: 5 29/32 (150.0)
I.D.: 3/8 (9.5) & 2 13/16 (71.4)
Height: 9 1/32 (229.4)
A. Gskt: [1] Attached
Grommets: [1] Attached













RS3749 Radial Seal Air Element

Fits: Sterling Trucks
Replaces: Ford F6HZ-9601-BA
O.D.: 12 31/32 (329.4)
I.D.: 6 13/16 (173.0) One End
Height: 17 5/16 (439.7)

PA3754 Air Element

Fits: Iveco Trucks
Replaces: Iveco 1905710
O.D.: 12 7/8 (327.0)
I.D.: 13/32 (10.3) & 8 1/2 (215.9)
Height: 18 3/4 (476.3)
A. Gskt: [2] Attached









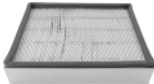

Measurements Are Shown In Inches And (Millimeters)

WARNING: These products can expose you to chemicals, including Diisononyl Phthalate, Carbon black extracts, Nickel, 1,3 Butadiene, Ethylene Oxide, Epichlorohydrin, which are known to the State of California to cause cancer, and Bisphenol, Ethylene Glycol, Ethylene Oxide, 1,3 Butadiene, Epichlorohydrin, which are known to the State of California to cause birth defects or other reproductive harm. For more information go to www.P65Warnings.ca.gov.

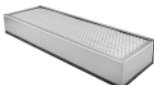
<p>PA3755 Outer Air Element Fits: Volvo Loaders Replaces: Volvo 6631290, 6631299 O.D.: 10 1/16 (255.6) I.D.: 7 9/16 (192.1) Height: 7 11/16 (195.3)</p> 	<p>PA3763 Panel Air Element with Foam Pad Fits: Dodge Light-Duty Trucks Replaces: Chrysler 4728406, 4856649, 4864442 Length: 11 13/16 (300.0) Width: 10 25/32 (273.8) Height: 2 11/16 (68.3)</p> 
<p>PA3756 Cab Air Element Fits: Caterpillar Equipment Replaces: Caterpillar 5G1913 Length: 16 (406.4) Width: 8 (203.2) Height: 2 3/16 (55.6)</p> 	<p>RS3764 Radial Seal Air Element Replaces: Donaldson P778674 O.D.: 12 9/32 (311.9) I.D.: 6 31/32 (177.0) One End Height: 22 29/32 (581.8)</p> 
<p>PA3757 Air Element Fits: Atlas Copco Compressors; Atlas-Weyhausen, Fiat Equipment Replaces: Atlas Copco 16196220; Atlas-Weyhausen 2673698 O.D.: 3 11/16 (93.7) I.D.: 11/32 (8.7) & 1 11/16 (42.9) Height: 6 25/32 (172.2) A. Gskt: [1] Attached</p> 	<p>PA3765 Outer Air Element Fits: Mercedes-Benz Trucks, Vans Replaces: Mercedes-Benz 30947004 O.D.: 12 29/32 (327.8) I.D.: 7/16 (11.1) & 7 17/32 (191.3) Height: 18 7/8 (479.4) A. Gskt: [1] Attached</p> 
<p>PA3758 Air Element with Lid Replaces: Volvo 7354867 O.D.: 4 11/32 (110.3) Lid 5 3/8 (136.5) I.D.: 11/32 (8.7) & 1 31/32 (50.0) Height: 8 15/16 (227.0) A. Gskt: [2] Attached</p> 	<p>PA3766 Air Element Notes: OBSOLETE. Availability Limited to Dealer Stock. Fits: M.A.N. Buses Replaces: M.A.N. 83.08405.0000 O.D.: 11 29/32 (302.4) I.D.: 13/32 (10.3) & 7 17/32 (191.3) Height: 13 1/4 (336.5) A. Gskt: [1] Attached F. Gskt: [1] Included</p> 
<p>PA3760 Outer Air Element Fits: DAF, Iveco, M.A.N., Pegaso Buses, Trucks Replaces: DAF 393561; Iveco 1907533; Pegaso 173260 O.D.: 9 17/32 (242.1) I.D.: 7/16 (11.1) & 5 3/16 (131.8) Height: 14 27/32 (377.0) A. Gskt: [1] Attached F. Gskt: [1] Included</p> 	<p>PA3767 Air Element with 4 Bolt Holes in Flange Contains: [1] Grease packet Fits: Volvo Trucks Replaces: Volvo 1665898 O.D.: 12 3/4 (323.8) Flange 14 (355.6) I.D.: 7 25/32 (197.6) One End Height: 16 19/32 (421.5) A. Gskt: [2] Attached</p> 
<p>PA3761-FN Outer Air Element with Fins Fits: Ford Tractors Replaces: Ford E9NN-9601-GA, SBA314531128; New Holland 86512889 O.D.: 5 1/4 (133.4) Fins 6 3/8 (161.9) I.D.: 3/8 (9.5) & 2 5/8 (66.7) Height: 11 9/32 (286.5) A. Gskt: [1] Attached F. Gskt: [1] Included</p> 	<p>PA3768 Air Element with 4 Bolt Holes in Flange Fits: Volvo Trucks Replaces: Volvo 1665908 O.D.: 14 1/32 (356.4) Flange 14 7/8 (377.8) I.D.: 7 7/8 (200.0) One End Height: 16 5/16 (414.3) A. Gskt: [2] Attached</p> 











Measurements Are Shown In Inches And (Millimeters)

WARNING: These products can expose you to chemicals, including Diisononyl Phthalate, Carbon black extracts, Nickel, 1,3 Butadiene, Ethylene Oxide, Epichlorohydrin, which are known to the State of California to cause cancer, and Bisphenol, Ethylene Glycol, Ethylene Oxide, 1,3 Butadiene, Epichlorohydrin, which are known to the State of California to cause birth defects or other reproductive harm. For more information go to www.P65Warnings.ca.gov.

<p>PA3773 Air Element  Fits: Saab, Volkswagen Automotive, Vans Replaces: Saab 4023420; Volkswagen 25129620, 25129620-A O.D.: 7 3/16 (182.6) I.D.: 3 15/16 (100.0) Height: 4 1/16 (103.2)</p>	<p>PA3780 Outer Air Element  Replaces: Renault 5010317060 O.D.: 12 1/16 (306.4) I.D.: 11/16 (17.5) & 7 11/16 (195.3) Height: 18 23/32 (475.5) A. Gskt: [1] Attached F. Gskt: G103-N, [1] Wing Nut</p>
<p>PA3774 Inner Air Element  Fits Inside: PA3775 Fits: Agco, White Tractors Replaces: Deutz 72162544 O.D.: 5 15/16 (150.8) I.D.: 2 1/32 (16.7) & 4 27/32 (123.0) Height: 13 1/2 (342.9) A. Gskt: [1] Included F. Gskt: G103-N</p>	<p>PA3781 Cab Air Element  Fits: Caterpillar Equipment Replaces: Caterpillar 7X6041 Length: 12 1/4 (311.2) Width: 9 9/16 (242.9) Height: 2 9/16 (65.1) A. Gskt: [1] Attached</p>
<p>PA3775 Outer Air Element  Fits: Agco, White Equipment Use With: PA3774 Replaces: Deutz 72162543; White 30-3435318 O.D.: 9 29/32 (251.6) I.D.: 7/8 (22.2) & 6 1/16 (154.0) Height: 15 9/16 (395.3) A. Gskt: [1] Attached F. Gskt: [1] Included</p>	<p>PA3782 Cab Air Element  Fits: Caterpillar Equipment, Off-Highway Trucks Replaces: Caterpillar 8C9657 Length: 17 1/2 (444.5) Width: 6 (152.4) Height: 2 9/16 (65.1)</p>
<p>PA3777 Cab Air Element  Fits: Caterpillar Equipment Replaces: Caterpillar 3E0410 Length: 9 (228.6) Width: 7 (177.8) Height: 1 3/8 (34.9) A. Gskt: [1] Attached</p>	<p>PA3783 Inner Air Element  Fits Inside: PA3479 Fits: Hitachi Excavators; Isuzu Engines Replaces: Hitachi 4247974 O.D.: 5 3/16 (131.8) I.D.: 2 1/32 (16.7) & 3 31/32 (100.8) Height: 9 9/16 (242.9) A. Gskt: [1] Attached F. Gskt: G103-N</p>
<p>PA3778 Outer Air Element  Fits: John Deere Tractors Use With: PA2381 Replaces: John Deere AL65051 O.D.: 5 1/4 (133.4) I.D.: 2 1/32 (16.7) & 3 1/4 (82.6) Height: 12 1/2 (317.5) A. Gskt: [1] Attached F. Gskt: G103-N</p>	<p>PA3785-FN Outer Air Element with Fins and Lid  Fits: John Deere Tractors Replaces: John Deere M802606 O.D.: 4 3/32 (104.0) Lid 5 29/32 (150.0) I.D.: 2 1/32 (16.7) & 2 1/2 (63.5) Height: 10 1/2 (266.7) A. Gskt: [1] Attached F. Gskt: G103-N</p>
<p>PA3779-FN Outer Air Element with Fins  Fits: John Deere, New Holland Equipment Use With: PA2670 Replaces: John Deere RE45827; New Holland 86529587 O.D.: 6 3/32 (154.8) Fins 7 13/16 (198.4) I.D.: 3/4 (19.0) & 3 15/32 (88.1) Height: 13 9/32 (337.3) A. Gskt: [1] Attached F. Gskt: G103-N, [1] Wing Nut</p>	<p>PA3786-FN Outer Air Element with Fins  Fits: Ford Buses, Trucks Use With: PA2883 Replaces: Donaldson P900006; Motorcraft AFA92 O.D.: 12 1/8 (308.0) Fins 15 3/4 (400.0) I.D.: 7/8 (22.2) & 7 11/16 (195.3) Height: 16 1/2 (419.1) A. Gskt: [1] Attached F. Gskt: G129-N</p>

Measurements Are Shown In Inches And (Millimeters)

WARNING: These products can expose you to chemicals, including Diisononyl Phthalate, Carbon black extracts, Nickel, 1,3 Butadiene, Ethylene Oxide, Epichlorohydrin, which are known to the State of California to cause cancer, and Bisphenol, Ethylene Glycol, Ethylene Oxide, 1,3 Butadiene, Epichlorohydrin, which are known to the State of California to cause birth defects or other reproductive harm. For more information go to www.P65Warnings.ca.gov.

<p>PA3787</p> 	<p>Inner Air Element Fits Inside: PA3606 Fits: Claas, Liebherr, New Holland Equipment; M.A.N. Trucks Replaces: Claas 773820; Liebherr 7368215; M.A.N. 81.08304.0066 O.D.: 7 15/16 (201.6) Flange 8 5/16 (211.1) I.D.: 21/32 (16.7) & 7 11/32 (186.5) Height: 23 31/32 (608.8) I.Gskt: [1] Included</p>	<p>PA3795</p> 	<p>Outer Air Element Fits: Yanmar Tractors Replaces: Yanmar 124764-12510 O.D.: 4 3/32 (104.0) I.D.: 25/32 (19.8) & 2 15/32 (62.7) Height: 7 25/32 (197.6) A. Gskt: [1] Attached F. Gskt: G103-N</p>
<p>PA3790</p> 	<p>Outer Air Element with Lid Fits: Massey Ferguson Tractors Use With: PA3950 Replaces: GMC 25313867; Massey Ferguson 3595500-M1 O.D.: 7 13/16 (198.4) Lid 8 13/32 (213.5) I.D.: 5/8 (15.9) & 3 7/16 (87.3) Height: 11 1/32 (280.2) A. Gskt: [1] Attached F. Gskt: [1] Wing Nut</p>	<p>PA3796</p> 	<p>Outer Air Element Fits: John Deere Tractors Use With: PA3797 Replaces: John Deere AL78223 O.D.: 7 9/32 (184.9) Flange 9 9/32 (235.7) I.D.: 3 19/32 (91.3) One End Height: 12 1/4 (311.2) A. Gskt: [1] Attached</p>
<p>PA3791-FN</p> 	<p>Outer Air Element with Fins Fits: New Holland Equipment Use With: PA2489 Replaces: New Holland 86504145 O.D.: 5 1/4 (133.4) Fins 6 3/8 (161.9) I.D.: 21/32 (16.7) & 2 5/8 (66.7) Height: 11 1/2 (292.1) A. Gskt: [1] Attached F. Gskt: G103-N</p>	<p>PA3797</p> 	<p>Inner Air Element with 3 Bolts Fits Inside: PA3796 Fits: John Deere Tractors Replaces: John Deere AL78224 O.D.: 5 1/32 (127.8) Flange 7 13/16 (198.4) I.D.: 3 5/8 (92.1) One End Height: 5 3/16 (131.8) I.Gskt: [1] Included O-Ring: [3] Included</p>
<p>PA3792</p> 	<p>Outer Air Element Fits: Kubota Tractors Replaces: Kubota T0070-16323 O.D.: 4 3/32 (104.0) I.D.: 2 1/2 (63.5) Height: 9 15/16 (252.4) A. Gskt: [2] Attached</p>	<p>PA3798</p> 	<p>Cab Air Element Fits: Ford Tractors Replaces: Ford E4NN-94000N20-AE, E4NN-94000N20-AF Length: 18 1/4 (463.6) Width: 3 7/8 (98.4) Height: 3 3/16 (81.0) A. Gskt: [1] Attached</p>
<p>PA3794</p> 	<p>Outer Air Element Fits: Scania Trucks Replaces: Scania 395776 O.D.: 12 3/32 (307.2) I.D.: 21/32 (16.7) & 7 23/32 (196.1) Height: 17 5/32 (435.8) A. Gskt: [1] Attached F. Gskt: G103-N</p>	<p>PA3800</p> 	<p>Replacement for Ecolite Air Element in Disposable Housing Fits: Blue Bird Buses; Farr Air Cleaners Replaces: Farr 117122-000 O.D.: 11 1/2 (292.1) I.D.: 7 (177.8) One End Height: 25 19/32 (650.1)</p>
		<p>PA3801-FN</p> 	<p>Outer Air Element with Fins Replaces: Caterpillar 97-1293 O.D.: 5 1/4 (133.4) Fins 6 11/32 (161.1) I.D.: 21/32 (16.7) & 3 5/16 (84.1) Height: 11 1/2 (292.1) A. Gskt: [1] Attached F. Gskt: G103-N</p>











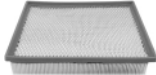

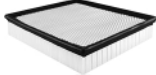
Measurements Are Shown In Inches And (Millimeters)

WARNING: These products can expose you to chemicals, including Diisononyl Phthalate, Carbon black extracts, Nickel, 1,3 Butadiene, Ethylene Oxide, Epichlorohydrin, which are known to the State of California to cause cancer, and Bisphenol, Ethylene Glycol, Ethylene Oxide, 1,3 Butadiene, Epichlorohydrin, which are known to the State of California to cause birth defects or other reproductive harm. For more information go to www.P65Warnings.ca.gov.

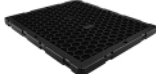
<p>PA3802 Cab Air Element Fits: Caterpillar Equipment Replaces: Caterpillar 7T3519 Length: 19 11/16 (500.1) Width: 3 15/16 (100.0) Height: 3 9/16 (90.5) A. Gskt: [1] Included</p> 	<p>PA3809 Inner Air Element Fits Inside: PA3808-FN Fits: Komatsu Excavators Replaces: Komatsu 20501-K1480 O.D.: 4 9/16 (115.9) I.D.: 2 1/32 (16.7) & 3 7/16 (87.3) Height: 16 1/2 (419.1) A. Gskt: [1] Attached F. Gskt: G103-N</p> 
<p>PA3803 Cab Air Element Fits: Caterpillar Equipment Replaces: Caterpillar 7T7358 Length: 12 7/8 (327.0) Width: 12 (304.8) Height: 2 9/16 (65.1) A. Gskt: [1] Attached</p> 	<p>PA3810 Inner Air Element Fits Inside: PA3806 Replaces: Ingersoll-Rand 36864379 O.D.: 9 11/32 (237.3) I.D.: 13/16 (20.6) & 8 1/8 (206.4) Height: 25 9/32 (642.1) A. Gskt: [1] Attached F. Gskt: [1] Included</p> 
<p>PA3804 Cab Air Element Fits: Caterpillar Equipment Replaces: Caterpillar 9X3352 Length: 9 (228.6) Width: 9 (228.6) Height: 2 9/16 (65.1) A. Gskt: [1] Attached</p> 	<p>PA3811-FN Outer Air Element with Fins and Lid Fits: J.C. Bamford Equipment Use With: PA3812 Replaces: J.C. Bamford 32/905301 O.D.: 5 1/8 (130.2) Lid 5 21/32 (143.7) I.D.: 2 15/32 (62.7) One End Height: 8 13/32 (213.5) A. Gskt: [1] Attached, [1] Wing Nut</p> 
<p>PA3805-FN Air Element with Fins Contains: Flame Retardant Media Fits: Hyster Lift Trucks Replaces: Hyster 1377093 O.D.: 4 3/32 (104.0) Fins 5 1/8 (130.2) I.D.: 25/32 (19.8) & 2 15/32 (62.7) Height: 14 5/16 (363.5) A. Gskt: [1] Attached F. Gskt: G103-N</p> 	<p>PA3812 Inner Air Element Fits Inside: PA3811-FN Fits: J.C. Bamford Equipment Replaces: J.C. Bamford 32/905302 O.D.: 2 3/8 (60.3) Flange 2 3/4 (69.9) I.D.: 21/32 (16.7) & 1 31/32 (50.0) Height: 6 31/32 (177.0) A. Gskt: [1] Attached F. Gskt: [1] Included</p> 
<p>PA3806 Outer Air Element with Bail Handle Fits: Ingersoll-Rand Compressors Use With: PA3810 Replaces: Ingersoll-Rand 36864361 O.D.: 13 13/16 (350.8) Boot 14 1/2 (368.3) I.D.: 15/16 (23.8) & 9 1/2 (241.3) Height: 27 5/16 (693.7) A. Gskt: [2] Attached F. Gskt: [1] Included</p> 	<p>PA3814 DynaCell Air Element Replacement Fits: Various Oil Field, Marine Applications Replaces: Farr T520 Length: 19 1/2 (495.3) Width: 19 1/2 (495.3) Height: 5 1/4 (133.4) A. Gskt: [1] Attached Related To: PA3815 (Top Open)</p> 
<p>PA3807 Air Element with Lid Fits: Mercedes-Benz Trucks, Vans Replaces: Mercedes-Benz 10949404 O.D.: 8 9/32 (210.3) Lid 9 29/32 (251.6) I.D.: 11/32 (8.7) & 4 1/16 (103.2) Height: 8 11/16 (220.7) A. Gskt: [1] Attached</p> 	<p>PA3815 DynaCell Air Element Replacement Fits: Various Oil Field, Marine Applications Replaces: Farr T520D Length: 19 1/2 (495.3) Width: 19 1/2 (495.3) Height: 5 1/4 (133.4) A. Gskt: [1] Attached Related To: PA3814 (Top Closed)</p> 

Measurements Are Shown In Inches And (Millimeters)

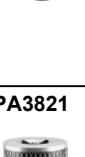
WARNING: These products can expose you to chemicals, including Diisononyl Phthalate, Carbon black extracts, Nickel, 1,3 Butadiene, Ethylene Oxide, Epichlorohydrin, which are known to the State of California to cause cancer, and Bisphenol, Ethylene Glycol, Ethylene Oxide, 1,3 Butadiene, Epichlorohydrin, which are known to the State of California to cause birth defects or other reproductive harm. For more information go to www.P65Warnings.ca.gov.

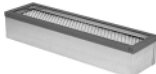
<p>PA3816</p> 	<p>Outer Air Element with Lid Fits: J.C. Bamford Equipment Use With: PA3817 Replaces: J.C. Bamford 32/903001 O.D.: 6 9/32 (159.5) Lid 6 25/32 (172.2) I.D.: 2 27/32 (72.2) One End Height: 10 3/32 (256.4) A. Gskt: [1] Attached, [1] Wing Nut</p>	<p>PA3822 Cab Air Element Fits: Caterpillar Equipment Replaces: Caterpillar 112-7448 Length: 11 9/32 (286.5) Width: 8 15/16 (227.0) Height: 1 29/32 (48.4)</p> 
<p>PA3817</p> 	<p>Inner Air Element Fits Inside: PA3816 Fits: J.C. Bamford Equipment Replaces: J.C. Bamford 32/903002 O.D.: 2 11/16 (68.3) Flange 3 17/32 (89.7) I.D.: 21/32 (16.7) & 2 7/16 (61.9) Height: 9 3/32 (231.0) F. Gskt: [1] Included</p>	<p>PA3823 Cab Air Element Fits: Caterpillar Equipment Replaces: Caterpillar 107-0266 Length: 11 13/16 (300.0) Width: 10 3/4 (273.1) Height: 2 3/16 (55.6)</p> 
<p>PA3818-FN</p> 	<p>Outer Air Element with Fins and Lid Fits: J.C. Bamford Equipment Use With: PA3819 Replaces: J.C. Bamford 32/905001 O.D.: 5 1/2 (139.7) Lid 6 25/32 (172.2) I.D.: 2 13/16 (71.4) Height: 8 5/8 (219.1) A. Gskt: [1] Attached, [1] Wing Nut</p>	<p>PA3824 Cab Air Element Fits: Ford, New Holland Tractors Replaces: New Holland 9823782 Length: 26 15/16 (684.2) Width: 6 1/4 (158.8) Height: 2 9/16 (65.1) A. Gskt: [1] Attached</p> 
<p>PA3819</p> 	<p>Inner Air Element Fits Inside: PA3818-FN; PA4614 Fits: J.C. Bamford Equipment Replaces: J.C. Bamford 32/905002 O.D.: 2 11/16 (68.3) Flange 3 17/32 (89.7) I.D.: 21/32 (16.7) & 2 13/32 (61.1) Height: 6 31/32 (177.0) A. Gskt: [1] Attached F. Gskt: [1] Included</p>	<p>PA3825 Cab Air Element Fits: Caterpillar Crawler Tractors, Loaders Replaces: Caterpillar 6T5068 Length: 12 19/32 (319.9) Width: 10 5/8 (269.9) Height: 5/8 (15.9)</p> 
<p>PA3820-FN</p> 	<p>Air Element with Fins and Lid Fits: Hitachi, J.C. Bamford Excavators Replaces: J.C. Bamford KAP0482 O.D.: 4 3/32 (104.0) Lid 5 29/32 (150.0) I.D.: 19/32 (15.1) & 2 17/32 (64.3) Height: 10 9/16 (268.3) A. Gskt: [1] Attached, [1] Wing Nut</p>	<p>RS3826 Radial Seal Outer Air Element Fits: Caterpillar Gen Sets; New Holland, Volvo Equipment Use With: RS3827 Replaces: Volvo 11033998-3 O.D.: 12 9/32 (311.9) I.D.: 6 31/32 (177.0) One End Height: 22 29/32 (581.8)</p> 
<p>PA3821</p> 	<p>Air Element Notes: OBSOLETE. Availability Limited to Dealer Stock. Fits: J.C. Bamford Equipment Replaces: J.C. Bamford 98/800031; GMC 25096242 O.D.: 4 3/4 (120.7) I.D.: 2 1/8 (54.0) One End Height: 11 1/4 (285.8) A. Gskt: [1] Attached, [1] Wing Nut</p>	<p>RS3827 Radial Seal Inner Air Element Fits Inside: RS3826 Fits: Caterpillar Gen Sets; New Holland, Volvo Equipment Replaces: Volvo 11033999-1 O.D.: 7 1/16 (179.4) I.D.: 5 11/16 (144.5) One End Height: 22 3/32 (561.2)</p> 
<p>PA3822</p> 	<p>Cab Air Element Fits: Case Equipment Replaces: Case R53519 Length: 12 1/4 (311.2) Width: 4 (101.6) Height: 2 9/16 (65.1) A. Gskt: [1] Attached</p> 	<p>PA3828 Cab Air Element Fits: Caterpillar Motor Graders Replaces: Caterpillar 9X4986 Length: 14 13/16 (376.2) Width: 4 (101.6) Height: 2 11/16 (68.3) A. Gskt: [1] Included</p> 

Measurements Are Shown In Inches And (Millimeters)

WARNING: These products can expose you to chemicals, including Diisononyl Phthalate, Carbon black extracts, Nickel, 1,3 Butadiene, Ethylene Oxide, Epichlorohydrin, which are known to the State of California to cause cancer, and Bisphenol, Ethylene Glycol, Ethylene Oxide, 1,3 Butadiene, Epichlorohydrin, which are known to the State of California to cause birth defects or other reproductive harm. For more information go to www.P65Warnings.ca.gov.

PA3832



Inner Air Element
Fits Inside: LL1886, PA1886, PA1886XP
Fits: Komatsu Excavators
Replaces: Komatsu 20801-68510
O.D.: 7 5/16 (185.7)
I.D.: 2 1/32 (16.7) & 6 5/32 (156.4)
Height: 15 1/2 (393.7)
A. Gskt: [1] Attached
F. Gskt: [1] Metal Washer

PA3833



Air Element
Fits: Caterpillar, Mitsubishi Lift Trucks
Replaces: Caterpillar 108-5330; Hyster 3111230; Mitsubishi 91361-13300
O.D.: 4 1/4 (108.0)
 Flange 6 3/32 (154.8)
I.D.: 2 5/16 (58.7) One End
Height: 9 3/32 (231.0)
A. Gskt: [2] Attached

PA3834

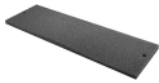

Foam Cab Air Element
Fits: Caterpillar Equipment
Replaces: Caterpillar 7T3549
Length: 14 5/8 (371.5)
Width: 4 1/2 (114.3)
Height: 1/2 (12.7)

PA3835



Foam Replacement Pad
Fits: Caterpillar Equipment
Replaces: Caterpillar 3E0411
Length: 9 (228.6)
Width: 7 (177.8)
Height: 1/4 (6.4)

PA3836



Air Element
Fits: Citroen, Fiat, Iveco, Peugeot Trucks, Vans
Replaces: Citroen 1444A1; Iveco 1902457; Peugeot 144409
O.D.: 6 5/16 (160.3)
I.D.: 3 29/32 (99.2)
Height: 6 31/32 (177.0)

PA3838



Air Element
Fits: Mercedes-Benz Trucks, Vans
Replaces: Mercedes-Benz A0030949204
O.D.: 16 13/16 (427.0)
I.D.: 13/32 (10.3) & 10 (254.0)
Height: 10 5/16 (261.9)
F. Gskt: [1] Included

PA3839



Cab Air Element
Fits: Volvo Trucks
Replaces: Volvo 8143691, 8143691-7, 8144430
Length: 8 9/32 (210.3)
Width: 8 9/32 (210.3)
Height: 1 15/16 (49.2)

PA3840

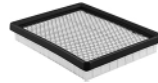

Panel Air Element
Fits: Thermo King Refrigeration Units
Replaces: Thermo King 11-7234
Length: 7 5/8 (193.7)
Width: 6 1/16 (154.0)
Height: 1 3/32 (27.8)

PA3843

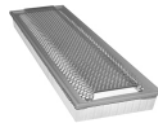

Panel Air Element
Fits: Mercedes-Benz Buses, Trucks, Vans
Replaces: Mercedes-Benz 20949304
Length: 23 17/32 (597.7)
Width: 6 23/32 (170.7)
Height: 3 3/16 (81.0)

PA3844



Air Element
Fits: Mercedes-Benz Trucks, Vans
Replaces: Mercedes-Benz A0030949104
O.D.: 16 17/32 (419.9)
I.D.: 13/32 (10.3) & 10 (254.0)
Height: 12 17/32 (318.3)
F. Gskt: [1] Included

PA3847



Inner Air Element
Fits Inside: PA3652, PA3860, PA3862-FN
Fits: Fiat-Allis, John Deere, Liebherr, Massey Ferguson, New Holland, Sisu Equipment
Replaces: Fiat 1930792; John Deere RE42762; Liebherr 7403951; Massey Ferguson 3580724-M1
O.D.: 5 15/16 (150.8)
I.D.: 2 1/32 (16.7) & 4 27/32 (123.0)
Height: 15 (381.0)
A. Gskt: [1] Attached
F. Gskt: [1] Included

PA3848-FN



Outer Air Element with Fins
Fits: Manitou Equipment
Use With: PA4827
Replaces: Manitou 177130
O.D.: 6 3/32 (154.8)
 Fins 7 27/32 (199.2)
I.D.: 3 15/32 (88.1)
Height: 12 1/16 (306.4)
A. Gskt: [1] Attached
F. Gskt: [1] Included













PA3849



Outer Air Element with Lid
Fits: Fiat, Same Tractors
Use With: PA1981
Replaces: Fiat 1930786, 221190599
O.D.: 9 7/32 (234.2)
 Lid 11 (279.4)
I.D.: 4 27/32 (123.0)
Height: 16 3/8 (415.9)
A. Gskt: [1] Attached
F. Gskt: [1] Wing Nut

Measurements Are Shown In Inches And (Millimeters)

WARNING: These products can expose you to chemicals, including Diisononyl Phthalate, Carbon black extracts, Nickel, 1,3 Butadiene, Ethylene Oxide, Epichlorohydrin, which are known to the State of California to cause cancer, and Bisphenol, Ethylene Glycol, Ethylene Oxide, 1,3 Butadiene, Epichlorohydrin, which are known to the State of California to cause birth defects or other reproductive harm. For more information go to www.P65Warnings.ca.gov.

<p>PA3850 Outer Air Element with Lid Fits: Fiat Tractors Use With: PA3851 Replaces: Fiat 1930174 O.D.: 9 29/32 (251.6) Lid 10 27/32 (275.4) I.D.: 4 13/16 (122.2) Height: 13 3/8 (339.7) A. Gskt: [1] Attached, [1] Wing Nut</p> 	<p>PA3859 Outer Air Element with Lid Fits: Case-International, Fiat, New Holland Equipment Use With: PA2791 Replaces: Fiat 1930536 O.D.: 5 7/16 (138.1) Lid 7 1/16 (179.4) I.D.: 2 13/16 (71.4) Height: 13 15/16 (354.0) A. Gskt: [1] Attached, [1] Wing Nut</p> 
<p>PA3851 Inner Air Element Notes: Sometimes used as Inner Air Element with PA1884 on Fiat tractors. Fits Inside: PA3850, PA3864 Fits: Fiat Tractors Replaces: Fiat 1930175; Massey Ferguson 3385734-M1 O.D.: 4 9/16 (115.9) I.D.: 3 17/32 (89.7) One End Height: 12 1/4 (311.2) A. Gskt: [1] Attached</p> 	<p>PA3860 Outer Air Element with Lid Fits: Laverda, Massey Ferguson Equipment Use With: PA3847 Replaces: Fiat 1930783; New Holland 452529 O.D.: 10 13/32 (264.3) Lid 12 1/2 (317.5) I.D.: 19/32 (15.1) & 6 (152.4) Height: 16 1/2 (419.1) A. Gskt: [1] Attached F. Gskt: [1] Washer, [1] Wing Nut</p> 
<p>PA3852-FN Outer Air Element with Fins and Lid Fits: Fiat-Allis Equipment Use With: PA2670 Replaces: Fiat 71405431 O.D.: 6 3/32 (154.8) Lid 8 13/32 (213.5) I.D.: 3 15/32 (88.1) One End Height: 13 15/16 (354.0) A. Gskt: [1] Attached, [1] Wing Nut</p> 	<p>PA3861 Inner Air Element Fits Inside: PA2840 Fits: Astra Trucks Replaces: Astra 107030 O.D.: 7 5/16 (185.7) Flange 8 15/32 (215.1) I.D.: 11/16 (17.5) & 6 5/32 (156.4) Height: 19 5/32 (486.6) A. Gskt: [1] Attached F. Gskt: [1] Included</p> 
<p>PA3853-FN Air Element with Fins and Lid Fits: Fermecc, Massey Ferguson Equipment Replaces: Massey Ferguson 3515586-M1, 3595503-M1 O.D.: 7 5/8 (193.7) Lid 8 5/16 (211.1) I.D.: 3 7/16 (87.3) Height: 11 1/16 (281.0) A. Gskt: [1] Attached F. Gskt: [1] Included, [1] Wing Nut</p> 	<p>PA3862-FN Outer Air Element with Fins Fits: Fiat-Allis, New Holland Equipment Use With: PA3847 Replaces: Fiat 1930604 O.D.: 9 13/16 (249.2) Fins 11 7/16 (290.5) I.D.: 5/8 (15.9) & 6 3/16 (157.2) Height: 16 1/2 (419.1) A. Gskt: [1] Attached</p> 
<p>PA3854-FN Air Element with Fins and Lid Fits: Ammann, Fiat, Fiat-Allis, Hitachi, Vibromax Equipment Replaces: Fiat 1930603, 1930826, 71415282 O.D.: 9 13/16 (249.2) Lid 11 (279.4) I.D.: 5 3/8 (136.5) One End Height: 16 7/16 (417.5) A. Gskt: [1] Attached F. Gskt: [1] Washer, [1] Wing Nut</p> 	<p>PA3863 Air Element Fits: Hino Trucks Replaces: Hino 1780B-44070, 1780B-G8011 O.D.: 7 17/32 (191.3) I.D.: 3 5/16 (84.1) Height: 5 11/16 (144.5)</p> 
<p>PA3855-FN Air Element with Fins and Lid Fits: Fiat-Allis, Hitachi Equipment Replaces: Fiat 1930602, 71420350, 700055856 O.D.: 9 13/16 (249.2) Lid 12 15/32 (316.7) I.D.: 21/32 (16.7) & 6 3/16 (157.2) Height: 16 1/2 (419.1) A. Gskt: [1] Attached F. Gskt: [1] Washer, [1] Wing Nut</p> 	<p>PA3864 Outer Air Element with Lid Fits: Massey Ferguson Equipment Use With: PA3851 Replaces: Massey Ferguson 3385733-M1 O.D.: 9 5/32 (232.6) Lid 11 (279.4) I.D.: 4 27/32 (123.0) Height: 13 19/32 (345.3) A. Gskt: [1] Attached F. Gskt: [1] Wing Nut</p> 

Measurements Are Shown In Inches And (Millimeters)

WARNING: These products can expose you to chemicals, including Diisononyl Phthalate, Carbon black extracts, Nickel, 1,3 Butadiene, Ethylene Oxide, Epichlorohydrin, which are known to the State of California to cause cancer, and Bisphenol, Ethylene Glycol, Ethylene Oxide, 1,3 Butadiene, Epichlorohydrin, which are known to the State of California to cause birth defects or other reproductive harm. For more information go to www.P65Warnings.ca.gov.

PA3865 Inner Air Element
Fits Inside: PA3484
Fits: Volvo Trucks
Replaces: Volvo 1080920
O.D.: 5 15/16 (150.8)
 Boot 6 25/32 (172.2)
I.D.: 15/32 (11.9) & 5 3/8 (136.5)
Height: 22 27/32 (580.2)
A. Gskt: [1] Attached
F. Gskt: [1] Included



PA3867 Air Element
Contains: Flame Retardant Media
Fits: Various Marine Applications
Replaces: Cummins 3924540; Donaldson B085046
O.D.: 8 1/2 (215.9)
I.D.: 4 (101.6) One End
Height: 12 3/8 (314.3)



PA3868 Air Element
Contains: Flame Retardant Media
Fits: Various Marine Applications
Replaces: Cummins 3924893; Donaldson B085048
O.D.: 8 17/32 (216.7)
I.D.: 3 (76.2) One End
Height: 12 3/8 (314.3)
Related To: PA2815 (without Flame Retardant Media)



PA3869 Cab Air Element with Lift Tabs
Notes: Uses 2 filters per application.
Fits: Case Loaders
Replaces: International 1970006-C2
Length: 20 (508.0)
Width: 9 (228.6)
Height: 2 9/16 (65.1)
A. Gskt: [1] Attached



RS3870 Radial Seal Outer Air Element
Contains: Blank Band
Fits: Ag-Chem, Case, Crane Carrier, Doosan, Hitachi, Hyster, John Deere, Liebherr, Link-Belt, New Holland, Terex, Volvo Off-Highway Equipment; Peterbilt Trucks
Use With: RS3871, RS4639
Replaces: Terex 15270188; Volvo 11033996
O.D.: 12 9/32 (311.9)
I.D.: 6 31/32 (177.0) One End
Height: 20 17/32 (521.5)
Related To: RS3870XP (Extreme Performance), RS4638 (without Blank Band)



RS3870XP Extreme Performance Nano Radial Seal Outer Air Element
Contains: Blank Band
Fits: Ag-Chem, Case, Crane Carrier, Doosan, Hitachi, Hyster, John Deere, Liebherr, Link-Belt, New Holland, Terex, Volvo Off-Highway Equipment; Peterbilt Trucks
Use With: RS3871, RS4639
Replaces: Donaldson DBA5116
O.D.: 12 9/32 (311.9)
I.D.: 6 15/16 (176.5) One End
Height: 20 9/16 (522)
Related To: RS3870 (Standard Version) RS4638 (without Blank Band)



RS3871 Radial Seal Inner Air Element
Fits Inside: RS3870, RS3870XP, RS4638
Fits: Caterpillar, Hitachi, John Deere, Terex, Volvo Equipment
Replaces: Terex 15270189; Volvo 11033997-5
O.D.: 7 1/16 (179.4)
I.D.: 5 11/16 (144.5) One End
Height: 19 31/32 (507.2)
Related To: RS4639 (with Flame Retardant Media)



PA3872 Reinforced Cotton Fiber Panel Air Element
Replaces: Airguard DP40-205
Length: 23 3/8 (593.7)
Width: 23 3/8 (593.7)
Height: 1 3/4 (44.4)

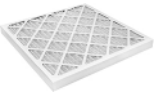

PA3873 Reinforced Cotton Fiber Panel Air Element
Fits: Farr Air Cleaners
Replaces: Farr 49880012
Length: 23 3/8 (593.7)
Width: 19 3/8 (492.1)
Height: 1 3/4 (44.4)



PA3874 Air Element
Fits: Sullair Compressors
Replaces: Sullair 225005-1136
O.D.: 9 7/32 (234.2)
I.D.: 21/32 (16.7) & 5 5/16 (134.9)
Height: 11 15/16 (303.2)
A. Gskt: [1] Attached
F. Gskt: G103-N















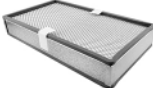

PA3875-FN Air Element with Fins and Lid
Fits: Kobelco, Komatsu Equipment
Replaces: Kobelco 2446U271-S2; Komatsu 3EC-01-11630, 3EC-01-11630-L, Z76-01-11630
O.D.: 6 3/8 (161.9)
 Lid 7 1/8 (181.0)
I.D.: 21/32 (16.7) & 2 5/8 (66.7)
Height: 11 1/2 (292.1)
A. Gskt: [1] Attached
F. Gskt: G103-N



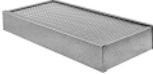











Measurements Are Shown In Inches And (Millimeters)

WARNING: These products can expose you to chemicals, including Diisononyl Phthalate, Carbon black extracts, Nickel, 1,3 Butadiene, Ethylene Oxide, Epichlorohydrin, which are known to the State of California to cause cancer, and Bisphenol, Ethylene Glycol, Ethylene Oxide, 1,3 Butadiene, Epichlorohydrin, which are known to the State of California to cause birth defects or other reproductive harm. For more information go to www.P65Warnings.ca.gov.

<p>PA3876 Air Element  Notes: OBSOLETE. Availability Limited to Dealer Stock. Fits: Iveco Trucks Replaces: Iveco 1907695 O.D.: 12 29/32 (327.8) I.D.: 13/32 (10.3) & 8 5/8 (219.1) Height: 20 3/16 (512.8) A. Gskt: [1] Attached F. Gskt: [1] Included, [1] Steel Washer</p>	<p>RS3882XP Extreme Performance Nano Radial Seal Outer Air Element  Fits: John Deere Excavators Use With: RS3883 Replaces: John Deere AP35310 O.D.: 8 5/32 (207.2) I.D.: 4 3/16 (106.4) One End Height: 11 5/8 (295.3)</p>
<p>PA3877 Cab Air Element  Fits: Caterpillar Equipment Replaces: Caterpillar 9X8216 Length: 26 15/16 (684.2) Width: 5 15/16 (150.8) Height: 2 19/32 (65.9) A. Gskt: [1] Attached</p>	<p>RS3883 Radial Seal Inner Air Element  Fits Inside: RS3882; RS3882XP Fits: Barber-Greene, Caterpillar, John Deere Equipment Replaces: Caterpillar 108-0672; John Deere AT175345 O.D.: 4 1/4 (108.0) I.D.: 2 3/4 (69.9) One End Height: 10 25/32 (273.8)</p>
<p>PA3878 Cab Air Element  Fits: Hitachi, John Deere Equipment Replaces: John Deere AT103629, AT166805 Length: 18 (457.2) Width: 10 (254.0) Height: 2 15/16 (74.6) A. Gskt: [2] Attached</p>	<p>RS3884 Radial Seal Outer Air Element  Fits: Benford, Case-International, Dynapac, J.C. Bamford, New Holland, Pro-Tec Equipment Use With: RS3885 Replaces: J.C. Bamford 32/912901 O.D.: 8 5/32 (207.2) I.D.: 4 3/16 (106.4) One End Height: 16 9/16 (420.7)</p>
<p>PA3879-FN Air Element with Fins and Lid  Fits: Massey Ferguson Tractors Replaces: Massey Ferguson 3595518-M1 O.D.: 5 7/16 (138.1) Lid: 7 1/16 (179.4) I.D.: 2 27/32 (72.2) One End Height: 11 27/32 (300.8) A. Gskt: [1] Attached</p>	<p>RS3885 Radial Seal Inner Air Element  Fits Inside: RS3734, RS3734XP, RS3884, RS30059-FN Fits: Benford, Case-International, Caterpillar, Dynapac, J.C. Bamford, John Deere, Liebherr, New Holland, Pro-Tec Equipment Replaces: J.C. Bamford 32/912902 O.D.: 4 1/4 (108.0) I.D.: 3 3/8 (85.7) One End Height: 16 1/16 (408.0)</p>
<p>PA3880 Air Element  Fits: Yamaha Golf Carts Replaces: Yamaha J381445000 O.D.: 4 1/8 (104.8) I.D.: 1 7/32 (31.0) One End Height: 5 13/16 (147.6)</p>	<p>PA3886 Cab Air Element with Bail Handle  Fits: John Deere Equipment Replaces: John Deere AH112712, AH115836 Length: 14 21/32 (372.3) Width: 3 3/8 (85.7) to: 5 1/4 (133.4) Height: 2 7/16 (61.9) A. Gskt: [2] Attached</p>
<p>PA3881 Cab Air Element  Fits: Caterpillar Excavators Replaces: Caterpillar 8C4120; Nelson 87249N Length: 15 1/4 (387.3) Width: 7 5/16 (185.7) Height: 2 3/16 (55.6)</p>	<p>RS3882 Radial Seal Outer Air Element  Fits: Barber-Greene, Caterpillar, John Deere Equipment Use With: RS3883 Replaces: Caterpillar 108-0671; John Deere AT175344 O.D.: 8 5/32 (207.2) I.D.: 4 1/4 (108.0) One End Height: 11 5/8 (295.3)</p>
<p>RS3882 Radial Seal Outer Air Element  Fits: Barber-Greene, Caterpillar, John Deere Equipment Use With: RS3883 Replaces: Caterpillar 108-0671; John Deere AT175344 O.D.: 8 5/32 (207.2) I.D.: 4 1/4 (108.0) One End Height: 11 5/8 (295.3)</p>	<p>PA3887 Outer Air Element  Fits: John Deere Equipment Use With: PA3889 Replaces: John Deere AZ45868 O.D.: 12 3/32 (307.2) I.D.: 21/32 (16.7) & 7 11/16 (195.3) Height: 22 1/2 (571.5) A. Gskt: [1] Attached F. Gskt: G103-N</p>













Measurements Are Shown In Inches And (Millimeters)

WARNING: These products can expose you to chemicals, including Diisononyl Phthalate, Carbon black extracts, Nickel, 1,3 Butadiene, Ethylene Oxide, Epichlorohydrin, which are known to the State of California to cause cancer, and Bisphenol, Ethylene Glycol, Ethylene Oxide, 1,3 Butadiene, Epichlorohydrin, which are known to the State of California to cause birth defects or other reproductive harm. For more information go to www.P65Warnings.ca.gov.

<p>RS3888 Radial Seal Air Element Fits: DAF Trucks Replaces: DAF 1317409 O.D.: 10 31/32 (278.6) I.D.: 5 13/16 (147.6) One End Height: 18 7/8 (479.4)</p> 	<p>PA3894 Air Element Fits: Various Industrial Equipment Replaces: Nelson 70459A, 70459N O.D.: 7 29/32 (200.8) I.D.: 4 3/32 (104.0) Height: 11 1/2 (292.1)</p> 
<p>PA3889 Inner Air Element Fits Inside: PA3887 Fits: John Deere Equipment Replaces: John Deere AZ45867 O.D.: 7 1/4 (184.2) Flange 8 13/32 (213.5) I.D.: 11/16 (17.5) & 6 3/16 (157.2) Height: 21 13/16 (554.0) A. Gskt: [1] Attached F. Gskt: G103-N</p> 	<p>PA3895-FN Air Element with Fins Fits: Bobcat Equipment Replaces: Melroe-Bobcat 897064B O.D.: 3 1/4 (82.6) Fins 4 1/4 (108.0) I.D.: 13/32 (10.3) & 1 27/32 (46.8) Height: 7 1/4 (184.2) A. Gskt: [1] Attached F. Gskt: [1] Included</p> 
<p>PA3890 Air Element with Foam Wrap Fits: Kohler Engines Replaces: Kohler 253107 O.D.: 8 3/4 (222.3) I.D.: 4 3/32 (104.0) Height: 5 31/32 (151.6)</p> 	<p>PA3896 Air Element Notes: Sometimes used as Inner Air Element with PA2582. Fits: Champion Graders; Ingersoll-Rand Compressors Replaces: Ingersoll-Rand 35384627 O.D.: 6 3/8 (161.9) I.D.: 5/8 (15.9) & 5 7/16 (138.1) Height: 19 (482.6) A. Gskt: [1] Attached F. Gskt: G103-N</p> 
<p>PA3891 Replacement for Ecolite Air Filter in Disposable Housing Contains: Water Drain Valve Fits: Farr Air Cleaners; Thomas Buses Replaces: Farr 119862-001, 119862-001G; Thomas 61100179 O.D.: 9 11/16 (246.1) Inlet: 6 Outlet: 6 Height: 19 13/16 (503.2)</p> 	<p>PA3897 Cab Air Element Fits: John Deere Equipment Replaces: John Deere AT74377 Length: 11 31/32 (304.0) Width: 9 15/16 (252.4) Height: 2 23/32 (69.1) A. Gskt: [1] Attached</p> 
<p>PA3892 Outer Air Element with Lift Tab Fits: Ingersoll-Rand Compressors Use With: PA3893 Replaces: Ingersoll-Rand 36867786 O.D.: 12 (304.8) Boot 12 15/32 (316.7) I.D.: 7/8 (22.2) & 7 7/8 (200.0) Height: 20 1/2 (520.7) A. Gskt: [2] Attached F. Gskt: [1] Metal Washer</p> 	<p>PA3898 Outer Air Element Fits: Kobelco Equipment Use With: PA3899 Replaces: Kobelco 2446R254-S5 O.D.: 8 1/8 (206.4) I.D.: 21/32 (16.7) & 4 27/32 (123.0) Height: 21 1/2 (546.1) A. Gskt: [1] Attached F. Gskt: G103-N</p> 
<p>PA3893 Inner Air Element Fits Inside: PA3892 Fits: Ingersoll-Rand Compressors Replaces: Ingersoll-Rand 36876019 O.D.: 7 5/8 (193.7) I.D.: 7/8 (22.2) & 6 3/16 (157.2) Height: 18 1/2 (469.9) A. Gskt: [1] Attached F. Gskt: [1] Metal Washer</p> 	<p>PA3899 Inner Air Element Fits Inside: PA3898 Fits: Kobelco Equipment Replaces: Kobelco 2446R254-S6 O.D.: 4 9/16 (115.9) Boot 5 3/4 (146.0) I.D.: 21/32 (16.7) & 3 7/16 (87.3) Height: 20 13/32 (518.3) A. Gskt: [1] Attached F. Gskt: G103-N</p> 











Measurements Are Shown In Inches And (Millimeters)

WARNING: These products can expose you to chemicals, including Diisononyl Phthalate, Carbon black extracts, Nickel, 1,3 Butadiene, Ethylene Oxide, Epichlorohydrin, which are known to the State of California to cause cancer, and Bisphenol, Ethylene Glycol, Ethylene Oxide, 1,3 Butadiene, Epichlorohydrin, which are known to the State of California to cause birth defects or other reproductive harm. For more information go to www.P65Warnings.ca.gov.

<p>PA3900 Cab Air Element Fits: John Deere Tractors Replaces: John Deere RE70742 Length: 12 1/2 (317.5) Width: 6 1/2 (165.1) Height: 1 3/4 (44.4)</p> 	<p>PA3906 Outer Air Element Fits: Mitsubishi Trucks Use With: PA5412 Replaces: Mitsubishi ME073252 O.D.: 9 1/8 (231.8) I.D.: 15/16 (23.8) & 5 13/16 (147.6) Height: 17 19/32 (446.9) A. Gskt: [1] Attached F. Gskt: [1] Included</p> 
<p>PA3901 Air Element Fits: Exmark Lawn & Garden Tractors; Kohler Engines Use With: PA3901 FOAM Replaces: Kohler 2408303 O.D.: 6 31/32 (177.0) I.D.: 5 19/32 (142.1) Height: 3 (76.2)</p> 	<p>PA3907 Replacement for Ecolite Air Filter in Disposable Housing Fits: Farr Air Cleaners; Ottawa Trucks Replaces: Farr 400292-000, 400292-000-A O.D.: 11 1/2 (292.1) Inlet: 6 Outlet: 7 Height: 16 29/32 (429.4)</p> 
<p>PA3901 FOAM Foam Blanket for PA3901 Use With: PA3901 O.D.: 6 25/32 (172.2) I.D.: 6 5/16 (160.3) Height: 2 23/32 (69.1)</p> 	<p>PA3902 Outer Air Element with Lift Bar Fits: New Holland Tractors Use With: PA3903 Replaces: New Holland 82008596 O.D.: 8 1/2 (215.9) Flange Gasket 10 (254.0) I.D.: 19/32 (15.1) & 4 27/32 (123.0) Height: 12 3/8 (314.3) A. Gskt: [2] Attached F. Gskt: [1] Included</p> 
<p>PA3903 Inner Air Element Fits Inside: PA3902 Fits: New Holland Tractors Replaces: New Holland 82008597 O.D.: 4 23/32 (119.9) Flange 5 29/32 (150.0) I.D.: 13/32 (10.3) & 3 31/32 (100.8) Height: 12 1/4 (311.2) A. Gskt: [2] Attached</p> 	<p>PA3908 Outer Air Element Fits: Kubota Tractors Use With: PA3909 Replaces: Kubota 17301-11080 O.D.: 6 (152.4) I.D.: 5/8 (15.9) & 4 (101.6) Height: 7 3/4 (196.9) A. Gskt: [1] Attached F. Gskt: G103-N</p> 
<p>PA3904 Outer Air Element Fits: Caterpillar Generators, Industrial, Marine Engines Use With: PA3905 Replaces: Caterpillar 4P0710 O.D.: 19 9/32 (489.7) I.D.: 12 7/8 (327.0) One End Height: 13 27/32 (351.6) A. Gskt: [1] Attached</p> 	<p>PA3909 Inner Air Element Fits Inside: PA3908 Fits: Kubota Tractors Replaces: Kubota 17301-11180 O.D.: 3 7/8 (98.4) I.D.: 5/8 (15.9) & 3 3/16 (81.0) Height: 7 1/32 (178.6) A. Gskt: [1] Attached F. Gskt: [1] Included</p> 
<p>PA3905 Inner Air Element with 8 Bolt Holes Fits Inside: PA3904 Fits: Caterpillar Generators, Industrial, Marine Engines Replaces: Caterpillar 4P0711 Flange 15 5/8 (396.9) I.D.: 10 9/32 (261.1) One End Height: 14 1/4 (362.0) A. Gskt: [1] Attached</p> 	<p>PA3910-FN Outer Air Element with Fins and Lid Fits: J.C. Bamford Equipment Use With: PA3911 Replaces: J.C. Bamford 32/911801 O.D.: 7 13/16 (198.4) Lid 8 3/8 (212.7) I.D.: 19/32 (15.1) & 3 15/32 (88.1) Height: 9 5/16 (236.5) A. Gskt: [1] Attached F. Gskt: [1] Included, [1] Wing Nut</p> 
	<p>PA3911 Inner Air Element Fits Inside: PA3910-FN Fits: J.C. Bamford Equipment Replaces: J.C. Bamford 32/911802 O.D.: 3 3/8 (85.7) Flange 4 5/32 (105.6) I.D.: 21/32 (16.7) & 2 29/32 (73.8) Height: 7 21/32 (194.5) A. Gskt: [1] Attached F. Gskt: [1] Metal Washer</p> 













Measurements Are Shown In Inches And (Millimeters)

WARNING: These products can expose you to chemicals, including Diisononyl Phthalate, Carbon black extracts, Nickel, 1,3 Butadiene, Ethylene Oxide, Epichlorohydrin, which are known to the State of California to cause cancer, and Bisphenol, Ethylene Glycol, Ethylene Oxide, 1,3 Butadiene, Epichlorohydrin, which are known to the State of California to cause birth defects or other reproductive harm. For more information go to www.P65Warnings.ca.gov.

<p>PA3914 Outer Air Element Fits: Hino Equipment Use With: PA3915 Replaces: Hino 17801-2910, 17801-2910M O.D.: 10 27/32 (275.4) I.D.: 15/16 (23.8) & 6 1/2 (165.1) Height: 14 1/2 (368.3) A. Gskt: [1] Attached F. Gskt: [1] Included</p> 	<p>RS3920 Radial Seal Outer Air Element Fits: J.C. Bamford, Massey Ferguson, Volvo Equipment Use With: RS3921 Replaces: J.C. Bamford 32/915802 O.D.: 5 31/32 (151.6) I.D.: 3 3/8 (85.7) One End Height: 14 1/8 (358.8)</p> 
<p>PA3915 Inner Air Element Fits Inside: PA3914 Fits: Hino Equipment Replaces: Hino 17801-2900, 17801-2900M O.D.: 6 3/8 (161.9) I.D.: 5/8 (15.9) & 5 9/32 (134.1) Height: 12 3/8 (314.3) A. Gskt: [1] Attached F. Gskt: G103-N</p> 	<p>RS3921 Radial Seal Inner Air Element Fits Inside: RS3920 Fits: J.C. Bamford, Massey Ferguson Equipment Replaces: J.C. Bamford 32/915801 O.D.: 3 3/32 (78.6) I.D.: 2 15/16 (74.6) One End Height: 13 19/32 (345.3)</p> 
<p>PA3916 Air Element Fits: MCI, Universal Coach Buses Replaces: MCI 9031073; Universal Coach T12-1111 O.D.: 12 3/32 (307.2) I.D.: 7/8 (22.2) & 7 11/16 (195.3) Height: 19 1/2 (495.3) A. Gskt: [1] Attached F. Gskt: [1] Included</p> 	<p>RS3922 Radial Seal Outer Air Element Fits: Deutz, Deutz-Fahr, Fendt, Gehl, Massey Ferguson Tractors; J.C. Bamford Excavators, Loaders; Terex Lift Trucks Use With: RS3923 Replaces: J.C. Bamford 32/917804 O.D.: 6 3/8 (161.9) I.D.: 3 3/4 (95.3) One End Height: 14 3/4 (374.7)</p> 
<p>PA3917 Cab Air Element Fits: Caterpillar Equipment Replaces: Caterpillar 1212761, 6T9504, 7G6599; Fleetguard AF27700 Length: 17 15/32 (443.7) Width: 8 1/2 (215.9) Height: 5/8 (15.9)</p> 	<p>RS3923 Radial Seal Inner Air Element Fits Inside: RS3922 Fits: Deutz, Deutz-Fahr, Fendt, Massey Ferguson Tractors; J.C. Bamford Excavators, Loaders; Terex Lift Trucks Replaces: J.C. Bamford 32/917805 O.D.: 3 17/32 (89.7) I.D.: 3 13/32 (86.5) One End Height: 14 7/32 (361.2)</p> 
<p>PA3918 Outer Air Element with Lift Bar Fits: John Deere Tractors Use With: PA3919 Replaces: John Deere AL78869 O.D.: 8 29/32 (226.2) Flange 11 7/32 (285.0) I.D.: 4 21/32 (118.3) One End Height: 12 7/32 (310.4) A. Gskt: [1] Attached</p> 	<p>PA3924-FN Outer Air Element with Fins and Lid Fits: John Deere, Zetor Tractors Use With: PA2689 Replaces: Zetor 79011284 O.D.: 7 13/16 (198.4) Lid 8 3/8 (212.7) I.D.: 19/32 (15.1) & 3 15/32 (88.1) Height: 11 1/2 (292.1) A. Gskt: [1] Attached F. Gskt: [1] Included, [1] Wing Nut</p> 
<p>PA3919 Inner Air Element with 3 Bolts Fits Inside: PA3918 Fits: John Deere Tractors Replaces: John Deere AL78870 O.D.: 6 11/32 (161.1) Flange 9 3/8 (238.1) I.D.: 4 21/32 (118.3) One End Height: 5 1/8 (130.2) A. Gskt: [1] Attached O-Ring: [3] Included</p> 	

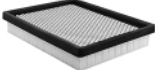
Measurements Are Shown In Inches And (Millimeters)

WARNING: These products can expose you to chemicals, including Diisononyl Phthalate, Carbon black extracts, Nickel, 1,3 Butadiene, Ethylene Oxide, Epichlorohydrin, which are known to the State of California to cause cancer, and Bisphenol, Ethylene Glycol, Ethylene Oxide, 1,3 Butadiene, Epichlorohydrin, which are known to the State of California to cause birth defects or other reproductive harm. For more information go to www.P65Warnings.ca.gov.

<p>PA3925</p> 	<p>Inner Air Element Fits Inside: RS4967 Fits: Volvo Trucks Replaces: Volvo 1665937, 1665937-7 O.D.: 7 31/32 (202.4) I.D.: 7 (177.8) One End Height: 17 19/32 (446.9)</p>	<p>PA3931</p>  <p>Foam Inside Cab Air Element Fits: John Deere Tractors Replaces: John Deere R120501 Length: 13 (330.2) Width: 7 (177.8) Height: 1/2 (12.7)</p>
<p>RS3926</p> 	<p>Radial Seal Outer Air Element Fits: Case-International Equipment Use With: RS3927 Replaces: Case 243968A1 O.D.: 12 31/32 (329.4) I.D.: 6 13/16 (173.0) One End Height: 22 9/32 (565.9)</p>	<p>PA3932</p>  <p>Outer Air Element Notes: Uses 2 filters per application. Fits: Caterpillar Generators, Industrial, Marine Engines Use With: PA3933 Replaces: Caterpillar 113-1578 O.D.: 19 9/32 (489.7) I.D.: 12 7/8 (327.0) One End Height: 18 5/16 (465.1) A. Gskt: [1] Attached</p>
<p>RS3927</p> 	<p>Radial Seal Inner Air Element Fits Inside: RS3926 Fits: Case-International Equipment Replaces: Case 243969A1 O.D.: 6 7/8 (174.6) I.D.: 5 5/32 (131.0) One End Height: 21 15/32 (545.3)</p>	<p>PA3933</p>  <p>Inner Air Element with 8 Bolt Holes Fits Inside: PA3932 Fits: Caterpillar Generators, Industrial, Marine Engines Replaces: Caterpillar 113-1579 O.D.: 12 25/32 (324.6) Flange: 15 5/8 (396.9) I.D.: 10 9/32 (261.1) One End Height: 17 3/4 (450.9) A. Gskt: [1] Attached</p>
<p>PA3928</p> 	<p>Set of 2 Cab Air Elements Notes: Uses 2 filters per application. Fits: John Deere Tractors Replaces: John Deere AL115625, AL111748 Each Filter: Length: 23 5/16 (592.1) Width: 5 3/16 (131.8) to 5 3/8 (136.5) Height: 3 11/32 (84.9) A. Gskt: [1] Included</p>	<p>RS3934</p>  <p>Radial Seal Outer Air Element Fits: Case-International Equipment Use With: RS3935 Replaces: Case 187471A1 O.D.: 8 5/32 (207.2) I.D.: 4 3/16 (106.4) One End Height: 15 5/8 (396.9)</p>
<p>PA3929</p> 	<p>Cab Air Element Fits: John Deere Tractors Replaces: John Deere RE48882 Length: 9 1/32 (229.4) Width: 7 3/16 (182.6) Height: 1 5/8 (41.3)</p>	<p>RS3935</p>  <p>Radial Seal Inner Air Element Fits Inside: RS3934, RS3971 Fits: Case-International Equipment Replaces: Case 187472A1 O.D.: 4 1/4 (108.0) I.D.: 2 3/4 (69.9) One End Height: 15 (381.0)</p>
<p>RS3930</p> 	<p>Radial Seal Inner Air Element Fits Inside: RS3715 Fits: Allmand, Bobcat, Exmark, John Deere Equipment Replaces: John Deere M123378; Walker 5090-3 O.D.: 1 11/16 (42.9) I.D.: 1 3/16 (30.2) One End Height: 6 5/8 (168.3)</p>	<p>RS3936</p>  <p>Radial Seal Air Element Fits: Mack Trucks Replaces: Mack 2MD4139M, 57MD46M O.D.: 9 9/32 (235.7) I.D.: 5 25/32 (146.8) One End Height: 25 17/32 (648.5)</p>

Measurements Are Shown In Inches And (Millimeters)

WARNING: These products can expose you to chemicals, including Diisononyl Phthalate, Carbon black extracts, Nickel, 1,3 Butadiene, Ethylene Oxide, Epichlorohydrin, which are known to the State of California to cause cancer, and Bisphenol, Ethylene Glycol, Ethylene Oxide, 1,3 Butadiene, Epichlorohydrin, which are known to the State of California to cause birth defects or other reproductive harm. For more information go to www.P65Warnings.ca.gov.

PA3937 Cab Air Element
Notes: Uses 2 filters per application.
Fits: Caterpillar Equipment
Replaces: Caterpillar 113-0305
Length: 16 7/16 (417.5)
Width: 5 9/16 (141.3)
Height: 2 9/16 (65.1)
A. Gskt: [1] Attached

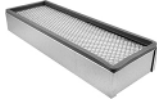

PA3938 Air Element
Fits: Mack Trucks
Replaces: Mack 57MD47
O.D.: 10 27/32 (275.4)
I.D.: 15/16 (23.8) & 6 1/2 (165.1)
Height: 20 15/32 (519.9)
A. Gskt: [1] Attached
F. Gskt: [1] Included



PA3939 Cab Air Element
Fits: Caterpillar Excavators
Replaces: Caterpillar 411278
Length: 23 5/8 (600.1)
Width: 4 7/8 (123.8)
Height: 1 1/16 (27.0)

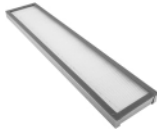

RS3940 Radial Seal Outer Air Element
Contains: Flame Retardant Media
Fits: Toyota Lift Trucks
Use With: RS4962
Replaces: Toyota 17741-23600-71,
 17743-23600-71
O.D.: 5 13/32 (137.3)
I.D.: 3 3/16 (81.0) One End
Height: 11 1/32 (280.2)



PA3941 Air Element
Fits: Hatz Diesel Engines; Bitelli Paving
 Equipment
Replaces: Hatz 1493000
O.D.: 6 1/2 (165.1)
I.D.: 3 15/32 (88.1)
Height: 3 21/32 (92.9)



RS3942 Radial Seal Outer Air Element
Fits: Ahlmann, Massey Ferguson Tractors;
 Atlas Copco Compressors; Bomag Compactors;
 Melroe-Bobcat Lift Trucks
Use With: RS3943
Replaces: Mann & Hummel C14200
O.D.: 4 31/32 (126.2)
I.D.: 2 31/32 (75.4) One End
Height: 12 17/32 (318.3)



RS3943 Radial Seal Inner Air Element
Fits Inside: RS3942
Fits: Ahlmann, Massey Ferguson Tractors;
 Atlas Copco Compressors; Bomag Compactors;
 Melroe-Bobcat Lift Trucks
Replaces: Deutz 1180869; Massey Ferguson
 3901463-M1
O.D.: 2 3/4 (69.9)
I.D.: 2 11/16 (68.3) One End
Height: 12 1/16 (306.4)



PA3944 Panel Air Element
Replaces: Dart 625081, 842408; Euclid 1004320
Length: 20 (508.0)
Width: 15 (381.0)
Height: 2 3/16 (55.6)



PA3945 Cab Air Element
Fits: Hitachi Equipment
Replaces: Hitachi 4206637
Length: 17 1/8 (435.0)
Width: 8 7/16 (214.3)
Height: 2 11/16 (68.3)
A. Gskt: [1] Attached

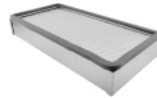

PA3946 Air Element
Fits: Volvo Trucks
Replaces: Volvo 6778729
O.D.: 7 15/16 (201.6)
I.D.: 7/16 (11.1) & 4 5/8 (117.5)
Height: 22 19/32 (573.9)
A. Gskt: [1] Attached
F. Gskt: [1] Included



PA3948 Outer Air Element with Lift Bar
Fits: New Holland Tractors
Use With: PA3949
Replaces: New Holland 82001819, 82008606
O.D.: 8 1/2 (215.9)
 Boot Gasket 10 (254.0)
I.D.: 19/32 (15.1) & 4 27/32 (123.0)
Height: 15 9/16 (395.3)
A. Gskt: [2] Attached
F. Gskt: [1] Included















PA3949 Inner Air Element with Lift Tabs
Notes: Oil Wetted Media
Fits Inside: PA3948
Fits: New Holland Tractors
Replaces: New Holland 82001820, 82008607
O.D.: 4 23/32 (119.9)
 Flange 5 29/32 (150.0)
I.D.: 13/32 (10.3) & 3 31/32 (100.8)
Height: 15 3/8 (390.5)
A. Gskt: [2] Attached

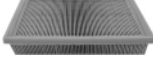

Measurements Are Shown In Inches And (Millimeters)

WARNING: These products can expose you to chemicals, including Diisononyl Phthalate, Carbon black extracts, Nickel, 1,3 Butadiene, Ethylene Oxide, Epichlorohydrin, which are known to the State of California to cause cancer, and Bisphenol, Ethylene Glycol, Ethylene Oxide, 1,3 Butadiene, Epichlorohydrin, which are known to the State of California to cause birth defects or other reproductive harm. For more information go to www.P65Warnings.ca.gov.

<p>PA3950</p> 	<p>Inner Air Element Fits Inside: PA3790 Fits: Massey Ferguson Tractors Replaces: Massey Ferguson 3515587-M1, 3595501-M1 O.D.: 3 3/8 (85.7) Flange 3 25/32 (96.0) I.D.: 2 1/32 (16.7) & 2 7/8 (73.0) Height: 9 1/32 (229.4) A. Gskt: [1] Attached F. Gskt: [1] Washer</p>	<p>PA3957</p>  <p>Oval Air Element with Foam Wrap Fits: American Sportsworks Utility Vehicles; Genie Lifts; Honda Engines; Toro Loaders Use With: PA3957 FOAM Replaces: Honda 17210-ZE3-010, 17210-ZE3-505 O.D.: 3 25/32 (96.0) to 4 13/32 (111.9) I.D.: 1/4 (6.4) & 1 5/8 (41.3) Height: 3 5/8 (92.1) A. Gskt: [1] Metal Washer Grommets: [1] Attached</p>
<p>PA3951</p> 	<p>Conical-Shaped Air Element Notes: Inside-Out Flow Direction Fits: Ford, GMC, Mack Trucks Replaces: Ford D8HZ-9601-B; GMC 8997222; International 526059-C91 O.D.: 7 13/32 (188.1) to 10 13/32 (264.3) I.D.: 6 15/16 (176.2) One End Height: 29 (736.6) A. Gskt: [2] Attached F. Gskt: G298-AF</p>	<p>PA3957 FOAM</p>  <p>Foam Blanket for PA3957 Use With: PA3957 O.D.: 3 27/32 (97.6) I.D.: 3 3/8 (85.7) Length: 3 3/16 (81.0) Height: 2 27/32 (72.2)</p>
<p>RS3952</p> 	<p>Radial Seal Air Element Fits: DAF Trucks Replaces: DAF 1353115 O.D.: 10 31/32 (278.6) I.D.: 5 13/16 (147.6) One End Height: 19 29/32 (505.6)</p>	<p>PA3958</p>  <p>Foam Wrap Fits: Detroit Diesel Marine Engines Replaces: GMC 6422214, 25177939 O.D.: 8 19/32 (218.3) I.D.: 7 19/32 (192.9) Height: 7 (177.8)</p>
<p>PA3953</p> 	<p>Panel Air Element Fits: Genie Industrial Lifts Replaces: Lombardini 2175.164, 107.2175.160 Length: 8 7/8 (225.4) Width: 5 5/16 (134.9) Height: 1 5/8 (41.3)</p>	<p>PA3959</p>  <p>Air Element Fits: Kubota Equipment Replaces: Kubota 11420-11180 O.D.: 4 23/32 (119.9) I.D.: 1 31/32 (50.0) Height: 1 31/32 (50.0) A. Gskt: [2] Attached</p>
<p>RS3954</p> 	<p>Radial Seal Outer Air Element Fits: New Holland, Terex, Volvo Equipment Use With: RS3547 Replaces: Perkins 26510362 O.D.: 4 1/8 (104.8) I.D.: 2 5/16 (58.7) One End Height: 11 27/32 (300.8)</p>	<p>BA3964(4)</p>  <p>Set of 4 Nylon Screen Supported Bag Air Elements Notes: Oil Wetted Media Fits: Railroad Applications Replaces: Clark EG2; EMD 9522063 Length: 22 (558.8) Width: 18 3/4 (476.3) Height: 5 (127.0)</p>
<p>PA3956</p> 	<p>Air Element with Foam Wrap Fits: Kohler Generators Replaces: Cummins 3903876, 3903879; Kohler 253108 O.D.: 8 1/32 (204.0) I.D.: 5 5/16 (134.9) Height: 10 15/16 (277.8)</p>	<p>BA3965(4)</p>  <p>Set of 4 Nylon Screen Supported Bag Air Elements Notes: Oil Wetted Media Fits: Railroad Applications Replaces: Clark EG1; EMD 8470903; General Electric 41A218313P1 Length: 29 3/8 (746.1) Width: 27 3/8 (695.3) Height: 6 3/8 (161.9)</p>

Measurements Are Shown In Inches And (Millimeters)

WARNING: These products can expose you to chemicals, including Diisononyl Phthalate, Carbon black extracts, Nickel, 1,3 Butadiene, Ethylene Oxide, Epichlorohydrin, which are known to the State of California to cause cancer, and Bisphenol, Ethylene Glycol, Ethylene Oxide, 1,3 Butadiene, Epichlorohydrin, which are known to the State of California to cause birth defects or other reproductive harm. For more information go to www.P65Warnings.ca.gov.

PA3966



Air Element

Fits: EMD, GE Locomotives
Replaces: EMD 8402068; Farr 116367-001;
 General Electric 41A216205P1
O.D.: 8 (203.2)
I.D.: 6 1/8 (155.6)
Height: 12 5/32 (308.8)

PA3973



Inner Air Element

Fits Inside: PA3972
Fits: Kubota Tractors
Replaces: Kubota 15724-11180
O.D.: 3 7/8 (98.4)
I.D.: 5/8 (15.9) & 3 7/32 (81.8)
Height: 8 13/16 (223.8)
A. Gskt: [1] Attached
F. Gskt: [1] Metal Washer

PA3967



Air Element

Fits: John Deere Lawn & Garden Equipment
Replaces: John Deere AM101812; Onan
 140-1911, 140-2523
O.D.: 8 1/4 (209.6)
I.D.: 6 13/32 (162.7)
Height: 3 13/16 (96.8)

RS3974



Radial Seal Outer Air Element

Fits: John Deere, New Holland Loaders
Use With: RS3975
Replaces: John Deere AT178583
O.D.: 9 9/32 (235.7)
I.D.: 5 5/32 (131.0) One End
Height: 21 7/8 (555.6)

PA3969



Air Element

Replaces: Mitsubishi 91261-08200
O.D.: 5 5/16 (134.9)
I.D.: 7/16 (11.1) & 3 1/16 (77.8)
Height: 10 3/8 (263.5)
A. Gskt: [1] Attached

RS3975



Radial Seal Inner Air Element

Fits Inside: RS3974
Fits: John Deere, New Holland Loaders
Replaces: John Deere AT178584
O.D.: 5 1/4 (133.4)
I.D.: 3 5/8 (92.1) One End
Height: 21 7/32 (539.0)

PA3970



Air Element

Fits: Hatz Engines
Replaces: Hatz 40084500
O.D.: 6 1/2 (165.1)
I.D.: 3 1/2 (88.9)
Height: 3 21/32 (92.9)

PA3978



Air Element

Fits: Sullair Compressors
Replaces: Sullair 405158, 405158S
O.D.: 12 3/32 (307.2)
I.D.: 13/32 (10.3) & 6 3/32 (154.8)
Height: 15 15/32 (392.9)
A. Gskt: [1] Attached
F. Gskt: [1] Metal Washer

RS3971



Radial Seal Outer Air Element

Fits: Gradall, Volvo Equipment
Use With: RS3935, RS5304
Replaces: Gradall 91343059
O.D.: 7 11/32 (186.5)
I.D.: 4 5/32 (105.6) One End
Height: 15 21/32 (397.7)

PA3979



Air Element with Lid

Fits: Kubota Equipment
Replaces: Kubota 17351-11080, 17351-11083
O.D.: 5 1/4 (133.4)
 Lid 7 (177.8)
I.D.: 9/16 (14.3) & 2 27/32 (72.2)
Height: 11 1/2 (292.1)
A. Gskt: [2] Attached

PA3972



Outer Air Element

Fits: Kubota Tractors
Use With: PA3973
Replaces: Kubota 15724-11080
O.D.: 6 3/32 (154.8)
I.D.: 2 1/32 (16.7) & 4 3/32 (104.0)
Height: 9 5/8 (244.5)
A. Gskt: [1] Attached
F. Gskt: [1] Washer

PA3980



Cab Air Element

Fits: M.A.N. Buses, Trucks
Replaces: M.A.N. 81.69100.011
Length: 15 23/32 (399.3)
Width: 7 3/32 (180.2)
Height: 1 9/16 (39.7)

Measurements Are Shown In Inches And (Millimeters)

WARNING: These products can expose you to chemicals, including Diisononyl Phthalate, Carbon black extracts, Nickel, 1,3 Butadiene, Ethylene Oxide, Epichlorohydrin, which are known to the State of California to cause cancer, and Bisphenol, Ethylene Glycol, Ethylene Oxide, 1,3 Butadiene, Epichlorohydrin, which are known to the State of California to cause birth defects or other reproductive harm. For more information go to www.P65Warnings.ca.gov.

PA3983-FN Air Element with Fins
Fits: Kubota Engines
Replaces: Kubota 14971-11180
O.D.: 3 3/8 (85.7)
 Fins 4 5/32 (105.6)
I.D.: 1 7/32 (31.0) & 1 1/4 (31.8)
Height: 4 1/32 (102.4)



PA3989-FN Air Element with Fins
Contains: Flame Retardant Media
Fits: Caterpillar, Mitsubishi Lift Trucks
Replaces: Mitsubishi 91861-01600
O.D.: 6 3/32 (154.8)
 Fins 7 13/16 (198.4)
I.D.: 3/4 (19.0) & 3 15/32 (88.1)
Height: 12 1/8 (308.0)
A. Gskt: [1] Attached
F. Gskt: [1] Washer



PA3984 Air Element with Lid
Fits: Lister Engines
Replaces: Lister 38207903
O.D.: 5 (127.0)
 Lid 7 1/8 (181.0)
I.D.: 11/16 (17.5) & 2 27/32 (72.2)
Height: 13 29/32 (353.2)
A. Gskt: [1] Attached
F. Gskt: [1] Included, [1] Wing Nut



RS3990 Radial Seal Outer Air Element
Fits: Kubota Engines
Use With: RS3991
Replaces: Atlas Copco 29149300-00; KHD 1319141; Worthington 6211455100
O.D.: 4 9/16 (115.9)
I.D.: 2 5/8 (66.7) One End
Height: 9 7/8 (250.8)



PA3985 Inner Air Element
Fits Inside: PA3670
Fits: Komatsu Excavators
Replaces: Komatsu 600-181-9480
O.D.: 3 3/8 (85.7)
 Flange 4 3/16 (106.4)
I.D.: 11/16 (17.5) & 2 19/32 (65.9)
Height: 11 (279.4)
A. Gskt: [1] Attached
F. Gskt: [1] Included



RS3991 Radial Seal Inner Air Element
Fits Inside: RS3990
Fits: Kubota Engines
Replaces: KHD 1180868
O.D.: 2 7/32 (56.4)
 to 2 1/4 (57.2)
I.D.: 1 5/8 (41.3) One End
Height: 9 13/32 (238.9)



PA3986 Cab Air Element
Fits: Volvo Trucks
Replaces: Volvo 8089705
Length: 11 13/32 (289.7)
Width: 4 23/32 (119.9)
Height: 1 23/32 (43.7)



RS3992 Radial Seal Outer Air Element
Fits: Deutz, Massey Ferguson, Liebherr, Volvo Equipment
Use With: RS3993
Replaces: Atlas Copco 2914930800; Demag 11323374
O.D.: 7 11/16 (195.3)
I.D.: 4 17/32 (115.1) One End
Height: 15 23/32 (399.3)



PA3987 Replacement for Ecolite Air Element in Disposable Housing
Contains: Bleeder Valve
Fits: Blue Bird, Thomas Buses
Replaces: Farr 119861-003
O.D.: 11 (279.4)
Inlet: 7
Outlet: 6
Height: 19 11/16 (500.1)



RS3993 Radial Seal Inner Air Element
Fits Inside: RS3992
Fits: Deutz, Massey Ferguson, Liebherr, Volvo Equipment
Replaces: Atlas Copco 16158928, 29149309; Bomag 5821148; Deutz 1180872, 4415903; Liebherr 7026329; Massey Ferguson 3901478-M1
O.D.: 4 11/32 (110.3)
I.D.: 3 9/16 (90.5) One End
Height: 15 5/32 (385.0)



RS3988 Radial Seal Outer Air Element
Fits: Case, Caterpillar, Hitachi, Kubota, Mustang Equipment
Use With: RS3703
Replaces: Case 133720A1; Caterpillar 134-8726; Hitachi 4290940; John Deere AM129028
O.D.: 5 1/32 (127.8)
I.D.: 3 5/32 (80.2) One End
Height: 12 5/16 (312.7)
Related To: RS3549 (with Flame Retardant Media)



RS3994 Radial Seal Outer Air Element
Fits: Atlas Copco Compressors; Caterpillar, Massey Ferguson Equipment
Use With: RS3995
Replaces: Atlas Copco 16138004, 29149310; Bomag 5821149; Claas 7521980; Deutz 1181003; Massey Ferguson 3902783-M1
O.D.: 8 11/16 (220.7)
I.D.: 4 15/16 (125.4) One End
Height: 15 27/32 (402.4)



Measurements Are Shown In Inches And (Millimeters)

WARNING: These products can expose you to chemicals, including Diisononyl Phthalate, Carbon black extracts, Nickel, 1,3 Butadiene, Ethylene Oxide, Epichlorohydrin, which are known to the State of California to cause cancer, and Bisphenol, Ethylene Glycol, Ethylene Oxide, 1,3 Butadiene, Epichlorohydrin, which are known to the State of California to cause birth defects or other reproductive harm. For more information go to www.P65Warnings.ca.gov.

RS3995 Radial Seal Inner Air Element
Contains: [1] Grease packet
Fits Inside: RS3994
Fits: Atlas Copco Compressors; Caterpillar, Massey Ferguson Equipment
Replaces: Bomag 5821150; Claas 751199.0, 752199.0; Deutz 1181004; Massey Ferguson 392782-M1
O.D.: 4 23/32 (119.9)
I.D.: 4 (101.6) One End
Height: 15 1/4 (387.3)



RS3999 Radial Seal Inner Air Element
Fits Inside: RS3998, RS3998XP
Fits: Caterpillar Loaders, Motor Graders; Demag, Grove, Liebherr Cranes
Replaces: Atlas Copco 2914-5018-00
O.D.: 7 29/32 (200.8)
I.D.: 7 9/16 (192.1) One End
Height: 22 5/8 (574.7)



RS3996 Radial Seal Outer Air Element
Fits: Atlas Copco Compressors; Demag, Grove, Liebherr Cranes
Use With: RS3997
Replaces: Atlas Copco 2914-5023-00; Massey Ferguson 3902806-M1
O.D.: 9 1/2 (241.3)
I.D.: 5 3/4 (146.0) One End
Height: 21 5/32 (537.4)



PA4005 Air Element
Fits: Ford Vans
Replaces: Ford E1VZ-9601-A, F1UZ-9601-A
O.D.: 12 (304.8)
I.D.: 8 19/32 (218.3)
Height: 4 13/32 (111.9)



RS3997 Radial Seal Inner Air Element with Bail Handle
Fits Inside: RS3996
Fits: Atlas Copco Compressors; Demag, Grove, Liebherr Cranes
Replaces: Atlas Copco 2914-5024-00; Massey Ferguson 3902812-M1
O.D.: 5 17/32 (140.5)
I.D.: 4 25/32 (121.4) One End
Height: 20 9/16 (522.3)



PA4015 Panel Air Element
Fits: Chrysler, Eagle, Mazda, Mitsubishi Automotive
Replaces: Mazda KL47-13-Z40; Mitsubishi MB906051
Length: 9 1/32 (229.4)
Width: 7 9/32 (184.9)
Height: 2 1/16 (52.4)



RS3998 Radial Seal Outer Air Element
Fits: Caterpillar Equipment; Demag, Grove, Liebherr Cranes
Use With: RS3999
Replaces: Atlas Copco 2914-5017-00; CompAir 11516/974; Ingersoll-Rand 89288971
O.D.: 11 23/32 (297.7)
I.D.: 8 1/32 (204.0) One End
Height: 23 5/16 (592.1)
Related To: RS3998XP (Extreme Performance Nano Version)



PA4016 Panel Air Element
Fits: Chrysler, Mitsubishi Automotive
Replaces: Mitsubishi MD620472
Length: 8 7/8 (225.4)
Width: 8 7/8 (225.4)
Height: 1 13/32 (35.7)



RS3998XP Extreme Performance Nano Radial Seal Outer Air Element
Fits: Caterpillar Equipment; Demag, Grove, Liebherr Cranes
Use With: RS3999
Replaces: Atlas Copco 2914-5017-00; CompAir 11516/974; Ingersoll-Rand 89288971
O.D.: 11 23/32 (297.7)
I.D.: 8 1/32 (204.0) One End
Height: 23 5/16 (592.1)
Related To: RS3998 (Standard Media Version)



PA4018 Panel Air Element
Fits: Infiniti FX50, FX35; Nissan 300ZX, Lucino, Rogue, Sentra
Replaces: General Motors 25147124; Nissan 1654630P00, 1654673C10
Length: 9 1/32 (229.4)
Width: 6 5/8 (168.3)
Height: 1 7/32 (31.0)



PA4023 Panel Air Element
Fits: Chevrolet, Geo Tracker; Suzuki Sidekick
Replaces: GMC 96057994; Suzuki 13780-61A00
Length: 10 1/8 (257.2)
Width: 8 9/32 (210.3)
Height: 1 11/16 (42.9)

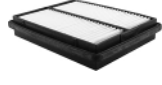

PA4026 Air Element
Fits: Chevrolet Metro, Sprint; Pontiac Firefly; Suzuki Swift
Replaces: GMC 25099251; Suzuki 13780-82400; WIX 546182, 46182
O.D.: 6 25/32 (172.2)
Height: 2 23/32 (69.1)



PA4028 Panel Air Element
Fits: Lexus, Toyota Automotive
Replaces: Toyota 17801-74060
Length: 12 3/16 (309.6)
Width: 7 3/8 (187.3)
Height: 1 11/16 (42.9)



Measurements Are Shown In Inches And (Millimeters)

WARNING: These products can expose you to chemicals, including Diisononyl Phthalate, Carbon black extracts, Nickel, 1,3 Butadiene, Ethylene Oxide, Epichlorohydrin, which are known to the State of California to cause cancer, and Bisphenol, Ethylene Glycol, Ethylene Oxide, 1,3 Butadiene, Epichlorohydrin, which are known to the State of California to cause birth defects or other reproductive harm. For more information go to www.P65Warnings.ca.gov.

<p>PA4041</p> 	<p>Air Element Fits: Daihatsu Automotive Replaces: Daihatsu 17801-87601-000 O.D.: 6 1/8 (155.6) I.D.: 15/32 (11.9) & 3 3/8 (85.7) Height: 6 7/32 (158.0) A. Gskt: [1] Attached</p>	<p>PA4049</p> 	<p>Panel Air Element Fits: Saturn Automotive Replaces: Saturn 21000938 Length: 9 27/32 (250.0) Width: 5 15/32 (138.9) Height: 2 1/16 (52.4) A. Gskt: [1] Attached</p>
<p>PA4042</p> 	<p>Panel Air Element Fits: Porsche Automotive Replaces: Porsche 91111018502 Length: 15 13/16 (401.6) Width: 7 3/32 (180.2) Height: 1 5/8 (41.3)</p>	<p>PA4050</p> 	<p>Panel Air Element Fits: Honda Automotive Replaces: Honda 17220-P07-000 Length: 8 7/32 (208.8) Width: 7 1/4 (184.2) Height: 1 21/32 (42.1) A. Gskt: [1] Attached</p>
<p>PA4043</p> 	<p>Panel Air Element Fits: Hyundai Automotive Replaces: Hyundai 28113-22051 Length: 9 21/32 (245.3) Width: 6 5/16 (160.3) Height: 1 15/32 (37.3)</p>	<p>PA4060</p> 	<p>Panel Air Element Fits: Lexus, Toyota Automotive Replaces: Toyota 17801-46060 Length: 9 21/32 (245.3) Width: 8 1/8 (206.4) Height: 2 1/16 (52.4)</p>
<p>PA4044</p> 	<p>Panel Air Element Fits: Ford Automotive Replaces: Ford F6DX-9601-BA, F6DZ-9601-B Length: 9 15/16 (252.4) Width: 7 1/32 (178.6) Height: 1 9/16 (39.7)</p>	<p>PA4061</p> 	<p>Air Element Fits: Lexus Automotive Replaces: Toyota 17801-50010; Wix 46058 O.D.: 10 1/32 (254.8) Height: 2 5/8 (66.7)</p>
<p>PA4045</p> 	<p>Panel Air Element Fits: Ford Automotive Replaces: Ford F4BZ-9601-A Length: 8 7/32 (208.8) Width: 5 7/8 (149.2) Height: 1 15/32 (37.3)</p>	<p>PA4069</p> 	<p>Panel Air Element Fits: Ford Automotive Replaces: Ford F23E-9601-BB, F23Z-9601-B Length: 10 1/16 (255.6) Width: 7 5/32 (181.8) Height: 1 9/16 (39.7)</p>
<p>PA4046</p> 	<p>Panel Air Element Fits: Jeep Grand Cherokee; Nissan Automotive Replaces: Chrysler 53007386 Length: 11 3/8 (288.9) Width: 9 3/4 (247.7) Height: 1 15/32 (37.3)</p>	<p>PA4070</p> 	<p>Air Element Fits: Nissan Light-Duty Trucks Replaces: Nissan 16546-89G00; GMC 25147122 O.D.: 13 1/16 (331.8) Height: 2 3/8 (60.3) I.Gskt: [2] Included</p>
<p>PA4047</p> 	<p>Panel Air Element Fits: BMW Automotive Replaces: BMW (Bavarian Motor Works) 13721707050, 13721715881; Wix 46221 Length: 10 3/16 (258.8) Width: 5 7/8 (149.2) Height: 2 7/32 (56.4)</p>	<p>PA4071</p> 	<p>Air Element Fits: Ford Automotive Replaces: Ford F4ZZ-9601-A O.D.: 4 5/8 (117.5) Flange 6 13/32 (162.7) I.D.: 3 3/16 (81.0) One End Height: 7 15/32 (189.7)</p>
<p>PA4048</p> 	<p>Panel Air Element Fits: BMW Automotive Replaces: BMW 13721730946 Length: 9 21/32 (245.3) Width: 7 (177.8) Height: 2 5/16 (58.7)</p>	<p>PA4072</p> 	<p>Air Element Replaces: Ingersoll-Rand 39449293 O.D.: 7 7/8 (200.0) I.D.: 4 1/8 (104.8) Height: 4 27/32 (123.0)</p>

Measurements Are Shown In Inches And (Millimeters)

WARNING: These products can expose you to chemicals, including Diisononyl Phthalate, Carbon black extracts, Nickel, 1,3 Butadiene, Ethylene Oxide, Epichlorohydrin, which are known to the State of California to cause cancer, and Bisphenol, Ethylene Glycol, Ethylene Oxide, 1,3 Butadiene, Epichlorohydrin, which are known to the State of California to cause birth defects or other reproductive harm. For more information go to www.P65Warnings.ca.gov.

PA4073 Air Element with Foam Pad
Fits: Ford Trucks
Replaces: Ford F3TZ-9601-Z
Length: 10 13/32 (264.3)
Width: 8 3/8 (212.7)
Height: 1 25/32 (45.2)



PA4075 Air Element
Fits: Ford Automotive, Light-Duty Trucks
Replaces: Ford F50Y-9601-A
O.D.: 7 (177.8)
 Flange 8 1/8 (206.4)
I.D.: 4 7/32 (107.2) One End
Height: 7 9/16 (192.1)



PA4077 Panel Air Element
Fits: Acura, Honda, Isuzu Automotive
Replaces: Honda 17220-P0A-A00; Isuzu 5-86202-255-0
Length: 12 1/16 (306.4)
Width: 7 9/32 (184.9)
Height: 2 1/8 (54.0)
A. Gskt: [1] Attached



PA4078 Panel Air Element
Fits: Chevrolet, Geo, Suzuki Automotive
Replaces: GMC 25175325; Suzuki 13780-58B00
Length: 11 5/8 (295.3)
Width: 5 9/32 (134.1)
Height: 2 3/32 (53.2)



PA4079 Panel Air Element
Fits: Buick Skylark; Chevrolet Berette, Corsica
Replaces: GMC 25099735
Length: 10 3/4 (273.1)
Width: 6 1/2 (165.1)
Height: 1 21/32 (42.1)

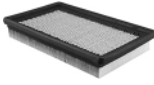

PA4081 Panel Air Element
Fits: Honda, Isuzu, Toyota Automotive
Replaces: Isuzu 8-97035-303-0, 8-97111-423-0; Toyota 17801-0W010
Length: 12 1/8 (308.0)
Width: 7 27/32 (199.2)
Height: 1 11/16 (42.9)



PA4084 Panel Air Element
Fits: Mazda Automotive
Replaces: Mazda B595-13-Z40
Length: 9 11/16 (246.1)
Width: 6 5/16 (160.3)
Height: 1 15/32 (37.3)



PA4085 Panel Air Element
Fits: Chrysler Automotive
Replaces: Chrysler 4573624, 4874153
Length: 8 7/8 (225.4)
Width: 7 13/32 (188.1)
Height: 1 1/2 (38.1)

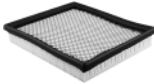

PA4088 Air Element
Fits: Ford Automotive
Replaces: Ford F7CZ-9601-A
O.D.: 5 27/32 (148.4)
 Flange 6 13/16 (173.0)
I.D.: 3 3/32 (78.6) One End
Height: 7 15/32 (189.7)



PA4089 Air Element
Fits: Ford Automotive
Replaces: Ford F67Z-9601-AA
O.D.: 5 5/32 (131.0)
 Flange 6 23/32 (170.7)
I.D.: 3 1/32 (77.0) One End
Height: 5 29/32 (150.0)



PA4090 Panel Air Element
Fits: Acura CL; Honda Accord
Replaces: Honda 17220-P0G-A00; WIX 546395, 46395
Length: 12 3/8 (314.3)
Width: 6 3/16 (157.2)
Height: 2 23/32 (69.1)



PA4091 Panel Air Element
Fits: Audi, BMW, Volkswagen Automotive
Replaces: Audi 58133843; BMW 13711736675, 13721702158, 13721736675
Length: 10 1/8 (257.2)
Width: 8 7/16 (214.3)
Height: 2 3/16 (55.6)

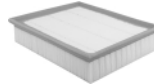

PA4092 Panel Air Element with Foam Pad
Fits: Jeep Wrangler
Replaces: Chrysler 4797777
Length: 13 1/2 (342.9)
Width: 6 1/4 (158.8)
Height: 1 5/16 (33.3)

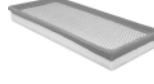

PA4093 Oval Air Element
Fits: Hatz Engines
Replaces: Hatz 952900
O.D.: 6 17/32 (165.9) to 9 3/4 (247.7)
I.D.: 2 9/32 (57.9) & 5 1/2 (139.7)
Height: 3 5/8 (92.1)



PA4099 Panel Air Element
Fits: Honda Automotive
Replaces: Honda 17220-P2N-A01
Length: 7 19/32 (192.9)
Width: 7 7/8 (200.0)
Height: 1 7/8 (47.6)

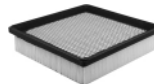



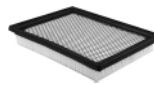







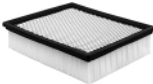
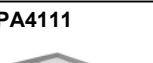

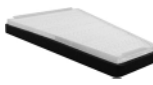
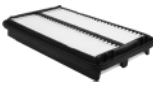
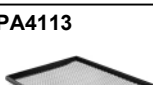
PA4100 Panel Air Element
Fits: Honda Automotive
Replaces: Honda 17220-P2F-A01
Length: 8 7/8 (225.4)
Width: 6 21/32 (169.1)
Height: 1 5/16 (33.3)

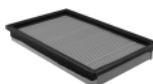

Measurements Are Shown In Inches And (Millimeters)

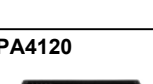
WARNING: These products can expose you to chemicals, including Diisononyl Phthalate, Carbon black extracts, Nickel, 1,3 Butadiene, Ethylene Oxide, Epichlorohydrin, which are known to the State of California to cause cancer, and Bisphenol, Ethylene Glycol, Ethylene Oxide, 1,3 Butadiene, Epichlorohydrin, which are known to the State of California to cause birth defects or other reproductive harm. For more information go to www.P65Warnings.ca.gov.

<p>PA4101</p> 	<p>Air Element Fits: Acura Automotive Replaces: Honda 17220-P72-000 O.D.: 5 5/32 (131.0) I.D.: 3 9/32 (83.3) One End Height: 12 5/16 (312.7) End Seals: [1] Attached Grommets: [1] Attached</p>	<p>PA4109</p> 	<p>Panel Air Element Fits: Chrysler Automotive Replaces: Chrysler 4591100AB, 4591100AC Length: 9 17/32 (242.1) Width: 7 3/32 (180.2) Height: 1 19/32 (40.5)</p>
<p>PA4102</p> 	<p>Panel Air Element Fits: Ford, Mazda Automotive, Light-Duty Trucks Replaces: Ford F77X-9601-AA, F77Z-9601-AA Length: 8 25/32 (223.0) Width: 7 9/16 (192.1) Height: 2 1/8 (54.0) A. Gskt: [1] Included</p>	<p>PA4110</p> 	<p>Panel Air Element with Foam Pad Fits: Ford Light-Duty Trucks Replaces: Ford F81A-9601-AA, F81Z-9601-AB Length: 13 1/4 (336.5) Width: 7 1/16 (179.4) Height: 2 19/32 (65.9)</p>
<p>PA4103</p> 	<p>Panel Air Element Fits: Mitsubishi Automotive Replaces: Mitsubishi MR188657 Length: 8 3/8 (212.7) Width: 8 1/16 (204.8) Height: 1 31/32 (50.0) A. Gskt: [1] Attached</p>	<p>PA4112</p> 	<p>Cabin Air Element Fits: Ford Automotive Replaces: Ford F6DZ-19N619-BA, F6DZ-19N619-C, F7DZ-19N619-A Length: 10 15/16 (277.8) Width: 3 1/4 (82.6) to 7 (177.8) Height: 1 1/8 (28.6) A. Gskt: [1] Attached</p>
<p>PA4104</p> 	<p>Panel Air Element Fits: Honda Automotive Replaces: Honda 17220-PAA-000, 17220-PAA-A00 Length: 10 25/32 (273.8) Width: 6 5/8 (168.3) Height: 1 21/32 (42.1) A. Gskt: [1] Attached</p>	<p>PA4113</p> 	<p>Panel Air Element Fits: Chevrolet, GMC Light-Duty Trucks Replaces: GMC 25313348 Length: 12 9/32 (311.9) Width: 9 23/32 (246.9) Height: 2 5/16 (58.7)</p>
<p>PA4105</p> 	<p>Panel Air Element Fits: Suzuki Automotive Replaces: Suzuki 13780-60G00 Length: 7 7/16 (188.9) Width: 6 1/16 (154.0) Height: 2 1/16 (52.4) A. Gskt: [1] Attached</p>	<p>PA4114</p> 	<p>Panel Air Element Fits: Mazda Automotive Replaces: Mazda FSD7-13-Z40 Length: 10 7/16 (265.1) Width: 6 19/32 (167.5) Height: 1 5/16 (33.3)</p>
<p>PA4106</p> 	<p>Panel Air Element Fits: Acura, Honda Automotive Replaces: Honda 17220-P8C-A00 Length: 12 5/8 (320.7) Width: 6 11/32 (161.1) Height: 2 15/16 (74.6) A. Gskt: [1] Attached</p>	<p>PA4118</p> 	<p>Air Element Fits: Dodge, Plymouth Automotive Replaces: Chrysler 4891097AA O.D.: 5 5/8 (142.9) I.D.: 2 13/32 (61.1) One End Height: 6 9/16 (166.7)</p>
<p>PA4107</p> 	<p>Panel Air Element Fits: GM Automotive Replaces: GMC 25161977 Length: 12 2/32 (306.4) Width: 7 5/8 (193.7) Height: 1 19/32 (40.5)</p>	<p>PA4120</p> 	<p>Panel Air Element Fits: Ford Light-Duty Trucks Replaces: Ford XC3Z-9601-AA Length: 13 3/8 (339.7) Width: 7 1/4 (184.2) Height: 2 5/16 (58.7)</p>
<p>PA4108</p> 	<p>Panel Air Element Fits: Chevrolet Tracker; Suzuki Automotive Replaces: GMC 25311970; Suzuki 13780-77E00 Length: 9 1/16 (230.2) Width: 7 7/8 (200.0) Height: 2 5/32 (54.8)</p>		

Measurements Are Shown In Inches And (Millimeters)

WARNING: These products can expose you to chemicals, including Diisononyl Phthalate, Carbon black extracts, Nickel, 1,3 Butadiene, Ethylene Oxide, Epichlorohydrin, which are known to the State of California to cause cancer, and Bisphenol, Ethylene Glycol, Ethylene Oxide, 1,3 Butadiene, Epichlorohydrin, which are known to the State of California to cause birth defects or other reproductive harm. For more information go to www.P65Warnings.ca.gov.

PA4121 Panel Air Element
Fits: Saturn Automotive
Replaces: Saturn 90571362
Length: 12 19/32 (319.9)
Width: 9 11/32 (237.3)
Height: 1 13/32 (35.7)



PA4123 Panel Air Element
Fits: Ford Automotive
Replaces: Ford YS4Z-9601-CC
Length: 10 7/16 (265.1)
Width: 5 3/4 (146.0)
Height: 1 7/8 (47.6)

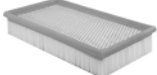

PA4124 Panel Air Element
Notes: OBSOLETE. Availability Limited to Dealer Stock.
Fits: Kia Automotive
Replaces: Kia K2A5-13-Z40A, OK2A5-13-Z40A
Length: 13 5/16 (338.1)
Width: 6 23/32 (170.7)
Height: 1 17/32 (38.9)



PA4126 Panel Air Element
Fits: Land Rover Discovery
Replaces: Land Rover ESR1445
Length: 10 1/4 (260.3)
Width: 8 (203.2)
Height: 2 1/4 (57.2)



PA4127 Panel Air Element
Fits: Lexus, Toyota Automotive, Light-Duty Trucks
Replaces: Toyota 17801-07010, 17801-50040
Length: 12 1/4 (311.2)
Width: 9 1/8 (231.8)
Height: 2 1/16 (52.4)



PA4128 Panel Air Element
Fits: Subaru Light-Duty Trucks
Replaces: Subaru 16546-AA070, 16546-AA07A
Length: 14 21/32 (372.3)
Width: 6 7/16 (163.5)
Height: 1 9/32 (32.5)
A. Gskt: [1] Attached



PA4129 Panel Air Element
Fits: Honda Automotive
Replaces: Honda 17220-P8F-A00
Length: 11 1/4 (285.8)
Width: 5 1/2 (139.7)
to 6 13/32 (162.7)
Height: 2 9/16 (65.1)



RS4130 Radial Seal Air Element
Fits: Chrysler Automotive
Replaces: Chrysler 5011836AA
O.D.: 5 1/32 (127.8)
I.D.: 3 5/32 (80.2) One End
Height: 6 1/4 (158.8)



RS4131 Radial Seal Air Element
Fits: Chevrolet, GMC Vans
Replaces: GMC 15153904
O.D.: 5 13/32 (137.3)
I.D.: 3 3/16 (81.0) One End
Height: 13 5/32 (334.2)



PA4132 Panel Air Element
Fits: Chrysler, Dodge Vans
Replaces: Chrysler 4861480AA
Length: 9 11/32 (237.3)
Width: 8 7/16 (214.3)
Height: 1 21/32 (42.1)

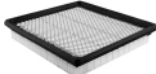

PA4133 Cabin Air Element
Fits: Ford, Lincoln Light-Duty Trucks
Replaces: Ford F65Z-19N619-AB
Length: 10 9/16 (268.3)
Width: 9 31/32 (253.2)
Height: 1 7/32 (31.0)



PA4134 Panel Air Element
Fits: Chevrolet, GMC Light-Duty Trucks, Suburbans with 6.6L Turbo Diesel Engine
Replaces: GMC 25332443; ACDelco A1618C
Length: 12 9/32 (311.9)
Width: 9 23/32 (246.9)
Height: 2 5/16 (58.7)

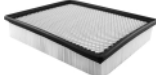

SA4137 Crankcase Breather Filter in Plastic Housing
Fits: Ford, Mercury Automotive, Light-Duty Trucks, Vans
Replaces: Ford E6TZ-6A768-A, F1BZ-6A768-A
O.D.: 3 1/4 (82.6)
I.D.: 1/2 (12.7) & 3/4 (19.0)
Height: 1 7/8 (47.6)



PA4138 Panel Air Element
Fits: Hyundai Automotive
Replaces: Hyundai 28113-23001
Length: 10 1/4 (260.3)
Width: 7 3/32 (180.2)
Height: 1 17/32 (38.9)



SA4141 Crankcase Breather Filter in Metal Housing
Fits: Chrysler, Dodge, Jeep, Plymouth Automotive, Light-Duty Trucks
Replaces: Chrysler 3462094, 4273322, 5214561, 53030254
O.D.: 3 1/32 (77.0)
Inlet: 1
Outlet: 5/8
Height: 2 5/8 (66.7)













SA4142 Polyester Crankcase Breather Filter
Fits: Chrysler, Dodge, Plymouth Automotive
Replaces: Chrysler 4459657, 5277665; Wix 46964
Length: 3 1/4 (82.6)
Width: 1 3/4 (44.4)
Height: 5/8 (15.9)

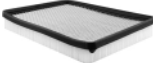

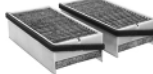
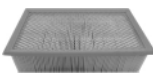
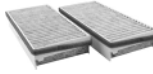



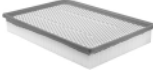

Measurements Are Shown In Inches And (Millimeters)

WARNING: These products can expose you to chemicals, including Diisononyl Phthalate, Carbon black extracts, Nickel, 1,3 Butadiene, Ethylene Oxide, Epichlorohydrin, which are known to the State of California to cause cancer, and Bisphenol, Ethylene Glycol, Ethylene Oxide, 1,3 Butadiene, Epichlorohydrin, which are known to the State of California to cause birth defects or other reproductive harm. For more information go to www.P65Warnings.ca.gov.

<p>PA4144</p> 	<p>Panel Air Element Replaces: Mazda WL81-13-Z40 Length: 9 29/32 (251.6) Width: 7 27/32 (199.2) Height: 2 1/16 (52.4) A. Gskt: [1] Attached</p>	<p>PA4152</p> 	<p>Cabin Air Element Fits: Ford, Mercury Vans Replaces: Ford XF2Z-19N619-AB Length: 11 3/8 (288.9) Width: 5 1/16 (128.6) Height: 15/16 (23.8) A. Gskt: [1] Attached</p>
<p>PA4145</p> 	<p>Air Element with Lift Tab Fits: Hummer Light-Duty Trucks Replaces: GMC 12342870 O.D.: 9 3/32 (231.0) I.D.: 15/32 (11.9) & 5 7/32 (132.6) Height: 13 9/32 (337.3) A. Gskt: [1] Attached F. Gskt: [1] Included</p>	<p>PA4153</p> 	<p>Cabin Air Element Fits: Ford, Mercury Automotive Replaces: Ford F5RZ-19N619-BA Length: 20 11/32 (516.7) Width: 4 1/8 (104.8) Height: 1 1/8 (28.6) A. Gskt: [1] Attached</p>
<p>PA4146</p> 	<p>Panel Air Element Fits: Buick, Chevrolet, Pontiac, Oldsmobile Automotive Replaces: GMC 24508572; ACDelco A1614C Length: 10 1/2 (266.7) Width: 7 7/8 (200.0) Height: 1 9/16 (39.7)</p>	<p>PA4154</p> 	<p>Cabin Air Element with Pull Tab Fits: Buick, Chevrolet, Pontiac Automotive Replaces: GMC 10261703, 10406026, 10446783 Length: 11 15/32 (291.3) Width: 7 11/32 (186.5) Height: 1 5/32 (29.4) A. Gskt: [1] Attached</p>
<p>PA4147</p> 	<p>Panel Air Element Fits: Ford, Mercury Light-Duty Trucks Replaces: Ford 1L2Z-9601-AA Length: 11 1/2 (292.1) Width: 7 3/32 (180.2) Height: 2 1/4 (57.2)</p>	<p>PA4155 KIT</p> 	<p>Set of 2 Cabin Air Elements Notes: Uses 2 filters per application. Fits: Chevrolet, Oldsmobile, Pontiac Vans Replaces: General Motors Corp. 52470574, 52482929; Wix 524811, 24811 Each Filter: Length: 9 1/32 (229.4) Width: 4 9/16 (115.9) Height: 2 7/32 (56.4) A. Gskt: [1] Included on Each</p>
<p>PA4148</p> 	<p>Panel Air Element Fits: Ford Light-Duty Trucks Replaces: Ford 1C3Z-9601-AA Length: 13 3/8 (339.7) Width: 7 5/16 (185.7) Height: 3 13/32 (86.5)</p>	<p>PA4156 KIT</p> 	<p>Set of 2 Cabin Air Elements Notes: Uses 2 filters per application. Contains: Charcoal Impregnated Media for Odor Control. Fits: Buick, Chevrolet, Oldsmobile, Pontiac, Saturn Light-Duty Trucks, Vans Replaces: GMC 10302760, 10322538 Each Filter: Length: 8 11/16 (220.7) Width: 4 1/4 (108.0) Height: 1 17/32 (38.9) A. Gskt: [1] Included on Each</p>
<p>PA4149 KIT</p> 	<p>Set of 2 Cabin Air Elements Notes: Uses 2 filters per application. Fits: Cadillac, Chevrolet Light-Duty Trucks Replaces: GMC 52485513 Each Filter: Length: 9 11/32 (237.3) Width: 5 7/16 (138.1) Height: 29/32 (23.0)</p>	<p>PA4157</p> 	<p>Panel Air Element Fits: Buick, Cadillac, Chevrolet, Pontiac, Saturn Automotive Replaces: Saturn 22676970 Length: 10 15/16 (277.8) Width: 9 11/32 (237.3) Height: 1 15/32 (37.3)</p>
<p>PA4150</p> 	<p>Panel Air Element Fits: Lexus, Toyota Automotive, Light-Duty Trucks Replaces: Toyota 17801-20040, 17801-0H010, 17801-0H020 Length: 12 17/32 (318.3) Width: 7 19/32 (192.9) Height: 1 11/16 (42.9) A. Gskt: [1] Attached</p>	<p>PA4158</p> 	<p>Air Element Fits: Euclid Dump Trucks Replaces: Euclid 9029495, E9029495; Fleetguard AF4728 O.D.: 3 17/32 (89.7) I.D.: 1 17/32 (38.9) Height: 4 1/2 (114.3)</p>
<p>PA4151</p> 	<p>Panel Air Element Fits: Dodge Light-Duty Trucks Replaces: Chrysler 53032404AA Length: 13 3/4 (349.3) Width: 9 11/32 (237.3) Height: 1 15/16 (49.2) A. Gskt: [1] Attached</p>		

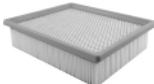
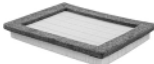

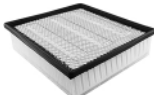
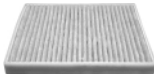
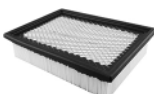
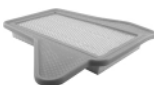
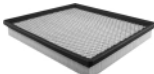

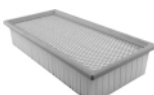



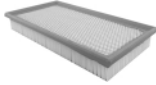
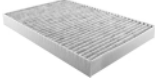

Measurements Are Shown In Inches And (Millimeters)

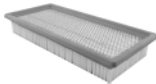
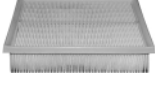
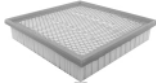
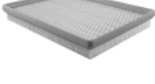
WARNING: These products can expose you to chemicals, including Diisononyl Phthalate, Carbon black extracts, Nickel, 1,3 Butadiene, Ethylene Oxide, Epichlorohydrin, which are known to the State of California to cause cancer, and Bisphenol, Ethylene Glycol, Ethylene Oxide, 1,3 Butadiene, Epichlorohydrin, which are known to the State of California to cause birth defects or other reproductive harm. For more information go to www.P65Warnings.ca.gov.

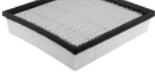
<p>PA4159 Cabin Air Element Contains: Charcoal Impregnated Media for Odor Control. Fits: Chrysler Pacifica, Town and Country, Voyager; Dodge Caravan, Grand Caravan Replaces: Chrysler 82205905 Length: 12 7/32 (310.4) Width: 9 7/32 (234.2) Height: 29/32 (23.0)</p> 	<p>PA4166 Air Element Fits: Hatz Engines Replaces: Bomag 5727220; Hatz 4030100; Fleetguard AF25481 O.D.: 5 1/2 (139.7) I.D.: 3 1/4 (82.6) Height: 3 9/32 (83.3)</p> 
<p>PA4160 Panel Air Element Fits: Ford, Mazda Light-Duty Trucks Replaces: Motorcraft FA1744 Length: 9 (228.6) Width: 7 3/4 (196.9) Height: 2 7/32 (56.4)</p> 	<p>PA4167 Panel Air Element Fits: Ford, Lincoln Light-Duty Trucks Replaces: Ford 4L3Z-9601-BA; Motorcraft FA1754 Length: 11 11/32 (288.1) Width: 8 15/32 (215.1) Height: 1 13/32 (35.7) A. Gskt: [1] Attached</p> 
<p>RS4161 Radial Seal Air Element Fits: Buick, Chevrolet, GMC Light-Duty Trucks Replaces: GMC 15036141 O.D.: 5 31/32 (151.6) I.D.: 3 7/32 (81.8) One End Height: 8 (203.2)</p> 	<p>PA4168 Cabin Air Element Fits: Jeep Grand Cherokee Replaces: Chrysler 5013595AB, 82208300 Length: 18 5/16 (465.1) Width: 3 1/16 (77.8) Height: 1 5/8 (41.3)</p> 
<p>PA4162 Panel Air Element with Foam Pad Fits: Dodge Light-Duty Trucks Replaces: Chrysler 53032700AA Length: 10 29/32 (277.0) Width: 9 7/8 (250.8) Height: 2 23/32 (69.1) A. Gskt: [1] Attached</p> 	<p>PA4169 Cabin Air Element Contains: Charcoal Impregnated Media for Odor Control Fits: Cadillac Escalade; Chevrolet Silverado, Suburban, Tahoe; GMC Sierra, Yukon Replaces: GMC 88986533; ACDelco CF127 Length: 10 5/8 (269.9) Width: 9 7/16 (239.7) Height: 1 (25.4) A. Gskt: [1] Attached</p> 
<p>PA4163 Panel Air Element Fits: Ford, Mazda, Mercury Automotive Replaces: Ford YL8Z-9601-AA; Mazda YF09-13-Z40 Length: 9 15/16 (252.4) Width: 7 1/32 (178.6) Height: 2 3/16 (55.6)</p> 	<p>PA4170 Panel Air Element Fits: Chrysler Pacifica Replaces: Chrysler 5510026AA Length: 12 5/32 (308.8) Width: 7 1/4 (184.2) to 12 19/32 (319.9) Height: 1 25/32 (45.2) A. Gskt: [1] Attached</p> 
<p>PA4164 Panel Air Element Fits: Jeep Grand Cherokee Replaces: Chrysler 5015610AA Length: 10 23/32 (272.3) Width: 9 11/16 (246.1) Height: 1 17/32 (38.9)</p> 	<p>PA4171 Panel Air Element Fits: Ford Vans Replaces: Ford 4C2U-9601-AB Length: 12 5/16 (312.7) Width: 6 23/32 (170.7) Height: 3 5/16 (84.1)</p> 
<p>PA4165 Panel Air Element Fits: Toyota Light-Duty Trucks Replaces: Toyota 17801-31090 Length: 13 31/32 (354.8) Width: 3 1/8 (79.4) to 6 17/32 (165.9) Height: 2 7/16 (61.9) A. Gskt: [1] Attached</p> 	<p>PA4172 Panel Air Element Fits: Ford Super Duty Pickups Replaces: Ford 5C3Z-9601-AA; Motorcraft FA1782 Length: 14 23/32 (373.9) Width: 6 13/16 (173.0) Height: 2 3/4 (69.9)</p> 

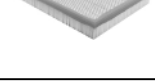

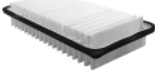









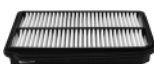

Measurements Are Shown In Inches And (Millimeters)

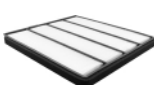
WARNING: These products can expose you to chemicals, including Diisononyl Phthalate, Carbon black extracts, Nickel, 1,3 Butadiene, Ethylene Oxide, Epichlorohydrin, which are known to the State of California to cause cancer, and Bisphenol, Ethylene Glycol, Ethylene Oxide, 1,3 Butadiene, Epichlorohydrin, which are known to the State of California to cause birth defects or other reproductive harm. For more information go to www.P65Warnings.ca.gov.

<p>PA4173</p> 	<p>Air Element Fits: Chevrolet Colorado, GMC Canyon; Hummer Replaces: GMC 15202408; ACDelco A1624C O.D.: 5 27/32 (148.4) I.D.: 3 5/8 (92.1) One End Height: 8 5/8 (219.1)</p>	<p>PA4181</p>  <p>Panel Air Element Fits: Ford, Jaguar, Lincoln, Mercury Automotive Replaces: Ford XW4Z-9601-AC; Motorcraft FA1679 Length: 12 7/32 (310.4) Width: 6 17/32 (165.9) Height: 1 3/4 (44.4)</p>
<p>PA4174</p> 	<p>Cabin Air Element Contains: Charcoal Impregnated Media for Odor Control. Fits: Chrysler 300; Dodge Charger, Magnum Replaces: Chrysler 4596501AB Length: 12 5/32 (308.8) Width: 8 5/16 (211.1) Height: 1 3/16 (30.2)</p>	<p>PA4182</p>  <p>Panel Air Element Fits: Acura, Honda Automotive Replaces: Honda 17220-PLC-000; Wix 42564 Length: 12 19/32 (319.9) Width: 7 3/4 (196.9) Height: 1 15/32 (37.3) A. Gskt: [1] Attached</p>
<p>PA4175</p> 	<p>Panel Air Element Fits: Ford, Mercury Automotive Replaces: Ford 6E5Z-9601-EA; Motorcraft FA1785 Length: 10 9/16 (268.3) Width: 6 5/16 (160.3) Height: 1 31/32 (50.0)</p>	<p>PA4183</p>  <p>Panel Air Element Fits: Ford, Mercury Automotive Replaces: Ford 5F9Z-9601-AA; Motorcraft FA1771 Length: 11 23/32 (297.7) Width: 5 11/32 (135.7) Height: 1 27/32 (46.8)</p>
<p>PA4176</p> 	<p>Panel Air Element Fits: Ford, Mercury Automotive Replaces: Ford 6E5Z-9601-GA; Motorcraft FA1786 Length: 8 13/32 (213.5) Width: 6 5/16 (160.3) Height: 1 31/32 (50.0)</p>	<p>PA4184</p>  <p>Panel Air Element Fits: Dodge Durango Replaces: Chrysler 53032527AA Length: 8 29/32 (226.2) Width: 8 5/8 (219.1) Height: 1 3/4 (44.4)</p>
<p>PA4177</p> 	<p>Panel Air Element Fits: Chrysler, Dodge Automotive, Light-Duty Trucks Replaces: Chrysler 5019002AA, 5037615AA Length: 11 15/32 (291.3) Width: 8 11/32 (211.9) Height: 1 1/2 (38.1)</p>	<p>PA4185</p>  <p>Panel Air Element Fits: 2006-on Ford Explorer, Mercury Mountaineer all with V8-281 (4.6L) Engine Replaces: Motorcraft FA1780; Wix 49145 Length: 15 5/32 (385.0) Width: 8 1/16 (204.8) Height: 1 9/32 (32.5)</p>
<p>PA4178</p> 	<p>Panel Air Element Fits: Chevrolet, Pontiac Automotive Replaces: GMC 10350737 Length: 9 3/8 (238.1) Width: 8 27/32 (224.6) Height: 1 31/32 (50.0)</p>	<p>PA4187</p>  <p>Foam Wrap Notes: Can be used as a replacement wrap for PA4553. Contains: Oil Wetted Media Fits: John Deere Mowers, Lawn & Garden Tractors Replaces: John Deere M76076 O.D.: 7 (177.8) I.D.: 6 3/4 (171.5) Height: 1 31/32 (50.0)</p>
<p>PA4179</p> 	<p>Panel Air Element Fits: Jeep Cherokee, Commander, Liberty Replaces: Chrysler 5018777AA Length: 11 15/32 (291.3) Width: 8 5/16 (211.1) Height: 1 19/32 (40.5)</p>	<p>PA4188</p>  <p>Cabin Air Element Fits: Mitsubishi, Subaru, Toyota Automotive Replaces: Toyota 87139-47010 Length: 8 15/32 (215.1) Width: 8 15/32 (215.1) Height: 21/32 (16.7)</p>
<p>PA4180</p> 	<p>Panel Air Element Fits: Pontiac, Scion, Toyota Automotive Replaces: Toyota 17801-0D020 Length: 11 3/8 (288.9) Width: 5 29/32 (150.0) Height: 2 (50.8) A. Gskt: [1] Attached</p>	<p>RS4189</p>  <p>Radial Seal Air Element Fits: Acura, Honda Automotive Replaces: Honda 17220-PNA-003, 17220-PNB-003; Wix 42188 O.D.: 5 7/16 (138.1) I.D.: 3 5/32 (80.2) Height: 6 27/32 (173.8)</p>



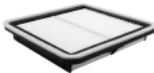

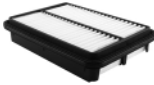





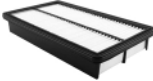

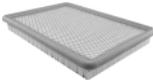
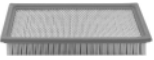

Measurements Are Shown In Inches And (Millimeters)

WARNING: These products can expose you to chemicals, including Diisononyl Phthalate, Carbon black extracts, Nickel, 1,3 Butadiene, Ethylene Oxide, Epichlorohydrin, which are known to the State of California to cause cancer, and Bisphenol, Ethylene Glycol, Ethylene Oxide, 1,3 Butadiene, Epichlorohydrin, which are known to the State of California to cause birth defects or other reproductive harm. For more information go to www.P65Warnings.ca.gov.

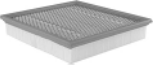
<p>PA4190 Panel Air Element Fits: Acura, Honda Automotive Replaces: Honda 17220-PGK-A00; ACDelco A2964C Length: 11 3/8 (288.9) Width: 2 1/8 (54.0) to 6 15/32 (164.3) Height: 1 5/8 (41.3) A. Gskt: [1] Attached</p> 	<p>PA4198 Panel Air Element Fits: Mitsubishi Automotive Replaces: Mitsubishi MR571396 Length: 9 1/8 (231.8) Width: 8 17/32 (216.7) Height: 1 31/32 (50.0)</p> 
<p>PA4191 Panel Air Element Fits: Acura, Honda Automotive Replaces: Honda 17220-RAA-A00; ACDelco A2950C Length: 13 7/16 (341.3) Width: 4 7/16 (112.7) to 5 15/16 (150.8) Height: 1 25/32 (45.2) A. Gskt: [1] Attached</p> 	<p>PA4199 Cabin Air Element Fits: Infiniti, Mitsubishi, Nissan Automotive, Light-Duty Trucks Replaces: Nissan B7200-5M000 Length: 8 11/16 (220.7) Width: 7 27/32 (199.2) Height: 1 3/16 (30.2)</p> 
<p>PA4192 Panel Air Element Fits: 2004-09 Toyota Prius Replaces: Toyota 17801-21040 Length: 11 11/32 (288.1) Width: 7 1/4 (184.2) Height: 1 1/16 (27.0) A. Gskt: [1] Attached</p> 	<p>PA4303 Panel Air Element Fits: 2002-04 Honda Odyssey Replaces: Honda 17220-P8F-A10 Length: 11 7/32 (285.0) Width: 6 11/32 (161.1) Height: 1 5/8 (41.3) A. Gskt: [1] Attached</p> 
<p>PA4193 Panel Air Element Fits: Acura, Honda Automotive Replaces: Honda 17220-RRA-A00 Length: 10 7/8 (276.2) Width: 6 11/32 (161.1) Height: 2 1/8 (54.0) A. Gskt: [1] Attached</p> 	<p>PA4304 Cabin Air Element Fits: Acura MDX; Honda Odyssey, Pilot Replaces: Honda 80290-S0X-A01 Length: 11 5/8 (295.3) Width: 10 3/8 (263.5) Height: 25/32 (19.8) A. Gskt: [1] Attached</p> 
<p>PA4194 Cabin Air Element Fits: Lexus, Toyota Automotive Replaces: Toyota 87139-32010 Length: 8 3/8 (212.7) Width: 8 5/16 (211.1) Height: 21/32 (16.7) A. Gskt: [2] Attached</p> 	<p>PA4305 Panel Air Element Fits: Scion, Toyota Automotive Replaces: Toyota 17801-21030 Length: 9 13/16 (249.2) Width: 4 3/4 (120.7) Height: 2 3/32 (53.2)</p> 
<p>PA4195 KIT Set of 2 Cabin Air Elements Notes: Uses 2 filters per application. Fits: Acura, Honda Automotive Replaces: Honda 80292-S5D-A01, 80292-S5A-003 Each Filter: Length: 8 27/32 (224.6) Width: 4 13/32 (111.9) Height: 1 1/8 (28.6)</p> 	<p>PA4306 Panel Air Element Fits: 2003-05 Honda Accord with V6-183 (3.0L) Engine Replaces: Honda 17220-RCA-A00; ACDelco A2951C Length: 12 29/32 (327.8) Width: 5 27/32 (148.4) Height: 1 19/32 (40.5) A. Gskt: [1] Attached</p> 
<p>PA4196 Cabin Air Element Fits: Acura, Honda Automotive Replaces: Honda 80292-SEC-A01 Length: 9 7/32 (234.2) Width: 8 21/32 (219.9) Height: 1 1/8 (28.6)</p> 	<p>PA4307 Panel Air Element Fits: 2001-05 Toyota RAV4 Replaces: Toyota 17801-28010 Length: 14 3/4 (374.7) Width: 3 7/8 (98.4) to 5 11/32 (135.7) Height: 2 1/8 (54.0)</p> 
<p>PA4197 Panel Air Element Fits: Subaru Automotive, Light-Duty Trucks Replaces: Subaru 16546-AA10A Length: 8 11/16 (220.7) Width: 8 15/32 (215.1) Height: 1 1/4 (31.8) A. Gskt: [1] Attached</p> 	<p>PA4308 Panel Air Element Fits: Hyundai, Kia Automotive Replaces: Hyundai 28113-2D000 Length: 10 (254.0) Width: 6 7/8 (174.6) Height: 1 5/8 (41.3)</p> 
<p>PA4309 Panel Air Element Fits: Hyundai Santa Fe Replaces: Hyundai 28113-26000 Length: 10 3/16 (258.8) Width: 7 (177.8) Height: 1 31/32 (50.0)</p> 	





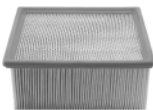





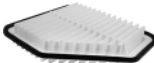
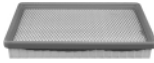

Measurements Are Shown In Inches And (Millimeters)

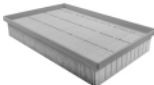
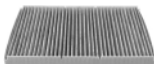
WARNING: These products can expose you to chemicals, including Diisononyl Phthalate, Carbon black extracts, Nickel, 1,3 Butadiene, Ethylene Oxide, Epichlorohydrin, which are known to the State of California to cause cancer, and Bisphenol, Ethylene Glycol, Ethylene Oxide, 1,3 Butadiene, Epichlorohydrin, which are known to the State of California to cause birth defects or other reproductive harm. For more information go to www.P65Warnings.ca.gov.

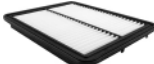
<p>PA4310 Panel Air Element Fits: 2000-06 Mazda MPV Van, 2003-on Mazda6 Replaces: Mazda RF2A-13-Z40A9U, RF2A-13-Z40A; Length: 12 19/32 (319.9) Width: 6 15/16 (176.2) Height: 1 27/32 (46.8)</p> 	<p>PA4319 Panel Air Element Notes: OBSOLETE. Availability Limited to Dealer Stock. Fits: Opel, Renault Light-Duty Trucks Replaces: GMC 93187335; Opel 4402614, 4416403; Renault 7701047285, 7701476258, 8200457286 Length: 12 11/32 (313.5) Width: 4 (101.6) Height: 1 5/8 (41.3)</p> 
<p>PA4311 Panel Air Element Fits: Hyundai Accent Replaces: Hyundai 28113-22600; ACDelco A2936C Length: 9 13/16 (249.2) Width: 6 5/8 (168.3) Height: 1 17/32 (38.9)</p> 	<p>PA4320 Panel Air Element Fits: 2006 Honda Civic 4-1799cc (1.8L) MFI, 2007-on Civic 4-1799cc (1.8L) FI, Natural Gas Engines Replaces: Honda 17220-RNA-A00; Wix 49065 Length: 8 15/16 (227.0) Width: 7 3/4 (196.9) Height: 1 3/4 (44.4) A. Gskt: [1] Attached</p> 
<p>PA4312 Panel Air Element Fits: Saturn Automotive Replaces: GMC 22679620; ACDelco A2953C Length: 11 29/32 (302.4) Width: 8 15/32 (215.1) Height: 1 13/32 (35.7)</p> 	<p>PA4321 Panel Air Element Fits: Ford, Mercury, Lincoln Automotive Replaces: Ford 7T4Z-9601-A; Motorcraft FA1884 Length: 11 31/32 (304.0) Width: 6 11/16 (169.9) Height: 1 3/4 (44.4)</p> 
<p>PA4313 Panel Air Element Fits: Hyundai Sonata; Kia Optima, Magentis Replaces: Hyundai 28113-37101 Length: 9 3/8 (238.1) Width: 7 1/2 (190.5) Height: 1 9/16 (39.7)</p> 	<p>PA4322 Panel Air Element Fits: Toyota Light-Duty Trucks Replaces: Toyota 17801-0S010 Length: 12 7/16 (315.9) Width: 11 11/16 (296.9) Height: 2 (50.8) A. Gskt: [1] Attached</p> 
<p>PA4314 Panel Air Element Fits: Chrysler PT Cruiser Replaces: Chrysler 4891176AA; ACDelco A2937C Length: 10 1/32 (254.8) Width: 7 7/16 (188.9) Height: 1 15/32 (37.3)</p> 	<p>PA4323 Panel Air Element Fits: Ford, Lincoln Light-Duty Trucks Replaces: Ford 7C3Z-9601-A; Motorcraft FA1883 Length: 10 15/32 (265.9) Width: 9 29/32 (251.6) Height: 1 7/8 (47.6)</p> 
<p>SA4315 Crankcase Breather Filter in Plastic Housing Fits: Buick, Chevrolet, GMC, Oldsmobile, Pontiac Automotive, Light-Duty Trucks, Vans Replaces: GMC 25041487, 25047377; ACDelco FB82 Width: 1 15/32 (37.3) Height: 1 3/8 (34.9)</p> 	<p>PA4324 Panel Air Element Fits: Pontiac Solstice, Saturn Sky Red Line Replaces: GMC 15925738; ACDelco A3084C Length: 14 9/16 (369.9) Width: 9 9/16 (242.9) Height: 1 5/32 (29.4) A. Gskt: [1] Attached</p> 
<p>PA4316 Panel Air Element Fits: Chevrolet HHR Replaces: GMC 22731072; ACDelco A3054C Length: 13 7/8 (352.4) Width: 4 29/32 (124.6) Height: 2 9/32 (57.9)</p> 	<p>PA4325 Panel Air Element Fits: 2006-10 Chrysler PT Cruiser Replaces: Chrysler 4891691AA Length: 10 5/32 (258.0) Width: 6 1/2 (165.1) Height: 1 11/16 (42.9)</p> 
<p>PA4317 Cabin Air Element Fits: Chevrolet, Pontiac, Saturn Automotive Replaces: GMC 52493319, ACDelco CF125 Length: 9 23/32 (246.9) Width: 8 1/2 (215.9) Height: 29/32 (23.0) A. Gskt: [2] Attached</p> 	<p>PA4327 Cabin Air Element Fits: Scion, Toyota Automotive, Light-Duty Trucks Replaces: Toyota 87139-YZZ08 Length: 8 7/16 (214.3) Width: 7 11/16 (195.3) Height: 1 1/8 (28.6)</p> 
<p>PA4318 Panel Air Element Fits: Dodge Light and Medium-Duty Trucks; Sterling Bullet Replaces: Chrysler 53034051AB Length: 10 15/16 (277.8) Width: 9 29/32 (251.6) Height: 4 3/8 (111.1)</p> 	

Measurements Are Shown In Inches And (Millimeters)

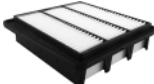
WARNING: These products can expose you to chemicals, including Diisononyl Phthalate, Carbon black extracts, Nickel, 1,3 Butadiene, Ethylene Oxide, Epichlorohydrin, which are known to the State of California to cause cancer, and Bisphenol, Ethylene Glycol, Ethylene Oxide, 1,3 Butadiene, Epichlorohydrin, which are known to the State of California to cause birth defects or other reproductive harm. For more information go to www.P65Warnings.ca.gov.

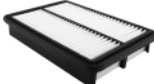
<p>PA4328 Air Element  Fits: Toyota Automotive, Light-Duty Trucks Replaces: Toyota 17801-31050, 17801-54080, 17801-54120; Donaldson P500021; Fleetguard AF25295 O.D.: 6 3/32 (154.8) I.D.: 1/2 (12.7) & 3 15/32 (88.1) Height: 7 3/4 (196.9) F. Gskt: [1] Metal Washer</p>	<p>PA4336 Cabin Air Element  Contains: Charcoal Impregnated Media for Odor Control. Fits: Dodge, Freightliner, Mercedes-Benz Sprinter Vans Replaces: Chrysler 68012876AA; Mercedes-Benz AA9068300318 Length: 14 9/16 (369.9) Width: 11 5/32 (283.4) Height: 1 3/8 (34.9) Related To: PA4488 (Standard Media Version)</p>
<p>PA4329 Panel Air Element  Fits: Chevrolet Cobalt; Pontiac G5, Pursuit Replaces: GMC 21999324; ACDelco A2956C Length: 9 3/8 (238.1) Width: 4 1/2 (114.3) to 8 3/8 (212.7) Height: 1 25/32 (45.2)</p>	<p>PA4337 Panel Air Element  Fits: Chevrolet, Pontiac Automotive Replaces: General Motors 10366901; ACDelco A2930C Length: 11 5/8 (295.3) Width: 7 3/32 (180.2) Height: 1 23/32 (43.7)</p>
<p>PA4330 Cabin Air Element  Fits: Buick, Cadillac, Oldsmobile, Pontiac Automotive Replaces: GMC 25654414; ACDelco CF117 Length: 11 1/4 (285.8) Width: 8 5/8 (219.1) Height: 29/32 (23.0) Related To: PA4384 (Charcoal Media Version)</p>	<p>PA4338 Panel Air Element  Fits: Ford, Mercury Automotive Replaces: Ford 3W3Z-9601-AA; Motorcraft FA1745; Wix 46814 Length: 11 13/32 (289.7) Width: 7 19/32 (192.9) Height: 1 31/32 (50.0)</p>
<p>PA4331 Cabin Air Element  Contains: Charcoal Impregnated Media for Odor Control. Fits: Audi, Volkswagen Automotive Replaces: Volkswagen 1J0819644, 1J0819644A Length: 11 3/32 (281.8) Width: 8 3/16 (208.0) Height: 1 3/16 (30.2)</p>	<p>PA4340 Cabin Air Element  Fits: Chevrolet Equinox; Pontiac Torrent; Saturn Sky, VUE Replaces: Saturn 22665802 Length: 16 3/4 (425.5) Width: 4 13/32 (111.9) Height: 1 1/8 (28.6)</p>
<p>PA4332 Cabin Air Element  Fits: Toyota Corolla, Matrix Replaces: Toyota 88568-02020; Wix 24873 Length: 8 21/32 (219.9) Width: 7 27/32 (199.2) Height: 25/32 (19.8)</p>	<p>PA4341 Panel Air Element  Fits: Kia Sorento Replaces: Kia 28113-3E000, 28113-3E500 Length: 11 21/32 (296.1) Width: 9 3/8 (238.1) Height: 1 5/16 (33.3)</p>
<p>PA4333 Panel Air Element  Fits: Lexus, Scion, Toyota Automotive, Light-Duty Trucks Replaces: Toyota 17801-31120, 17801-AD010 Length: 10 (254.0) Width: 5 1/2 (139.7) to 9 3/8 (238.1) Height: 2 1/4 (57.2) A. Gskt: [1] Attached</p>	<p>PA4344 Panel Air Element  Fits: Chevrolet Aveo, Pontiac Wave Replaces: GMC 96536696 Length: 8 3/4 (222.3) Width: 7 3/8 (187.3) Height: 1 25/32 (45.2) A. Gskt: [1] Attached</p>
<p>PA4334 Cabin Air Element  Fits: Hyundai, Kia Automotive, Light-Duty Trucks, Vans Replaces: Hyundai 97133-2B010, 97133-3K000 Length: 9 7/8 (250.8) Width: 8 23/32 (221.5) Height: 1 3/16 (30.2)</p>	<p>PA4345 Panel Air Element  Fits: Mazda3, Mazda5, MazdaSpeed3 Replaces: Mazda LF50-13-Z40A, LF50-13-Z40-9U Length: 10 27/32 (275.4) Width: 7 3/8 (187.3) Height: 2 3/32 (53.2) A. Gskt: [1] Attached</p>
<p>PA4335 Panel Air Element  Fits: Chrysler, Dodge Automotive Replaces: Chrysler 4891926AA Length: 9 9/32 (235.7) Width: 8 7/16 (214.3) Height: 1 17/32 (38.9)</p>	<p>PA4348 Panel Air Element  Fits: Hyundai Tucson, Kia Sportage Replaces: Hyundai 28113-08000 Length: 9 31/32 (253.2) Width: 6 13/16 (173.0) Height: 1 23/32 (43.7) A. Gskt: [1] Attached</p>

Measurements Are Shown In Inches And (Millimeters)

WARNING: These products can expose you to chemicals, including Diisononyl Phthalate, Carbon black extracts, Nickel, 1,3 Butadiene, Ethylene Oxide, Epichlorohydrin, which are known to the State of California to cause cancer, and Bisphenol, Ethylene Glycol, Ethylene Oxide, 1,3 Butadiene, Epichlorohydrin, which are known to the State of California to cause birth defects or other reproductive harm. For more information go to www.P65Warnings.ca.gov.

<p>PA4349</p> 	<p>Panel Air Element Fits: Hyundai Automotive Replaces: Hyundai 38113-3K200 Length: 9 9/32 (235.7) Width: 8 13/16 (223.8) Height: 2 5/16 (58.7) A. Gskt: [1] Attached</p>	<p>PA4360</p> 	<p>Panel Air Element Fits: 2003-08 Mazda6, 2006-07 MazdaSpeed6, 2007-on CX7 Replaces: Mazda AJ57-13-Z40, AJ57-13-Z409U Length: 12 5/16 (312.7) Width: 6 15/16 (176.2) Height: 1 27/32 (46.8) A. Gskt: [1] Attached</p>
<p>PA4350</p> 	<p>Panel Air Element Fits: Toyota Camry, Venza Replaces: Toyota 17801-28030, 17801-0H050 Length: 11 17/32 (292.9) Width: 7 7/8 (200.0) Height: 1 11/16 (42.9)</p>	<p>PA4361</p> 	<p>Panel Air Element Fits: 2005-10 Ford Mustang Replaces: Ford 4R3Z-9601-AA; Motorcraft FA1773 Length: 9 31/32 (253.2) Width: 9 3/16 (233.4) Height: 1 23/32 (43.7)</p>
<p>PA4351</p> 	<p>Panel Air Element Fits: 2007-09 Acura MDX; 2005-10 Honda Odyssey Replaces: Honda 17220-RGL-A00, 17220-RGL-A10 Length: 11 13/16 (300.0) Width: 6 7/8 (174.6) Height: 1 19/32 (40.5) A. Gskt: [1] Attached</p>	<p>PA4362</p> 	<p>Panel Air Element Fits: 2007-10 Dodge Caliber, Jeep Compass, Patriot Replaces: Chrysler 4891694AA Length: 12 27/32 (326.2) Width: 6 5/8 (168.3) Height: 1 1/4 (31.8)</p>
<p>PA4352</p> 	<p>Panel Air Element Fits: Toyota Prius Replaces: Toyota 17801-21020 Length: 7 5/16 (185.7) Width: 6 23/32 (170.7) Height: 1 1/16 (27.0)</p>	<p>PA4363</p> 	<p>Panel Air Element Fits: Hyundai, Kia Automotive Replaces: Hyundai 28113-1G000; Kia 28113-1G000 Length: 10 11/32 (262.7) Width: 5 9/32 (134.1) Height: 2 3/16 (55.6)</p>
<p>PA4354</p> 	<p>Panel Air Element Fits: Lexus Automotive Replaces: Toyota 17801-46080; WIX 46465 Length: 9 3/4 (247.7) Width: 8 9/32 (210.3) Height: 2 3/32 (53.2) A. Gskt: [1] Attached</p>	<p>PA4364</p> 	<p>Panel Air Element Fits: Acura, Honda Automotive Replaces: Honda 17220-R70-A00 Length: 10 5/16 (261.9) Width: 8 3/32 (205.6) Height: 1 3/4 (44.4) A. Gskt: [1] Attached</p>
<p>PA4355</p> 	<p>Panel Air Element Fits: Acura, Honda Automotive Replaces: Honda 17220-RDA-A00 Length: 12 27/32 (326.2) Width: 5 25/32 (146.8) Height: 2 1/8 (54.0) A. Gskt: [1] Attached</p>	<p>PA4365</p> 	<p>Cabin Air Element Fits: Ford, Lincoln Automotive Replaces: Ford 7T4Z-19N619-B Length: 7 7/8 (200.0) Width: 7 7/16 (188.9) Height: 23/32 (18.3)</p>
<p>PA4356</p> 	<p>Panel Air Element Fits: Toyota Tacoma Light-Duty Truck Replaces: Toyota 17801-0C040 Length: 12 19/32 (319.9) Width: 9 1/2 (241.3) Height: 2 1/16 (52.4)</p>	<p>PA4366</p> 	<p>Panel Air Element Fits: Honda Automotive Replaces: Honda 17220-PWA-J10, 17315-SLN-A01 Length: 6 21/32 (169.1) Width: 5 13/16 (147.6) Height: 2 7/32 (56.4) A. Gskt: [1] Attached</p>
<p>PA4358</p> 	<p>Panel Air Element Fits: Cadillac CTS Replaces: General Motors 25728874 Length: 3 15/32 (88.1) Width: 10 7/8 (276.2) Height: 1 1/4 (31.8)</p>	<p>PA4367</p> 	<p>Panel Air Element Fits: 2007-10 Dodge Nitro; 2008-11 Jeep Liberty Replaces: Chrysler 5189933AA Length: 11 15/32 (291.3) Width: 9 1/16 (230.2) Height: 2 5/16 (58.7)</p>
<p>PA4359</p> 	<p>Panel Air Element Fits: Volvo Automotive Replaces: Volvo 9454647, 9454647-0 Length: 13 (330.2) Width: 8 1/2 (215.9) Height: 2 9/32 (57.9)</p>		

Measurements Are Shown In Inches And (Millimeters)

WARNING: These products can expose you to chemicals, including Diisononyl Phthalate, Carbon black extracts, Nickel, 1,3 Butadiene, Ethylene Oxide, Epichlorohydrin, which are known to the State of California to cause cancer, and Bisphenol, Ethylene Glycol, Ethylene Oxide, 1,3 Butadiene, Epichlorohydrin, which are known to the State of California to cause birth defects or other reproductive harm. For more information go to www.P65Warnings.ca.gov.

PA4368 Panel Air Element
Fits: Chevrolet, Suzuki Light-Duty Trucks
Replaces: GMC 96553450; Suzuki 13780-85Z00
Length: 7 3/4 (196.9) to 8 3/4 (222.3)
Width: 11 5/16 (287.3)
Height: 1 7/16 (36.5)
A. Gskt: [1] Attached



PA4377 Panel Air Element
Fits: 2006-on Honda Ridgeline
Replaces: Honda 17220-RJE-A00
Length: 13 1/8 (333.4)
Width: 6 15/16 (176.2)
Height: 1 25/32 (45.2)
A. Gskt: [1] Attached

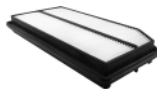

PA4369 Panel Air Element
Fits: Acura RDX
Replaces: Acura 17220-RWC-A00; Honda 17220-RWC-A00; Wix 49123
Length: 13 7/32 (335.8)
Width: 6 17/32 (165.9)
Height: 2 1/8 (24.0)



PA4381 Panel Air Element
Fits: Honda Civic Hybrid
Replaces: Honda 17220-PZA-000
Length: 8 7/8 (225.4)
Width: 5 31/32 (151.6)
Height: 1 9/16 (39.7)
A. Gskt: [1] Attached



PA4370 Cabin Air Element
Fits: Ford, Mazda Automotive, Light-Duty Trucks
Replaces: Ford YL8Z-19N619-AB, YL84-19N619-AB; Motorcraft FP46, FP49
Length: 10 11/32 (262.7)
Width: 6 23/32 (170.7)
Height: 1 13/32 (35.7)
A. Gskt: [1] Attached



PA4383 Panel Air Element
Fits: Audi, Volkswagen Automotive
Replaces: Audi 6F133843A; Volkswagen 6F133843A
Length: 15 29/32 (404.0)
Width: 6 25/32 (172.2)
Height: 1 13/32 (35.7)



PA4371 Cabin Air Element
Fits: Lexus, Toyota Light-Duty Trucks
Replaces: Toyota 87139-48020
Length: 9 7/32 (234.2)
Width: 8 7/16 (214.3)
Height: 23/32 (18.3)

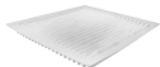

PA4384 Cabin Air Element
Contains: Charcoal Impregnated Media for Odor Control.
Fits: Buick, Cadillac, Oldsmobile, Pontiac Automotive
Replaces: GMC 25689297; ACDelco CF105C, CF118C
Length: 11 21/32 (296.1)
Width: 8 13/16 (223.8)
Height: 7/8 (22.2)
Related To: PA4330 (Non-Charcoal Version)

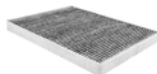

PA4372 Cabin Air Element
Fits: Scion, Toyota Automotive; Komatsu Excavators
Replaces: Toyota 88568-52010
Length: 8 1/2 (215.9)
Width: 7 11/16 (195.3)
Height: 5/8 (15.9)

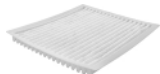

PA4385 Panel Air Element
Fits: 2005-on Ford Escape Hybrid; 2006-on Mercury Mariner Hybrid
Replaces: Ford 5M6Z-9601-AA; Motorcraft FA1772
Length: 12 7/8 (327.0)
Width: 5 17/32 (140.5)
Height: 1 23/32 (43.7)



PA4373 Cabin Air Element
Contains: Charcoal Impregnated Media for Odor Control.
Fits: Chrysler, Dodge, Jeep Automotive
Replaces: Chrysler 5058381AA, 5058693AA
Length: 8 1/2 (215.9)
Width: 7 21/32 (194.5)
Height: 31/32 (24.6)

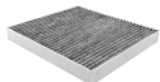

PA4386 Panel Air Element
Fits: Land Rover Discovery, Freelander, Range Rover
Replaces: Land Rover ESR4238
Length: 9 7/16 (239.7)
Width: 8 1/32 (204.0)
Height: 1 13/16 (46.0)



PA4374 Panel Air Element
Fits: Honda Automotive
Replaces: Honda 17220-R40-A00
Length: 10 9/16 (268.3)
Width: 5 (127.0) to 8 21/32 (219.9)
Height: 2 1/32 (51.6)
A. Gskt: [1] Attached



PA4387 Panel Air Element
Fits: Hyundai Santa Fe
Replaces: Hyundai 28113-26350
Length: 10 5/8 (269.9)
Width: 7 17/32 (191.3)
Height: 1 31/32 (50.0)
A. Gskt: [1] Attached





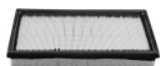







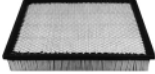

PA4376 Panel Air Element
Fits: Kia Automotive
Replaces: Kia K30C-13-Z40A, OK30C-13-Z40A
Length: 10 5/16 (261.9)
Width: 5 21/32 (143.7)
Height: 1 1/2 (38.1)

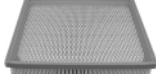

Measurements Are Shown In Inches And (Millimeters)

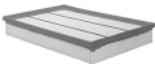
WARNING: These products can expose you to chemicals, including Diisononyl Phthalate, Carbon black extracts, Nickel, 1,3 Butadiene, Ethylene Oxide, Epichlorohydrin, which are known to the State of California to cause cancer, and Bisphenol, Ethylene Glycol, Ethylene Oxide, 1,3 Butadiene, Epichlorohydrin, which are known to the State of California to cause birth defects or other reproductive harm. For more information go to www.P65Warnings.ca.gov.

<p>PA4388</p> 	<p>Air Element Fits: Citroen, Peugeot Automotive Replaces: Citroen 1444.H1; Peugeot 1444-H2 O.D.: 4 1/2 (114.3) I.D.: 2 5/8 (66.7) Height: 8 9/16 (217.5)</p>	<p>PA4397 Panel Air Element Fits: Saturn Automotive Replaces: Saturn 96815102 Length: 5 11/16 (144.5) to 11 1/8 (282.6) Width: 8 13/16 (223.8) Height: 5 1/4 (133.4)</p> 
<p>PA4389</p> 	<p>Air Element Notes: OBSOLETE. Availability Limited to Dealer Stock. Replaces: Citroen 1444F5; Peugeot 1444-F5 O.D.: 6 5/8 (168.3) I.D.: 4 23/32 (119.9) Height: 4 27/32 (123.0)</p>	<p>PA4398 Cabin Air Element Fits: Saturn Automotive Replaces: Saturn 19130294 Length: 10 1/16 (255.6) Width: 8 3/4 (222.3) Height: 11/16 (17.5)</p> 
<p>PA4390</p> 	<p>Panel Air Element Fits: 2007-10 Dodge Sprinter, Freightliner Sprinter Replaces: Chrysler 68013676AA; Mercedes-Benz A0000902651 Length: 13 29/32 (353.2) Width: 10 7/16 (265.1) Height: 2 1/4 (57.2)</p>	<p>PA4399 Panel Air Element Fits: Nissan Automotive Replaces: Nissan 16546-JA00A, 16546-JA00B Length: 12 11/32 (313.5) Width: 5 7/32 (132.6) Height: 2 1/4 (57.2)</p> 
<p>PA4391</p> 	<p>Cabin Air Element Fits: Hyundai, Kia Automotive, Light-Duty Trucks Replaces: Kia 97133-2E200, 97133-2E210 Length: 8 15/16 (227.0) Width: 7 29/32 (200.8) Height: 21/32 (16.7)</p>	<p>PA4400 Panel Air Element Fits: Kia Automotive Replaces: Kia 28113-2G000 Length: 10 3/32 (256.4) Width: 7 15/16 (201.6) Height: 1 23/32 (43.7)</p> 
<p>PA4393</p> 	<p>Cabin Air Element Fits: Lexus, Toyota Automotive, Light-Duty Trucks Replaces: Toyota 87139-07010 Length: 8 15/32 (215.1) Width: 7 19/32 (192.9) Height: 1 1/8 (28.6)</p>	<p>PA4401 Panel Air Element Fits: Hyundai, Kia Automotive Replaces: Hyundai 28113-2H000 Length: 7 3/4 (196.9) Width: 7 13/32 (188.1) Height: 1 15/16 (49.2) A. Gskt: [1] Attached</p> 
<p>PA4394</p> 	<p>Cabin Air Element Fits: Ford, Mazda, Mercury Light-Duty Trucks Replaces: Ford 8L8Z-19N619-B; Motorcraft FP66 Length: 12 3/16 (309.6) Width: 4 (101.6) to 7 1/16 (179.4) Height: 25/32 (19.8) A. Gskt: [1] Attached</p>	<p>PA4402 Panel Air Element Fits: 2007-09 Hyundai Santa Fe Replaces: Hyundai 28113-2B000 Length: 10 9/16 (268.3) Width: 6 7/8 (174.6) Height: 2 3/8 (60.3) A. Gskt: [1] Attached</p> 
<p>PA4396</p> 	<p>Panel Air Element Fits: Audi, Volkswagen Automotive Replaces: Volkswagen 1K0129620; WIX 49122 Length: 13 5/8 (346.1) Width: 8 25/32 (223.0) Height: 1 31/32 (50.0)</p>	<p>PA4403 Set of 2 Cabin Air Elements Notes: Uses 2 filters per application. Fits: Mazda Automotive Replaces: Mazda BP4K-61-J6X Larger Filter Length: 9 1/4 (235.0) Width: 4 (101.6) Height: 7/8 (22.2) Smaller Filter Length: 9 5/16 (236.5) Width: 3 25/32 (96.0) Height: 7/8 (22.2) A. Gskt: [1] Attached to Smaller Filter</p> 
		<p>PA4404 Cabin Air Element Fits: Hyundai Automotive Replaces: Hyundai 87901-E000A, 971331-E000 Length: 9 21/32 (245.3) Width: 8 1/32 (204.0) Height: 3/4 (19.0) A. Gskt: [1] Attached</p> 

Measurements Are Shown In Inches And (Millimeters)

WARNING: These products can expose you to chemicals, including Diisononyl Phthalate, Carbon black extracts, Nickel, 1,3 Butadiene, Ethylene Oxide, Epichlorohydrin, which are known to the State of California to cause cancer, and Bisphenol, Ethylene Glycol, Ethylene Oxide, 1,3 Butadiene, Epichlorohydrin, which are known to the State of California to cause birth defects or other reproductive harm. For more information go to www.P65Warnings.ca.gov.

PA4405 Cabin Air Element
Fits: Chrysler, Dodge Vans; Infiniti Automotive
Replaces: Nissan 27277-EG025
Length: 9 (228.6)
Width: 7 13/16 (198.4)
Height: 1 1/4 (31.8)



PA4408 Cabin Air Element
Fits: Subaru Automotive, Light-Duty Trucks
Replaces: Subaru 3B451-30361; 72880-FE000;
 G3210-FE100; WIX 24485
Length: 8 3/8 (212.7)
Width: 7 1/4 (184.2)
Height: 1 1/8 (28.6)



PA4409 Cabin Air Element
Contains: Charcoal Impregnated Media for
 Odor Control.
Fits: Dodge, Freightliner Sprinter Vans
Replaces: Chrysler 5103600AA;
 Mercedes-Benz A9018300418
Length: 14 13/16 (376.2)
Width: 6 5/8 (168.3)
Height: 1 3/32 (27.8)
A. Gskt: [1] Attached
Related To: PA4489 (Standard Media Version)

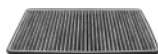

PA4410 KIT Set of 2 Cabin Air Elements
Notes: Uses 2 filters per application.
Fits: Nissan Frontier, Pathfinder, Xterra;
 Suzuki Equator
Replaces: Nissan 999M1-VR056
Each Filter:
Length: 10 5/32 (258.0)
Width: 3 31/32 (100.8)
Height: 31/32 (24.6)



PA4411 Cabin Air Element
Fits: Honda Fit
Replaces: Honda 80291-SAA-J01; Wix 24524
Length: 7 3/16 (182.6)
Width: 7 1/16 (179.4)
Height: 1 1/8 (28.6)



PA4412 Panel Air Element
Fits: Chevrolet, GMC, Hummer, Isuzu
 Light-Duty Trucks
Replaces: General Motors 15942429; ACDelco
 A3095C
Length: 12 9/32 (311.9)
Width: 10 (254.0)
Height: 2 (50.8)
A. Gskt: [1] Included



PA4413 Panel Air Element
Fits: 2007-09 Hyundai Entourage; 2006-on Kia
 Sedona
Replaces: Hyundai 28113-4D000; Kia
 28113-4D000
Length: 11 31/32 (304.0)
Width: 6 9/32 (159.5)
Height: 2 1/8 (54.0)
A. Gskt: [1] Attached



PA4415 Cabin Air Element
Fits: 2002-08 Mini Cooper, Cooper S
Replaces: BMW 64311496710; WIX 24478,
 24758
Length: 18 5/8 (473.1)
Width: 4 23/32 (119.9)
Height: 1 3/8 (34.9)



PA4416 KIT Set of 2 Cabin Air Elements
Notes: Uses 2 filters per application.
Fits: Acura, Honda Automotive
Replaces: Honda 80291-S84-A01
Each Filter:
Length: 11 19/32 (294.5)
Width: 3 3/4 (95.3)
Height: 1 3/16 (30.2)



PA4417 Panel Air Element
Fits: 2007-09 Honda CR-V
Replaces: Honda 17220-RZA-000
Length: 10 17/32 (267.5)
Width: 2 5/8 (66.7)
 to 6 23/32 (170.7)
Height: 1 15/16 (49.2)
A. Gskt: [1] Attached



PA4418 Panel Air Element
Fits: 2008-on Buick Enclave; 2009-on
 Chevrolet Traverse; 2007-on GMC Acadia,
 2007-10 Saturn Outlook
Replaces: GMC 15278634; ACDelco A3083C
Length: 5 1/2 (139.7) to 13 3/4 (349.3)
Width: 2 1/4 (57.2)
 to 11 3/4 (298.5)
Height: 1 23/32 (43.7)
A. Gskt: [1] Attached



PA4419 Panel Air Element
Fits: 2008-on Ford Focus
Replaces: Ford 8S4Z-9601-A; Motorcraft
 FA1890
Length: 3 3/4 (95.3) to 8 7/16 (214.3)
Width: 2 13/16 (71.4)
 to 7 3/4 (196.9)
Height: 2 3/16 (55.6)



PA4421 Panel Air Element
Fits: 2006-08 Suzuki Grand Vitara
Replaces: Suzuki 13780-65J00; Wix 49085
Length: 9 (228.6)
Width: 5 1/8 (130.2)
 to 7 (177.8)
Height: 1 15/16 (49.2)
A. Gskt: [1] Attached



PA4422 Panel Air Element
Fits: Nissan Frontier; Suzuki Equator
Replaces: Nissan 16546-EA000
Length: 15 1/16 (382.6)
Width: 7 9/32 (184.9)
Height: 1 5/16 (33.3)













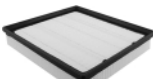

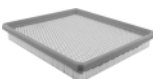
PA4423 Panel Air Element
Fits: Saturn Ion
Replaces: General Motors 15893542; Saturn
 15800986
Length: 11 15/16 (303.2)
Width: 7 23/32 (196.1)
Height: 1 5/16 (33.3)

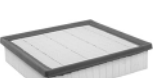
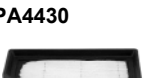

Measurements Are Shown In Inches And (Millimeters)

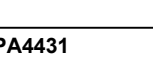
WARNING: These products can expose you to chemicals, including Diisononyl Phthalate, Carbon black extracts, Nickel, 1,3 Butadiene, Ethylene Oxide, Epichlorohydrin, which are known to the State of California to cause cancer, and Bisphenol, Ethylene Glycol, Ethylene Oxide, 1,3 Butadiene, Epichlorohydrin, which are known to the State of California to cause birth defects or other reproductive harm. For more information go to www.P65Warnings.ca.gov.

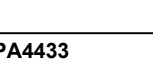
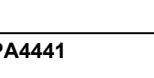
<p>PA4424</p> 	<p>Cabin Air Element Fits: Subaru Automotive, Light-Duty Trucks Replaces: Subaru 72880-SA000, G3010-SA100; WIX 49359 Length: 8 11/16 (220.7) Width: 7 7/8 (200.0) Height: 1 25/32 (45.2)</p>	<p>PA4434</p> 	<p>Panel Air Element Fits: Honda Pilot Replaces: Honda 17220-RN0-A00 Length: 11 27/32 (300.8) Width: 6 7/8 (174.6) Height: 1 27/32 (46.8) A. Gskt: [1] Included</p>
<p>PA4425</p> 	<p>Panel Air Element Fits: Ford Transit 2.2 TDCI Van (7/06-on) Replaces: Ford 1373667, 6C11-9601-CB Length: 10 3/4 (273.1) Width: 9 13/16 (249.2) Height: 1 27/32 (46.8)</p>	<p>PA4435</p> 	<p>Panel Air Element with Foam Pad Fits: Lexus GX460; Toyota 4Runner, FJ Cruiser Replaces: Toyota 17801-38050 Length: 12 19/32 (319.9) Width: 9 11/32 (237.3) Height: 2 7/16 (61.9)</p>
<p>PA4426</p> 	<p>Panel Air Element Fits: Chrysler, Dodge, Volkswagen Automotive, Vans Replaces: Chrysler 4891713AA; Volkswagen 7B0129620 Length: 9 11/32 (237.3) Width: 8 7/16 (214.3) Height: 1 3/8 (34.9)</p>	<p>PA4436</p> 	<p>Panel Air Element Fits: Chrysler Cirrus; Dodge Journey Replaces: Chrysler 4891916AA Length: 9 5/32 (232.6) Width: 8 15/32 (215.1) Height: 1 27/32 (46.8)</p>
<p>PA4428</p> 	<p>Panel Air Element Fits: Audi, Volkswagen Automotive Replaces: Volkswagen 1K0129620D, 1K0129620G, 3C0129620B Length: 13 9/16 (344.5) Width: 5 11/32 (135.7) Height: 2 25/32 (70.6)</p>	<p>PA4437</p> 	<p>Panel Air Element Fits: 2007-on Jeep Wrangler Replaces: Chrysler 53034018AD, 53034018AE Length: 11 1/2 (292.1) Width: 8 3/16 (208.0) Height: 1 23/32 (43.7) A. Gskt: [1] Attached</p>
<p>PA4429</p> 	<p>Panel Air Element Fits: Cadillac CTS Replaces: General Motors 15875795; ACDelco A3096C Length: 11 3/8 (288.9) Width: 9 3/8 (238.1) Height: 2 3/32 (53.2)</p>	<p>PA4438</p> 	<p>Panel Air Element Fits: Dodge Durango, Jeep Grand Cherokee Replaces: Chrysler 4861756AA Length: 9 5/8 (244.5) Width: 8 3/4 (222.3) Height: 2 3/16 (55.6)</p>
<p>PA4430</p> 	<p>Panel Air Element Fits: Ford Transit Connect Replaces: Ford 9T1Z-9601-A, 9T16-9601-AA; Motorcraft FA1900 Length: 2 11/16 (68.3) to 10 1/32 (254.8) Width: 1 1/32 (26.2) to 8 3/16 (208.0) Height: 2 13/32 (61.1)</p>	<p>PA4439</p> 	<p>Panel Air Element Fits: 2004-09 Cadillac SRX, 2005-on STS Replaces: General Motors 25735595, 25798271; ACDelco A2944C Length: 13 7/8 (352.4) Width: 9 (228.6) Height: 1 1/4 (31.8) A. Gskt: [1] Attached</p>
<p>PA4431</p> 	<p>Panel Air Element with Felt Pad Fits: Chevrolet Equinox, GMC Terrain Replaces: General Motors 25899727; ACDelco A3138C Length: 10 15/16 (277.8) Width: 8 27/32 (224.6) Height: 2 1/32 (51.6)</p>	<p>PA4440 KIT</p> 	<p>Set of 2 Panel Air Elements Notes: Uses 2 filters per application. Fits: Mercedes-Benz Automotive Replaces: Mercedes-Benz 1120940004, 1120940604, 1120910004, 1130940004 Each Filter: Length: 13 29/32 (353.2) Width: 5 1/4 (133.4) Height: 1 3/4 (44.4)</p>
<p>PA4433</p> 	<p>Panel Air Element Fits: Ford Super Duty F450, F550 Trucks with V8-406 (6.7L) FI Turbo Diesel Engine Replaces: Ford BC3Z-9601-A; Motorcraft FA1902 Length: 14 1/16 (357.2) Width: 6 11/16 (169.9) Height: 4 9/32 (108.7)</p>	<p>PA4441</p> 	<p>Panel Air Element Fits: 2007-12 Nissan Sentra Replaces: Nissan 16546-ET000 Length: 9 1/16 (230.2) Width: 7 7/16 (188.9) Height: 2 9/32 (57.9)</p>

Measurements Are Shown In Inches And (Millimeters)

WARNING: These products can expose you to chemicals, including Diisononyl Phthalate, Carbon black extracts, Nickel, 1,3 Butadiene, Ethylene Oxide, Epichlorohydrin, which are known to the State of California to cause cancer, and Bisphenol, Ethylene Glycol, Ethylene Oxide, 1,3 Butadiene, Epichlorohydrin, which are known to the State of California to cause birth defects or other reproductive harm. For more information go to www.P65Warnings.ca.gov.

PA4442 Panel Air Element
Fits: Nissan Cube, Tiida, Versa
Replaces: Nissan 16546-ED000
Length: 9 1/16 (230.2)
Width: 5 5/16 (134.9)
Height: 1 11/32 (34.1)
A. Gskt: [1] Included

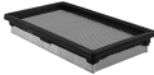

PA4443 Panel Air Element
Fits: Infiniti G35, EX35, G37, QX50; Nissan 350Z, 370Z
Replaces: Nissan 16546-JK20A
Length: 7 1/8 (181.0)
Width: 6 5/8 (168.3)
Height: 1 5/16 (33.3)

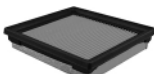

PA4444 Cabin Air Element with Pull Tab
Fits: Nissan Altima, Murano, Maxima, Quest
Replaces: Nissan 27277-JA000, 27277-JA00A, B7277-JN20A
Length: 11 1/16 (281.0)
Width: 10 9/16 (268.3)
Height: 13/16 (20.6)



RS4445 Radial Seal Air Element
Fits: Ford Escape, Mazda Tribute, Mercury Mariner
Replaces: Ford 9L8Z-9601-A; Mazda ZC423603
O.D.: 5 31/32 (151.6)
I.D.: 3 1/32 (77.0) One End
Height: 10 1/8 (257.2)



PA4446 Panel Air Element
Fits: 2009-10 Pontiac Vibe; 2008-on Scion xD; 2006-on Toyota Yaris, 2009-on Corolla, Matrix
Replaces: General Motors 88975792; Toyota 17801-0D060, 17801-0T030, 17801-21050
Length: 9 7/16 (239.7)
Width: 6 31/32 (177.0)
Height: 2 3/32 (53.2)
A. Gskt: [1] Attached



PA4447 Panel Air Element
Fits: 2006-10 Hyundai Sonata
Replaces: Hyundai 28113-3K010
Length: 9 1/8 (231.8)
Width: 7 15/32 (189.7)
Height: 2 9/32 (57.9)

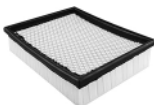

PA4448 Panel Air Element
Fits: Lexus RX400h; Toyota Highlander
Replaces: Toyota 17801-20050
Length: 14 5/16 (363.5)
Width: 6 3/16 (157.2)
Height: 1 29/32 (48.4)
A. Gskt: [1] Included



PA4449 Panel Air Element
Fits: Lexus RX350; Toyota Sienna
Replaces: Toyota 17801-0P050, 17801-31130
Length: 9 9/16 (242.9)
Width: 8 29/32 (226.2)
Height: 2 1/8 (54.0)

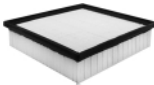

RS4450 Radial Seal Air Element
Fits: Ford Escape, Focus; Lincoln MKC
Replaces: Ford CV6Z-9601-A; Motorcraft FA1908
O.D.: 6 3/16 (157.2)
I.D.: 2 3/4 (69.9) One End
Height: 8 5/16 (211.1)
I.Gskt: [1] Included



PA4451 Panel Air Element
Fits: BMW X3, Z4
Replaces: BMW 13717542545
Length: 11 3/16 (284.2)
Width: 8 15/16 (227.0)
Height: 1 7/8 (47.6)



PA4452 Panel Air Element
Fits: Acura ILX, Honda Civic
Replaces: Honda 17220R1AA01
Length: 9 11/16 (246.1)
Width: 7 5/16 (185.7)
Height: 1 15/16 (49.2)
A. Gskt: [1] Included



PA4453 Panel Air Element with Foam Pad
Fits: Chevrolet Cruze; Buick Verano
Replaces: General Motors 13272719
Length: 10 15/32 (265.9)
Width: 10 3/16 (258.8)
Height: 1 15/32 (37.3)

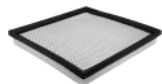

PA4454 Panel Air Element with Foam Pad
Fits: Buick, Chevrolet Automotive
Replaces: General Motors 13272720
Length: 10 3/32 (256.4)
Width: 9 13/16 (249.2)
Height: 1 21/32 (42.1)

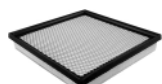

PA4455 Panel Air Element
Fits: Ford Fiesta
Replaces: Ford BE8Z-9601-A; Motorcraft FA1904
Length: 7 23/32 (196.1)
Width: 6 1/4 (158.8)
Height: 2 5/16 (58.7)



PA4456 Panel Air Element
Fits: Chrysler Town & Country, Dodge Grand Caravan; Ram Cargo Van; Volkswagen Routan
Replaces: Chrysler 4861737AA
Length: 12 3/4 (323.8)
Width: 9 23/32 (246.9)
Height: 1 25/32 (45.2)













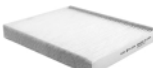
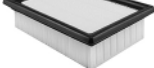



PA4458 Panel Air Element
Fits: Dodge Pickups with 6-360 (5.9L) FI Turbo Diesel Engine
Replaces: Chrysler 53034249AA
Length: 10 15/16 (277.8)
Width: 9 15/16 (252.4)
Height: 4 13/32 (111.9)

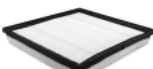











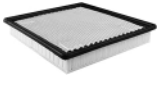

Measurements Are Shown In Inches And (Millimeters)

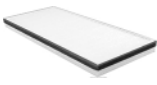
WARNING: These products can expose you to chemicals, including Diisononyl Phthalate, Carbon black extracts, Nickel, 1,3 Butadiene, Ethylene Oxide, Epichlorohydrin, which are known to the State of California to cause cancer, and Bisphenol, Ethylene Glycol, Ethylene Oxide, 1,3 Butadiene, Epichlorohydrin, which are known to the State of California to cause birth defects or other reproductive harm. For more information go to www.P65Warnings.ca.gov.

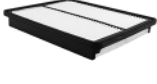
<p>PA4460 KIT</p> 	<p>Set of 2 Cabin Air Elements Fits: Jeep Wrangler Replaces: Chrysler 55111302AA Each Filter: Length: 6 1/16 (154.0) Width: 2 15/16 (74.6) Height: 25/32 (19.8)</p>	<p>PA4469</p> 	<p>Panel Air Element Fits: Nissan Versa with 4-1598cc (1.6L) Engine Replaces: Nissan 165461HK0A Length: 9 1/8 (231.8) Width: 4 9/16 (115.9) Height: 1 11/32 (34.1)</p>
<p>PA4461</p> 	<p>Cabin Air Element Fits: Ford Explorer, Flex, Taurus, Lincoln MKS, MKT Replaces: Ford AE9Z19N619A; Motorcraft FP68 Length: 8 15/16 (227.0) Width: 7 9/32 (184.9) Height: 1 1/32 (26.2) A. Gskt: [2] Included</p>	<p>PA4470</p> 	<p>Panel Air Element Fits: Ford Escape, Transit Connect Replaces: Ford CJ5Z-9601-A; Motorcraft FA1910 Length: 8 5/32 (207.2) Width: 6 3/32 (154.8) Height: 2 3/16 (55.6)</p>
<p>PA4462</p> 	<p>Cabin Air Element Fits: Dodge Durango, Jeep Grand Cherokee Replaces: Chrysler 68079487AA Length: 10 3/8 (263.5) Width: 9 19/32 (243.7) Height: 1 3/16 (30.2)</p>	<p>PA4471</p> 	<p>Panel Air Element with Foam Pad Fits: Ford Fusion; Lincoln MKZ Replaces: Ford DS7Z-9601-A; Motorcraft FA1912, FA1912A Length: 9 23/32 (246.9) Width: 7 29/32 (200.8) Height: 1 29/32 (48.4)</p>
<p>PA4463</p> 	<p>Panel Air Element Fits: Acura ILX, NSX, Honda Civic Replaces: Honda 17220RX0A00 Length: 10 7/32 (259.6) Width: 6 15/32 (164.3) Height: 2 13/32 (61.1) A. Gskt: [1] Included</p>	<p>PA4472</p> 	<p>Air Element Fits: Citroen, Fiat, Peugeot Vans Replaces: Citroen 1444QV; Fiat 1349042080, 1359643080; Peugeot 1444QT O.D.: 6 5/8 (168.3) I.D.: 3 13/16 (96.8) One End Height: 11 15/16 (303.2)</p>
<p>PA4464</p> 	<p>Panel Air Element with Foam Pad Fits: Chevrolet Impala with V6-217 (3.6L) Engine Replaces: General Motors 20862288; ACDelco A3171C Length: 11 13/16 (300.0) Width: 7 3/16 (182.6) Height: 2 29/32 (73.8)</p>	<p>PA4473</p> 	<p>Panel Air Element Fits: Dodge Dart Replaces: Chrysler 4627127AB Length: 7 23/32 (196.1) Width: 7 15/32 (189.7) Height: 2 5/16 (58.7)</p>
<p>PA4465</p> 	<p>Panel Air Element with Foam Pad Fits: Cadillac SRX; Saab 9-4X Replaces: General Motors 15913344, 20897358; ACDelco A3139C, A3147C Length: 10 7/16 (265.1) Width: 10 13/32 (264.3) Height: 1 23/32 (43.7)</p>	<p>PA4474</p> 	<p>Cabin Air Element Fits: Ford Focus, C-Max, Escape, Transit Connect; Lincoln MKC Replaces: Motorcraft FP70 Length: 9 27/32 (250.0) Width: 8 (203.2) Height: 1 13/32 (35.7) A. Gskt: [2] Included</p>
<p>PA4466</p> 	<p>Panel Air Element with Foam Pad Fits: Chevrolet Silverado, GMC Sierra Light-Duty Trucks with V8-400 (6.6L) Turbo Diesel Engine Replaces: General Motors 25945271; ACDelco A3141C Length: 13 (330.2) Width: 9 1/2 (241.3) Height: 2 29/32 (73.8)</p>	<p>PA4475</p> 	<p>Cabin Air Element Fits: Ford Fusion, Lincoln MKZ Replaces: Motorcraft FP71 Length: 10 15/16 (277.8) Width: 8 13/16 (223.8) Height: 3/4 (19.0)</p>
<p>PA4468</p> 	<p>Panel Air Element Fits: Honda CR-V with 4-2354cc (2.4L) Engine Replaces: Honda 17220R5AA00, 17220R5AA01 Length: 10 1/8 (257.2) Width: 7 3/4 (196.9) Height: 2 1/16 (52.4) A. Gskt: [1] Included</p>	<p>PA4476</p> 	<p>Panel Air Element Fits: Hyundai Azera, Sonata; Kia Optima, Sorento Replaces: Kia 281132P100; Knecht LX2957; Mahle LX2957 Length: 10 29/32 (277.0) Width: 8 31/32 (227.8) Height: 1 5/8 (41.3) A. Gskt: [1] Included</p>

Measurements Are Shown In Inches And (Millimeters)

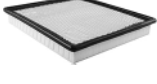
WARNING: These products can expose you to chemicals, including Diisononyl Phthalate, Carbon black extracts, Nickel, 1,3 Butadiene, Ethylene Oxide, Epichlorohydrin, which are known to the State of California to cause cancer, and Bisphenol, Ethylene Glycol, Ethylene Oxide, 1,3 Butadiene, Epichlorohydrin, which are known to the State of California to cause birth defects or other reproductive harm. For more information go to www.P65Warnings.ca.gov.

<p>PA4477 Panel Air Element  Fits: Honda CR-V Replaces: Honda 17220REZA00 Length: 10 13/32 (264.3) Width: 7 1/2 (190.5) Height: 2 3/32 (53.2) A. Gskt: [1] Included</p>	<p>PA4487 Panel Air Element with Foam Pad  Contains: Flame Retardant Media Fits: Buick Regal; Cadillac XTS; Chevrolet Malibu Replaces: General Motors 20972655 Length: 11 3/16 (284.2) Width: 9 15/16 (252.4) Height: 1 11/16 (42.9) Related To: PA4485 (without Foam Pad)</p>
<p>PA4478 Panel Air Element  Fits: Chrysler 300, Dodge Challenger, Charger Replaces: Chrysler 4861746AA Length: 14 1/4 (362.0) Width: 9 1/8 (231.8) Height: 1 15/32 (37.3)</p>	<p>PA4488 Cabin Air Element  Fits: Dodge, Freightliner, Mercedes-Benz Sprinter Light-Duty Trucks Replaces: Mercedes-Benz 9068300218, A9068300218; Donaldson P787452 Length: 13 31/32 (354.8) Width: 9 7/32 (234.2) Height: 1 3/8 (34.9) A. Gskt: [1] Attached Related To: PA4336 (Charcoal Media Version)</p>
<p>PA4479 Panel Air Element  Fits: Hyundai Accent, Veloster; Kia Rio, Soul Replaces: Hyundai 281131R100 Length: 10 5/32 (258.0) Width: 5 3/4 (146.0) Height: 1 7/8 (47.6) A. Gskt: [1] Included</p>	<p>PA4489 Cabin Air Element  Fits: Sprinter Vans Replaces: Mercedes-Benz 8303318, 9018300018, A00083603318, A901830018 Length: 14 9/16 (369.9) Width: 6 7/16 (163.5) Height: 31/32 (24.6) A. Gskt: [1] Attached Related To: PA4409 (Charcoal Media Version)</p>
<p>PA4480 Panel Air Element  Fits: Hyundai Elantra; Kia Forte Replaces: Hyundai 281133X000 Length: 10 5/32 (258.0) Width: 6 13/32 (162.7) Height: 2 1/16 (52.4) A. Gskt: [1] Included</p>	<p>PA4548 Inner Air Element  Fits Inside: PA3650 Fits: Komatsu Excavators Replaces: Komatsu 600-181-6360 O.D.: 3 5/32 (80.2) I.D.: 5/8 (15.9) & 2 5/32 (54.8) Height: 9 1/32 (229.4) A. Gskt: [1] Attached F. Gskt: [1] Included</p>
<p>PA4481 Panel Air Element  Fits: Hyundai Santa Fe; Kia Sorento Replaces: Hyundai 28113-2W100 Length: 11 27/32 (300.8) Width: 9 (228.6) Height: 1 15/32 (37.3) A. Gskt: [1] Included</p>	<p>RS4549 Radial Seal Inner Air Element  Fits Inside: RS3714 Fits: M.A.N. Trucks Replaces: M.A.N. 81.08304.0084; Donaldson P778453 O.D.: 6 7/8 (174.6) I.D.: 6 7/16 (163.5) One End Height: 18 1/2 (469.9)</p>
<p>PA4483 Panel Air Element  Fits: Jeep Grand Cherokee Replaces: Chrysler 4861688AA Length: 8 11/16 (220.7) Width: 8 9/32 (210.3) Height: 1 15/16 (49.2)</p>	<p>PA4551 Oval Air Element with Foam Wrap  Fits: Honda GX110 Engine Replaces: Honda 17201-ZE0-822, 17210-ZE0-505 O.D.: 2 7/8 (73.0) to 4 (101.6) I.D.: 1/4 (6.4) & 1 5/16 (33.3) Height: 2 1/16 (52.4) A. Gskt: [1] Metal Washer Grommets: [1] Attached</p>
<p>PA4484 Panel Air Element  Fits: Jeep Cherokee Replaces: Chrysler 52022378AA Length: 10 19/32 (269.1) Width: 7 9/32 (184.9) Height: 1 21/32 (42.1)</p>	
<p>PA4485 Panel Air Element  Contains: Flame Retardant Media Fits: Chevrolet Malibu, Impala Replaces: General Motors 20972654 Length: 11 3/16 (284.2) Width: 9 15/16 (252.4) Height: 1 9/16 (39.7) Related To: PA4487 (with Foam Pad)</p>	
<p>PA4486 Cabin Air Element  Fits: General Motors Light-Duty Trucks Replaces: General Motors 22808781 Length: 9 3/4 (247.7) Width: 9 5/32 (232.6) Height: 1 3/16 (30.2)</p>	

Measurements Are Shown In Inches And (Millimeters)

WARNING: These products can expose you to chemicals, including Diisononyl Phthalate, Carbon black extracts, Nickel, 1,3 Butadiene, Ethylene Oxide, Epichlorohydrin, which are known to the State of California to cause cancer, and Bisphenol, Ethylene Glycol, Ethylene Oxide, 1,3 Butadiene, Epichlorohydrin, which are known to the State of California to cause birth defects or other reproductive harm. For more information go to www.P65Warnings.ca.gov.

PA4552 Oval Air Element with Foam Wrap
Fits: Honda GX240, GX270 Engines
Replaces: Honda 17210-ZE2-505, 17210-ZE2-822
O.D.: 3 1/2 (88.9)
to 3 31/32 (100.8)
I.D.: 1 1/2 (38.1) & 1 5/8 (41.3)
Height: 3 3/32 (78.6)
A. Gskt: [1] Metal Washer
Grommets: [1] Attached



RS4561 Radial Seal Air Element
Fits: Caterpillar Engines
Replaces: Caterpillar 289-2348
O.D.: 10 31/32 (278.6)
I.D.: 5 13/16 (147.6) One End
Height: 16 7/16 (417.5)



PA4553 Oval Air Element with Foam Wrap
Notes: Replacement foam wrap is PA4187.
Fits: John Deere Garden Tractors, Transporters
Replaces: John Deere M117254
O.D.: 4 21/32 (118.3)
to 7 7/8 (200.0)
I.D.: 2 21/32 (67.5) & 5 7/8 (149.2)
Height: 2 9/16 (65.1)



RS4562 Radial Seal Air Element
Fits: DAF Trucks
Replaces: DAF 1346885, 1385791
O.D.: 9 11/16 (246.1)
I.D.: 4 29/32 (124.6) One End
Height: 17 7/16 (442.9)



PA4554 Panel Air Element
Replaces: Elgin 7070010
Length: 13 15/16 (354.0)
Width: 6 (152.4)
Height: 2 9/16 (65.1)
A. Gskt: [1] Attached



RS4563 Conical-Shaped Radial Seal Air Element
Fits: Freightliner Trucks
Replaces: Fleetguard AF25693; Nelson 870710A, 870710N
O.D.: 7 3/4 (196.9)
to 10 13/32 (264.3)
I.D.: 3 1/8 (79.4) & 5 27/32 (148.4)
Height: 22 3/16 (563.6)
F. Gskt: [1] Included



PA4555 Panel Air Element
Fits: Briggs & Stratton Engines
Replaces: Briggs & Stratton 397795; GMC 25177524
Length: 6 5/16 (160.3)
Width: 4 7/16 (112.7)
Height: 13/16 (20.6)



PA4557 Air Element
Fits: Onan RV Generators
Replaces: Onan 140-1891, 140-2379
O.D.: 4 (101.6)
I.D.: 2 3/4 (69.9)
Height: 3 5/32 (80.2)



RS4564 Radial Seal Air Element
Notes: Uses 2 filters per application.
Inside-Out Flow Direction
Contains: 3 3/4 Inch Dust Ejector Hole
Fits: Peterbilt Trucks
Replaces: Donaldson P542753
O.D.: 11 3/8 (288.9)
I.D.: 6 13/16 (173.0) One End
Height: 21 11/32 (542.1)
F. Gskt: G501-AF



PA4559 Foam Cab Air Element
Fits: Volvo Loaders
Replaces: Volvo 11007847
Length: 18 5/32 (461.2)
Width: 15 9/16 (395.3)
Height: 19/32 (15.1)



PA4566 Air Element
Fits: Caterpillar Equipment
Replaces: Caterpillar 8T6288; Ingersoll-Rand 39322201
O.D.: 12 3/4 (323.8)
Boot Gasket 13 11/32 (338.9)
I.D.: 15/16 (23.8) & 8 11/32 (211.9)
Height: 24 1/2 (622.3)
A. Gskt: [2] Attached
F. Gskt: [1] Washer



PA4560 Cab Air Element
Fits: Volvo Construction Equipment
Replaces: Volvo 11007848
Length: 15 19/32 (396.1)
Width: 12 27/32 (326.2)
Height: 2 3/4 (69.9)



PA4567 Cab Air Element
Fits: John Deere Equipment
Replaces: John Deere AT141209; Nelson 87387N
Length: 14 5/8 (371.5)
Width: 4 7/8 (123.8)
Height: 2 9/16 (65.1)
A. Gskt: [1] Attached

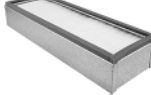

Measurements Are Shown In Inches And (Millimeters)

WARNING: These products can expose you to chemicals, including Diisononyl Phthalate, Carbon black extracts, Nickel, 1,3 Butadiene, Ethylene Oxide, Epichlorohydrin, which are known to the State of California to cause cancer, and Bisphenol, Ethylene Glycol, Ethylene Oxide, 1,3 Butadiene, Epichlorohydrin, which are known to the State of California to cause birth defects or other reproductive harm. For more information go to www.P65Warnings.ca.gov.

PA4570 Set of 2 Cab Air Elements
Notes: Uses 2 filters per application.
Fits: John Deere Tractors
Replaces: John Deere AL112954, AL112955, AL71259
Each Filter:
Length: 8 (203.2)
Width: 4 1/4 (108.0) to 6 1/4 (158.8)
Height: 1 7/16 (36.5)
A. Gskt: [1] Attached Each Element



RS4576 Radial Seal Outer Air Element
Fits: Case Tractors
Use With: RS4577
Replaces: Case 294292A1
O.D.: 13 7/16 (341.3)
I.D.: 7 29/32 (200.8) One End
Height: 11 9/16 (293.7)



PA4571 Air Element with Lid
Notes: Lid contains [6] bolt holes.
Replaces: Cummins 3630778; Fleetguard AF25278
O.D.: 13 13/16 (350.8)
Lid 16 1/4 (412.8)
I.D.: 9 1/2 (241.3) One End
Height: 18 1/2 (469.9)
A. Gskt: [1] Attached



RS4577 Radial Seal Inner Air Element
Fits Inside: RS4576
Fits: Case Tractors
Replaces: Case 294293A1
O.D.: 8 1/8 (206.4)
I.D.: 6 1/8 (155.6) One End
Height: 10 9/16 (268.3)



RS4572 Radial Seal Air Element
Fits: Peterbilt Trucks
Replaces: Donaldson P544243
O.D.: 12 3/32 (307.2)
I.D.: 7 3/8 (187.3) One End
Height: 21 11/16 (550.9)
F. Gskt: [1] Included



RS4578 Radial Seal Air Element
Contains: Flame Retardant Media
Fits: Hyster Lift Trucks
Replaces: Hyster 8500534
O.D.: 5 13/32 (137.3)
I.D.: 3 3/16 (81.0) One End
Height: 12 31/32 (329.4)
Related To: RS3542 (Standard Media Version)



PA4573 Outer Air Element with Lift Bars
Fits: New Holland Equipment
Use With: PA4574
Replaces: New Holland 86512479
O.D.: 11 1/2 (292.1)
I.D.: 13/32 (10.3) & 7 1/4 (184.2)
Height: 20 3/4 (527.1)
A. Gskt: [1] Attached
F. Gskt: [1] Included



RS4579 Radial Seal Outer Air Element
Fits: Atlas Copco Drilling Rigs; Case-International, New Holland Tractors; Volvo Dump Trucks
Use With: RS4580
Replaces: Volvo 11110217; Donaldson P781398
O.D.: 14 7/32 (361.2)
I.D.: 8 15/16 (227.0) One End
Height: 19 3/8 (492.1)



PA4574 Inner Air Element
Fits Inside: PA4573
Fits: New Holland Equipment
Replaces: New Holland 86512478
O.D.: 6 7/8 (174.6)
I.D.: 5/8 (15.9) & 5 13/32 (137.3)
Height: 19 1/8 (485.8)
A. Gskt: [1] Attached
F. Gskt: [1] Included



RS4580 Radial Seal Inner Air Element
Fits Inside: RS4579
Fits: Atlas Copco Drilling Rigs; Case-International, New Holland Tractors; Volvo Dump Trucks
Replaces: Volvo 11110218; Donaldson P781399
O.D.: 9 3/32 (231.0)
I.D.: 6 29/32 (175.4) One End
Height: 19 3/32 (485.0)



PA4581 Outer Air Element
Fits: Komatsu Dozers, Graders
Use With: PA4582
Replaces: Komatsu 600-300-0110
O.D.: 8 1/2 (215.9)
I.D.: 4 5/32 (105.6) One End
Height: 16 3/4 (425.5)
A. Gskt: [1] Attached
Related To: PA3609 (with Bolt Hole in Closed End)



Measurements Are Shown In Inches And (Millimeters)

WARNING: These products can expose you to chemicals, including Diisononyl Phthalate, Carbon black extracts, Nickel, 1,3 Butadiene, Ethylene Oxide, Epichlorohydrin, which are known to the State of California to cause cancer, and Bisphenol, Ethylene Glycol, Ethylene Oxide, 1,3 Butadiene, Epichlorohydrin, which are known to the State of California to cause birth defects or other reproductive harm. For more information go to www.P65Warnings.ca.gov.

PA4582 Inner Air Element with 6 Bolts
Fits Inside: PA4581
Fits: Komatsu Dozers, Graders
Replaces: Komatsu 600-300-0121, 6110-80-7300, 6610-80-7300
O.D.: 4 5/32 (105.6)
 Flange 6 11/16 (169.9)
I.D.: 2 27/32 (72.2) One End
Height: 16 7/16 (417.5)
A. Gskt: [1] Attached



RS4595 Radial Seal Outer Air Element
Fits: Fleetguard/Nelson AH19087, AH19088, AH19089, AH19090 Housings
Use With: RS3747
Replaces: Nelson 87797N; Fleetguard AF25553
O.D.: 5 1/32 (127.8)
I.D.: 3 5/32 (80.2) One End
Height: 12 7/16 (315.9)



PA4583-FN Air Element with Fins
Fits: Caterpillar Lift Trucks
Replaces: Mitsubishi 91461-11500
O.D.: 5 1/4 (133.4)
 Fins 6 3/8 (161.9)
I.D.: 2 1/32 (16.7) & 3 5/16 (84.1)
Height: 11 3/8 (288.9)
A. Gskt: [1] Attached
F. Gskt: [1] Included



RS4597 Radial Seal Cab Air Element
Fits: John Deere Loaders
Replaces: John Deere T168220
O.D.: 6 1/2 (165.1)
I.D.: 3 9/16 (90.5) One End
Height: 11 19/32 (294.5)



PA4585 Air Element with Lid
Replaces: Fleetguard AF1968
O.D.: 10 5/8 (269.9)
 Lid 11 11/16 (296.9)
I.D.: 6 23/32 (170.7) One End
Height: 22 15/32 (570.7)
A. Gskt: [1] Attached



RS4598 Radial Seal Outer Air Element
Fits: New Holland Tractors
Use With: RS4599
Replaces: New Holland 82983412
O.D.: 6 1/2 (165.1)
I.D.: 3 11/16 (93.7) One End
Height: 14 5/8 (371.5)



PA4592 Cab Air Element
Fits: Caterpillar Equipment
Replaces: Caterpillar 7R2258
Length: 17 (431.8)
Width: 6 (152.4)
Height: 2 3/16 (55.6)



RS4599 Radial Seal Inner Air Element
Fits Inside: RS4598
Fits: New Holland Tractors
Replaces: New Holland 82983413
O.D.: 3 29/32 (99.2)
I.D.: 3 1/16 (77.8) One End
Height: 14 1/32 (356.4)



PA4593 Outer Air Element
Fits: Komatsu Dozers
Use With: PA4594
Replaces: Komatsu 600-181-7210; Donaldson P181144
O.D.: 7 1/16 (179.4)
I.D.: 7/16 (11.1) & 3 15/16 (100.0)
Height: 12 3/8 (314.3)
A. Gskt: [1] Attached
Grommets: [1] Attached



PA4600 Panel Air Element
Fits: Dodge, Freightliner, Mercedes-Benz, Volkswagen Trucks, Vans
Replaces: Mercedes-Benz 30947504, 30948204, 40942604, A0030947504; Volkswagen 2D0129620
Length: 12 13/32 (315.1)
Width: 10 7/8 (276.2)
Height: 2 25/32 (70.6)
A. Gskt: [1] Attached

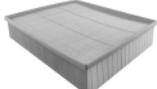

PA4594 Inner Air Element
Fits Inside: PA4593
Fits: Komatsu Dozers
Replaces: Komatsu 600-181-7310
O.D.: 3 13/16 (96.8)
I.D.: 5/8 (15.9) & 2 3/8 (60.3)
Height: 11 7/16 (290.5)
A. Gskt: [1] Attached
F. Gskt: [1] Included





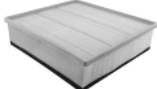









PA4601 Panel Air Element with Foam Pad
Fits: Dodge, Freightliner, Mercedes-Benz, Volkswagen Trucks, Vans
Replaces: Mercedes-Benz 30948304, A0030948304; Volkswagen 2D0129620A
Length: 12 13/32 (315.1)
Width: 10 7/8 (276.2)
Height: 3 3/16 (81.0)



Measurements Are Shown In Inches And (Millimeters)

WARNING: These products can expose you to chemicals, including Diisononyl Phthalate, Carbon black extracts, Nickel, 1,3 Butadiene, Ethylene Oxide, Epichlorohydrin, which are known to the State of California to cause cancer, and Bisphenol, Ethylene Glycol, Ethylene Oxide, 1,3 Butadiene, Epichlorohydrin, which are known to the State of California to cause birth defects or other reproductive harm. For more information go to www.P65Warnings.ca.gov.

<p>PA4602 Outer Air Element Fits: Hitachi Excavators Use With: PA4603 Replaces: Hitachi 4285623 O.D.: 6 3/32 (154.8) Flange 7 7/8 (200.0) I.D.: 2 1/32 (16.7) & 4 3/32 (104.0) Height: 12 7/8 (327.0) A. Gskt: [1] Attached F. Gskt: [1] Included</p> 	<p>PA4610 KIT Set of 2 Outer Air Elements Notes: Contains 2 elements that stack. Use With: PA4611 Replaces: Komatsu 66758-17021 and 66758-17231; Fleetguard AF25088 and AF25048 Each Element O.D.: 9 21/32 (245.3) I.D.: 5 7/32 (132.6) Height: 8 27/32 (224.6) A. Gskt: [2] Attached to Element</p> 
<p>PA4603 Inner Air Element Fits Inside: PA4602 Fits: Hitachi Excavators Replaces: Hitachi 4247975 O.D.: 3 7/8 (98.4) I.D.: 5/8 (15.9) & 3 3/16 (81.0) Height: 11 19/32 (294.5) A. Gskt: [1] Attached F. Gskt: [1] Washer</p> 	<p>PA4611 Inner Air Element Fits Inside: PA4610 KIT Replaces: Komatsu 67758-17031; Fleetguard AF25049 O.D.: 5 1/16 (128.6) I.D.: 13/32 (10.3) & 3 13/16 (96.8) Height: 16 15/16 (430.2) A. Gskt: [1] Attached F. Gskt: [1] Included</p> 
<p>PA4604-FN Air Element with Fins Replaces: Nelson 70757H; Fleetguard AF25543K O.D.: 4 3/32 (104.0) Fins 5 1/16 (128.6) I.D.: 2 1/32 (16.7) & 2 15/32 (62.7) Height: 10 3/8 (263.5) A. Gskt: [1] Attached F. Gskt: [1] Included</p> 	<p>PA4612 Cab Air Element with Pull Tabs Notes: OBSOLETE. Availability Limited to Dealer Stock. Fits: DAF XF Trucks Replaces: DAF 1322255; Fleetguard AF25840 Length: 12 21/32 (321.5) Width: 9 1/4 (235.0) Height: 15/16 (23.8) A. Gskt: [1] Attached</p> 
<p>PA4605 Air Element Replaces: Fleetguard AF25409M O.D.: 13 13/16 (350.8) I.D.: 15/16 (23.8) & 9 1/2 (241.3) Height: 12 21/32 (321.5) A. Gskt: [2] Attached F. Gskt: [1] Included</p> 	<p>RS4613 Radial Seal Air Element Notes: Inside-Out Flow Direction Contains: 4 5/8 Inch Dust Ejector Hole Replaces: Mack 57MD318 O.D.: 12 3/32 (307.2) I.D.: 7 3/8 (187.3) One End Height: 21 11/16 (550.9) F. Gskt: [1] Included</p> 
<p>PA4606 Air Element with Bail Handle Replaces: Ingersoll-Rand 39333372 O.D.: 13 13/16 (350.8) Boot Gasket 14 1/2 (368.3) I.D.: 15/16 (23.8) & 9 1/2 (241.3) Height: 27 5/16 (693.7) A. Gskt: [2] Attached F. Gskt: [1] Included</p> 	<p>PA4614 Outer Air Element Fits: J.C. Bamford Loaders Use With: PA3819 Replaces: J.C. Bamford 32/909101 O.D.: 6 1/4 (158.8) Flange 6 7/8 (174.6) I.D.: 19/32 (15.1) & 2 25/32 (70.6) Height: 8 1/2 (215.9) A. Gskt: [1] Attached F. Gskt: [1] Included, [1] Wing Nut</p> 
<p>PA4608 Air Element Fits: Toyota Vans Replaces: Toyota 17801-64030 O.D.: 5 3/16 (131.8) I.D.: 15/32 (11.9) & 2 17/32 (64.3) Height: 11 1/32 (280.2) F. Gskt: [1] Included</p> 	<p>RS4616 Radial Seal Outer Air Element Fits: Terex Dump Trucks Use With: RS4617 Replaces: Terex 15273424 O.D.: 14 7/32 (361.2) I.D.: 8 15/16 (227.0) One End Height: 20 1/2 (520.7)</p> 

Measurements Are Shown In Inches And (Millimeters)

WARNING: These products can expose you to chemicals, including Diisononyl Phthalate, Carbon black extracts, Nickel, 1,3 Butadiene, Ethylene Oxide, Epichlorohydrin, which are known to the State of California to cause cancer, and Bisphenol, Ethylene Glycol, Ethylene Oxide, 1,3 Butadiene, Epichlorohydrin, which are known to the State of California to cause birth defects or other reproductive harm. For more information go to www.P65Warnings.ca.gov.

<p>RS4617</p> 	<p>Radial Seal Inner Air Element Fits Inside: RS4616 Fits: Terex Dump Trucks Replaces: Terex 15243425 O.D.: 9 3/32 (231.0) I.D.: 6 29/32 (175.4) One End Height: 20 11/32 (516.7)</p>	<p>RS4622</p> 	<p>Radial Seal Outer Air Element Fits: John Deere Tractors Use With: RS4623 Replaces: John Deere RE164839 O.D.: 12 31/32 (329.4) I.D.: 6 13/16 (173.0) One End Height: 11 11/16 (296.9)</p>
<p>RS4618</p> 	<p>Radial Seal Air Element Notes: Inside-Out Flow Direction Contains: Drainage hole in bottom. Fits: Mack Trucks Replaces: Mack 57MD317 O.D.: 11 3/8 (288.9) I.D.: 5 13/16 (147.6) One End Height: 20 13/32 (518.3) F. Gskt: G501-AF</p>	<p>RS4623</p> 	<p>Radial Seal Inner Air Element Fits Inside: RS4622 Fits: John Deere Tractors Replaces: John Deere RE172447 O.D.: 6 7/8 (174.6) I.D.: 5 5/16 (134.9) One End Height: 10 7/8 (276.2)</p>
<p>PA4619</p> 	<p>Replacement for Ecolite Air Element in Disposable Housing Fits: Onan Generators Replaces: Donaldson C055003; Onan 1402680 O.D.: 5 1/2 (139.7) I.D.: 1 3/4 (44.4) One End Height: 5 3/8 (136.5)</p>	<p>PA4624</p> 	<p>Outer Air Element Fits: Kobelco Excavators Use With: PA4625 Replaces: Kobelco LQ11PU0001S002 O.D.: 9 7/32 (234.2) I.D.: 21/32 (16.7) & 5 27/32 (148.4) Height: 14 3/4 (374.7) A. Gskt: [1] Attached F. Gskt: [1] Included</p>
<p>RS4620</p> 	<p>Radial Seal Outer Air Element Fits: John Deere, Volvo Equipment Use With: RS4621 Replaces: Volvo 11110175; Donaldson P778905 O.D.: 9 9/32 (235.7) I.D.: 5 5/32 (131.0) One End Height: 18 19/32 (472.3)</p>	<p>PA4625</p> 	<p>Inner Air Element Fits Inside: PA4624 Fits: Kobelco Excavators Replaces: Kobelco LQ11PU0001S001 O.D.: 5 9/16 (141.3) I.D.: 21/32 (16.7) & 4 7/16 (112.7) Height: 12 29/32 (327.8) A. Gskt: [1] Attached F. Gskt: G103-N</p>
<p>RS4621</p> 	<p>Radial Seal Inner Air Element Fits Inside: RS4620 Fits: John Deere, Volvo Equipment Replaces: Volvo 11110176 O.D.: 5 1/4 (133.4) I.D.: 3 3/4 (95.3) One End Height: 17 7/8 (454.0)</p>	<p>PA4627</p> 	<p>Inner Air Element Fits Inside: PA2797 Replaces: Volvo V1114450; Donaldson P521692 O.D.: 8 1/4 (209.6) I.D.: 21/32 (16.7) & 7 3/32 (180.2) Height: 13 3/8 (339.7) A. Gskt: [1] Attached F. Gskt: [1] Included</p>

Measurements Are Shown In Inches And (Millimeters)

WARNING: These products can expose you to chemicals, including Diisononyl Phthalate, Carbon black extracts, Nickel, 1,3 Butadiene, Ethylene Oxide, Epichlorohydrin, which are known to the State of California to cause cancer, and Bisphenol, Ethylene Glycol, Ethylene Oxide, 1,3 Butadiene, Epichlorohydrin, which are known to the State of California to cause birth defects or other reproductive harm. For more information go to www.P65Warnings.ca.gov.

PA4628 Inner Air Element
Fits Inside: PA4656
Fits: Case Tractors
Replaces: Case A171254
O.D.: 4 3/32 (104.0)
 Flange 4 27/32 (123.0)
I.D.: 2 1/32 (16.7) & 3 5/8 (92.1)
Height: 13 19/32 (345.3)
A. Gskt: [1] Attached
F. Gskt: [1] Metal Washer



PA4633 Inner Air Element
Fits Inside: PA4632, RS5273
Fits: Kubota Excavators, Tractors
Replaces: Kubota 32721-58242
O.D.: 1 21/32 (42.1)
I.D.: 1 7/32 (31.0) One End
Height: 6 7/16 (163.5)
I.Gskt: [1] Included



RS4629 Radial Seal Inner Air Element
Fits Inside: RS4989
Fits: John Deere Dump Trucks; New Holland Equipment
Replaces: John Deere TT221378; Donaldson P781102
O.D.: 9 3/32 (231.0)
I.D.: 7 (177.8) One End
Height: 24 5/8 (625.5)



RS4634 Radial Seal Air Element
Notes: Features recessed closed end.
Fits: Mack Trucks
Replaces: Mack 57MD48M, 57MD320M; Donaldson EAF5114
O.D.: 9 9/32 (235.7)
I.D.: 5 25/32 (146.8) One End
Height: 25 1/2 (647.7)
Related To: RS4634XP (Extreme Performance Nano Version)



PA4630 Replacement for Ecolite Air Element in Disposable Housing
Fits: Motor Homes with Cummins Engine
Replaces: Farr 99842-009; Donaldson P537455
O.D.: 13 1/2 (342.9)
Inlet: 7
Outlet: 7 1/16
Height: 16 27/32 (427.8)



RS4634XP Extreme Performance Nano Air Element
Notes: Features recessed closed end.
Fits: Mack Trucks
Replaces: Donaldson DBA5114
O.D.: 9 9/32 (235.7)
I.D.: 5 25/32 (146.8) One End
Height: 25 1/2 (647.7)
Related To: RS4634 (Standard Version)



PA4631-FN Air Element with Fins
Fits: Komatsu Equipment
Replaces: Komatsu 8481-01-155
O.D.: 6 3/32 (154.8)
 Fins 7 3/4 (196.9)
I.D.: 3/4 (19.0) & 3 15/32 (88.1)
Height: 15 9/16 (395.3)
A. Gskt: [1] Attached



PA4635 Cab Air Element
Fits: John Deere Dozers, Motor Graders
Replaces: John Deere AT170037; Fleetguard AF25786
Length: 14 3/4 (374.7)
Width: 6 7/8 (174.6)
Height: 2 7/16 (61.9)
A. Gskt: [1] Attached



PA4632 Outer Air Element
Contains: Grease packet
Fits: Kubota Excavators, Tractors
Use With: PA4633
Replaces: Kubota 6A10082630, 6A10082632
O.D.: 3 17/32 (89.7)
I.D.: 1 25/32 (45.2) One End
Height: 6 15/16 (176.2)



RS4636 Radial Seal Outer Air Element
Fits: International Buses, Trucks
Use With: RS4637
Replaces: International 3532799-C1
O.D.: 10 1/4 (260.3)
I.D.: 7 15/16 (201.6) One End
Height: 15 29/32 (404.0)











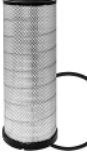

RS4637 Conical-Shaped Radial Seal Inner Air Element
Fits Inside: RS4636
Fits: International Buses, Trucks
Replaces: International 3532800-C1; Fleetguard AF25732
O.D.: 3 1/2 (88.9) to 8 1/32 (204.0)
I.D.: 5 1/32 (127.8) One End
Height: 15 11/32 (389.7)



Measurements Are Shown In Inches And (Millimeters)

WARNING: These products can expose you to chemicals, including Diisononyl Phthalate, Carbon black extracts, Nickel, 1,3 Butadiene, Ethylene Oxide, Epichlorohydrin, which are known to the State of California to cause cancer, and Bisphenol, Ethylene Glycol, Ethylene Oxide, 1,3 Butadiene, Epichlorohydrin, which are known to the State of California to cause birth defects or other reproductive harm. For more information go to www.P65Warnings.ca.gov.

<p>RS4638</p> 	<p>Radial Seal Outer Air Element Fits: Komatsu Equipment; Scania Trucks Use With: RS3871, RS4639 Replaces: Caterpillar 1421340; Komatsu 600-185-6110; Donaldson P777868; Fleetguard AF25627 O.D.: 12 9/32 (311.9) I.D.: 6 31/32 (177.0) One End Height: 20 9/16 (522.3) Related To: RS3870 (with Blank Band), RS3870XP (Extreme Performance)</p>	<p>PA4644</p> 	<p>Cab Air Element Fits: John Deere Tractors Replaces: John Deere RE67829 O.D.: 6 7/8 (174.6) I.D.: 2 1/32 (16.7) & 3 1/2 (88.9) Height: 12 13/32 (315.1) A. Gskt: [1] Attached F. Gskt: G103-N</p>
<p>RS4639</p> 	<p>Radial Seal Inner Air Element Contains: Flame Retardant Media Fits Inside: RS3870, RS3870XP, RS4638 Fits: Caterpillar Equipment Replaces: Caterpillar 142-1403 O.D.: 7 1/16 (179.4) I.D.: 5 11/16 (144.5) One End Height: 19 31/32 (507.2) Related To: RS3871 (without Flame Retardant Media)</p>	<p>RS4646</p> 	<p>Radial Seal Air Element Fits: Freightliner Trucks Replaces: Donaldson P537355 O.D.: 9 21/32 (245.3) I.D.: 3 3/32 (78.6) & 5 5/32 (131.0) Height: 24 27/32 (631.0) F. Gskt: [1] Included</p>
<p>PA4640-FN</p> 	<p>Air Element with Lid and Fins Fits: Caterpillar Excavators Replaces: Caterpillar 616434 O.D.: 6 3/32 (154.8) Lid 8 21/32 (219.9) I.D.: 2 1/32 (16.7) & 3 15/32 (88.1) Height: 12 1/2 (317.5) A. Gskt: [1] Attached F. Gskt: [1] Metal Washer</p>	<p>PA4647</p> 	<p>Air Element Replaces: Toyota 17801-58010 O.D.: 7 3/4 (196.9) I.D.: 3 1/4 (82.6) Height: 5 3/4 (146.0)</p>
<p>PA4641</p> 	<p>Air Element Replaces: Toyota 17801-67070 O.D.: 9 15/32 (240.5) I.D.: 4 11/32 (110.3) Height: 4 3/4 (120.7)</p>	<p>PA4648</p> 	<p>Air Element Replaces: Toyota 17801-67060; Fleetguard AF25584M O.D.: 8 5/8 (219.1) I.D.: 4 9/32 (108.7) One End Height: 5 11/16 (144.5)</p>
<p>RS4642</p> 	<p>Radial Seal Outer Air Element Fits: Volvo Trucks Use With: RS4643 Replaces: Volvo 20411815; Donaldson P605551 O.D.: 13 (330.2) I.D.: 9 1/8 (231.8) One End Height: 19 1/2 (495.3)</p>	<p>PA4649</p> 	<p>Air Element Replaces: Toyota 17801-54180 O.D.: 8 5/8 (219.1) I.D.: 4 5/16 (109.5) Height: 4 13/16 (122.2)</p>
<p>RS4643</p> 	<p>Radial Seal Inner Air Element Fits Inside: RS4642 Fits: Volvo Trucks Replaces: Volvo 20411816; Donaldson P605552 O.D.: 8 17/32 (216.7) I.D.: 7 11/16 (195.3) One End Height: 18 1/2 (469.9)</p>	<p>PA4650-FN</p> 	<p>Outer Air Element with Fins Fits: Samsung Excavators Use With: PA1912 Replaces: Volvo 991240700 O.D.: 7 15/16 (201.6) Fins 10 (254.0) I.D.: 1 1/16 (17.5) & 5 3/8 (136.5) Height: 16 1/2 (419.1) A. Gskt: [1] Attached F. Gskt: [1] Metal Washer</p>

Measurements Are Shown In Inches And (Millimeters)

WARNING: These products can expose you to chemicals, including Diisononyl Phthalate, Carbon black extracts, Nickel, 1,3 Butadiene, Ethylene Oxide, Epichlorohydrin, which are known to the State of California to cause cancer, and Bisphenol, Ethylene Glycol, Ethylene Oxide, 1,3 Butadiene, Epichlorohydrin, which are known to the State of California to cause birth defects or other reproductive harm. For more information go to www.P65Warnings.ca.gov.

PA4651



Outer Air Element
Fits: Kubota Tractors
Replaces: Kubota 32751-96260
O.D.: 4 3/32 (104.0)
 Flange 5 3/4 (146.0)
I.D.: 19/32 (15.1) & 2 1/2 (63.5)
Height: 10 3/8 (263.5)
A. Gskt: [2] Attached

PA4657



Replacement for Ecolite Air Element in Disposable Housing
Fits: Pierce Fire Trucks
Replaces: Farr 99842-005
O.D.: 13 1/2 (342.9)
Inlet: 7
Outlet: 7
Height: 25 19/32 (650.1)

PA4652

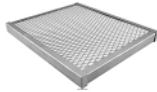

Cab Air Element
Fits: Caterpillar Equipment
Replaces: Caterpillar 6C9226; Donaldson P777576; Fleetguard AF25713
Length: 11 13/16 (300.0)
Width: 9 13/16 (249.2)
Height: 1 1/16 (27.0)

PA4659

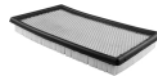

Cab Air Element
Notes: Uses 2 filters per application.
Fits: Caterpillar Loaders, Telehandlers
Replaces: Caterpillar 116-7376; Donaldson P609445
Length: 12 1/2 (317.5)
Width: 7 1/16 (179.4)
Height: 1 7/16 (36.5)

PA4653



Replacement for Ecolite Air Filter in Disposable Housing
Replaces: Farr 400820-014
O.D.: 11 1/32 (280.2)
Inlet: 7
Outlet: 7
Height: 19 13/16 (503.2)

PA4660



Air Element
Replaces: Donaldson P527566
O.D.: 13 7/8 (352.4)
I.D.: 9 1/2 (241.3) One End
Height: 13 1/2 (342.9)
A. Gskt: [1] Attached
F. Gskt: [1] Included

PA4654 KIT

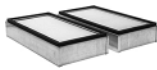

Set of 2 Cab Air Elements
Notes: Uses 2 filters per application.
Fits: Case Tractors
Replaces: Case 240883A1, 303748A1
Each Filter:
Length: 14 1/8 (358.8)
Width: 7 1/8 (181.0)
Height: 2 9/16 (65.1)
A. Gskt: [1] Attached Each Filter

PA4661



Wire Supported Cotton Polyester Industrial Air Element
Fits: Industrial Applications
Replaces: Airguard DP40-203; Farr 49880-002
Length: 19 1/2 (495.3)
Width: 19 1/2 (495.3)
Height: 1 3/4 (44.4)

PA4655



Replacement for Ecolite Air Filter in Disposable Housing
Fits: Freightliner Buses, Trucks
Replaces: Farr 114880-005 Series; Fleetguard AH19057
O.D.: 8 3/32 (205.6)
Inlet: 4
Outlet: 6
Height: 17 3/16 (436.6)

PA4662

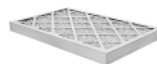

Wire Supported Cotton Polyester Industrial Air Element
Fits: Industrial Applications
Replaces: Airguard DP40-202; Farr 49880-004
Length: 24 1/2 (622.3)
Width: 15 1/2 (393.7)
Height: 1 3/4 (44.4)

PA4663



Wire Supported Cotton Polyester Industrial Air Element
Fits: Industrial Applications
Replaces: Airguard DP40-210; Farr 49880-006
Length: 23 3/8 (593.7)
Width: 11 3/8 (288.9)
Height: 1 3/4 (44.4)

PA4656



Air Element with Lift Bar
Fits: Case Tractors
Use With: PA4628
Replaces: Case A171253
O.D.: 7 15/16 (201.6)
I.D.: 21/32 (16.7) & 4 5/8 (117.5)
Height: 15 1/2 (393.7)
A. Gskt: [1] Attached
F. Gskt: [1] Included



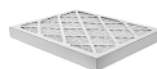







PA4664



Wire Supported Cotton Polyester Industrial Air Element
Fits: Industrial Applications
Replaces: Airguard DP40-201; Farr 49880-001
Length: 19 1/2 (495.3)
Width: 15 1/2 (393.7)
Height: 1 3/4 (44.4)

Measurements Are Shown In Inches And (Millimeters)

WARNING: These products can expose you to chemicals, including Diisononyl Phthalate, Carbon black extracts, Nickel, 1,3 Butadiene, Ethylene Oxide, Epichlorohydrin, which are known to the State of California to cause cancer, and Bisphenol, Ethylene Glycol, Ethylene Oxide, 1,3 Butadiene, Epichlorohydrin, which are known to the State of California to cause birth defects or other reproductive harm. For more information go to www.P65Warnings.ca.gov.

<p>PA4665-FN</p> 	<p>Outer Air Element with Fins Fits: Kubota Excavators, Tractors Use With: PA4666 Replaces: Kubota 6C040-94240 O.D.: 3 5/16 (84.1) Fins 4 1/4 (108.0) I.D.: 2 1/32 (16.7) & 2 1/8 (54.0) Height: 7 5/32 (181.8) A. Gskt: [1] Attached F. Gskt: [1] Included</p>	<p>RS4676</p> 	<p>Radial Seal Outer Air Element Fits: John Deere Dozers, Loaders Use With: RS4677 Replaces: John Deere AT225338; Donaldson P600072 O.D.: 9 9/32 (235.7) I.D.: 5 5/32 (131.0) One End Height: 17 (431.8)</p>
<p>PA4666</p> 	<p>Inner Air Element Fits Inside: PA4665-FN Fits: Kubota Excavators, Tractors Replaces: Kubota 6C040-94350; Fleetguard AF25702 O.D.: 2 5/32 (54.8) I.D.: 5/8 (15.9) & 1 17/32 (38.9) Height: 6 1/4 (158.8)</p>	<p>RS4677</p> 	<p>Radial Seal Inner Air Element Fits Inside: RS4676 Fits: John Deere Dozers, Loaders Replaces: John Deere AT225339; Donaldson P600076 O.D.: 5 1/4 (133.4) I.D.: 3 3/4 (95.3) One End Height: 16 13/32 (416.7)</p>
<p>RS4672</p> 	<p>Radial Seal Outer Air Element Fits: Chevrolet, GMC, Isuzu Trucks Use With: RS4673 Replaces: GMC 88937525; ACDelco A2031C O.D.: 7 7/8 (200.0) I.D.: 4 3/4 (120.7) One End Height: 18 1/2 (469.9)</p>	<p>RS4678</p> 	<p>Radial Seal Outer Air Element Fits: Manitou Equipment Use With: RS4679 Replaces: Manitou 563416; Fleetguard AF25795 O.D.: 6 1/2 (165.1) I.D.: 3 9/16 (90.5) One End Height: 13 7/16 (341.3)</p>
<p>RS4673</p> 	<p>Radial Seal Inner Air Element Fits Inside: RS4672 Fits: Chevrolet, GMC, Isuzu Trucks Replaces: GMC 88937548; ACDelco A2035C O.D.: 4 7/16 (112.7) I.D.: 3 5/16 (84.1) One End Height: 17 23/32 (450.1)</p>	<p>RS4679</p> 	<p>Radial Seal Inner Air Element Fits Inside: RS4678, RS5641 Fits: Manitou Equipment Replaces: Manitou 563415; Fleetguard AF25794 O.D.: 3 21/32 (92.9) I.D.: 2 7/8 (73.0) One End Height: 13 1/8 (333.4)</p>
<p>PA4674-FN</p> 	<p>Air Element with Lid and Fins Replaces: Toyota 17807-23800-71 O.D.: 5 5/16 (134.9) Lid 7 13/16 (198.4) I.D.: 15/32 (11.9) & 3 5/16 (84.1) Height: 11 17/32 (292.9) A. Gskt: [2] Attached</p>	<p>RS4680</p> 	<p>Radial Seal Air Element Fits: Lister Petter Engines Replaces: Lister 624-50610; Woodgate WGA1652 O.D.: 5 23/32 (145.3) I.D.: 3 (76.2) One End Height: 12 5/8 (320.7)</p>
	<p>PA4681</p> 	<p>Cab Air Element Fits: Volvo Trucks Replaces: Volvo 20435801; Donaldson P606555 Length: 12 3/4 (323.8) Width: 11 9/16 (293.7) Height: 1 1/8 (28.6)</p>	

Measurements Are Shown In Inches And (Millimeters)

WARNING: These products can expose you to chemicals, including Diisononyl Phthalate, Carbon black extracts, Nickel, 1,3 Butadiene, Ethylene Oxide, Epichlorohydrin, which are known to the State of California to cause cancer, and Bisphenol, Ethylene Glycol, Ethylene Oxide, 1,3 Butadiene, Epichlorohydrin, which are known to the State of California to cause birth defects or other reproductive harm. For more information go to www.P65Warnings.ca.gov.

<p>PA4682 Cab Air Element Fits: Volvo Trucks Replaces: Volvo 3948712 Length: 13 7/16 (341.3) Width: 8 3/8 (212.7) Height: 25/32 (19.8)</p> 	<p>PA4695 Oblong Air Element with Foam Wrap Fits: Honda Engines Replaces: Honda 17210-ZE8-003, 17210-ZE8-013; Woodgate WGA1159 O.D.: 3 1/8 (79.4) to 5 3/32 (129.4) I.D.: 1 3/32 (27.8) & 3 9/16 (90.5) Height: 3 1/8 (79.4) Grommets: [1] Attached</p> 
<p>PA4683 Outer Air Element with Lift Bar Fits: New Holland Tractors Use With: PA3492 Replaces: New Holland 82011402, 82027153 O.D.: 7 3/16 (182.6) Flange 8 21/32 (219.9) I.D.: 15/32 (11.9) & 3 27/32 (97.6) Height: 13 13/32 (340.5) A. Gskt: [2] Attached</p> 	<p>PA4696 FOAM Foam Blanket Notes: OBSOLETE. Availability Limited to Dealer Stock. Width: 3 3/16 (81.0) Height: 7/32 (5.6)</p> 
<p>PA4689 Oblong Air Element Notes: OBSOLETE. Availability Limited to Dealer Stock. Replaces: Woodgate WGA1638 O.D.: 3 11/16 (93.7) to 5 25/32 (146.8) I.D.: 2 3/32 (53.2) & 4 5/32 (105.6) Height: 3 7/32 (81.8)</p> 	<p>PA4697-FN Outer Air Element with Fins Fits: Manitou Telehandlers; New Holland Equipment Use With: PA2419 Replaces: New Holland 85807057; Woodgate WGA176K O.D.: 6 1/16 (154.0) Fins 7 17/32 (191.3) I.D.: 21/32 (16.7) & 3 7/16 (87.3) Height: 15 3/32 (383.4) A. Gskt: [1] Attached F. Gskt: [1] Included</p> 
<p>PA4692 Inner Air Element Fits Inside: PA3852-FN Replaces: Woodgate WGA1147S O.D.: 3 13/32 (86.5) Flange 4 5/32 (105.6) I.D.: 11/16 (17.5) & 2 5/16 (58.7) Height: 12 (304.8) A. Gskt: [1] Attached</p> 	<p>PA4698 Oblong Air Element with Foam Wrap Fits: Honda Engines Replaces: Honda 17210-ZE7-003, 17210-ZE7-013; Woodgate WGA1177 O.D.: 2 1/2 (63.5) to 7 17/32 (191.3) I.D.: 1 1/16 (27.0) & 6 1/32 (153.2) Height: 1 15/16 (49.2) A. Gskt: [1] Attached Grommets: [2] Attached</p> 
<p>PA4693 Air Element Fits: Volkswagen Eurovan Replaces: Volkswagen 44129620; Woodgate WGA1148 O.D.: 6 3/8 (161.9) I.D.: 3 11/16 (93.7) Height: 9 11/32 (237.3)</p> 	<p>CA4700 Channel Flow Air Element Fits: Freightliner Buses, Trucks Use With: PA4701 Replaces: Donaldson P548070, P607955; Fleetguard AF26154 O.D.: 9 29/32 (251.6) Flange 12 25/32 (324.6) Height: 8 1/32 (204.0) A. Gskt: [1] Attached Related To: CA5420 (Flame Retardant Media Version)</p> 
<p>PA4694 Air Element with Foam Wrap Fits: Honda Engines Replaces: Honda 17210-ZG3-003, 17210-ZG3-505, 17210-ZG3-801; Woodgate WGA1157 O.D.: 4 13/16 (122.2) I.D.: 1/4 (6.4) & 2 5/16 (58.7) Height: 2 11/16 (68.3) A. Gskt: [1] Attached Grommets: [1] Attached</p> 	<p>PA4701 Channel Flow Air Secondary Element Fits: Freightliner Buses, Trucks Use With: CA4700 Replaces: Donaldson P544432, P616400; Fleetguard AF26153 O.D.: 9 13/32 (238.9) Height: 31/32 (24.6) A. Gskt: [1] Attached</p> 

Measurements Are Shown In Inches And (Millimeters)

WARNING: These products can expose you to chemicals, including Diisononyl Phthalate, Carbon black extracts, Nickel, 1,3 Butadiene, Ethylene Oxide, Epichlorohydrin, which are known to the State of California to cause cancer, and Bisphenol, Ethylene Glycol, Ethylene Oxide, 1,3 Butadiene, Epichlorohydrin, which are known to the State of California to cause birth defects or other reproductive harm. For more information go to www.P65Warnings.ca.gov.

CA4702 Channel Flow Air Element
Fits: John Deere Tractors
Use With: PA4704
Replaces: John Deere AL119839, AL172780; Donaldson P606119; Fleetguard AF26157
O.D.: 4 7/8 (123.8)
to 12 7/32 (310.4)
Height: 7 11/32 (186.5)
A. Gskt: [1] Included



CA4703 Channel Flow Air Element
Fits: John Deere Sprayers, Tractors
Use With: PA4704
Replaces: John Deere AL150285, AL172781; Donaldson P606120; Fleetguard AF26156
O.D.: 4 7/8 (123.8)
to 12 7/32 (310.4)
Height: 11 3/16 (284.2)
A. Gskt: [1] Included



PA4704 Channel Flow Air Secondary Element
Notes: Sometimes used with CA5278, Channel Flow Air Element.
Fits: John Deere Tractors
Use With: CA4702, CA4703
Replaces: John Deere AL150288; Donaldson P606121; Fleetguard AF26155; Wix 42795
O.D.: 4 9/32 (108.7)
to 11 25/32 (299.2)
Height: 1 13/16 (46.0)
A. Gskt: [1] Included



PA4705 Air Element
Replaces: M.A.N. 45.0095.3105; Woodgate WGA1282
O.D.: 2 17/32 (64.3)
I.D.: 1 1/2 (38.1) One End
Height: 2 23/32 (69.1)
F. Gskt: [1] Included



PA4706 Air Element
Replaces: Mann & Hummel C1337; Woodgate WGA1286
O.D.: 5 (127.0)
I.D.: 2 17/32 (64.3)
Height: 4 15/16 (125.4)
Grommets: [2] Included



PA4707 Air Element
Replaces: M.A.N. 45.07554.166; Woodgate WGA1287
O.D.: 9 1/2 (241.3)
I.D.: 6 11/32 (161.1)
Height: 3 15/32 (88.1)



PA4708 Air Element
Replaces: M.A.N. 45.02155.104; Woodgate WGA1288
O.D.: 3 7/8 (98.4)
I.D.: 2 3/8 (60.3) One End
Height: 2 29/32 (73.8)
A. Gskt: [1] Attached



PA4709 Outer Air Element
Use With: PA2419
Replaces: J.C. Bamford 32/914700; Woodgate WGA1307
O.D.: 7 5/8 (193.7)
Flange 8 3/16 (208.0)
I.D.: 19/32 (15.1) & 3 11/16 (93.7)
Height: 15 21/32 (397.7)
A. Gskt: [1] Attached, [1] Wing Nut



PA4711 Air Element
Replaces: Hydrovane 52438; Woodgate WGA1318
O.D.: 13 23/32 (348.5)
I.D.: 11 5/8 (295.3)
Height: 4 3/16 (106.4)



PA4713 Air Element
Replaces: Ceccato 640110; Woodgate WGA1339
O.D.: 6 5/16 (160.3)
I.D.: 4 1/2 (114.3)
Height: 4 25/32 (121.4)



PA4714 Panel Air Element
Notes: OBSOLETE. Availability Limited to Dealer Stock.
Replaces: Leyland ABU8516; Fleetguard AF4049; Woodgate WGA135
Length: 12 3/4 (323.8)
Width: 4 7/8 (123.8)
Height: 1 7/32 (31.0)



PA4715 Air Element
Replaces: Becker 84040910; Woodgate WGA1354
O.D.: 5 29/32 (150.0)
I.D.: 3 15/32 (88.1)
Height: 4 31/32 (126.2)



PA4716 Air Element
Replaces: Busch 532013; Woodgate WGA1392
O.D.: 5 (127.0)
I.D.: 2 17/32 (64.3)
Height: 6 3/32 (154.8)
F. Gskt: [2] Included



Measurements Are Shown In Inches And (Millimeters)

WARNING: These products can expose you to chemicals, including Diisononyl Phthalate, Carbon black extracts, Nickel, 1,3 Butadiene, Ethylene Oxide, Epichlorohydrin, which are known to the State of California to cause cancer, and Bisphenol, Ethylene Glycol, Ethylene Oxide, 1,3 Butadiene, Epichlorohydrin, which are known to the State of California to cause birth defects or other reproductive harm. For more information go to www.P65Warnings.ca.gov.

PA4720 Air Element with Attached Spring
Replaces: Rietschle 731143; Woodgate WGA1412
O.D.: 2 17/32 (64.3)
I.D.: 1 1/2 (38.1)
Height: 7 27/32 (199.2)
A. Gskt: [1] Attached
Spring: [1] Attached



PA4727 Air Element with Foam Wrap
Notes: OBSOLETE. Availability Limited to Dealer Stock.
Fits: Robin Engines
Replaces: Robin 1573620101; Woodgate WGA1565
O.D.: 3 17/32 (89.7)
I.D.: 2 7/16 (61.9)
Height: 2 3/8 (60.3)
A. Gskt: [2] Attached



PA4730 Panel Air Element
Fits: Ruggerini Engines
Replaces: Ruggerini 17540; Woodgate WGA1569
Length: 6 9/32 (159.5)
Width: 6 3/16 (157.2)
Height: 1 17/32 (38.9)



PA4731 Oblong Air Element
Notes: OBSOLETE. Availability Limited to Dealer Stock.
Fits: Wacker Equipment
Replaces: Wacker 95711; Woodgate WGA1570
O.D.: 2 3/4 (69.9)
 4 25/32 (121.4)
I.D.: 1 29/32 (48.4) & 3 15/16 (100.0)
Height: 1 7/32 (31.0)



PA4732 Air Element
Replaces: Petter 334643; Woodgate WGA1574
O.D.: 3 13/16 (96.8)
I.D.: 1 31/32 (50.0)
Height: 4 3/16 (106.4)



PA4733 Air Element with Foam Wrap
Fits: Lombardini 15LD315 Engine
Replaces: Lombardini 196.2175.120; Woodgate WGA1575
O.D.: 4 11/32 (110.3)
I.D.: 5/8 (15.9) & 2 7/16 (61.9)
Height: 2 15/16 (74.6)
A. Gskt: [1] Attached
Grommets: [1] Attached



PA4734 Panel Air Element with Foam Pad
Replaces: Kubota 12812-11210; Woodgate WGA1576
Length: 4 9/32 (108.7)
Width: 3 29/32 (99.2)
Height: 1 3/8 (34.9)
O-Ring: [1] Included



PA4735 Foam Air Filter
Notes: OBSOLETE. Availability Limited to Dealer Stock.
Fits: Honda G100, G110 Engines
Replaces: Honda 17211-896-000; Woodgate WGA1578
Length: 3 7/8 (98.4)
Width: 3 3/32 (78.6)
Height: 15/16 (23.8)



PA4736 FOAM Foam Blanket
Fits: Exmark Lawn & Garden Tractors
O.D.: 6 19/32 (167.5)
I.D.: 6 3/32 (154.8)
Height: 2 5/32 (54.8)



PA4737 Air Element with Foam Wrap
Fits: Kubota OC60E, OC95E Engines
Replaces: Kubota 11460-11180; Woodgate WGA1583
O.D.: 4 13/16 (122.2)
 Boot 4 31/32 (126.2)
I.D.: 1/4 (6.4) & 2 5/16 (58.7)
Height: 2 23/32 (69.1)
A. Gskt: [2] Attached



PA4738 Foam Oblong Air Element
Notes: OBSOLETE. Availability Limited to Dealer Stock.
Fits: Robin EC08, EY08, EY15D Engines
Replaces: Robin 2273600203; Woodgate WGA1593
O.D.: 3 9/32 (83.3)
 To 4 23/32 (119.9)
Height: 1 1/4 (31.8)



PA4740 Inner Air Element
Fits Inside: PA1690-FN
Replaces: Petter 397080; Woodgate WGA15S
O.D.: 2 13/32 (61.1)
 Flange 2 3/4 (69.9)
I.D.: 21/32 (16.7) & 2 (50.8)
Height: 9 1/32 (229.4)
A. Gskt: [2] Attached













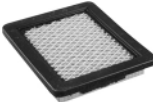

PA4741 Air Element
Notes: OBSOLETE. Availability Limited to Dealer Stock.
Fits: Lister-Petter TR3, TS3 Engines
Replaces: Lister 366-07723; Woodgate WGA1601
O.D.: 5 29/32 (150.0)
I.D.: 3 13/32 (86.5)
Height: 3 5/8 (92.1)













Measurements Are Shown In Inches And (Millimeters)

WARNING: These products can expose you to chemicals, including Diisononyl Phthalate, Carbon black extracts, Nickel, 1,3 Butadiene, Ethylene Oxide, Epichlorohydrin, which are known to the State of California to cause cancer, and Bisphenol, Ethylene Glycol, Ethylene Oxide, 1,3 Butadiene, Epichlorohydrin, which are known to the State of California to cause birth defects or other reproductive harm. For more information go to www.P65Warnings.ca.gov.

<p>PA4750 Panel Air Element  Fits: Briggs & Stratton Engines Replaces: Briggs & Stratton 494511; Woodgate WGA1619 Length: 6 31/32 (177.0) Width: 3 15/32 (88.1) Height: 1 9/32 (32.5)</p>	<p>PA4760 Oval Air Element with Foam Wrap  Fits: Honda GXV390 Engines Replaces: Honda 17211-ZF5-001; Woodgate WGA1651 O.D.: 2 15/16 (74.6) to 5 9/32 (134.1) I.D.: 1 1/32 (8.7) & 3 1/2 (88.9) Height: 3 7/16 (87.3)</p>
<p>PA4753 Inner Air Element  Fits Inside: PA2360-FN, PA4865-FN Replaces: Johnson Sweepers 13086; Woodgate WGA162S O.D.: 2 23/32 (69.1) Flange 3 17/32 (89.7) I.D.: 21/32 (16.7) & 2 13/32 (61.1) Height: 13 31/32 (354.8) F. Gskt: [1] Included</p>	<p>PA4763 Conical-Shaped Air Element with Foam Wrap  Fits: Robin EH25, EY28 Engines Replaces: Robin 2343260407; Woodgate WGA1672 O.D.: 2 9/16 (65.1) to 4 21/32 (118.3) I.D.: 2 3/4 (69.9) One End Height: 3 9/32 (83.3) A. Gskt: [1] Attached</p>
<p>PA4754 Panel Air Element  Notes: Can be used with PA4911 Foam Pad. Fits: Honda Engines Replaces: Honda 17211-ZL8-A000; Woodgate WGA1635 Length: 5 5/32 (131.0) Width: 4 1/2 (114.3) Height: 29/32 (23.0)</p>	<p>PA4764 Air Element  Replaces: Petter 340660; Woodgate WGA1674 O.D.: 4 7/32 (107.2) I.D.: 2 1/32 (51.6) Height: 4 5/32 (105.6)</p>
<p>PA4755 Oval Air Element  Contains: 7/16 Inch bolt hole on closed end Fits: Partner K950, K1250 Saws Replaces: Partner 506231801; Woodgate WGA1639 O.D.: 3 15/16 (100.0) to 6 3/32 (154.8) I.D.: 2 1/32 (51.6) & 4 1/16 (103.2) Height: 2 19/32 (65.9)</p>	<p>PA4766 Air Element  Replaces: Kubota 16616-11013; Woodgate WGA1697 O.D.: 4 3/32 (104.0) I.D.: 21/32 (16.7) & 2 15/32 (62.7) Height: 10 1/4 (260.3) A. Gskt: [1] Attached F. Gskt: [1] Included</p>
<p>PA4756 Foam Air Filter  Notes: OBSOLETE. Availability Limited to Dealer Stock. [2] Small holes and [1] large, irregular hole cut in pad. Fits: Partner K1200 Saws Replaces: Partner 506231901; Woodgate WGA1640 Length: 10 13/32 (264.3) Width: 5 5/8 (142.9) Height: 11/16 (17.5)</p>	<p>PA4769 Oblong Air Element with Foam Wrap  Fits: Toro Lawn & Garden Tractors with Kawasaki Engines Replaces: Kawasaki 11013-2110; Woodgate WGA1708 O.D.: 2 7/8 (73.0) to 6 5/32 (156.4) I.D.: 1 13/32 (35.7) & 4 23/32 (119.9) Height: 3 3/16 (81.0) A. Gskt: [2] Attached</p>
<p>PA4758 Air Element  Fits: Rig Master Auxilliary Power Units Replaces: Atlas Copco 1613-9001-00; Woodgate WGA1647 O.D.: 3 31/32 (100.8) I.D.: 2 21/32 (67.5) Height: 3 1/8 (79.4) A. Gskt: [2] Attached</p>	<p>PA4773 Oval Air Element  Notes: Has 5/16 In. bolt hole on closed end. Fits: Ford Lawn & Garden Tractors Replaces: Briggs & Stratton 493909; Woodgate WGA1714 O.D.: 2 7/8 (73.0) to 7 1/4 (184.2) I.D.: 15/16 (23.8) & 3 29/32 (99.2) Height: 3 1/32 (77.0)</p>

Measurements Are Shown In Inches And (Millimeters)

WARNING: These products can expose you to chemicals, including Diisononyl Phthalate, Carbon black extracts, Nickel, 1,3 Butadiene, Ethylene Oxide, Epichlorohydrin, which are known to the State of California to cause cancer, and Bisphenol, Ethylene Glycol, Ethylene Oxide, 1,3 Butadiene, Epichlorohydrin, which are known to the State of California to cause birth defects or other reproductive harm. For more information go to www.P65Warnings.ca.gov.

<p>RS4775 Radial Seal Air Element Fits: M.A.N. Trucks Replaces: M.A.N. 81.08304.0087; Fleetguard AF25496; Woodgate WGA1743 O.D.: 9 21/32 (245.3) I.D.: 4 23/32 (119.9) One End Height: 15 (381.0)</p> 	<p>PA4802 Air Element Fits: Carrier Refrigeration Units Replaces: Carrier 30-0043022; Fleetguard AF25888; Woodgate WGA1869 O.D.: 4 1/8 (104.8) Top 4 15/32 (113.5) I.D.: 2 21/32 (67.5) One End Height: 10 5/32 (258.0)</p> 
<p>PA4778 Air Element Replaces: Woodgate WGA1758 O.D.: 2 29/32 (73.8) I.D.: 1 19/32 (40.5) Height: 1 21/32 (42.1)</p> 	<p>RS4803 Radial Seal Air Element Replaces: Kubota T0270-16321; Woodgate WGA1872 O.D.: 4 7/32 (107.2) I.D.: 2 5/32 (54.8) One End Height: 9 19/32 (243.7)</p> 
<p>PA4781 Air Element Replaces: Samsung 60131062; Woodgate WGA1777 O.D.: 7 15/16 (201.6) I.D.: 17/32 (13.5) & 4 31/32 (126.2) Height: 3 13/16 (96.8)</p> 	<p>RS4804 Radial Seal Air Element Fits: Massey Ferguson Equipment Replaces: Iseki 167510421300; Woodgate WGA1873 O.D.: 3 3/4 (95.3) I.D.: 1 21/32 (42.1) Height: 6 15/16 (176.2)</p> 
<p>PA4793 Panel Air Element Fits: Ford European Light-Duty Trucks Replaces: Motorcraft EFA184; Woodgate WGA1835 Length: 11 3/32 (281.8) Width: 7 1/8 (181.0) Height: 2 9/32 (57.9)</p> 	<p>RS4806 Radial Seal Air Element Fits: Mitsubishi Trucks Replaces: Mitsubishi ME017246; Woodgate WGA1882 O.D.: 9 1/8 (231.8) I.D.: 4 23/32 (119.9) One End Height: 11 7/32 (285.0)</p> 
<p>RS4794 Radial Seal Air Element Fits: DAF Trucks Replaces: Leyland ACHD040; Fleetguard AF25478; Woodgate WGA1837 O.D.: 8 1/8 (206.4) I.D.: 4 3/16 (106.4) One End Height: 20 7/8 (530.2)</p> 	<p>PA4809 Inner Air Element Fits Inside: PA2813 Fits: Scania Trucks Replaces: Scania 397813; Fleetguard AF4727; Woodgate WGA458S O.D.: 5 15/16 (150.8) Flange 6 1/4 (158.8) I.D.: 21/32 (16.7) & 5 11/16 (144.5) Height: 14 25/32 (375.4)</p> 
<p>PA4795 Air Element with Lid Replaces: Iseki 157210325000; Woodgate WGA1852 O.D.: 4 3/32 (104.0) Lid 5 7/8 (149.2) I.D.: 9/16 (14.3) & 2 15/32 (62.7) Height: 10 3/8 (263.5) A. Gskt: [2] Attached</p> 	

Measurements Are Shown In Inches And (Millimeters)

WARNING: These products can expose you to chemicals, including Diisononyl Phthalate, Carbon black extracts, Nickel, 1,3 Butadiene, Ethylene Oxide, Epichlorohydrin, which are known to the State of California to cause cancer, and Bisphenol, Ethylene Glycol, Ethylene Oxide, 1,3 Butadiene, Epichlorohydrin, which are known to the State of California to cause birth defects or other reproductive harm. For more information go to www.P65Warnings.ca.gov.

<p>PA4813 Air Element Replaces: CompAir 982621015; Woodgate WGA639 O.D.: 6 3/16 (4 13/16) I.D.: 4 13/16 (122.2) Height: 5 19/32 (142.1)</p> 	<p>PA4827 Inner Air Element Fits Inside: PA3848-FN Fits: Manitou Equipment Replaces: New Holland 85807052; Fleetguard AF25321; Woodgate WGA964S O.D.: 3 11/32 (84.9) Flange 4 3/16 (106.4) I.D.: 23/32 (18.3) & 2 15/16 (74.6) Height: 11 7/32 (285.0) A. Gskt: [1] Attached</p> 
<p>PA4819 Air Element Fits: Farymann Marine Engines; Wacker Equipment Replaces: Farymann 5410522; Fleetguard AF25433; Woodgate WGA925 O.D.: 3 27/32 (97.6) to 4 3/32 (104.0) I.D.: 1 13/32 (35.7) Height: 5 3/16 (131.8) Grommets: [1] Attached</p> 	<p>PA4829 Conical-Shaped Air Element with Foam Wrap Fits: Robin Engines Replaces: Robin 2053600404; Woodgate WGA967 O.D.: 2 15/32 (62.7) Flange 4 1/4 (108.0) I.D.: 2 1/4 (57.2) Height: 2 3/8 (60.3) A. Gskt: [1] Attached</p> 
<p>PA4820 Oval Air Element with Foam Wrap Fits: Dynapac Equipment; Honda Engines Replaces: Honda 17210-ZE1-822; Fleetguard AF25472; Woodgate WGA935 O.D.: 2 29/32 (73.8) to 3 31/32 (100.8) I.D.: 1/4 (6.4) & 1 1/4 (31.8) Height: 2 11/16 (68.3) Grommets: [1] Attached</p> 	<p>PA4830 Air Element Fits: Robin Engines Replaces: Robin 2433260008; Woodgate WGA969 O.D.: 3 15/16 (100.0) I.D.: 1/4 (6.4) & 2 23/32 (69.1) Height: 2 3/32 (53.2)</p> 
<p>PA4823 Conical-Shaped Air Element with Foam Wrap Fits: Robin Engines Replaces: Robin 2073260107; Woodgate WGA944 O.D.: 2 15/32 (62.7) to 4 5/32 (105.6) I.D.: 2 13/16 (71.4) One End Height: 3 7/32 (81.8) A. Gskt: [1] Attached</p> 	<p>PA4833-FN Air Element with Lid and Fins Fits: Hitachi Excavators Replaces: Hitachi 4294845; Fleetguard AF25200K; Woodgate WGA982K O.D.: 3 5/16 (84.1) Lid 5 1/32 (127.8) I.D.: 7/16 (11.1) & 1 13/16 (46.0) Height: 7 3/8 (187.3) A. Gskt: [1] Attached</p> 
<p>PA4824 Air Element Fits: Yanmar Engines, Generators Replaces: Yanmar 114250-12580; Fleetguard AF25607; Woodgate WGA948 O.D.: 3 15/16 (100.0) Flange 4 1/8 (104.8) I.D.: 2 1/8 (54.0) One End Height: 1 25/32 (45.2) Grommets: [1] Attached</p> 	<p>PA4834-FN Air Element with Fins Replaces: Gehl 49140111110; Woodgate WGA999K O.D.: 4 3/32 (104.0) Fins 5 1/8 (130.2) I.D.: 21/32 (16.7) & 2 15/32 (62.7) Height: 6 1/32 (153.2) A. Gskt: [1] Attached F. Gskt: [1] Included</p> 
<p>PA4825 Air Element Replaces: Orenstein & Koppel 1499267; Fleetguard AF4065; Woodgate WGA95 O.D.: 5 7/16 (138.1) Boot 6 15/32 (164.3) I.D.: 2 27/32 (72.2) One End Height: 15 5/8 (396.9) A. Gskt: [1] Attached</p> 	<p>PA4848 Air Element Replaces: Woodgate WGD800020 O.D.: 7 1/32 (178.6) I.D.: 5 7/16 (138.1) Height: 5 5/8 (142.9)</p> 

Measurements Are Shown In Inches And (Millimeters)

WARNING: These products can expose you to chemicals, including Diisononyl Phthalate, Carbon black extracts, Nickel, 1,3 Butadiene, Ethylene Oxide, Epichlorohydrin, which are known to the State of California to cause cancer, and Bisphenol, Ethylene Glycol, Ethylene Oxide, 1,3 Butadiene, Epichlorohydrin, which are known to the State of California to cause birth defects or other reproductive harm. For more information go to www.P65Warnings.ca.gov.

PA4852 Panel Air Element
Fits: Stihl TS400 Chain Saws
Use With: PA4852 FOAM; PA4853
Replaces: Stihl 42231410300; Fleetguard AF25855; Woodgate WGA1187
Length: 5 13/32 (137.3)
Width: 3 3/8 (85.7)
Height: 1 13/16 (46.0)



PA4852 FOAM Foam Blanket for PA4852
Notes: Has [2] holes drilled through foam blanket.
Fits: Stihl TS400 Chain Saws
Use With: PA4852
Width: 3 5/32 (80.2)
Height: 3/4 (19.0)



PA4853 Air Element
Contains: Tube on one end
Fits: Stihl TS400 Chain Saws
Use With: PA4852
Replaces: Stihl 42231401800; Woodgate WGA1187S
Length: 4 5/8 (117.5)
Width: 2 11/16 (68.3)
Height: 1 5/32 (29.4)

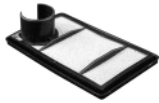

PA4854 Panel Air Element
Fits: Makita Saws
Use With: PA4854 FOAM; PA4855
Replaces: Makita 394173010; Woodgate WGA1568
Length: 4 1/8 (104.8)
Width: 3 5/32 (80.2)
Height: 2 5/16 (58.7)

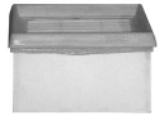

PA4855 Plastic Mesh Secondary Air Element
Fits: Makita Saws
Use With: PA4854
Replaces: Makita 394173020; Woodgate WGA1568S
Length: 3 9/16 (90.5)
Width: 2 9/16 (65.1)
Height: 21/32 (16.7)



PA4857 Cab Air Element
Fits: Freightliner Trucks
Replaces: Freightliner 91559, BOA91559
Length: 10 5/8 (269.9)
Width: 10 5/8 (269.9)
Height: 31/32 (24.6)



PA4858 Cab Air Element
Fits: John Deere Loaders, Toolcarriers
Replaces: John Deere T156471
Length: 16 3/8 (415.9)
Width: 8 9/16 (217.5)
Height: 1 9/16 (39.7)
A. Gskt: [2] Attached



RS4859 Radial Seal Air Element
Fits: Chevrolet Kodiak, GMC Topkick Trucks
Replaces: GMC 88937527, 88937528; ACDelco A2032C, A2033C
O.D.: 7 7/8 (200.0)
I.D.: 4 9/16 (115.9) One End
Height: 17 13/32 (442.1)



PA4860 Air Element in Disposable Housing
Replaces: Farr 40082-0022
O.D.: 11 (279.4)
Inlet: 7
Outlet: 6
Height: 19 13/16 (503.2)



RS4861 Radial Seal Air Element
Contains: 5/16 Inch bolt on closed end
Fits: DAF Trucks
Replaces: DAF 1318919; Fleetguard AF25237; Woodgate WGA1245
O.D.: 9 17/32 (242.1)
I.D.: 4 13/16 (122.2) One End
Height: 16 15/32 (418.3)



RS4862 Radial Seal Outer Air Element
Fits: International Trucks
Use With: RS4863
Replaces: International 3551814-C1
O.D.: 12 1/16 (306.4)
I.D.: 9 7/8 (250.8) One End
Height: 16 3/32 (408.8)











RS4863 Conical-Shaped Radial Seal Inner Air Element
Fits Inside: RS4862
Fits: International Trucks
Replaces: International 3551815-C1
O.D.: 5 3/8 (136.5) to 9 15/16 (252.4)
I.D.: 6 15/16 (176.2) One End
Height: 15 13/32 (391.3)

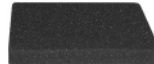

Measurements Are Shown In Inches And (Millimeters)

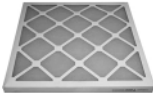
WARNING: These products can expose you to chemicals, including Diisononyl Phthalate, Carbon black extracts, Nickel, 1,3 Butadiene, Ethylene Oxide, Epichlorohydrin, which are known to the State of California to cause cancer, and Bisphenol, Ethylene Glycol, Ethylene Oxide, 1,3 Butadiene, Epichlorohydrin, which are known to the State of California to cause birth defects or other reproductive harm. For more information go to www.P65Warnings.ca.gov.

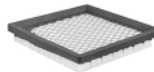
<p>RS4864</p>  <p>Radial Seal Air Element with 2 Blank Bands Replaces: Coopers AEM2620; Fleetguard AF25635; Woodgate WGA1634 O.D.: 8 3/8 (212.7) I.D.: 4 27/32 (123.0) One End Height: 14 17/32 (369.1)</p>	<p>PA4877</p>  <p>Air Element Replaces: Becker 84040112; Woodgate WGA1270 O.D.: 8 1/16 (204.8) I.D.: 5 23/32 (145.3) Height: 6 15/32 (164.3)</p>
<p>PA4870-FN</p>  <p>Outer Air Element with Lid and Fins Fits: J.C. Bamford Loaders; Zetor Tractors Use With: PA2700 Replaces: J.C. Bamford 32/913601; Fleetguard AF25958K; Woodgate WGA1059K O.D.: 5 1/4 (133.4) Lid 6 27/32 (173.8) I.D.: 19/32 (15.1) & 2 13/16 (71.4) Height: 12 3/32 (307.2) A. Gskt: [1] Attached, [1] Wing Nut</p>	<p>PA4878</p>  <p>Air Element Replaces: CompAir AP111581443; Woodgate WGA1679 O.D.: 3 (76.2) I.D.: 1 21/32 (42.1) Height: 4 19/32 (116.7) A. Gskt: [2] Attached Related To: PA4939 (Long Version)</p>
<p>PA4871</p>  <p>Air Element Replaces: Tamrock 81166609; Woodgate WGA937 O.D.: 8 7/32 (208.8) I.D.: 5 15/16 (150.8) Height: 4 (101.6)</p>	<p>PA4879</p>  <p>Foam Air Filter Notes: OBSOLETE. Availability Limited to Dealer Stock. Replaces: Woodgate WGA1896 Length: 3 15/32 (88.1) Width: 3 15/32 (88.1) Height: 13/32 (10.3)</p>
<p>PA4872</p>  <p>Air Element Replaces: Becker 909506000; Woodgate WGA962 O.D.: 3 5/16 (84.1) I.D.: 2 3/8 (60.3) One End Height: 2 13/16 (71.4) A. Gskt: [1] Attached</p>	<p>PA4881</p>  <p>Inner Air Element Fits Inside: PA3435-FN Fits: Manitou Equipment Replaces: Manitou 177178; Woodgate WGA1054S O.D.: 2 9/16 (65.1) Flange 2 29/32 (73.8) I.D.: 11/32 (8.7) & 2 7/32 (56.4) Height: 10 1/4 (260.3) A. Gskt: [1] Attached</p>
<p>PA4874</p>  <p>Panel Air Element Notes: OBSOLETE. Availability Limited to Dealer Stock. For air conditioning Replaces: Woodgate WGD20202 Length: 19 1/2 (495.3) Width: 19 1/2 (495.3) Height: 1 25/32 (45.2)</p>	<p>PA4883</p>  <p>Air Element Replaces: Wacker 18419; Woodgate WGA1155 O.D.: 3 3/32 (78.6) I.D.: 2 9/32 (57.9) Height: 3 1/8 (79.4) A. Gskt: [2] Attached</p>
<p>PA4876</p>  <p>Air Element Contains: Threaded hex nut for removal. Replaces: Atlas Copco 3214-6239-00; Fleetguard AF26147; Woodgate WGD852600 Thread: M74 x 6.0 O.D.: 4 23/32 (119.9) I.D.: 2 15/16 (74.6) One End Height: 23 5/8 (600.1) A. Gskt: [1] Attached</p>	<p>PA4885</p>  <p>Panel Air Element Fits: Briggs & Stratton Engines Replaces: Briggs & Stratton 399877; Woodgate WGA1167 Length: 4 5/8 (117.5) Width: 4 5/8 (117.5) Height: 25/32 (19.8)</p>

Measurements Are Shown In Inches And (Millimeters)

WARNING: These products can expose you to chemicals, including Diisononyl Phthalate, Carbon black extracts, Nickel, 1,3 Butadiene, Ethylene Oxide, Epichlorohydrin, which are known to the State of California to cause cancer, and Bisphenol, Ethylene Glycol, Ethylene Oxide, 1,3 Butadiene, Epichlorohydrin, which are known to the State of California to cause birth defects or other reproductive harm. For more information go to www.P65Warnings.ca.gov.

PA4886 Oblong Air Element with Foam Wrap
Fits: Komatsu Excavators; Yanmar Engines
Replaces: Yanmar 1146501-2540; Woodgate WGA1169
O.D.: 3 7/8 (98.4)
to 5 19/32 (142.1)
I.D.: 1/4 (6.4) & 3 11/16 (93.7)
Height: 2 7/8 (73.0)
Grommets: [1] Attached



PA4895 Air Element
Replaces: Rietschle 731142; Woodgate WGA1409
O.D.: 2 23/32 (69.1)
I.D.: 1 5/16 (33.3) One End
Height: 3 5/32 (80.2)



PA4887 Air Element in Disposable Housing
Fits: Voegle Paving Equipment
Replaces: Volvo 3826215; Fleetguard AF25312; Woodgate WGA1242
O.D.: 10 (254.0)
I.D.: 4 23/32 (119.9) One End
Height: 27 5/8 (701.7)



PA4896 Air Element with Attached Spring
Replaces: Rietschle 731148; Woodgate WGA1410
O.D.: 2 1/8 (54.0)
I.D.: 1 5/16 (33.3) One End
Height: 7 27/32 (199.2)
A. Gskt: [1] Attached
Spring: [1] Attached



PA4889 Air Element
Replaces: Leyland ACU8456; Fleetguard AF25087; Woodgate WGA1252
O.D.: 11 3/32 (281.8)
I.D.: 21/32 (16.7) & 6 3/4 (171.5)
Height: 14 7/16 (366.7)
A. Gskt: [1] Attached
F. Gskt: [1] Washer



PA4897 Air Breather Element in Disposable Housing
Replaces: Ingersoll-Rand 93191542; Woodgate WGA1415
O.D.: 6 15/32 (164.3)
I.D.: 3 (76.2) One End
Height: 5 1/2 (139.7)
A. Gskt: [1] Attached



PA4890 Air Element
Replaces: Renault 5001000878; Fleetguard AF4910; Woodgate WGA1255
O.D.: 5 1/8 (130.2)
I.D.: 3 9/16 (90.5)
Height: 12 1/4 (311.2)



PA4900 Air Element
Replaces: CompAir 9826281; Woodgate WGA1531
O.D.: 3 7/8 (98.4)
I.D.: 2 3/8 (60.3)
Height: 4 3/32 (104.0)



PA4891 Air Element
Replaces: Becker 84040405; Woodgate WGA1283
O.D.: 2 17/32 (64.3)
I.D.: 1 1/2 (38.1) One End
Height: 2 23/32 (69.1)
A. Gskt: [1] Attached



PA4902 Air Element
Fits: Hatz Engines
Replaces: Hatz 504260001001; Woodgate WGA1571
O.D.: 4 15/32 (113.5)
I.D.: 1/4 (6.4) & 2 (50.8)
Height: 3 3/32 (78.6)
Grommets: [1] Included



PA4893 Air Element
Notes: OBSOLETE. Availability Limited to Dealer Stock.
Replaces: Hydrovane HY0119; Woodgate WGA1316
O.D.: 8 11/16 (220.7)
I.D.: 5 29/32 (150.0)
Height: 2 1/4 (57.2)



PA4903 Air Element
Replaces: Nissan 16546-1G000; Fleetguard AF25353; Woodgate WGA1573
O.D.: 4 15/16 (125.4)
I.D.: 11/32 (8.7) & 2 3/4 (69.9)
Height: 9 1/4 (235.0)
A. Gskt: [2] Attached



Measurements Are Shown In Inches And (Millimeters)

WARNING: These products can expose you to chemicals, including Diisononyl Phthalate, Carbon black extracts, Nickel, 1,3 Butadiene, Ethylene Oxide, Epichlorohydrin, which are known to the State of California to cause cancer, and Bisphenol, Ethylene Glycol, Ethylene Oxide, 1,3 Butadiene, Epichlorohydrin, which are known to the State of California to cause birth defects or other reproductive harm. For more information go to www.P65Warnings.ca.gov.

PA4905 Panel Air Element
Fits: Stihl Chain Saws
Replaces: Stihl 41341410300B; Woodgate WGA1579
Length: 3 7/16 (87.3)
Width: 2 23/32 (69.1)
Height: 1 1/32 (26.2)

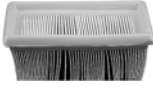

PA4907 Oblong Air Element with Foam Wrap
Notes: OBSOLETE. Availability Limited to Dealer Stock.
Fits: Robin Engines
Replaces: Robin 2623260107; Woodgate WGA1585
O.D.: 3 1/32 (77.0)
to 5 3/4 (146.0)
I.D.: 1/4 (6.4) & 4 1/16 (103.2)
Height: 3 1/16 (77.8)
A. Gskt: [1] Attached



PA4908 Foam Air Filter
Notes: Has 1 3/16 In. hole in center.
Fits: Honda Engines
Replaces: Honda 17211-ZE1-000; Woodgate WGA1587
Length: 4 31/32 (126.2)
Width: 3 27/32 (97.6)
Height: 1 19/32 (40.5)



PA4911 Foam Pad for PA4754
Replaces: Woodgate WGA1635-PF
Width: 3 3/32 (78.6)
Height: 7/32 (5.6)

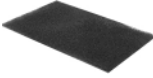

PA4912 Cabin Air Element
Fits: Mercedes-Benz Trucks, Vans
Replaces: Mercedes-Benz 8301218, A0008301218
Length: 15 1/32 (381.8)
Width: 5 3/16 (131.8)
Height: 1 19/32 (40.5)
A. Gskt: [1] Attached
Related To: PA5492 (Charcoal Impregnated Media Version)

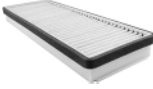

PA4918 Replacement for Ecolite Air Element in Disposable Housing
Replaces: CompAir 982625141; Donaldson C065004; Woodgate WGA1692
O.D.: 6 1/2 (165.1)
I.D.: 2 1/4 (57.2) One End
Height: 10 3/8 (263.5)



PA4919 Inner Air Element
Fits Inside: PA1681-FN
Replaces: Nissan 16546-L9011; Woodgate WGA16S
O.D.: 3 11/32 (84.9)
Flange 4 1/8 (104.8)
I.D.: 21/32 (16.7) & 2 29/32 (73.8)
Height: 11 1/16 (281.0)
A. Gskt: [1] Attached
F. Gskt: [1] Included



PA4925 Air Element
Notes: OBSOLETE. Availability Limited to Dealer Stock.
Replaces: Leyland ACU2376; Fleetguard AF4989; Woodgate WGA182
O.D.: 9 3/16 (233.4)
I.D.: 21/32 (16.7) & 4 13/16 (122.2)
Height: 16 15/32 (418.3)
A. Gskt: [1] Attached



PA4928 Panel Cab Air Element
Fits: DAF Trucks
Replaces: DAF 1322259; Fleetguard AF26139; Woodgate WGA1832
Length: 16 7/16 (417.5)
Width: 6 5/32 (156.4)
Height: 29/32 (23.0)
A. Gskt: [1] Attached

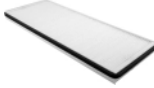

PA4929 Oval Air Element with Lid and Air Restriction Gauge Fitting
Fits: Volvo Trucks
Replaces: Volvo 3120490; Woodgate WGA1840
O.D.: 7 3/8 to 12 1/8 (187.3 to 308.0)
Lid 9 9/32 to 13 31/32 (235.7 to 354.8)
I.D.: 5 7/16 (138.1) One End
Height: 25 (635.0)



PA4930 Air Element
Notes: Can be used with PA4931 Foam Blanket.
Contains: Plastic Clamp with Screw on Open End
Fitting Attachment on Closed End
Fits: Kawasaki Mules
Replaces: Kawasaki 110291004; Woodgate WGA1849
O.D.: 5 1/32 (127.8)
I.D.: 2 27/32 (72.2)
Height: 4 7/16 (112.7)



PA4931 Foam Blanket for PA4930
Replaces: Kawasaki 110131217; Woodgate WGA1849PF
O.D.: 4 15/16 (125.4)
I.D.: 4 19/32 (116.7)
Height: 3 9/16 (90.5)



PA4932 Panel Air Element
Replaces: Jacobsen 72368G01; Woodgate WGA1850
Length: 11 15/32 (291.3)
Width: 5 3/32 (129.4)
Height: 1 13/16 (46.0)



Measurements Are Shown In Inches And (Millimeters)

WARNING: These products can expose you to chemicals, including Diisononyl Phthalate, Carbon black extracts, Nickel, 1,3 Butadiene, Ethylene Oxide, Epichlorohydrin, which are known to the State of California to cause cancer, and Bisphenol, Ethylene Glycol, Ethylene Oxide, 1,3 Butadiene, Epichlorohydrin, which are known to the State of California to cause birth defects or other reproductive harm. For more information go to www.P65Warnings.ca.gov.

PA4934



Air Element

Fits: Kubota Tractors
Replaces: Kubota 67980-82630; Woodgate WGA1859
O.D.: 3 11/32 (84.9)
I.D.: 1 13/16 (46.0)
Height: 7 7/16 (188.9)
A. Gskt: [2] Attached

PA4935



Oval Air Element

Notes: OBSOLETE. Availability Limited to Dealer Stock.
 Lid measures 5 13/16 x 3 5/32 (147.6 x 80.2)
Replaces: Kawasaki 110132132; Woodgate WGA1860
O.D.: 5 1/16 (128.6) to 6 (152.4)
I.D.: 25/32 (19.8) & 3 27/32 (97.6)
Height: 2 7/16 (61.9)
A. Gskt: [1] Attached

PA4938



Panel Cab Air Element

Fits: Scania Trucks
Replaces: Scania 1420197; Woodgate WGA1885
Length: 9 3/32 (231.0)
Width: 6 7/8 (174.6)
Height: 2 23/32 (69.1)
A. Gskt: [1] Attached

PA4939



Air Element

Replaces: Woodgate WGA1886
O.D.: 2 31/32 (75.4)
I.D.: 1 21/32 (42.1)
Height: 5 1/4 (133.4)
Related To: PA4878 (Short Version)

PA4942



Air Element with Lid

Replaces: Mercedes-Benz 120948502; Woodgate WGA88
O.D.: 10 7/16 (265.1)
 Lid 13 5/32 (334.2)
I.D.: 13/32 (10.3) & 5 1/4 (133.4)
Height: 9 1/32 (229.4)
A. Gskt: [1] Attached

PA4945



Cabin Air Element with Lift Tabs

Fits: Mercedes-Benz Trucks, Vans
Replaces: Mercedes-Benz 9408350047
Length: 17 3/4 (450.9)
Width: 7 13/32 (188.1)
Height: 1 7/32 (31.0)
A. Gskt: [1] Attached

PA4955



Cab Air Element

Fits: M.A.N. Trucks
Replaces: M.A.N. 81.61910.0018
Length: 18 3/8 (466.7)
Width: 7 9/32 (184.9)
Height: 2 13/16 (71.4)
Related To: PA5477 (Charcoal Media Version)

PA4956



Cabin Air Element

Fits: Mercedes-Benz Trucks, Vans
Replaces: Mercedes-Benz 8301118
Length: 14 15/16 (379.4)
Width: 5 5/16 (134.9)
Height: 1 17/32 (38.9)

RS4959



Radial Seal Air Element

Contains: Flame Retardant Media
Fits: DAF Trucks
Replaces: DAF 1638006, 1726060
O.D.: 10 1/2 (266.7)
I.D.: 6 11/16 (169.9)
Height: 18 7/8 (479.4)

PA4960-FN



Outer Air Element with Fins

Use With: PA4961
Replaces: Sofiflra 124005
O.D.: 7 7/8 (200.0)
 Fins 9 1/2 (241.3)
I.D.: 25/32 (19.8) & 3 9/16 (90.5)
Height: 14 1/16 (357.2)
A. Gskt: [1] Attached

PA4961



Inner Air Element

Fits Inside: PA4960-FN
Replaces: Sofiflra 125001
O.D.: 3 11/32 (84.9)
 Flange 4 5/8 (117.5)
I.D.: 7/16 (11.1) & 3 1/32 (77.0)
Height: 13 9/32 (337.3)
A. Gskt: [1] Attached

RS4962



Radial Seal Inner Air Element

Fits Inside: RS3940
Replaces: Toyota 17744-23600-71; Fleetguard AF25483; Woodgate WGA1289S
O.D.: 3 1/16 (77.8)
 Flange 3 5/32 (80.2)
I.D.: 2 7/16 (61.9) One End
Height: 10 15/32 (265.9)

RS4963









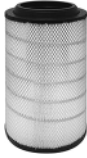

Radial Seal Air Element

Fits: Scania Trucks
Replaces: Scania 1387549; Mann & Hummel C311254; Fleetguard AF25614; Woodgate WGA1529
O.D.: 12 3/16 (309.6)
I.D.: 7 1/32 (178.6) One End
Height: 18 5/16 (465.1)

Measurements Are Shown In Inches And (Millimeters)

WARNING: These products can expose you to chemicals, including Diisononyl Phthalate, Carbon black extracts, Nickel, 1,3 Butadiene, Ethylene Oxide, Epichlorohydrin, which are known to the State of California to cause cancer, and Bisphenol, Ethylene Glycol, Ethylene Oxide, 1,3 Butadiene, Epichlorohydrin, which are known to the State of California to cause birth defects or other reproductive harm. For more information go to www.P65Warnings.ca.gov.

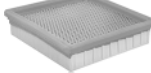
<p>RS4966</p> 	<p>Radial Seal Outer Air Element Fits: Volvo Trucks Use With: RS5408 Replaces: Volvo 8149064; Fleetguard AF25631 O.D.: 11 31/32 (304.0) Flange 12 13/16 (325.4) I.D.: 5 15/16 (150.8) One End Height: 16 1/8 (409.6)</p>	<p>RS4971</p> 	<p>Radial Seal Outer Air Element Contains: Flame Retardant Media Fits: M.A.N. Trucks Use With: RS5361 Replaces: M.A.N. 81.08405.0016; Fleetguard AF25894 O.D.: 10 11/16 (271.5) I.D.: 6 11/16 (169.9) One End Height: 20 (508.0)</p>
<p>RS4967</p> 	<p>Radial Seal Outer Air Element Fits: Volvo Trucks Use With: PA3925 Replaces: Volvo 814996-1; Fleetguard AF25632 O.D.: 13 1/16 (331.8) Flange 13 25/32 (350.0) I.D.: 7 15/16 (201.6) One End Height: 16 11/32 (415.1) A. Gskt: [2] Attached Related To: RS5776 (Flame Retardant Media)</p>	<p>RS4972</p> 	<p>Radial Seal Air Element Fits: Deutz-Fahr Tractors Use With: RS5684 Replaces: Fleetguard AF25504 O.D.: 8 5/32 (207.2) I.D.: 4 9/32 (108.7) One End Height: 15 1/16 (382.6)</p>
<p>RS4968</p> 	<p>Radial Seal Air Element Fits: Iveco Trucks Replaces: Iveco 42471161; Fleetguard AF25875 O.D.: 9 21/32 (245.3) I.D.: 5 7/16 (138.1) One End Height: 13 1/16 (331.8)</p>	<p>PA4973</p> 	<p>Rectangular Air Element Fits: Ingersoll-Rand Compressors Replaces: Ingersoll-Rand 51322881; Woodgate WGD800016 Length: 32 3/16 (817.6) Width: 9 13/32 (238.9) Height: 3 1/2 (88.9)</p>
<p>RS4969</p> 	<p>Radial Seal Air Element Contains: Flame Retardant Media Fits: Iveco Trucks Replaces: Iveco 42471166; Fleetguard AF25876 O.D.: 9 19/32 (243.7) I.D.: 5 7/16 (138.1) One End Height: 16 5/16 (414.3)</p>	<p>PA4977-FN</p> 	<p>Air Element with Fins Replaces: Fiat 8016660; Woodgate WGA1553 O.D.: 9 5/32 (232.6) Fins 11 13/32 (289.7) I.D.: 25/32 (19.8) & 4 29/32 (124.6) Height: 13 19/32 (345.3)</p>
<p>RS4970</p> 	<p>Radial Seal Air Element Fits: DAF, Kenworth Trucks Replaces: Fleetguard AF25873 O.D.: 8 3/8 (212.7) I.D.: 4 11/16 (119.1) One End Height: 16 7/16 (417.5) Related To: RS5433 (Flame Retardant Media)</p>	<p>PA4978</p> 	<p>Air Element Notes: OBSOLETE. Availability Limited to Dealer Stock. Replaces: Becker 909536; Woodgate WGA956 O.D.: 2 9/32 (57.9) I.D.: 3/16 (4.8) & 23/32 (18.3) Height: 1 19/32 (40.5) A. Gskt: [1] Attached</p>
	<p>PA4979</p> 	<p>Panel Air Element Fits: Lombardini Engines Replaces: Lombardini 55.02175.096; Woodgate WGA1618 Length: 6 9/32 (159.5) Width: 6 5/32 (156.4) Height: 1 17/32 (38.9)</p>	

Measurements Are Shown In Inches And (Millimeters)

WARNING: These products can expose you to chemicals, including Diisononyl Phthalate, Carbon black extracts, Nickel, 1,3 Butadiene, Ethylene Oxide, Epichlorohydrin, which are known to the State of California to cause cancer, and Bisphenol, Ethylene Glycol, Ethylene Oxide, 1,3 Butadiene, Epichlorohydrin, which are known to the State of California to cause birth defects or other reproductive harm. For more information go to www.P65Warnings.ca.gov.

PA4983



Inner Air Element

Fits Inside: PA4984-FN
Fits: Hyundai Excavators, Loaders
Replaces: Hyundai 11EM21051
O.D.: 5 5/32 (131.0)
I.D.: 3/4 (19.0) & 4 1/32 (102.4)
Height: 19 7/16 (493.7)
A. Gskt: [1] Attached

RS4989



Radial Seal Outer Air Element

Notes: Sometimes used with RS4629.
Fits: Caterpillar, John Deere, New Holland Equipment
Replaces: Perkins SEV551F14
O.D.: 14 7/32 (361.2)
I.D.: 8 15/16 (227.0) One End
Height: 24 27/32 (631.0)

PA4984-FN



Outer Air Element with Fins

Fits: Hyundai Excavators, Loaders
Use With: PA4983
Replaces: Hyundai 11EM21041
O.D.: 7 31/32 (202.4)
 Fins 9 13/16 (249.2)
I.D.: 3/4 (19.0) & 5 3/8 (136.5)
Height: 19 13/16 (503.2)
A. Gskt: [1] Attached

PA4991



Cab Air Element

Fits: Volvo Dump Trucks, Loaders
Replaces: Volvo 11703980
Length: 19 1/8 (485.8)
Width: 11 1/4 (285.8)
Height: 2 7/16 (61.9)
A. Gskt: [1] Included

PA4985



Cab Air Element

Fits: International Trucks
Replaces: International 2506656-C1
Length: 12 19/32 (319.9)
Width: 7 1/4 (184.2)
Height: 31/32 (24.6)

RS4992



Radial Seal Outer Air Element

Fits: John Deere Equipment
Use With: RS5329
Replaces: John Deere AT300487
O.D.: 8 27/32 (224.6)
I.D.: 7 1/8 (181.0) One End
Height: 16 23/32 (424.7)

PA4986

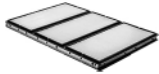

Cab Air Element

Fits: Komatsu Equipment
Replaces: Komatsu 77Z9-70-0020
Length: 12 (304.8)
Width: 7 13/16 (198.4)
Height: 3/4 (19.1)
A. Gskt: [1] Attached

RS4993



Radial Seal Air Element

Fits: Cummins Engines
Replaces: Fleetguard AF25708M; Nelson 870904A, 870904N
O.D.: 11 3/32 (281.8)
I.D.: 8 (203.2) One End
Height: 20 15/32 (519.9)

PA4987



Cab Air Element

Fits: Komatsu Dozers
Replaces: Komatsu 77Z9-70-0010
Length: 8 9/32 (210.3)
Width: 8 1/32 (204.0)
Height: 25/32 (19.8)
A. Gskt: [1] Attached

RS4994



Radial Seal Outer Air Element

Fits: Caterpillar Crawler Tractors
Use With: RS4995
Replaces: Caterpillar 180-5474; Donaldson P606804
O.D.: 6 1/2 (165.1)
I.D.: 3 9/16 (90.5) One End
Height: 12 17/32 (318.3)

RS4988



Radial Seal Air Element

Fits: Caterpillar D9R Crawler Tractor
Replaces: Caterpillar 165-1689; Donaldson P606220
O.D.: 13 15/32 (342.1)
I.D.: 8 5/32 (207.2) One End
Height: 15 17/32 (394.5)

RS4995



Radial Seal Inner Air Element

Fits Inside: RS4994
Fits: Caterpillar Crawler Tractors
Replaces: Caterpillar 180-5475
O.D.: 3 21/32 (92.9)
I.D.: 2 7/8 (73.0) One End
Height: 12 3/32 (307.2)

Measurements Are Shown In Inches And (Millimeters)

WARNING: These products can expose you to chemicals, including Diisononyl Phthalate, Carbon black extracts, Nickel, 1,3 Butadiene, Ethylene Oxide, Epichlorohydrin, which are known to the State of California to cause cancer, and Bisphenol, Ethylene Glycol, Ethylene Oxide, 1,3 Butadiene, Epichlorohydrin, which are known to the State of California to cause birth defects or other reproductive harm. For more information go to www.P65Warnings.ca.gov.

CA4996 Channel Flow Primary Air Element
Fits: Caterpillar Crawler Tractors, Loaders; Valtra Tractors
Use With: PA4997
Replaces: Caterpillar 2277448, 2934053
O.D.: 7 7/8 (200.0)
to 9 1/8 (231.8)
Height: 6 7/8 (174.6)



PA4997 Channel Flow Secondary Air Element
Fits: Caterpillar Crawler Tractors, Loaders
Use With: CA4996
Replaces: Caterpillar 2277449; J.C. Bamford 32/926072
O.D.: 5 9/16 (141.3)
to 8 7/32 (208.8)
Height: 1 19/32 (40.5)



CA4999 Channel Flow Air Element
Fits: Ford Excursion, Super Duty Trucks all with 6.0L Turbo Diesel Engine
Replaces: Ford 3C3U-9601-BC; Motorcraft FA1746; Donaldson P603577; Fleetguard AF26152; Wix 42731
O.D.: 7 31/32 (202.4)
to 12 3/32 (307.2)
Height: 9 5/16 (236.5)
A. Gskt: [1] Attached



CFB5000 Coolant Filter Base
Contains: 11/16-16 Threaded Stud
Use With: All Coolant Spin-ons with 11/16-16 Thread
O.D.: 4 11/16 (119.1)
Inlet: 3/8-18 NPTF
Outlet: 3/8-18 NPTF
Height: 3 3/32 (78.6)



CS5007 BTA PLUS Formula Liquid Additive (Pint Plastic Bottle)
Notes: NOT compatible with Long Life Organic Acid-based Coolant.
For systems containing 0% to 60% Ethylene Glycol antifreeze.
Contains: 4 Units BTA PLUS
Pre-Charge treatment is 1 1/4 units per gallon of cooling system capacity.
Maintenance treatment is 1 1/4 units per 4 gallons of cooling system capacity every 12,000-15,000 miles or 300-350 hours of operation.
Replaces: Case B91245; Cummins 3305372, 3315459; John Deere RE23182, TY16004
Related To: CS5057 (5 Gallon Jug)
CS5058 (Half Gallon Jug)



CS5008 BTE Liquid Coolant Additive (Pint Plastic Bottle)
Notes: NOT compatible with Long Life Organic Acid-based Coolant.
For systems containing 40% to 60% Ethylene Glycol antifreeze.
Compatible with all Ethylene Glycol antifreezes.
Heavy-Duty antifreeze containing sodium nitrite needs no initial treatment.
Contains: Pre-Charge treatment is one pint to each 4 gallons of cooling system capacity or fraction.
Maintenance treatment is one pint for each 20 gallons of cooling system capacity or fraction.
Every 12,000-15,000 miles or 300-350 hours of operation.



CS5009 BTE Liquid Coolant Additive (Half Gallon Plastic Jug)
Notes: NOT compatible with Long Life Organic Acid-based Coolant.
For systems containing 40% to 60% Ethylene Glycol antifreeze.
Compatible with all Ethylene Glycol antifreezes.
Heavy-Duty antifreeze containing sodium nitrite needs no initial treatment.
Contains: Pre-Charge treatment is one pint to each 4 gallons of cooling system capacity or fraction.
Maintenance treatment is one pint for each 20 gallons of cooling system capacity or fraction.
Every 12,000-15,000 miles or 300-350 hours of operation.



CS5010 BTE Liquid Coolant Additive (5 Gallon Bucket)
Notes: NOT compatible with Long Life Organic Acid-based Coolant.
For systems containing 40% to 60% Ethylene Glycol antifreeze.
Compatible with all Ethylene Glycol antifreezes.
Heavy-Duty antifreeze containing sodium nitrite needs no initial treatment.
Contains: Pre-Charge treatment is one pint to each 4 gallons of cooling system capacity or fraction.
Maintenance treatment is one pint for each 20 gallons of cooling system capacity or fraction.
Every 12,000-15,000 miles or 300-350 hours of operation.













CS5011 BTE Liquid Coolant Additive (55 Gallon No Return Plastic Drum)
Notes: NOT compatible with Long Life Organic Acid-based Coolant.
For systems containing 40% to 60% Ethylene Glycol antifreeze.
Compatible with all Ethylene Glycol antifreezes.
Heavy-Duty antifreeze containing sodium nitrite needs no initial treatment.
Contains: Pre-Charge treatment is one pint to each 4 gallons of cooling system capacity or fraction.
Maintenance treatment is one pint for each 20 gallons of cooling system capacity or fraction.
Every 12,000-15,000 miles or 300-350 hours of operation.



Measurements Are Shown In Inches And (Millimeters)

WARNING: These products can expose you to chemicals, including Diisononyl Phthalate, Carbon black extracts, Nickel, 1,3 Butadiene, Ethylene Oxide, Epichlorohydrin, which are known to the State of California to cause cancer, and Bisphenol, Ethylene Glycol, Ethylene Oxide, 1,3 Butadiene, Epichlorohydrin, which are known to the State of California to cause birth defects or other reproductive harm. For more information go to www.P65Warnings.ca.gov.

<p>CSC5012</p>  <p>Liquid Coolant Cleaner (1 Gallon Plastic Bottle) Notes: This is the same product, but with the dye removed. An inhibited neutral chelating cooling system cleaner. CSC is formulated to dissolve scale and corrosion products while removing silica gel and oil found in engine cooling systems. Contains: Recommended treatment is 1 gallon to each 10 gallons of cooling system capacity. While you may get improved performance from a higher concentration of CSC, do not use CSC at more than twice the recommended concentration levels.</p>	<p>CTK5029-4</p>  <p>FleetStrip Coolant Test Strips Only Contains: [4] Test Strips, Color Chart, Instruction Sheet</p>
<p>CSC5013</p>  <p>Liquid Coolant Cleaner (5 Gallon Jug) Notes: An inhibited neutral chelating cooling system cleaner. CSC is formulated to dissolve scale and corrosion products while removing silica gel and oil found in engine cooling systems. Contains: Recommended treatment is 1 gallon to each 10 gallons of cooling system capacity. While you may get improved performance from a higher concentration of CSC, do not use CSC at more than twice the recommended concentration levels.</p>	<p>CTK5029-M</p>  <p>FleetStrip Coolant Test Kit Notes: CTK5029-M Color Chart measurement is metric. Kit is designed to test SCAs by measuring freeze point, nitrite and molybdate. Does not test Long Life Organic Acid-based coolant. Contains: [1] Sample Vial [1] Extraction Pipet Instructions Color Chart Plastic Carrying Case [50] Test Strips</p>
<p>CTK5028</p>  <p>Correcting Refractometer Notes: This refractometer measures Ethylene and Propylene Glycol based fluids. Contains: Internal Light Source Syringe Dip Stick</p>	<p>CS5057</p>  <p>BTA PLUS Liquid Additive (5 Gallon Jug) Notes: NOT compatible with Long Life Organic Acid-based Coolant. Pre-Charge treatment is 1 1/4 units per gallon of cooling system capacity. Maintenance treatment is 1 1/4 units per 4 gallons of cooling system Replaces: Caterpillar 8C3680 Related To: CS5007 (Pint Bottle) CS5058 (Half Gallon Jug)</p>
<p>CTK5029</p>  <p>FleetStrip Coolant Test Kit Notes: Kit is designed to test SCAs by measuring freeze point, nitrite and molybdate. Does not test Long Life Organic Acid-based coolant. Contains: [1] Sample Vial [1] Extraction Pipet Instructions Color Chart Plastic Carrying Case [50] Test Strips Replaces: Fleetguard CC2602</p>	<p>CS5058</p>  <p>BTA PLUS Formula Liquid Additive (Half Gallon Jug) Notes: NOT compatible with Long Life Organic Acid-based Coolant. Pre-Charge treatment is 1 1/4 units per gallon of cooling system capacity. Maintenance treatment is 1 1/4 units per 4 gallons of cooling system Replaces: Cummins 3305373; Komatsu 1258390-H1 Related To: CS5007 (Pint Bottle) CS5057 (5 Gallon Bucket)</p>
<p>CTK5029-1</p>  <p>FleetStrip Coolant Test Strip Only Contains: [1] Test Strip, Color Chart, Instruction Sheet Replaces: Fleetguard CC2602B</p>	<p>OTK5060</p>  <p>Live Oil Sample Kit with Processing Notes: Purchase of kit includes testing charges. Testing includes 23 Elements, Antifreeze, Fuel Dilution, Viscosity @ 100 C, Complete Oil Condition (Soot, Oxidation, Nitration, Sulfation) Contains: [1] 2.5 oz. Bottle with Lid, Live Sample Cap for Sample Extraction Label for Sample Information Ziploc, Bubble Mailer for Return (Return Postage is included) Fits: Engines, Transmissions, Hydraulics Use With: Systems with Pressurized Probalyzer Ports - OTK5061 (Marine Applications) Replaces: Titan OD1020</p>

Measurements Are Shown In Inches And (Millimeters)

WARNING: These products can expose you to chemicals, including Diisononyl Phthalate, Carbon black extracts, Nickel, 1,3 Butadiene, Ethylene Oxide, Epichlorohydrin, which are known to the State of California to cause cancer, and Bisphenol, Ethylene Glycol, Ethylene Oxide, 1,3 Butadiene, Epichlorohydrin, which are known to the State of California to cause birth defects or other reproductive harm. For more information go to www.P65Warnings.ca.gov.

OTK5061



Stainless Steel Probalyzer Plug
Notes: Installs into standard NPT 1/8 In. pressure ports, allows fluid samples to be drawn during operation using live sample caps, handles up to 5000 psi.
Contains: Stainless Steel Plug with Instructions
Fits: Can be installed on any pressurized line for oil and coolant. Best used in Marine applications as it does not corrode in salt water.
Use With: OTK5060
Replaces: Titan OD1015

OTK5063



Oil Test Kit
Notes: Purchase of kit includes testing charges.
 Testing includes 23 Elements, Antifreeze, Fuel Dilution, Viscosity @ 100 C, Complete Oil Condition (Soot, Oxidation, Nitration, Sulfation)
Contains: [1] 2.5 oz. Bottle with Lid Label for Sample Information
 Ziploc, Bubble Mailer for Return (Return Postage is included)
Fits: Extractor Pumps and Tubing as well as mid-drain sampling.
Replaces: Titan OD8011

BW5070



Coolant Spin-on with BTA PLUS Formula
Notes: Maintenance filter for systems with 1-6 gallons capacity.
 Can be used with CFB5000 base, or CFB8784 dual base.
Contains: 2 Units BTA PLUS
Fits: Cummins Engines
Replaces: Cummins 3318157; Fleetguard WF2070
Thread: 11/16 -16
O.D.: 3 11/16 (93.7)
Height: 4 3/8 (111.1)
I.Gskt: G381-A

BW5071



Coolant Spin-on with BTA PLUS Formula
Notes: Maintenance filter for systems with 7-16 gallons capacity.
 Can be used with CFB5000 base or CFB8784 dual base.
Contains: 4 Units BTA PLUS
Fits: Cummins Engines
Replaces: Ag-Chem 709939; Case 1822627C1; Caterpillar 226-6565; Cummins 3315116; Demag 692338; Ford E5NN-8A424-A; General Motors 25012893; Hitachi 4127340; John Deere RE42052; Mack 25MF214; Fleetguard WF2071
Thread: 11/16 -16
O.D.: 3 11/16 (93.7)
Height: 4 3/8 (111.1)
I.Gskt: G381-A

BW5072



Coolant Spin-on with BTA PLUS Formula
Notes: Maintenance filter for systems with 17-21 gallons capacity.
 Can be used with CFB5000 base or CFB8784 dual base.
Contains: 6 Units BTA PLUS
Fits: Cummins Engines
Replaces: Cummins 3318201; Ford E8NN-8A424-B; Hough 1257937H1; John Deere F434679; Komatsu 6742-01-3970; Onan 133-3538; Volvo 129680286; Fleetguard WF2072
Thread: 11/16 -16
O.D.: 3 11/16 (93.7)
Height: 4 3/8 (111.1)
I.Gskt: G381-A

BW5073



Coolant Spin-on with BTA PLUS Formula
Notes: Maintenance filter for systems with 22-32 gallons capacity.
 Can be used with CFB5000 base or CFB8784 dual base.
Contains: 8 Units BTA PLUS
Fits: Cummins Engines
Replaces: Agco 1076751M1; Case 690139C1; Caterpillar 226-6567; Cummins 3315115; Daewoo 9912-15115; Demag 692336; Hitachi 19305494; Versatile 104040; Volvo M12968028; Fleetguard WF2073
Thread: 11/16 -16
O.D.: 3 11/16 (93.7)
Height: 5 3/8 (136.5)
I.Gskt: G381-A

BW5074



Coolant Spin-on with BTA PLUS Formula
Notes: Maintenance filter for systems with 33-43 gallons capacity.
 Can be used with CFB5000 base or CFB8784 dual base.
Contains: 12 Units BTA PLUS
Fits: Cummins Engines
Replaces: Cummins 3315114; Fleetguard WF2074
Thread: 11/16 -16
O.D.: 3 11/16 (93.7)
Height: 5 3/8 (136.5)
I.Gskt: G381-A

BW5075



Coolant Spin-on with BTA PLUS Formula
Notes: Maintenance filter for systems with 44-51 gallons capacity.
 Can be used with CFB5000 base or CFB8784 dual base.
Contains: 15 Units BTA PLUS
Fits: Cummins Engines
Replaces: Cummins 3318318; Fleetguard WF2075
Thread: 11/16 -16
O.D.: 3 11/16 (93.7)
Height: 5 3/8 (136.5)
I.Gskt: G381-A

Measurements Are Shown In Inches And (Millimeters)

WARNING: These products can expose you to chemicals, including Diisononyl Phthalate, Carbon black extracts, Nickel, 1,3 Butadiene, Ethylene Oxide, Epichlorohydrin, which are known to the State of California to cause cancer, and Bisphenol, Ethylene Glycol, Ethylene Oxide, 1,3 Butadiene, Epichlorohydrin, which are known to the State of California to cause birth defects or other reproductive harm. For more information go to www.P65Warnings.ca.gov.

<p>BW5076</p> 	<p>Coolant Spin-on with BTA PLUS Formula Notes: Maintenance filter for systems with 52-70 gallons capacity. Can be used with CFB5000 base or CFB8784 dual base. Contains: 23 Units BTA PLUS Fits: Cummins Engines Replaces: Cummins 3318319; Fleetguard WF2076 Thread: 11/16 -16 O.D.: 3 11/16 (93.7) Height: 7 5/32 (181.8) I.Gskt: G381-A</p>	<p>B5089</p>  <p>Coolant Spin-on without Chemicals Notes: Can be used with CFB5000 base or CFB8784 dual base. Fits: Scania Trucks Replaces: International 1825314-C1; Fleetguard WF2107 Thread: 11/16 -16 O.D.: 3 11/16 (93.7) Height: 4 3/8 (111.1) I.Gskt: G381-A Related To: B5134 (Long Version)</p>
<p>BW5082</p> 	<p>Coolant Spin-on with BTA PLUS Formula Notes: Maintenance filter for systems with 7-16 gallons capacity. Can be used with CFB5000 base or CFB8784 dual base. Contains: 4 Units BTA PLUS Fits: International Equipment Replaces: International 1822313-C1; Fleetguard WF2106 Thread: 11/16 -16 O.D.: 3 11/16 (93.7) Height: 5 3/8 (136.5) I.Gskt: G381-A</p>	<p>B5090</p>  <p>Coolant Spin-on without Chemicals Notes: Long Life (150,000 miles) used with Extended Service coolant Can be used with CFB5000 base or CFB8784 dual base. Fits: International, Kenworth Trucks Replaces: Cummins 3098690; Fleetguard WF2123 Thread: 11/16 -16 O.D.: 3 11/16 (93.7) Height: 5 3/8 (136.5) I.Gskt: G381-A Related To: B5088 (Short Version)</p>
<p>BW5086</p> 	<p>Coolant Spin-on with BTA PLUS Formula Contains: 11 1/2 Units BTA PLUS Fits: Cummins Engines Replaces: Cummins 3680433; Fleetguard WF2126 Thread: M36 x 2.0 O.D.: 3 3/4 (95.3) Height: 5 13/32 (137.3) I.Gskt: [1] Included</p>	<p>B5091</p>  <p>Coolant Spin-on without Chemicals Fits: Mack Trucks Replaces: Mack 20575545 Thread: M16 x 1.5 O.D.: 3 11/16 (93.7) Height: 5 13/32 (137.3) A. Gskt: G401</p>
<p>B5087</p> 	<p>Coolant Spin-on without Chemicals Notes: Long Life (150,000 miles) used with Extended Service coolant. Fits: Cummins Engines Replaces: Cummins 3680434 Thread: M36 x 2.0 O.D.: 3 3/4 (95.3) Height: 5 15/32 (138.9) F. Gskt: [1] Included</p>	<p>P5092</p>  <p>Coolant Element without Chemicals Notes: Has a Bail Handle. Fits: Detroit Diesel DD15 (14.8L) Engine; Freightliner, Mercedes-Benz, Sterling, Western Star Trucks Replaces: Detroit Diesel A4722030155, A4722030255; Mercedes-Benz A4722030255 O.D.: 3 21/32 (92.9) I.D.: 1 5/8 (41.3) One End Height: 5 9/32 (134.1) O-Ring: [1] Included</p>
<p>B5088</p> 	<p>Coolant Spin-on without Chemicals Notes: Long Life (150,000 miles) used with Extended Service coolant Can be used with CFB5000 base or CFB8784 dual base. Fits: Caterpillar, Cummins Engines Replaces: Cummins 3098689 Thread: 11/16 -16 O.D.: 3 11/16 (93.7) Height: 4 3/8 (111.1) I.Gskt: G381-A Related To: B5090 (Long Version)</p>	<p>B5134</p>  <p>Coolant Spin-on without Chemicals Notes: Can be used with CFB5000 base or CFB8784 dual base. Fits: John Deere Equipment Replaces: Caterpillar 9Y4528; Cummins 3300721; Ford E7NN-8A469-AA; GMC 25010844; Hino 16304-41015; John Deere RE11992 Thread: 11/16 -16 O.D.: 3 11/16 (93.7) Height: 5 13/32 (137.3) I.Gskt: G381-A Related To: B5089 (Short Version)</p>

Measurements Are Shown In Inches And (Millimeters)

WARNING: These products can expose you to chemicals, including Diisononyl Phthalate, Carbon black extracts, Nickel, 1,3 Butadiene, Ethylene Oxide, Epichlorohydrin, which are known to the State of California to cause cancer, and Bisphenol, Ethylene Glycol, Ethylene Oxide, 1,3 Butadiene, Epichlorohydrin, which are known to the State of California to cause birth defects or other reproductive harm. For more information go to www.P65Warnings.ca.gov.

BW5136



Coolant Spin-on with BTE Formula
Notes: Maintenance filter for systems with 1-10 gallons capacity.
 Can be used with CFB5000 base or CFB8784 dual base.
Contains: 2 Units BTE
Fits: Allis Chalmers, Case, International, John Deere Equipment
Replaces: Allis Chalmers 40290892; Case A151931; Caterpillar 7E6014; Ford E7HZ-8A424-C; John Deere AR89381; Komatsu 600-411-1190
Thread: 11/16 -16
O.D.: 3 11/16 (93.7)
Height: 4 3/8 (111.1)
I.Gskt: G381-A

BW5137



Coolant Spin-on with BTE Formula
Notes: Maintenance filter for systems with 11-20 gallons capacity.
 Can be used with CFB5000 base or CFB8784 dual base.
Contains: 4 Units BTE
Fits: Allis Chalmers, Caterpillar, Fiat-Allis, International, Komatsu Equipment; Chevrolet, Freightliner, GMC, International, Iveco, Kenworth, Peterbilt Trucks
Replaces: Allis Chalmers 4681776; Caterpillar 9N3368; Cummins 209606; GMC 23507545; Ford D2HZ-8A424-A; International 1801090-C1; Komatsu 600-411-1020
Thread: 11/16 -16
O.D.: 3 11/16 (93.7)
Height: 4 13/32 (111.9)
I.Gskt: G381-A

BW5138



Coolant Spin-on with BTE Formula
Notes: Maintenance filter for systems with 21-30 gallons capacity.
 Can be used with CFB5000 base or CFB8784 dual base.
Contains: 6 Units BTE
Fits: Komatsu Equipment
Replaces: Allis Chalmers 70697635; Fiat 70697635; GMC 25011791; Komatsu 600-411-1140
Thread: 11/16 -16
O.D.: 3 11/16 (93.7)
Height: 5 3/8 (136.5)
I.Gskt: G381-A

BW5139



Coolant Spin-on with BTE Formula
Notes: Maintenance filter for systems with 31-40 gallons capacity.
 Can be used with CFB5000 base or CFB8784 dual base.
Contains: 8 Units BTE
Fits: Caterpillar, Komatsu Equipment
Replaces: Allis Chalmers 4393504, 4393504-8; Case A152819; Caterpillar 9N3366; Cummins 209607; GMC 6439698; Hino 16304-1011; International 1801089-C1; John Deere AR88276; Komatsu 600-411-1040
Thread: 11/16 -16
O.D.: 3 11/16 (93.7)
Height: 5 11/32 (135.7)
I.Gskt: G381-A

BW5140



Coolant Spin-on with BTE Formula
Notes: Maintenance filter for systems with 41-50 gallons capacity.
 Can be used with CFB5000 base or CFB8784 dual base.
Contains: 16 Units BTE
Fits: Caterpillar, Komatsu Equipment
Replaces: Caterpillar 1W5518; Clark 963797; Cummins 3315788; GMC 23507189; John Deere AR94652; Komatsu 600-411-1420
Thread: 11/16 -16
O.D.: 3 11/16 (93.7)
Height: 7 5/32 (181.8)
I.Gskt: G381-A

BW5141



Coolant Spin-on with BTE Formula
Notes: Maintenance filter for systems with 1-10 gallons capacity.
Contains: 2 Units BTE
Fits: Volvo Equipment
Replaces: Volvo 1661964-5, 1699830, 1699830-7
Thread: M16 x 1.5
O.D.: 3 11/16 (93.7)
Height: 5 13/32 (137.3)
I.Gskt: G401

BW5142



Coolant Spin-on with BTE Formula
Contains: 8 Units BTE
Fits: Volvo Engines
Replaces: Volvo 3945411
Thread: M16 x 1.5
O.D.: 3 11/16 (93.7)
Height: 5 13/32 (137.3)
I.Gskt: G401

BW5143



Coolant Spin-on with BTE Formula
Notes: Can be used with CFB5000 base or CFB8784 dual base.
Contains: 11 Units BTE
Fits: Iveco Trucks
Replaces: Iveco 1901776
Thread: 11/16 -16
O.D.: 3 11/16 (93.7)
Height: 5 3/8 (136.5)
I.Gskt: G381-A

B5144



Coolant By-Pass Spin-on Canister
Notes: For use with Long Life Coolant. DO NOT replace with spin-on containing chemicals.
Fits: Volvo Engines
Replaces: Volvo 3969696; Fleetguard WF2109
Thread: M16 x 1.5
O.D.: 3 11/16 (93.7)
Height: 5 7/16 (138.1)
I.Gskt: G401

B5145



Coolant Spin-on without Chemicals
Notes: Long Life (150,000 miles) used with Extended Service coolant.
Fits: Volvo Equipment
Replaces: Volvo 20458771; Fleetguard WF2129
Thread: M16 x 1.5
O.D.: 3 11/16 (93.7)
Height: 4 7/16 (112.7)
I.Gskt: G401

Measurements Are Shown In Inches And (Millimeters)

WARNING: These products can expose you to chemicals, including Diisononyl Phthalate, Carbon black extracts, Nickel, 1,3 Butadiene, Ethylene Oxide, Epichlorohydrin, which are known to the State of California to cause cancer, and Bisphenol, Ethylene Glycol, Ethylene Oxide, 1,3 Butadiene, Epichlorohydrin, which are known to the State of California to cause birth defects or other reproductive harm. For more information go to www.P65Warnings.ca.gov.

B5176 Coolant Spin-on without Chemicals
Fits: Mack Engines, Trucks
Replaces: Fleetguard WF2078
Thread: 3/4 -20
O.D.: 3 11/16 (93.7)
Height: 5 3/8 (136.5)
I.Gskt: G381-A



B5177 Coolant Spin-on without Chemicals
Fits: Mack Engines, Trucks
Replaces: Fleetguard WF2079
Thread: 1 -16
O.D.: 4 1/4 (108.0)
Height: 5 13/16 (147.6)
I.Gskt: [1] Included



BW5178 Coolant Spin-on with BTE Formula
Contains: 10 Units BTE
Fits: Mack Engines, Trucks
Replaces: GMC 6439296; Mack 25MF428, 25MF428-A; White 27-077522
Thread: 3/4 -20
O.D.: 3 11/16 (93.7)
Height: 5 3/8 (136.5)
I.Gskt: G381-A



BW5179 Coolant Spin-on with BTE Formula
Contains: 16 Units BTE
Fits: Mack Engines, Trucks
Replaces: GMC 25010921; Mack 25MF418
Thread: 1 -16
O.D.: 4 1/4 (108.0)
Height: 5 13/16 (147.6)
I.Gskt: [1] Included



BW5182 Coolant Spin-on with BTE Formula
Notes: Can be used with CFB5000 base or CFB8784 dual base.
Contains: 8 Units BTE
Fits: Komatsu Excavators, Loaders
Replaces: Komatsu 600-411-1181
Thread: 11/16 -16
O.D.: 3 11/16 (93.7)
Height: 3 7/32 (81.8)
I.Gskt: G381-A



BW5183 Coolant Spin-on with BTE Formula
Contains: 12 Units BTE
Fits: Mack Trucks
Replaces: Mack 20539991
Thread: M16 x 1.5
O.D.: 3 11/16 (93.7)
Height: 4 7/16 (112.7)
I.Gskt: G401



BW5200 Controlled Release Coolant Spin-on with BTE Formula
Notes: Can be used with CFB5000 base or CFB8784 dual base.
Contains: Flow Control Orifice that meters flow of coolant through filter to allow coolant additives to be released in the amount required to maintain proper system balance for up to 150,000 miles of service.
Fits: Applications Using a "Controlled Release" Coolant Additive
Replaces: Nalcool NF2088
Thread: 11/16 -16
O.D.: 3 11/16 (93.7)
Height: 5 13/32 (137.3)
I.Gskt: G381-A



BW5201 Controlled Release Coolant Spin-on with BTE Formula
Contains: Flow Control Orifice that meters flow of coolant through filter to allow coolant additives to be released in the amount required to maintain proper system balance for up to 150,000 miles of service.
Fits: Applications Using a "Controlled Release" Coolant Additive
Replaces: Nalcool NF2089, NF2089-1, NFC2089
Thread: 3/4 -20
O.D.: 3 11/16 (93.7)
Height: 5 3/8 (136.5)
I.Gskt: G381-A



BW5250 Controlled Release Coolant Spin-on with BTA PLUS Formula
Notes: Can be used with CFB5000 base or CFB8784 dual base.
Contains: Flow Control Orifice that meters flow of coolant through filter to allow coolant additives to be released in the amount required to maintain proper system balance for up to 150,000 miles of service.
Fits: Applications using a "Controlled Release" Coolant Additive
Replaces: Cummins XWF4242; Fleetguard WF2121
Thread: 11/16 -16
O.D.: 3 11/16 (93.7)
Height: 5 13/32 (137.3)
I.Gskt: G381-A



PE5270 Urea Diesel Exhaust Fluid Filter
Contains: [1] Plastic Drain Plug
[1] Steel Mesh Strainer
[1] Foam Absorber
Fits: DAF, M.A.N., Volvo Trucks
Replaces: Cummins 3967874; DAF 1649425, 1674485, 1789050, 1815766, 1819795; Iveco 42553548, 42561571, 42562233; M.A.N. 81154036015, 81154036089; Nissan 20421-NY00J; Volvo 207136
O.D.: 2 23/32 (69.1)
I.D.: 31/32 (24.6) One End
Height: 3 (76.2)
F. Gskt: [1] Included
O-Ring: [1] Attached, [1] Included



Measurements Are Shown In Inches And (Millimeters)

WARNING: These products can expose you to chemicals, including Diisononyl Phthalate, Carbon black extracts, Nickel, 1,3 Butadiene, Ethylene Oxide, Epichlorohydrin, which are known to the State of California to cause cancer, and Bisphenol, Ethylene Glycol, Ethylene Oxide, 1,3 Butadiene, Epichlorohydrin, which are known to the State of California to cause birth defects or other reproductive harm. For more information go to www.P65Warnings.ca.gov.

PE5271



Urea Diesel Exhaust Fluid Filter
Contains: [1] Plastic Drain Plug
Fits: Challenger, Fendt, Massey Ferguson Tractors; Volvo Trucks
Replaces: Agco V837062993; Deutz 2934622; Iveco 42555073, 42561605; Renault 7420877950, 7420877953; Volvo 20876498, 20876502
O.D.: 2 19/32 (65.9)
I.D.: 7/16 (11.1)
Height: 3 15/16 (100.0)
F. Gskt: [1] Included
O-Ring: [2] Attached

PE5272



Urea Diesel Exhaust Fluid Filter in Plastic Shell
Fits: Freightliner, Mercedes-Benz, Western Star Buses, Trucks
Replaces: Freightliner A0001420089, A0001420289; Mercedes-Benz A0001420089, A0001420289
Element
O.D.: 1 11/16 (42.9)
I.D.: 1 1/32 (26.2)
Height: 3 3/8 (85.7)
O-Ring: [1] Attached
Shell
O.D. 2 13/16 (71.4)
I.D. 1 3/4 (44.5)
Height 3 29/32 (99.2)

RS5273



Radial Seal Outer Air Element
Fits: Case-IH, Kubota, New Holland Equipment
Use With: PA4633
Replaces: Case 87300190, SBA314531174; Kubota 6C6099410
O.D.: 3 17/32 (89.7)
I.D.: 1 17/32 (38.9) One End
Height: 7 (177.8)

PA5274



Outer Air Element
Use With: PA5275
Replaces: Dongfeng 1109N12020; Donaldson P500940; Fleetguard AF25276
O.D.: 11 13/16 (300.0)
I.D.: 11/32 (8.7) & 7 7/8 (200.0)
Height: 18 3/4 (476.3)
A. Gskt: [1] Attached

PA5275



Inner Air Element
Fits Inside: PA5274
Replaces: Dongfeng 1109N12030; Donaldson P500941; Fleetguard AF25277
O.D.: 7 15/32 (189.7)
I.D.: 11/16 (17.5) & 6 1/2 (165.1)
Height: 17 19/32 (446.9)
A. Gskt: [1] Attached

PA5276



Hydraulic Breather Element
Fits: Komatsu Dump Trucks, Equipment
Replaces: Komatsu 4216035170
O.D.: 2 5/32 (54.8)
I.D.: 7/8 (22.2) & 1 1/32 (26.2)
Height: 1 9/32 (32.5)

CA5278



Channel Flow Air Element
Notes: Sometimes used with PA4704 Secondary Air Element
Fits: Valtra Tractors
Replaces: Valtra 36539600
O.D.: 5 1/8 (130.2) to 12 13/16 (325.4)
Height: 7 5/16 (185.7)

PA5281



Cab Air Element with Foam Wrap
Contains: Charcoal Impregnated Media for Odor Control.
Fits: John Deere Sprayers, Tractors
Replaces: John Deere RE199681
O.D.: 7 15/16 (201.6)
I.D.: 9/16 (14.3) & 3 17/32 (89.7)
Height: 12 1/4 (311.2)

PA5282



Cab Air Element
Fits: John Deere Tractors
Replaces: John Deere RE73220
Length: 15 11/32 (389.7)
Width: 4 29/32 (124.6)
Height: 1 7/16 (36.5)

PA5283



Cab Air Element
Fits: Gleaner, Massey Ferguson, White Combines
Replaces: Agco 71362389
Length: 23 29/32 (607.2)
Width: 9 (228.6)
Height: 2 1/4 (57.2)

BA5284



Coalescer Air Dryer Spin-on
Fits: Van Hool CL915, CL916 Buses with DAF Engines; DAF Trucks
Replaces: DAF 1681575, 1821580; Donaldson P951411
Thread: M41 x 1.5
O.D.: 5 7/16 (138.1)
Height: 6 9/16 (166.7)
I.Gskt: [1] Included
O-Ring: [1] Included
Related To: BA5376 (Desiccant Version)

Measurements Are Shown In Inches And (Millimeters)

WARNING: These products can expose you to chemicals, including Diisononyl Phthalate, Carbon black extracts, Nickel, 1,3 Butadiene, Ethylene Oxide, Epichlorohydrin, which are known to the State of California to cause cancer, and Bisphenol, Ethylene Glycol, Ethylene Oxide, 1,3 Butadiene, Epichlorohydrin, which are known to the State of California to cause birth defects or other reproductive harm. For more information go to www.P65Warnings.ca.gov.

RS5285 Radial Seal Cab Air Element
Fits: Case Loaders; New Holland Motor Graders, Wheel Loaders
Replaces: Case 87712194, 76303305; New Holland 87712194, 76303305
O.D.: 6 1/4 (158.8)
I.D.: 2 3/4 (69.9) One End
Height: 10 29/32 (277.0)



PA5289 Primary Oval Air Element with Lid
Notes: Open one end only.
Fits: Caterpillar Equipment
Use With: PA5290 Secondary
Replaces: Caterpillar 3466687
O.D.: 5 5/8 to 11 1/4 (142.9 to 285.8)
 Lid 5 5/16 to 11 7/8 (134.9 to 301.6)
I.D.: 7/8 (22.2) & 6 (152.4) to
Height: 8 3/8 (212.7)



RS5287 Radial Seal Outer Air Element
Notes: Inside-Out Flow Direction.
Contains: Inlet Adapter
Fits: Kenworth, Peterbilt Trucks
Replaces: Donaldson P625128
O.D.: 13 1/8 (333.0)
I.D.: 7 5/8 (193.8) & 4 5/8 (117.6)
Height: 25 7/8 (657.35)
F. Gskt: [1] Included
Related To: RS5287XP (Extreme Performance Nano Version)



PA5290 Secondary Oval Air Element
Fits: Caterpillar Equipment
Use With: PA5289
Replaces: Caterpillar 3466688
O.D.: 5 3/16 (131.8)
 to 10 5/16 (261.9)
Height: 1 1/2 (38.1)



RS5287XP Extreme Performance Nano Radial Seal Outer Air Element
Notes: Inside-Out Flow Direction.
Contains: Inlet Adapter
Fits: Kenworth W900 Truck; Peterbilt 388, 389 Trucks
Replaces: Paccar P614556, X011622
O.D.: 12 3/32 (307.2)
I.D.: 4 5/8 (117.5) & 7 5/8 (193.7)
Height: 25 7/8 (657.35)
F. Gskt: [1] Included
Related To: RS30187XP (Premium Housing Gasket), RS5287 (Standard Version)



RS5291 Radial Seal Outer Air Element
Fits: New Holland TF210, TG230, TG255, 285 Tractors
Use With: RS5292
Replaces: New Holland 451525A1
O.D.: 11 (279.4)
I.D.: 7 3/32 (180.2) One End
Height: 15 3/4 (400.0)



RS5288 Radial Seal Outer Air Element
Contains: Inlet Adapter
Fits: Kenworth C500, C550, T800, W900; Peterbilt 367, 388, 389 Trucks
Replaces: Donaldson P625287
O.D.: 11 13/32 (289.6)
I.D.: 7 5/8 (193.5) & 3 25/32 (96.0)
Height: 24 5/32 (613.41)
F. Gskt: [1] Included
Related To: RS5288XP (Extreme Performance Nano Version)



RS5292 Radial Seal Inner Air Element
Fits Inside: RS5291
Fits: New Holland TF210, TG230, TG255, TG285 Tractors
Replaces: New Holland 451526A1
O.D.: 6 11/16 (169.9)
 Flange 7 1/4 (184.2)
I.D.: 5 7/16 (138.1) One End
Height: 15 (381.0)



RS5288XP Extreme Performance Nano Radial Seal Outer Air Element
Contains: Inlet Adapter
Fits: Kenworth, Peterbilt Trucks
Replaces: Paccar P614986
O.D.: 11 13/32 (289.7)
I.D.: 3 25/32 (96.0) & 7 5/8 (193.7)
Height: 24 5/32 (613.41)
F. Gskt: [1] Included
Related To: RS5288 (Standard Version)



RS5293 Radial Seal Outer Air Element
Fits: Caterpillar Off-Highway Trucks; Donaldson G200088, G290055 Housings
Use With: RS5294
Replaces: Caterpillar 2777837, 4199172; Donaldson P609519; Fleetguard AF27698
O.D.: 17 23/32 (450.1)
I.D.: 11 7/16 (290.5) One End
Height: 30 1/32 (762.8)
Related To: RS5293XP (Extreme Performance Nano Version)



RS5293XP Extreme Performance Nano Radial Seal Outer Air Element
Fits: Caterpillar Off-Highway Trucks; Donaldson G200088, G290055 Housings
Use With: RS5294
Replaces: Caterpillar 2777837, 4199172; Donaldson P609519; Fleetguard AF27698
O.D.: 17 23/32 (450.1)
I.D.: 11 7/16 (290.5) One End
Height: 30 1/32 (762.8)
Related To: RS5293 (Standard Media Version)



Measurements Are Shown In Inches And (Millimeters)

WARNING: These products can expose you to chemicals, including Diisononyl Phthalate, Carbon black extracts, Nickel, 1,3 Butadiene, Ethylene Oxide, Epichlorohydrin, which are known to the State of California to cause cancer, and Bisphenol, Ethylene Glycol, Ethylene Oxide, 1,3 Butadiene, Epichlorohydrin, which are known to the State of California to cause birth defects or other reproductive harm. For more information go to www.P65Warnings.ca.gov.

<p>RS5294</p> 	<p>Radial Seal Inner Air Element Fits Inside: RS5293 Fits: Caterpillar Off-Highway Trucks; Donaldson G200088, G290055 Housings Replaces: Caterpillar 2777838; Donaldson P609518; Fleetguard AF27698 O.D.: 11 9/16 (293.7) I.D.: 9 (228.6) One End Height: 24 3/8 (619.1)</p>	<p>PA5302</p>  <p>Air Element in Disposable Housing Fits: Winpower Generators Replaces: Fleetguard AH1100 O.D.: 15 5/16 (388.9) Outlet: 5 1/2 Height: 12 1/4 (311.2) F. Gskt: [4] Included</p>
<p>PA5297</p> 	<p>Outer Air Element Notes: Metal washer welded on one end. Fits: Valtra Tractors Use With: PA5298 Replaces: Agco 836862573; Valtra V836862573; Fleetguard AF26665 O.D.: 7 27/32 (199.2) I.D.: 13/32 (10.3) & 5 (127.0) Height: 15 9/16 (395.3) A. Gskt: [1] Attached</p>	<p>PA5303</p>  <p>Air Element in Disposable Housing Replaces: Cummins 3315742; Fleetguard AH1101 O.D.: 17 5/8 (447.7) Outlet: 5 1/2 Height: 19 13/16 (503.2) F. Gskt: [4] Included</p>
<p>PA5298</p> 	<p>Inner Air Element Notes: Metal washer welded on one end. Fits Inside: PA5297 Fits: Valtra Tractors Replaces: Agco 836862574; Valtra V836862574; Fleetguard AF27681 O.D.: 4 29/32 (124.6) I.D.: 7/16 (11.1) & 3 31/32 (100.8) Height: 16 21/32 (423.1) A. Gskt: [1] Attached</p>	<p>RS5304</p>  <p>Radial Seal Inner Air Element Fits Inside: RS3971 Fits: Volvo Excavators, Loaders Replaces: Agco 4270036M1; Case KLH10560; J.C. Bamford 32/925402; New Holland 87682992; Volvo 11110284 O.D.: 4 1/4 (108.0) I.D.: 3 3/8 (85.7) One End Height: 15 5/32 (385.0)</p>
<p>PA5299</p> 	<p>Cab Air Element Fits: Massey Ferguson Equipment Replaces: Massey Ferguson 1078061M1 Length: 33 (838.2) Width: 4 (101.6) Height: 2 7/32 (56.4)</p>	<p>RS5305</p>  <p>Radial Seal Cab Air Element Fits: Caterpillar Loaders Replaces: Caterpillar 149-1912; Donaldson P195930, P609447 O.D.: 6 1/2 (165.1) I.D.: 3 9/16 (90.5) One End Height: 11 27/32 (300.8) Related To: RS5761 (Charcoal Media Version)</p>
<p>PA5300</p> 	<p>Cab Air Element with Pull Tabs Fits: Caterpillar Equipment Replaces: Caterpillar 180-7487; Donaldson P606762; Fleetguard AF25780 Length: 16 13/16 (427.0) Width: 11 11/16 (296.9) Height: 2 9/16 (65.1) A. Gskt: [1] Included</p>	<p>PA5306</p>  <p>Cab Air Element Fits: Kenworth Trucks Replaces: Kenworth 525507, 525507BSM Length: 13 7/8 (352.4) Width: 10 3/32 (256.4) Height: 7/8 (22.2)</p>
<p>RS5301</p> 	<p>Radial Seal Air Element Fits: Mack Trucks Replaces: Renault 5010315990; Donaldson P782137; Fleetguard AF25898 O.D.: 9 11/16 (246.1) I.D.: 4 7/8 (123.8) One End Height: 14 5/8 (371.5)</p>	<p>PA5310</p>  <p>Pre-Filter Cab Air Element Fits: Volvo Equipment Replaces: Volvo 11703979 Length: 17 1/8 (435.0) Width: 4 13/16 (122.2) Height: 1 3/4 (44.4) A. Gskt: [1] Included</p>









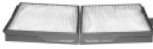

Measurements Are Shown In Inches And (Millimeters)

WARNING: These products can expose you to chemicals, including Diisononyl Phthalate, Carbon black extracts, Nickel, 1,3 Butadiene, Ethylene Oxide, Epichlorohydrin, which are known to the State of California to cause cancer, and Bisphenol, Ethylene Glycol, Ethylene Oxide, 1,3 Butadiene, Epichlorohydrin, which are known to the State of California to cause birth defects or other reproductive harm. For more information go to www.P65Warnings.ca.gov.

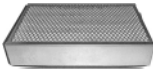
<p>PA5311 Air Breather Element Fits: Volvo Equipment Replaces: Volvo 11707077, 11707077-1 O.D.: 4 5/32 (105.6) I.D.: 2 15/32 (62.7) Height: 2 7/8 (73.0)</p> 	<p>PA5318 Set of 2 Cab Air Elements Notes: Uses 2 filters per application. Fits: Western Star Trucks Replaces: Alliance 384160, RD384160 Each Filter: Length: 11 15/16 (303.2) Width: 5 7/16 (138.1) Height: 7/8 (22.2)</p> 
<p>PA5312 KIT Air Element Kit Contains: [1] Panel Air Element [1] Breather Element Fits: Scania Trucks Replaces: Scania 1485187, 1485188, 1486634 Panel Air Length: 1 3/16 (30.2) Width: 6 31/32 (177.0) Height: 2 5/8 (66.7) Breather O.D. 3 27/32 (97.6) Height: 1 3/16 (30.2)</p> 	<p>PA5319 Cab Air Element Fits: Freightliner Trucks Replaces: Alliance ABPN83328345, N8328345; Freightliner 22446600, 2244665000; Fleetguard AF25697 Length: 10 19/32 (269.1) Width: 10 19/32 (269.1) Height: 3/4 (19.0)</p> 
<p>RS5313 Radial Seal Inner Air Element Fits Inside: RS3726 Fits: Scania Trucks Replaces: Scania 1335680; Fleetguard AF25969 O.D.: 6 7/8 (174.6) I.D.: 5 5/32 (131.0) One End Height: 19 23/32 (500.9)</p> 	<p>PA5320 Insert for Cab Air Element Fits: Peterbilt Trucks Replaces: Elixaire 5X010007 Length: 10 13/16 (274.6) Width: 8 1/8 (206.4) Height: 25/32 (19.8) A. Gskt: [2] Attached</p> 
<p>PA5314 Cab Air Element Fits: John Deere Equipment Replaces: John Deere AT191102 Length: 9 5/16 (236.5) Width: 6 11/32 (161.1) Height: 2 9/32 (57.9)</p> 	<p>PA5321 Cab Air Element Fits: Peterbilt Trucks Replaces: Elixaire 5X000180, 5X000190 Length: 11 1/8 (282.6) Width: 6 25/32 (172.2) Height: 25/32 (19.8)</p> 
<p>PA5315 Panel Air Element Fits: John Deere Equipment Replaces: Elgin 7172355; Donaldson P113407 Length: 20 (508.0) Width: 7 1/2 (190.5) Height: 2 3/16 (55.6) A. Gskt: [1] Attached Related To: PA2354 (without Attached Gasket)</p> 	<p>PA5323 Air Element with Lid and 6 Bolt Holes Replaces: Fleetguard AF25593; Nelson 64288P O.D.: 12 3/32 (307.2) Lid 16 1/4 (412.8) I.D.: 7 23/32 (196.1) One End Height: 23 3/4 (603.3) A. Gskt: [2] Attached</p> 
<p>PA5316 Wire Mesh Supported Hydraulic Breather Fits: Case, J.C. Bamford, Kobelco, Link-Belt, Volvo Excavators Replaces: Volvo 14500233 O.D.: 2 5/32 (54.8) I.D.: 1 7/32 (31.0) Height: 1 1/2 (38.1) A. Gskt: [2] Attached</p> 	<p>RS5325 Radial Seal Air Element Fits: Carrier Refrigeration Units Replaces: Carrier 300042624, 300042627 O.D.: 4 5/32 (105.6) I.D.: 3 (76.2) One End Height: 10 23/32 (272.3)</p> 
<p>PA5317 Cab Air Element with Handle Fits: Volvo Excavators Replaces: Volvo 14503269 Length: 12 13/16 (325.4) Width: 6 1/32 (153.2) Height: 2 9/32 (57.9) A. Gskt: [1] Attached</p> 	<p>PA5326 Air Element in Disposable Housing Fits: Ingersoll-Rand Equipment Replaces: Ingersoll-Rand 85413458; Donaldson ECC065003 O.D.: 6 5/8 (168.3) I.D.: 2 5/16 (58.7) One End Height: 6 5/16 (160.3)</p> 

Measurements Are Shown In Inches And (Millimeters)

WARNING: These products can expose you to chemicals, including Diisononyl Phthalate, Carbon black extracts, Nickel, 1,3 Butadiene, Ethylene Oxide, Epichlorohydrin, which are known to the State of California to cause cancer, and Bisphenol, Ethylene Glycol, Ethylene Oxide, 1,3 Butadiene, Epichlorohydrin, which are known to the State of California to cause birth defects or other reproductive harm. For more information go to www.P65Warnings.ca.gov.

<p>PA5327 Cab Air Element Fits: Komatsu Equipment Replaces: Komatsu 20Y-979-6261 Length: 10 (254.0) Width: 5 5/8 (142.9) Height: 25/32 (19.8)</p> 	<p>RS5335 Radial Seal Inner Air Element Fits Inside: RS5334 Fits: Caterpillar, Komatsu Equipment Replaces: Komatsu 600-185-2500, 600-185-2520 O.D.: 4 1/4 (108.0) I.D.: 3 3/8 (85.7) One End Height: 15 (381.0)</p> 
<p>PA5328 Cab Air Element Fits: Komatsu Equipment Replaces: Komatsu 17M-911-3530 Length: 8 15/16 (227.0) Width: 6 19/32 (167.5) Height: 2 1/8 (54.0)</p> 	<p>PA5336 Cab Air Element Fits: Iveco Trucks Replaces: Iveco 504024890; Fleetguard AF26146 Length: 17 21/32 (448.5) Width: 8 1/8 (206.4) Height: 1 (25.4) Related To: PA5476 (Charcoal Media Version)</p> 
<p>RS5329 Radial Seal Inner Air Element Fits Inside: RS4992 Fits: John Deere Equipment Replaces: John Deere AT300488, AT314583 O.D.: 4 25/32 (121.4) Flange 7 1/4 (184.2) I.D.: 3 5/8 (92.1) One End Height: 16 1/8 (409.6)</p> 	<p>PA5337 Cab Air Element Fits: Sterling Trucks Replaces: Ford F6HZ-19N619-AA Length: 8 5/8 (219.1) Width: 6 3/16 (157.2) Height: 1 11/32 (34.1) A. Gskt: [1] Included</p> 
<p>PA5331 Cab Air Element Fits: Volvo Motor Graders Replaces: Volvo 12725424 Length: 12 9/32 (311.9) Width: 7 9/16 (192.1) Height: 2 7/16 (61.9) A. Gskt: [1] Attached</p> 	<p>PA5338-FN Air Element with Lid and Fins Fits: J.C. Bamford Equipment Replaces: J.C. Bamford 32/925594 O.D.: 6 13/16 (173.0) I.D.: 19/32 (15.1) & 2 27/32 (72.2) Height: 11 23/32 (297.7) A. Gskt: [1] Attached F. Gskt: [1] Wing Nut</p> 
<p>RS5332 Radial Seal Air Element Fits: Volvo Equipment Replaces: Volvo Penta 3827643 O.D.: 11 31/32 (304.0) I.D.: 7 3/8 (187.3) One End Height: 19 1/8 (485.8)</p> 	<p>PA5339 Cab Air Element Fits: M.A.N. Trucks Replaces: M.A.N. 85.619.500.025; Fleetguard AF26231 Length: 13 31/32 (354.8) Width: 6 3/16 (157.2) Height: 1 19/32 (40.5) A. Gskt: [2] Attached</p> 
<p>PA5333 Cab Air Element Fits: New Holland Equipment Replaces: Case/New Holland 86504784 Length: 8 3/32 (205.6) Width: 5 9/32 (134.1) Height: 1 5/8 (41.3)</p> 	<p>PA5340 Cab Air Element Fits: Mercedes-Benz Trucks Replaces: Mercedes-Benz 9738350147; Fleetguard AF26144 Length: 22 23/32 (577.1) Width: 6 7/16 (163.5) Height: 1 15/32 (37.3) A. Gskt: [1] Attached</p> 
<p>RS5334 Radial Seal Outer Air Element Fits: Caterpillar, Komatsu Equipment Use With: RS5335 Replaces: Komatsu 600-185-2510, 600-185-2500 O.D.: 7 11/32 (186.5) I.D.: 4 5/32 (105.6) One End Height: 15 17/32 (394.5)</p> 	<p>PA5341 Cab Air Element Fits: DAF Trucks Replaces: DAF 1362124; Fleetguard AF26145 Length: 10 11/32 (262.7) Width: 6 1/2 (165.1) Height: 1 9/16 (39.7) A. Gskt: [1] Attached</p> 

Measurements Are Shown In Inches And (Millimeters)

WARNING: These products can expose you to chemicals, including Diisononyl Phthalate, Carbon black extracts, Nickel, 1,3 Butadiene, Ethylene Oxide, Epichlorohydrin, which are known to the State of California to cause cancer, and Bisphenol, Ethylene Glycol, Ethylene Oxide, 1,3 Butadiene, Epichlorohydrin, which are known to the State of California to cause birth defects or other reproductive harm. For more information go to www.P65Warnings.ca.gov.

<p>RS5342</p>  <p>Radial Seal Air Element with Lid Fits: Mercedes-Benz Trucks Replaces: Mercedes-Benz 60949604, A0030949604; Fleetguard AF25653 O.D.: 11 7/32 (285.0) Lid 13 15/32 (342.1) I.D.: 5 1/32 (127.8) One End Height: 13 25/32 (350.0)</p>	<p>RS5348</p>  <p>Radial Seal Outer Air Element Notes: OBSOLETE. Availability Limited to Dealer Stock. Use With: RS5347 Replaces: Reytor IT2004 O.D.: 9 15/32 (240.5) I.D.: 5 9/16 (141.3) One End Height: 16 11/32 (415.1)</p>
<p>RS5343</p>  <p>Radial Seal Air Element with Lid Fits: Mercedes-Benz Trucks Replaces: Mercedes-Benz 40940204, A0040940204; Fleetguard AF25476 O.D.: 11 7/32 (285.0) Lid 13 17/32 (343.7) I.D.: 5 1/32 (127.8) One End Height: 15 31/32 (405.6)</p>	<p>PA5350</p>  <p>Air Element Fits: Stihl Saws Replaces: Stihl 42241401801A Length: 4 11/16 (119.1) Width: 3 9/32 (83.3) Height: 15/16 (23.8)</p>
<p>RS5344</p>  <p>Radial Seal Outer Air Element Use With: RS5345 Replaces: Reytor IT2000; Fleetguard AF25856 O.D.: 10 1/32 (254.8) I.D.: 4 31/32 (126.2) One End Height: 16 7/16 (417.5)</p>	<p>RS5351</p>  <p>Radial Seal Air Element Notes: Sometimes used as Inner Air Element with RS3727. Fits: R.V.I. Trucks Replaces: Renault 5010317187; Fleetguard AF25634; Donaldson P780624 O.D.: 7 1/16 (179.4) I.D.: 5 11/16 (144.5) One End Height: 17 1/2 (444.5)</p>
<p>RS5345</p>  <p>Radial Seal Inner Air Element Fits Inside: RS5344 Replaces: Reytor IT2000S; Fleetguard AF25857 O.D.: 5 1/8 (130.2) I.D.: 4 3/8 (111.1) One End Height: 15 (381.0)</p>	<p>CA5352</p>  <p>Channel Flow Air Element Fits: Chevrolet Silverado, GMC Sierra Replaces: GMC 15282462; Donaldson P605313, P610875 O.D.: 9 5/16 (236.5) Height: 6 9/32 (159.5) A. Gskt: [1] Attached</p>
<p>RS5347</p>  <p>Radial Seal Inner Air Element Notes: OBSOLETE. Availability Limited to Dealer Stock. Fits Inside: RS5348 Replaces: Reytor IT2002S; Luber-finer LAF5764 O.D.: 5 3/4 (146.0) I.D.: 4 7/8 (123.8) One End Height: 15 1/2 (393.7)</p>	<p>PA5353</p>  <p>Panel Air Element Fits: Stihl TS700 Saw Replaces: Stihl 42241410300A; SF Filter SL1551 Length: 5 5/8 (142.9) Width: 4 1/32 (102.4) Height: 1 7/8 (47.6)</p>
	<p>RS5354</p>  <p>Radial Seal Outer Air Element Fits: John Deere Sprayers, Tractors Use With: RS5355 Replaces: John Deere RE210102; Fleetguard AF26337 O.D.: 12 3/32 (307.2) I.D.: 7 13/16 (198.4) One End Height: 12 11/16 (322.3)</p>

Measurements Are Shown In Inches And (Millimeters)

WARNING: These products can expose you to chemicals, including Diisononyl Phthalate, Carbon black extracts, Nickel, 1,3 Butadiene, Ethylene Oxide, Epichlorohydrin, which are known to the State of California to cause cancer, and Bisphenol, Ethylene Glycol, Ethylene Oxide, 1,3 Butadiene, Epichlorohydrin, which are known to the State of California to cause birth defects or other reproductive harm. For more information go to www.P65Warnings.ca.gov.

<p>RS5355 Radial Seal Inner Air Element Fits Inside: RS5354 Fits: John Deere Sprayers, Tractors Replaces: John Deere RE210103; Fleetguard AF26336 O.D.: 7 5/32 (181.8) I.D.: 5 27/32 (148.4) One End Height: 11 23/32 (297.7)</p> 	<p>RS5361 Radial Seal Inner Air Element Fits Inside: RS4971; RS5534 Fits: ERF, ECM, ECT Series Trucks; M.A.N. Buses, Trucks Replaces: M.A.N. 81.084.050.017; Donaldson P782937; Fleetguard AF25896 O.D.: 6 3/32 (154.8) I.D.: 5 11/32 (135.7) One End Height: 16 (406.4) I.Gskt: [1] Included</p> 
<p>RS5356 Radial Seal Air Element Contains: Flame Retardant Media Fits: Iveco Trucks Replaces: Iveco 41272124; Donaldson P785352; Fleetguard AF26241 O.D.: 12 7/32 (310.4) I.D.: 8 1/32 (204.0) One End Height: 18 7/32 (462.8)</p> 	<p>PA5363 Cab Air Element Fits: Caterpillar Loaders Replaces: Caterpillar 170-7272; Donaldson P609444 Length: 15 5/8 (396.9) Width: 10 1/32 (254.8) Height: 1 1/32 (26.2) A. Gskt: [1] Attached</p> 
<p>PA5357 Outer Air Element with Lift Bar Fits: Case, New Holland Tractors Replaces: Case 82034446 O.D.: 8 1/2 (215.9) Boot Gasket 10 (254.0) I.D.: 19/32 (15.1) & 4 27/32 (123.0) Height: 15 19/32 (396.1) A. Gskt: [2] Attached F. Gskt: [2] Included</p> 	<p>PA5364 Outer Air Element Contains: Flame Retardant Media Fits: Iveco Trucks with Cursor 13 Engine Use With: PA5365 Replaces: Iveco 2992374, 41272211; Fleetguard AF26204 O.D.: 12 7/8 (327.0) I.D.: 13/32 (10.3) & 8 1/2 (215.9) Height: 18 11/32 (465.9) A. Gskt: [1] Attached F. Gskt: [1] Washer</p> 
<p>RS5358 Radial Seal Outer Air Element Contains: Flame Retardant Media Fits: Mercedes-Benz Trucks Use With: RS5549 Replaces: Mercedes-Benz 40943504, A0040943504; Fleetguard AF26242 O.D.: 10 17/32 (267.5) I.D.: 6 19/32 (167.5) One End Height: 20 13/16 (528.6) Related To: RS5508 (without Flame Retardant Media)</p> 	<p>PA5365 Inner Air Element Fits Inside: PA5364 Fits: Iveco Trucks with Cursor 13 Engine Replaces: Iveco 2996157, 41214149; Fleetguard AF26245 O.D.: 7 7/8 (200.0) I.D.: 21/32 (16.7) & 7 5/8 (193.7) Height: 18 5/32 (461.2) A. Gskt: [2] Attached</p> 
<p>PA5359 Cab Air Element Fits: Freightliner Trucks; Thomas Buses Replaces: Alliance ABP/N10G-36000006; Freightliner 36000006, VCC36000006; Wix 49082 Length: 8 5/8 (219.1) Width: 8 11/32 (211.9) Height: 31/32 (24.6)</p> 	<p>CA5366 Channel Flow Air Element Fits: Ford Trucks Replaces: Ford 4C4Z-9601-AA; Motorcraft FA1753; Donaldson P609086; Fleetguard AF26493 O.D.: 7 5/16 (185.7) to 11 7/16 (290.5) Height: 9 3/16 (233.4) A. Gskt: [1] Included</p> 
<p>RS5360 Radial Seal Air Element Fits: DAF Trucks Replaces: DAF 1363025, 1640920, 1657522; Fleetguard AF25976 O.D.: 10 7/16 (265.1) I.D.: 6 3/16 (157.2) One End Height: 16 15/32 (418.3)</p> 	<p>CA5368 Channel Flow Air Element Fits: Freightliner Business Class M2 Trucks Replaces: Donaldson P607965, P544325 O.D.: 11 31/32 (304.0) 14 7/8 (377.8) Height: 8 1/32 (204.0) Related To: CA5419 (Flame Retardant Media Version)</p> 

Measurements Are Shown In Inches And (Millimeters)

WARNING: These products can expose you to chemicals, including Diisononyl Phthalate, Carbon black extracts, Nickel, 1,3 Butadiene, Ethylene Oxide, Epichlorohydrin, which are known to the State of California to cause cancer, and Bisphenol, Ethylene Glycol, Ethylene Oxide, 1,3 Butadiene, Epichlorohydrin, which are known to the State of California to cause birth defects or other reproductive harm. For more information go to www.P65Warnings.ca.gov.

CA5369



Channel Flow Air Element
Fits: Ford Super Duty Trucks with V8-391 (6.4L) Turbo Diesel Engine
Replaces: Ford 7C3Z-9601-B; Motorcraft FA1886; Donaldson P613522
O.D.: 6 1/32 (153.2)
 to 11 7/8 (301.6)
Height: 8 23/32 (221.5)
A. Gskt: [1] Included

CA5370



Channel Flow Air Element
Fits: Chevrolet Express Van, GMC Savana
Replaces: General Motors 15102546
O.D.: 5 31/32 (151.6)
 to 10 29/32 (277.0)
Height: 6 9/32 (159.5)
A. Gskt: [1] Included

BA5371



Desiccant Air Dryer Spin-on
Fits: Haldex Pure Air Plus DA33100, DA33105, DA33110, DA33200 Air Dryers
Replaces: Haldex DA33120
Thread: 2 1/2 -12
O.D.: 5 7/32 (132.6)
Height: 6 5/8 (168.3)
I.Gskt: [1] Included

BA5373



Desiccant Air Dryer Spin-on
Contains: Grease Tube
Fits: Ford, Freightliner, Hino, Kenworth, Peterbilt Trucks
Replaces: Bendix 065624, 109493
Thread: 1 1/4 -17
O.D.: 7 9/32 (184.9)
 Flange 8 3/8 (212.7)
Height: 7 17/32 (191.3)
O-Ring: [2] Attached, [2] Included

BA5374



Desiccant Air Dryer Spin-on
Fits: Blue Bird, Kassbohrer, Setra Buses; DAF, E.R.F., Freightliner, IHC, Iveco, Kenworth, Mack, M.A.N., Mercedes-Benz, Peterbilt, R.V.I., Sterling, Volvo Trucks; Liebherr Cranes
Replaces: Caterpillar 2032389; Iveco 2992261; Ford 4C452A131AA; General Motors 89040662; Hengst T250W; Mann & Hummel TB1374x
Thread: M39 x 1.5
O.D.: 5 1/2 (139.7)
Height: 6 9/16 (166.7)
I.Gskt: [1] Included
O-Ring: [1] Included
Related To: BA5379 (Coalescer Version)

BA5375



Desiccant Air Dryer Spin-on
Fits: R.V.I., Scania Trucks
Replaces: Scania 1384549, 1455253
Thread: 1 1/4 -11 BSP-PL
O.D.: 5 1/2 (139.7)
Height: 6 31/32 (177.0)
I.Gskt: [1] Included
O-Ring: [1] Included
Related To: BA5378 (Coalescer Version)

BA5376



Desiccant Air Dryer Spin-on
Fits: Van Hool CL915, CL916 Buses with DAF Engines
Replaces: DAF 1391510; Hengst T200W
Thread: M41 x 1.5
O.D.: 5 1/2 (139.7)
Height: 5 15/32 (138.9)
I.Gskt: [1] Included
O-Ring: [1] Included
Related To: BA5284 (Coalescer Version)

BA5377



Desiccant Air Dryer
Contains: Threaded Stud: 5/8-11 Grease Tube
Fits: Blue Bird, Thomas Buses; Autocar, Capacity, Freightliner, IHC, Kenworth, Mack, Oshkosh, Peterbilt, Sterling, Western Star Trucks
Replaces: Bendix 107794, 107796
O.D.: 4 17/32 (115.1)
 Lid 5 27/32 (148.4)
Height: 10 23/32 (272.3)
O-Ring: [2] Included

BA5378



Coalescer Air Dryer Spin-on
Fits: Scania Trucks
Replaces: Scania 1774598; Donaldson P783753
Thread: 1 1/4 -11 BSP-PL
O.D.: 5 11/32 (135.7)
Height: 7 (177.8)
I.Gskt: [1] Included
O-Ring: [1] Included
Related To: BA5375 (Desiccant Version)

BA5379



Coalescer Air Dryer Spin-on
Fits: M.A.N. TGA Series, TGM Series, TGS Series, TGX Series Trucks
Replaces: Volvo 20557234, 20972915; DAF 1506635; M.A.N. 81.52108.6025; WABCO R950068
Thread: M39 x 1.5
O.D.: 5 3/8 (136.5)
Height: 6 9/16 (166.7)
I.Gskt: [1] Included
O-Ring: [1] Included
Related To: BA5374 (Desiccant Version)

RS5387 KIT



Radial Seal Air Element with Lid
Contains: Plastic lid with dump valve.
Fits: Thermo King Refrigeration Units
Replaces: Thermo King 11-9300 Element
O.D.: 5 (127.0)
I.D.: 1 29/32 (48.4) One End
Height: 9 29/32 (251.6)

PA5388



Air Element with Lid
Fits: Case-International, New Holland Tractors
Replaces: Case 1931168; Donaldson P778702; Fleetguard AF25342
O.D.: 6 3/32 (154.8)
 Lid 8 3/8 (212.7)
I.D.: 19/32 (15.1) & 3 15/32 (88.1)
Height: 13 1/2 (342.9)
A. Gskt: [1] Attached
F. Gskt: [1] Included, [1] Wing Nut

Measurements Are Shown In Inches And (Millimeters)

WARNING: These products can expose you to chemicals, including Diisononyl Phthalate, Carbon black extracts, Nickel, 1,3 Butadiene, Ethylene Oxide, Epichlorohydrin, which are known to the State of California to cause cancer, and Bisphenol, Ethylene Glycol, Ethylene Oxide, 1,3 Butadiene, Epichlorohydrin, which are known to the State of California to cause birth defects or other reproductive harm. For more information go to www.P65Warnings.ca.gov.

RS5389-FN Radial Seal Outer Air Element with Fins
Fits: International WorkStar Trucks
Use With: RS4863
Replaces: International 3551816-C1
O.D.: 12 1/16 (306.4)
 Fins 13 5/16 (338.1)
I.D.: 9 7/8 (250.8) One End
Height: 16 1/32 (407.2)



PA5396 Cab Air Element with Foam
Notes: Uses 2 filters per application.
Fits: Case-International, New Holland Tractors
Replaces: Case 82022328, 820223280, 82034664; New Holland 82022328, 820223280, 82034664
Length: 21 21/32 (550.1)
Width: 3 15/16 (100.0)
Height: 2 1/2 (63.5)
A. Gskt: [1] Attached



RS5390 Radial Seal Air Element
Contains: Flame Retardant Media
Fits: R.V.I., Volvo Trucks
Replaces: Volvo 20732726; R.V.I. 5001865723; Donaldson P780622, P785522, Fleetguard AF26244
O.D.: 12 9/32 (311.9)
I.D.: 6 31/32 (177.0) One End
Height: 18 11/32 (465.9)
Related To: RS3727 (Standard Media Version)



RS5397 Radial Seal Outer Air Element
Fits: Case-International, New Holland Tractors
Use With: RS5398
Replaces: Case 82027573, 82034433, 82034434, 82034440; New Holland 82027573, 82034433, 82034434, 82034440
O.D.: 9 7/8 (250.8)
I.D.: 5 5/16 (134.9) One End
Height: 17 3/16 (436.6)



RS5391 Radial Seal Air Element
Replaces: Iveco 8041419
O.D.: 9 1/2 (241.3)
I.D.: 4 7/8 (123.8) One End
Height: 19 1/2 (495.3)



RS5398 Radial Seal Inner Air Element
Fits Inside: RS5397
Fits: Case, New Holland Tractors
Replaces: Case 82034435, 82034436, 82027574; New Holland 82034435, 82034436, 82027574
O.D.: 5 15/32 (138.9)
I.D.: 4 1/2 (114.3) One End
Height: 16 19/32 (421.5)



RS5392 Radial Seal Inner Air Element
Fits Inside: RS3506, RS3506XP, RS30285
Fits: John Deere Feller Bunchers, Loaders
Replaces: John Deere F435742; Perkins 2652C832
O.D.: 5 29/32 (150.0)
I.D.: 4 3/8 (111.1) One End
Height: 15 23/32 (399.3)



PA5399 Cab Air Element
Fits: Case, New Holland Tractors
Replaces: Case 87302687; New Holland 87302687
Length: 14 31/32 (380.2)
Width: 5 1/8 (130.2)
Height: 1 31/32 (50.0)



PA5393 Foam Cab Air Element
Fits: Sterling Trucks
Replaces: Ford F6HZ-19N619-BA
Length: 5 27/32 (148.4)
Width: 4 17/32 (115.1)
Height: 1 (25.4)

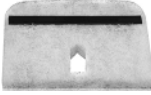

PA5400 Cab Air Element with Foam
Fits: Case-International, New Holland Tractors
Replaces: Case 87311194; New Holland 87311194
Length: 14 31/32 (380.2)
Width: 5 1/8 (130.2)
Height: 2 1/8 (54.0)



RS5395-FN Radial Seal Outer Air Element with Fins
Fits: ASV PT70, PT80 Loaders
Use With: RS3709
Replaces: Donaldson P601437
O.D.: 6 7/8 (174.6)
 Fins 8 3/8 (212.7)
I.D.: 3 1/8 (79.4) One End
Height: 15 13/32 (391.3)



PA5401 Cab Air Element
Replaces: J.C. Bamford 33/125629
Length: 17 1/32 (432.6)
Width: 2 7/8 (73.0)
Height: 1 7/8 (47.6)
A. Gskt: [1] Attached















PA5403 Cab Air Element
Fits: Case-International Tractors
Replaces: Case 82029888, 82034665, 82034663; New Holland 82029888, 82034665, 82034663
Length: 8 3/16 (208.0)
Width: 4 9/16 (115.9)
Height: 1 13/16 (46.0)















Measurements Are Shown In Inches And (Millimeters)

WARNING: These products can expose you to chemicals, including Diisononyl Phthalate, Carbon black extracts, Nickel, 1,3 Butadiene, Ethylene Oxide, Epichlorohydrin, which are known to the State of California to cause cancer, and Bisphenol, Ethylene Glycol, Ethylene Oxide, 1,3 Butadiene, Epichlorohydrin, which are known to the State of California to cause birth defects or other reproductive harm. For more information go to www.P65Warnings.ca.gov.











<p>PA5404 Cab Air Element  Fits: Case-International, New Holland Tractors Replaces: Case C001723, C001896, 82034661, 87385322; New Holland C001723, C001896, 82034661, 87385322 Length: 20 15/32 (519.9) Width: 4 3/32 (104.0) Height: 2 (50.8) A. Gskt: [1] Attached</p>	<p>PA5412 Inner Air Element  Fits Inside: PA3906 Fits: Mitsubishi Trucks Replaces: Mitsubishi AE073385, DC073385, ME073385; Donaldson P815403; Fleetguard AF25582M O.D.: 5 23/32 (145.3) I.D.: 21/32 (16.7) & 4 19/32 (116.7) Height: 16 5/8 (422.3) A. Gskt: [1] Attached F. Gskt: [1] Metal Washer</p>
<p>PA5405 Cab Air Element  Replaces: J.C. Bamford 30/925759 Length: 11 11/32 (288.1) Width: 3 15/32 (88.1) Height: 25/32 (19.8) A. Gskt: [1] Attached</p>	<p>RS5413 Radial Seal Air Element  Notes: Features recessed closed end. Contains: Flame Retardant Media Fits: DAF Trucks Replaces: DAF 1638054; Donaldson P786443 O.D.: 10 31/32 (278.6) I.D.: 5 13/16 (147.6) One End Height: 20 1/32 (508.8)</p>
<p>RS5408 Radial Seal Inner Air Element  Contains: Grease packet Fits Inside: RS4966 Fits: Volvo Trucks Replaces: Volvo 3979928; Fleetguard AF26162; Wix Europe 93250E O.D.: 6 5/8 (168.3) I.D.: 5 (127.0) One End Height: 17 5/16 (439.7)</p>	<p>RS5414 Radial Seal Outer Air Element  Fits: John Deere Equipment Use With: RS5415 Replaces: John Deere AH164062; Donaldson P612469 O.D.: 12 31/32 (329.4) I.D.: 6 13/16 (173.0) One End Height: 23 9/32 (591.3)</p>
<p>RS5409 Radial Seal Air Element  Fits: M.A.N. Trucks Replaces: M.A.N. 81.08405.0022; Donaldson P785002; Fleetguard AF26261 O.D.: 9 3/32 (231.0) I.D.: 5 7/16 (138.1) One End Height: 16 5/16 (414.3)</p>	<p>RS5415 Radial Seal Inner Air Element  Fits Inside: RS5414 Fits: John Deere Equipment Replaces: John Deere AH164063 O.D.: 6 7/8 (174.6) I.D.: 5 7/16 (138.1) One End Height: 22 9/16 (573.1)</p>
<p>PA5410-FN Air Element with Fins  Contains: Flame Retardant Media O.D.: 4 1/8 (104.8) Fins: 5 1/8 (130.2) I.D.: 25/32 (19.8) & 2 1/2 (63.5) Height: 10 3/8 (263.5) A. Gskt: [1] Attached F. Gskt: [1] Metal Washer Related To: PA1690-FN (Standard Media Version)</p>	<p>CA5416 Channel Flow Air Element  Fits: Hummer H2 Replaces: General Motors 15286805, 88944151; ACDelco A2948C, A3100C O.D.: 5 31/32 (151.6) to 10 29/32 (277.0) Height: 7 7/32 (183.4) A. Gskt: [1] Included</p>
<p>RS5411 Radial Seal Air Element  Replaces: Volvo 3827589; Fleetguard AF26237; Alco MD7580 O.D.: 9 27/32 (250.0) I.D.: 4 3/4 (120.7) One End Height: 17 9/16 (446.1)</p>	<p>CA5417 Channel Flow Primary Air Element  Fits: John Deere Tractors Use With: PA5418 Replaces: John Deere RE196945 O.D.: 9 29/32 (251.6) Height: 9 1/8 (231.8) A. Gskt: [1] Included</p>

Measurements Are Shown In Inches And (Millimeters)
WARNING: These products can expose you to chemicals, including Diisononyl Phthalate, Carbon black extracts, Nickel, 1,3 Butadiene, Ethylene Oxide, Epichlorohydrin, which are known to the State of California to cause cancer, and Bisphenol, Ethylene Glycol, Ethylene Oxide, 1,3 Butadiene, Epichlorohydrin, which are known to the State of California to cause birth defects or other reproductive harm. For more information go to www.P65Warnings.ca.gov.

<p>PA5418 Channel Flow Secondary Air Element Fits: John Deere Sprayers, Tractors Use With: CA5417 Replaces: John Deere RE181915 O.D.: 9 3/8 (238.1) Height: 2 3/16 (55.6) A. Gskt: [1] Included</p> 	<p>RS5424 Radial Seal Air Element Fits: Blue Bird Vision Buses Replaces: Blue Bird 0061519, 61519, BB0061519; Racor 500353001 O.D.: 9 5/8 (244.5) I.D.: 4 7/8 (123.8) One End Height: 11 11/32 (288.1)</p> 
<p>CA5419 Channel Flow Air Element Contains: Flame Retardant Media Fits: Freightliner Business Class M2 Series Trucks Replaces: Donaldson P605960 O.D.: 11 31/32 (304.0) Flange 14 7/8 (377.8) Height: 8 1/32 (204.0) A. Gskt: [1] Attached Related To: CA5368 (Standard Media Version)</p> 	<p>PA5425 Air Element with Lid Replaces: Cummins 3351735; Fleetguard AF25688 O.D.: 11 1/8 (282.6) Lid 15 3/32 (383.4) I.D.: 21/32 (16.7) & 6 23/32 (170.7) Height: 15 27/32 (402.4) A. Gskt: [2] Attached</p> 
<p>CA5420 Channel Flow Air Element Contains: Flame Retardant Media Fits: Freightliner Business Class M2 Series Trucks Replaces: Donaldson P607960; Wix 49959 O.D.: 9 29/32 (251.6) Flange 12 25/32 (324.6) Height: 8 1/32 (204.0) A. Gskt: [1] Attached Related To: CA4700 (Standard Media Version)</p> 	<p>PA5426 Panel Air Element with Foam Pad and Lift Tabs Fits: Mercedes-Benz Trucks Replaces: Mercedes-Benz 40941104, A0040941104; Fleetguard AF25731 Length: 24 29/32 (632.6) Width: 22 1/2 (571.5) Height: 3 3/32 (78.6) A. Gskt: [2] Attached</p> 
<p>CA5421 Channel Flow Air Element Replaces: Volvo 70320440 O.D.: 12 1/32 (305.6) Height: 8 3/16 (208.0) A. Gskt: [1] Attached</p> 	<p>PA5428 Panel Air Element Fits: Chevrolet Trucks Replaces: General Motors 19152817; ACDelco A3102C Length: 16 11/16 (423.9) Width: 8 7/8 (225.4) Height: 2 1/4 (57.2)</p> 
<p>RS5422 Radial Seal Air Element Fits: EvoBus, Mercedes-Benz/Setra Buses Replaces: Mercedes-Benz 40941804, A0040941804; Donaldson P783117; Fleetguard AF26172; Hengst E626L O.D.: 7 11/32 (186.5) I.D.: 4 5/32 (105.6) One End Height: 14 1/32 (356.4)</p> 	<p>RS5429 Radial Seal Outer Air Element Fits: John Deere, Liebherr, MacDon Equipment Use With: RS5430 Replaces: Fleetguard AF26124; Wix 49148 O.D.: 10 1/4 (260.3) I.D.: 6 17/32 (165.9) One End Height: 20 7/16 (519.1)</p> 
<p>PA5423-FN Air Element with Fins Replaces: Case 808039R1; John Deere CM18213; Donaldson P900247; Fleetguard AF25027K O.D.: 5 3/16 (131.8) Fins 6 7/16 (163.5) I.D.: 5/8 (15.9) & 3 5/8 (92.1) Height: 11 9/16 (293.7) A. Gskt: [1] Attached</p> 	<p>RS5430 Radial Seal Inner Air Element Fits Inside: RS5429 Fits: John Deere, Liebherr, MacDon Equipment Replaces: Fleetguard AF26125; Wix 49149 O.D.: 5 13/32 (137.3) Flange 8 1/32 (204.0) I.D.: 5 3/16 (131.8) One End Height: 19 17/32 (496.1)</p> 











Measurements Are Shown In Inches And (Millimeters)

WARNING: These products can expose you to chemicals, including Diisononyl Phthalate, Carbon black extracts, Nickel, 1,3 Butadiene, Ethylene Oxide, Epichlorohydrin, which are known to the State of California to cause cancer, and Bisphenol, Ethylene Glycol, Ethylene Oxide, 1,3 Butadiene, Epichlorohydrin, which are known to the State of California to cause birth defects or other reproductive harm. For more information go to www.P65Warnings.ca.gov.

<p>RS5431</p>  <p>Radial Seal Air Element Fits: DAF Trucks Replaces: DAF 1433690, 1644642, 1667999, 1672463, APUC543; Alco MD-7622 O.D.: 8 13/32 (213.5) I.D.: 4 29/32 (124.6) One End Height: 13 3/8 (339.7)</p>	<p>PA5436</p>  <p>Outer Air Element Fits: Challenger, Massey Ferguson Tractors Use With: PA5437 Replaces: Massey Ferguson 3703703-M91; Wix 46497 O.D.: 4 3/32 (104.0) Flange 5 11/16 (144.5) I.D.: 17/32 (13.5) & 2 1/2 (63.5) Height: 10 3/8 (263.5) A. Gskt: [1] Attached F. Gskt: [1] Included</p>
<p>RS5432</p>  <p>Radial Seal Air Element Fits: Volvo-Penta Generators Replaces: Deutz 1182786; M.A.N. 83.08405.0001; Volvo 21377909 O.D.: 9 29/32 (251.6) I.D.: 6 3/16 (157.2) One End Height: 18 29/32 (480.2)</p>	<p>PA5437</p>  <p>Inner Air Element Fits Inside: PA5436 Fits: Agco, Challenger, Massey Ferguson Tractors Replaces: Massey Ferguson 3703704-M91 O.D.: 2 3/8 (60.3) I.D.: 7/16 (11.1) & 2 (50.8) Height: 8 7/8 (225.4)</p>
<p>RS5433</p>  <p>Radial Seal Air Element Contains: Flame Retardant Media Fits: DAF, Kenworth Trucks Replaces: DAF 1668000, 1672464 O.D.: 8 13/32 (213.5) I.D.: 4 11/16 (119.1) One End Height: 16 17/32 (419.9) Related To: RS4970 (Standard Media Version)</p>	<p>RS5438</p>  <p>Radial Seal Air Element Contains: Flame Retardant Media Fits: M.A.N. TGL Series, TGM Series Trucks Replaces: M.A.N. 81.08405.0023; Donaldson P785001; Fleetguard AF26262 O.D.: 8 29/32 (226.2) I.D.: 4 21/32 (118.3) One End Height: 12 (304.8) Related To: RS5536 (Standard Media Version)</p>
<p>RS5434</p>  <p>Radial Seal Air Element Fits: Isuzu Trucks Replaces: Isuzu 8-97062-294-0; Donaldson P543614, P828633 O.D.: 9 9/32 (235.7) I.D.: 5 5/32 (131.0) One End Height: 11 3/8 (288.9)</p>	<p>RS5440</p>  <p>Radial Seal Air Element Use With: RS5548 Replaces: Deutz 1182912 O.D.: 9 15/32 (240.5) I.D.: 5 15/32 (138.9) One End Height: 18 5/16 (465.1)</p>
<p>RS5435</p>  <p>Radial Seal Air Element Fits: J.C. Bamford Fastrac Tractors Replaces: J.C. Bamford 32/210101; Perkins 26510387 O.D.: 8 13/32 (213.5) I.D.: 4 29/32 (124.6) One End Height: 15 19/32 (396.1)</p>	<p>RS5441</p>  <p>Radial Seal Air Element Fits: Nissan Atleon Trucks with Cummins ISB4 Series Engine Use With: RS5547 Replaces: Nissan 16546-LA40A O.D.: 9 3/32 (231.0) I.D.: 5 7/16 (138.1) One End Height: 16 5/16 (414.3)</p>

Measurements Are Shown In Inches And (Millimeters)

WARNING: These products can expose you to chemicals, including Diisononyl Phthalate, Carbon black extracts, Nickel, 1,3 Butadiene, Ethylene Oxide, Epichlorohydrin, which are known to the State of California to cause cancer, and Bisphenol, Ethylene Glycol, Ethylene Oxide, 1,3 Butadiene, Epichlorohydrin, which are known to the State of California to cause birth defects or other reproductive harm. For more information go to www.P65Warnings.ca.gov.

<p>RS5442</p>  <p>Radial Seal Outer Air Element Use With: RS5443 Replaces: Donaldson P601767; Wix 49767 O.D.: 9 5/32 (232.6) I.D.: 4 5/8 (117.5) One End Height: 13 7/16 (341.3)</p>	<p>RS5448</p>  <p>Radial Seal Inner Air Element Fits: Dynapac Rollers Replaces: Dynapac 909271; Donaldson P781471 O.D.: 4 1/4 (108.0) I.D.: 3 7/16 (87.3) One End Height: 19 15/16 (506.4)</p>
<p>RS5443</p>  <p>Radial Seal Inner Air Element Fits Inside: RS5442 Replaces: Donaldson P601774; Wix 49766 O.D.: 4 23/32 (119.9) I.D.: 3 1/4 (82.6) One End Height: 12 25/32 (324.6)</p>	<p>RS5449</p>  <p>Radial Seal Air Element Fits: Caterpillar Generator Sets; Caterpillar, Lister-Petter Industrial Engines Replaces: Caterpillar 246-5011; Lister 75727890; Perkins 135326205 O.D.: 4 1/8 (104.8) I.D.: 2 7/16 (61.9) One End Height: 10 3/4 (273.1)</p>
<p>PA5445</p>  <p>Outer Air Element with Lift Tabs Fits: Hualing 280HP Heavy Truck Use With: PA5446 Replaces: Parker China Division K3250 O.D.: 12 7/8 (327.0) I.D.: 27/32 (21.4) & 8 11/32 (211.9) Height: 19 13/32 (492.9)</p>	<p>CA5450</p>  <p>Channel Flow Primary Air Element Fits: Case, Case-IH, J.C. Bamford, John Deere, New Holland Equipment Use With: PA5451 Replaces: Case 82988916, 87037984, 87356351; J.C. Bamford 32/925682; John Deere FG6340591, RE253518; New Holland 82988916, 87037984, 87356351 O.D.: 5 27/32 (148.4) to 9 13/16 (249.2) Height: 7 1/8 (181.0)</p>
<p>PA5446</p>  <p>Inner Air Element Fits Inside: PA5445 Replaces: Parker China Division K3250 O.D.: 8 9/32 (210.3) I.D.: 29/32 (23.0) & 7 3/32 (180.2) Height: 17 17/32 (445.3) A. Gskt: [1] Attached F. Gskt: [1] Washer</p>	<p>PA5451</p>  <p>Channel Flow Secondary Air Element with Pull Handle Fits: Case, Case-IH, J.C. Bamford, John Deere, New Holland Equipment Use With: CA5450 Replaces: Case 82988917, 87037985, 87356353; New Holland 82988917, 87037985, 87356353; J.C. Bamford 32/925683; John Deere FG6340592, RE253519 O.D.: 4 1/4 (108.0) to 8 1/4 (209.6) Height: 2 9/16 (65.1) A. Gskt: [1] Attached</p>
<p>RS5447</p>  <p>Radial Seal Outer Air Element Fits: Dynapac Rollers Replaces: Dynapac 909270; Donaldson P781470; Fleetguard AF25612 O.D.: 8 5/32 (207.2) I.D.: 4 3/16 (106.4) One End Height: 20 5/8 (523.9)</p>	<p>RS5452</p>  <p>Radial Seal Outer Air Element Fits: Mercedes-Benz Buses, Trucks Replaces: Mercedes-Benz A3740947104; Reytor IT3095 O.D.: 10 29/32 (277.0) I.D.: 6 25/32 (172.2) One End Height: 16 1/2 (419.1)</p>

Measurements Are Shown In Inches And (Millimeters)

WARNING: These products can expose you to chemicals, including Diisononyl Phthalate, Carbon black extracts, Nickel, 1,3 Butadiene, Ethylene Oxide, Epichlorohydrin, which are known to the State of California to cause cancer, and Bisphenol, Ethylene Glycol, Ethylene Oxide, 1,3 Butadiene, Epichlorohydrin, which are known to the State of California to cause birth defects or other reproductive harm. For more information go to www.P65Warnings.ca.gov.

RS5453 Radial Seal Inner Air Element
Fits: Mercedes-Benz Buses
Replaces: Mercedes-Benz A3740947204; Reyor IT3095S
O.D.: 6 1/4 (158.8)
I.D.: 5 1/4 (133.4) One End
Height: 15 5/32 (385.0)



RS5459 Radial Seal Outer Air Element
Fits: Volvo Dump Trucks, Excavators, Loaders
Use With: RS5460
Replaces: Volvo 11110531, 11110532, 15193232
O.D.: 14 7/32 (361.2)
I.D.: 8 15/16 (227.0) One End
Height: 22 7/16 (569.9)



PA5454 Panel Air Element
Contains: Flame Retardant Media
Fits: Waukesha VHP 12, 16 Cylinder Stationary Engines
Replaces: Waukesha 214275A
Length: 25 1/4 (641.3)
Width: 19 1/4 (489.0)
Height: 3 3/4 (95.3)
A. Gskt: [2] Attached



RS5460 Radial Seal Inner Air Element
Fits Inside: RS5459
Fits: Volvo Dump Trucks, Excavators, Loaders
Replaces: Volvo 11110533; Fleetguard AF26491
O.D.: 9 3/32 (231.0)
I.D.: 6 7/8 (174.6) One End
Height: 22 3/32 (561.2)



RS5455 Radial Seal Outer Air Element
Fits: Case-International Equipment; New Holland Tractors
Use With: RS5456
Replaces: Case 367349A1, 87409371
O.D.: 12 1/8 (308.0)
I.D.: 8 1/2 (215.9) One End
Height: 13 3/4 (349.3)



RS5461 Radial Seal Outer Air Element
Fits: J.C. Bamford Equipment
Use With: RS5462
Replaces: J.C. Bamford 32/210001; Coopers AEM2756
O.D.: 9 27/32 (250.0)
I.D.: 7 13/32 (188.1) One End
Height: 19 21/32 (499.3)



RS5456 Radial Seal Inner Air Element
Fits Inside: RS5455
Fits: Case-International, New Holland Equipment
Replaces: Case 367350A1, 87409407; Fleetguard AF25711
O.D.: 8 1/8 (206.4)
I.D.: 6 (152.4) One End
Height: 12 31/32 (329.4)



RS5462 Radial Seal Inner Air Element
Contains: [1] Grease packet
Fits Inside: RS5461
Fits: J.C. Bamford Equipment
Replaces: J.C. Bamford 32/210002
O.D.: 7 5/32 (181.8)
I.D.: 5 1/2 (139.7) One End
Height: 19 1/16 (484.2)



PA5457 Wire Supported Cotton Polyester Industrial Air Element
Replaces: Airguard DP40-204
Length: 24 1/2 (622.3)
Width: 19 1/2 (495.3)
Height: 1 3/4 (44.4)

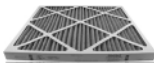

PA5463 Outer Air Element
Use With: PA5464
Replaces: Cummins 3237954; Fleetguard AF25804
O.D.: 14 (355.6)
Boot 14 13/16 (376.2)
I.D.: 21/32 (16.7) & 9 19/32 (243.7)
Height: 26 1/32 (661.2)
A. Gskt: [2] Attached
F. Gskt: [1] Included, [1] Wing Nut













RS5458 Radial Seal Air Element
Fits: Blue Bird Vision Buses
Replaces: Blue Bird 87782
O.D.: 9 31/32 (253.2)
Lid 11 1/2 (292.1)
I.D.: 4 13/16 (122.2) One End
Height: 11 3/8 (288.9)













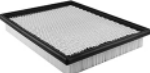

Measurements Are Shown In Inches And (Millimeters)

WARNING: These products can expose you to chemicals, including Diisononyl Phthalate, Carbon black extracts, Nickel, 1,3 Butadiene, Ethylene Oxide, Epichlorohydrin, which are known to the State of California to cause cancer, and Bisphenol, Ethylene Glycol, Ethylene Oxide, 1,3 Butadiene, Epichlorohydrin, which are known to the State of California to cause birth defects or other reproductive harm. For more information go to www.P65Warnings.ca.gov.

<p>PA5464</p>  <p>Inner Air Element Fits Inside: PA5463 Replaces: Cummins 4055279; Donaldson P500922; Fleetguard AF25803 O.D.: 8 13/32 (213.5) I.D.: 11/16 (17.5) & 6 3/16 (157.2) Height: 16 3/4 (425.5) A. Gskt: [1] Attached F. Gskt: [1] Included, [1] Wing Nut</p>	<p>RS5471</p>  <p>Radial Seal Inner Air Element Fits Inside: RS5470, RS5472 Fits: John Deere Combines, Cotton Pickers Replaces: John Deere AH212295; Donaldson P618932; Fleetguard AF26438 O.D.: 7 1/16 (179.4) I.D.: 6 13/32 (162.7) One End Height: 22 1/2 (571.5) O-Ring: [1] Attached</p>
<p>PA5465</p>  <p>Air Element Replaces: Perkins SEV5514 O.D.: 12 23/32 (323.1) I.D.: 1 1/16 (27.0) & 9 9/32 (235.7) Height: 22 3/16 (563.6)</p>	<p>RS5472</p>  <p>Radial Seal Outer Air Element Fits: John Deere Equipment Use With: RS5471 Replaces: John Deere AH222225; Donaldson P618931 O.D.: 12 23/32 (323.1) I.D.: 7 13/16 (198.4) One End Height: 24 5/8 (625.5)</p>
<p>PA5467</p>  <p>Outer Air Element Use With: PA5468 Replaces: Cummins 3814695; Fleetguard AF25910 O.D.: 7 25/32 (197.6) I.D.: 11/32 (8.7) & 4 11/32 (110.3) Height: 12 3/32 (307.2) A. Gskt: [1] Attached F. Gskt: [1] Included</p>	<p>PA5475</p>  <p>Cabin Air Element Fits: Iveco Light-Duty Trucks Replaces: Iveco 3802821; Hengst E2593LI; Mahle LA439; Mann & Hummel CU2952 Length: 11 17/32 (292.9) Width: 7 9/16 (192.1) Height: 1 3/16 (30.2) A. Gskt: [2] Attached</p>
<p>PA5468</p>  <p>Inner Air Element Fits Inside: PA5467 Replaces: Cummins 3814696; Fleetguard AF25911 O.D.: 4 3/32 (104.0) I.D.: 21/32 (16.7) & 3 17/32 (89.7) Height: 10 29/32 (277.0) A. Gskt: [1] Attached F. Gskt: [1] Included</p>	<p>PA5476</p>  <p>Cab Air Element Notes: OBSOLETE. Availability Limited to Dealer Stock. Contains: Charcoal Impregnated Media for Odor Control Fits: Iveco Trucks Replaces: Iveco 2994583; Hengst E1908LC; Mann & Hummel CUK4594 Length: 17 21/32 (448.5) Width: 8 1/8 (206.4) Height: 1 (25.4) Related To: PA5366 (Standard Media)</p>
<p>RS5470</p>  <p>Radial Seal Outer Air Element Fits: John Deere Combines, Cotton Pickers Use With: RS5471 Replaces: John Deere AH212294; Donaldson P618930 O.D.: 11 11/16 (296.9) I.D.: 7 27/32 (199.2) One End Height: 24 5/8 (625.5)</p>	<p>PA5477</p>  <p>Cab Air Element Contains: Charcoal Impregnated Media for Odor Control Fits: M.A.N. Trucks Replaces: M.A.N. 81.61910.0019; Donaldson P786092; Hengst E954LC; Mahle LAK154; Mann & Hummel CUK4795 Length: 18 19/32 (472.3) Width: 7 7/16 (188.9) Height: 2 13/16 (71.4) A. Gskt: [1] Attached Related To: PA4955 (Standard Media Version)</p>

Measurements Are Shown In Inches And (Millimeters)

WARNING: These products can expose you to chemicals, including Diisononyl Phthalate, Carbon black extracts, Nickel, 1,3 Butadiene, Ethylene Oxide, Epichlorohydrin, which are known to the State of California to cause cancer, and Bisphenol, Ethylene Glycol, Ethylene Oxide, 1,3 Butadiene, Epichlorohydrin, which are known to the State of California to cause birth defects or other reproductive harm. For more information go to www.P65Warnings.ca.gov.

<p>RS5478-FN Radial Seal Outer Air Element with Fins Fits: Donaldson FRG09 Housings Use With: RS5479 Replaces: Donaldson P601280; Wix 49280 O.D.: 7 (177.8) Fins 8 1/2 (215.9) I.D.: 4 (101.6) One End Height: 16 7/16 (417.5)</p> 	<p>PA5486 Inner Air Element Fits Inside: PA5485-FN Replaces: Arrow Filter 13023273 O.D.: 4 9/16 (115.9) Flange 5 3/4 (146.0) I.D.: 1/2 (12.7) & 3 7/16 (87.3) Height: 14 23/32 (373.9) A. Gskt: [1] Attached F. Gskt: [1] Included</p> 
<p>RS5479 Radial Seal Inner Air Element Fits Inside: RS5478-FN Fits: Donaldson FRG09 Housings Replaces: Donaldson P601286 O.D.: 4 1/8 (104.8) I.D.: 3 7/16 (87.3) One End Height: 15 9/16 (395.3)</p> 	<p>RS5489 Radial Seal Outer Air Element Use With: RS5490 Replaces: Donaldson P785589; Sandvik 55089266 O.D.: 8 (203.2) I.D.: 4 3/8 (111.1) One End Height: 16 21/32 (423.1)</p> 
<p>PA5482 Cab Air Element Fits: Komatsu Dump Trucks, Loaders Replaces: Komatsu 427-07-22120 Length: 12 9/32 (311.9) Width: 10 1/16 (255.6) Height: 1 13/16 (46.0)</p> 	<p>RS5490 Radial Seal Inner Air Element Fits Inside: RS5489 Replaces: Donaldson P785389 O.D.: 4 1/16 (103.2) I.D.: 3 5/16 (84.1) One End Height: 14 3/8 (365.1)</p> 
<p>RS5483 Radial Seal Air Element Fits: Kassbohrer Buses Replaces: EvoBus 8.319.150.192.0; Irisbus 5010423885; Donaldson P780731; Fleetguard AF25626 O.D.: 11 27/32 (300.8) I.D.: 6 9/16 (166.7) One End Height: 13 1/16 (331.8)</p> 	<p>PA5491 Air Element Replaces: Caterpillar 7C1572 O.D.: 10 19/32 (269.1) I.D.: 6 (152.4) One End Height: 8 3/8 (212.7)</p> 
<p>RS5484 Radial Seal Air Element Fits: Kassbohrer Buses Replaces: EvoBus 8.319.147.187, 8.319.147.187.0; Mercedes-Benz 40942204, A0040942204; Donaldson P778924; Fleetguard AF25522 O.D.: 11 27/32 (300.8) I.D.: 6 9/16 (166.7) One End Height: 18 17/32 (470.7)</p> 	<p>PA5492 Cab Air Element Contains: Charcoal Impregnated Media for Odor Control Fits: Mercedes-Benz Trucks, Vans Replaces: Mercedes-Benz 8301318, 8303418, A0008301318, A0008303408 Length: 14 7/8 (377.8) Width: 5 1/2 (139.7) Height: 1 9/16 (39.7) A. Gskt: [1] Attached Related To: PA4912 (Standard Media Version)</p> 
<p>PA5485-FN Outer Air Element with Fins Use With: PA5486 Replaces: Arrow Filter 13023273 O.D.: 7 15/16 (201.6) Fins 10 (254.0) I.D.: 1/2 (12.7) & 4 31/32 (126.2) Height: 15 3/4 (400.0) A. Gskt: [1] Attached F. Gskt: [1] Washer</p> 	<p>PA5493 Cab Air Element Fits: Scania Serie G, Serie P, Serie R Trucks Replaces: Scania 1770813, 1913500; Fleetguard AF27692 Length: 14 23/32 (373.9) Width: 5 5/16 (134.9) Height: 25/32 (19.8) A. Gskt: [1] Attached</p> 

Measurements Are Shown In Inches And (Millimeters)

WARNING: These products can expose you to chemicals, including Diisononyl Phthalate, Carbon black extracts, Nickel, 1,3 Butadiene, Ethylene Oxide, Epichlorohydrin, which are known to the State of California to cause cancer, and Bisphenol, Ethylene Glycol, Ethylene Oxide, 1,3 Butadiene, Epichlorohydrin, which are known to the State of California to cause birth defects or other reproductive harm. For more information go to www.P65Warnings.ca.gov.

PA5494 Foam Cab Air Element
Fits: Freightliner Trucks
Replaces: Freightliner 91595, BOA91595; Alliance ABP/N10G-91595
Length: 7 7/8 (200.0)
Width: 6 5/16 (160.3)
Height: 5/8 (15.9)



PA5495 Foam Cab Air Element
Replaces: Freightliner 803190015900, BOA803190015900, ZGG20010; Alliance ABPN10G803190015900; Donaldson P614225
Length: 8 1/2 (215.9)
Width: 7 5/8 (193.7)
Height: 3/4 (19.0)



PA5496 Outer Air Element
Fits: Guangxi Liugong Machinery Company, LTD Equipment
Use With: PA5497
Replaces: Dongfeng Motor Corp. 1109N-020; Fleetguard AF25270; Sakura A-8636
O.D.: 9 7/32 (234.2)
I.D.: 15/32 (11.9) & 5 5/16 (134.9)
Height: 16 7/8 (428.6)
A. Gskt: [1] Attached



PA5497 Inner Air Element
Fits Inside: PA5496
Fits: Guangxi Liugong Machinery Company, LTD Equipment
Replaces: Dongfeng Motor Corp. 1109N-030; Fleetguard AF25277; Sakura A-8637
O.D.: 5 3/16 (131.8)
 Flange 5 29/32 (150.0)
I.D.: 15/32 (11.9) & 4 1/32 (102.4)
Height: 16 5/16 (414.3)
A. Gskt: [1] Attached



PA5498 Outer Air Element
Fits: Zhengzhou Yutong Group Company, LTD Buses
Use With: PA5499
Replaces: Dongfeng Motor Corp. 1109-00135; Fleetguard AF25452
O.D.: 11 (279.4)
I.D.: 23/32 (18.3) & 6 1/2 (165.1)
Height: 20 3/16 (512.8)
A. Gskt: [1] Attached



PA5499 Inner Air Element
Fits Inside: PA5498
Fits: Zhengzhou Yutong Group Company, LTD Buses
Replaces: Dongfeng Motor Corp. 1109-00135; Fleetguard AF25453
O.D.: 6 1/8 (155.6)
I.D.: 23/32 (18.3) & 5 7/32 (132.6)
Height: 19 (482.6)
A. Gskt: [1] Attached



CA5500 Channel Flow EXO Air Element
Fits: Kenworth Trucks
Replaces: Kenworth P611696; Donaldson P616056
O.D.: 11 3/16 (284.2)
 to 17 11/32 (440.5)
Height: 9 27/32 (250.0)



PA5503 Outer Air Element
Fits: Guangxi Liugong Machinery Company, LTD Equipment
Use With: PA5504
Replaces: Dongfeng Motor Corp. 1109.6B-020-B; Fleetguard AF25268
O.D.: 8 9/32 (210.3)
I.D.: 11/32 (8.7) & 5 5/32 (131.0)
Height: 14 23/32 (373.9)
A. Gskt: [1] Attached



PA5504 Inner Air Element
Fits Inside: PA5503
Fits: Guangxi Liugong Machinery Company, LTD Equipment
Replaces: Dongfeng Motor Corp. 1109.6B-030-B; Fleetguard AF25269
O.D.: 4 7/8 (123.8)
I.D.: 23/32 (18.3) & 3 3/8 (85.7)
Height: 14 11/32 (364.3)
A. Gskt: [1] Attached



PA5505 Air Element
Fits: Some MTU 12V2000, 16V2000, 18V2000 Marine Engines
Replaces: Donaldson B120376, ECB120376; Mann & Hummel C311195; SF-Filter SL12942
O.D.: 12 19/32 (319.9)
I.D.: 7 13/16 (198.4) One End
Height: 17 9/16 (446.1)



RS5506 Radial Seal Air Element
Fits: M.A.N. TGL Series, TGM Series Trucks
Replaces: M.A.N. 81.08405.0018; Alco MD-7664; Donaldson P788809
O.D.: 10 (254.0)
I.D.: 5 1/32 (127.8) One End
Height: 18 (457.2)



RS5507 Radial Seal Air Element
Contains: [2] Washers
 [2] Lock Washers
 [2] O-Rings
 [2] Nuts
Fits: Cummins 500KVA Generator with QSX15-C Tier 3 Diesel Engine
Replaces: Cummins 4946497; Fleetguard AF26173
O.D.: 11 31/32 (304.0)
I.D.: 5 27/32 (148.4) One End
Height: 16 1/4 (412.8)



Measurements Are Shown In Inches And (Millimeters)

WARNING: These products can expose you to chemicals, including Diisononyl Phthalate, Carbon black extracts, Nickel, 1,3 Butadiene, Ethylene Oxide, Epichlorohydrin, which are known to the State of California to cause cancer, and Bisphenol, Ethylene Glycol, Ethylene Oxide, 1,3 Butadiene, Epichlorohydrin, which are known to the State of California to cause birth defects or other reproductive harm. For more information go to www.P65Warnings.ca.gov.

RS5508 Radial Seal Air Element
Replaces: Iveco 42537392, 500394100; Donaldson P784456
O.D.: 10 17/32 (267.5)
I.D.: 6 19/32 (167.5) One End
Height: 20 13/16 (528.6)
Related To: RS5358 (Flame Retardant Media)



PA5515 Channel Flow Secondary Air Element with Pull Handle
Fits: Ag-Chem, Agco, Caterpillar, Challenger, J.C. Bamford, John Deere, Massey Ferguson, Valtra Equipment; IHC Trucks
Use With: CA5514, CA5788
Replaces: Agco 4286474M1; Caterpillar 3045633; International 2591007C1; J.C. Bamford 32/925753; John Deere F071151
O.D.: 7 1/2 (190.5)
to 12 13/16 (325.4)
Height: 2 5/16 (58.7)
A. Gskt: [1] Attached



RS5509 Radial Seal Outer Air Element
Fits: John Deere 824K, 844J, 844K Loaders
Use With: RS5510
Replaces: John Deere AT311066
O.D.: 12 3/32 (307.2)
I.D.: 7 11/16 (195.3) One End
Height: 20 9/16 (522.3)



PA5516 Cab Air Element
Replaces: Liebherr 10323466
Length: 10 5/8 (269.9)
Width: 9 1/16 (230.2)
Height: 1 3/16 (30.2)
A. Gskt: [1] Attached

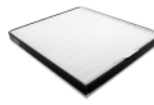

RS5510 Radial Seal Inner Air Element
Fits Inside: RS5509
Fits: John Deere 824K, 844J, 844K Loaders
Replaces: John Deere AT311067
O.D.: 7 5/32 (181.8)
I.D.: 5 27/32 (148.4) One End
Height: 19 21/32 (499.3)



RS5517 Radial Seal Outer Air Element
Contains: Flame Retardant Media
Use With: RS3545
Replaces: Donaldson P604996; Komatsu 3EC02A541E; Toyota 17741-U3330-71
O.D.: 6 1/2 (165.1)
I.D.: 3 9/16 (90.5) One End
Height: 14 1/32 (356.4)
Related To: RS3544 (Standard Media Version)



PA5511 Cab Air Element
Fits: Fendt Tractors
Replaces: Fendt H931812140511
Length: 11 13/16 (300.0)
Width: 7 15/32 (189.7)
Height: 1 25/32 (45.2)
A. Gskt: [1] Attached

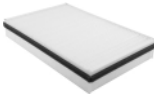

PA5528 Outer Air Element
Use With: PA5529
Replaces: Parker China Division KX2640-2000; Shantui 612600110540
O.D.: 10 7/32 (259.6)
I.D.: 1/2 (12.7) & 6 1/2 (165.1)
Height: 16 1/4 (412.8)
A. Gskt: [1] Attached



PA5512 Panel Air Element
Replaces: Liebherr 10287303
Length: 16 (406.4)
Width: 7 1/16 (179.4)
Height: 1 3/16 (30.2)
A. Gskt: [1] Attached

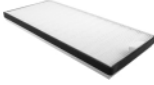

PA5529 Inner Air Element
Fits Inside: PA5528
Replaces: Parker China Division KX2640-3000; Shantui 612600110540
O.D.: 6 1/4 (158.8)
I.D.: 1/2 (12.7) & 4 7/8 (123.8)
Height: 14 15/32 (367.5)
A. Gskt: [1] Attached



CA5514 Channel Flow Primary Air Element
Fits: Agco, Caterpillar, Challenger, John Deere, Massey Ferguson Equipment; Ford, IHC Trucks
Use With: PA5515
Replaces: Agco 4286473M2; Caterpillar 3045632; International 2591005C1; John Deere F071150
O.D.: 8 1/4 (209.6)
to 13 3/8 (339.7)
Height: 7 7/16 (188.9)













RS5534 Radial Seal Outer Air Element
Fits: Liebherr LTM1080/1 Crane
Use With: RS5361
Replaces: Kassbohrer 83191752020; Liebherr 571755608; M.A.N. 81083040100; Mercedes-Benz 40941704, A0040941704
O.D.: 10 17/32 (267.5)
I.D.: 6 19/32 (167.5) One End
Height: 18 23/32 (475.5)













Measurements Are Shown In Inches And (Millimeters)

WARNING: These products can expose you to chemicals, including Diisononyl Phthalate, Carbon black extracts, Nickel, 1,3 Butadiene, Ethylene Oxide, Epichlorohydrin, which are known to the State of California to cause cancer, and Bisphenol, Ethylene Glycol, Ethylene Oxide, 1,3 Butadiene, Epichlorohydrin, which are known to the State of California to cause birth defects or other reproductive harm. For more information go to www.P65Warnings.ca.gov.

<p>RS5535</p> 	<p>Radial Seal Air Element Fits: Iveco EuroCargo Trucks Replaces: Iveco 2992388, 42553258 O.D.: 9 1/8 (231.8) I.D.: 5 13/16 (147.6) One End Height: 16 5/32 (410.4)</p>	<p>RS5540</p> 	<p>Radial Seal Outer Air Element Fits: Isuzu 6WA1 Engine Use With: RS5541 Replaces: FAW Hanwei 110907055A; Parker China Division KU2845 O.D.: 11 3/32 (281.8) I.D.: 7 7/16 (188.9) One End Height: 19 13/32 (492.9)</p>
<p>RS5536</p> 	<p>Radial Seal Outer Air Element Use With: RS5550 Replaces: Sullair 68562431; Mann & Hummel C23513 O.D.: 9 (228.6) I.D.: 4 7/8 (123.8) One End Height: 11 7/8 (301.6) Related To: RS5438 (Flame Retardant Media)</p>	<p>RS5541</p> 	<p>Radial Seal Inner Air Element Fits Inside: RS5540 Fits: Isuzu 6WA1 Engine Replaces: FAW Hanwei 110906055A; Parker China Division KU2845 O.D.: 7 5/16 (185.7) I.D.: 6 5/16 (160.3) One End Height: 17 3/16 (436.6) O-Ring: [1] Included</p>
<p>RS5537</p> 	<p>Radial Seal Outer Air Element Replaces: Faun Frisch 99707008877; FAW Hanwei 1109060385; Hitachi 59004040; M.A.N. 81083040101, 81083040103; Sullair 68562430; Parker China Division KU2437 O.D.: 9 25/32 (248.4) I.D.: 5 21/32 (143.7) One End Height: 16 5/32 (410.4)</p>	<p>RS5543</p> 	<p>Radial Seal Outer Air Element Fits: Manitou MLT523, MLT523A, MT523 Telescopic Handlers Use With: RS5544 Replaces: Manitou 227959 O.D.: 5 13/32 (137.3) I.D.: 3 3/16 (81.0) One End Height: 12 19/32 (319.9)</p>
<p>RS5538</p> 	<p>Radial Seal Outer Air Element Fits: Faw-Xichai 6DL Diesel Engine Use With: RS5539 Replaces: Faw-Xichai 110907050A; Donaldson R000753 O.D.: 11 3/32 (281.8) I.D.: 7 7/16 (188.9) One End Height: 17 21/32 (448.5)</p>	<p>RS5544</p> 	<p>Radial Seal Inner Air Element Fits Inside: RS5543 Fits: Manitou MLT523, MLT523A, MT523 Telescopic Handlers Replaces: Manitou 227960 O.D.: 3 5/16 (84.1) I.D.: 2 15/32 (62.7) One End Height: 12 7/32 (310.4)</p>
<p>RS5539</p> 	<p>Radial Seal Inner Air Element Fits Inside: RS5538 Replaces: Faw-Xichai 110906050A O.D.: 7 5/16 (185.7) I.D.: 6 19/32 (167.5) One End Height: 15 7/16 (392.1) O-Ring: [1] Attached</p>	<p>RS5546</p> 	<p>Radial Seal Outer Air Element Use With: RS3732 Replaces: Fleetguard AF25746; Nelson 70991N O.D.: 8 13/16 (223.8) I.D.: 5 5/32 (131.0) One End Height: 16 7/8 (428.6)</p>













Measurements Are Shown In Inches And (Millimeters)

WARNING: These products can expose you to chemicals, including Diisononyl Phthalate, Carbon black extracts, Nickel, 1,3 Butadiene, Ethylene Oxide, Epichlorohydrin, which are known to the State of California to cause cancer, and Bisphenol, Ethylene Glycol, Ethylene Oxide, 1,3 Butadiene, Epichlorohydrin, which are known to the State of California to cause birth defects or other reproductive harm. For more information go to www.P65Warnings.ca.gov.

<p>RS5547</p>  <p>Radial Seal Inner Air Element Fits Inside: RS5441 Fits: King Long XMQ6120, XMQ6900 Buses Replaces: Hitachi 59004050; King Long 4574556159; M.A.N. 81084050026; Mann & Hummel CF1430 O.D.: 5 5/16 (134.9) I.D.: 4 1/4 (108.0) One End Height: 13 15/16 (354.0) O-Ring: [1] Included</p>	<p>PA5556</p>  <p>Outer Air Element Use With: PA5557 Replaces: Parker China Division KY2139-1000; Weichai Power 13023273 (Outer) O.D.: 8 1/2 (215.9) I.D.: 15/32 (11.9) & 4 13/16 (122.2) Height: 15 29/32 (404.0) A. Gskt: [1] Attached</p>
<p>RS5548</p>  <p>Radial Seal Inner Air Element Fits Inside: RS5440 Replaces: FAW Group 1109070297; Parker China Division KU2337, KU2437; Mann & Hummel CF1440 O.D.: 5 5/16 (134.9) I.D.: 4 3/8 (111.1) One End Height: 15 29/32 (404.0) O-Ring: [1] Included</p>	<p>PA5557</p>  <p>Inner Air Element Fits Inside: PA5556 Replaces: Parker China Division KY2139-2000; Weichai Power 13023273 (Inner) O.D.: 4 21/32 (118.3) Flange: 5 9/32 (134.1) I.D.: 15/32 (11.9) & 3 7/16 (87.3) Height: 14 3/4 (374.7) A. Gskt: [1] Attached</p>
<p>RS5549</p>  <p>Radial Seal Inner Air Element Fits Inside: RS5358 Fits: Heuliez, Irisbus, Iveco Autobus, M.A.N., Neoplan, Renault, Scania Buses Replaces: Bomag 5821450; Irisbus 5006307754, 503131284; M.A.N. 81084050027; Scania 1510942 O.D.: 6 1/8 (155.6) I.D.: 5 1/8 (130.2) One End Height: 18 7/16 (468.3) O-Ring: [1] Included</p>	<p>RS5558</p>  <p>Radial Seal Outer Air Element Fits: Ingersoll-Rand Compressors Use With: RS5559 Replaces: Ingersoll-Rand 54717145 O.D.: 8 13/16 (223.8) I.D.: 5 17/32 (140.5) One End Height: 16 23/32 (424.7)</p>
<p>RS5550</p>  <p>Radial Seal Inner Air Element Notes: OBSOLETE. Availability Limited to Dealer Stock. Fits Inside: RS5536 (NOT for use with RS5438) Replaces: Mann & Hummel CF1240 O.D.: 4 1/2 (114.3) I.D.: 3 9/16 (90.5) One End Height: 9 1/2 (241.3) O-Ring: [1] Included</p>	<p>RS5559</p>  <p>Radial Seal Inner Air Element Fits Inside: RS5558 Fits: Ingersoll-Rand 10/105 VHP300WIR, 375, XP375WIR, P425WIR Compressors with Ingersoll-Rand 4IRD5AE Engine Replaces: Ingersoll-Rand 54717152 O.D.: 5 1/2 (139.7) I.D.: 3 3/4 (95.3) One End Height: 15 3/4 (400.0)</p>
<p>PA5554</p>  <p>Air Element Notes: OBSOLETE. Availability Limited to Dealer Stock. Replaces: Parker China Division KY1520-2000; Foton Lovol SM1021-1109010 O.D.: 6 1/8 (155.6) I.D.: 7/16 (11.1) & 3 3/8 (85.7) Height: 7 11/16 (195.3)</p>	<p>PA5563</p>  <p>Air Element Replaces: Parker China Division K2007-1000; Weichai Power K2007-1000, 13023208 O.D.: 7 27/32 (199.2) I.D.: 4 27/32 (123.0) Height: 3 9/32 (83.3) A. Gskt: [2] Attached</p>
	<p>BA5566</p>  <p>Desiccant Air Dryer Spin-on Contains: Left Hand Threads Fits: Volvo Trucks Replaces: Knorr-Bremse K005686, K014712, K039453; Renault 5001865404, 7421267793; Volvo 20754416, 21267818; WABCO 4329012452; Mahle AL26 Thread: M39 x 1.5 LH O.D.: 5 3/8 (136.5) Height: 6 9/16 (166.7) I.Gskt: [1] Included O-Ring: [1] Included</p>

Measurements Are Shown In Inches And (Millimeters)

WARNING: These products can expose you to chemicals, including Diisononyl Phthalate, Carbon black extracts, Nickel, 1,3 Butadiene, Ethylene Oxide, Epichlorohydrin, which are known to the State of California to cause cancer, and Bisphenol, Ethylene Glycol, Ethylene Oxide, 1,3 Butadiene, Epichlorohydrin, which are known to the State of California to cause birth defects or other reproductive harm. For more information go to www.P65Warnings.ca.gov.

<p>PA5580 Cab Air Element Fits: John Deere, Volvo, Zetor Equipment Replaces: John Deere RE187966 Length: 12 19/32 (319.9) Width: 6 1/2 (165.1) Height: 1 7/8 (47.6)</p> 	<p>PA5588 Outer Air Element Use With: PA5589 Replaces: Dongfeng Tianlong A660-020; Fleetguard AF26413 O.D.: 11 13/16 (300.0) I.D.: 11/16 (17.5) & 7 7/8 (200.0) Height: 18 19/32 (472.3) A. Gskt: [1] Attached F. Gskt: [1] Included</p> 
<p>PA5581 Cab Air Element Fits: Caterpillar D3G, D4G, D5G Crawler Tractors Replaces: Caterpillar 1832813 Length: 20 13/16 (528.6) Width: 5 11/32 (135.7) Height: 2 9/32 (57.9)</p> 	<p>PA5589 Inner Air Element Fits Inside: PA5588 Replaces: Dongfeng Tianlong A660-030; Fleetguard AF26414 O.D.: 7 15/32 (189.7) I.D.: 11/16 (17.5) & 6 7/32 (158.0) Height: 17 7/16 (442.9) A. Gskt: [1] Attached F. Gskt: [1] Included</p> 
<p>PA5583 Air Element Fits: Ditch Witch, Hyster, Yale Equipment Replaces: Hyster 1574111; Yale 580053908; Donaldson P611859 O.D.: 4 1/32 (102.4) Flange: 5 9/16 (141.3) I.D.: 2 13/16 (71.4) One End Height: 12 7/8 (327.0)</p> 	<p>RS5591XP Extreme Performance Nano Radial Seal Cab Air Element Fits: Case-International Sprayers; Case-International, New Holland Tractors Replaces: Case 259288A1, 87684088 O.D.: 6 1/8 (155.6) I.D.: 2 1/2 (63.5) One End Height: 13 21/32 (346.9)</p> 
<p>PA5584 Outer Air Element Contains: Flame Retardant Media Fits: Hyster, Yale Equipment Use With: PA30163 Replaces: Hyster 1559418; Yale 580048838; Donaldson P611858 O.D.: 3 13/32 (86.5) Flange: 4 3/4 (120.7) I.D.: 2 1/4 (57.2) One End Height: 10 17/32 (267.5)</p> 	<p>BA5592 Desiccant Air Dryer Spin-on Notes: DISCONTINUED. Replaced by BA5374. Fits: Freightliner, Mack, Volvo Trucks Replaces: Volvo 8235R950068, 85110799 Thread: M39 x 1.5 O.D.: 5 1/2 (139.7) Height: 6 9/16 (166.7) I.Gskt: [1] Included O-Ring: [1] Included</p> 
<p>PA5585 Cab Air Element Notes: OBSOLETE. Availability Limited to Dealer Stock. Fits: M.A.N., Neoplan Buses Replaces: M.A.N. 88779100003; Donaldson P787437; Fleetguard AF55709 Length: 8 21/32 (219.9) Width: 5 29/32 (150.0) Height: 25/32 (19.8)</p> 	<p>RS5593XP Extreme Performance Nano Radial Seal Cab Air Element Fits: Case-IH Combines Replaces: Case 247752A1 O.D.: 7 3/32 (180.2) I.D.: 2 15/32 (62.7) One End Height: 21 15/16 (557.2)</p> 
<p>PA5586 Cab Air Element Fits: EvoBus, Konvekta, M.A.N., Neoplan, Solaris Buses Replaces: M.A.N. 88779100002; Mercedes-Benz 18352747; Konvekta H14002499; Donaldson P788729; Fleetguard AF55708 Length: 15 3/4 (400.0) Width: 5 3/16 (131.8) Height: 25/32 (19.8)</p> 	<p>PA5597 Cab Air Element Fits: EvoBus, M.A.N., Vison Buses Replaces: EvoBus 18359247; Konvekta H14003495; M.A.N. 83779720656; Mercedes-Benz A0018359247 Length: 17 29/32 (454.8) Width: 5 15/16 (150.8) Height: 15/32 (11.9) A. Gskt: [1] Attached</p> 
<p>BF5587-D Secondary Fuel Spin-on with Drain Fits: Massey Ferguson, Volvo Equipment Replaces: Volvo 3976655, 3976655-5; Mann & Hummel WK842/2; Sinfa FG758; Woodgate WGF842-2 Thread: M16 x 1.5 O.D.: 3 7/16 (87.3) Height: 6 13/32 (162.7) I.Gskt: [1] Included O-Ring: [1] Attached Related To: BF5587-D (without Trapped O-Ring)</p> 	

Measurements Are Shown In Inches And (Millimeters)

WARNING: These products can expose you to chemicals, including Diisononyl Phthalate, Carbon black extracts, Nickel, 1,3 Butadiene, Ethylene Oxide, Epichlorohydrin, which are known to the State of California to cause cancer, and Bisphenol, Ethylene Glycol, Ethylene Oxide, 1,3 Butadiene, Epichlorohydrin, which are known to the State of California to cause birth defects or other reproductive harm. For more information go to www.P65Warnings.ca.gov.

PA5618 Cab Air Element
Fits: Bobcat Loaders
Replaces: Bobcat 6677983
Length: 24 13/32 (619.9)
Width: 4 3/16 (106.4)
Height: 1 3/32 (27.8)



PA5619 Oval Air Element
Notes: Recommend using with PA4187 (Oiled Foam)
Fits: John Deere Lawn & Garden Tractors
Replaces: John Deere M76077, MIU10778
O.D.: 3 1/2 (88.9)
to 8 5/8 (219.1)
I.D.: 1 21/32 (42.1) & 6 27/32 (173.8)
Height: 2 29/32 (73.8)
A. Gskt: [2] Attached



PA5620 Cab Air Element
Fits: New Holland Excavators
Replaces: Komatsu YT20M00004S050; New Holland YT20M00004S050
Length: 8 5/32 (207.2)
Width: 7 5/16 (185.7)
Height: 1 5/32 (29.4)



PA5621 Cab Air Element with Handle
Fits: Fiat-Hitachi, Hitachi, John Deere Excavators; John Deere Loggers
Replaces: Hitachi 4350249, 4S00640
Length: 13 9/32 (337.3)
Width: 8 21/32 (219.9)
Height: 2 13/16 (71.4)
A. Gskt: [1] Attached



PA5622 Cab Air Element with Pull Tab
Fits: Komatsu Dozers, Excavators
Replaces: Komatsu 2039796840
Length: 9 5/32 (232.6)
Width: 7 29/32 (200.8)
Height: 15/16 (23.8)



PA5623 Cab Air Element
Fits: Volvo Equipment
Replaces: Volvo 14506997, VOE14506997; Fleetguard AF26668
Length: 16 3/32 (408.8)
Width: 11 23/32 (297.7)
Height: 1 3/16 (30.2)
A. Gskt: [1] Attached

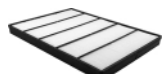

PA5624 Cab Air Element
Fits: Hitachi Excavators; John Deere Excavators, Forestry Swing Machines
Replaces: Hitachi 4484453
Length: 11 11/32 (288.1)
Width: 6 5/8 (168.3)
Height: 1 7/16 (36.5)



PA5625 Cab Air Element
Fits: Bobcat Loaders
Replaces: Bobcat 6678207
Length: 14 5/8 (371.5)
Width: 4 5/8 (117.5)
Height: 1 3/16 (30.2)



PA5626 Cab Air Element
Fits: Agco, Challenger, Massey Ferguson Tractors
Replaces: Massey Ferguson 3388840M2, 3388840M3
Length: 34 17/32 (877.1)
Width: 5 5/16 (134.9)
Height: 2 13/32 (61.1)

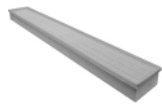

RS5627 Radial Seal Outer Air Element
Fits: Mercedes-Benz O 500 M, O 500 R, O 500 U, OF 1721, OF 1518, OH 1520, OH1618, OH 1621 L, OF1622 L Latin America Buses, 2726, 2726 B-36, 2726 K-36 South America Trucks
Use With: RS5628
Replaces: Mercedes-Benz 6345280306, A6345280306; Racor AR5626RS; Donaldson P618941
O.D.: 10 3/8 (263.5)
I.D.: 5 3/4 (146.0) One End
Height: 15 7/8 (403.2)



RS5628 Radial Seal Inner Air Element
Fits Inside: RS5627
Fits: Volkswagen 26.220, 26.260, 26.260 E, 26.300, 26.310 Trucks
Replaces: Volkswagen 2S0129620A
O.D.: 5 3/4 (146.0)
I.D.: 4 3/8 (111.1) One End
Height: 16 1/2 (419.1)



PA5629 Cab Air Element
Fits: Kobelco, New Holland Excavators
Replaces: Kobelco YN50V01006P1P; New Holland YN50V01006P1, YN50V01006P1P
Length: 8 17/32 (216.7)
Width: 7 15/16 (201.6)
Height: 1 31/32 (50.0)
A. Gskt: [1] Attached



PA5630 Cab Air Element
Fits: Hitachi Zaxis 75US-A, ZX75US-A Excavators
Replaces: Hitachi 4S00687
Length: 17 1/2 (444.5)
Width: 4 1/4 (108.0)
Height: 3/16 (4.8)

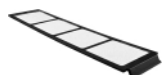

PA5631 Cab Air Element
Fits: Case, Link-Belt Excavators
Replaces: Case KHR2772, MMR80010
Length: 9 (228.6)
Width: 7 1/8 (181.0)
Height: 1 27/32 (46.8)





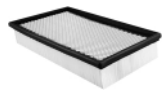

PA5632 Cab Air Element
Fits: Caterpillar Equipment
Replaces: Caterpillar 2098217
Length: 12 7/16 (315.9)
Width: 7 1/16 (179.4)
Height: 2 5/32 (54.8)



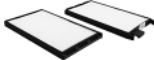



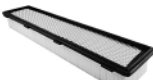





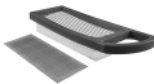
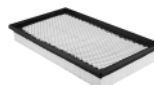
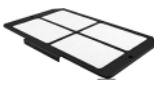

Measurements Are Shown In Inches And (Millimeters)

WARNING: These products can expose you to chemicals, including Diisononyl Phthalate, Carbon black extracts, Nickel, 1,3 Butadiene, Ethylene Oxide, Epichlorohydrin, which are known to the State of California to cause cancer, and Bisphenol, Ethylene Glycol, Ethylene Oxide, 1,3 Butadiene, Epichlorohydrin, which are known to the State of California to cause birth defects or other reproductive harm. For more information go to www.P65Warnings.ca.gov.

<p>PA5633 Cab Air Element Fits: Caterpillar Crawler Tractors Replaces: Caterpillar 3E7904; Donaldson P618641 Length: 9 23/32 (246.9) Width: 6 17/32 (165.9) Height: 1 3/8 (34.9)</p> 	<p>PA5651 Set of 2 Cab Air Elements Notes: Uses 2 filters per application. Fits: Komatsu Excavators Replaces: Komatsu 22B9791730 Each Filter: Length: 8 1/8 (206.4) Width: 4 1/2 (114.3) Height: 19/32 (15.1) A. Gskt: [1] Attached Each Filter</p> 
<p>PA5636 Cab Air Element Fits: Komatsu Dump Trucks Replaces: Komatsu PB7001 Length: 20 (508.0) Width: 14 19/32 (370.7) Height: 2 3/16 (55.6)</p> 	<p>PA5652 Cab Air Element Fits: John Deere Backhoe/Loaders Replaces: John Deere AT184590 Length: 12 9/16 (319.1) Width: 6 1/2 (165.1) Height: 1 7/16 (36.5) A. Gskt: [1] Attached</p> 
<p>PA5637 Cab Air Element Fits: International Trucks Replaces: International 1699956C1; Donaldson P617005; Fleetguard AF55700 Length: 13 21/32 (346.9) Width: 10 1/32 (254.8) Height: 19/32 (15.1)</p> 	<p>PA5653 Cab Air Element Fits: John Deere, Timberjack Feller Bunchers Replaces: John Deere 700093800; Timberjack 700093800 Length: 17 (431.8) Width: 10 1/32 (254.8) Height: 2 3/16 (55.6)</p> 
<p>PA5638 Cab Air Element Fits: Caterpillar Equipment Replaces: Caterpillar 2457823 Length: 7 15/16 (201.6) Width: 7 7/8 (200.0) Height: 23/32 (18.3)</p> 	<p>PA5654 Cab Air Element Fits: Caterpillar Off-Highway Trucks, Wheel Tractors Replaces: Caterpillar 1748145 Length: 16 1/8 (409.6) Width: 5 31/32 (151.6) Height: 2 19/32 (65.9) A. Gskt: [1] Attached</p> 
<p>RS5641 Radial Seal Outer Air Element Fits: Power Prime DV150i Pump with Perkins 1104C Engine Use With: RS4679 Replaces: FG Wilson 915671; J.C. Bamford 32110086; Perkins 26510380 O.D.: 6 13/32 (162.7) I.D.: 3 17/32 (89.7) One End Height: 13 21/32 (346.9)</p> 	<p>PA5655 Cab Air Element Fits: Caterpillar Off-Highway Trucks, Equipment Replaces: Caterpillar 1193355 Length: 15 29/32 (404.0) Width: 7 7/8 (200.0) Height: 2 3/16 (55.6) A. Gskt: [1] Attached</p> 
<p>PA5642 Cab Air Element with Foam Pad Fits: EvoBus Buses; Mercedes-Benz Trucks Replaces: EvoBus 18359147; Mercedes-Benz A0018359147 Length: 20 5/32 (512.0) Width: 9 7/32 (234.2) Height: 1 7/8 (47.6) A. Gskt: [2] Attached</p> 	<p>PA5656 Cab Air Element Fits: Hitachi, John Deere Excavators Replaces: Hitachi 4632689, 4S00686, 4S00686SH Length: 12 9/16 (319.1) Width: 8 (203.2) Height: 3 1/16 (77.8) A. Gskt: [1] Attached</p> 
<p>PA5649 Cab Air Element Fits: Case-IH, McCormick Equipment Replaces: Case 248124A1, 87761808 Length: 18 1/2 (469.9) Width: 4 9/16 (115.9) Height: 2 1/4 (57.2)</p> 	<p>PA5657 Cab Air Element with Pull Tabs Fits: Case, New Holland Equipment Replaces: Case 627749 Length: 29 29/32 (759.6) Width: 9 17/32 (242.1) Height: 2 3/16 (55.6)</p> 
<p>PA5650 Cab Air Element Fits: Caterpillar Equipment Replaces: Caterpillar 2318132 Length: 10 23/32 (272.3) Width: 4 3/32 (104.0) Height: 1 3/32 (27.8) A. Gskt: [2] Attached</p> 	





Measurements Are Shown In Inches And (Millimeters)

WARNING: These products can expose you to chemicals, including Diisononyl Phthalate, Carbon black extracts, Nickel, 1,3 Butadiene, Ethylene Oxide, Epichlorohydrin, which are known to the State of California to cause cancer, and Bisphenol, Ethylene Glycol, Ethylene Oxide, 1,3 Butadiene, Epichlorohydrin, which are known to the State of California to cause birth defects or other reproductive harm. For more information go to www.P65Warnings.ca.gov.

<p>PA5658 Oval Air Element Fits: Onan RV Generators Replaces: Onan 1402897 O.D.: 4 7/16 (112.7) to 6 19/32 (167.5) I.D.: 2 15/16 (74.6) & 5 1/32 (127.8) Height: 4 1/16 (103.2)</p> 	<p>PA5668 Cab Air Element Fits: Case Loaders Replaces: Case 360260A2 Length: 29 3/32 (739.0) Width: 5 9/16 (141.3) Height: 2 3/16 (55.6) A. Gskt: [1] Attached</p> 
<p>PA5661 Panel Air Element with Foam Pre-Cleaner Fits: L100, 102, LA105, L108, LA110, X110, 115, LA115, X 120, Z225 EZTrak Lawn & Garden Equipment Replaces: John Deere GY20573; Stens 102871 and 102875 Length: 8 31/32 (227.8) Width: 6 5/16 (160.3) Height: 1 1/2 (38.1)</p> 	<p>PA5669 Cab Air Element Fits: John Deere Dozers, Feller Bunchers, Loaders Replaces: John Deere AT307501 Length: 12 17/32 (318.3) Width: 7 1/16 (179.4) Height: 1 5/8 (41.3)</p> 
<p>PA5662 Cab Air Element Fits: Hitachi Excavators Replaces: Hitachi 4441139, 4S00684; John Deere 4S00684 Length: 11 3/8 (288.9) Width: 6 9/16 (166.7) Height: 3/8 (9.5)</p> 	<p>RS5670 Radial Seal Air Element Fits: Nissan, Renault Trucks Replaces: Nissan 16546MA70A, 16546MA70C; Renault 5001869822 O.D.: 6 27/32 (173.8) I.D.: 3 3/4 (95.3) One End Height: 7 1/4 (184.2)</p> 
<p>PA5663 Cab Air Element with Bail Handle Fits: Komatsu HM350-1, HM400-1 Dump Trucks Replaces: Komatsu 2099796260 Length: 9 31/32 (253.2) Width: 6 1/32 (153.2) Height: 2 3/16 (55.6)</p> 	<p>RS5672 Radial Seal Outer Air Element Use With: RS5673 Replaces: DongFeng Tianlong 11043911210; Fleetguard AF26433 O.D.: 11 25/32 (299.2) I.D.: 7 3/4 (196.9) One End Height: 20 (508.0)</p> 
<p>PA5664 Air Element Fits: Volvo-Penta Marine Engines Replaces: Volvo 858488 O.D.: 7 31/32 (202.4) I.D.: 3 27/32 (97.6) Height: 3 15/16 (100.0)</p> 	<p>RS5673 Radial Seal Inner Air Element Fits Inside: RS5672 Replaces: DongFeng Tianlong 11043911216; Fleetguard AF26434 O.D.: 7 1/16 (179.4) I.D.: 6 15/32 (164.3) One End Height: 19 5/32 (486.6)</p> 
<p>PA5665 Air Element Replaces: Air Refiner ARP1063; Universal Silencer 811063; Wix 42788 O.D.: 9 23/32 (246.9) I.D.: 7 9/32 (184.9) Height: 6 (152.4)</p> 	<p>PA5674 Air Element in Disposable Housing Fits: Pierce-Arrow Fire Trucks Replaces: Farr 99842002; Wix 46813 O.D.: 10 31/32 (278.6) Inlet: 7 Outlet: 7 1/16 Height: 25 23/32 (653.3)</p> 
<p>PA5666 Cab Air Element Fits: Hitachi, John Deere Excavators Replaces: Hitachi 4643580, 4S00685 Length: 11 1/32 (280.2) Width: 6 5/16 (160.3) Height: 1 25/32 (45.2)</p> 	
<p>PA5667 Cab Air Element Fits: Fiat-Hitachi Excavators; Hitachi, New Holland Loaders Replaces: New Holland 154227500 Length: 18 5/16 (465.1) Width: 5 5/16 (134.9) Height: 2 5/32 (54.8)</p> 	













Measurements Are Shown In Inches And (Millimeters)

WARNING: These products can expose you to chemicals, including Diisononyl Phthalate, Carbon black extracts, Nickel, 1,3 Butadiene, Ethylene Oxide, Epichlorohydrin, which are known to the State of California to cause cancer, and Bisphenol, Ethylene Glycol, Ethylene Oxide, 1,3 Butadiene, Epichlorohydrin, which are known to the State of California to cause birth defects or other reproductive harm. For more information go to www.P65Warnings.ca.gov.

<p>RS5675</p> 	<p>Radial Seal Outer Air Element Use With: RS5676 Replaces: Scania 1931040 O.D.: 10 31/32 (278.6) I.D.: 5 17/32 (140.5) One End Height: 18 3/8 (466.7)</p>	<p>PA5683</p>  <p>Cab Air Element with Pull Tab Fits: Komatsu Equipment Replaces: Komatsu 22B9791740 Length: 8 19/32 (218.3) Width: 4 5/32 (105.6) Height: 31/32 (24.6) A. Gskt: [1] Attached</p>
<p>RS5676</p> 	<p>Radial Seal Inner Air Element Fits Inside: RS5675, RS30130 Replaces: Scania 1931041 O.D.: 5 29/32 (150.0) I.D.: 4 5/16 (109.5) One End Height: 16 7/32 (412.0)</p>	<p>RS5684</p>  <p>Radial Seal Inner Air Element Fits Inside: RS4972 Fits: Deutz-Fahr Tractors Replaces: Deutz 90000592; Renault 7700039510; Donaldson P777779 O.D.: 4 1/8 (104.8) I.D.: 3 29/32 (99.2) One End Height: 14 3/32 (358.0)</p>
<p>PA5678</p> 	<p>Foam Cab Air Element Fits: New Holland Bale Wagons Replaces: New Holland 593939 Length: 24 9/32 (616.7) Width: 4 11/32 (110.3) Height: 31/32 (24.6)</p>	<p>RS5685</p>  <p>Radial Seal Cab Air Element Contains: Carbon Activated Inner Core Fits: Case-International Sprayers, Tractors; New Holland Tractors Replaces: Case 87267363 O.D.: 6 3/32 (154.8) I.D.: 2 7/16 (61.9) One End Height: 13 31/32 (354.8)</p>
<p>PA5679</p> 	<p>Cab Air Element Fits: IHC 7400 WorkStar, 7500 WorkStar, 7600 WorkStar, 8600 TranStar Trucks Replaces: International 3839141C1; MicronAir IN10215P Length: 12 1/4 (311.2) Width: 6 5/32 (156.4) Height: 1 3/16 (30.2)</p>	<p>PA5686</p>  <p>Cab Air Element with Pull Tabs Fits: John Deere 643G, 843G Feller Bunchers, 544G, 624G Loaders Replaces: John Deere AT171176 Length: 19 21/32 (499.3) Width: 5 9/32 (134.1) Height: 2 19/32 (65.9) A. Gskt: [1] Attached</p>
<p>PA5680</p> 	<p>Cab Air Element Fits: Caterpillar Engines, Off-Highway Trucks, Wheel Tractors Replaces: Caterpillar 2593222 Length: 14 7/16 (366.7) Width: 6 1/32 (153.2) Height: 2 9/32 (57.9)</p>	<p>PA5689</p>  <p>Cab Air Element Fits: John Deere Tractors Replaces: John Deere RE291412; Mann & Hummel CU33128 O.D.: 12 15/16 (328.6) I.D.: 9 9/16 (242.9) Height: 2 29/32 (73.8)</p>
<p>PA5681</p> 	<p>Cab Air Element Fits: Euclid, Hitachi Dump Trucks Replaces: Euclid E12630763; Hitachi 12630763; Donaldson P123229 Length: 16 (406.4) Width: 11 31/32 (304.0) Height: 2 3/16 (55.6)</p>	<p>PA5690</p>  <p>Foam Cab Air Element Fits: International 5000 PayStar, 5600 Series, 9100i, 9300, 9900i Trucks Replaces: International 498144C1 Length: 13 3/8 (339.7) Width: 12 13/16 (325.4) Height: 25/32 (19.8)</p>
<p>PA5682</p> 	<p>Cab Air Element Fits: Agco, Challenger Tractors Replaces: Agco 3786649M1, 3786649M2, 3786649M3; Mahle LX1151 Length: 19 11/16 (500.1) Width: 7 7/8 (200.0) Height: 2 5/32 (54.8)</p>	<p>PA5691</p>  <p>Foam cab Air Element Fits: International Trucks Replaces: International 1696834C1 Length: 11 13/16 (300.0) Width: 11 7/32 (285.0) Height: 17/32 (13.5)</p>

Measurements Are Shown In Inches And (Millimeters)

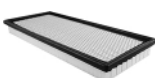
WARNING: These products can expose you to chemicals, including Diisononyl Phthalate, Carbon black extracts, Nickel, 1,3 Butadiene, Ethylene Oxide, Epichlorohydrin, which are known to the State of California to cause cancer, and Bisphenol, Ethylene Glycol, Ethylene Oxide, 1,3 Butadiene, Epichlorohydrin, which are known to the State of California to cause birth defects or other reproductive harm. For more information go to www.P65Warnings.ca.gov.

<p>RS5692 Radial Seal Air Element Contains: Flame Retardant Media Fits: DAF Trucks Replaces: DAF 1679397 O.D.: 9 23/32 (246.9) I.D.: 6 5/16 (160.3) One End Height: 15 11/32 (389.7)</p> 	<p>PA5699 Air Element Contains: Flame Retardant Media Fits: LeTourneau Equipment Replaces: LeTourneau 4219820 O.D.: 13 7/8 (352.4) I.D.: 9 1/2 (241.3) Height: 22 1/2 (571.5) A. Gskt: [1] Attached Related To: PA3588 (Different Media)</p> 
<p>RS5693 Radial Seal Air Element Fits: Volvo-Penta D12D (12.0L) Engine Replaces: Volvo 21196919, 3828811 O.D.: 9 25/32 (248.4) to 11 1/16 (281.0) I.D.: 7 11/32 (186.5) One End Height: 12 5/16 (312.7)</p> 	<p>PA5700 Air Breather Element Contains: Check Valve Clamp Fits: Volvo Dump Trucks, Equipment Replaces: Volvo 11172907; Donaldson P528708; Fleetguard AF27819 O.D.: 3 7/16 (87.3) I.D.: 31/32 (24.6) One End Height: 3 9/16 (90.5) Grommets: [1] Attached Related To: PA2798 (without Check Valve)</p> 
<p>PA5694 Foam Cab Air Element Fits: Peterbilt 387, 587 Trucks Replaces: Peterbilt 525838BSM Length: 13 11/16 (347.7) Width: 10 1/32 (254.8) Height: 25/32 (19.8)</p> 	<p>RS5707 Radial Seal Outer Air Element Fits: Yutong Buses Use With: RS5708 Replaces: Yutong AA90141 Outer; Weifang K3043 Outer; Fleetguard AF26597 O.D.: 11 25/32 (299.2) I.D.: 7 3/4 (196.9) One End Height: 17 (431.8)</p> 
<p>PA5695 Cab Air Element Fits: Fendt Combines, Tractors Replaces: Agco 72478600; Fendt H816810140070, H816810140071 Length: 16 1/16 (408.0) Width: 4 23/32 (119.9) Height: 2 5/16 (58.7)</p> 	<p>RS5708 Radial Seal Inner Air Element Fits Inside: RS5707 Fits: Yutong Buses Replaces: Yutong AA90141 Inner; Weifang K3043 Inner; Fleetguard AF26598 O.D.: 7 1/16 (179.4) I.D.: 5 29/32 (150.0) One End Height: 16 1/4 (412.8)</p> 
<p>PA5696 Cab Air Element Fits: John Deere Combines, Tractors Replaces: John Deere RE284091; Fleetguard AF55740 Length: 24 1/32 (610.4) Width: 4 1/16 (103.2) Height: 3 7/16 (87.3)</p> 	<p>PA5710 Cab Air Element Fits: Case-IH, New Holland Tractors Replaces: New Holland 47128151, 73402760, 82012057; Donaldson P784574 Length: 20 7/16 (519.1) Width: 4 1/8 (104.8) Height: 1 31/32 (50.0) A. Gskt: [1] Attached</p> 
<p>PA5697 Cab Air Element Fits: Caterpillar Loaders, Motor Graders Replaces: Caterpillar 2112660 Length: 15 21/32 (397.7) Width: 6 7/16 (163.5) Height: 1 17/32 (38.9)</p> 	<p>PA5711 Cab Air Element with Bail Handle Fits: Case Loaders Replaces: Case 330014A1 Length: 19 31/32 (507.2) Width: 9 1/16 (230.2) Height: 2 19/32 (65.9) A. Gskt: [1] Attached</p> 
<p>PA5698 Cab Air Element Fits: John Deere Loaders Replaces: John Deere AT359416 Length: 10 19/32 (269.1) Width: 3 9/16 (90.5) Height: 1 3/32 (27.8)</p> 	

Measurements Are Shown In Inches And (Millimeters)

WARNING: These products can expose you to chemicals, including Diisononyl Phthalate, Carbon black extracts, Nickel, 1,3 Butadiene, Ethylene Oxide, Epichlorohydrin, which are known to the State of California to cause cancer, and Bisphenol, Ethylene Glycol, Ethylene Oxide, 1,3 Butadiene, Epichlorohydrin, which are known to the State of California to cause birth defects or other reproductive harm. For more information go to www.P65Warnings.ca.gov.

<p>PA5712</p> 	<p>Cab Air Element with Lift Tab Fits: John Deere Dump Trucks Replaces: John Deere TT226019 Length: 14 1/4 (362.0) Width: 10 23/32 (272.3) Height: 1 13/32 (35.7)</p>	<p>PA5728</p> 	<p>Oval Air Element Fits: John Deere Lawn & Garden Equipment Use With: PA5728 FOAM Replaces: John Deere M150949; Kawasaki 110137027 O.D.: 3 9/16 (90.5) to 7 5/16 (185.7) I.D.: 1 3/16 (30.2) & 5 7/16 (138.1) Height: 3 1/4 (82.6) A. Gskt: [1] Attached</p>
<p>PA5713</p> 	<p>Foam Cab Air Element Fits: John Deere Tractors Replaces: John Deere R65450 Length: 29 17/32 (750.1) Width: 4 1/8 (104.8) Height: 31/32 (24.6)</p>	<p>PA5728 FOAM</p> 	<p>Foam Wrap for PA5728 Fits: John Deere Lawn & Garden Equipment Use With: PA5728 Replaces: John Deere M140295 O.D.: 8 1/32 (204.0) I.D.: 7 3/32 (180.2) Height: 2 23/32 (69.1)</p>
<p>PA5716</p> 	<p>Foam Cab Air Element Fits: Komatsu Dump Trucks Replaces: Komatsu BF5467 Length: 18 13/16 (477.8) Width: 4 1/8 (104.8) Height: 1/2 (12.7)</p>	<p>PA5729</p> 	<p>Cab Air Element with Handle and Foam Pre-Cleaner Fits: John Deere Lawn & Garden Equipment Replaces: Briggs & Stratton 499486S; John Deere GY20575 Length: 5 29/32 (150.0) Width: 4 7/32 (107.2) Height: 1 17/32 (38.9)</p>
<p>PA5719</p> 	<p>Foam Cab Air Element Fits: Caterpillar Loaders Replaces: Caterpillar 1429291 Length: 7 (177.8) Width: 5 15/32 (138.9) Height: 1/2 (12.7)</p>	<p>RS5730</p> 	<p>Radial Seal Outer Air Element Fits: Volvo Trucks with D13C Engine Use With: RS5731 Replaces: Volvo 21115483 O.D.: 12 3/32 (307.2) I.D.: 8 9/32 (210.3) Height: 16 1/8 (409.6)</p>
<p>PA5720</p> 	<p>Cab Air Element Fits: Caterpillar Excavators Replaces: Caterpillar 3276618 Length: 10 15/16 (277.8) Width: 7 7/16 (188.9) Height: 1 9/16 (39.7) A. Gskt: [1] Attached</p>	<p>RS5731</p> 	<p>Radial Seal Inner Air Element Fits Inside: RS5730 Fits: Volvo Trucks Replaces: Volvo 21115501; Hengst E1024LS; Mahle LXS300 O.D.: 7 21/32 (194.5) I.D.: 6 31/32 (177.0) One End Height: 14 9/32 (362.7) O-Ring: [1] Attached</p>
<p>PA5722</p> 	<p>Cab Air Element Fits: Freightliner Trucks Replaces: Freightliner 2246891000 Length: 8 5/8 (219.1) Width: 7 11/16 (195.3) Height: 31/32 (24.6)</p>	<p>PA5732</p> 	<p>Foam Cab Air Element Notes: OBSOLETE. Availability Limited to Dealer Stock. Fits: Case, New Holland Dozers Replaces: Case 76092242; New Holland 76092242 Length: 15 9/16 (395.3) Width: 8 9/32 (210.3) Height: 3/16 (4.8)</p>
<p>PA5723</p> 	<p>Cab Air Element Fits: Hitachi, John Deere Excavators Replaces: Hitachi 4455778, 4S00688; John Deere 4455778, 4S00688 Length: 8 21/32 (219.9) Width: 4 7/8 (123.8) Height: 19/32 (15.1) A. Gskt: [1] Attached</p>	<p>PA5725</p> 	<p>Cab Air Element Contains: Charcoal Impregnated Media for Odor Control Fits: Case Loaders Replaces: Case 87656118; New Holland 87656118 Length: 14 1/2 (368.3) Width: 6 11/32 (161.1) Height: 15/16 (23.8)</p>
<p>PA5725</p> 	<p>Cab Air Element Contains: Charcoal Impregnated Media for Odor Control Fits: Case Loaders Replaces: Case 87656118; New Holland 87656118 Length: 14 1/2 (368.3) Width: 6 11/32 (161.1) Height: 15/16 (23.8)</p>	<p>PA5727</p> 	<p>Foam Cab Air Element Fits: John Deere Skidders Replaces: John Deere T183432 Length: 12 29/32 (327.8) Width: 3 17/32 (89.7) Height: 1/2 (12.7)</p>

Measurements Are Shown In Inches And (Millimeters)

WARNING: These products can expose you to chemicals, including Diisononyl Phthalate, Carbon black extracts, Nickel, 1,3 Butadiene, Ethylene Oxide, Epichlorohydrin, which are known to the State of California to cause cancer, and Bisphenol, Ethylene Glycol, Ethylene Oxide, 1,3 Butadiene, Epichlorohydrin, which are known to the State of California to cause birth defects or other reproductive harm. For more information go to www.P65Warnings.ca.gov.

PA5733 Panel Air Element
Fits: Onan Generators
Replaces: Onan 1403116
Length: 10 1/4 (260.3)
Width: 6 17/32 (165.9)
Height: 1 13/32 (35.7)



PA5734 Cab Air Element
Fits: Case, New Holland Loaders
Replaces: Case 78314367; New Holland 87314367
Length: 16 3/8 (415.9)
Width: 9 27/32 (250.0)
Height: 27/32 (21.4)
A. Gskt: [1] Attached

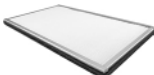

PA5735 Air Element in Disposable Housing
Fits: Peterbilt Trucks
Replaces: Farr 400820023; Paccar 400820023; Parker 400820023; Racor 400820023
O.D.: 10 31/32 (278.6)
Inlet: 7
Outlet: 5 29/32
Height: 14 29/32 (378.6)



PA5736 Cab Air Element
Fits: Caterpillar Scrapers, Wheel Tractors
Replaces: Caterpillar 3E7319
Length: 18 19/32 (472.3)
Width: 7 7/8 (200.0)
Height: 2 19/32 (65.9)
A. Gskt: [1] Attached



PA5738 Cab Air Element
Fits: Caterpillar Loaders
Replaces: Caterpillar 2318130, 3036658
Length: 8 11/32 (211.9)
Width: 3 21/32 (92.9)
Height: 1 17/32 (38.9)
A. Gskt: [2] Attached



PA5739 Cab Air Element
Fits: Case, New Holland Loaders
Replaces: Case 139768A1; Donaldson P784574
Length: 12 1/16 (306.4)
Width: 4 1/32 (102.4)
Height: 2 7/16 (61.9)
A. Gskt: [1] Attached



RS5741 Radial Seal Outer Air Element
Fits: Bobcat Loaders
Use With: RS5742
Replaces: Bobcat 6698057
O.D.: 6 1/8 (155.6)
I.D.: 3 9/16 (90.5) One End
Height: 12 1/16 (306.4)



RS5742 Radial Seal Inner Air Element
Fits Inside: RS5741
Fits: Bobcat Loaders
Replaces: Bobcat 6698058; Fleetguard AF26365
O.D.: 3 3/8 (85.7)
Flange: 5 3/32 (129.4)
I.D.: 2 11/16 (68.3) One End
Height: 10 15/16 (277.8)



RS5743 Radial Seal Outer Air Element with Bail Handle
Fits: Komatsu Dump Trucks
Replaces: Komatsu XA4292; Donaldson P608306; Fleetguard AF27696
O.D.: 17 23/32 (450.1)
I.D.: 11 7/16 (290.5) One End
Height: 24 7/8 (631.8)



RS5743XP Extreme Performance Nano Radial Seal Outer Air Element with Bail Handle
Fits: Caterpillar Off-Highway Trucks
Use With: RS5744
Replaces: Caterpillar 4199162; Donaldson P608306; Fleetguard AF27696
O.D.: 17 23/32 (450.1)
I.D.: 11 7/16 (290.5) One End
Height: 24 7/8 (631.8)



RS5744 Radial Seal Inner Air Element
Fits Inside: RS5743, RS5743XP
Fits: Caterpillar Off-Highway Trucks
Replaces: Caterpillar 2673005; Donaldson P608305; Fleetguard AF27695
O.D.: 11 9/16 (293.7)
I.D.: 9 (228.6) One End
Height: 19 1/4 (489.0)













RS5745 Radial Seal Outer Air Element
Fits: Yale Equipment using 8 Inch OptiAir Series Housings
Use With: RS5746
Replaces: Yale 580088196
O.D.: 6 1/4 (158.8)
I.D.: 3 9/16 (90.5) One End
Height: 14 1/16 (357.2)



Measurements Are Shown In Inches And (Millimeters)

WARNING: These products can expose you to chemicals, including Diisononyl Phthalate, Carbon black extracts, Nickel, 1,3 Butadiene, Ethylene Oxide, Epichlorohydrin, which are known to the State of California to cause cancer, and Bisphenol, Ethylene Glycol, Ethylene Oxide, 1,3 Butadiene, Epichlorohydrin, which are known to the State of California to cause birth defects or other reproductive harm. For more information go to www.P65Warnings.ca.gov.

<p>RS5746</p> 	<p>Radial Seal Inner Air Element Fits Inside: RS5745 Fits: Yale Equipment using 8 Inch OptiAir Series Housings Replaces: Fleetguard AF25961; Wix 49868 O.D.: 3 3/8 (85.7) Flange 5 3/32 (129.4) I.D.: 2 7/8 (73.0) One End Height: 13 3/32 (332.6)</p>	<p>PA5751</p>  <p>Outer Air Element Fits: Challenger, Gleaner, Massey Ferguson Combines Use With: PA2410 Replaces: Agco 71368961 O.D.: 12 3/32 (307.2) I.D.: 7/8 (22.2) & 7 23/32 (196.1) Height: 18 1/32 (458.0) F. Gskt: [1] Steel Washer</p>
<p>RS5747</p> 	<p>Radial Seal Outer Air Element Fits: Bobcat Loaders Use With: RS5748 Replaces: Bobcat 7008043 O.D.: 6 1/4 (158.8) I.D.: 3 9/16 (90.5) One End Height: 10 1/16 (255.6)</p>	<p>PA5752</p>  <p>Cab Air Element Fits: Caterpillar Loaders Replaces: Caterpillar 2112661; Donaldson P627028; Fleetguard AF27911 O.D.: 6 1/8 (155.6) I.D.: 2 1/32 (16.7) & 3 15/32 (88.1) Height: 9 1/2 (241.3) A. Gskt: [1] Attached F. Gskt: [1] Wing Nut</p>
<p>RS5748</p> 	<p>Radial Seal Inner Air Element Fits Inside: RS5747 Fits: Bobcat Loaders Replaces: Bobcat 7008044 O.D.: 3 3/8 (85.7) Flange 5 3/32 (129.4) I.D.: 2 3/4 (69.9) One End Height: 9 3/16 (233.4)</p>	<p>PA5753</p>  <p>Cab Air Element with Pull Tab Fits: Kobelco, New Holland Excavators Replaces: Case YN50V01015P3, YN50V01015P3P; New Holland YN50V01015P3, YN50V01015P3P Length: 8 11/32 (211.9) Width: 7 1/2 (190.5) Height: 1 1/16 (27.0) A. Gskt: [1] Attached</p>
<p>RS5749</p> 	<p>Radial Seal Outer Air Element Fits: Harlo HP5000, HP6500 Lift Trucks; Reed B20 Concrete Pump Use With: RS5750 Replaces: Fleetguard AF26120 O.D.: 7 1/2 (190.5) I.D.: 5 11/16 (144.5) One End Height: 14 13/16 (376.2)</p>	<p>RS5754</p>  <p>Radial Seal Air Element with Lid Contains: Bleed Valve Flame Retardant Media Fits: DAF Trucks with PACCAR Engines Replaces: Daf 1854407, 1931681, 1931685; Donaldson P951919 O.D.: 10 31/32 (278.6) Lid 13 19/32 (345.3) I.D.: 5 25/32 (146.8) One End Height: 20 5/32 (512.0)</p>
<p>RS5750</p> 	<p>Radial Seal Inner Air Element Fits Inside: RS5749 Fits: Harlo HP5000, HP6500 Lift Trucks Replaces: Fleetguard AF26121; Nelson 871402N O.D.: 4 1/8 (104.8) Flange 5 7/8 (149.2) I.D.: 2 15/16 (74.6) One End Height: 14 1/8 (358.8)</p>	<p>PA5755</p>  <p>Cab Air Element Fits: Caterpillar Crawler Tractors Replaces: Caterpillar 2653857, 3197944 Length: 20 25/32 (527.8) Width: 3 31/32 (100.8) Height: 3 5/8 (92.1) A. Gskt: [1] Attached F. Gskt: [1] Included</p>
		<p>RS5756</p>  <p>Radial Seal Outer Air Element Fits: Blue Bird Buses Use With: RS30237 Replaces: Blue Bird 10004113; Racor 500454001, 500454001BB O.D.: 11 3/8 (288.9) I.D.: 6 3/8 (161.9) One End Height: 19 11/16 (500.1) F. Gskt: [1] Included</p>

Measurements Are Shown In Inches And (Millimeters)

WARNING: These products can expose you to chemicals, including Diisononyl Phthalate, Carbon black extracts, Nickel, 1,3 Butadiene, Ethylene Oxide, Epichlorohydrin, which are known to the State of California to cause cancer, and Bisphenol, Ethylene Glycol, Ethylene Oxide, 1,3 Butadiene, Epichlorohydrin, which are known to the State of California to cause birth defects or other reproductive harm. For more information go to www.P65Warnings.ca.gov.

PA5757 Cab Air Element
Fits: Caterpillar Crawler Tractors
Replaces: Caterpillar 2380479
Length: 20 (508.0)
Width: 3 15/16 (100.0)
Height: 3 9/16 (90.5)
A. Gskt: [1] Attached



RS5758 Radial Seal Outer Air Element with Pull Tabs
Use With: RS5759
Replaces: Longgong 612600114993 Outer; Weifang KX2400 Outer
O.D.: 9 1/2 (241.3)
I.D.: 8 1/8 (206.4) One End
Height: 16 9/32 (413.5)
A. Gskt: [1] Attached



RS5759 Radial Seal Inner Air Element
Fits Inside: RS5758
Replaces: Longgong 612600114993 Inner; Weifang KX2400 Inner
O.D.: 5 21/32 (143.7)
I.D.: 4 7/16 (112.7) One End
Height: 16 1/4 (412.8)



RS5761 Radial Seal Cab Air Element
Contains: Charcoal Impregnated Media for Odor Control
Fits: Caterpillar Motor Graders, Off-Highway Trucks
Replaces: Caterpillar 2208800
O.D.: 6 15/32 (164.3)
I.D.: 3 5/8 (92.1) One End
Height: 11 21/32 (296.1)
Related To: RS5305 (Standard Media Version)



PA5762 Air Element
Fits: Caterpillar Gen Sets, Gen Set Engines
Replaces: Caterpillar 9Y3879
O.D.: 12 19/32 (319.9)
I.D.: 6 (152.4) One End
Height: 13 11/32 (338.9)



PA5763 Outer Air Element
Fits: Valmet, Valtra Tractors
Use With: PA5764
Replaces: Agco 20228310, 836462568
O.D.: 6 1/2 (165.1)
I.D.: 13/32 (10.3) & 3 3/8 (85.7)
Height: 15 (381.0)
A. Gskt: [1] Attached



PA5764 Inner Air Element
Fits Inside: PA5763
Fits: Valtra Tractors
Replaces: Agco 20228410, 836462569
O.D.: 3 1/2 (88.9)
I.D.: 13/32 (10.3) & 2 13/16 (71.4)
Height: 14 3/4 (374.7)
A. Gskt: [1] Attached



PA5765 Foam Cab Air Element
Fits: Peterbilt Trucks
Replaces: Peterbilt 5S013817, 5X013817
Length: 13 11/32 (338.9)
Width: 9 3/32 (231.0)
Height: 5/8 (15.9)



PA5766 Cab Air Element
Fits: Komatsu Dump Trucks, Loaders
Replaces: Komatsu 4260732441
Length: 12 1/4 (311.2)
Width: 9 31/32 (253.2)
Height: 1 3/4 (44.4)



RS5767 Radial Seal Air Element
Contains: Air Divider Hose Connection
Fits: Chevrolet, GMC, Isuzu Trucks; Isuzu 6HK1-TC 7.8L Engine
Replaces: General Motors 19179832; Isuzu 19179832; ACDelco A3101C
O.D.: 7 13/16 (198.4)
I.D.: 4 27/32 (123.0) One End
Height: 19 23/32 (500.9)



PA5768 Cab Air Element
Fits: John Deere Equipment
Replaces: John Deere RE195491
Length: 12 3/32 (307.2)
Width: 4 7/32 (107.2)
Height: 1 3/16 (30.2)



PA5770 Cab Air Element
Fits: Caterpillar Equipment
Replaces: Caterpillar 2656618
Length: 12 23/32 (323.1)
Width: 5 27/32 (148.4)
Height: 2 7/32 (56.4)

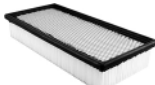

PA5771 Cab Air Element
Fits: John Deere Dozers
Replaces: John Deere AT315958
Length: 26 7/32 (666.0)
Width: 6 1/2 (165.1)
Height: 2 7/32 (56.4)





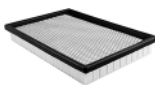









PA5772 Cab Air Element
Fits: Caterpillar Off-Highway Trucks, Pipelayers, Telehandlers
Replaces: Caterpillar 2015023
Length: 10 3/8 (263.5)
Width: 7 (177.8)
Height: 1 13/32 (35.7)



Measurements Are Shown In Inches And (Millimeters)

WARNING: These products can expose you to chemicals, including Diisononyl Phthalate, Carbon black extracts, Nickel, 1,3 Butadiene, Ethylene Oxide, Epichlorohydrin, which are known to the State of California to cause cancer, and Bisphenol, Ethylene Glycol, Ethylene Oxide, 1,3 Butadiene, Epichlorohydrin, which are known to the State of California to cause birth defects or other reproductive harm. For more information go to www.P65Warnings.ca.gov.

<p>PA5773 Foam Cab Air Element Fits: Freightliner Trucks Replaces: Alliance ABPN/10G/91621 Length: 10 1/8 (257.2) Width: 5 1/32 (127.8) Height: 3/16 (4.8)</p> 	<p>RS5784 Radial Seal Air Element Fits: Ingersoll Rand Compressors Replaces: Ingersoll Rand 54471834 O.D.: 6 1/2 (165.1) I.D.: 3 3/4 (95.3) One End Height: 14 (355.6)</p> 
<p>PA5774 Cab Air Element Fits: Caterpillar Loaders, Skid Steers Replaces: Caterpillar 2656619 Length: 10 5/8 (269.9) Width: 4 3/4 (120.7) Height: 2 7/32 (56.4)</p> 	<p>PA5785 Outer Air Element with Blank Band Notes: OBSOLETE. Availability Limited to Dealer Stock. Fits: Valmet Forestry Equipment, Tractors Use With: PA5786 Replaces: Agco 836128654; Valmet V836128654 O.D.: 6 5/8 (168.3) Flange: 7 11/16 (195.3) I.D.: 11/32 (8.7) & 4 21/32 (118.3) Height: 13 7/8 (352.4) A. Gskt: [2] Attached</p> 
<p>RS5776 Radial Seal Air Element Contains: Flame Retardant Media Fits: Volvo Trucks Replaces: Volvo 21834210; Fleetguard AF25632; Mahle LX1281 O.D.: 14 (355.6) I.D.: 7 25/32 (197.6) One End Height: 16 1/4 (412.8) Related To: RS4967 (Standard Media Version)</p> 	<p>PA5786 Inner Air Element Notes: OBSOLETE. Availability Limited to Dealer Stock. Fits Inside: PA5785, PA5787 Fits: Valmet Forestry Equipment, Tractors; Valtra Tractors Replaces: Agco 836128655; Valmet V836128655 O.D.: 4 1/2 (114.3) I.D.: 11/32 (8.7) & 3 3/32 (78.6) Height: 13 (330.2)</p> 
<p>PA5780 Cab Air Element with Handle Contains: 8 Inch Metal Handle Fits: Volvo Motor Graders Replaces: Volvo 12742527 Length: 33 31/32 (862.8) Width: 5 15/16 (150.8) Height: 1 21/32 (42.1) A. Gskt: [2] Attached</p> 	<p>PA5787 Outer Air Element with Blank Band and Lift Tab Notes: OBSOLETE. Availability Limited to Dealer Stock. Fits: Valmet Forestry Equipment, Tractors Use With: PA5786 Replaces: Agco 836136409; Valmet V836136409 O.D.: 6 5/8 (168.3) Flange: 7 11/16 (195.3) I.D.: 11/32 (8.7) & 4 21/32 (118.3) Height: 13 25/32 (350.0) A. Gskt: [2] Attached</p> 
<p>PA5781 Cab Air Element with Pull Strap Fits: Volvo Motor Graders Replaces: Volvo 12742526 Length: 25 31/32 (659.6) Width: 5 15/16 (150.8) Height: 1 21/32 (42.1) A. Gskt: [2] Attached</p> 	<p>CA5788 Channel Flow Primary Air Element Fits: Ag-Chem, Agco, Apache, Challenger, Fendt, Massey Ferguson, Valtra Equipment Use With: PA5515 Replaces: Fendt H931202090410; J.C. Bamford 32/925752; Massey Ferguson 4286479M2 O.D.: 8 9/32 (210.3) to 13 13/32 (340.5) Height: 11 7/32 (285.0)</p> 
<p>RS5782 Radial Seal Conical Shaped Outer Air Element Notes: MUST be used with RS5783 Inner Air Element Fits: John Deere Excavators, Loaders; New Holland Excavators Use With: RS5783 Replaces: John Deere AT332908; Baldwin PA5501 O.D.: 6 1/16 (154.0) to 7 23/32 (196.1) I.D.: 4 11/16 (119.1) One End Height: 14 (355.6)</p> 	
<p>RS5783 Radial Seal Conical Shaped Inner Air Element Fits Inside: RS5782 Fits: John Deere Excavators, Loaders; New Holland Excavators Replaces: John Deere AT332909; Baldwin PA5502 O.D.: 3 3/16 (81.0) to 4 31/32 (126.2) I.D.: 4 3/16 (106.4) One End Height: 13 11/16 (347.7)</p> 	

Measurements Are Shown In Inches And (Millimeters)

WARNING: These products can expose you to chemicals, including Diisononyl Phthalate, Carbon black extracts, Nickel, 1,3 Butadiene, Ethylene Oxide, Epichlorohydrin, which are known to the State of California to cause cancer, and Bisphenol, Ethylene Glycol, Ethylene Oxide, 1,3 Butadiene, Epichlorohydrin, which are known to the State of California to cause birth defects or other reproductive harm. For more information go to www.P65Warnings.ca.gov.

CA5789 Channel Flow Primary Air Element
Fits: Mack Trucks
Use With: PA5792
Replaces: Mack 57MD321M, 21020786;
 Case/New Holland N102191; Volvo 43863232
O.D.: 10 7/32 (259.6)
 to 15 5/8 (396.9)
Height: 13 1/4 (336.5)



CA5790 EnduraCube Air Element
Fits: Freightliner Trucks
Replaces: Freightliner 333648001, P610260;
 Donaldson P618478
Length: 26 1/8 (663.6)
Width: 5 1/4 (133.4)
Height: 9 9/32 (235.7)



CA5791 Channel Flow Primary Air Element
Fits: Case, Case-IH, New Holland Equipment
Use With: PA5792
Replaces: Case 87356545; New Holland
 87356545
O.D.: 11 1/4 (285.8)
 to 15 1/16 (382.6)
Height: 9 5/16 (236.5)



PA5792 Channel Flow Secondary Air Element with Pull Handle
Fits: Case, Case-IH, New Holland Equipment
Use With: CA5789, CA5791
Replaces: Case 87356547
O.D.: 9 7/16 (239.7)
 to 14 3/4 (374.7)
Height: 2 5/16 (58.7)
A. Gskt: [1] Attached



CA5793 Channel Flow Air Element
Fits: 1999-2003 Ford F450 Super Duty, F550
 Super Duty Trucks, 2000-03 Excursion all with
 V8-445 (7.3L) Turbo Diesel Engine
Replaces: Ford 2U2Z9601BA, 2U2J9601BA;
 Motorcraft FA1757
O.D.: 5 5/8 to 12 7/8 (142.9 to 327.0)
 Flange 8 to 14 3/8 (203.2 to 365.1)
Height: 6 (152.4)



PA5796 Cab Air Element
Fits: Challenger, Valtra Tractors
Replaces: Agco 20531300; Donaldson P750026
Length: 19 1/16 (484.2)
Width: 6 15/16 (176.2)
Height: 2 1/8 (54.0)
A. Gskt: [2] Attached

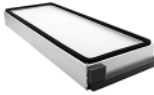

PA5797 Cab Air Element
Fits: Volvo Buses
Replaces: Volvo 20746873, 2130158, 70326723,
 85107862
Length: 15 31/32 (405.6)
Width: 7 1/16 (179.4)
Height: 1 3/16 (30.2)
A. Gskt: [1] Attached

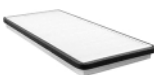

PA5798 Cab Air Element
Notes: OBSOLETE. Availability Limited to
 Dealer Stock.
Fits: Citroen, Fiat, Peugeot Trucks
Replaces: Citroen 6447YA, 6479C9; Peugeot
 6447YA
Length: 9 27/32 (250.0)
Width: 9 1/4 (235.0)
Height: 31/32 (24.6)



BF5800 Primary Fuel Spin-on
Notes: Can be used with FB1301 base.
Fits: Detroit Diesel Engines
Replaces: Detroit Diesel 6438839; GMC
 25010793
Thread: 1 -12
O.D.: 3 11/16 (93.7)
Height: 8 (203.2)
I.Gskt: [1] Included
Related To: BF592 (Short Version)
 BF5813 (Fuel/Water Separator Version)



BF5801 Primary Fuel Spin-on
Notes: CAUTION: Do NOT use on Cummins
 engines. Furnished D-Ring must be installed on
 post for seal.
 Can be used with FB1311 base.
Fits: Detroit Diesel Engines Using Cummins
 Fuel Filter Base
Thread: 1 -14
O.D.: 3 11/16 (93.7)
Height: 8 1/32 (204.0)
I.Gskt: G381-A
F. Gskt: ES24-D



BF5810 Secondary Fuel Spin-on
Notes: Can be used with FB1302 base.
Contains: Integral Post Seal
Fits: Detroit Diesel Engines
Replaces: Detroit Diesel 23518482
Thread: 13/16 -12
O.D.: 3 11/16 (93.7)
Height: 7 3/32 (180.2)
I.Gskt: [1] Included



BF5812 Primary Fuel/Water Separator Spin-on with
 Drain
Notes: CAUTION: Do NOT use on Cummins
 engines. Furnished D-Ring must be installed on
 post for seal.
 Can be used with FB1311 base.
Fits: Detroit Diesel Engines with Cummins
 Fuel Filter Base
Replaces: Detroit Diesel 23516189
Thread: 1 -14
O.D.: 3 11/16 (93.7)
Height: 8 27/32 (224.6)
I.Gskt: G381-A
F. Gskt: ES24-D



Measurements Are Shown In Inches And (Millimeters)

WARNING: These products can expose you to chemicals, including Diisononyl Phthalate, Carbon black extracts, Nickel, 1,3 Butadiene, Ethylene Oxide, Epichlorohydrin, which are known to the State of California to cause cancer, and Bisphenol, Ethylene Glycol, Ethylene Oxide, 1,3 Butadiene, Epichlorohydrin, which are known to the State of California to cause birth defects or other reproductive harm. For more information go to www.P65Warnings.ca.gov.

BF5813

Primary Fuel/Water Separator Spin-on with Drain



Notes: Can be used with FB1301 base.
Fits: Detroit Diesel Engines
Replaces: GMC 23512317
Thread: 1 -12
O.D.: 3 11/16 (93.7)
Height: 8 13/16 (223.8)
I.Gskt: [1] Included
O. Gskt: ES24-D (for Caterpillar Engines)
Related To: BF5800 (Fuel Version)
 BF5813-O (with Open End for Bowl)

BF5813-O

Fuel/Water Separator with Open End for Bowl



Fits: Isuzu Trucks
Replaces: Racor S3202T; Isuzu 8156189210;
 General Motors Corp. 156189210
Thread: 1 -12 UNF-2B
O.D.: 3 3/4 (95.3)
Height: 7 13/32 (188.1)
F. Gskt: [2] Included
O-Ring: [1] Included
Related To: BF5813 (Drain Version)
 BF5800 (Fuel Version)

BF5815

Secondary Fuel Spin-on



Contains: Integral Post Seal
Fits: Detroit Diesel Engines
Replaces: Detroit Diesel 23518530
Thread: 13/16 -12
O.D.: 3 11/16 (93.7)
Height: 7 3/32 (180.2)
I.Gskt: [1] Included

BF5816

High Efficiency Secondary Fuel Spin-on



Contains: Integral Post Seal
Fits: Detroit Diesel Engines
Replaces: Detroit Diesel 23533726
Thread: 13/16 -12
O.D.: 3 11/16 (93.7)
Height: 7 3/32 (180.2)
I.Gskt: [1] Included

6017

Transmission Filter

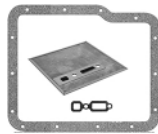

Notes: Pan gasket contains [14] bolt holes.
Fits: 1962-73 Chevrolet, 1963-73 GMC, 1963-72
 Pontiac Automotive, Light-Duty Trucks with
 Powerglide Transmission (RWD, Aluminum
 Case)
Replaces: General Motors Corp. 6438815; Wix
 51883, 58883
Length: 5 13/32 (137.3)
Width: 5 7/32 (132.6)
Pan Gasket: [1] Included, Plus One Small
 Irregular Gasket

6020

Transmission Filter



Notes: Pan gasket contains [13] bolt holes.
Fits: 1967-80 Buick, Oldsmobile, Pontiac,
 1963-84, 1988-90 Cadillac, 1968-90 Chevrolet,
 1967-90 GMC, 1992-93 Hummer, 1975-92 Jaguar;
 1972 International Light-Duty Trucks; 1968-79
 Jeep Automotive with THM375
Replaces: GMC 12337210
Length: 11 23/32 (297.7)
Width: 6 1/2 (165.1)
Height: 5/8 (15.9)
Grommets: [1] Attached
Pan Gasket: [1] Included, Plus One Small
 O-Ring

6021

Transmission Filter

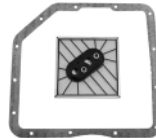

Notes: Pan gasket contains [13] bolt holes.
Fits: 1966-74, 1982-84 Buick, 1982 Cadillac,
 1967-84, 1986 Chevrolet, 1969-84, 1986 GMC
 Light-Duty Trucks, 1968-74, 1981-84
 Oldsmobile, 1969-83 Pontiac Automotive,
 1965-67 Jeep with THM250C, THM350, THM350C
Replaces: GMC 6433856
Width: 5 5/8 (142.9)
O-Ring: [1] Included
Pan Gasket: [1] Included

BK6022

Service Kit for Detroit Diesel



Contains: [2] B495 Lube
 [1] PF7744 Pri. Fuel
 [1] BF5810 Sec. Fuel
 [1] CTK5029-1 Coolant Test Strip

BK6023

Service Kit for Detroit Diesel



Contains: [2] B495 Lube
 [1] BF1395-SP Fuel/Water Separator
 [1] CTK5029-1 Coolant Test Strip

BK6024

Service Kit for Cummins



Contains: [1] BD7154 Dual-Flow Lube
 [1] PF7680 Fuel/Water Separator
 [1] CTK5029-1 Coolant Test Strip

BK6025

Service Kit for Cummins



Contains: [1] BD7154 Dual-Flow Lube
 [1] BF7766 Fuel
 [1] CTK5029-1 Coolant Test Strip

Measurements Are Shown In Inches And (Millimeters)

WARNING: These products can expose you to chemicals, including Diisononyl Phthalate, Carbon black extracts, Nickel, 1,3 Butadiene, Ethylene Oxide, Epichlorohydrin, which are known to the State of California to cause cancer, and Bisphenol, Ethylene Glycol, Ethylene Oxide, 1,3 Butadiene, Epichlorohydrin, which are known to the State of California to cause birth defects or other reproductive harm. For more information go to www.P65Warnings.ca.gov.

BK6026 Service Kit for Mercedes-Benz
Contains: [1] P7230 Lube
 [1] PF7744 Pri. Fuel
 [1] PF7761 Fuel
 [1] CTK5029-1 Coolant Test Strip



BK6033 Service Kit for International
Contains: [1] P7329 Lube
 [1] PF7748 Fuel/Water Separator
 [1] PF7928 Fuel



BK6027 Service Kit for Mack/Volvo
Contains: [2] B76 F-F Lube
 [1] BC7242 B-P Lube
 [1] BF1384-SP Fuel/Water Separator
 [1] BF7814 Fuel



BK6035 Service Kit for Cummins
Contains: [1] BD7309 Dual-Flow Lube
 [1] BF7924 Fuel



BK6028 Service Kit for Cummins
Contains: [1] BD7153 Dual-Flow Lube
 [2] BF1212 Pri. Fuel
 [1] BW5073 Coolant
 [2] BT8873 Hydraulic
 [1] BT839-10 Hydraulic



BK6045 Service Kit for Cummins
Contains: [1] BD7309 Dual-Flow Lube
 [1] BF7815 Fuel
 [1] BW5074 Coolant



BK6029 Service Kit for Mack/Volvo
Contains: [2] B76 F-F Lube
 [1] BC7228 B-P Lube Spinner
 [1] BF7656 Pri. Fuel
 [1] BF7657 Sec. Fuel



BK6030 Service Kit for Perkins
Contains: [1] BT215 Lube
 [1] PF717 Pri. Fuel
 [1] BT351 Hydraulic
 [1] PT9167 Hydraulic



BK6049 Service Kit for Chevrolet/GMC
Contains: [1] B1428 Lube
 [1] BF781 Pri. Fuel
 [2] BT839-10 Hydraulic
 [1] P106-HD Steering
 [1] PA2256 Air Breather



BK6031 Service Kit for Paccar
Contains: [1] B7177 Lube
 [1] BF1378-SPS Fuel/Water Separator
 [1] BF7940 Fuel



BK6050 Service Kit for Mack/Volvo
Contains: [1] BT287 F-F Lube
 [2] B7600 F-F Lube
 [1] B7685 B-P Lube
 [1] BF7814 Pri. Fuel
 [1] BF1366-O Fuel/Water Separator
 [1] BW5141 Coolant
 [2] BT8851-MPG Hydraulic



BK6032 Service Kit for Paccar
Contains: [1] BD7309 Dual-Flow Lube
 [1] BF1378-SPS Fuel/Water Separator
 [1] BF7924 Fuel



BK6051 Service Kit for Mack/Volvo
Contains: [2] B76 F-F Lube
 [1] B7685 B-P Lube
 [1] BF7814 Pri. Fuel
 [1] BF1386-O Fuel/Water Separator



BK6053 Service Kit for Mack/Volvo
Contains: [2] B76 F-F Lube
 [1] BC7242 B-P Lube
 [1] BF7656 Pri. Fuel
 [1] BF7773 Fuel



Measurements Are Shown In Inches And (Millimeters)

WARNING: These products can expose you to chemicals, including Diisononyl Phthalate, Carbon black extracts, Nickel, 1,3 Butadiene, Ethylene Oxide, Epichlorohydrin, which are known to the State of California to cause cancer, and Bisphenol, Ethylene Glycol, Ethylene Oxide, 1,3 Butadiene, Epichlorohydrin, which are known to the State of California to cause birth defects or other reproductive harm. For more information go to www.P65Warnings.ca.gov.

BK6054

Service Kit for Mack/Volvo

- Contains:** [2] B76 F-F Lube
[1] BC7242 B-P Lube
[1] BF7943 Fuel
[1] BF1386-O Fuel/Water Separator



BK6055

Service Kit for Cummins

- Contains:** [1] BD7153 Dual-Flow Lube
[1] BF7766 Fuel
[1] PF7755 Fuel/Water Separator



BK6056

Service Kit for Cummins

- Contains:** [1] B7177 Lube
[1] BF7940 Fuel
[1] BF1378-SPS Fuel/Water Separator
[1] BT287-10 Hydraulic



BK6057

Service Kit for Mack/Volvo

- Contains:** (2) B7225 F-F Lube
(1) B7685 B-P Lube
(1) BF1386-O Fuel/Water Separator
(1) BF7814 Fuel Spin-on
(1) BW5141 Coolant Spin-on with BTE Formula
Fits: Mack Trucks



BK6058

Service Kit for Mack/Volvo

- Contains:** [2] B76 F-F Lube
[1] BC7242 B-P Lube
[1] BF7814 Fuel
[1] BF1386-O Fuel/Water Separator



BK6059

Service Kit for Caterpillar

- Contains:** [1] B99 Lube
[1] BF7587 Fuel
[1] BF1212 Fuel/Water Separator
[1] BW5137 Coolant
[1] P528 Steering



BK6060

Service Kit for Cummins

- Contains:** [1] B7177 F-F Lube
[1] B7577 B-P Lube
[1] BF7966 Pri. Fuel
[1] BF1210 Fuel/Water Separator
[1] BF1385-SPS Fuel/Water Separator
[1] BT839-10 Hydraulic
[1] PT951 Steering



BK6061

Service Kit for Detroit Diesel

- Contains:** [2] B495-SS Lube
[1] PF7748 Fuel/Water Separator
Fits: International Trucks
Replaces: Fleetguard MK12941



BK6062

Service Kit for Mack/Volvo

- Contains:** [2] B7600 F-F Lube
[1] B7685 B-P Lube
[1] BF7814 Fuel
[1] PF7782 Fuel/Water Separator
Fits: Volvo Equipment
Replaces: Fleetguard MK13185; Wix 24039



BK6064

Service Kit for Cummins

- Contains:** [1] BD7154 Dual-Flow Lube
[1] PF9814 Fuel
[1] BF9860 Fuel
Fits: Cummins Engines
Replaces: Fleetguard MK13448



BK6065

Service Kit for Kubota

- Contains:** [2] B113 F-F Lube
[1] B7152 B-P Lube
[1] BF840-K1 In-Line Fuel



BK6067

Service Kit for Carrier

- Contains:** [1] B7139 Lube
[1] BF988 Pri. Fuel
[1] RS3715 Radial Seal Outer Air



BK6068

Service Kit for Mack / Volvo

- Contains:** [2] B76 F-F Lube
[1] B7409 B-P Lube
[1] BF1386-O Fuel/Water Separator
[1] BF46117 Fuel



BK6069

Service Kit for Mack / Volvo

- Contains:** [2] B76 F-F Lube
[1] B7409 B-P Lube
[1] BF1386-O Fuel/Water Separator
[1] BF46117 Fuel
[1] BW5183 Coolant



Measurements Are Shown In Inches And (Millimeters)

WARNING: These products can expose you to chemicals, including Diisononyl Phthalate, Carbon black extracts, Nickel, 1,3 Butadiene, Ethylene Oxide, Epichlorohydrin, which are known to the State of California to cause cancer, and Bisphenol, Ethylene Glycol, Ethylene Oxide, 1,3 Butadiene, Epichlorohydrin, which are known to the State of California to cause birth defects or other reproductive harm. For more information go to www.P65Warnings.ca.gov.

BK6070

Service Kit for Mack / Volvo
Contains: [2] B76 F-F Lube
 [1] B7409 B-P Lube
 [1] BF7943 Pri. Fuel



BK6071

Service Kit for Mack / Volvo
Contains: [2] B76 F-F Lube
 [1] BC7242 B-P Lube
 [1] BF7773 Pri. Fuel



BK6073

Service Kit for Mack / Volvo
Contains: [2] B76 F-F Lube
 [1] B7409 B-P Lube
 [1] BF7943 Fuel
 [1] BF1386-O Fuel/Water Separator
 [1] B5145 Coolant



BK6075

Service Kit for Mack / Volvo
Contains: [2] B7225 F-F Lube
 [1] BC7242 B-P Lube
 [1] BF7656 Pri. Fuel
 [1] BF7773 Fuel
 [1] B5176 Coolant



BK6076

Service Kit for Caterpillar
Contains: [1] B7299 Lube
 [1] BF7587 Fuel
 [1] BF1212 Fuel/Water Separator



BK6080

Service Kit for Cummins
Contains: [1] BD103 Dual-Flow Lube
 [1] BF880-FP Pri. Fuel



BK6081

Service Kit for Cummins
Contains: [1] BD7154 Dual-Flow Lube
 [1] PF9814 Fuel Element
 [1] BF9885 Fuel Spin-on



BK6082

Service Kit for Mack/Volvo
Contains: [2] B76 F-F Lube
 [1] B7409 B-P Lube
 [1] BF46034 Fuel Spin-on



BK6083

Service Kit for Mack/Volvo
Contains: [2] B7225 F-F Lube
 [1] B7685 B-P Lube
 [1] BF1386-O Fuel/Water Separator
 [1] BF46117 Fuel



BK6085

Service Kit for Mack/Volvo
Contains: [2] B76 F-F Lube
 [1] B7685 B-P Lube
 [1] BF46117 Fuel



BK6086

Service Kit for Cummins
Contains: [1] BD7154 Dual-Flow Lube
 [1] BF9885 Fuel
 [1] PF9928 Fuel/Water Separator



BK6087

Service Kit for Thermo King
Contains: [1] B161-S Lube
 [1] BF9894 Pri. Fuel
 [1] RS3715 Radial Seal Outer Air



BK6088

Service Kit for Detroit Diesel
Contains: [1] P7505 Lube
 [1] PF9924 Kit Fuel Filter Kit
 [1] P5092 Coolant
Fits: Freightliner Coronado SD



BK6089

Service Kit for Thermo King
Contains: [1] B7375 Lube
 [1] BF9893 Fuel
 [1] RS5387 KIT Radial Seal Air Element with Lid
Fits: Thermo King Refrigeration Units
Replaces: Thermo King 10-449



Measurements Are Shown In Inches And (Millimeters)

WARNING: These products can expose you to chemicals, including Diisononyl Phthalate, Carbon black extracts, Nickel, 1,3 Butadiene, Ethylene Oxide, Epichlorohydrin, which are known to the State of California to cause cancer, and Bisphenol, Ethylene Glycol, Ethylene Oxide, 1,3 Butadiene, Epichlorohydrin, which are known to the State of California to cause birth defects or other reproductive harm. For more information go to www.P65Warnings.ca.gov.

BK6090

Service Kit for Mack/Volvo

Contains: [2] B7225 F-F Lube
[1] B7685 B-P Lube
[1] BF1386-O Fuel/Water Separator
[1] BF7814 Fuel
Replaces: Donaldson P559106; Fleetguard FF5507, LF3654, LF3973, FS19966



BK6092

Service Kit for Cummins

Contains: [1] BD50000 Lube
[1] PF9814 Fuel/Water Separator
[1] BF9885 Fuel



BK6093

Service Kit for Mack/Volvo

Contains: [2] B7700 High Efficiency Lube
[1] B7685 B-P Lube
[1] BF1386-O Fuel/Water Separator
[1] BF7814 Fuel
[1] BW5142 Coolant



BK6094

Service Kit for Mack/Volvo

Contains: [2] B76 F-F Lube
[1] B7409 B-P Lube
[1] BF1386-O Fuel/Water Separator
[1] BF7943 Fuel
[1] B5176 Coolant



BK6095

Service Kit for Mack/Volvo

Contains: [2] B7600 F-F Lube
[1] B7685 B-P Lube
[1] BF7814 Fuel
Fits: Volvo Engines
Replaces: Donaldson P559143



BK6096

Service Kit for Detroit Diesel

Contains: [1] P7505 Lube Element
[1] PF9908 KIT Fuel Filter Kit
Fits: Detroit DD13, DD15, DD16;
Mercedes-Benz OM471LA, OM473LA Engines
Replaces: Donaldson P559665



BK6097

Service Kit for Cummins

Contains: [1] BT7237 Lube
[1] BF1385-SPS Fuel/Water Separator
[1] BF7813 Fuel
Fits: Cummins Engines
Replaces: Donaldson P559144



BK6098

Service Kit for Detroit Diesel

Contains: [1] P7505, [1] PF9924 KIT
Fits: Detroit DD13, DD15, DD16 Engines
Replaces: Donaldson P559646



BK6099

Service Kit for Mack/Volvo

Contains: [2] B7700 High Efficiency Lube
[1] B7685 B-P Lube
[1] BF46117 Fuel



BK6102

Service Kit for Cummins

Contains: [1] BD7153 Dual-Flow Lube
[1] BF7766 Fuel
[1] BF7760 Fuel
Fits: Cummins Engines



BK6103

Service Kit for Detroit Diesel

Contains: [2] B495-SS Lube
[1] PF7744 Fuel/Water Separator
Fits: Detroit Diesel Engines



BK6104

Service Kit for Volvo

Contains: [2] B7600 F-F Lube
[1] B7685 B-P Lube
[1] PF7744 Fuel/Water Separator
[1] BF7814 Fuel
Fits: Volvo Engines



BK6105

Service Kit for Caterpillar

Contains: [1] B99-MPG F-F Lube
[1] BF7587 High Efficiency Fuel
[1] BF5800 Pri. Fuel
[1] BW5071 Coolant
Fits: Caterpillar Engines



Measurements Are Shown In Inches And (Millimeters)

WARNING: These products can expose you to chemicals, including Diisononyl Phthalate, Carbon black extracts, Nickel, 1,3 Butadiene, Ethylene Oxide, Epichlorohydrin, which are known to the State of California to cause cancer, and Bisphenol, Ethylene Glycol, Ethylene Oxide, 1,3 Butadiene, Epichlorohydrin, which are known to the State of California to cause birth defects or other reproductive harm. For more information go to www.P65Warnings.ca.gov.

BK6106 Service Kit for Cummins
Contains: [2] B495-SS Lube
 [1] PF7895 Fuel/Water Separator
Fits: Cummins Engines



BK6115 Service Kit for Caterpillar
Contains: [1] B7299 High Efficiency Lube
 [1] BF7587 High Efficiency Fuel
 [1] BF5800 Pri. Fuel
 [1] BW5071 Coolant
Fits: Caterpillar Engines



BK6107 Service Kit for Caterpillar
Contains: [1] B99-MPG F-F Lube
 [1] BF5800 Pri. Fuel
 [1] BF7587 High Efficiency Fuel
Fits: Caterpillar Engines



BK6116 Service Kit for Mack/Volvo
Contains: [2] B76 F-F Lube
 [1] B7409 B-P Lube
 [1] PF7930 Fuel/Water Separator
 [1] BF46117 Fuel
Fits: Mack/Volvo Engines



BK6108 Service Kit for Detroit Diesel
Contains: [1] P7505 Lube
 [1] PF9804 Fuel/Water Separator
 [1] PF9908 KIT Fuel Kit
Fits: Detroit Diesel Engines



BK6117 Service Kit for Volvo
Contains: [2] B7700 High Efficiency Lube
 [1] B7685 B-P Lube
 [1] PF7680 Fuel/Water Separator
 [1] BW5142 Coolant



BK6110 Service Kit for Thermo King
Notes: Biodiesel compatible outer wrap and grommet
Contains: [1] B7375 Lube
 [1] BF9894 Fuel/Water Separator
 [1] RS5387 KIT Radial Seal Air Element with Lid
Fits: Thermo King Refrigeration Units
Replaces: Thermo-King 10-417



BK6118 Service Kit for Cummins ISX, X15 Engines
Contains: [1] BD50000 High Efficiency Dual-Flow Lube
 [1] PF9814 Fuel/Water Separator
 [1] BF46129 Fuel



BK6112 Service Kit for GasJack
Contains: [1] BT251 F-F Lube
 [1] BF840-K1 In-Line Fuel Filter with Clamps & Hoses
 [1] PA638 Air Element
Fits: GasJack Compressors with Ford 460 Engine



BK6120 Service Kit for Caterpillar
Contains: [1] B7299 High Efficiency Fuel
 [1] BF5800 Pri. Fuel
 [1] BF614 Fuel
 [1] BW5071 Coolant
Fits: Caterpillar Engines



BK6114 Service Kit for Cummins
Contains: [1] BD50000 Lube
 [1] PF46081 Fuel/Water Separator
 [1] BF46129 Fuel
Fits: Cummins Engines



BK6121 Service Kit for Mack/Volvo
Contains: [2] B76 F-F Lube
 [1] B7409 B-P Lube
 [1] BF46117 Fuel
 [1] PF7782 Fuel/Water Separator with Relief Valve
Fits: Mack/Volvo Engines



BK6124 Service Kit
Contains: [2] B76 F-F Lube
 [1] B7409 B-P Lube
 [1] BF46117 Fuel
 [1] BF46182-O Fuel/Water Separator
Fits: Mack/Volvo Engines



Measurements Are Shown In Inches And (Millimeters)

WARNING: These products can expose you to chemicals, including Diisononyl Phthalate, Carbon black extracts, Nickel, 1,3 Butadiene, Ethylene Oxide, Epichlorohydrin, which are known to the State of California to cause cancer, and Bisphenol, Ethylene Glycol, Ethylene Oxide, 1,3 Butadiene, Epichlorohydrin, which are known to the State of California to cause birth defects or other reproductive harm. For more information go to www.P65Warnings.ca.gov.

BK6130

Service Kit



Contains: [2] B7225 Full-Flow Lube
[1] B7685 By-Pass Lube
[1] BF1386-O Fuel-Water Separator
[1] BF46117 Fuel Spin-on
[1] BW5141 Coolant
Fits: Mack & Volvo Engine Applications

BK6138

Service Kit for Volvo



Contains: [2] B7700 High Efficiency Lube
[1] B7685 B-P Lube
[1] PF7680 Fuel/Water Separator
[1] BF7814 Fuel
[1] BW5142 Coolant
Replaces: Donaldson P559632

BK6140

Service Kit for Mack/Volvo



Contains: [2] B76 Full-Flow Lube Spin-ons
[1] B7685 By-Pass Lube Spin-on
[1] BF7814 Fuel Spin-on

BK6161

Service Kit for Mercedes-Benz



Contains: [1] P7188 Lube
[1] BC7326 By-Pass Lube Spinner
[1] PF7735 Fuel

BK6167

Service Kit for Cummins



Contains: [1] BD7309 Dual-Flow Lube
[1] BF1293-SPS Fuel/Water Separator

BK6183

Service Kit for Caterpillar



Contains: [1] B7299 Lube
[1] BF7587 Fuel
[1] BF1259 Fuel/Water Separator

BK6184

Service Kit for Caterpillar



Contains: [1] B7299 High Efficiency Lube
[1] BF7587 Fuel

BK6185

Service Kit for Mack/Volvo



Contains: [2] B7225 F-F Lube
[1] BC7242 B-P Lube Spinner
[1] BF7656 Pri. Fuel
[1] BF7773 Sec. Fuel
[1] BW5178 Coolant

BK6187

Service Kit for Caterpillar



Contains: [1] B7299 Lube
[1] BF596 Pri. Fuel
[1] BF7587 Fuel

BK6195

Service Kit for Caterpillar



Contains: [1] B99 Lube
[1] BF7587 Fuel
Replaces: Donaldson P559519; Fleetguard MK12673

BK6196

Service Kit for Caterpillar



Contains: [1] B99 Lube
[1] BF7587 Fuel
[1] BW5137 Coolant

BK6215

Service Kit for Caterpillar



Contains: [1] B99 Lube
[1] BF957 Pri. Fuel
[1] BF7587 Fuel
[1] B5134 Coolant

Measurements Are Shown In Inches And (Millimeters)

WARNING: These products can expose you to chemicals, including Diisononyl Phthalate, Carbon black extracts, Nickel, 1,3 Butadiene, Ethylene Oxide, Epichlorohydrin, which are known to the State of California to cause cancer, and Bisphenol, Ethylene Glycol, Ethylene Oxide, 1,3 Butadiene, Epichlorohydrin, which are known to the State of California to cause birth defects or other reproductive harm. For more information go to www.P65Warnings.ca.gov.

BK6287

Service Kit for Caterpillar
Contains: [1] B7600 Lube
[1] BF7632 Fuel



BK6426

Service Kit for Cummins
Contains: [1] BD7153 Dual-Flow Lube
[1] BF7760 Pri. Fuel
[1] BF7766 Fuel
[1] BW5086 Coolant



BK6341

Service Kit for Cummins
Contains: [1] BD7154 Dual-Flow Lube
[1] BF1259 Fuel/Water Separator



BK6429

Service Kit for Cummins
Contains: [1] BD103 Dual-Flow Lube
[1] BF7815 Fuel
[1] BF1293-SPS Fuel/Water Separator



BK6375

Service Kit for Cummins
Contains: [1] BD103 Dual-Flow Lube
[1] BF1259 Fuel/Water Separator
[1] BW5071 Coolant
Replaces: Donaldson P559303; Fleetguard MK12119, MK11811; Fram FK8139; Luber-finer LK208C



BK6438

Service Kit for Cummins
Contains: [1] BD7154 Dual-Flow Lube
[1] BF1259 Fuel/Water Separator
[1] B5134 Coolant



BK6376

Service Kit for Cummins
Contains: [1] BD103 Dual-Flow Lube
[1] BF1259 Fuel/Water Separator
Replaces: Donaldson P559468; Fleetguard MK11807, MK12557; Luber-finer LK228C



BK6440

Service Kit for Cummins
Contains: [1] BD7154 Dual-Flow Lube
[1] BF7760 Fuel
[1] BF7766 Fuel



BK6380

Service Kit for Cummins
Contains: [1] BD103 Dual-Flow Lube
[1] BF1212 Fuel/Water Separator
[1] BW5071 Coolant
Replaces: Donaldson P559047; Fleetguard MK11997, MK1105300; Fram FK7132; Luber-finer LK143C, LK177C



BK6451

Service Kit for Cummins
Contains: [1] BD103 Dual-Flow Lube
[1] BF1259 Fuel/Water Separator
[1] BW5072 Coolant



BK6457

Service Kit for Mack/Volvo
Contains: [2] B7225 F-F Lube
[1] B7685 B-P Lube
[1] BF7814 Fuel
[1] BF1386-O Fuel/Water Separator
[1] PT9394-MPG Steering



Measurements Are Shown In Inches And (Millimeters)

WARNING: These products can expose you to chemicals, including Diisononyl Phthalate, Carbon black extracts, Nickel, 1,3 Butadiene, Ethylene Oxide, Epichlorohydrin, which are known to the State of California to cause cancer, and Bisphenol, Ethylene Glycol, Ethylene Oxide, 1,3 Butadiene, Epichlorohydrin, which are known to the State of California to cause birth defects or other reproductive harm. For more information go to www.P65Warnings.ca.gov.

BK6464

Service Kit for Cummins

Contains: [1] BD7154 Dual-Flow Lube
[1] PF7755 Fuel/Water Separator
[1] BF7766 Fuel



BK6467

Service Kit for Cummins

Contains: [1] BD7309 Dual-Flow Lube
[1] BF1272-SPS Fuel/Water Separator



BK6561

Service Kit for Detroit Diesel

Contains: [2] B495 Lube
[1] BF5800 Pri. Fuel
[1] BF5810 Sec. Fuel
[1] BW5137 Coolant
Replaces: Fleetguard MK11518, MK11660



BK6562

Service Kit for Detroit Diesel

Contains: [2] B495 Lube
[1] BF5800 Pri. Fuel
[1] BF5810 Sec. Fuel
Replaces: GMC 23518686, 25014736;
Donaldson P559251; Fleetguard MK11562; Fram
FK7646; Luber-finer LK161D; Wix 24537



BK6579

Service Kit for Detroit Diesel

Contains: [2] B495 Lube
[1] BF5800 Pri. Fuel
[1] BF5810 Sec. Fuel
[1] BW5071 Coolant
Replaces: Donaldson P559299, P559466;
Fleetguard MK11666; Luber-finer LK162D



BK6583

Service Kit for Detroit Diesel

Contains: [2] B495 Lube
[1] PF7680 Fuel Element
Replaces: Donaldson P559474; Fleetguard
MK12358, MK12499



BK6595

Service Kit for Detroit Diesel

Contains: [2] B495 Lube
[1] PF7680 Fuel Element
[1] BW5137 Coolant



BK6600

Service Kit for International

Contains: [2] BT261 Lube
[1] BF979 Pri. Fuel
[1] BF588 Sec. Fuel
[1] BW5137 Coolant
Replaces: Donaldson P559217; Fleetguard
MK151900; Fram FK3888; Luber-finer LK321



BK6601

Service Kit for International

Contains: [2] BT261 Lube
[1] BF979 Pri. Fuel
[1] BF588 Sec. Fuel
Replaces: Donaldson P559009; Fleetguard
MK12427, MK146600; Fram FK3887, FK3905;
Luber-finer LK91



BK6610

Service Kit for International

Contains: [2] B299 Lube
[1] BF979 Pri. Fuel
[1] BF588 Sec. Fuel
Replaces: Fleetguard MK11029; Luber-finer
LK1151



BK6613

Service Kit for Mack/Volvo

Contains: [2] B76 F-F Lube
[1] BC7242 Centrifugal B-P Lube
[1] BF7656 Pri. Fuel
[1] BF7657 Sec. Fuel



BK6619

Service Kit for International

Contains: [1] B7030 Lube
[1] BF7629 Fuel
[1] BW5137 Coolant
Replaces: Luber-finer LK2041; Wix 24567



BK6634

Service Kit for International

Contains: [1] B7030 Lube
[1] BF7629 Fuel
[1] BW5071 Coolant



BK6650

Service Kit for Mack/Volvo

Contains: [2] B76-SS F-F Lube
[1] B7685 By-Pass Lube
[1] BF7943 Fuel



Measurements Are Shown In Inches And (Millimeters)

WARNING: These products can expose you to chemicals, including Diisononyl Phthalate, Carbon black extracts, Nickel, 1,3 Butadiene, Ethylene Oxide, Epichlorohydrin, which are known to the State of California to cause cancer, and Bisphenol, Ethylene Glycol, Ethylene Oxide, 1,3 Butadiene, Epichlorohydrin, which are known to the State of California to cause birth defects or other reproductive harm. For more information go to www.P65Warnings.ca.gov.

BK6652 Service Kit for International
Contains: [1] BD7250 Dual Flow Lube
 [1] PF7779 Fuel Element



BK6661 Service Kit for Mercedes-Benz
Contains: [1] P7188 Lube
 [1] PF7735 Fuel



BK6653 Service Kit for Mack/Volvo
Contains: [2] B7225 F-F Lube
 [1] BC7242 B-P Lube
 [1] BF7656 Pri. Fuel
 [1] BF1286 Fuel/Water Separator
 [1] BW5178 Coolant
Fits: Mack ASET-CEGR Engine
Replaces: Mack 57GC2245



BK6662 Service Kit for Mack/Volvo
Contains: [2] B7225 F-F Lube
 [1] BC7242 B-P Lube Spinner
 [1] BF7656 Pri. Fuel
 [1] BF1286 Fuel/Water Separator



BK6654 Service Kit for Mack/Volvo
Contains: [2] B7600 F-F Lube
 [1] B7685 B-P Lube
 [1] BF7814 Fuel
 [1] BF1329 Fuel/Water Separator
 [1] B5145 Coolant



BK6663 Service Kit for Mack/Volvo
Contains: [2] B76-SS F-F Lube
 [1] B7685 B-P Lube
 [1] BF7814 Fuel



BK6656 Service Kit for Mack/Volvo
Contains: [2] B76 F-F Lube
 [1] B7409 B-P Lube
 [1] BF1386-O Fuel/Water Separator
 [1] BF7943 Fuel
 [1] BW5183 Coolant



BK6665 Service Kit for Mack/Volvo
Contains: [2] B7225 F-F Lube
 [1] BC7242 B-P Lube Spinner
 [1] BF7656 Pri. Fuel
 [1] BF7773 Fuel



BK6657 Service Kit for Mack/Volvo
Contains: [2] B7225 F-F Lube
 [1] BC7242 B-P Lube
 [1] BF7656 Pri. Fuel
 [1] BF7657 Sec. Fuel
 [1] BW5178 Coolant
Fits: Mack ASET-IEGR Engine
Replaces: Mack 57GC2234



BK6666 Service Kit for Mack/Volvo
Contains: [2] B7225 F-F Lube
 [1] BC7228 B-P Lube
 [1] BF7657 Fuel
 [1] BF1256 Pri. Fuel/Water Separator



BK6658 Service Kit for Mack/Volvo
Contains: [2] B7225 F-F Lube
 [1] BC7242 B-P Lube Spinner
 [1] BF1256 Fuel/Water Separator
 [1] BF7657 Sec. Fuel



BK6670 Service Kit for Mack/Volvo
Contains: [2] B76-SS F-F Lube
 [1] B7685 B-P Lube
 [1] PF7744 Pri. Fuel
 [1] BF7814 Fuel



BK6659 Service Kit for Mack/Volvo
Contains: [2] B7225 F-F Lube
 [1] BC7242 B-P Lube Spinner
 [1] BF1256 Fuel/Water Separator
 [1] BF7773 Fuel



BK6675 Service Kit for Mercedes-Benz
Contains: [1] P7230 Lube
 [1] PF7761 Fuel



Measurements Are Shown In Inches And (Millimeters)

WARNING: These products can expose you to chemicals, including Diisononyl Phthalate, Carbon black extracts, Nickel, 1,3 Butadiene, Ethylene Oxide, Epichlorohydrin, which are known to the State of California to cause cancer, and Bisphenol, Ethylene Glycol, Ethylene Oxide, 1,3 Butadiene, Epichlorohydrin, which are known to the State of California to cause birth defects or other reproductive harm. For more information go to www.P65Warnings.ca.gov.

BK6676

Service Kit for Mercedes-Benz
Contains: [1] P7230 Lube
 [1] PF7748 Fuel/Water Separator
 [1] PF7761 Fuel



BK6683

Service Kit for Mack/Volvo
Contains: [2] B76-SS F-F Lube
 [1] B7685 B-P Lube
 [1] BF7653 Pri. Fuel



BK6686

Service Kit for Caterpillar
Contains: [1] B99 Lube
 [1] BF957 Pri. Fuel
 [1] BF7587 Fuel



BK6693

Service Kit for Mack/Volvo
Contains: [2] B7225 F-F Lube
 [1] BC7242 B-P Lube Spinner
 [1] BF7656 Pri. Fuel
 [1] BF7657 Sec. Fuel



BK6694

Service Kit for Mack/Volvo
Contains: [2] B76 F-F Lube
 [1] BC7173 B-P Lube Spinner
 [1] BF7656 Pri. Fuel
 [1] BF7657 Sec. Fuel
 [1] BW5178 Coolant
Replaces: Fleetguard MK12790



BK6696

Service Kit for Mack/Volvo
Contains: [2] B76 F-F Lube
 [1] BC7173 B-P Lube Spinner
 [1] BF7656 Pri. Fuel
 [1] BF7657 Sec. Fuel
Replaces: Mack 57GC2188A; Fleetguard MK12698



BK6700

Service Kit for Mack/Volvo
Contains: [2] B76 Lube
 [1] BF877 Pri. Fuel
 [1] BF876 Sec. Fuel
 [1] BW5178 Coolant
Replaces: Mack 57GC294, 215SB192A;
 Donaldson P559001; Fleetguard MK31M; Fram
 FK3352; Luber-finer LK1M; Purolator K50001;
 Wix 24210



BK6702

Service Kit for Mack/Volvo
Contains: [2] B76 Lube
 [1] BF877 Pri. Fuel
 [1] BF976 Sec. Fuel
Replaces: Donaldson P559205; Fleetguard
 MK11116; Luber-finer LK77M



BK6704

Service Kit for Mack/Volvo
Contains: [2] B76 F-F Lube
 [1] BC110 B-P Lube Spinner
 [1] BF7656 Pri. Fuel
 [1] BF7657 Sec. Fuel
 [1] BW5178 Coolant
Replaces: Mack 57GC2177; Fram FK8454;
 Luber-finer LK236M; Wix 24566



BK6705

Service Kit for Mack/Volvo
Contains: [2] B76 F-F Lube
 [1] BC110 B-P Lube Spinner
 [1] BF7656 Pri. Fuel
 [1] BF7657 Sec. Fuel
Replaces: Mack 57GC2177A, 57GC2177B;
 Hastings KF48



BK6710

Service Kit for Mack/Volvo
Contains: [3] B76 Lube
 [1] BF877 Pri. Fuel
 [1] BF976 Sec. Fuel
 [1] BW5179 Coolant
Replaces: Mack 57GC295A, 215SB134A;
 Donaldson P559031; Fleetguard MK33M; Fram
 FK3434; Luber-finer LK3M; Purolator K50002;
 Wix 24222



BK6720

Service Kit for Mack/Volvo
Contains: [2] B76 F-F Lube
 [1] BC110 B-P Lube Spinner
 [1] BF877 Pri. Fuel
 [1] BF976 Sec. Fuel
 [1] BW5179 Coolant
Replaces: Mack 57GC298, 57GC2136;
 Fleetguard MK11057; Fram FK7121; Luber-finer
 LK107M; Purolator K50005; Wix 24561



BK6721

Service Kit for Mack/Volvo
Contains: [2] B76 F-F Lube
 [1] BC110 B-P Lube Spinner
 [1] BF877 Pri. Fuel
 [1] BF976 Sec. Fuel
Replaces: Mack 215SB210, 215SB210A;
 Donaldson P559222; Fleetguard MK11362; Fram
 FK8064; Luber-finer LK170M; Wix 24564





BK6723

Service Kit for Mack/Volvo
Contains: [2] B76 F-F Lube
 [1] BC110 B-P Lube Spinner
 [1] BF877 Pri. Fuel
 [1] BF976 Sec. Fuel
 [1] BW5178 Coolant
Replaces: Mack 57GC2120, 57GC2120B;
 Donaldson P559051; Fleetguard MK11412; Fram
 FK7120; Hastings KF23; Luber-finer LK109M;
 Purolator K50015



Measurements Are Shown In Inches And (Millimeters)

WARNING: These products can expose you to chemicals, including Diisononyl Phthalate, Carbon black extracts, Nickel, 1,3 Butadiene, Ethylene Oxide, Epichlorohydrin, which are known to the State of California to cause cancer, and Bisphenol, Ethylene Glycol, Ethylene Oxide, 1,3 Butadiene, Epichlorohydrin, which are known to the State of California to cause birth defects or other reproductive harm. For more information go to www.P65Warnings.ca.gov.

<p>BK6764</p>  <p>Service Kit for International Contains: [1] B7030 Lube [1] BF7629 Fuel Replaces: Fleetguard MK11663, MK12150; Luber-finer LK209I</p>	<p>BK6933</p>  <p>Service Kit for Caterpillar, Mitsubishi Lift Trucks Contains: [1] B7049 Lube [1] RS3716 Radial Seal Outer Air</p>
<p>BK6780</p>  <p>Service Kit for Mack/Volvo Contains: [1] PA2438 Inter-Cooler Air Element [1] PA2439 Air Element [2] G25-AF Gaskets Replaces: Mack 215SB194; Donaldson X005582; Fram KA1549; Luber-finer LK1MA</p>	<p>BK6934</p>  <p>Service Kit for Detroit Diesel Contains: [2] B495-SS Severe Service Lube [1] PF7680 Fuel/Water Separator</p>
<p>BK6799</p>  <p>Service Kit for Thermo King Contains: [1] BD7095 Dual-Flow Lube [1] BF7579 Box-Style Fuel Filter [1] BF7580 Box-Style Fuel/Water Separator Replaces: Fleetguard MK12073; Luber-finer LK195T</p>	<p>BK6942</p>  <p>Service Kit for Mack/Volvo Contains: [2] B7225 F-F Lube [1] B7409 B-P Lube [1] BF7943 Fuel [1] BF1386-O Fuel/Water Separator</p>
<p>BK6903</p>  <p>Service Kit for Mack/Volvo Contains: [1] B76 F-F Lube [1] B7685 B-P Lube [2] BF988 Fuel</p>	<p>BK6953</p>  <p>Service Kit for Caterpillar Contains: [1] B99 Lube [1] BF7587 Fuel [1] BW5071 Coolant</p>
<p>BK6923</p>  <p>Service Kit for Mack/Volvo Contains: [2] B7225 F-F Lube [1] BC7242 B-P Lube [1] PF7680 Fuel/Water Separator</p>	<p>BK6954</p>  <p>Service Kit for Caterpillar Contains: [1] B99 Lube [1] BF7587 Fuel [1] BF1259 Fuel/Water Separator</p>
<p>BK6930</p>  <p>Service Kit for Mack/Volvo Contains: [2] B76 F-F Lube [1] B7685 B-P Lube [1] BF7814 Fuel [1] BF1329 Fuel/Water Separator [1] BW5142 Coolant</p>	<p>BK6955</p>  <p>Service Kit for Cummins Contains: [1] BD7154 Dual-Flow Lube [1] BF7766 Fuel [1] BF1212 Fuel/Water Separator</p>
<p>BK6931</p>  <p>Service Kit for Mack/Volvo Contains: [2] B76 F-F Lube [1] B7685 B-P Lube [1] BF7814 Fuel [1] BF1366-O Fuel/Water Separator [1] BW5142 Coolant</p>	

Measurements Are Shown In Inches And (Millimeters)

WARNING: These products can expose you to chemicals, including Diisononyl Phthalate, Carbon black extracts, Nickel, 1,3 Butadiene, Ethylene Oxide, Epichlorohydrin, which are known to the State of California to cause cancer, and Bisphenol, Ethylene Glycol, Ethylene Oxide, 1,3 Butadiene, Epichlorohydrin, which are known to the State of California to cause birth defects or other reproductive harm. For more information go to www.P65Warnings.ca.gov.

BK6956

Service Kit for Mack/Volvo

- Contains:** [2] B76 F-F Lube
[1] B7409 B-P Lube
[1] BF1386-O Fuel/Water Separator
[1] BF7943 Fuel Spin-on



BK6987

Service Kit for Cummins

- Contains:** [1] BT339 Lube
[1] BF7695 Pri. Fuel
[1] BT839-10 Hydraulic



BK6980

Service Kit for Cummins

- Contains:** [1] BT339 F-F Lube
[1] B7577 B-P Lube
[1] BF1210 Fuel/Water Separator
[1] BT839-10 Hydraulic
[1] PT951 Steering



BK6997

Service Kit for Carrier

- Contains:** [1] B7139 Lube
[1] BF840 In-Line Fuel
[1] BF954 Fuel
[1] RS3715 Radial Seal Outer Air



BK6982

Service Kit for Cummins

- Contains:** [1] BT339 Lube
[1] BF7519 Fuel
[1] BF1356 Fuel/Water Separator
[1] BT839 Hydraulic
[1] PT951 Steering
[1] PT9415-MPG KIT Transmission



P7000 KIT

Kit of 2 Lube Elements

- Contains:** [1] P7092
[1] P7093
Fits: Case, Furukawa, Kobelco, MDI/Yutani, Mitsubishi, Tadano Equipment
Replaces: Case 151197A1; Kobelco 2451U-1801; Mitsubishi ME064356
P7092
O.D.: 5 1/16 (128.6)
I.D.: 2 11/32 (59.5)
Height: 5 7/8 (149.2)
P7093
O.D. 5 1/16
I.D. 19/32
Height 6 23/32



BK6983

Service Kit for Cummins

- Contains:** [1] B7177 Lube
[1] BF7540 Fuel
[1] BF1378-SPS Fuel/Water Separator
[1] BT839-10 Hydraulic
[1] PT951 Steering
[1] PT9415-MPG KIT Transmission



BK6984

Service Kit for Cummins

- Contains:** [2] BF1212 Pri. Fuel
[1] BT8847 Hydraulic
[2] BT8873 Hydraulic
[3] PT752 Hydraulic
[1] BW5071 Coolant



B7001

Lube Spin-on

- Contains:** Anti-Drainback Valve
14 PSID By-Pass Valve
Fits: Ford (Europe) Transit
Replaces: Ford 914F-6714-A, 914F-6714-AA
Thread: M22 x 1.5
O.D.: 3 11/16 (93.7)
Height: 3 3/4 (95.3)
I.Gskt: [1] Included



BK6985

Service Kit for Cummins

- Contains:** [1] B7177 Lube
[1] BF7940 Fuel
[1] BF1378-SPS Fuel/Water Separator
[1] BT839-10 Hydraulic



P7003

Full-Flow Lube Element

- Fits:** Caterpillar Industrial, Marine Engines
Replaces: Caterpillar 1R0726, 4P2839, 7N7500
O.D.: 7 3/8 (187.3)
I.D.: 2 27/32 (72.2)
Height: 10 9/32 (261.1)
A. Gskt: [2] Attached



BK6986

Service Kit for Cummins

- Contains:** [1] B7177 Lube
[1] BF1212 Fuel/Water Separator
[1] BF1378-SPS Fuel/Water Separator
[1] BT839-10 Hydraulic



B7004

Lube Spin-on

- Fits:** Hitachi Equipment
Replaces: Hitachi 4206079
Thread: 1 1/2 -12
O.D.: 4 21/32 (118.3)
Height: 8 3/32 (205.6)
I.Gskt: [1] Included



Measurements Are Shown In Inches And (Millimeters)

WARNING: These products can expose you to chemicals, including Diisononyl Phthalate, Carbon black extracts, Nickel, 1,3 Butadiene, Ethylene Oxide, Epichlorohydrin, which are known to the State of California to cause cancer, and Bisphenol, Ethylene Glycol, Ethylene Oxide, 1,3 Butadiene, Epichlorohydrin, which are known to the State of California to cause birth defects or other reproductive harm. For more information go to www.P65Warnings.ca.gov.

B7005 Full-Flow Lube Spin-on
Fits: Hino Trucks; Hitachi Equipment
Replaces: Detroit Diesel 23530411; Hino 15607-1380, 15607-1740; Hitachi 4178801, 4283859; Isuzu 1-13240-046-0, 1-13240-075-0
Thread: 1 1/2 -12
O.D.: 4 21/32 (118.3)
Height: 8 3/32 (205.6)
I.Gskt: [1] Included



P7013 Lube Element
Fits: Hino Engines; Hitachi Equipment
Replaces: Hitachi 4507886
O.D.: 3 15/16 (100.0)
I.D.: 19/32 (15.1)
Height: 5 29/32 (150.0)
F. Gskt: [1] Included
Grommets: [2] Attached



P7007 Lube Element
Replaces: Deutz 1172637
O.D.: 7 5/8 (193.7)
I.D.: 4 21/32 (118.3)
Height: 7 3/32 (180.2)
A. Gskt: [2] Attached



B7014 Lube Spin-on
Contains: Anti-Drainback Valve
 14 PSID By-Pass Valve
Fits: Hino Engines; Kobelco Loaders
Replaces: Hino 15607-1630
Thread: 1 -16
O.D.: 3 11/16 (93.7)
Height: 5 3/8 (136.5)
I.Gskt: G381-A



B7009 Lube Spin-on
Contains: 8 PSID By-Pass Valve
Fits: Ford Tractors
Replaces: Ford F0NN-6714-AA
Thread: 1 -12
O.D.: 4 1/4 (108.0)
Height: 5 7/8 (149.2)
I.Gskt: G401



P7015 Lube Element
Fits: Claas, Demag Equipment; M.A.N., Mercedes-Benz Buses, Trucks
Replaces: Claas 1335300; Demag 760017; Mann & Hummel H9471, H9471X
O.D.: 3 5/16 (84.1)
I.D.: 29/32 (23.0)
Height: 7 27/32 (199.2)
F. Gskt: [2] Metal Washers
O-Ring: [1] Included
Grommets: [2] Attached



B7010 Lube Spin-on
Fits: GM, Saturn Automotive
Replaces: GMC 25014377
Thread: 13/16 -16
O.D.: 3 (76.2)
Height: 4 3/32 (104.0)
I.Gskt: [1] Included



P7016 Lube Element
Fits: Mercedes-Benz Trucks, Vans
Replaces: Mercedes-Benz 4411800009
O.D.: 3 9/32 (83.3)
I.D.: 13/16 (20.6)
Height: 7 27/32 (199.2)
O-Ring: [2] Included
Grommets: [2] Attached



B7011 Lube or Hydraulic Spin-on
Notes: Can be used with OB1314 and OB1316 bases (requires optional G286-C gasket).
Fits: Transit Buses
Replaces: Zinga LE-3
Thread: 1 1/2 -16
O.D.: 5 1/16 (128.6)
Height: 10 3/4 (273.1)
F. Gskt: [1] Included
O. Gskt: G286-C, G369-V, G372, G447, G483, G704, G710



P7017 Lube Element
Fits: DAF, Mercedes-Benz, R.V.I. Buses, Trucks
Replaces: Mercedes-Benz 3661840225
O.D.: 3 9/32 (83.3)
I.D.: 13/16 (20.6)
Height: 5 3/8 (136.5)
I.Gskt: [2] Included
F. Gskt: [1] Copper Washer, [1] Metal Washer
O-Ring: [1] Included



P7012 Lube Element
Fits: Caterpillar Industrial, Marine Engines
Replaces: Caterpillar 1W4136
O.D.: 7 5/16 (185.7)
I.D.: 3 13/32 (86.5)
Height: 13 19/32 (345.3)
A. Gskt: [2] Attached



B7018 By-Pass Lube Spin-on
Fits: Nissan Trucks
Replaces: Nissan 15201-Z9008
Thread: 3/4 -16
O.D.: 4 1/4 (108.0)
Height: 5 7/8 (149.2)
I.Gskt: G401











Measurements Are Shown In Inches And (Millimeters)

WARNING: These products can expose you to chemicals, including Diisononyl Phthalate, Carbon black extracts, Nickel, 1,3 Butadiene, Ethylene Oxide, Epichlorohydrin, which are known to the State of California to cause cancer, and Bisphenol, Ethylene Glycol, Ethylene Oxide, 1,3 Butadiene, Epichlorohydrin, which are known to the State of California to cause birth defects or other reproductive harm. For more information go to www.P65Warnings.ca.gov.

<p>B7019 Lube Spin-on Contains: Integral Post Seal Fits: Hitachi, J.C. Bamford, Link-Belt Equipment; Isuzu Engines Replaces: Fiat 76561779; Isuzu 1-13240-105-21 Thread: 1 3/8 -16 O.D.: 4 21/32 (118.3) Height: 9 29/32 (251.6) I.Gskt: [1] Included</p> 	<p>B7025 Lube Spin-on Fits: Thermo King Refrigeration Units Replaces: Thermo King 11-6228 Thread: 3/4 -20 O.D.: 3 11/16 (93.7) Height: 5 3/8 (136.5) I.Gskt: G381-A</p> 
<p>B7020 Lube Spin-on Contains: Anti-Drainback Valve 14 PSID By-Pass Valve Fits: Lexus, Toyota Light-Duty Trucks, Vans Thread: 3/4 -16 O.D.: 3 (76.2) Height: 4 3/32 (104.0) I.Gskt: [1] Included</p> 	<p>B7026-MPG Maximum Performance Glass Hydraulic Spin-on Fits: Massey Ferguson Tractors Replaces: Massey Ferguson 3595175-M1 Thread: M24 x 2.0 O.D.: 3 21/32 (92.9) Height: 5 5/8 (142.9) I.Gskt: G381-A</p> 
<p>P7021 Lube Element Fits: Mitsubishi Equipment, Trucks Replaces: Mitsubishi 30840-06010, ME021074, ME034481 O.D.: 3 15/16 (100.0) I.D.: 11/16 (17.5) & 1 1/8 (28.6) Height: 7 27/32 (199.2) A. Gskt: [2] Attached F. Gskt: [2] Included</p> 	<p>BD7028 Dual-Flow Lube Spin-on Contains: 20 PSID By-Pass Valve Fits: Kobelco Excavators; Mitsubishi Engines, Trucks Replaces: Mitsubishi ME013307 Thread: M26 x 1.5 O.D.: 4 1/4 (108.0) Height: 5 27/32 (148.4) I.Gskt: G401</p> 
<p>B7022 Lube Spin-on Contains: Anti-Drainback Valve Fits: Nissan Buses Replaces: Nissan 15208-05D00 Thread: 3/4 -16 O.D.: 3 25/32 (96.0) Height: 5 9/32 (134.1) I.Gskt: G381-A</p> 	<p>BD7029 Dual-Flow Lube Spin-on Contains: Anti-Drainback Valve 5-8 PSID By-Pass Valve Fits: Toyota Camry with Diesel Engine Replaces: Toyota 90915-03006, 90915-30002 Thread: M24 x 1.5 O.D.: 3 31/32 (100.8) Height: 4 27/32 (123.0) I.Gskt: [1] Included</p> 
<p>B7023 Lube Spin-on Contains: 14 PSID By-Pass Valve Fits: Ingersoll-Rand Compressors Replaces: Ingersoll-Rand 39460456 Thread: 1 1/4 -12 O.D.: 3 11/16 (93.7) Height: 5 3/8 (136.5) I.Gskt: G381-A</p> 	<p>B7030 Full-Flow Lube Spin-on Contains: 30 PSID By-Pass Valve Fits: Agco, Terex Equipment; Detroit Diesel, International Engines; International Buses, Trucks Replaces: GMC 25171955; International 1819452-C1 Thread: M36 x 1.5 O.D.: 5 3/8 (136.5) Height: 12 3/32 (307.2) I.Gskt: [1] Included</p> 
<p>B7024 Air Breather Spin-on Contains: Integral Post Seal Adapter Thread: 3/4-14 NPT Fits: Boart, Fletcher Drills; Gehl, Liebherr, Oldenburg Equipment Replaces: Schroeder ABF3/10 (with Adapter) Thread: 1 1/8 -16 O.D.: 3 11/16 (93.7) Height: 4 5/16 (109.5) Related To: BT367-S (without Adapter)</p> 	<p>B7031 Full-Flow Lube Spin-on Contains: Anti-Drainback Valve 30 PSID By-Pass Valve Fits: Claas, Zetor Equipment; DAF, Iveco Buses, Trucks; Deutz Engines Replaces: Claas 568440; DAF 661049; Deutz 1174419; Iveco 1161934; Zetor 4061130 Thread: 1 -12 O.D.: 3 11/16 (93.7) Height: 6 5/8 (168.3) I.Gskt: G381-A Related To: B236 (Long Version)</p> 

Measurements Are Shown In Inches And (Millimeters)

WARNING: These products can expose you to chemicals, including Diisononyl Phthalate, Carbon black extracts, Nickel, 1,3 Butadiene, Ethylene Oxide, Epichlorohydrin, which are known to the State of California to cause cancer, and Bisphenol, Ethylene Glycol, Ethylene Oxide, 1,3 Butadiene, Epichlorohydrin, which are known to the State of California to cause birth defects or other reproductive harm. For more information go to www.P65Warnings.ca.gov.

<p>B7033 Full-Flow Lube Spin-on Contains: Anti-Drainback Valve 14 PSID By-Pass Valve Replaces: Isuzu 8-94463-713-0 Thread: M22 x 1.5 O.D.: 3 1/32 (77.0) Height: 4 1/16 (103.2) I.Gskt: [1] Included</p> 	<p>B7045 Lube Spin-on Contains: 14 PSID By-Pass Valve Fits: Toyota Engines Replaces: Toyota 15601-78010 Thread: M26 x 1.5 O.D.: 4 1/4 (108.0) Height: 5 27/32 (148.4) I.Gskt: G401</p> 
<p>B7034 By-Pass Lube Spin-on Thread: M20 x 1.5 O.D.: 3 25/32 (96.0) Height: 4 11/32 (110.3) I.Gskt: [1] Included</p> 	<p>B7047 Full-Flow Lube Spin-on Contains: Anti-Drainback Valve Fits: Nissan Engines, Trucks Replaces: Nissan FL208-05D01 Thread: 3/4 -16 O.D.: 3 23/32 (94.5) Height: 4 15/32 (113.5) I.Gskt: G401</p> 
<p>P7035 Lube Element Fits: Belarus Tractors Replaces: Belarus 2401017040A3 O.D.: 3 15/16 (100.0) I.D.: 1 19/32 (40.5) Height: 7 3/4 (196.9) End Seals: [2] Attached</p> 	<p>B7049 Lube Spin-on Contains: Anti-Drainback Valve Fits: Caterpillar, Komatsu, Mitsubishi Lift Trucks; Nissan Engines Replaces: Nissan 15208-01B01 Thread: 3/4 -16 O.D.: 3 (76.2) Height: 2 27/32 (72.2) I.Gskt: [1] Included</p> 
<p>B7039 Lube Spin-on Fits: Ford Light-Duty Trucks, Vans; International Trucks Replaces: Ford F4TZ-6731-A Thread: 1 1/2 -16 O.D.: 4 1/4 (108.0) Height: 7 3/8 (187.3) I.Gskt: [1] Included</p> 	<p>P7050 Lube Element Fits: Hitachi Excavators; Isuzu Trucks Replaces: Isuzu 9-88511-194-2 O.D.: 3 9/32 (83.3) I.D.: 5/8 (15.9) & 1 5/8 (41.3) Height: 5 25/32 (146.8) F. Gskt: [3] Included End Seals: [1] Attached Grommets: [1] Attached</p> 
<p>B7042 Lube Spin-on Contains: Anti-Drainback Valve 14 PSID By-Pass Valve Fits: Caterpillar Lift Trucks; Citroen Trucks; Peugeot Automotive, Light-Duty Trucks Replaces: Caterpillar 1N4402; Citroen 95638903; Peugeot 110987 Thread: M20 x 1.5 O.D.: 3 11/16 (93.7) Height: 5 3/8 (136.5) I.Gskt: G381-A</p> 	<p>B7051 Lube Spin-on Contains: Anti-Drainback Valve 30 PSID By-Pass Valve Standpipe Fits: Komatsu Equipment Replaces: Komatsu 6134-51-5120 Thread: 1 1/8 -16 O.D.: 4 1/4 (108.0) Height: 5 27/32 (148.4) I.Gskt: [1] Included</p> 
<p>B7044 Lube Spin-on Contains: Anti-Drainback Valve Replaces: Nissan 15209-Z6502 Thread: 1 -12 O.D.: 3 23/32 (94.5) Height: 6 23/32 (170.7) I.Gskt: G401</p> 	<p>P7052 Lube Element Contains: Reinforced Centertube Fits: Mercedes-Benz Buses, Trucks, Vans Replaces: Mercedes-Benz 3551800009 O.D.: 3 15/16 (100.0) I.D.: 1/2 (12.7) & 19/32 (15.1) Height: 9 5/8 (244.5) F. Gskt: [4] Included End Seals: [1] Attached Grommets: [1] Attached</p> 

Measurements Are Shown In Inches And (Millimeters)

WARNING: These products can expose you to chemicals, including Diisononyl Phthalate, Carbon black extracts, Nickel, 1,3 Butadiene, Ethylene Oxide, Epichlorohydrin, which are known to the State of California to cause cancer, and Bisphenol, Ethylene Glycol, Ethylene Oxide, 1,3 Butadiene, Epichlorohydrin, which are known to the State of California to cause birth defects or other reproductive harm. For more information go to www.P65Warnings.ca.gov.

P7053 Lube Element
Contains: Reinforced Centertube
Fits: Hino Engines, Tractors, Trucks
Replaces: Hino 15607-1560
O.D.: 3 15/16 (100.0)
I.D.: 19/32 (15.1) & 1 15/16 (49.2)
Height: 7 9/32 (184.9)
F. Gskt: [2] Included
O. Gskt: ES1074
End Seals: [1] Attached
Grommets: [1] Attached



P7084 Lube Element
Contains: Reinforced Centertube
Fits: Isuzu Trucks
Replaces: Isuzu 9-88513-264-1
O.D.: 4 1/4 (108.0)
I.D.: 9/16 (14.3) & 1 15/16 (49.2)
Height: 7 1/16 (179.4)
A. Gskt: [1] Attached
F. Gskt: [4] Included
End Seals: [1] Attached



P7058 Lube Element
Fits: Nissan Trucks
Replaces: Nissan 15274-99025, 15274-99285
O.D.: 4 11/32 (110.3)
I.D.: 5/8 (15.9) & 1 27/32 (46.8)
Height: 8 11/32 (211.9)
A. Gskt: [1] Attached



B7089 Lube Spin-on
Contains: 40 PSID By-Pass Valve
Fits: Ford, New Holland Equipment
Replaces: Ford F2NN-6714-AA, F2NN-6714-AB
Thread: 1 -12
O.D.: 3 11/16 (93.7)
Height: 6 5/8 (168.3)
I.Gskt: G381-A



P7059 Lube Element
Fits: Nissan Trucks
Replaces: Nissan 15274-99085, 15274-99087
O.D.: 5 1/32 (127.8)
I.D.: 5/8 (15.9) & 2 15/32 (62.7)
Height: 6 15/32 (164.3)
A. Gskt: [1] Attached
F. Gskt: [3] Copper Washers, [1] Included
Grommets: [1] Attached



B7091 Lube Spin-on
Contains: Anti-Drainback Valve
 18-20 PSID By-Pass Valve
Fits: Ford Tractors
Replaces: Ford SBA140516230
Thread: 3/4 -16
O.D.: 3 1/32 (77.0)
Height: 5 13/16 (147.6)
I.Gskt: [1] Included



P7081 Full-Flow Lube Element
Fits: Toyota Lift Trucks
Replaces: Toyota 4152-46010
O.D.: 3 5/8 (92.1)
I.D.: 23/32 (18.3)
Height: 5 15/32 (138.9)
F. Gskt: [4] Included, [1] Metal Washer



P7092 Full-Flow Lube Element
Notes: Included in P7000 KIT
Contains: Reinforced Centertube
Fits: Caterpillar, Furukawa Equipment;
 Mitsubishi Engines
Replaces: Mitsubishi 31240-53054
O.D.: 5 1/16 (128.6)
I.D.: 2 11/32 (59.5)
Height: 5 7/8 (149.2)
A. Gskt: [1] Attached
F. Gskt: [2] Included
End Seals: [1] Attached



B7082 Lube Spin-on
Contains: Anti-Drainback Valve
 8 PSID By-Pass Valve
Fits: Bobcat Loaders
Replaces: Melroe-Bobcat 6659329
Thread: M20 x 1.5
O.D.: 3 11/16 (93.7)
Height: 5 3/32 (129.4)
I.Gskt: [1] Included



P7093 By-Pass Lube Element
Notes: Included in P7000 KIT
Contains: Bleed Hole
Fits: Caterpillar Excavators; Mitsubishi
 Engines
Replaces: Caterpillar 94-8385; Mitsubishi
 ME054236, ME054238
O.D.: 5 1/16 (128.6)
I.D.: 19/32 (15.1)
Height: 6 23/32 (170.7)
F. Gskt: [2] Included
Grommets: [2] Attached















P7083 Lube Element
Fits: Nissan Lift Trucks
Replaces: Nissan 15208-76225
O.D.: 3 3/32 (78.6)
I.D.: 7/8 (22.2) & 1 5/8 (41.3)
Height: 5 7/16 (138.1)
F. Gskt: [3] Included
End Seals: [1] Attached



Measurements Are Shown In Inches And (Millimeters)

WARNING: These products can expose you to chemicals, including Diisononyl Phthalate, Carbon black extracts, Nickel, 1,3 Butadiene, Ethylene Oxide, Epichlorohydrin, which are known to the State of California to cause cancer, and Bisphenol, Ethylene Glycol, Ethylene Oxide, 1,3 Butadiene, Epichlorohydrin, which are known to the State of California to cause birth defects or other reproductive harm. For more information go to www.P65Warnings.ca.gov.

<p>BD7095 Dual-Flow Lube Spin-on Contains: Anti-Drainback Valve Fits: Thermo King Refrigeration Units Replaces: Thermo King 11-7382 Thread: M26 x 1.5 O.D.: 3 11/16 (93.7) Height: 7 1/8 (181.0) I.Gskt: G381-A</p> 	<p>BD7105 Dual-Flow Lube Spin-on with Drain Contains: Standpipe Fits: Hino, Nissan Trucks; Hitachi, Kobelco Equipment Replaces: Hino 15607-1600; Hitachi 4285963 Thread: 1 1/2 -16 O.D.: 4 7/16 (112.7) Height: 8 11/32 (211.9) I.Gskt: [1] Included</p> 
<p>B7097 Dual-Flow Lube Spin-on Contains: 10-15 PSID By-Pass Valve Fits: Ford Cargo Trucks Replaces: Ford 826F-6714-AA2A Thread: M60 x 3.0 O.D.: 5 15/32 (138.9) Height: 6 3/4 (171.5) I.Gskt: [1] Included</p> 	<p>P7106 Lube Element Contains: Reinforced Centertube Fits: Hino Trucks Replaces: Hino 15607-1320 O.D.: 4 5/32 (105.6) I.D.: 19/32 (15.1) & 1 7/8 (47.6) Height: 6 3/4 (171.5) A. Gskt: [1] Attached F. Gskt: [4] Included</p> 
<p>B7099 Lube Spin-on Contains: 30 PSID By-Pass Valve Fits: Fendt, International, Kubota Equipment Replaces: Fendt F139215310010; International 3132023-R92 Thread: 3/4 -16 O.D.: 3 11/16 (93.7) Height: 4 7/16 (112.7) I.Gskt: G401</p> 	<p>P7107 Lube Element Contains: Reinforced Centertube Fits: Kobelco Loaders; Nissan Trucks Replaces: Kobelco 2451R131-1F; Nissan 15274-90225 O.D.: 3 15/16 (100.0) I.D.: 5/8 (15.9) & 1 23/32 (43.7) Height: 7 9/16 (192.1) A. Gskt: [1] Attached F. Gskt: [3] Included</p> 
<p>P7102 By-Pass Lube Element with Handle Fits: Hitachi Excavators Replaces: Hitachi 4231195 Thread: M16 x 2.0 O.D.: 6 1/2 (165.1) Height: 5 3/32 (129.4) F. Gskt: [1] Included, [2] Metal Washers</p> 	<p>B7113 Full-Flow Lube Spin-on Contains: Anti-Drainback Valve 30 PSID By-Pass Valve Fits: Pegaso Buses, Trucks Replaces: Pegaso 649092 Thread: 1 1/8 -16 O.D.: 4 1/4 (108.0) Height: 7 11/32 (186.5) I.Gskt: [1] Included</p> 
<p>P7103 Fuel Element Fits: Mitsubishi Equipment, Trucks; Nissan Trucks; Yanmar Engines Replaces: Mitsubishi ME023833, ME023838; Nissan 16444-Z9000 O.D.: 2 7/8 (73.0) I.D.: 15/32 (11.9) Height: 3 9/16 (90.5) F. Gskt: [1] Included O-Ring: [1] Included Grommets: [2] Attached</p> 	<p>P7114 Lube Element Fits: BMW Automotive Replaces: BMW 11421267268, 11429063138 O.D.: 3 3/16 (81.0) I.D.: 1 3/32 (27.8) Height: 5 3/32 (129.4) A. Gskt: [2] Attached F. Gskt: [4] Included</p> 
<p>P7104 Lube Element Fits: Nissan Trucks Replaces: Nissan 15274-99428 O.D.: 3 25/32 (96.0) I.D.: 19/32 (15.1) & 1 23/32 (43.7) Height: 6 1/16 (154.0) A. Gskt: [1] Attached F. Gskt: [4] Included</p> 	<p>B7116 Lube Spin-on Contains: 30 PSID By-Pass Valve Fits: M.A.N. Trucks Replaces: M.A.N. 51.05501.7160, 51.05501.7161, 51.05501.7165 Thread: M30 x 2.0 O.D.: 4 1/4 (108.0) Height: 7 13/32 (188.1) I.Gskt: [1] Included</p> 

Measurements Are Shown In Inches And (Millimeters)
WARNING: These products can expose you to chemicals, including Diisononyl Phthalate, Carbon black extracts, Nickel, 1,3 Butadiene, Ethylene Oxide, Epichlorohydrin, which are known to the State of California to cause cancer, and Bisphenol, Ethylene Glycol, Ethylene Oxide, 1,3 Butadiene, Epichlorohydrin, which are known to the State of California to cause birth defects or other reproductive harm. For more information go to www.P65Warnings.ca.gov.

B7117 Lube Spin-on
Replaces: Mann & Hummel W940/34
Thread: 1 -16
O.D.: 3 11/16 (93.7)
Height: 5 3/8 (136.5)
I.Gskt: G381-A



P7127 Lube Element
Fits: Hino Equipment, Trucks
Replaces: Hino 15607-1010, 15607-1010A, 15607-1011
O.D.: 4 27/32 (123.0)
I.D.: 21/32 (16.7)
Height: 8 7/8 (225.4)
F. Gskt: [5] Included



B7119 Full-Flow Lube Spin-on
Contains: Anti-Drainback Valve
 16 PSID By-Pass Valve
Fits: Allis Chalmers, Massey Ferguson Tractors
Replaces: Allis Chalmers 2100723; Massey Ferguson 3283341-M1
Thread: 3/4 -16
O.D.: 3 1/4 (82.6)
Height: 3 5/32 (80.2)
I.Gskt: [1] Included



B7128 Lube Spin-on
Contains: Anti-Drainback Valve
 50 PSID By-Pass Valve
Fits: Fendt, Renault Tractors; Sullair Compressors
Replaces: Mann & Hummel W930
Thread: 3/4 -16
O.D.: 3 11/16 (93.7)
Height: 4 7/16 (112.7)
I.Gskt: G401



B7121 Dual-Flow Lube Spin-on
Contains: 14-16 PSID By-Pass Valve
Fits: Kobelco Equipment; Mitsubishi Trucks
Replaces: Kobelco 2446R-332D11; 2451U-3431
Thread: M26 x 1.5
O.D.: 4 1/4 (108.0)
Height: 7 11/32 (186.5)
I.Gskt: [1] Included



V7129-C Cotton/Sisal Lube Sock
Replaces: Nelson 82620D; Winslow CP3245-T0
O.D.: 4 3/8 (111.1)
I.D.: 1 5/32 (29.4)
Height: 31 1/4 (793.8)



B7124 By-Pass Lube Spin-on
Fits: GMC, Hino, Isuzu Trucks
Replaces: GMC 94054123; Hino 15607-1860; Isuzu 1-13240-089-0
Thread: 5/8 -18
O.D.: 4 1/4 (108.0)
Height: 5 7/8 (149.2)
I.Gskt: G401



B7130 Lube Spin-on
Contains: 14 PSID By-Pass Valve
Fits: Gehl, TCM Loaders
Replaces: Gehl 127389; TCM 20801-01261
Thread: 1 -12
O.D.: 4 1/4 (108.0)
Height: 5 13/16 (147.6)
I.Gskt: [1] Included



B7125 Full-Flow Lube Spin-on
Contains: 20 PSID By-Pass Valve
Fits: Ditch Witch, John Deere, Lincoln Equipment; Atlas Copco, Ingersoll-Rand Compressors
Replaces: Ingersoll-Rand 36881696; John Deere RE59754
Thread: 1 1/2 -16
O.D.: 3 11/16 (93.7)
Height: 5 3/4 (146.0)
I.Gskt: [1] Included



B7131 Lube Spin-on
Contains: Anti-Drainback Valve
 30 PSID By-Pass Valve
Fits: Caterpillar Lift Trucks; Mitsubishi Engines
Replaces: Caterpillar 103-9737; Wako 32A4000100
Thread: 1 -12
O.D.: 4 1/4 (108.0)
Height: 4 1/32 (102.4)
I.Gskt: [1] Included



P7126 Lube Element with Handle
Contains: Reinforced Centertube
Fits: Hitachi Equipment
Replaces: Hitachi 4225367
Thread: M16 x 2.0
O.D.: 6 1/2 (165.1)
Height: 11 15/16 (303.2)
F. Gskt: [3] Included



P7132 Lube Element
Contains: 60 PSID By-Pass Valve
Fits: Honda ATVs, Motorcycles
Replaces: Honda 15410-KF0-315, 15412-KF0-000
O.D.: 1 31/32 (50.0)
I.D.: 15/32 (11.9) One End
Height: 1 7/16 (36.5)
A. Gskt: [1] Attached
F. Gskt: [1] Included



P7134 Power Steering Element
Notes: Inside-Out Flow Direction
Fits: International Buses, Trucks
Replaces: International 1653998-C91
O.D.: 2 15/32 (62.7)
I.D.: 1 3/32 (27.8)
Height: 3 9/16 (90.5)
F. Gskt: [8] Included



Measurements Are Shown In Inches And (Millimeters)

WARNING: These products can expose you to chemicals, including Diisononyl Phthalate, Carbon black extracts, Nickel, 1,3 Butadiene, Ethylene Oxide, Epichlorohydrin, which are known to the State of California to cause cancer, and Bisphenol, Ethylene Glycol, Ethylene Oxide, 1,3 Butadiene, Epichlorohydrin, which are known to the State of California to cause birth defects or other reproductive harm. For more information go to www.P65Warnings.ca.gov.

B7135 Full-Flow Lube Spin-on
Fits: Detroit Diesel Engines
Replaces: GMC 23550401
Thread: M45 x 1.5
O.D.: 5 3/8 (136.5)
Height: 12 3/32 (307.2)
I.Gskt: [1] Included



B7142 Full-Flow Lube Spin-on
Contains: 20 PSID By-Pass Valve
Replaces: Hyster 1313454; Perkins CV2473
Thread: M30 x 1.5
O.D.: 4 1/4 (108.0)
Height: 7 9/16 (192.1)
I.Gskt: [1] Included



P7136 Lube Element
Fits: Audi, Volkswagen Automotive
Replaces: GMC 25313731; Volkswagen 21115561B, 21115562A
O.D.: 3 1/4 (82.6)
I.D.: 15/16 (23.8) & 1 9/16 (39.7)
Height: 4 11/32 (110.3)
A. Gskt: [2] Attached
O-Ring: [1] Included



B7143 Full-Flow Lube Spin-on
Contains: 50 PSID By-Pass Valve
Fits: Atlas Copco, Kaeser Compressors
Replaces: Kaeser 6-1981, 6-1981-0, 6-1981-0/A1
Thread: 1 -12
O.D.: 3 11/16 (93.7)
Height: 8 1/8 (206.4)
I.Gskt: G381-A



P7137 Lube Element
Fits: BMW Automotive
Replaces: BMW 11421745390, 11421745391
O.D.: 3 1/4 (82.6)
I.D.: 1 1/32 (26.2) & 1 9/16 (39.7)
Height: 6 3/8 (161.9)
A. Gskt: [1] Attached
F. Gskt: [1] Metal Washer
O-Ring: [1] Included



B7144 Lube Spin-on
Contains: Anti-Drainback Valve
 14 PSID By-Pass Valve
Fits: Case, Hitachi, Kobelco, Link-Belt, Massey Ferguson, Mitsubishi Equipment; Isuzu Engines
Replaces: Hitachi 4183853; Isuzu 8-94321-219-1; Kobelco 2451U309-1; Link-Belt KNH0324
Thread: 1 -12
O.D.: 4 1/4 (108.0)
Height: 5 27/32 (148.4)
I.Gskt: [1] Included



P7138 Lube Element
Fits: BMW Automotive
Replaces: BMW 11421427908, 11421740534
O.D.: 3 1/4 (82.6)
I.D.: 1 9/16 (39.7)
Height: 4 1/8 (104.8)
A. Gskt: [2] Attached
F. Gskt: [1] Metal Washer
O-Ring: [1] Included



P7145 Lube Element
Fits: Deutz Engines; Deutz Tractors; M.A.N. Engines, Trucks
Replaces: M.A.N. 51.055040.096; Renault 5001846993
O.D.: 3 9/32 (83.3)
I.D.: 1 5/8 (41.3) One End
Height: 8 13/32 (213.5)
A. Gskt: [1] Attached
O-Ring: [1] Included



B7139 Full-Flow Lube Spin-on
Contains: Anti-Drainback Valve
 30 PSID By-Pass Valve
Fits: Carrier-Transicold Refrigeration Units; Massey Ferguson Tractors
Replaces: Agco 72118856, 74920158; Carrier 941172, 25-34602-00; Massey Ferguson 3281019-M1, 3435171-M1
Thread: 3/4 -16
O.D.: 3 1/32 (77.0)
Height: 4 3/32 (104.0)
I.Gskt: [1] Included



B7151 Lube Spin-on
Contains: 40 PSID By-Pass Valve
Fits: DAF Trucks
Replaces: DAF 1306549
Thread: 1 -12
O.D.: 4 1/4 (108.0)
Height: 9 1/8 (231.8)
I.Gskt: G401



BD7141 Dual-Flow Lube Spin-on
Replaces: Isuzu 8-94396-375-4
Thread: 1 1/2 -12
O.D.: 4 21/32 (118.3)
Height: 8 3/32 (205.6)
I.Gskt: [1] Included



B7152 Lube Spin-on
Contains: Anti-Drainback Valve
 20 PSID By-Pass Valve
Fits: Case, Hitachi, Kubota Equipment
Replaces: Kubota 17321-32430
Thread: 3/4 -16
O.D.: 3 11/16 (93.7)
Height: 3 1/4 (82.6)
I.Gskt: G381-A



Measurements Are Shown In Inches And (Millimeters)

WARNING: These products can expose you to chemicals, including Diisononyl Phthalate, Carbon black extracts, Nickel, 1,3 Butadiene, Ethylene Oxide, Epichlorohydrin, which are known to the State of California to cause cancer, and Bisphenol, Ethylene Glycol, Ethylene Oxide, 1,3 Butadiene, Epichlorohydrin, which are known to the State of California to cause birth defects or other reproductive harm. For more information go to www.P65Warnings.ca.gov.

BD7153 High Velocity Dual-Flow Lube Spin-on
Contains: Venturi-Type Cone
Fits: Cummins Engines
Replaces: Cummins 3406810, 340681000; Fleetguard LF9070
Thread: M95 x 2.5
O.D.: 4 21/32 (118.3)
Height: 14 7/32 (361.2)
I.Gskt: [1] Included
Related To: BD7154 (Short Version)



BD7159 Dual-Flow Lube Spin-on
Contains: 40 PSID By-Pass Valve
Fits: Isuzu Engines, Trucks
Replaces: Isuzu 8-94338-181-0, 8-94338-181-1, 8-97096-777-0
Thread: 1 1/2 -12
O.D.: 4 21/32 (118.3)
Height: 4 15/16 (125.4)
I.Gskt: [1] Included



BD7154 High Velocity Dual-Flow Lube Spin-on
Contains: Venturi-Type Cone
Fits: Cummins Engines
Replaces: Cummins 3406809; Fleetguard LF9001
Thread: M95 x 2.5
O.D.: 4 21/32 (118.3)
Height: 11 25/32 (299.2)
I.Gskt: [1] Included
Related To: BD7153 (Long Version) BD7509 (Vamac Gasket) BD50000 (High Efficiency Version)



BD7160 Dual-Flow Lube Spin-on
Contains: 11-17 PSID By-Pass Valve
Replaces: GMC 94360427; Isuzu 8-94360-427-1, 8-97021-576-0; Mazda RFT1-1A-302, RYF0-14-302; Mitsubishi MD336080; Nissan 15208-HC200, 15208-89TA0
Thread: M26 x 1.5
O.D.: 3 17/32 (89.7)
Height: 4 15/16 (125.4)
I.Gskt: [1] Included
O-Ring: [3] Included



B7155 Lube Spin-on
Fits: Hino Trucks
Replaces: Hino 15607-2050
Thread: 1 1/2 -16
O.D.: 4 21/32 (118.3)
Height: 8 1/8 (206.4)
I.Gskt: [1] Included



B7161 Lube Spin-on
Contains: 35 PSID By-Pass Valve
 Hex nut for removal
Fits: DAF Trucks
Replaces: DAF 1331057, 1345332
Thread: M42 x 2.0
O.D.: 5 3/8 (136.5)
Height: 8 7/8 (225.4)
I.Gskt: [1] Included



B7156 Lube Spin-on
Contains: Anti-Drainback Valve
 40 PSID By-Pass Valve
Fits: Hatz Diesel Engines; Renault Tractors
Replaces: Hatz 40065300
Thread: 3/4 -16
O.D.: 3 11/16 (93.7)
Height: 5 3/8 (136.5)
I.Gskt: G381-A



B7162 Lube Spin-on
Contains: 35 PSID By-Pass Valve
 Hex nut for removal
Fits: DAF Engines, Trucks
Replaces: DAF 1310901
Thread: M42 x 2.0
O.D.: 5 3/8 (136.5)
Height: 12 3/8 (314.3)
I.Gskt: [1] Included



B7157 Lube Spin-on
Contains: Anti-Drainback Valve
 35 PSID By-Pass Valve
Fits: MWM Engines
Replaces: MWM 605412970039
Thread: 1 1/2 -16
O.D.: 5 3/8 (136.5)
Height: 12 3/32 (307.2)
I.Gskt: [1] Included



B7163 Lube Spin-on
Contains: 35 PSID By-Pass Valve
Replaces: Atlas Copco 1202-8040-00
Thread: M20 x 1.5
O.D.: 3 23/32 (94.5)
Height: 8 3/32 (205.6)
I.Gskt: [1] Included



BD7158 Dual-Flow Lube Spin-on
Contains: Integral Post Seal
 25-31 PSID By-Pass Valve
Fits: Caterpillar Excavators, Industrial Engines
Replaces: Caterpillar 517950, 517950X
Thread: M32 x 1.5
O.D.: 4 1/4 (108.0)
Height: 8 25/32 (223.0)
I.Gskt: [1] Included



B7164 By-Pass Lube Spin-on
Fits: Hitachi, Kobelco Excavators; Isuzu Engines
Replaces: Hitachi 4285642; Isuzu 8-97026-134-2
Thread: M20 x 1.5
O.D.: 4 1/4 (108.0)
Height: 7 5/8 (193.7)
I.Gskt: [1] Included



Measurements Are Shown In Inches And (Millimeters)

WARNING: These products can expose you to chemicals, including Diisononyl Phthalate, Carbon black extracts, Nickel, 1,3 Butadiene, Ethylene Oxide, Epichlorohydrin, which are known to the State of California to cause cancer, and Bisphenol, Ethylene Glycol, Ethylene Oxide, 1,3 Butadiene, Epichlorohydrin, which are known to the State of California to cause birth defects or other reproductive harm. For more information go to www.P65Warnings.ca.gov.

B7165 Lube Spin-on
Contains: Anti-Drainback Valve
 8 PSID Front End By-Pass Valve
Fits: Ariens, Bush Hog, Cub Cadet, Gravely, Husqvarna, John Deere, Snapper, White Lawn & Garden Tractors; Briggs & Stratton Engines
Replaces: Briggs & Stratton 492932
Thread: 3/4 -16
O.D.: 3 1/32 (77.0)
Height: 2 5/16 (58.7)
I.Gskt: G449-B



B7171 Lube Spin-on
Contains: Anti-Drainback Valve
 Front End Check Valve
 35 PSID By-Pass Valve
Fits: Liebherr Equipment
Replaces: Liebherr 7381111, 738111123
Thread: M30 x 2.0
O.D.: 4 1/4 (108.0)
Height: 9 1/8 (231.8)
I.Gskt: [1] Included



BD7166 Dual-Flow Lube Spin-on
Contains: 15 PSID By-Pass Valve
Fits: GMC Trucks; Isuzu Engines
Replaces: GMC 97719921; Isuzu 2-90654-600-0, 8-97049-282-0
Thread: 1 1/2 -12
O.D.: 4 21/32 (118.3)
Height: 8 1/16 (204.8)
I.Gskt: [1] Included



B7172 Lube Spin-on
Contains: Anti-Drainback Valve
 20 PSID By-Pass Valve
Fits: Perkins Engines
Replaces: Perkins 140516990
Thread: 3/4 -16
O.D.: 3 1/32 (77.0)
Height: 4 3/32 (104.0)
I.Gskt: [1] Included



B7167 Lube Spin-on
Contains: Anti-Drainback Valve
 20 PSID By-Pass Valve
Fits: Bobcat Loaders; Citroen, Peugeot Trucks; Suzuki Automotive
Replaces: Melroe-Bobcat 6661011
Thread: M20 x 1.5
O.D.: 3 1/32 (77.0)
Height: 3 1/2 (88.9)
I.Gskt: G449-B



BC7173 Centrifugal By-Pass Lube Element
Fits: Mack, R.V.I. Engines
Replaces: Mack 57GC2187, 236GB245M
O.D.: 3 27/32 (97.6)
I.D.: 3/8 (9.5) & 1/2 (12.7)
Height: 4 1/2 (114.3)
F. Gskt: [1] Included



BD7168 Dual-Flow Lube Spin-on
Contains: Anti-Drainback Valve
 23 PSID By-Pass Valve
Fits: Iveco Trucks
Replaces: Iveco 1905704, 1907571
Thread: M30 x 2.0
O.D.: 4 5/16 (109.5)
Height: 10 3/8 (263.5)
I.Gskt: [1] Included
F. Gskt: [1] Included



B7174-MPG Maximum Performance Glass Lube Spin-on
Fits: Case Dump Trucks; Case-IH Harvesters, Tractors; Iveco Engines, Trucks; New Holland Combines, Forage Harvesters, Tractors; Winpower Generators
Replaces: Iveco 99445200
Thread: M30 x 2.0
O.D.: 4 1/4 (108.0)
Height: 9 1/8 (231.8)
I.Gskt: [1] Included



BD7169 Dual-Flow Lube Spin-on
Contains: 19 PSID By-Pass Valve
Fits: GMC, Isuzu Buses, Trucks
Replaces: GMC 97148270; Isuzu 2-90654-800-0, 8-97148-270-0
Thread: 1 1/2 -12
O.D.: 4 21/32 (118.3)
Height: 4 15/16 (125.4)
I.Gskt: [1] Included



B7175 Lube Spin-on
Fits: Detroit Diesel Engines
Replaces: Detroit Diesel 23540000
Thread: M45 x 1.5
O.D.: 5 3/8 (136.5)
Height: 12 3/32 (307.2)
I.Gskt: [1] Included



B7170 Lube Spin-on
Contains: Anti-Drainback Valve
 2 PSID Front-End Check Valve
 50 PSID By-Pass Valve
Fits: John Deere, Liebherr Equipment
Replaces: Liebherr 5700043, 570004323
Thread: 1 -12
O.D.: 3 11/16 (93.7)
Height: 8 1/8 (206.4)
I.Gskt: G381-A









BD7176 High Velocity Dual-Flow Lube Spin-on
Contains: Venturi-Type Cone
Fits: Cummins Engines
Replaces: Cummins 4016657; Fleetguard LF9050
Thread: M90 x 2.0
O.D.: 4 23/32 (119.9)
Height: 11 5/8 (295.3)
I.Gskt: [1] Included













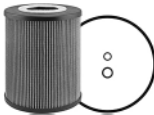

Measurements Are Shown In Inches And (Millimeters)

WARNING: These products can expose you to chemicals, including Diisononyl Phthalate, Carbon black extracts, Nickel, 1,3 Butadiene, Ethylene Oxide, Epichlorohydrin, which are known to the State of California to cause cancer, and Bisphenol, Ethylene Glycol, Ethylene Oxide, 1,3 Butadiene, Epichlorohydrin, which are known to the State of California to cause birth defects or other reproductive harm. For more information go to www.P65Warnings.ca.gov.

<p>B7177 Lube Spin-on Fits: Equipment, Motor Homes and Trucks with Cummins ISB 5.9L, QSB 5.9L Engines Replaces: Cummins 3937144 Thread: 1 1/8 -16 O.D.: 3 11/16 (93.7) Height: 7 3/16 (182.6) I.Gskt: G401</p> 	<p>B7182 Lube Spin-on Contains: 35 PSID By-Pass Valve Fits: DAF Trucks Replaces: DAF 1316123, 1346986, 267715 Thread: 1 1/2 -16 O.D.: 5 3/8 (136.5) Height: 8 7/8 (225.4) I.Gskt: [1] Included Related To: B7187 (Long Version)</p> 
<p>P7178 Power Steering Element Notes: Inside-Out Flow Direction Contains: 14 PSID By-Pass Valve Fits: International Trucks Replaces: International 1696766-C1 O.D.: 2 3/4 (69.9) I.D.: 7/16 (11.1) One End Height: 3 (76.2) Grommets: [1] Attached</p> 	<p>P7183 Lube Element Fits: Railroad Applications Replaces: Clark C52; GE 2X4223, 41C615890 O.D.: 6 13/32 (162.7) I.D.: 1 15/32 (37.3) One End Height: 30 3/32 (764.4) I.Gskt: [1] Included A. Gskt: [1] Attached</p> 
<p>B7179 Lube Spin-on Contains: Anti-Drainback Valve 20 PSID By-Pass Valve Fits: Agco, Case, Massey Ferguson, Valtra, Valmet Equipment Replaces: Agco 836647133 Thread: M24 x 1.5 O.D.: 4 1/4 (108.0) Height: 5 27/32 (148.4) I.Gskt: G401</p> 	<p>P7185 By-Pass Lube Element Fits: Hino Trucks Replaces: Hino 15607-1210, 15607-1340, 15607-2160; Donaldson P502191; Fleetguard LF3709 O.D.: 4 25/32 (121.4) I.D.: 29/32 (23.0) Height: 9 3/4 (247.7) F. Gskt: [2] Included O-Ring: [2] Included Grommets: [1] Included</p> 
<p>B7180 Lube Spin-on Notes: For Vertical Installation Only. Contains: 35 PSID By-Pass Valve Fits: Atlas Copco Mining Trucks; Coleman Generators; Detroit Diesel Engines; Hitachi, Terex, Unit Rig Dump Trucks; LeTourneau Loaders; MTU Diesel Engines Replaces: Detroit Diesel 23526919 Thread: 1 1/2 -16 O.D.: 5 3/8 (136.5) Height: 12 3/32 (307.2) I.Gskt: [1] Included</p> 	<p>BC7186 KIT Paper Insert Notes: Paper insert for Spinner II Models 36/60/66/76/96 Fits: Peterbilt Trucks Replaces: Spinner II 70669, 71429 Length: 15 5/32 (385.0) Width: 2 1/2 (63.5) O-Ring: [2] Included</p> 
<p>B7181 Lube Spin-on Contains: Anti-Drainback Valve Fits: Daewoo, Komatsu Equipment Replaces: Daewoo 65055105015 Thread: 1 -16 O.D.: 3 11/16 (93.7) Height: 7 1/8 (181.0) I.Gskt: G381-A</p> 	<p>B7187 Lube Spin-on Contains: 35 PSID By-Pass Valve Fits: DAF Trucks Replaces: DAF 267714 Thread: 1 1/2 -16 O.D.: 5 3/8 (136.5) Height: 12 3/8 (314.3) I.Gskt: [1] Included Related To: B7182 (Short Version)</p> 

Measurements Are Shown In Inches And (Millimeters)

WARNING: These products can expose you to chemicals, including Diisononyl Phthalate, Carbon black extracts, Nickel, 1,3 Butadiene, Ethylene Oxide, Epichlorohydrin, which are known to the State of California to cause cancer, and Bisphenol, Ethylene Glycol, Ethylene Oxide, 1,3 Butadiene, Epichlorohydrin, which are known to the State of California to cause birth defects or other reproductive harm. For more information go to www.P65Warnings.ca.gov.

<p>P7188</p>  <p>Lube Element Fits: Equipment, Trucks with Deutz, Mercedes-Benz Engines; Fendt Tractors Replaces: Deutz 2931095, 4252248; Mercedes-Benz 1801709, 9061800009, A0001801709 O.D.: 3 9/32 (83.3) I.D.: 3/8 (9.5) & 1 9/16 (39.7) Height: 8 3/8 (212.7) O-Ring: [1] Included End Seals: [1] Attached</p>	<p>BC7194</p>  <p>Centrifugal By-Pass Lube Element Fits: DAF Trucks Replaces: DAF 1310891, 1376481 O.D.: 3 27/32 (97.6) I.D.: 9/16 (14.3) Height: 4 1/2 (114.3) F. Gskt: [1] Included O-Ring: [1] Included</p>
<p>B7189</p>  <p>Lube Spin-on Contains: Anti-Drainback Valve 20 PSID By-Pass Valve Fits: MDI/Yutani Equipment; Mitsubishi Engines, Trucks Replaces: Mitsubishi ME014833 Thread: M20 x 1.5 O.D.: 4 1/4 (108.0) Height: 4 3/4 (120.7) I.Gskt: [1] Included</p>	<p>P7195</p>  <p>Lube Element Fits: Komatsu Dump Trucks, Engines Replaces: Komatsu 6128-51-5030 O.D.: 6 5/16 (160.3) I.D.: 7/8 (22.2) Height: 15 (381.0) O-Ring: [2] Included</p>
<p>P7190</p>  <p>Lube Element Fits: M.A.N. Engines, Trucks Replaces: M.A.N. 51.055040.098 O.D.: 4 3/4 (120.7) I.D.: 2 7/32 (56.4) Height: 5 27/32 (148.4) A. Gskt: [2] Attached O-Ring: [3] Included</p>	<p>P7196</p>  <p>Lube Element Fits: Fendt Tractors; M.A.N. Trucks; Mercedes-Benz Automotive, Engines Replaces: Mercedes-Benz 6021800009, 8021840025; Renault 6005019830 O.D.: 3 1/4 (82.6) I.D.: 1 7/16 (36.5) Height: 6 31/32 (177.0) O-Ring: [3] Included Grommets: [2] Attached</p>
<p>B7191</p>  <p>Lube Spin-on Contains: Anti-Drainback Valve 30 PSID By-Pass Valve Standpipe Replaces: Waukesha 304126 Thread: 1 1/8 -16 O.D.: 4 1/4 (108.0) Height: 10 7/16 (265.1) I.Gskt: [1] Included</p>	<p>B7197</p>  <p>Lube Spin-on Contains: Anti-Drainback Valve 14 PSID By-Pass Valve Fits: Ingersoll-Rand Compressors, Engines Replaces: Ingersoll-Rand 54381314; Fleetguard LF3983 Thread: M20 x 1.5 O.D.: 3 11/16 (93.7) Height: 3 27/32 (97.6) I.Gskt: [1] Included</p>
<p>P7192</p>  <p>Lube Element Fits: Demag, Grove Equipment; Mercedes-Benz Engines, Trucks, Vans Replaces: Mercedes-Benz 5411800009, 5411240225; Renault 5001846632 O.D.: 4 21/32 (118.3) I.D.: 2 1/8 (54.0) One End Height: 12 1/4 (311.2) O-Ring: [2] Included</p>	<p>P7199</p>  <p>Lube Element Fits: Buses, Trucks with Mercedes-Benz Engines Replaces: Mercedes-Benz 1801609, A0001801609; Fleetguard LF3827 O.D.: 3 9/32 (83.3) I.D.: 3/8 (9.5) & 1 9/16 (39.7) Height: 5 15/16 (150.8) A. Gskt: [1] Attached O-Ring: [1] Included</p>
<p>P7193</p>  <p>Lube Element Notes: Uses 4 filters per application. Fits: Superior Compressors with Natural Gas Engines Replaces: Superior 870078A O.D.: 6 1/32 (153.2) I.D.: 5/8 (15.9) & 2 (50.8) Height: 11 13/32 (289.7) A. Gskt: [1] Attached F. Gskt: [1] Included Grommets: [1] Attached</p>	<p>B7215</p>  <p>Lube Spin-on Contains: 20 PSID By-Pass Valve Fits: Case-International, New Holland Equipment Replaces: New Holland 86605897 Thread: 1 -12 O.D.: 3 11/16 (93.7) Height: 6 5/8 (168.3) I.Gskt: G381-A</p>

Measurements Are Shown In Inches And (Millimeters)

WARNING: These products can expose you to chemicals, including Diisononyl Phthalate, Carbon black extracts, Nickel, 1,3 Butadiene, Ethylene Oxide, Epichlorohydrin, which are known to the State of California to cause cancer, and Bisphenol, Ethylene Glycol, Ethylene Oxide, 1,3 Butadiene, Epichlorohydrin, which are known to the State of California to cause birth defects or other reproductive harm. For more information go to www.P65Warnings.ca.gov.

B7216

Lube Spin-on



Contains: Anti-Drainback Valve
30 PSID By-Pass Valve
Fits: John Deere Mowers, Tractors all with Yanmar Engines
Replaces: John Deere M806419
Thread: M20 x 1.5
O.D.: 3 (76.2)
Height: 2 27/32 (72.2)
I.Gskt: [1] Included

B7223

Lube Spin-on



Contains: 30 PSID By-Pass Valve
Fits: Komatsu Equipment
Replaces: Komatsu 6136-51-5120, 6136-51-5121
Thread: 1 1/8 -16
O.D.: 4 1/4 (108.0)
Height: 5 27/32 (148.4)
I.Gskt: [1] Included

B7217

Lube Spin-on



Contains: 20 PSID By-Pass Valve
Fits: Hitachi, John Deere, Link-Belt Excavators
Replaces: Hitachi 4448336
Thread: 1 1/2 -12
O.D.: 4 21/32 (118.3)
Height: 8 3/32 (205.6)
I.Gskt: [1] Included

B7224

Lube Spin-on



Contains: 35 PSID By-Pass Valve
Fits: DAF Trucks
Replaces: DAF 1327672
Thread: M42 x 2.0
O.D.: 5 3/8 (136.5)
Height: 12 3/8 (314.3)
I.Gskt: [1] Included

B7219

Lube Spin-on



Contains: Anti-Drainback Valve
30 PSID By-Pass Valve
2 PSID Front-End Check Valve
Fits: New Holland Tractors
Replaces: New Holland 1931018
Thread: 3/4 -16
O.D.: 4 1/4 (108.0)
Height: 4 3/8 (111.1)
A. Gskt: G381-A

B7225

Full-Flow Lube Spin-on



Notes: Uses 2 filters per application.
Fits: Mack Trucks
Replaces: Mack 485GB3232, 485GB3236
Thread: 1 1/8 -16
O.D.: 4 1/4 (108.0)
Height: 10 7/16 (265.1)
I.Gskt: [1] Included
Related To: B76 (Media Difference)

B7220

Lube Spin-on



Contains: Anti-Drainback Valve
30 PSID By-Pass Valve
Fits: Komatsu Equipment
Replaces: Komatsu 600-211-6240, 600-211-6242
Thread: 1 -12
O.D.: 3 11/16 (93.7)
Height: 3 1/4 (82.6)
I.Gskt: G381-A

B7227

Lube Spin-on



Fits: R.V.I. Trucks
Replaces: Renault 5010240400, 5010295195, 5010295196
Thread: 1 1/8 -16
O.D.: 4 1/4 (108.0)
Height: 7 3/8 (187.3)
I.Gskt: [1] Included

B7221

Lube Spin-on



Contains: Anti-Drainback Valve
8 PSID Front-End By-Pass Valve
Fits: Equipment Using Lister-Petter LPA3A Engine
Replaces: Lister 751-10620
Thread: 3/4 -16
O.D.: 3 11/16 (93.7)
Height: 2 9/16 (65.1)
I.Gskt: G381-A

BC7228

Centrifugal By-Pass Lube Element



Fits: Mack Engines
Replaces: Mack 57GC2206, 236GB41M
O.D.: 3 27/32 (97.6)
I.D.: 1/2 (12.7) & 5/8 (15.9)
Height: 7 (177.8)
F. Gskt: [1] Included

B7222

Lube Spin-on



Contains: Anti-Drainback Valve
20 PSID By-Pass Valve
Fits: Lincoln Ranger 8 Welder with Ruggerini Diesel Engine; Lister-Petter Industrial, Marine Engines
Replaces: Ruggerini 17524; Fleetguard LF3826
Thread: 3/4 -16
O.D.: 3 1/16 (77.8)
Height: 2 11/32 (59.5)
I.Gskt: G449-B

B7229

Lube Spin-on



Contains: By-Pass Screen
35 PSID By-Pass Valve
Fits: Detroit Diesel 4000 Series Engines
Replaces: Detroit Diesel 5241840301; Euclid E12980181; Donaldson P550512
Thread: M36 x 1.5
O.D.: 5 3/8 (136.5)
Height: 12 3/32 (307.2)
I.Gskt: [1] Included

Measurements Are Shown In Inches And (Millimeters)

WARNING: These products can expose you to chemicals, including Diisononyl Phthalate, Carbon black extracts, Nickel, 1,3 Butadiene, Ethylene Oxide, Epichlorohydrin, which are known to the State of California to cause cancer, and Bisphenol, Ethylene Glycol, Ethylene Oxide, 1,3 Butadiene, Epichlorohydrin, which are known to the State of California to cause birth defects or other reproductive harm. For more information go to www.P65Warnings.ca.gov.

P7230 Lube Element
Fits: Freightliner, Sterling, Western Star Trucks; Mercedes-Benz Engines
Replaces: Mercedes-Benz 1802109, 4571840125, A0001802109, A4571840125
O.D.: 4 3/4 (120.7)
I.D.: 9/16 (14.3) & 2 1/16 (52.4)
Height: 10 15/32 (265.9)
A. Gskt: [1] Attached
O-Ring: [1] Included



B7238 Lube Spin-on
Contains: Anti-Drainback Valve
 14 PSID By-Pass Valve
Fits: Onan Generators
Replaces: Onan 122-0836
Thread: 3/4 -16
O.D.: 2 9/16 (65.1)
Height: 4 3/4 (120.7)
I.Gskt: [1] Included



B7231 Lube Spin-on
Replaces: E.M.D. 40058635; Clark TL3FSO
Thread: 3/4 -16
O.D.: 3 11/16 (93.7)
Height: 7 1/8 (181.0)
I.Gskt: G381-A



B7239 Lube Spin-on
Contains: Anti-Drainback Valve
 Integral Post Seal
Fits: Daewoo Excavators
Replaces: Daewoo 65-05510-5016
Thread: 1 1/2 -12
O.D.: 4 21/32 (118.3)
Height: 8 3/32 (205.6)
I.Gskt: [1] Included



P7232 Lube Element
Fits: DAF Trucks
Replaces: DAF 1397764
O.D.: 4 11/32 (110.3)
I.D.: 2 1/4 (57.2)
Height: 5 7/8 (149.2)
A. Gskt: [2] Attached
O-Ring: [1] Included



B7240 Lube Spin-on
Contains: Anti-Drainback Valve
 14 PSID By-Pass Valve
Fits: Kubota Equipment
Replaces: Kubota 70000-74035
Thread: 3/4 -16
O.D.: 3 11/16 (93.7)
Height: 3 1/4 (82.6)
I.Gskt: G401



P7233 Lube Element
Fits: John Deere Engines, Equipment
Replaces: John Deere RE509672; Fleetguard LF16043
O.D.: 4 3/4 (120.7)
I.D.: 5/8 (15.9) & 2 1/16 (52.4)
Height: 5 25/32 (146.8)
A. Gskt: [1] Attached
O-Ring: [1] Included



B7241 Lube Spin-on
Contains: Anti-Drainback Valve
Fits: Daewoo Engines, Excavators
Replaces: Daewoo 65055105017, 65055105020; Fleetguard LF3716
Thread: 1 1/2 -12
O.D.: 4 21/32 (118.3)
Height: 9 15/16 (252.4)
I.Gskt: [1] Included



P7235 Lube Element
Fits: Ford Light-Duty Trucks; International Engines
Replaces: Ford 3C3Z-6731-AA; International 1840752-C91, 1844588-C91
O.D.: 3 9/32 (83.3)
I.D.: 3/8 (9.5) & 1 9/16 (39.7)
Height: 6 11/16 (169.9)
O-Ring: [1] Included
Related To: P7436, P7437 (with Lid)



BC7242 Centrifugal By-Pass Lube Element
Fits: 8/19/03-on Mack ASET Engines S/N 300079-up, 11/11/03-on ASET AI, AMI Engines S/N 3V0313-up
Replaces: Mack 57GC2231, 236GB42M
O.D.: 3 27/32 (97.6)
I.D.: 3/8 (9.5) & 1/2 (12.7)
Height: 7 (177.8)
F. Gskt: [1] Included
O-Ring: [1] Included



BT7237 Lube Spin-on
Fits: Case, New Holland Equipment
Replaces: Case 87803261; DAF 1399494; Iveco 504074043; New Holland 87803260
Thread: M27 x 2.0
O.D.: 3 11/16 (93.7)
Height: 6 5/8 (168.3)
I.Gskt: [1] Included



B7243 Lube Spin-on
Contains: Anti-Drainback Valve
 20 PSID By-Pass Valve
Fits: Chrysler, Dodge, Hyundai, Kia, Mitsubishi Automotive, Light-Duty Trucks
Replaces: Mitsubishi MD352626, MZ690116; Hyundai 26300-35500, 26300-35501
Thread: M20 x 1.5
O.D.: 3 1/32 (77.0)
Height: 3 7/16 (87.3)
I.Gskt: [1] Included



Measurements Are Shown In Inches And (Millimeters)











WARNING: These products can expose you to chemicals, including Diisononyl Phthalate, Carbon black extracts, Nickel, 1,3 Butadiene, Ethylene Oxide, Epichlorohydrin, which are known to the State of California to cause cancer, and Bisphenol, Ethylene Glycol, Ethylene Oxide, 1,3 Butadiene, Epichlorohydrin, which are known to the State of California to cause birth defects or other reproductive harm. For more information go to www.P65Warnings.ca.gov.

B7245	<p>High Efficiency Lube Spin-on Fits: Gas Compression Industry Thread: 1 1/2 -16 O.D.: 5 3/8 (136.5) Height: 12 3/32 (307.2) I.Gskt: [1] Included</p>
B7246	<p>Lube Spin-on with Drain Plug Fits: Hitachi Cranes, Excavators Replaces: Hitachi 4266385, 4430378; Fleetguard LF3603 Thread: 1 3/8 -16 O.D.: 4 29/32 (124.6) Height: 10 1/16 (255.6) I.Gskt: [1] Included</p>
P7247	<p>Transmission Filter Fits: Ford Super Duty Pickups, E Series Vans Replaces: Ford 3C3Z-7B155-BA; Motorcraft FT145 O.D.: 1 13/16 (46.0) I.D.: 3/8 (9.5) Height: 3 3/8 (85.7) O-Ring: [1] Included</p>
B7249-MPG	<p>Maximum Performance Glass Lube Spin-on Replaces: Donaldson ELF7405; Fleetguard LF3566 Thread: 1 1/2 -16 O.D.: 5 3/8 (136.5) Height: 12 3/32 (307.2) I.Gskt: [1] Included Related To: B99, B99-MPG, B99-SS (Different Media)</p>
BD7250	<p>High Velocity Dual-Flow Lube Spin-on Contains: Venturi-Type Cone Fits: International Engines, Trucks Replaces: International 1841606-C1, 1842639-C91; Donaldson P550656; Fleetguard LF9025 Thread: M95 x 2.0 O.D.: 4 21/32 (118.3) Height: 14 7/32 (361.2) I.Gskt: [1] Included O-Ring: [2] Viton Included</p>

BD7252	<p>High Velocity Dual-Flow Lube Spin-on Contains: Venturi-Type Cone Fits: International Engines, Trucks Replaces: International 1842543-C1, 1842655-C91; Fleetguard LF90035 Thread: M92 x 2.0 O.D.: 4 21/32 (118.3) Height: 10 11/32 (262.7) I.Gskt: [1] Included O-Ring: [2] Included</p>
P7255	<p>Lube Element Replaces: Ford XS7Q-6744-AA; Fleetguard LF16113; Woodgate WGL9206 O.D.: 3 9/16 (90.5) I.D.: 1 11/32 (34.1) Height: 2 7/16 (61.9) O-Ring: [1] Included</p>
P7256	<p>Lube Element Replaces: Petter 393204; Woodgate WGL3456 O.D.: 2 1/32 (51.6) I.D.: 29/32 (23.0) Height: 2 25/32 (70.6) A. Gskt: [2] Attached F. Gskt: [1] Included O-Ring: [1] Included</p>
P7259	<p>Lube Element Contains: By-Pass Valve Fits: Hatz Engines Replaces: Hatz 3795700; Fleetguard LF3794; Woodgate WGL9104 O.D.: 1 21/32 (42.1) I.D.: 1/2 (12.7) One End Height: 2 17/32 (64.3) Grommets: [1] Attached</p>
P7260	<p>Lube Element Replaces: Robin 2286430101; Woodgate WGL9121 O.D.: 1 7/32 (31.0) Flange 1 25/32 x 2 9/16 (45.2 x 65.1) I.D.: 15/32 (11.9) One End Height: 2 17/32 (64.3) O-Ring: [1] Attached</p>
P7263	<p>Lube Element with Lift Tab Contains: By-Pass Valve Fits: Ruggnerini Engines Replaces: Ruggnerini 17505; Woodgate WGL9125 O.D.: 29/32 (23.0) I.D.: 13/32 (10.3) Height: 2 7/8 (73.0) A. Gskt: [1] Attached</p>

Measurements Are Shown In Inches And (Millimeters)

WARNING: These products can expose you to chemicals, including Diisononyl Phthalate, Carbon black extracts, Nickel, 1,3 Butadiene, Ethylene Oxide, Epichlorohydrin, which are known to the State of California to cause cancer, and Bisphenol, Ethylene Glycol, Ethylene Oxide, 1,3 Butadiene, Epichlorohydrin, which are known to the State of California to cause birth defects or other reproductive harm. For more information go to www.P65Warnings.ca.gov.

<p>P7264</p>  <p>Lube Element Contains: By-Pass Valve Fits: Hitachi, John Deere Excavators Replaces: Hitachi 4294132; Woodgate WGL9126 O.D.: 3 9/16 (90.5) I.D.: 1 5/8 (41.3) One End Height: 8 7/32 (208.8) O-Ring: [1] Attached</p>	<p>B7273</p>  <p>Lube Spin-on Contains: Anti-Drainback Valve By-Pass Valve Fits: J.C. Bamford Excavators Replaces: J.C. Bamford 2/800176; Woodgate WGL3528 Thread: M20 x 1.5 O.D.: 3 5/8 (92.1) Height: 5 1/16 (128.6) I.Gskt: [1] Included</p>
<p>P7267</p>  <p>Lube Element Replaces: Hino 15607-1531; Woodgate WGL9195 O.D.: 4 13/16 (122.2) I.D.: 2 1/32 (16.7) Height: 8 21/32 (219.9) F. Gskt: [3] Included O-Ring: [1] Included</p>	<p>B7274</p>  <p>Lube Spin-on Contains: 20 PSID By-Pass Valve Standpipe Fits: J.C. Bamford Equipment Replaces: J.C. Bamford 32/915500; Woodgate WGL9035 Thread: 1 -12 O.D.: 3 11/16 (93.7) Height: 4 3/8 (111.1) I.Gskt: [1] Included</p>
<p>P7268</p>  <p>Wire Mesh Supported Lube Element Replaces: Fairey-Arlon TXW5CC10; Woodgate WGTW5CC-10 O.D.: 4 3/16 (106.4) I.D.: 13/32 (10.3) & 2 27/32 (72.2) Height: 10 3/16 (258.8) O-Ring: [1] Attached</p>	<p>B7275</p>  <p>Lube Spin-on Contains: Anti-Drainback Valve By-Pass Valve Replaces: Ford 89FF-6714-A1C; Mercedes-Benz 1031800610; Woodgate WGL9107 Thread: 3/4 -16 O.D.: 3 (76.2) Height: 3 27/32 (97.6) I.Gskt: [1] Included</p>
<p>P7269</p>  <p>Lube Element with Bail Handle Replaces: Woodgate WGL3605N O.D.: 3 7/32 (81.8) I.D.: 7/8 (22.2) Height: 5 3/16 (131.8) F. Gskt: [1] Copper Washer O-Ring: [1] Included, [1] Copper O-Ring Grommets: [2] Attached</p>	<p>B7276</p>  <p>Lube Spin-on Contains: Anti-Drainback Valve 14 PSID By-Pass Valve Fits: Lombardini Engines Replaces: Lombardini 105.2175.136, 115.2175.136; Woodgate WGL9130 Thread: M20 x 1.5 O.D.: 3 (76.2) Height: 2 5/16 (58.7) I.Gskt: [1] Included</p>
<p>B7271</p>  <p>Lube Spin-on Contains: Anti-Drainback Valve 8-12 PSID By-Pass Valve Standpipe Fits: Case, Terex Equipment Replaces: Massey Ferguson 3621292-M1; Woodgate WGL3353 Thread: 3/4 -16 O.D.: 3 11/16 (93.7) Height: 4 1/2 (114.3) I.Gskt: [1] Included</p>	<p>B7277</p>  <p>Lube Spin-on Contains: By-Pass Valve Replaces: Fiat-Iveco 5495622; Mercedes-Benz 1031840201; Woodgate WGL9132 Thread: M20 x 1.5 O.D.: 3 3/32 (78.6) Height: 3 27/32 (97.6) I.Gskt: [1] Included</p>
	<p>B7280</p>  <p>Lube Spin-on Replaces: GMC 93156631; Woodgate WGL9160 Thread: M20 x 1.5 O.D.: 4 9/32 (108.7) Height: 4 (101.6) I.Gskt: [1] Included</p>

Measurements Are Shown In Inches And (Millimeters)

WARNING: These products can expose you to chemicals, including Diisononyl Phthalate, Carbon black extracts, Nickel, 1,3 Butadiene, Ethylene Oxide, Epichlorohydrin, which are known to the State of California to cause cancer, and Bisphenol, Ethylene Glycol, Ethylene Oxide, 1,3 Butadiene, Epichlorohydrin, which are known to the State of California to cause birth defects or other reproductive harm. For more information go to www.P65Warnings.ca.gov.

<p>B7281 Lube Spin-on Contains: Anti-Drainback Valve 14 PSID By-Pass Valve Replaces: Yanmar 119100-35100; Woodgate WGL3536 Thread: M20 x 1.5 O.D.: 3 7/32 (81.8) Height: 3 7/8 (98.4) I.Gskt: [1] Included</p> 	<p>B7290 Lube Spin-on Contains: Anti-Drainback Valve 14 PSID By-Pass Valve Fits: Caterpillar, Lombardini, Ruggerini Engines Replaces: Lombardini 500.217.536; Woodgate WGL3338 Thread: 3/4 -16 O.D.: 3 (76.2) Height: 3 7/8 (98.4) I.Gskt: [1] Included</p> 
<p>B7283 Lube Spin-on Notes: OBSOLETE. Availability Limited to Dealer Stock. Contains: Anti-Drainback Valve By-Pass Valve Replaces: Renault 7701727480; Woodgate WGL9180 Thread: M20 x 1.5 O.D.: 3 1/2 (88.9) Height: 2 11/32 (59.5) I.Gskt: [1] Included</p> 	<p>B7291 Lube Spin-on Contains: Anti-Drainback Valve 17 PSID By-Pass Valve Replaces: Leyland ADU3553; Fleetguard LF3643; Woodgate WGL3643 Thread: 13/16 -16 O.D.: 3 5/8 (92.1) Height: 3 7/8 (98.4) I.Gskt: [1] Included</p> 
<p>B7285 Lube Spin-on Contains: Anti-Drainback Valve 20 PSID By-Pass Valve Fits: Kubota Engines, Equipment Replaces: Kubota 15853-32430; Woodgate WGL9187 Thread: M20 x 1.5 O.D.: 2 9/16 (65.1) Height: 2 5/8 (66.7) I.Gskt: [1] Included</p> 	<p>B7292 Lube Spin-on Contains: 8-12 PSID By-Pass Valve Fits: Ducati Motorcycles Replaces: GMC 7984608; Woodgate WGL9032 Thread: M16 x 1.5 O.D.: 3 (76.2) Height: 2 31/32 (75.4) I.Gskt: [1] Included</p> 
<p>B7286 Lube Spin-on Contains: Anti-Drainback Valve By-Pass Valve Replaces: Iseki 621324000210; Woodgate WGL9200 Thread: 3/4 -16 O.D.: 2 11/16 (68.3) Height: 3 (76.2) I.Gskt: [1] Included</p> 	<p>B7293 Lube Spin-on Contains: Anti-Drainback Valve By-Pass Valve Replaces: Lister 601-32950; Woodgate WGL9131 Thread: M16 x 1.5 O.D.: 3 3/32 (78.6) Height: 2 1/2 (63.5) I.Gskt: [1] Included</p> 
<p>B7287 Lube Spin-on Replaces: Iseki 621324000510; Woodgate WGL9201 Thread: 3/4 -16 O.D.: 3 1/32 (77.0) Height: 3 3/16 (81.0) I.Gskt: [1] Included</p> 	<p>B7294 Lube Spin-on Contains: Anti-Drainback Valve 32 PSID By-Pass Valve Fits: Bomag Rollers with Deutz Engines Replaces: Deutz 1180815; Woodgate WGL9060 Thread: 3/4 -16 O.D.: 3 (76.2) Height: 2 9/32 (57.9) I.Gskt: [1] Included</p> 
<p>B7289 Lube Spin-on Contains: Anti-Drainback Valve By-Pass Valve Fits: Toro Groundsmaster, Reelmaster Tractors Replaces: Toro 74-7970; Woodgate WGL9109 Thread: M20 x 1.5 O.D.: 3 (76.2) Height: 3 11/32 (84.9) I.Gskt: [1] Included</p> 	<p>B7295 Lube Spin-on Fits: Claas Combines Replaces: Woodgate WGL3310 Thread: 3/4 -16 O.D.: 3 (76.2) Height: 3 1/8 (79.4) I.Gskt: [1] Included</p> 
	<p>B7298 Lube Spin-on Contains: Anti-Drainback Valve 14 PSID By-Pass Valve Fits: Kubota Equipment Replaces: Kubota 1C020-32430; Woodgate WGL9202 Thread: 3/4 -16 O.D.: 3 23/32 (94.5) Height: 3 31/32 (100.8) I.Gskt: [1] Included</p> 

Measurements Are Shown In Inches And (Millimeters)

WARNING: These products can expose you to chemicals, including Diisononyl Phthalate, Carbon black extracts, Nickel, 1,3 Butadiene, Ethylene Oxide, Epichlorohydrin, which are known to the State of California to cause cancer, and Bisphenol, Ethylene Glycol, Ethylene Oxide, 1,3 Butadiene, Epichlorohydrin, which are known to the State of California to cause birth defects or other reproductive harm. For more information go to www.P65Warnings.ca.gov.

B7299 High Efficiency Lube Spin-on
Fits: Caterpillar Engines
Replaces: Caterpillar 1R1808, 275-2604
Thread: 1 1/2 -16
O.D.: 5 3/8 (136.5)
Height: 12 3/32 (307.2)
I.Gskt: [1] Included
Related To: B99, B99-MPG, B99-SS (Standard Versions)
 B7507 (w/3 O-Rings)



BD7310 High Velocity Dual-Flow Lube Spin-on
Contains: Venturi-Type Cone
Fits: John Deere Equipment
Replaces: John Deere RE58935
Thread: M52 x 1.5
O.D.: 4 21/32 (118.3)
Height: 11 13/32 (289.7)
I.Gskt: G293-B



P7303 Lube Element with Bail Handle
Contains: By-Pass Valve
Fits: Lombardini Engines
Replaces: Lombardini 710.275.138; Woodgate WGL9157
O.D.: 1 17/32 (38.9)
I.D.: 15/32 (11.9)
Height: 2 17/32 (64.3)
A. Gskt: [1] Attached



B7311-MPG Maximum Performance Glass Lube Spin-on
Contains: Anti-Drainback Valve
 8 PSID By-Pass Valve
Fits: Carrier Refrigeration Units
Replaces: Carrier 30-00450-00; Fleetguard LF3947
Thread: 3/4 -16
O.D.: 3 11/16 (93.7)
Height: 7 1/8 (181.0)
I.Gskt: G381-A



P7305 Lube Element
Fits: M.A.N. Trucks
Replaces: Mann & Hummel HU947/1n; Mercedes-Benz 3661801009, 3661801025, 3661840125
O.D.: 3 9/32 (83.3)
I.D.: 15/16 (23.8)
Height: 7 19/32 (192.9)
O-Ring: [2] Included
Grommets: [2] Attached



P7312 Lube Element
Notes: Inside-Out Flow Direction
Replaces: Wartsila 5611F185, 5611F216
O.D.: 4 31/32 (126.2)
I.D.: 9/16 (14.3) & 3 5/8 (92.1)
Height: 11 7/16 (290.5)
F. Gskt: [1] Included
O-Ring: [2] Included

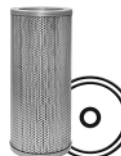

B7306 Lube Spin-on
Contains: 30 PSID By-Pass Valve
Fits: John Deere Engines, Tractors
Replaces: John Deere RE518977
Thread: M24 x 1.5
O.D.: 3 11/16 (93.7)
Height: 5 13/32 (137.3)
I.Gskt: G401



P7313 Lube Element
Fits: Ford, Mazda Automotive
Replaces: Ford 3M4Z-6744-AC; Mazda L321-14-302
O.D.: 2 9/16 (65.1)
I.D.: 31/32 (24.6)
Height: 2 7/8 (73.0)
O-Ring: [2] Included



P7308 Lube Element
Fits: Volkswagen Automotive
Replaces: Volkswagen 74115562
O.D.: 2 17/32 (64.3)
I.D.: 21/32 (16.7)
Height: 6 1/32 (153.2)
A. Gskt: [2] Attached
O-Ring: [2] Included



B7314 Lube Spin-on
Contains: 35 PSID By-Pass Valve
Fits: International 4400 DuraStar
Replaces: International 1842816-C2
Thread: M45 x 1.5
O.D.: 5 3/8 (136.5)
Height: 9 5/8 (244.5)
I.Gskt: [1] Included



BD7309 High Velocity Dual-Flow Lube Spin-on
Contains: Venturi-Type Cone
Fits: Cummins Engines
Replaces: Cummins 3401544
Thread: 2 1/4 -12
O.D.: 4 21/32 (118.3)
Height: 11 13/32 (289.7)
I.Gskt: [1] Included
Related To: BD103 (Standard Version)



BT7316 Lube Spin-on
Contains: Anti-Drainback Valve
 30 PSID By-Pass Valve
 Standpipe
Fits: Case-International Tractors
Replaces: Case 47128196
Thread: 3/4 -16
O.D.: 4 1/4 (108.0)
Height: 5 13/16 (147.6)
I.Gskt: G381-A



Measurements Are Shown In Inches And (Millimeters)

WARNING: These products can expose you to chemicals, including Diisononyl Phthalate, Carbon black extracts, Nickel, 1,3 Butadiene, Ethylene Oxide, Epichlorohydrin, which are known to the State of California to cause cancer, and Bisphenol, Ethylene Glycol, Ethylene Oxide, 1,3 Butadiene, Epichlorohydrin, which are known to the State of California to cause birth defects or other reproductive harm. For more information go to www.P65Warnings.ca.gov.

BD7317

Dual-Flow Lube Spin-on



Contains: Venturi-Type Cone
Fits: Carrier Refrigeration Units
Replaces: Carrier 30-00463-00; Fleetguard LF9028
Thread: 1 -16
O.D.: 3 11/16 (93.7)
Height: 7 1/8 (181.0)
I.Gskt: [1] Included

B7324

Lube Spin-on



Contains: 14 PSID By-Pass Valve
Fits: J.C. Bamford Equipment with Isuzu Engines
Replaces: Isuzu 87610-006, 1-87610-006-0; J.C. Bamford 02/801481, 581/18096
Thread: 1 1/2 -12
O.D.: 4 21/32 (118.3)
Height: 8 3/32 (205.6)
I.Gskt: [1] Included

B7318

Lube Spin-on



Contains: Anti-Drainback Valve
 20 PSID By-Pass Valve
Fits: Volvo Excavators
Replaces: Volvo 7410062
Thread: M20 x 1.5
O.D.: 2 9/16 (65.1)
Height: 3 1/2 (88.9)
I.Gskt: [1] Included

BD7325

Dual-Flow Lube Spin-on



Fits: Hino, Nissan UD Trucks
Replaces: Hino 15607-2190
Thread: 1 1/2 -16
O.D.: 4 21/32 (118.3)
Height: 8 1/8 (206.4)
I.Gskt: [1] Included

P7319

Lube Element



Fits: Scania Generator Sets, Trucks
Replaces: Scania 1439036; Fleetguard LF3895
O.D.: 4 1/32 (102.4)
I.D.: 1 25/32 (45.2) One End
Height: 10 (254.0)
O-Ring: [1] Included

BC7326

Centrifugal Lube Element



Fits: Freightliner, Kenworth, Peterbilt, Sterling Trucks; Mercedes-Benz, Paccar Engines
Replaces: Mercedes-Benz A9061810086; Fleetguard CS41008
O.D.: 3 11/16 (93.7)
I.D.: 1/4 (6.4) One End
Height: 5 13/16 (147.6)
O-Ring: [1] Included
Related To: BC7485 (Different O-Ring)

B7320

Lube Spin-on



Contains: Anti-Drainback Valve
 40 PSID By-Pass Valve
Fits: Demag Compressors; Volvo Loaders
Replaces: Volvo 11700375; Mann & Hummel W940/18
Thread: 1 -12
O.D.: 3 11/16 (93.7)
Height: 5 3/8 (136.5)
I.Gskt: G381-A

B7327

Lube Spin-on



Contains: Anti-Drainback Valve
Fits: Case-International, New Holland Tractors
Replaces: Case 2854750, 87803206
Thread: M27 x 2.0
O.D.: 3 11/16 (93.7)
Height: 6 5/8 (168.3)
I.Gskt: G381-A

P7321

Lube Element



Notes: Inside-Out Flow Direction
Replaces: Perkins 996452, CH10929
O.D.: 4 29/32 (124.6)
I.D.: 1 11/16 (42.9) One End
Height: 10 21/32 (270.7)
O-Ring: [1] Included

B7328

Lube Spin-on



Fits: New Holland Equipment
Replaces: New Holland 87803201
Thread: M27 x 2.0
O.D.: 3 23/32 (94.5)
Height: 3 7/8 (98.4)
I.Gskt: G381-A

B7322

Lube Spin-on



Fits: John Deere Equipment
Replaces: John Deere RE504836
Thread: M92 x 2.5
O.D.: 3 29/32 (99.2)
Height: 5 15/16 (150.8)
I.Gskt: [1] Included

P7329











Lube Element



Fits: ERF Trucks; M.A.N. Engines, Trucks; R.V.I. Trucks; Volvo Engines, Trucks; Volvo-Penta Generators
Replaces: M.A.N. 51.05504.0107, 51.05504.0108
O.D.: 4 3/4 (120.7)
I.D.: 9/16 (14.3) & 2 1/16 (52.4)
Height: 7 7/8 (200.0)
A. Gskt: [1] Included
O-Ring: [1] Included

Measurements Are Shown In Inches And (Millimeters)

WARNING: These products can expose you to chemicals, including Diisononyl Phthalate, Carbon black extracts, Nickel, 1,3 Butadiene, Ethylene Oxide, Epichlorohydrin, which are known to the State of California to cause cancer, and Bisphenol, Ethylene Glycol, Ethylene Oxide, 1,3 Butadiene, Epichlorohydrin, which are known to the State of California to cause birth defects or other reproductive harm. For more information go to www.P65Warnings.ca.gov.

<p>P7330 Lube Element  Fits: DAF Buses, Trucks Replaces: DAF 1397765; Hengst E43HD97; Mann & Hummel HU1297X O.D.: 4 7/16 (112.7) I.D.: 2 19/32 (65.9) Height: 8 17/32 (216.7) A. Gskt: [2] Attached O-Ring: [1] Included</p>	<p>P7336 KIT Set of 2 Hydraulic Breather Elements  Fits: Iveco EuroCargo Trucks Replaces: Iveco 2992447; Coopers AEM2940; Hengst EAS304MD152; Mann & Hummel C911X2 Each Element O.D.: 2 3/32 (53.2) to 3 9/32 (83.3) I.D.: 21/32 (16.7) One End Height: 2 3/4 (69.9) F. Gskt: [1] Included Grommets: [1] Attached Each Element</p>
<p>PT7332 Full-Flow Lube or Hydraulic Element  Contains: Reinforced Centertube Fits: American Hoist & Derrick, Caterpillar, Clark, Gardner Denver, Koehring, Komatsu LeRoi, Link-Belt Equipment Replaces: Caterpillar 1R0659; Deutz 1161212; Komatsu 611-4505-100 O.D.: 3 15/16 (100.0) I.D.: 1 19/32 (40.5) Height: 9 9/32 (235.7) F. Gskt: G171, G214, [1] Included O. Gskt: G115-MSB, G342, G435 Related To: PT670 (with Paper Wrapper)</p>	<p>P7337 2-Section Hydraulic Element  Replaces: Cummins 3420742; Fleetguard LF16031 O.D.: 7 21/32 (194.5) I.D.: 4 21/32 (118.3) Height: 16 (406.4) A. Gskt: [2] Attached</p>
<p>B7333 Lube Spin-on  Contains: Anti-Drainback Valve By-Pass Valve Fits: Cushman Equipment Replaces: Jacobsen 2701908; Suzuki 16510-82703 Thread: 3/4 -16 O.D.: 2 25/32 (70.6) Height: 2 5/8 (66.7) I.Gskt: [1] Included</p>	<p>P7338 Lube Element  Fits: Volvo Automotive Replaces: Volvo 12758116 O.D.: 2 7/8 (73.0) I.D.: 1 1/32 (26.2) Height: 3 5/32 (80.2) O-Ring: [1] Included</p>
<p>B7334 Lube Spin-on  Contains: Anti-Drainback Valve 14 PSID By-Pass Valve Fits: Equipment with Cummins A1400, A1700, A2000, A2300 Engines Replaces: Kukje HRA11020F4A3; Fleetguard LF16034 Thread: M20 x 1.5 O.D.: 3 1/32 (77.0) Height: 3 7/16 (87.3) I.Gskt: [1] Included</p>	<p>BT7349 Lube Spin-on  Notes: BT7349 may be used in place of BT339. Do NOT substitute BT339 for BT7349. Can is fluted for improved installation. Fits: Dodge Light and Medium-Duty Trucks with 5.9L and 6.7L Turbo Diesel Engines Replaces: Chrysler 5083285AA Thread: 1 -16 O.D.: 3 11/16 (93.7) Height: 7 1/8 (181.0) I.Gskt: G381-A</p>
<p>B7335-MPG Maximum Performance Glass Lube Spin-on  Fits: John Deere Equipment Replaces: John Deere RE521420; Fleetguard LF16106 Thread: 1 5/8 -12 O.D.: 5 1/16 (128.6) Height: 6 31/32 (177.0) F. Gskt: G369-B O-Ring: G447</p>	<p>B7350 Lube Spin-on  Contains: Anti-Drainback Valve 35 PSID By-Pass Valve Check Valve Fits: Gillisons GVF5000 Lift Truck; J.C. Bamford Generators, Equipment Replaces: J.C. Bamford 320/04133; Alco SP-1294 Thread: M22 x 1.5 O.D.: 3 25/32 (96.0) Height: 6 11/16 (169.9) I.Gskt: [1] Included</p>
	<p>B7351-MPG Maximum Performance Glass Lube Spin-on  Fits: Komatsu Loaders Replaces: Komatsu 6731525130 Thread: 1 -16 O.D.: 3 11/16 (93.7) Height: 5 3/8 (136.5) I.Gskt: G381-A</p>

Measurements Are Shown In Inches And (Millimeters)

WARNING: These products can expose you to chemicals, including Diisononyl Phthalate, Carbon black extracts, Nickel, 1,3 Butadiene, Ethylene Oxide, Epichlorohydrin, which are known to the State of California to cause cancer, and Bisphenol, Ethylene Glycol, Ethylene Oxide, 1,3 Butadiene, Epichlorohydrin, which are known to the State of California to cause birth defects or other reproductive harm. For more information go to www.P65Warnings.ca.gov.

B7352

Lube Spin-on



Contains: Anti-Drainback Valve
11 PSID By-Pass Valve
Fits: R.V.I. Trucks
Replaces: Renault 7700720978, 7700734825,
7700856339, 7700867454, 7701349942
Thread: M20 x 1.5
O.D.: 3 1/8 (79.4)
Height: 3 17/32 (89.7)
I.Gskt: [1] Included

B7362

Lube Spin-on



Contains: 30 PSID By-Pass Valve
Fits: Tata Engines
Replaces: Tata Cummins 252718130132;
Fleetguard LF16061
Thread: 1 -16
O.D.: 3 11/16 (93.7)
Height: 6 9/16 (166.7)
I.Gskt: G381-A

B7356

Lube Spin-on



Contains: Anti-Drainback Valve
8 PSID By-Pass Valve
Fits: Agco, Challenger, Massey Ferguson
Tractors
Replaces: Agco 72201898; Massey Ferguson
3609410-M1, 3710280-M2
Thread: 3/4 -16
O.D.: 2 9/16 (65.1)
Height: 2 5/8 (66.7)
I.Gskt: [1] Included

B7363

Full-Flow Lube Spin-on



Contains: 50 PSID By-Pass Valve
By-Pass Screen
Fits: Agco, Challenger, Massey Ferguson
Tractors
Replaces: Agco V836862582; Sisu 836862582;
Mann & Hummel W1374/7
Thread: 1 1/2 -16
O.D.: 5 3/8 (136.5)
Height: 7 (177.8)
I.Gskt: [1] Included

B7357

Lube Spin-on



Contains: 30 PSID By-Pass Valve
Fits: Tata Engines
Replaces: Tata Cummins 252518130139;
Fleetguard LF16060
Thread: 1 -14
O.D.: 3 23/32 (94.5)
Height: 8 1/8 (206.4)
I.Gskt: G401

P7364

Lube Element



Fits: Hyundai Genesis, Sonata, Veracruz; Kia
Sorento
Replaces: Hyundai 26320-3C250
O.D.: 2 9/16 (65.1)
I.D.: 1 1/16 (27.0)
Height: 4 7/32 (107.2)
I.Gskt: [2] Included
F. Gskt: [1] Metal Washer
O-Ring: [2] Included

B7359

Lube Spin-on



Contains: 20 PSID By-Pass Valve
Fits: Tata Engines
Replaces: Tata Cummins 253418130165;
Fleetguard LF16062
Thread: 13/16 -16
O.D.: 3 23/32 (94.5)
Height: 5 15/32 (138.9)
I.Gskt: G401

P7365

Lube Element



Fits: Nissan Light-Duty Trucks
Replaces: Nissan 15209-00QAC, 15209-2W200;
Opel 4415218; Renault 7701057828
O.D.: 3 1/32 (77.0)
I.D.: 7/8 (22.2)
Height: 4 1/16 (103.2)
A. Gskt: [2] Attached
O-Ring: [1] Included

B7360

Lube Spin-on



Contains: Anti-Drainback Valve
40 PSID By-Pass Valve
Fits: Tata Engines
Replaces: Tata Cummins 253418130169;
Fleetguard LF16056
Thread: M24 x 1.5
O.D.: 3 11/16 (93.7)
Height: 5 11/16 (144.5)
I.Gskt: G401

B7367

Lube Spin-on



Contains: Anti-Drainback Valve
30 PSID By-Pass Valve
Replaces: Parker China Division JX0818,
WB236, Huafeng Power (Shandong Weichai
Huafeng Power Co., Ltd.) 61000070005
Thread: 1 -12
O.D.: 3 19/32 (91.3)
Height: 8 1/8 (206.4)
I.Gskt: [1] Included

B7361

Lube Spin-on



Contains: Anti-Drainback Valve
14 PSID By-Pass Valve
Fits: J.C. Bamford Equipment
Replaces: J.C. Bamford 2/630935, 2/630935A
Thread: 3/4 -16
O.D.: 3 (76.2)
Height: 3 17/32 (89.7)
I.Gskt: G449-B

P7368













By-Pass Lube Element



Fits: Cummins Engines
Replaces: Cummins 3873576; Fleetguard
LF16029
O.D.: 5 1/32 (127.8)
I.D.: 1 1/2 (38.1) One End
Height: 8 11/16 (220.7)
Grommets: [1] Attached

Measurements Are Shown In Inches And (Millimeters)

WARNING: These products can expose you to chemicals, including Diisononyl Phthalate, Carbon black extracts, Nickel, 1,3 Butadiene, Ethylene Oxide, Epichlorohydrin, which are known to the State of California to cause cancer, and Bisphenol, Ethylene Glycol, Ethylene Oxide, 1,3 Butadiene, Epichlorohydrin, which are known to the State of California to cause birth defects or other reproductive harm. For more information go to www.P65Warnings.ca.gov.

<p>B7370 Lube Spin-on Contains: Anti-Drainback Valve 30 PSID By-Pass Valve Fits: Dongfeng DF304G2 Tractors Replaces: Parker China Division JX0811A Thread: 1 -12 O.D.: 3 19/32 (91.3) Height: 5 1/8 (130.2) I.Gskt: [1] Included</p> 	<p>B7378 Lube Spin-on Contains: Anti-Drainback Valve 20 PSID By-Pass Valve Fits: Caterpillar Equipment Replaces: Caterpillar 269-8325; Donaldson P550920 Thread: M24 x 1.5 O.D.: 3 11/16 (93.7) Height: 8 1/8 (206.4) I.Gskt: G381-A</p> 
<p>B7372 Lube Spin-on Contains: Anti-Drainback Valve Fits: Daewoo Excavators Replaces: Doosan 47100093, 65055105028A Thread: 1 -16 O.D.: 3 11/16 (93.7) Height: 7 5/32 (181.8) I.Gskt: G381-A</p> 	<p>B7379 Lube Spin-on Contains: Anti-Drainback Valve 20 PSID By-Pass Valve Fits: Ford Super Duty Pickups with V8-406 (6.7L) Turbo Diesel Engine Replaces: Motorcraft FL2051 Thread: 1 -16 O.D.: 3 11/16 (93.7) Height: 6 7/16 (163.5) I.Gskt: G381-A</p> 
<p>B7373 Lube Spin-on Contains: Anti-Drainback Valve 40 PSID By-Pass Valve Replaces: Baudouin 1504168OC; Fleetguard LF3808; Mann & Hummel W1140/8 Thread: 1 -12 O.D.: 4 1/4 (108.0) Height: 4 3/4 (120.7) I.Gskt: [1] Included</p> 	<p>P7380 Lube Element Replaces: Parker China Division 12VB1810B; Jinan Diesel Engine Co. 12VB1810B O.D.: 5 23/32 (145.3) I.D.: 2 7/16 (61.9) Height: 5 5/8 (142.9)</p> 
<p>B7375 Lube Spin-on Fits: Thermo King Refrigeration Units Replaces: Thermo King 11-9182; Donaldson P550835; Fleetguard LF9030, LF16164 Thread: 1 1/8 -12 O.D.: 3 11/16 (93.7) Height: 7 1/8 (181.0) I.Gskt: [1] Included</p> 	<p>B7383 Lube Spin-on Contains: 35 PSID By-Pass Valve Replaces: Parker China Division JX1016; Sinotruk VG1246070031; Weichai Power 612630010239 Thread: M30 x 2.0 O.D.: 4 1/4 (108.0) Height: 7 11/16 (195.3) I.Gskt: [1] Included</p> 
<p>B7376 Lube Spin-on Contains: Anti-Drainback Valve 40 PSID By-Pass Valve Standpipe Fits: Iveco Daily Trucks Replaces: Iveco 2995561 Thread: M22 x 1.5 O.D.: 3 11/16 (93.7) Height: 6 5/8 (168.3) I.Gskt: G381-A</p> 	<p>B7384 Lube Spin-on Contains: 25 PSID By-Pass Valve Replaces: Parker China Division WB202E; FAW-Xichai 1012015AB010000 Thread: M20 x 1.5 O.D.: 3 19/32 (91.3) Height: 4 13/16 (122.2) I.Gskt: [1] Included</p> 
<p>B7377 Lube Spin-on Contains: Anti-Drainback Valve 40 PSID By-Pass Valve Fits: Citroen, Fiat, Iveco Daily Vans Replaces: Citroen 1109Y6; Fiat 8093784; Iveco 2992188; Alco SP1269 Thread: M22 x 1.5 O.D.: 3 11/16 (93.7) Height: 5 3/8 (136.5) I.Gskt: G381-A</p> 	<p>B7385 Lube Spin-on Contains: 20 PSID By-Pass Valve Replaces: Parker China Division WB447S; FAW Xichai 1012101A020000A Thread: 1 -12 O.D.: 4 1/4 (108.0) Height: 4 13/32 (111.9) I.Gskt: [1] Included</p> 

Measurements Are Shown In Inches And (Millimeters)

WARNING: These products can expose you to chemicals, including Diisononyl Phthalate, Carbon black extracts, Nickel, 1,3 Butadiene, Ethylene Oxide, Epichlorohydrin, which are known to the State of California to cause cancer, and Bisphenol, Ethylene Glycol, Ethylene Oxide, 1,3 Butadiene, Epichlorohydrin, which are known to the State of California to cause birth defects or other reproductive harm. For more information go to www.P65Warnings.ca.gov.

B7386 Lube Spin-on
Contains: 25 PSID By-Pass Valve
Replaces: Parker China Division WB447SX; FAW-Xichai 1012101A020000W
Thread: 1 -12
O.D.: 4 1/4 (108.0)
Height: 4 13/32 (111.9)
I.Gskt: [1] Included



B7395 Maximum Performance Glass Lube Spin-on
Fits: Quincy Compressors
Replaces: Quincy 128381050
Thread: 31/32 -20
O.D.: 3 21/32 (92.9)
Height: 5 3/8 (136.5)
A. Gskt: G381-A



B7387 Lube Spin-on
Contains: Anti-Drainback Valve
 20 PSID By-Pass Valve
Replaces: Parker China Division JX0814, WB7031; DCD JX4102B
Thread: 1 -12
O.D.: 3 19/32 (91.3)
Height: 6 5/8 (168.3)
I.Gskt: [1] Included



B7396 Lube Spin-on
Notes: Can be used with OB1368, OB1369 bases.
Contains: Integral Post Seal
Fits: Aksa, Belaz, Cummins, Demag, Euclid, Hitachi, Komatsu, Manitowoc, Unit Rig, WABCO Equipment
Replaces: Cummins 3307885, 3310169, 3313282; Komatsu CU3307885, VS7692; Liebherr 7369715; Renault 5000822872
Thread: 1 1/2 -12
O.D.: 4 11/16 (119.1)
Height: 11 9/32 (286.5)
I.Gskt: [1] Included



B7388 Lube Spin-on
Contains: Anti-Drainback Valve
 40 PSID By-Pass Valve
 Standpipe
Fits: Iveco Daily, Mitsubishi Trucks
Replaces: Iveco 2995655; Mitsubishi MK666096, MK667378
Thread: M22 x 1.5
O.D.: 3 11/16 (93.7)
Height: 5 3/8 (136.5)
A. Gskt: G381-A



B7397 Lube Spin-on
Fits: Case-International Tractors
Replaces: Case 87300047; Fleetguard LF3593
Thread: 1 1/8 -16
O.D.: 4 1/4 (108.0)
Height: 7 3/8 (187.3)
I.Gskt: [1] Included



B7390 Lube Spin-on
Contains: Anti-Drainback Valve
 18-20 PSID By-Pass Valve
Replaces: Faw-Xichai 1118105-051-0000; Parker China Division WB178A
Thread: M20 x 1.5
O.D.: 3 3/32 (78.6)
Height: 4 27/32 (123.0)
I.Gskt: [1] Included



P7398 Lube Element
Contains: [1] Plastic Drain Plug
Fits: Lexus, Toyota Automotive, Light-Duty Trucks
Replaces: Toyota 4152-31090
O.D.: 2 3/4 (69.9)
I.D.: 1 3/32 (27.8)
Height: 2 5/8 (66.7)
O-Ring: [2] Included



B7393 Lube Spin-on
Contains: Anti-Drainback Valve
 20 PSID By-Pass Valve
Replaces: Parker China Division JX1012A; DCD (DongFeng Chaoyang Diesel) 4102AZL.14.40
Thread: M30 x 1.5
O.D.: 4 9/32 (108.7)
Height: 6 1/4 (158.8)
I.Gskt: [1] Included



P7399 Lube Element
Fits: Audi, Volkswagen Automotive
Replaces: Volkswagen 6D115466, 6D115562
O.D.: 2 1/2 (63.5)
I.D.: 1 7/32 (31.0)
Height: 4 15/16 (125.4)
F. Gskt: [1] Included



BC7394 Centrifugal by-Pass Lube Element
Fits: International Engines, Trucks
Replaces: International 1842825C91; Donaldson P552231
O.D.: 3 27/32 (97.6)
I.D.: 3/8 (9.5) & 1/2 (12.7)
Height: 7 (177.8)
F. Gskt: [1] Included
O-Ring: [1] Included



P7400 Lube Element
Fits: Hyundai, Kia Automotive, Light-Duty Trucks
Replaces: Hyundai 26320-3C100
O.D.: 2 7/8 (73.0)
I.D.: 1 3/8 (34.9)
Height: 5 3/32 (129.4)
A. Gskt: [2] Attached
O-Ring: [2] Included



Measurements Are Shown In Inches And (Millimeters)

WARNING: These products can expose you to chemicals, including Diisononyl Phthalate, Carbon black extracts, Nickel, 1,3 Butadiene, Ethylene Oxide, Epichlorohydrin, which are known to the State of California to cause cancer, and Bisphenol, Ethylene Glycol, Ethylene Oxide, 1,3 Butadiene, Epichlorohydrin, which are known to the State of California to cause birth defects or other reproductive harm. For more information go to www.P65Warnings.ca.gov.

<p>B7401 Lube Spin-on Contains: Anti-Drainback Valve 14 PSID By-Pass Valve Fits: Chrysler, Dodge, Jeep Automotive, Light-Duty Trucks Replaces: Chrysler 4884900AB Thread: M22 x 1.5 O.D.: 3 1/32 (77.0) Height: 2 25/32 (70.6) I.Gskt: [1] Included</p> 	<p>B7409 By-Pass Lube Spin-on Fits: Mack MP7, MP8, MP10 Engines, Trucks Replaces: Mack 20843764; Volvo 20843764 Thread: 1 3/8 -16 O.D.: 4 1/4 (108.0) Height: 10 1/16 (255.6) I.Gskt: [1] Included</p> 
<p>B7402 Lube Spin-on Fits: Freightliner, Kenworth, Peterbilt Trucks all with Caterpillar C11, C13, C18 Engines Replaces: Caterpillar 249-2347 Thread: 1 1/2 -16 O.D.: 5 3/8 (136.5) Height: 8 19/32 (218.3) I.Gskt: [1] Included</p> 	<p>B7410 Lube Spin-on Contains: 40 PSID By-Pass Valve Fits: Case Compactors; Deutz Engines Replaces: Case ND103597; Deutz 1182236 Thread: 3/4 -16 O.D.: 3 1/32 (77.0) Height: 2 5/16 (58.7) I.Gskt: G449-B</p> 
<p>B7403 Lube Spin-on Contains: Anti-Drainback Valve 20 PSID By-Pass Valve Fits: Case, New Holland Wheel Loaders Replaces: Case 285451A1; Perkins 2654412 Thread: 3/4 -16 O.D.: 3 11/16 (93.7) Height: 4 3/8 (111.1) I.Gskt: G381-A</p> 	<p>P7411 Lube Element Fits: 2003-04 Cadillac CTS with V6-197 (3.2L) Engine Replaces: GMC 24415388, 88894390 O.D.: 2 1/16 (52.4) I.D.: 23/32 (18.3) One End Height: 4 (101.6) A. Gskt: [1] Attached O-Ring: [2] Included</p> 
<p>P7406 Lube Element Contains: [1] Plastic Drain Tube Fits: Toyota Light-Duty Trucks Replaces: Toyota 4152-YZZA4 O.D.: 2 11/16 (68.3) I.D.: 1 1/8 (28.6) Height: 4 5/8 (117.5) O-Ring: [2] Included Related To: P40109 (w/o Drain Plug)</p> 	<p>P7413 Lube Element Fits: Jeep, Mercedes-Benz Light-Duty Trucks, Dodge, Mercedes-Benz Sprinter Vans Replaces: Chrysler 5175571AA; Mercedes-Benz A6421800009; Fleetguard LF16231 O.D.: 2 13/16 (71.4) I.D.: 1 7/32 (31.0) Height: 3 3/4 (95.3) O-Ring: [2] Included</p> 
<p>B7407 Lube Spin-on Contains: Anti-Drainback Valve 20 PSID By-Pass Valve Fits: Hitachi, John Deere Excavators Replaces: Hitachi 4454526 Thread: M20 x 1.5 O.D.: 3 1/32 (77.0) Height: 2 25/32 (70.6) I.Gskt: [1] Included</p> 	<p>P7414 Lube Element Contains: [1] Circular Band Seal Fits: Audi Automotive Replaces: Audi 6E115562A; Wix 57204 O.D.: 2 9/16 (65.1) I.D.: 1 1/4 (31.8) Height: 6 3/32 (154.8) I.Gskt: [2] Included O-Ring: [1] Included</p> 
<p>P7408 Lube Element Fits: 2002-06 Mini Cooper, Cooper S Replaces: BMW 11427509208, 11427512466 O.D.: 2 13/16 (71.4) I.D.: 23/32 (18.3) & 1 3/32 (27.8) Height: 3 3/16 (81.0) A. Gskt: [2] Attached O-Ring: [1] Included</p> 	<p>P7415 Lube Element Fits: Audi, Volkswagen Automotive, Light-Duty Trucks Replaces: Volkswagen 71115562, 71115562A, 71115562B; ACDelco PF1708 O.D.: 2 25/32 (70.6) I.D.: 5/8 (15.9) One End Height: 5 9/16 (141.3) O-Ring: [1] Attached</p> 

Measurements Are Shown In Inches And (Millimeters)

WARNING: These products can expose you to chemicals, including Diisononyl Phthalate, Carbon black extracts, Nickel, 1,3 Butadiene, Ethylene Oxide, Epichlorohydrin, which are known to the State of California to cause cancer, and Bisphenol, Ethylene Glycol, Ethylene Oxide, 1,3 Butadiene, Epichlorohydrin, which are known to the State of California to cause birth defects or other reproductive harm. For more information go to www.P65Warnings.ca.gov.

B7416

Lube Spin-on



Contains: 14 PSID By-Pass Valve
Fits: Case Excavators
Replaces: Case 87327673; Isuzu 1-87610-006-1
Thread: 1 1/2 -12
O.D.: 4 21/32 (118.3)
Height: 8 3/32 (205.6)
I.Gskt: G498-D

P7423

Lube Element



Fits: International City Star Trucks; Workhorse Chassis all with IHC MaxxForce 5 (4.5L), VT275 (4.5L) Engines
Replaces: International 1847174-C91
O.D.: 3 5/16 (84.1)
I.D.: 1 9/16 (39.7) One End
Height: 5 15/16 (150.8)
O-Ring: [1] Included

P7417

Lube Element



Fits: Volvo Automotive
Replaces: Volvo 8642570
O.D.: 2 1/2 (63.5)
I.D.: 1 7/32 (31.0)
Height: 4 15/16 (125.4)
O-Ring: [1] Included

B7424

Lube Spin-on



Contains: Anti-Drainback Valve
 20 PSID By-Pass Valve
Fits: Jaguar Automotive
Replaces: Jaguar EAC1467
Thread: 1 -12
O.D.: 3 11/16 (93.7)
Height: 4 7/16 (112.7)
I.Gskt: G401

P7418

Lube Element



Contains: [1] Plastic Drain Plug
Fits: Lexus Automotive
Replaces: Toyota 4152-31060, 4152-YZZA5
O.D.: 2 3/4 (69.9)
I.D.: 1 3/32 (27.8)
Height: 3 7/32 (81.8)
O-Ring: [2] Included

P7426

Lube Element



Fits: BMW Automotive
Replaces: BMW 11421432097, 11421743398, 11421216192
O.D.: 2 17/32 (64.3)
I.D.: 31/32 (24.6)
Height: 4 1/32 (102.4)
F. Gskt: [1] Copper Washer
O-Ring: [3] Included

B7419

Lube Spin-on



Contains: Anti-Drainback Valve
 20 PSID By-Pass Valve
Fits: Suzuki ATVs, Motorcycles
Replaces: Suzuki 16510-03G00, 16510-06B01
Thread: M20 x 1.0
O.D.: 2 21/32 (67.5)
Height: 2 5/8 (66.7)
I.Gskt: [1] Included

P7427

Lube Element



Fits: BMW Automotive
Replaces: BMW 11427506677, 11427511161
O.D.: 2 7/8 (73.0)
I.D.: 3/8 (9.5) & 1 1/4 (31.8)
Height: 4 3/32 (104.0)
A. Gskt: [1] Attached
F. Gskt: [1] Metal Washer
O-Ring: [2] Included

B7420

Lube Spin-on



Contains: Anti-Drainback Valve
Fits: Komatsu Excavators
Replaces: Komatsu 6732-51-5141, 6732-51-5142; Fleetguard LF3915
Thread: 1 -16
O.D.: 3 11/16 (93.7)
Height: 5 3/8 (136.5)
I.Gskt: G381-A

B7428

Lube Spin-on



Contains: Anti-Drainback Valve
 25 PSID By-Pass Valve
Fits: Citroen, Fiat, Peugeot Automotive
Replaces: Peugeot 1109R0, 1109R1, 1109T0
Thread: M20 x 1.5
O.D.: 3 1/8 (79.4)
Height: 3 17/32 (89.7)
I.Gskt: [1] Included

B7422

Lube Spin-on



Contains: Anti-Drainback Valve
 20 PSID By-Pass Valve
Fits: General Motors, Suzuki Automotive
Replaces: General Motors 12640445; Suzuki 16510-78J01
Thread: M22 x 1.5
O.D.: 3 (76.2)
Height: 3 1/2 (88.9)
I.Gskt: G449-B

B7430











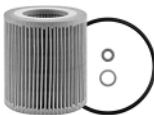

Lube Spin-on



Contains: Anti-Drainback Valve
 14 PSID By-Pass Valve
Replaces: Fiat 5984044, 71736157; Wix Europe WL7091
Thread: M20 x 1.5
O.D.: 3 1/8 (79.4)
Height: 4 1/32 (102.4)
I.Gskt: [1] Included













Measurements Are Shown In Inches And (Millimeters)

WARNING: These products can expose you to chemicals, including Diisononyl Phthalate, Carbon black extracts, Nickel, 1,3 Butadiene, Ethylene Oxide, Epichlorohydrin, which are known to the State of California to cause cancer, and Bisphenol, Ethylene Glycol, Ethylene Oxide, 1,3 Butadiene, Epichlorohydrin, which are known to the State of California to cause birth defects or other reproductive harm. For more information go to www.P65Warnings.ca.gov.

<p>B7431 Lube Spin-on Contains: Anti-Drainback Valve 16 PSID By-Pass Valve Fits: Nissan European Light-Duty Trucks Replaces: Nissan 15208-BN30A, 15208-BN300 Thread: 3/4 -16 O.D.: 3 3/4 (95.3) Height: 3 13/16 (96.8) I.Gskt: [1] Included</p> 	<p>P7437 Lube Element with Lid Fits: Ford E-Services Vans with 6.0L Diesel Engine Replaces: Wix 57313, 57323 O.D.: 3 1/4 (82.6) Lid 4 1/8 (104.8) I.D.: 1 1/2 (38.1) One End Height: 7 17/32 (191.3) Grommets: [1] Attached Related To: P7235 (without Lid)</p> 
<p>B7432 Lube Spin-on Contains: Anti-Drainback Valve 18 PSID By-Pass Valve Fits: Renault Master I European Light-Duty Trucks Replaces: Renault 8200007832 Thread: M20 x 1.5 O.D.: 3 9/16 (90.5) Height: 3 15/32 (88.1) I.Gskt: [1] Included</p> 	<p>P7438 Lube Element Fits: BMW Automotive Replaces: BMW 11427566327 O.D.: 2 7/8 (73.0) I.D.: 1 5/8 (41.3) Height: 3 1/8 (79.4) F. Gskt: [1] Metal Washer O-Ring: [2] Included</p> 
<p>B7433 Lube Spin-on Contains: Anti-Drainback Valve 14 PSID By-Pass Valve Replaces: Fiat 46805831, 71736160 Thread: 3/4 -16 O.D.: 3 1/8 (79.4) Height: 4 1/32 (102.4) I.Gskt: [1] Included</p> 	<p>B7440 Lube Spin-on Contains: Anti-Drainback Valve Fits: Komatsu Equipment Replaces: Komatsu 6733-51-5142 Thread: 1 -16 O.D.: 3 11/16 (93.7) Height: 5 3/8 (136.5) I.Gskt: G381-A</p> 
<p>B7434 Chrome Lube Spin-on Contains: 17 PSID By-Pass Valve Fits: Harley-Davidson Motorcycles Replaces: Harley-Davidson 6379677A, 6373199A Thread: 3/4 -16 O.D.: 3 1/8 (79.4) Height: 3 21/32 (92.9) I.Gskt: [1] Included</p> 	<p>B7441 Lube Spin-on Contains: Anti-Drainback Valve 14 PSID By-Pass Valve Replaces: Fiat 46544820, 71736161; Wix Europe WL7134 Thread: M20 x 1.5 O.D.: 2 23/32 (69.1) Height: 3 13/32 (86.5) I.Gskt: [1] Included</p> 
<p>B7435 By-Pass Lube Spin-on Contains: Stud Thread: M16 x 1.5 Replaces: Fleetguard LF3882 O.D.: 5 1/16 (128.6) Height: 6 31/32 (177.0) F. Gskt: G372</p> 	<p>P7442 Lube Element Fits: Chevrolet, Pontiac, Saturn Automotive Replaces: GM 12605566; ACDelco PF457G O.D.: 2 7/16 (61.9) I.D.: 1 3/8 (34.9) One End Height: 3 5/8 (92.1) I.Gskt: [1] Included O-Ring: [1] Included</p> 
<p>P7436 Lube Element with Lid Fits: Ford, IHC Trucks and Buses Replaces: Wix 57312 O.D.: 3 1/4 (82.6) Lid 4 1/8 (104.8) I.D.: 1 1/2 (38.1) One End Height: 7 11/16 (195.3) Grommets: [1] Attached Related To: P7235 (without Lid)</p> 	<p>B7443 Lube Spin-on Contains: Anti-Drainback Valve 8 PSID By-Pass Valve Fits: Chrysler, Dodge, Jeep Automotive Replaces: Chrysler 4892339AA; Mopar MO-339 Thread: M22 x 1.5 O.D.: 3 (76.2) Height: 3 1/2 (88.9) I.Gskt: G449-B</p> 
	<p>B7444 Lube Spin-on Contains: Anti-Drainback Valve 8 PSID By-Pass Valve Fits: Dodge, Jeep, Mitsubishi Light-Duty Trucks Replaces: Chrysler 5184231AA; Mopar MO231 Thread: M22 x 1.5 O.D.: 3 (76.2) Height: 4 27/32 (123.0) I.Gskt: G449-B</p> 

Measurements Are Shown In Inches And (Millimeters)

WARNING: These products can expose you to chemicals, including Diisononyl Phthalate, Carbon black extracts, Nickel, 1,3 Butadiene, Ethylene Oxide, Epichlorohydrin, which are known to the State of California to cause cancer, and Bisphenol, Ethylene Glycol, Ethylene Oxide, 1,3 Butadiene, Epichlorohydrin, which are known to the State of California to cause birth defects or other reproductive harm. For more information go to www.P65Warnings.ca.gov.

<p>B7445</p>  <p>Lube Spin-on Contains: Anti-Drainback Valve 17 PSID By-Pass Valve Fits: Antonio Carraro Equipment Replaces: Fiat 71736158, 46805832; Mann & Hummel W714/4 Thread: M20 x 1.5 O.D.: 3 1/8 (79.4) Height: 3 5/8 (92.1) I.Gskt: [1] Included</p>	<p>B7453</p>  <p>Lube Spin-on Contains: 20 PSID By-Pass Valve Integral Post Seal Fits: Kama, Taishan TS254C, TS354C Tractors Replaces: Parker China Division JX0707, WB173-S Thread: M20 x 1.5 O.D.: 3 11/16 (93.7) Height: 3 3/8 (85.7) I.Gskt: [1] Included</p>
<p>B7446</p>  <p>Lube Spin-on Replaces: Hyster 1350036; Donaldson P550047 Thread: M18 x 1.5 O.D.: 2 29/32 (73.8) Height: 3 1/2 (88.9) I.Gskt: G449-B</p>	<p>P7454</p>  <p>Lube Element Fits: Scion, Toyota Automotive Replaces: Toyota 4152-YZZA6; Wix 57064 O.D.: 2 3/8 (60.3) I.D.: 1 3/32 (27.8) Height: 2 1/4 (57.2) O-Ring: [1] Included</p>
<p>B7449</p>  <p>Lube Spin-on Contains: Anti-Drainback Valve 20 PSID By-Pass Valve Fits: Buick, Cadillac, Chevrolet, Ford, GMC, Lincoln, Mazda, Mercury Automotive, Light-Duty Trucks Replaces: Ford AA5Z-6714-A; Mazda ZZC4-23-802 Thread: M22 x 1.5 O.D.: 3 (76.2) Height: 4 3/32 (104.0) I.Gskt: G449-B</p>	<p>P7455</p>  <p>Lube Element Fits: Nissan, Opel, Renault Light-Duty Trucks Replaces: Nissan 15209-00QAA; Opel 4415941, 4506039, 93184133; Renault 7700109402, 7701472321, 8200004835 O.D.: 3 19/32 (91.3) I.D.: 1 15/32 (37.3) Height: 3 11/16 (93.7) O-Ring: [1] Included</p>
<p>P7450</p>  <p>Lube Element Fits: Mini Cooper Automotive Replaces: BMW 11427557012 O.D.: 2 9/16 (65.1) I.D.: 1 3/32 (27.8) Height: 2 23/32 (69.1) F. Gskt: [1] Brass Washer O-Ring: [1] Included</p>	<p>BC7456 KIT</p>  <p>Paper Insert Fits: Mack Trucks Replaces: Spinner II 73165, 73187 O-Ring: [2] Included</p>
<p>B7451</p>  <p>Lube Spin-on Contains: 20 PSID By-Pass Valve Integral Post Seal Fits: Foton FT404, FT504, Taishan TS554 Tractors Replaces: Parker China Division CX85100C, JX85100C, WB202C Thread: M24 x 2.0 O.D.: 3 21/32 (92.9) Height: 5 1/8 (130.2) I.Gskt: [1] Included</p>	<p>B7457</p>  <p>Lube Spin-on Notes: OBSOLETE. Availability Limited to Dealer Stock. Contains: Anti-Drainback Valve 21-28 PSID By-Pass Valve Replaces: Parker China Division WB202D; FAW-Xichai 1012010/4K Thread: 1 -12 O.D.: 3 19/32 (91.3) Height: 5 5/8 (142.9) I.Gskt: [1] Included</p>
<p>B7452</p>  <p>Lube Spin-on Contains: Threaded Stud: M27 x 1.5 Front End Check Valve 35 PSID By-Pass Valve Fits: Audi, Volkswagen Automotive Replaces: Volkswagen 6J115403C, 6J115561B; Wix 57561 O.D.: 3 1/16 (77.8) Height: 5 5/8 (142.9) I.Gskt: [1] Included</p>	<p>B7458</p>  <p>Lube Spin-on Contains: 18-20 PSID By-Pass Valve Replaces: Parker China Division WB178; Foton Lovol KM385T-09303 Thread: 3/4 -16 O.D.: 3 1/32 (77.0) Height: 4 13/16 (122.2) I.Gskt: [1] Included</p>

Measurements Are Shown In Inches And (Millimeters)

WARNING: These products can expose you to chemicals, including Diisononyl Phthalate, Carbon black extracts, Nickel, 1,3 Butadiene, Ethylene Oxide, Epichlorohydrin, which are known to the State of California to cause cancer, and Bisphenol, Ethylene Glycol, Ethylene Oxide, 1,3 Butadiene, Epichlorohydrin, which are known to the State of California to cause birth defects or other reproductive harm. For more information go to www.P65Warnings.ca.gov.

<p>B7459</p>  <p>Lube Spin-on Notes: OBSOLETE. Availability Limited to Dealer Stock. Contains: 30-42 PSID By-Pass Valve Replaces: Parker China Division WB218; Sinotruk VG1540070007; Weichai Power 610800070015 Thread: 1 1/8 -16 O.D.: 4 11/32 (110.3) Height: 10 1/4 (260.3) I.Gskt: [1] Included</p>	<p>B7483</p>  <p>Lube Spin-on Contains: 30-42 PSID By-Pass Valve Replaces: Yuchai Watyuan M30001012240A Thread: 1 1/8 -16 O.D.: 4 9/32 (108.7) Height: 6 7/32 (158.0) I.Gskt: [1] Included</p>
<p>B7461</p>  <p>Lube Spin-on Contains: 32-40 PSID By-Pass Valve Replaces: FAW-Xichai 101201036D; Mann & Hummel W950/31 Thread: 1 -12 O.D.: 3 19/32 (91.3) Height: 6 5/8 (168.3) I.Gskt: [1] Included</p>	<p>BC7485</p>  <p>Centrifugal Lube Element Fits: IHC MaxxFer 9, MaxxFer 10, MaxxFer 11, MaxxFer 13 Engines, ProStar, 4400 DuraStar, 7400 WorkStar, 7500 WorkStar, 7600 WorkStar Trucks Replaces: International 2606467-C91 O.D.: 3 11/16 (93.7) I.D.: 1/4 (6.4) One End Height: 5 13/16 (147.6) O-Ring: [1] Included Related To: BC7326 (Different O-Ring)</p>
<p>B7467</p>  <p>Lube Spin-on Contains: Anti-Drainback Valve 8 PSID By-Pass Valve Standpipe Fits: J.C. Bamford Equipment Replaces: J.C. Bamford 2/100284, 2/100284A Thread: 3/4 -16 O.D.: 3 11/16 (93.7) Height: 5 3/8 (136.5) A. Gskt: [1] Included</p>	<p>B7486</p>  <p>Lube Spin-on Contains: Anti-Drainback Valve 30 PSID By-Pass Valve Fits: J.C. Bamford, Hitachi, John Deere, Kobelco, New Holland Excavators Replaces: Isuzu 8-98075-676-0; J.C. Bamford 32/926119; SF-Filter SP4959 Thread: 3/4 -16 O.D.: 3 13/16 (96.8) Height: 5 29/32 (150.0) I.Gskt: [1] Included</p>
<p>B7468</p>  <p>Lube Spin-on Contains: By-Pass Valve Replaces: FAW-Xichai 1012015155YT50W; Parker China Division JX1017 Thread: 1 1/8 -16 O.D.: 4 3/8 (111.1) Height: 8 11/32 (211.9) I.Gskt: [1] Included</p>	<p>B7487</p>  <p>Lube Spin-on Contains: Anti-Drainback Valve 20 PSID By-Pass Valve Fits: Case, Komatsu, Takeuchi, Yanmar Engines, Equipment Replaces: Atlas Copco 2914920000; Isuzu 5864015150; Komatsu YM12915035153; Yanmar 12915035153 Thread: M20 x 1.5 O.D.: 3 1/32 (77.0) Height: 3 7/16 (87.3) I.Gskt: [1] Included</p>
<p>B7469</p>  <p>Lube Spin-on Contains: Anti-Drainback Valve 20 PSID By-Pass Valve Replaces: Huafeng Power JX0810; ShanDong Huayuan Laidong Engine JX0810; Parker China Division JX0810 Thread: M20 x 1.5 O.D.: 3 19/32 (91.3) Height: 5 1/8 (130.2) I.Gskt: [1] Included</p>	<p>P7488</p>  <p>Lube Element Fits: 2008-on Land Rover LR2; 2007-on Volvo S80, XC90, 2008-10 V70, 2008-on XC70, 2009-on XC60, 2011-on S60 Replaces: Land Rover LR001419; Volvo 3075001-3 O.D.: 3 9/32 (83.3) I.D.: 1 11/16 (42.9) Height: 4 1/32 (102.4) O-Ring: [1] Included</p>
<p>B7477</p>  <p>Lube Spin-on Contains: 18-20 PSID By-Pass Valve Replaces: Weichai Power JX1010; Parker China Division JX1010 Thread: M24 x 2.0 O.D.: 4 1/4 (108.0) Height: 5 9/32 (134.1) I.Gskt: [1] Included</p>	<p>P7489</p>  <p>Lube Element Fits: Chevrolet Aveo; Pontiac G3; Saturn Astra Replaces: Fiat 71744410; General Motors 93185674; Opel 5650359 O.D.: 2 1/4 (57.2) I.D.: 5/8 (15.9) & 13/16 (20.6) Height: 4 3/16 (106.4) A. Gskt: [1] Included F. Gskt: [1] Included</p>

Measurements Are Shown In Inches And (Millimeters)

WARNING: These products can expose you to chemicals, including Diisononyl Phthalate, Carbon black extracts, Nickel, 1,3 Butadiene, Ethylene Oxide, Epichlorohydrin, which are known to the State of California to cause cancer, and Bisphenol, Ethylene Glycol, Ethylene Oxide, 1,3 Butadiene, Epichlorohydrin, which are known to the State of California to cause birth defects or other reproductive harm. For more information go to www.P65Warnings.ca.gov.

P7490 Lube Element
Contains: 30 PSID By-Pass Valve
Fits: Suzuki ATVs
Replaces: Suzuki 16510-24501, 16510-25000, 16510-25C00; Arctic Cat 3436-005
O.D.: 1 23/32 (43.7)
I.D.: 17/32 (13.5) One End
Height: 2 3/16 (55.6)
O-Ring: [2] Included

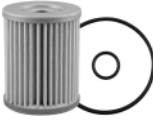

B7491 Lube Spin-on
Contains: 14 PSID By-Pass Valve
Fits: Ford, Mercury Automotive, Light-Duty Trucks
Replaces: Ford 1S7Z-6731-DA, BE8Z-6731-AB; Motorcraft EFL910, FL910, FL910S
Thread: 3/4 -16
O.D.: 3 (76.2)
Height: 3 17/32 (89.7)
I.Gskt: [1] Included



P7492 Lube Element
Fits: Chrysler, Dodge, Jeep, Ram Automotive, Light-Duty Trucks
Replaces: Chrysler 68079744AA, 68079744AB; Mopar MO744
O.D.: 2 1/16 (52.4)
I.D.: 5/8 (15.9) & 7/8 (22.2)
Height: 5 13/32 (137.3)
O-Ring: [1] Included



P7493 Lube Element
Fits: Mercedes-Benz Automotive
Replaces: Mercedes-Benz 1803109, A0001802609; Mahle OX345DECO
O.D.: 2 9/16 (65.1)
I.D.: 1 7/32 (31.0)
Height: 4 17/32 (115.1)
O-Ring: [5] Included



P7494 Lube Element
Fits: Caterpillar, IHC Trucks with MaxxForce 11, MaxxForce 13 Engines
Replaces: Caterpillar 3809364; International 3007498C92, 3007543C92, 3015784C1
O.D.: 4 23/32 (119.9)
I.D.: 1 3/4 (44.4) & 2 3/32 (53.2)
Height: 7 5/8 (193.7)
O-Ring: [1] Attached, [2] Included

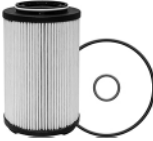

P7495 Lube Element in Plastic Housing
Notes: P40062 (Element only)
Fits: Iveco Trucks; Case-International Steiger, New Holland Equipment
Replaces: Iveco 2996416, 500054654, 504213801; New Holland 504213800, 87495056; Hengst H311W
Element
O.D.: 4 3/32 (104.0) to 4 3/8 (111.1)
I.D.: 1 9/16 (39.7) One End
Height: 12 21/32 (321.5)
O-Ring: [1] Attached
Housing
O.D.: 5 13/32 (111.9)
I.D. Thread: S125x4
Height: 13 3/4 (349.3)



B7496 Lube Spin-on
Contains: Anti-Drainback Valve
40 PSID By-Pass Valve
Fits: Iveco Trucks
Replaces: Iveco 2995811, 504091563; Fiat 8094872
Thread: M22 x 1.5
O.D.: 3 11/16 (93.7)
Height: 2 13/16 (71.4)
I.Gskt: G381-A



B7497 Lube Spin-on
Replaces: DongFeng Cummins Engine Co. 1012BF11-025; Parker China Division WPPA01102
Thread: 1 1/8 -16
O.D.: 3 5/8 (92.1)
Height: 7 1/8 (181.0)
I.Gskt: [1] Included



B7499 Lube Spin-on
Contains: Anti-Drainback Valve
30 PSID By-Pass Valve
Standpipe
Fits: Case Loaders; Case-International Tractors
Replaces: Case 87679496; Iveco 504182581
Thread: M27 x 2.0
O.D.: 3 11/16 (93.7)
Height: 3 7/8 (98.4)
I.Gskt: G381-A



F7500 Fuel Element with Bail Handle
Fits: 750 Housings
O.D.: 7 11/16 (195.3)
I.D.: 7/8 (22.2)
Height: 15 3/32 (383.4)
O. Gskt: ES1067, ES1068, ES1376, ES1377, G155, G157, G238, G252, G309-B
Related To: C750-E, C750-L, C750-L SINGLE (Depth-Pack or Vac-Cel By-Pass Lube Versions)



Measurements Are Shown In Inches And (Millimeters)

WARNING: These products can expose you to chemicals, including Diisononyl Phthalate, Carbon black extracts, Nickel, 1,3 Butadiene, Ethylene Oxide, Epichlorohydrin, which are known to the State of California to cause cancer, and Bisphenol, Ethylene Glycol, Ethylene Oxide, 1,3 Butadiene, Epichlorohydrin, which are known to the State of California to cause birth defects or other reproductive harm. For more information go to www.P65Warnings.ca.gov.

P7500 By-Pass Lube Element with Bail Handle
Fits: 750 Housings
O.D.: 7 11/16 (195.3)
I.D.: 7/8 (22.2)
Height: 15 3/32 (383.4)
O. Gskt: ES1067, ES1068, ES1376, ES1377, G155, G157, G238, G252, G309-B
Related To: C750-E, C750-L, C750-L SINGLE (Depth-Pack or Vac-Cel By-Pass Lube Versions)

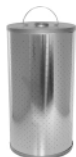

P7505 Lube Element
Contains: Offset By-Pass Valve
Fits: Freightliner Cascadia, Century Class S/T, Columbia, Coronado, Business Class M2, Sterling L-Line, L-Line 9500, Western Star 4900EX, 4900FA, 4900SA Trucks all with Detroit Diesel DD13, DD15 or DD16 Eng
Replaces: Detroit Diesel A4721800109, A4721800309; Mercedes-Benz A4721800309, A4721840525; Donaldson P551005
O.D.: 4 3/4 (120.7)
I.D.: 2 (50.8) One End
Height: 10 7/16 (265.1)
A. Gskt: [1] Attached
F. Gskt: [1] Copper Washer
O-Ring: [1] Included



B7501 Lube Spin-on
Contains: 35 PSID By-Pass Valve
Fits: Fendt Tractors
Replaces: Agco F934201510320; Deutz 1182947; Fendt F934201510320; Mann & Hummel W1110228
Thread: 1 1/8 -16
O.D.: 4 1/4 (108.0)
Height: 10 1/16 (255.6)
I.Gskt: [1] Included



B7506 Lube Spin-on
Fits: International MaxxForce 7 Engines, DuraStar, TerraStar, TransStar Trucks
Replaces: International 1899332-C91; 1893553-C2
Thread: 1 -16
O.D.: 4 9/32 (108.7)
Height: 8 3/4 (222.3)
I.Gskt: [1] Included



P7502 Lube Element
Fits: Scania Engines, Trucks
Replaces: Scania 1742037, 2022275; Fleetguard LF17486; Hengst E123HD194; Mahle OX562DECO; Mann HU10771X
O.D.: 3 9/16 (90.5)
I.D.: 1 3/4 (44.4) One End
Height: 11 1/8 (282.6)
O-Ring: [1] Included



B7507 High Efficiency Lube Spin-on
Fits: IHC MaxxForce 15 Engine, ProStar Truck
Replaces: Case-International 3014491C91
Thread: 1 1/2 -16
O.D.: 5 3/8 (136.5)
Height: 12 3/32 (307.2)
I.Gskt: [1] Included
O-Ring: [3] Included
Related To: B7299 (w/o O-Rings)



B7503 Lube Spin-on
Contains: 60 PSID By-Pass Valve
Fits: International MaxxForce DT, MaxxForce 9, MaxxForce 10 Engines, DuraStar, WorkStar Trucks; Spartan ERV Series Fire Truck Chassis
Replaces: International Harvester 1884508-C1, 1884508-C2, 1889124-C91
Thread: 1 3/4 -12
O.D.: 4 9/16 (115.9)
Height: 11 13/32 (289.7)
I.Gskt: [1] Included



P7508 Lube Element
Fits: IHC MaxForce 11, MaxxForce 13 Engines; LoneStar, Prostar, 7600 WorkStar, 7700 WorkStar, 8600 WorkStar, 8600 TranStar Trucks
Replaces: International 3006874C91
O.D.: 4 3/4 (120.7)
I.D.: 2 (50.8) One End
Height: 8 3/32 (205.6)
A. Gskt: [1] Attached
O-Ring: [2] Included



BD7504 High Velocity Dual-Flow Lube Spin-on
Replaces: Cummins 4906635; Fleetguard LF9039
Thread: 2 1/4 -12
O.D.: 4 21/32 (118.3)
Height: 11 13/32 (289.7)
I.Gskt: [1] Included













BD7509 High Velocity Dual-Flow Lube Spin-on
Contains: Venturi-Type Cone
Fits: Equipment with Various Cummins ISM11, QSX15 Series Engines
Replaces: Cummins 4906633; Fleetguard LF9031
Thread: M95 x 2.5
O.D.: 4 11/16 (119.1)
Height: 11 25/32 (299.2)
I.Gskt: [1] Included
Related To: BD7154 (Nitrile Gasket)













Measurements Are Shown In Inches And (Millimeters)

WARNING: These products can expose you to chemicals, including Diisononyl Phthalate, Carbon black extracts, Nickel, 1,3 Butadiene, Ethylene Oxide, Epichlorohydrin, which are known to the State of California to cause cancer, and Bisphenol, Ethylene Glycol, Ethylene Oxide, 1,3 Butadiene, Epichlorohydrin, which are known to the State of California to cause birth defects or other reproductive harm. For more information go to www.P65Warnings.ca.gov.

<p>P7510 Lube Element</p>  <p>Fits: Hino P11C Engine Replaces: Hino S156072430 O.D.: 4 3/16 (106.4) I.D.: 19/32 (15.1) & 2 (50.8) Height: 7 3/8 (187.3) A. Gskt: [1] Attached F. Gskt: [1] Metal Washer O-Ring: [3] Included Grommets: [1] Attached</p>	<p>B7516 Lube Spin-on</p>  <p>Contains: 20 PSID By-Pass Valve Fits: John Deere Gen Set Power Units with PowerTech (4.5L) & (6.8L) Engine Replaces: John Deere RE506178; Fleetguard LF3941 Thread: 1 1/2 -16 O.D.: 3 3/4 (95.3) Height: 5 3/4 (146.0) F. Gskt: [1] Included</p>
<p>B7511 Lube Spin-on</p>  <p>Contains: Anti-Drainback Valve 14 PSID By-Pass Valve Fits: Bobcat, Ingersoll-Rand Compactors Replaces: Ingersoll-Rand 54477104 Thread: 3/4 -16 O.D.: 3 11/16 (93.7) Height: 3 1/4 (82.6) I.Gskt: [1] Included</p>	<p>P7517 Lube Element</p>  <p>Fits: Jeep Grand Cherokee; Ram 1500 Pickups Replaces: Chrysler 68109834AA O.D.: 2 19/32 (65.9) I.D.: 3/4 (19.0) One End Height: 4 7/8 (123.8) O-Ring: [1] Attached, [1] Included</p>
<p>P7512 Lube Element</p>  <p>Replaces: Hino S156072440 O.D.: 4 25/32 (121.4) I.D.: 5/8 (15.9) Height: 8 21/32 (219.9) F. Gskt: [5] Included</p>	<p>BF7519 Stainless Steel Screen In-Line Fuel Filter</p>  <p>Contains: [2] Rubber Seals [2] Brass Fittings Fits: Case-International, John Deere Tractors Replaces: Case A184963; John Deere AR103220 O.D.: 1 29/32 (48.4) Inlet: 5/8-24 Outlet: 5/8-24 Length: 3 17/32 (89.7)</p>
<p>B7513 Lube Spin-on</p>  <p>Fits: Hino Engines, Trucks Replaces: Hino 15613E0030 Thread: 1 1/2 -16 O.D.: 4 21/32 (118.3) Height: 8 3/32 (205.6) I.Gskt: [1] Included</p>	<p>BF7522 Fuel Element with Drain</p>  <p>Fits: Ford (Europe) Trucks Replaces: Ford 6164913, 844F-9176-CAB O.D.: 3 1/2 (88.9) I.D.: 5/8 (15.9) One End Height: 6 11/32 (161.1) A. Gskt: [1] Attached</p>
<p>P7514 Lube Element</p>  <p>Notes: OBSOLETE. Availability Limited to Dealer Stock. Fits: Caterpillar C175-16, C175-20 Gen Set Replaces: Caterpillar 2492340, 3680066 O.D.: 7 13/32 (188.1) I.D.: 3 13/32 (86.5) Height: 13 21/32 (346.9) A. Gskt: [2] Attached</p>	<p>BF7528 Fuel Spin-on with Drain</p>  <p>Fits: Kubota, Thomas Equipment Replaces: Kubota 70000-43170 Thread: M20 x 1.5 O.D.: 3 11/16 (93.7) Height: 4 11/16 (119.1) I.Gskt: G324-A</p>
<p>P7515 Lube Element</p>  <p>Fits: Hyundai, Kia Automotive Replaces: Hyundai 263203CAA0; Kia 263203CAA0 O.D.: 2 19/32 (65.9) I.D.: 27/32 (21.4) & 1 3/32 (27.8) Height: 4 25/32 (121.4) A. Gskt: [1] Included F. Gskt: [1] Metal Washer O-Ring: [1] Included</p>	<p>BF7529 Fuel Spin-on</p>  <p>Notes: Can be used with FB46185 base. Contains: Integral Post Seal Fits: Mitsubishi Trucks Replaces: Mitsubishi ME035394 Thread: 1 -14 O.D.: 3 11/16 (93.7) Height: 6 11/16 (169.9) I.Gskt: G401</p>

Measurements Are Shown In Inches And (Millimeters)

WARNING: These products can expose you to chemicals, including Diisononyl Phthalate, Carbon black extracts, Nickel, 1,3 Butadiene, Ethylene Oxide, Epichlorohydrin, which are known to the State of California to cause cancer, and Bisphenol, Ethylene Glycol, Ethylene Oxide, 1,3 Butadiene, Epichlorohydrin, which are known to the State of California to cause birth defects or other reproductive harm. For more information go to www.P65Warnings.ca.gov.

<p>BF7531 Fuel Spin-on Contains: Integral Post Seal Fits: International Engines Replaces: International 1820479-C1 Thread: 7/8 -14 O.D.: 3 (76.2) Height: 5 7/8 (149.2) I.Gskt: G449-B</p> 	<p>BF7538 Fuel Spin-on Contains: Integral Post Seal Fits: Caterpillar Equipment Replaces: Caterpillar 517951 Thread: M20 x 1.5 O.D.: 3 11/16 (93.7) Height: 4 3/8 (111.1) I.Gskt: G324-A</p> 
<p>BF7532 Fuel/Water Separator Spin-on with Threaded Port Notes: Inside-Out Flow Direction Contains: Port Thread: M36 x 1.5 Fits: Nissan Trucks Replaces: Nissan 16403-05E01, 16403-59E00, 16405-05E01 Thread: 3/4 -16 O.D.: 3 9/16 (90.5) Height: 5 7/16 (138.1) I.Gskt: G381-A F. Gskt: [1] Included</p> 	<p>BF7541 Fuel Spin-on Fits: Kobelco, MDI/Yutani Equipment Replaces: Kobelco 2451U309-2 Thread: 3/4 -16 O.D.: 3 11/16 (93.7) Height: 3 1/4 (82.6) I.Gskt: G324-A</p> 
<p>BF7534 Fuel/Water Separator Spin-on with Threaded Port Notes: Inside-Out Flow Direction Contains: Port Thread: M36 x 1.5 Fits: Chevrolet, Dodge, GMC, Isuzu, Mitsubishi Automotive, Light-Duty Trucks; Toro Lawn & Garden Tractors Replaces: GMC 13240032; Isuzu 8-94483-850-0; Mitsubishi MB228988; Toro 60-5470 Thread: M20 x 1.5 O.D.: 3 9/16 (90.5) Height: 5 7/16 (138.1) I.Gskt: G381-A F. Gskt: [2] Included</p> 	<p>BF7544 Fuel Spin-on Fits: Hino Engines; Kobelco Loaders Replaces: Hino 23401-1381 Thread: M20 x 1.5 O.D.: 3 1/32 (77.0) Height: 4 3/32 (104.0) I.Gskt: [1] Included</p> 
<p>BF7535 Fuel/Water Separator Spin-on with Threaded Port Notes: Inside-Out Flow Direction Contains: Port Thread: M36 x 1.5 Fits: Nissan, Toyota Automotive; Toyota Lift Trucks Replaces: Nissan 16403-G9900; Toyota 23303-56040 Thread: 3/4 -16 O.D.: 3 9/16 (90.5) Height: 5 7/16 (138.1) I.Gskt: G381-A O-Ring: [1] Included</p> 	<p>PF7545 Fuel Element Fits: Bolens, Case, Ford, International, New Holland, White Tractors Replaces: Bolens 1876440; Ford SBA360720020; International 1273082-C1 O.D.: 1 1/8 (28.6) I.D.: 17/32 (13.5) One End Height: 2 9/32 (57.9)</p> 
<p>BF7537 Can-Type Fuel Filter Replaces: Mazda SL07-23-570 O.D.: 3 7/16 (87.3) I.D.: 3/4 (19.0) & 1 1/8 (28.6) Height: 3 13/32 (86.5) F. Gskt: [2] Included O-Ring: [3] Included</p> 	<p>BF7546 Fuel/Water Separator Spin-on with Drain Notes: CAUTION: Furnished D-Ring must be installed on threaded bushing before installing filter on D60E-7, D65E-7 and D75S-3 machines with NH220 or NT855 engines. Do NOT use on other Komatsu engines. Can be used with FB46185 base. Contains: Integral Post Seal Fits: Hitachi, Komatsu Equipment Replaces: Hitachi 4192631; Komatsu 600-311-8292 Thread: 1 -14 O.D.: 3 11/16 (93.7) Height: 6 31/32 (177.0) I.Gskt: G401 F. Gskt: ES24-D</p> 
	<p>PF7549 Fuel Element Fits: Isuzu Engines Replaces: Isuzu 5-87810-197-0 O.D.: 1 11/16 (42.9) I.D.: 15/32 (11.9) Height: 1 25/32 (45.2) F. Gskt: [3] Included</p> 

Measurements Are Shown In Inches And (Millimeters)

WARNING: These products can expose you to chemicals, including Diisononyl Phthalate, Carbon black extracts, Nickel, 1,3 Butadiene, Ethylene Oxide, Epichlorohydrin, which are known to the State of California to cause cancer, and Bisphenol, Ethylene Glycol, Ethylene Oxide, 1,3 Butadiene, Epichlorohydrin, which are known to the State of California to cause birth defects or other reproductive harm. For more information go to www.P65Warnings.ca.gov.

PF7550 Fuel Element

Fits: Hino Buses, Trucks
Replaces: Hino 23401-1060
O.D.: 2 15/32 (62.7)
I.D.: 13/32 (10.3)
Height: 2 17/32 (64.3)
F. Gskt: [2] Included
Grommets: [2] Attached

PF7551 Fuel Element

Fits: Hino Equipment, Trucks; Hitachi Equipment
Replaces: Hino 23401-1040; Hitachi 4020429
O.D.: 2 7/8 (73.0)
I.D.: 17/32 (13.5) & 19/32 (15.1)
Height: 4 7/32 (107.2)
F. Gskt: ES1049, [1] Included
End Seals: [1] Attached
Grommets: [1] Attached

BF7552 Fuel Spin-on

Contains: Integral Post Seal
Fits: Caterpillar, Daewoo, Komatsu, Takeuchi, Yanmar Equipment; Mitsubishi Engines
Replaces: Caterpillar 94-7073; Mitsubishi ME006066
Thread: M20 x 1.5
O.D.: 3 11/16 (93.7)
Height: 2 27/32 (72.2)
A. Gskt: [1] Included

PF7553 Fuel Element

Fits: Nissan Trucks
Replaces: Nissan 16444-99026, 16444-99028
O.D.: 4 3/8 (111.1)
I.D.: 9/16 (14.3) & 1 (25.4)
Height: 5 1/2 (139.7)
I.Gskt: [2] Included
F. Gskt: [1] Included, [1] Washer

PF7554 Fuel Element

Fits: Nissan Trucks
Replaces: Nissan 16444-90027, 16444-99128
O.D.: 3 19/32 (91.3)
I.D.: 9/16 (14.3)
Height: 5 19/32 (142.1)
F. Gskt: [1] Included

PF7556 Fuel Element

Replaces: Nissan 16444-Z9027
O.D.: 3 19/32 (91.3)
I.D.: 9/16 (14.3)
Height: 6 5/8 (168.3)
F. Gskt: [1] Included
Grommets: [1] Included

BF7557 Extended Life Fuel Spin-on

Notes: CAUTION: Furnished D-Ring must be installed on post for seal.
 Can be used with FB1311 base.
Fits: Allis Chalmers, Taylor, Versatile Equipment; Cummins Engines
Replaces: Cummins 3300901
Thread: 1 -14
O.D.: 3 11/16 (93.7)
Height: 7 1/8 (181.0)
I.Gskt: G381-A
F. Gskt: ES24-D
Related To: BF948, BF957 (Short, Standard Versions)
 BF7558 (Long Version)

BF7558 Extended Life Fuel Spin-on

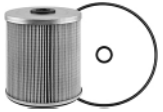
Notes: CAUTION: Furnished D-Ring must be installed on post for seal.
 Can be used with FB1311 base.
Thread: 1 -14
O.D.: 3 11/16 (93.7)
Height: 8 23/32 (221.5)
I.Gskt: G381-A
F. Gskt: ES24-D
Related To: BF948, BF957 (Short, Standard Versions)
 BF7557 (Short Version)

BF7559 Fuel Spin-on

Fits: Isuzu Engines
Replaces: Isuzu X13240-024
Thread: 3/4 -16
O.D.: 3 11/16 (93.7)
Height: 4 3/8 (111.1)
I.Gskt: G381-A

BF7571 Fuel Spin-on

Fits: Fuel Dispensing Pumps
Replaces: Cim-Tek 700-19, 800-10
Thread: 1 1/2 -16
O.D.: 5 1/16 (128.6)
Height: 10 3/4 (273.1)
F. Gskt: G369-B
O. Gskt: G286-C, G369-V, G372, G447, G483, G704, G710

PF7572 Fuel Element

Contains: Reinforced Centertube
Fits: Hino Tractors, Trucks; Hitachi Equipment
Replaces: Hino 23401-1020; Hitachi 4143271
O.D.: 3 15/16 (100.0)
I.D.: 19/32 (15.1) & 21/32 (16.7)
Height: 4 7/32 (107.2)
F. Gskt: [2] Included
End Seals: [1] Attached
Grommets: [1] Attached

Measurements Are Shown In Inches And (Millimeters)

WARNING: These products can expose you to chemicals, including Diisononyl Phthalate, Carbon black extracts, Nickel, 1,3 Butadiene, Ethylene Oxide, Epichlorohydrin, which are known to the State of California to cause cancer, and Bisphenol, Ethylene Glycol, Ethylene Oxide, 1,3 Butadiene, Epichlorohydrin, which are known to the State of California to cause birth defects or other reproductive harm. For more information go to www.P65Warnings.ca.gov.

BF7576 Box-Style Fuel Coalescer
Fits: Thermo King Refrigeration Units
Replaces: Thermo King 11-6286
Length: 4 21/32 (118.3)
Width: 2 27/32 (72.2)
Height: 2 15/32 (62.7)



BF7586 Fuel Storage Tank Spin-on
Contains: Water Absorbent Media
Fits: Various Fuel Islands
Replaces: Cim-Tek 400HS-10, 700-17
Thread: 1 1/2 -16
O.D.: 3 11/16 (93.7)
Height: 5 9/16 (141.3)
I.Gskt: [1] Included



B7577 By-Pass Lube Spin-on
Notes: Can be used with OB1308 base.
Fits: Caterpillar, Cummins, GMC Engines
Replaces: Caterpillar 9Y4468; Cummins 3304232; Ford E3HZ-6731-A; GMC 25011187
Thread: 1 3/8 -16
O.D.: 4 11/16 (119.1)
Height: 9 15/16 (252.4)
I.Gskt: G498-D



BF7587 High Efficiency Fuel Spin-on
Notes: Can be used with FB46185 base.
Fits: Caterpillar Engines, Equipment; Ford, Freightliner, International, Kenworth, Peterbilt, Sterling, Western Star Trucks
Replaces: Caterpillar 1R0749
Thread: 1 -14
O.D.: 3 11/16 (93.7)
Height: 10 1/2 (266.7)
I.Gskt: G381-A
Related To: BF614 (Standard Version) BF7633 (Short Version)



BF7579 Box-Style Fuel Filter
Fits: Thermo King Refrigeration Units
Replaces: Thermo King 11-6285
Length: 4 21/32 (118.3)
Width: 2 27/32 (72.2)
Height: 2 15/32 (62.7)



PF7588 Fuel Element
Fits: Hitachi, Komatsu Equipment
Replaces: Hitachi 4091472; Komatsu 600-311-8210
O.D.: 2 7/8 (73.0)
I.D.: 9/16 (14.3)
Height: 4 11/32 (110.3)
A. Gskt: [2] Attached
F. Gskt: [2] Included



BF7580 Box-Style Fuel Filter
Fits: Thermo King Refrigeration Units
Replaces: Thermo King 11-7264
Length: 4 21/32 (118.3)
Width: 2 27/32 (72.2)
Height: 2 15/32 (62.7)



BF7591-D Fuel/Water Separator Spin-on with Drain
Fits: Case, Hanomag, International Equipment
Replaces: Hanomag 114924144; International 1967094-C1
Thread: M16 x 1.5
O.D.: 3 1/32 (77.0)
Height: 6 1/8 (155.6)
A. Gskt: G449-B



BF7584 Fuel/Water Separator Spin-on with Drain
Contains: Integral Post Seal
Fits: International Engines
Replaces: International 1808623-C1
Thread: 7/8 -14
O.D.: 4 1/4 (108.0)
Height: 8 17/32 (216.7)
I.Gskt: G401
Related To: BF7629 (Fuel Version without Drain)



PF7592 Fuel Element
Fits: Mitsubishi Equipment, Trucks
Replaces: Mitsubishi 30062-65101, ME971550
O.D.: 3 19/32 (91.3)
I.D.: 9/16 (14.3)
Height: 5 3/8 (136.5)
F. Gskt: [3] Included
Grommets: [2] Attached



B7585 Lube Spin-on
Contains: Anti-Drainback Valve
14 PSID By-Pass Valve
Fits: Isuzu Engines
Replaces: Isuzu 8-97024-607-0, 8-97024-607-1
Thread: M20 x 1.5
O.D.: 4 1/4 (108.0)
Height: 5 27/32 (148.4)
I.Gskt: [1] Included
F. Gskt: [2] Included



BF7593 Fuel Spin-on
Contains: Integral Post Seal
Fits: Iveco Buses, Trucks
Replaces: Iveco 1901607
Thread: 3/4 -16
O.D.: 4 1/4 (108.0)
Height: 3 15/16 (100.0)
I.Gskt: G381-A



Measurements Are Shown In Inches And (Millimeters)

WARNING: These products can expose you to chemicals, including Diisononyl Phthalate, Carbon black extracts, Nickel, 1,3 Butadiene, Ethylene Oxide, Epichlorohydrin, which are known to the State of California to cause cancer, and Bisphenol, Ethylene Glycol, Ethylene Oxide, 1,3 Butadiene, Epichlorohydrin, which are known to the State of California to cause birth defects or other reproductive harm. For more information go to www.P65Warnings.ca.gov.

PF7594 Fuel Element
Fits: Belarus Tractors
Replaces: Belarus A6501100-10
O.D.: 3 23/32 (94.5)
I.D.: 13/32 (10.3) One End
Height: 4 3/4 (120.7)
Grommets: [1] Attached



B7600-SS Severe Service Full-Flow Lube Spin-on
Notes: DISCONTINUED. Replaced by B76-SS.
Fits: Caterpillar Engines, Equipment
Replaces: Caterpillar 1R0739
Thread: 1 1/8 -16
O.D.: 4 1/4 (108.0)
Height: 10 1/16 (255.6)
I.Gskt: [1] Included
Related To: B76, B76-MPG, B76-SS
 B7700 (High Performance Version)



PF7595 Fuel Element
Fits: Belarus Tractors
Replaces: Belarus 501117030A
O.D.: 2 1/16 (52.4)
I.D.: 13/32 (10.3)
Height: 4 7/8 (123.8)
Grommets: [2] Attached



BF7602 Fuel Spin-on
Contains: Integral Post Seal
Fits: Case, Hitachi, Kawasaki, Koehring, Link-Belt Equipment; Chevrolet, GMC, Isuzu Trucks
Replaces: Hitachi 4206080; Isuzu 1-13240-079-1; Link-Belt 3H1750
Thread: 3/4 -16
O.D.: 3 11/16 (93.7)
Height: 4 3/8 (111.1)
I.Gskt: G324-A



PF7596 Fuel Element
Fits: Iveco, M.A.N., R.V.I. Buses, Trucks; Perkins Engines
Replaces: M.A.N. A50.00241.676; Renault 854975700
O.D.: 2 9/16 (65.1)
I.D.: 9/16 (14.3)
Height: 2 3/32 (53.2)
F. Gskt: [1] Included



BF7606 Fuel Spin-on
Fits: Volvo Equipment
Replaces: Volvo 795210
Thread: 1 -12
O.D.: 3 11/16 (93.7)
Height: 7 3/16 (182.6)
I.Gskt: G401



PF7597 Fuel/Water Separator Element
Fits: Luber-finer F170 Housings
Replaces: Luber-finer 4666
O.D.: 4 1/2 (114.3)
I.D.: 7/8 (22.2)
Height: 8 3/16 (208.0)
A. Gskt: [2] Attached
F. Gskt: [1] Included



P7607 Lube Element
Fits: M.A.N. Trucks
Replaces: M.A.N. 85.48386, 81.05504.0037
O.D.: 3 7/32 (81.8)
I.D.: 1 1/16 (27.0)
Height: 5 31/32 (151.6)
A. Gskt: [2] Attached



BF7598 Fuel Spin-on with Threaded Sensor Port
Contains: Port Thread: M10 x 1.5
Fits: Nissan Automotive, Light-Duty Trucks; Komatsu, Nissan Lift Trucks
Replaces: Komatsu 600-311-9620; Nissan 16405-34W25
Thread: 3/4 -16
O.D.: 3 5/16 (84.1)
Height: 4 5/8 (117.5)
I.Gskt: [1] Included



BF7608 Fuel Spin-on
Notes: CAUTION: Furnished O-Ring must be installed on post for seal.
Fits: Ford Buses, Trucks; New Holland Equipment
Replaces: Ford E7HZ-9365-B
Thread: M16 x 1.5
O.D.: 3 1/32 (77.0)
Height: 4 3/32 (104.0)
I.Gskt: [1] Included
O-Ring: [1] Included



B7600 Full-Flow Lube Spin-on
Notes: DISCONTINUED. Replaced by B76.
Fits: Caterpillar Engines, Equipment
Replaces: Caterpillar 1R0739
Thread: 1 1/8 -16
O.D.: 4 1/4 (108.0)
Height: 10 1/16 (255.6)
I.Gskt: [1] Included
Related To: B76, B76-MPG, B76-SS
 B7700 (High Efficiency Version)



Measurements Are Shown In Inches And (Millimeters)

WARNING: These products can expose you to chemicals, including Diisononyl Phthalate, Carbon black extracts, Nickel, 1,3 Butadiene, Ethylene Oxide, Epichlorohydrin, which are known to the State of California to cause cancer, and Bisphenol, Ethylene Glycol, Ethylene Oxide, 1,3 Butadiene, Epichlorohydrin, which are known to the State of California to cause birth defects or other reproductive harm. For more information go to www.P65Warnings.ca.gov.

BF7612 Fuel Spin-on
Contains: Integral Post Seal
Fits: Detroit Diesel Engines
Replaces: Fleetguard FF5227
Thread: 13/16 -12
O.D.: 4 1/4 (108.0)
Height: 7 5/8 (193.7)
I.Gskt: G381-A
Related To: BF7613 (Long Version)



PF7618 Fuel Element
Fits: Isuzu, Nissan Trucks
Replaces: Nissan 16444-97001
O.D.: 4 11/32 (110.3)
I.D.: 19/32 (15.1) & 2 1/32 (51.6)
Height: 8 9/32 (210.3)
A. Gskt: [1] Attached
F. Gskt: [3] Copper Washers, [1] Gasket
O-Ring: [1] Included
Grommets: [1] Attached



BF7613 Fuel Spin-on
Contains: Integral Post Seal
Fits: Detroit Diesel Engines
Thread: 13/16 -12
O.D.: 4 1/4 (108.0)
Height: 10 7/16 (265.1)
I.Gskt: G381-A
Related To: BF7612 (Short Version)



BF7619 Fuel Spin-on
Contains: Integral Post Seal
Fits: Mercedes-Benz Automotive
Replaces: Mercedes-Benz 10922201, 10922301
Thread: M12 x 1.5
O.D.: 3 3/8 (85.7)
Height: 3 13/16 (96.8)
I.Gskt: [2] Included
F. Gskt: [2] Included



BF7614 Fuel Spin-on
Notes: Inside-Out Flow Direction
Fits: Nissan Buses, Trucks
Replaces: Nissan 16403-05D00, FL403-05D00
Thread: 3/4 -16
O.D.: 3 11/16 (93.7)
Height: 5 3/8 (136.5)
I.Gskt: [1] Included
F. Gskt: [1] Included



BF7623 Fuel Storage Tank Spin-on
Fits: Fuel Dispensing Pumps
Replaces: Cim-Tek 700-20, 800-30
Thread: 1 1/2 -16
O.D.: 5 1/16 (128.6)
Height: 10 3/4 (273.1)
F. Gskt: G369-B
O. Gskt: G369-V, G704, G710



P7615 Dual-Flow Lube Element with Bail Handle
Fits: Mercedes-Benz Automotive, Light-Duty Trucks
Replaces: Mercedes-Benz 6011800009, 6011800109, 6011800210
O.D.: 3 9/16 (90.5)
I.D.: 15/32 (11.9) & 31/32 (24.6)
Height: 6 11/16 (169.9)
F. Gskt: [3] Included
Grommets: [2] Attached



BF7624 Fuel Spin-on
Fits: Scania Trucks
Replaces: Scania 1361685, 1372444
Thread: M24 x 1.5
O.D.: 3 11/16 (93.7)
Height: 5 9/16 (141.3)
I.Gskt: G401



PT7616 Hydraulic Element
Fits: Caterpillar Excavators
Replaces: Caterpillar 5W5803
O.D.: 4 5/8 (117.5)
I.D.: 2 5/16 (58.7)
Height: 6 21/32 (169.1)
A. Gskt: [2] Attached



BF7625 In-Line Fuel Filter
Contains: [2] 19/32 Inch Plastic Fittings
Fits: Toyota Light-Duty Trucks
Replaces: Toyota 23300-79535
O.D.: 2 11/32 (59.5)
Inlet: 1/4
Outlet: 1/4
Length: 2 31/32 (75.4)
F. Gskt: [2] Included



PT7617 Hydraulic Element
Replaces: Hyster 376066
O.D.: 4 (101.6)
I.D.: 1 1/4 (31.8) & 1 9/16 (39.7)
Height: 18 29/32 (480.2)
Grommets: [1] Attached













PF7627 Fuel Element
Fits: Dodge Light-Duty Trucks, Vans
Replaces: Chrysler 4864307
O.D.: 5 (127.0)
I.D.: 3 9/32 (83.3) One End
Height: 1 3/4 (44.4)















Measurements Are Shown In Inches And (Millimeters)

WARNING: These products can expose you to chemicals, including Diisononyl Phthalate, Carbon black extracts, Nickel, 1,3 Butadiene, Ethylene Oxide, Epichlorohydrin, which are known to the State of California to cause cancer, and Bisphenol, Ethylene Glycol, Ethylene Oxide, 1,3 Butadiene, Epichlorohydrin, which are known to the State of California to cause birth defects or other reproductive harm. For more information go to www.P65Warnings.ca.gov.

<p>BF7628 Fuel Spin-on Contains: Integral Post Seal Fits: Carrier Refrigeration Units Replaces: Carrier 30-01090-01 Thread: 1 -14 O.D.: 4 5/16 (109.5) Height: 5 29/32 (150.0) I.Gskt: [1] Included</p> 	<p>BF7634 High Efficiency Fuel Spin-on Fits: Caterpillar Engines Replaces: Caterpillar 1R0759 Thread: 7/8 -14 O.D.: 3 (76.2) Height: 7 1/8 (181.0) I.Gskt: [1] Included</p> 
<p>BF7629 Fuel Spin-on Contains: Integral Post Seal Fits: Terex Equipment; Detroit Diesel, International Engines Replaces: International 1822588-C1 Thread: 7/8 -14 O.D.: 4 1/4 (108.0) Height: 7 (177.8) I.Gskt: G401 Related To: BF7584 (Fuel/Water Separator Version with Drain)</p> 	<p>BF7635 High Efficiency Fuel/Water Separator Spin-on with Drain Contains: Integral Post Seal Fits: Mining Applications in Cold Weather Thread: 1 3/8 -16 O.D.: 5 3/8 (136.5) Height: 10 9/16 (268.3) I.Gskt: [1] Included</p> 
<p>BF7630 In-Line Fuel Filter Contains: [2] Nuts [1] Plastic Retainer Clip Fits: Saturn Automotive Replaces: Saturn 21007437, 21007438 O.D.: 2 5/32 (54.8) Inlet: 3/8 Outlet: 3/8 Length: 16 15/16 (430.2)</p> 	<p>BF7637 High Performance Fuel Spin-on Fits: Caterpillar Equipment Replaces: Caterpillar 1R0750 Thread: 1 -14 O.D.: 3 1/32 (77.0) Height: 7 1/8 (181.0) A. Gskt: G449-B</p> 
<p>BF7631 High Efficiency Fuel Spin-on Contains: Integral Post Seal Fits: Caterpillar Equipment Replaces: Caterpillar 1R0753 Thread: 7/8 -14 O.D.: 3 11/16 (93.7) Height: 10 1/2 (266.7) I.Gskt: G381-A</p> 	<p>BF7639 High Efficiency Fuel Spin-on Contains: Integral Post Seal Fits: Caterpillar Equipment, Industrial and Marine Engines Replaces: Caterpillar 1R0755 Thread: 1 3/8 -16 O.D.: 5 3/8 (136.5) Height: 12 3/32 (307.2) I.Gskt: [1] Included</p> 
<p>BF7632 High Efficiency Fuel Spin-on Contains: Integral Post Seal Fits: Caterpillar Engines, Equipment Replaces: Caterpillar 1R0751 Thread: 7/8 -14 O.D.: 3 11/16 (93.7) Height: 7 1/8 (181.0) I.Gskt: G381-A</p> 	<p>BF7639-D High Efficiency Fuel Spin-on with Drain Contains: Integral Post Seal Fits: Mining Applications Using Davco Mega Filter Replaces: GMC 23512631 Thread: 1 3/8 -16 O.D.: 5 3/8 (136.5) Height: 12 7/16 (315.9) I.Gskt: [1] Included</p> 
<p>BF7633 High Efficiency Fuel Spin-on Fits: Caterpillar Equipment Replaces: Caterpillar 1R0750 Thread: 1 -14 O.D.: 3 11/16 (93.7) Height: 7 1/8 (181.0) I.Gskt: G381-A Related To: BF7587 (Long Version)</p> 	

Measurements Are Shown In Inches And (Millimeters)

WARNING: These products can expose you to chemicals, including Diisononyl Phthalate, Carbon black extracts, Nickel, 1,3 Butadiene, Ethylene Oxide, Epichlorohydrin, which are known to the State of California to cause cancer, and Bisphenol, Ethylene Glycol, Ethylene Oxide, 1,3 Butadiene, Epichlorohydrin, which are known to the State of California to cause birth defects or other reproductive harm. For more information go to www.P65Warnings.ca.gov.

<p>BF7640 Fuel Spin-on Contains: Integral Post Seal Fits: John Deere Equipment Replaces: John Deere RE61552, RE501113 Thread: 13/16 -12 O.D.: 3 11/16 (93.7) Height: 6 5/8 (168.3) I.Gskt: [1] Included</p> 	<p>BF7656 Primary Fuel Spin-on Contains: Integral Post Seal Fits: Mack Engines, Trucks Replaces: Mack 483GB470M Thread: M22 x 1.5 O.D.: 4 1/4 (108.0) Height: 7 19/32 (192.9) I.Gskt: [1] Included</p> 
<p>BF7644 Fuel Spin-on Contains: Integral Post Seal Fits: Volvo Engines Replaces: Volvo 420799 Thread: M18 x 1.5 O.D.: 3 11/16 (93.7) Height: 8 1/8 (206.4) I.Gskt: G381-A</p> 	<p>BF7657 Secondary Fuel Spin-on Contains: Integral Post Seal Fits: Mack Engines, Trucks Replaces: Mack 483GB471M Thread: M30 x 1.5 O.D.: 4 1/4 (108.0) Height: 10 7/16 (265.1) I.Gskt: [1] Included</p> 
<p>BF7645 Fuel Storage Tank Spin-on Fits: Fuel Tanks Replaces: Cim-Tek 400-10, 700-15 Thread: 1 1/2 -16 O.D.: 3 3/4 (95.3) Height: 5 9/16 (141.3) I.Gskt: [1] Included</p> 	<p>BF7658 In-Line Fuel Filter Contains: [1] Plastic Retainer Clip Fits: GMC, Isuzu Light-Duty Trucks Replaces: GMC 25168594; Isuzu 8-25168-594-0 O.D.: 2 9/32 (57.9) Inlet: M16 x 1.5 Outlet: 3/8 Length: 5 3/8 (136.5)</p> 
<p>BF7648 Fuel Spin-on Fits: GMC, Isuzu Trucks; Komatsu, Link-Belt Equipment Replaces: GMC 97718401; Isuzu 5-87310-335-0 Thread: 3/4 -16 O.D.: 3 1/32 (77.0) Height: 3 1/2 (88.9) I.Gskt: [1] Included</p> 	<p>BF7659 In-Line Fuel Filter Fits: Chrysler, Dodge, Eagle, Mitsubishi Automotive Replaces: GMC 25313814; Mitsubishi MR188221 O.D.: 2 17/32 (64.3) Inlet: M12 x 1 1/4 Outlet: M12 x 1 1/4 Length: 3 31/32 (100.8) F. Gskt: [4] Metal Washers</p> 
<p>BF7653 Fuel Spin-on Contains: Integral Post Seal Fits: Volvo, WhiteGMC Trucks Replaces: Volvo 8193841 Thread: M18 x 1.5 O.D.: 3 11/16 (93.7) Height: 8 1/8 (206.4) I.Gskt: G381-A</p> 	<p>BF7661 In-Line Fuel Filter Fits: Lexus, Toyota Automotive Replaces: Toyota 23300-20040 O.D.: 2 9/16 (65.1) Inlet: M14 x 1.5 Outlet: 5/16 Length: 4 3/16 (106.4)</p> 
<p>PF7655 Fuel Element Contains: Reinforced Centertube Fits: Caterpillar Engines Replaces: Caterpillar 1R0718, 1R0756 O.D.: 3 15/16 (100.0) I.D.: 1 5/8 (41.3) Height: 9 7/32 (234.2) A. Gskt: [2] Attached</p> 	<p>BF7662 In-Line Fuel Filter Fits: 1995-99 Toyota Paseo, Tercel Replaces: General Motors Corp. 25313812; Toyota 23300-11150, 23300-19385; Wix 33554, 533878, 33878 O.D.: 2 9/16 (65.1) Inlet: M14 x 1.5 Outlet: M12 x 1.25 Length: 3 15/16 (100.0) F. Gskt: [4] Metal Washers</p> 

Measurements Are Shown In Inches And (Millimeters)

WARNING: These products can expose you to chemicals, including Diisononyl Phthalate, Carbon black extracts, Nickel, 1,3 Butadiene, Ethylene Oxide, Epichlorohydrin, which are known to the State of California to cause cancer, and Bisphenol, Ethylene Glycol, Ethylene Oxide, 1,3 Butadiene, Epichlorohydrin, which are known to the State of California to cause birth defects or other reproductive harm. For more information go to www.P65Warnings.ca.gov.

BF7663	<p>Fuel Spin-on Fits: Iveco EuroCargo, EuroStar, EuroTech, EuroTrakker Series Trucks Replaces: Iveco 1907640 Thread: M16 x 1.5 O.D.: 3 1/32 (77.0) Height: 5 27/32 (148.4) I.Gskt: G449-B</p>
BF7664	<p>Fuel Spin-on Fits: DAF Trucks Replaces: DAF 1318695 Thread: M16 x 1.5 O.D.: 3 11/16 (93.7) Height: 5 3/8 (136.5) I.Gskt: G381-A</p>
BF7666	<p>Fuel/Water Separator Spin-on Fits: Isuzu Engines; Link-Belt Backhoes Replaces: Isuzu 8-94453-738-1, 8-94453-738-2 Thread: 3/4 -16 O.D.: 3 11/16 (93.7) Height: 3 1/4 (82.6) I.Gskt: G324-A</p>
BF7667	<p>In-Line Fuel Filter Contains: [1] Plastic Retainer Clip Fits: Cadillac Automotive Replaces: GMC 25163684 O.D.: 2 5/32 (54.8) Inlet: 3/8 Outlet: M14 x 1.5 Length: 5 13/32 (137.3)</p>
BF7668	<p>In-Line Fuel Filter Contains: [2] 3/8 Inch Clips Fits: Ford, Jaguar, Lincoln, Mazda, Mercury Automotive, Light-Duty Trucks Replaces: Ford F89Z-9155-A O.D.: 2 7/32 (56.4) Inlet: 5/16 Outlet: 5/16 Length: 7 3/32 (180.2) Related To: BF7768 (5/16 In. Clips)</p>
BF7669	<p>In-Line Fuel Filter Contains: 5/16 Inch Return Line Steel Braided Ground Wire Fits: Chrysler Vans Replaces: Chrysler 4682569, 4809117, 4809117-AB O.D.: 1 29/32 (48.4) Inlet: 3/8 Outlet: 5/16 Length: 30 (762.0)</p>
BF7670	<p>In-Line Fuel Filter Fits: Audi, Volkswagen Automotive Replaces: Volkswagen 1J020151A O.D.: 3 7/32 (81.8) Inlet: 5/16 Outlet: 5/16 Length: 6 15/16 (176.2)</p>

BF7671	<p>In-Line Fuel Filter Contains: 5/16 Inch Return Line Fits: Chrysler Automotive Replaces: Chrysler 4764210 O.D.: 2 11/32 (59.5) Inlet: 3/8 Outlet: 5/16 Length: 8 11/32 (211.9)</p>
BF7672-D	<p>Primary Fuel/Water Coalescer Element with Drain Notes: Tab/Keys are not needed for installation. Fits: Caterpillar, John Deere Equipment Use With: BF7673-D, BF7674-D Replaces: Caterpillar 131-1812; John Deere RE53729, RE62421; Donaldson P550398; Fleetguard FS19554 O.D.: 3 9/32 (83.3) I.D.: 21/32 (16.7) One End Height: 5 31/32 (151.6) Grommets: [1] Attached</p>
BF7673-D	<p>Secondary Fuel/Water Coalescer Element with Drain Notes: Tab/Keys are not needed for installation. Fits: John Deere Engines, Equipment Use With: BF7672-D Replaces: John Deere RE50455, RE58367, RE62418; Donaldson P550351; Fleetguard FS19516 O.D.: 3 9/32 (83.3) I.D.: 21/32 (16.7) One End Height: 5 7/32 (132.6) F. Gskt: [1] Included Grommets: [1] Attached</p>
BF7674-D	<p>Secondary Fuel/Water Separator Element with Drain Notes: Tab/Keys are not needed for installation. Fits: Caterpillar, Perkins Engines; John Deere Equipment Use With: BF7672-D, BF7681-D Replaces: Caterpillar 100-5593, 138-3098, 159-6102; GMC 12554082; John Deere RE52987, RE53400, RE62419, RE509031 O.D.: 3 9/32 (83.3) I.D.: 21/32 (16.7) One End Height: 5 31/32 (151.6) F. Gskt: [1] Included Grommets: [1] Attached</p>
BF7675-D	<p>Secondary Fuel/Water Separator Element with Drain Notes: Tab/Keys are not needed for installation. Fits: John Deere Power Tech Engines Replaces: John Deere RE60021; Fleetguard FS19573 O.D.: 3 9/32 (83.3) I.D.: 21/32 (16.7) One End Height: 4 15/32 (113.5) Grommets: [1] Attached</p>

Measurements Are Shown In Inches And (Millimeters)

WARNING: These products can expose you to chemicals, including Diisononyl Phthalate, Carbon black extracts, Nickel, 1,3 Butadiene, Ethylene Oxide, Epichlorohydrin, which are known to the State of California to cause cancer, and Bisphenol, Ethylene Glycol, Ethylene Oxide, 1,3 Butadiene, Epichlorohydrin, which are known to the State of California to cause birth defects or other reproductive harm. For more information go to www.P65Warnings.ca.gov.

BF7677-D Secondary Fuel/Water Separator Element with Drain



Notes: Tab/Keys are not needed for installation.
Fits: Case-IH, Challenger, Massey Ferguson, New Holland Tractors; Caterpillar, John Deere Equipment
Replaces: John Deere RE62420; Stanadyne 32179
O.D.: 3 9/32 (83.3)
I.D.: 21/32 (16.7) One End
Height: 7 5/8 (193.7)
Grommets: [1] Attached

BF7682-D Primary Fuel/Water Coalescer Element with Drain



Notes: Tab/Keys are not needed for installation.
Fits: John Deere, Timberjack Equipment
Replaces: John Deere RE62423, RE65431; Timberjack 431892, F431892
O.D.: 3 9/32 (83.3)
I.D.: 21/32 (16.7) One End
Height: 7 5/8 (193.7)
Grommets: [1] Attached

PF7678 Fuel Element with Lid



Notes: Lid Accepts 1/2 In. Square Driver
Fits: Ford Light-Duty Trucks, Vans
Replaces: Ford F4TZ-9N184-A, F4TZ-9N184-B
O.D.: 3 17/32 (89.7)
 Lid 4 7/8 (123.8)
I.D.: 9/16 (14.3) One End
Height: 4 17/32 (115.1)
O-Ring: [1] Attached
Grommets: [1] Attached

BF7683 Fuel Spin-on



Fits: Kubota Engines, Equipment
Replaces: Kubota 70000-43081
Thread: M20 x 1.5
O.D.: 3 (76.2)
Height: 3 1/2 (88.9)
I.Gskt: G449-B

BF7679-D Primary Fuel/Water Coalescer Element with Drain



Notes: Tab/Keys are not needed for installation.
Fits: Caterpillar, John Deere Equipment
Replaces: Caterpillar 117-4089; John Deere RE62424
O.D.: 3 9/32 (83.3)
I.D.: 21/32 (16.7) One End
Height: 5 31/32 (151.6)
Grommets: [1] Attached

B7685 By-Pass Lube Spin-on



Fits: R.V.I., Volvo Buses, Engines, Equipment, Trucks
Replaces: V.M.E. 119962280; Volvo 477556, 477556-5
Thread: 1 3/8 -16
O.D.: 4 1/4 (108.0)
Height: 10 1/16 (255.6)
I.Gskt: [1] Included

PF7680 Fuel/Water Separator Element



Fits: Caterpillar, Cummins, Detroit Diesel, Mack Engines with Davco Housing
Replaces: Davco 380087; Detroit Diesel 23514049; Mack 301SD19A, 301SD19B
O.D.: 3 3/4 (95.3)
I.D.: 21/32 (16.7) One End
Height: 7 1/32 (178.6)
O-Ring: ES3012, G445
O. Gskt: G717 (for Webb Housing)
Grommets: [1] Attached

BF7686 In-Line Fuel Filter



Fits: Kawasaki Motorcycles, Mules
Replaces: Kawasaki 490191055
O.D.: 1 7/16 (36.5)
Inlet: 5/16
Outlet: 5/16
Length: 3 27/32 (97.6)

BF7681-D Primary Fuel/Water Coalescer Element with Drain



Notes: Tab/Keys are not needed for installation.
Fits: Caterpillar, Perkins Engines; New Holland Tractors
Use With: BF7674-D
Replaces: Caterpillar 100-6374, 138-3100; New Holland 87840591
O.D.: 3 9/32 (83.3)
I.D.: 21/32 (16.7) One End
Height: 5 7/32 (132.6)
Grommets: [1] Attached

PF7687 Fuel Element



Fits: Late Model Detroit Diesel Engines Equipped with Davco Fuel Filters
Replaces: Detroit Diesel 23519978, 23521527
O.D.: 3 7/16 (87.3)
I.D.: 21/32 (16.7) One End
Height: 4 23/32 (119.9)
F. Gskt: [4] Included
Grommets: [1] Attached

BF7690 Steel Screen In-Line Fuel Strainer



Fits: John Deere Tractors
Replaces: John Deere RE38818
O.D.: 1 31/32 (50.0)
Inlet: 9/16-18
Outlet: 9/16-18
Length: 3 23/32 (94.5)

BF7691 In-Line Fuel Filter



Fits: GMC Motor Homes with Portable Fuel Storage Tanks
Replaces: GMC 25055347
O.D.: 2 (50.8)
Inlet: 1/2
Outlet: 1/2
Length: 4 7/16 (112.7)

Measurements Are Shown In Inches And (Millimeters)

WARNING: These products can expose you to chemicals, including Diisononyl Phthalate, Carbon black extracts, Nickel, 1,3 Butadiene, Ethylene Oxide, Epichlorohydrin, which are known to the State of California to cause cancer, and Bisphenol, Ethylene Glycol, Ethylene Oxide, 1,3 Butadiene, Epichlorohydrin, which are known to the State of California to cause birth defects or other reproductive harm. For more information go to www.P65Warnings.ca.gov.

BF7693

Steel Screen In-Line Fuel Strainer
Fits: Case-International, John Deere, Komatsu Equipment
Replaces: Case 194199A1; Komatsu 20704-A1100
O.D.: 1 29/32 (48.4)
Inlet: 1/2
Outlet: 1/2
Length: 4 1/4 (108.0)



B7700

High Efficiency Lube Spin-on
Fits: Caterpillar Engines, Equipment
Replaces: Caterpillar 1R1807
Thread: 1 1/8 -16
O.D.: 4 1/4 (108.0)
Height: 10 1/16 (255.6)
I.Gskt: [1] Included
Related To: B76, B76-MPG, B76-SS (Standard Versions)



BF7695

Resin Ribbon Fuel Coalescer Spin-on with Drain
Fits: Cummins Natural Gas Engines
Replaces: Cummins 3606712, 3607140
Thread: 1 1/2 -16
O.D.: 3 11/16 (93.7)
Height: 7 3/16 (182.6)
I.Gskt: [1] Included



BF7711

In-Line Fuel Filter
Contains: 3/8 Inch Quick Connect [1] Plastic Clip
Fits: Jeep Grand Cherokee
Replaces: Chrysler 52100283AC
O.D.: 2 5/32 (54.8)
Inlet: 5/16
Outlet: 3/8
Length: 6 3/4 (171.5)



BF7696

Fuel Spin-on
Fits: Iveco EuroTech Trucks with Cursor Engine
Replaces: Iveco 2991585
Thread: M16 x 1.5
O.D.: 3 11/16 (93.7)
Height: 8 1/8 (206.4)
I.Gskt: G381-A
Related To: BF7919 (Short Version)



BF7713

In-Line Fuel Filter
Fits: Dodge Light-Duty Trucks, Vans
Replaces: Chrysler 4443452, 4443454, 4549712
O.D.: 2 1/8 (54.0)
Inlet: 5/16
Outlet: 5/16
Length: 4 13/16 (122.2)



BF7697

High Efficiency Fuel Spin-on
Contains: Integral Post Seal
Fits: Detroit Diesel Engines
Replaces: Detroit Diesel 23518529, 25013535
Thread: 1 1/16 -16
O.D.: 4 21/32 (118.3)
Height: 9 1/2 (241.3)
I.Gskt: [1] Included



PF7715

Fuel Element
Fits: Railroad Applications
Replaces: Alco 1831113-2, 2321946; Clark FA1
O.D.: 5 1/16 (128.6)
I.D.: 11/16 (17.5) One End
Height: 11 7/8 (301.6)
A. Gskt: [1] Included
Spring: [1] Attached



PF7698

Fuel Element with Lid
Notes: Lid Accepts 1/2 In. Square Driver
Fits: Ford Light-Duty Trucks
Replaces: Ford F81Z-9N184-AA
O.D.: 3 27/32 (97.6)
Lid: 4 7/8 (123.8)
I.D.: 9/16 (14.3) One End
Height: 3 9/16 (90.5)
I.Gskt: [2] Included
Grommets: [1] Attached



PF7716

Fuel Element
Fits: Railroad Applications
Replaces: Alco 1831112-2; Clark FA2
O.D.: 5 1/16 (128.6)
I.D.: 11/16 (17.5) One End
Height: 20 15/16 (531.8)
A. Gskt: [1] Attached
Spring: [1] Attached



BF7699-D

Primary Fuel/Water Coalescer Element with Drain
Notes: Reverse Flow
 Tab/Keys are not needed for installation.
Fits: Barber Greene, Caterpillar Equipment
Replaces: Caterpillar 151-2409; Stanadyne 33748
O.D.: 3 9/32 (83.3)
I.D.: 21/32 (16.7) One End
Height: 5 7/32 (132.6)
Grommets: [1] Attached













BF7717

Secondary Fuel Spin-on
Fits: John Deere Equipment
Replaces: John Deere RE502204, RE506428
Thread: 7/8 -14
O.D.: 4 13/32 (111.9)
Height: 5 29/32 (150.0)
I.Gskt: [1] Included













Measurements Are Shown In Inches And (Millimeters)

WARNING: These products can expose you to chemicals, including Diisononyl Phthalate, Carbon black extracts, Nickel, 1,3 Butadiene, Ethylene Oxide, Epichlorohydrin, which are known to the State of California to cause cancer, and Bisphenol, Ethylene Glycol, Ethylene Oxide, 1,3 Butadiene, Epichlorohydrin, which are known to the State of California to cause birth defects or other reproductive harm. For more information go to www.P65Warnings.ca.gov.

<p>PF7718 Fuel Element  Replaces: Fleetguard FS19559 O.D.: 4 11/32 (110.3) I.D.: 2 1/32 (16.7) One End Height: 6 1/2 (165.1) O-Ring: [1] Included Grommets: [1] Attached Related To: PF7749 (Maximum Performance Glass Media Version)</p>	<p>PF7733 Fuel/Water Separator Element  Replaces: Fleetguard FS1011; Donaldson P550447 O.D.: 4 11/32 (110.3) I.D.: 2 1/32 (16.7) One End Height: 6 7/16 (163.5) O-Ring: [1] Included Grommets: [1] Attached Related To: PF7734 (Maximum Performance Media Version)</p>
<p>BF7719 In-Line Fuel Filter  Contains: [1] Plastic Clip Fits: Buick, Chevrolet, Oldsmobile, Pontiac Vans Replaces: GMC 10290491 O.D.: 1 15/16 (49.2) Inlet: 3/8 Outlet: 3/8 Length: 5 25/32 (146.8)</p>	<p>PF7734 Maximum Performance Fuel/Water Separator Element  Replaces: Fleetguard FS1020 O.D.: 4 11/32 (110.3) I.D.: 2 1/32 (16.7) Height: 6 1/2 (165.1) O-Ring: [1] Included Grommets: [1] Attached Related To: PF7733 (Standard Media Version)</p>
<p>BF7720 In-Line Fuel Filter  Fits: Geo, Suzuki Automotive Replaces: Suzuki 15430-50G00 O.D.: 2 15/16 (74.6) Inlet: 5/16 Outlet: 5/16 Length: 4 25/32 (121.4)</p>	<p>PF7735 Fuel Element  Fits: Claas, Demag, Grove Equipment; Freightliner, Sterling Trucks; Mercedes-Benz Engines, Trucks Replaces: Mercedes-Benz A0000901551, A9060920305 O.D.: 3 5/8 (92.1) I.D.: 1 3/32 (27.8) Height: 4 1/16 (103.2) O-Ring: [1] Included</p>
<p>BF7721 In-Line Fuel Filter  Fits: Acura Automotive Replaces: Honda 16900-SD4-671 O.D.: 3 13/32 (86.5) Inlet: M14 x 1.5 Outlet: M12 x 1 1/4 Length: 4 1/4 (108.0) F. Gskt: [2] Copper Washers</p>	<p>BF7736 In-Line Fuel Filter  Fits: Bomag, Case, New Holland Equipment Replaces: Wix 33002 O.D.: 2 1/8 (54.0) Inlet: 5/16 Outlet: 5/16 Length: 3 21/32 (92.9) Related To: BF840, BF840-K1 (Metal Versions)</p>
<p>BF7725 Nylon Screen In-Line Fuel Filter  Fits: Mercedes-Benz Automotive Replaces: Atlas Copco 29148002; John Deere AL78988; Mercedes-Benz 14772101, 14776901 O.D.: 1 13/32 (35.7) Inlet: 5/16 Outlet: 5/16 Length: 4 5/32 (105.6)</p>	<p>BF7736-K1 Fuel Element in Plastic Housing  Contains: [4] Clips [2] Hoses Replaces: Fiaam FT4648B; Woodgate WGF149-PK O.D.: 2 1/8 (54.0) Inlet: 5/16 Outlet: 1/4 Height: 4 11/16 (119.1)</p>
<p>BF7726 In-Line Fuel Filter  Contains: [2] Bleeder Plugs Reverse Flow Valve at Inlet Fits: Allis Chalmers, Case, Continental, Hercules, Massey Ferguson, Oliver, Waukesha Equipment Replaces: Case A57228; GMC 2449298 O.D.: 3 13/16 (96.8) Inlet: 1/4-18 Outlet: 1/4-18 Length: 6 13/32 (162.7)</p>	<p>BF7742 In-Line Fuel Filter  Contains: 5/16 Inch Return Line Fits: Ford, Mercury Light-Duty Trucks Replaces: Ford 2L2Z-9155-AB O.D.: 2 1/4 (57.2) Inlet: 3/8 Outlet: 3/8 Length: 7 (177.8)</p>

Measurements Are Shown In Inches And (Millimeters)

WARNING: These products can expose you to chemicals, including Diisononyl Phthalate, Carbon black extracts, Nickel, 1,3 Butadiene, Ethylene Oxide, Epichlorohydrin, which are known to the State of California to cause cancer, and Bisphenol, Ethylene Glycol, Ethylene Oxide, 1,3 Butadiene, Epichlorohydrin, which are known to the State of California to cause birth defects or other reproductive harm. For more information go to www.P65Warnings.ca.gov.

<p>PF7744</p> 	<p>Fuel/Water Separator Element Fits: Freightliner, International, Kenworth, Peterbilt, Sterling, Volvo Trucks Replaces: Caterpillar 4176217; Detroit Diesel 23521528; General Motors 23521528; Fleetguard FF5369, FF5369W O.D.: 3 3/4 (95.3) I.D.: 21/32 (16.7) One End Height: 6 29/32 (175.4) O-Ring: G445 O. Gskt: G717 End Seals: ES3012 Grommets: [1] Attached</p>	<p>PF7749</p>  <p>Maximum Performance Fuel/Water Separator Element Fits: Fleetguard FH23000, FH23001, FH23002, FH23003, FH23300, FH23301 Assemblies Replaces: Fleetguard FS1021, FS19557 O.D.: 4 23/32 (119.9) I.D.: 21/32 (16.7) One End Height: 6 15/32 (164.3) O-Ring: [1] Included Grommets: [1] Attached Related To: PF7718 (Standard Media Version)</p>
<p>BF7745-D</p> 	<p>Secondary Fuel/Water Separator Element with Drain Notes: Reverse Flow Tab/Keys are not needed for installation. Fits: Ford, New Holland Equipment Replaces: New Holland 87801434 O.D.: 3 9/32 (83.3) I.D.: 21/32 (16.7) One End Height: 4 15/32 (113.5) Grommets: [1] Attached</p>	<p>BF7750</p>  <p>Fuel Spin-on Fits: Various Fuel Pumps Replaces: Petro Clear 40510P Thread: 1 -12 O.D.: 3 11/16 (93.7) Height: 5 5/8 (142.9) I.Gskt: G381-A</p>
<p>BF7746-D</p> 	<p>Secondary Fuel/Water Separator Element with Drain Notes: Reverse Flow Tab/Keys are not needed for installation. Fits: Case, Caterpillar, New Holland Equipment Replaces: Ford YC15-9176-AA; Stanadyne 34470, 35332 O.D.: 3 9/32 (83.3) I.D.: 21/32 (16.7) One End Height: 7 5/8 (193.7) Grommets: [1] Attached</p>	<p>PF7751</p>  <p>Fuel/Water Separator Element with Lid Fits: Dodge Light-Duty Trucks with 5.9L Turbo Diesel Engine Replaces: Chrysler 4883963AC; Cummins 3990130; Fleetguard FS19598 O.D.: 3 19/32 (91.3) Lid 4 1/8 (104.8) I.D.: 1 1/8 (28.6) Height: 4 5/16 (109.5) F. Gskt: [2] Included Grommets: [1] Attached</p>
<p>BF7747</p> 	<p>Fuel Spin-on Fits: DAF Trucks Replaces: DAF 1345335; Fleetguard FF5366 Thread: M22 x 1.5 O.D.: 3 11/16 (93.7) Height: 5 5/8 (142.9) I.Gskt: G381-A</p>	<p>BF7753</p>  <p>High Efficiency Fuel Spin-on Fits: Caterpillar Engines, Equipment, Trucks Replaces: Caterpillar 1R0762 Thread: 1 -14 O.D.: 3 11/16 (93.7) Height: 10 1/2 (266.7) I.Gskt: [1] Included</p>
<p>PF7748</p> 	<p>Fuel/Water Separator Element Contains: Relief Valve Fits: Davco Fuel Pro Replaces: Detroit Diesel 23529168; Davco 382114 O.D.: 3 3/4 (95.3) I.D.: 21/32 (16.7) One End Height: 7 1/32 (178.6) O-Ring: ES3012, G402, G445 Included Grommets: [1] Attached</p>	<p>PF7755</p>  <p>Fuel/Water Separator Element Contains: Relief Valve Fits: Caterpillar, Cummins Engines; International, Kenworth, Peterbilt, Volvo Trucks Replaces: Davco 382116; Donaldson P550737; Fleetguard FS19729 O.D.: 3 3/4 (95.3) I.D.: 21/32 (16.7) One End Height: 7 1/32 (178.6) F. Gskt: ES3012, G402, G445 Grommets: [1] Attached</p>
	<p>BF7756</p>  <p>In-Line Fuel Element Contains: 13/32 Inch Return Fits: Mercedes-Benz Trucks Replaces: Mercedes-Benz 6110920201, A6110920201 O.D.: 3 19/32 (91.3) Inlet: 3/8 Outlet: 15/32 Height: 5 (127.0) O-Ring: [1] Attached</p>	

Measurements Are Shown In Inches And (Millimeters)

WARNING: These products can expose you to chemicals, including Diisononyl Phthalate, Carbon black extracts, Nickel, 1,3 Butadiene, Ethylene Oxide, Epichlorohydrin, which are known to the State of California to cause cancer, and Bisphenol, Ethylene Glycol, Ethylene Oxide, 1,3 Butadiene, Epichlorohydrin, which are known to the State of California to cause birth defects or other reproductive harm. For more information go to www.P65Warnings.ca.gov.

PF7758 Fuel Element

Fits: Mitsubishi Engines
Replaces: Mitsubishi ME036459, ME036478; Donaldson P550054
O.D.: 3 5/8 (92.1)
I.D.: 19/32 (15.1)
Height: 4 11/32 (110.3)
F. Gskt: [1] Included
Grommets: [2] Attached

BF7763 In-Line Fuel Filter

Contains: 5/16 Inch Return Line Ground Wire
Fits: Chrysler, Dodge Automotive
Replaces: Chrysler 4809118AC, 4809118AD
O.D.: 1 31/32 (50.0)
Inlet: 3/8
Outlet: 5/16
Length: 24 (609.6)

BF7759 Stainless Steel Mesh Fuel Strainer with Drain

Contains: 200 Mesh Media
Fits: GMC Trucks; Detroit Diesel Engines
Replaces: GMC 15152281; Racor S6484
Thread: 1 -12
O.D.: 3 11/16 (93.7)
Height: 7 13/32 (188.1)
I.Gskt: [1] Included

BF7765 In-Line Fuel Filter

Contains: Mounting Bracket with M8 x 1 1/4 Threaded Stud
Fits: Ford, Mazda Light-Duty Trucks
Replaces: Ford 1L5E-9155-BA, 2L5Z-9155-AA
O.D.: 3 5/8 (92.1)
Inlet: 5/16
Outlet: 5/16
Length: 6 5/8 (168.3)

BF7760 Wire Mesh Fuel Spin-on

Fits: International, Kenworth, Peterbilt Trucks with ISX Engine
Replaces: Cummins 4010476; Fleetguard FF2203
Thread: 1 -14
O.D.: 3 11/16 (93.7)
Height: 5 11/16 (144.5)
I.Gskt: G401
O-Ring: [1] Included

BF7766 Fuel Spin-on

Fits: Cummins ISX Series Engines; International, Kenworth, Mack, Peterbilt, Volvo Trucks
Replaces: Cummins 4088272; Fleetguard FF2200
Thread: M72 x 2.0
O.D.: 3 23/32 (94.5)
Height: 9 5/32 (232.6)
I.Gskt: [1] Included

PF7761 Fuel Element

Fits: Demag, Grove Equipment; Freightliner, Mercedes-Benz, Sterling, Western Star Trucks; Mercedes-Benz Engines
Replaces: Mercedes-Benz 5410900151, A5410920305, A5410920805
O.D.: 3 23/32 (94.5)
I.D.: 1/2 (12.7) & 1 25/32 (45.2)
Height: 8 (203.2)
I.Gskt: [1] Included
A. Gskt: [1] Attached
O-Ring: [1] Included
Grommets: [1] Included

PF7767 Fuel Element

Fits: DAF Trucks
Replaces: DAF 1397766
O.D.: 3 31/32 (100.8)
I.D.: 1/2 (12.7) & 1 3/4 (44.4)
Height: 8 (203.2)
A. Gskt: [1] Attached
O-Ring: [1] Included
Grommets: [2] Attached

BF7762 In-Line Fuel Filter

Contains: [2] Plastic Clips
Fits: Chevrolet, GMC, Isuzu, Oldsmobile Light-Duty Trucks; Hummer H2
Replaces: GMC 15015509
O.D.: 2 5/32 (54.8)
Inlet: 3/8
Outlet: 3/8
Length: 4 27/32 (123.0)

BF7768 In-Line Fuel Filter

Contains: [2] 5/16 Inch Clips
Fits: Ford Automotive
Replaces: Motorcraft FG986B
O.D.: 2 7/32 (56.4)
Inlet: 5/16
Outlet: 5/16
Length: 7 1/32 (178.6)
Related To: BF7668 (3/8 In. Clips)

BF7769 In-Line Fuel Filter

Contains: [2] Plastic Retainer Clips
Fits: Buick, Chevrolet, Oldsmobile, Pontiac, Saturn Automotive, Light-Duty Trucks
Replaces: GMC 10333072
O.D.: 1 31/32 (50.0)
Inlet: 3/8
Outlet: 3/8
Length: 6 27/32 (173.8)

BF7769 In-Line Fuel Filter

Contains: [2] Plastic Retainer Clips
Fits: Buick, Chevrolet, Oldsmobile, Pontiac, Saturn Automotive, Light-Duty Trucks
Replaces: GMC 10333072
O.D.: 1 31/32 (50.0)
Inlet: 3/8
Outlet: 3/8
Length: 6 27/32 (173.8)

Measurements Are Shown In Inches And (Millimeters)

WARNING: These products can expose you to chemicals, including Diisononyl Phthalate, Carbon black extracts, Nickel, 1,3 Butadiene, Ethylene Oxide, Epichlorohydrin, which are known to the State of California to cause cancer, and Bisphenol, Ethylene Glycol, Ethylene Oxide, 1,3 Butadiene, Epichlorohydrin, which are known to the State of California to cause birth defects or other reproductive harm. For more information go to www.P65Warnings.ca.gov.

PF7770

Dual-Flow Fuel Element



Fits: John Deere Engines, Equipment
Replaces: John Deere RE507284
O.D.: 4 5/8 (117.5)
 Lid 5 3/8 (136.5)
I.D.: 7/8 (22.2) One End
Height: 8 3/8 (212.7)
A. Gskt: [1] Attached
Grommets: [1] Attached

BF7776

In-Line Fuel Filter



Contains: 5/16 Inch Universal Return Line
Fits: Cadillac Automotive
Replaces: GMC 25763176; ACDelco GF897
O.D.: 2 1/8 (54.0)
Inlet: M16 x 1.5
Outlet: 3/8
Length: 6 1/4 (158.8)

BF7771

In-Line Fuel Filter



Contains: [2] Plastic Retainer Clips
 5/16 Inch Return Line
 Plastic Mounting Band
 Screw and Washer
Fits: Saturn Automotive
Replaces: GMC 22633313, 22633314
O.D.: 2 5/32 (54.8)
Inlet: 3/8
Outlet: 3/8
Length: 6 7/8 (174.6)

PF7777

Fuel/Water Separator Element



Fits: Cummins ISB Series Engines; Dodge Light-Duty Trucks; Ford, Freightliner, Kenworth, Peterbilt, Sterling Trucks
Replaces: Chrysler 5015581AA; Cummins 3942470; Fleetguard FS19579
O.D.: 3 3/8 (85.7)
I.D.: 13/16 (20.6) One End
Height: 4 3/32 (104.0)
O-Ring: [1] Included
Grommets: [1] Attached

BF7772

Fuel/Water Separator Spin-on with Drain



Fits: Case Equipment; Gehl Loaders
Replaces: Gehl 132024
Thread: M16 x 1.5
O.D.: 3 1/32 (77.0)
Height: 6 21/32 (169.1)
A. Gskt: G449-B
F. Gskt: [1] Included

BF7778

Fuel/Water Separator Element with Drain



Contains: 1/2 Inch Universal Return Port
 Pressure Relief Screw
Fits: Dodge, Freightliner Sprinter Vans; Mercedes-Benz Engines
Replaces: Mercedes-Benz 6120920001, A6120920001
O.D.: 3 19/32 (91.3)
Inlet: 13/32
Outlet: 1/2
Height: 4 23/32 (119.9)

BF7773

Fuel Spin-on



Contains: Integral Post Seal
Fits: Mack Engines, Trucks
Replaces: Mack 483GB476M
Thread: M30 x 1.5
O.D.: 4 1/4 (108.0)
Height: 7 19/32 (192.9)
I.Gskt: [1] Included

PF7779

Fuel/Water Separator Element



Fits: International Engines, Trucks
Replaces: International 1842638-C91; Fleetguard FS19684
O.D.: 3 3/4 (95.3)
I.D.: 13/16 (20.6) One End
Height: 5 11/16 (144.5)
O-Ring: [2] Included
Grommets: [1] Attached

BF7774

Fuel Spin-on



Notes: Can be used with FB1301.
Fits: Detroit Diesel Engines
Replaces: Detroit Diesel 23530641
Thread: 1 -12
O.D.: 3 11/16 (93.7)
Height: 5 11/32 (135.7)
I.Gskt: [1] Included

BF7780

In-Line Fuel Filter



Contains: 3/8 Inch Quick Connect
Fits: Jeep Grand Cherokee
Replaces: Chrysler 52100283AG
O.D.: 2 5/32 (54.8)
Inlet: 5/16
Outlet: 3/8
Length: 6 13/16 (173.0)

BF7775

In-Line Fuel Filter



Contains: 3/8 Inch Universal Return Line
Fits: Pontiac Automotive
Replaces: GMC 10337405; ACDelco GF872
O.D.: 2 1/8 (54.0)
Inlet: M16 x 1.5
Outlet: 3/8
Length: 6 9/16 (166.7)

PF7782

Fuel/Water Separator Element with Relief Valve



Fits: Cummins ISX Engines; Davco Fuel Pro FH230 Series, 382 Series Housings
Replaces: Davco 382119; Fleetguard FS19728
O.D.: 3 27/32 (97.6)
I.D.: 21/32 (16.7) One End
Height: 7 1/32 (178.6)
O-Ring: [3] Included
Grommets: [1] Attached

Measurements Are Shown In Inches And (Millimeters)

WARNING: These products can expose you to chemicals, including Diisononyl Phthalate, Carbon black extracts, Nickel, 1,3 Butadiene, Ethylene Oxide, Epichlorohydrin, which are known to the State of California to cause cancer, and Bisphenol, Ethylene Glycol, Ethylene Oxide, 1,3 Butadiene, Epichlorohydrin, which are known to the State of California to cause birth defects or other reproductive harm. For more information go to www.P65Warnings.ca.gov.

BF7783-D Primary Fuel/Water Coalescer Element with Drain



Notes: Tab/Keys are not needed for installation.
Fits: Massey Ferguson Tractors
Replaces: Agco 3780931M1; J.C. Bamford 32/921001; Fleetguard FS19585
O.D.: 3 9/32 (83.3)
I.D.: 21/32 (16.7) One End
Height: 5 7/32 (132.6)
Grommets: [2] Attached

BF7798-O Fuel/Water Separator Spin-on with Open End for Bowl



Notes: Bowl Thread 3 1/8 - 10 UN-1B
Fits: Autocar, Ford, Freightliner, Peterbilt, Sterling, Western Star Trucks; Blue Bird, Thomas Buses
Replaces: Alliance ABPN12232FRT03; Caterpillar 1986378; Racor S3201S
Thread: 1 -14
O.D.: 3 5/8 (92.2)
Height: 7 13/32 (188.2)
F. Gskt: [2] Included
O-Ring: [1] Included

BF7784-D Primary Fuel/Water Separator Element with Drain



Notes: Reverse Flow
 Tab/Keys are not needed for installation.
Fits: John Deere Equipment
Replaces: Case/New Holland 87802332; John Deere RE517181
O.D.: 3 9/32 (83.3)
I.D.: 21/32 (16.7) One End
Height: 5 31/32 (151.6)
Grommets: [1] Attached

BF7798-SP Fuel/Water Separator Spin-on with Drain and Sensor Port



Notes: CAUTION: Furnished D-Ring must be installed on post for seal.
 Can be used with FB1311 base.
Contains: Sensor Port Thread: 1/2-20
Fits: Caterpillar Engines
Replaces: Caterpillar 198-6378
Thread: 1 -14
O.D.: 3 11/16 (93.7)
Height: 9 17/32 (242.1)
I.Gskt: G401
F. Gskt: [1] Included
O-Ring: [1] Included
Related To: BF7798-O} (Open Port Version)

BF7785-D Primary Fuel/Water Separator Element with Drain



Notes: Reverse Flow
 Tab/Keys are not needed for installation.
Fits: John Deere Equipment
Replaces: John Deere RE509036, RE517180
O.D.: 3 9/32 (83.3)
I.D.: 21/32 (16.7) One End
Height: 7 5/8 (193.7)
Grommets: [1] Attached

PF7799 Fuel Element



Fits: Caterpillar Industrial, Marine Engines
Replaces: Caterpillar 1R0725, 1R0766, 1W4056
O.D.: 5 1/16 (128.6)
I.D.: 2 3/32 (53.2)
Height: 10 7/16 (265.1)
A. Gskt: [2] Attached

BF7786-D Secondary Fuel/Water Separator Element with Drain



Notes: Tab/Keys are not needed for installation.
Fits: John Deere Equipment
Replaces: John Deere RE509032
O.D.: 3 9/32 (83.3)
I.D.: 21/32 (16.7) One End
Height: 7 5/8 (193.7)
Grommets: [1] Attached

BF7800 In-Line Fuel Filter



Fits: Lincoln Light-Duty Trucks
Replaces: Ford 2L7Z-9155-AA; Motorcraft FG1062
O.D.: 2 1/4 (57.2)
Inlet: 3/8
Outlet: 3/8
Length: 7 1/4 (184.2)

PF7787 Primary Fuel Element



Use With: PF7788 (Secondary)
Replaces: Zetor 931207; Fleetguard FF5197; Woodgate WGF9001
O.D.: 2 27/32 (72.2)
I.D.: 27/32 (21.4)
Height: 5 5/32 (131.0)

BF7801 In-Line Fuel Filter



Contains: 3/8 Inch Return Line
Fits: Ford Automotive, Light-Duty Trucks
Replaces: Ford 1F1Z-9155-AD, 1F1Z-9155-CA
O.D.: 2 9/32 (57.9)
Inlet: 5/16
Outlet: 5/16
Length: 6 9/16 (166.7)

PF7788 Secondary Fuel Element



Use With: PF7787 (Primary)
Replaces: Zetor 931209; Woodgate WGF9002
O.D.: 2 27/32 (72.2)
I.D.: 13/16 (20.6)
Height: 5 3/16 (131.8)

Measurements Are Shown In Inches And (Millimeters)

WARNING: These products can expose you to chemicals, including Diisononyl Phthalate, Carbon black extracts, Nickel, 1,3 Butadiene, Ethylene Oxide, Epichlorohydrin, which are known to the State of California to cause cancer, and Bisphenol, Ethylene Glycol, Ethylene Oxide, 1,3 Butadiene, Epichlorohydrin, which are known to the State of California to cause birth defects or other reproductive harm. For more information go to www.P65Warnings.ca.gov.

BF7802 In-Line Fuel Filter
Fits: Ford, Lincoln, Mercury Automotive, Light-Duty Trucks
Replaces: Ford 2C5Z-9155-AA
O.D.: 2 9/32 (57.9)
Inlet: 3/8
Outlet: 3/8
Length: 6 29/32 (175.4)



BF7803 In-Line Fuel Filter
Contains: 3/8 Inch Vapor Diverter
Fits: Ford, Mazda Light-Duty Trucks
Replaces: Ford 1L2Z-9155-BA
O.D.: 3 5/32 (80.2)
Inlet: 5/16
Outlet: 5/16
Length: 6 11/16 (169.9)



BF7804 In-Line Fuel Filter
Contains: 3/8 Inch Vapor Diverter
Fits: Ford Light-Duty Trucks
Replaces: Ford YF1Z-9155-BA
O.D.: 3 5/32 (80.2)
Inlet: 5/16
Outlet: 5/16
Length: 6 3/16 (157.2)



BF7805 In-Line Fuel Filter
Contains: 5/16 Inch Vapor Diverter
Fits: Ford Light-Duty Trucks
Replaces: Ford 2L1Z-9155-AA
O.D.: 2 1/4 (57.2)
Inlet: 3/8
Outlet: 3/8
Length: 7 27/32 (199.2)



BF7806 Fuel/Water Separator Spin-on with Drain
Contains: Front End Check Valve
Fits: Caterpillar Engines; Ford Trucks
Replaces: Ford YC35-9176-AA, YC3Z-9176-AA, YC3Z-9365-AA; Motorcraft FD4597, FG998
Thread: 1 -14
O.D.: 3 11/16 (93.7)
Height: 6 7/32 (158.0)
I.Gskt: [1] Included
Related To: BF7806-O (Open Port Version)



BF7806-O Fuel/Water Separator Spin-on with Open End for Bowl
Contains: Bowl Thread 3 1/8 - 10 UN-1B
Fits: Ford F750 with Cat 3126, Cummins ISB 200 Engine
Replaces: Ford Motor Co. 5C4Z9N184AB; IHC (International Harvester) 2587803C1; Motorcraft FD4608; Parker PFF5527; Racor S6494
Thread: 1 -14
O.D.: 3 21/32 (92.7)
Height: 4 1/32 (102.4)
F. Gskt: [1] Included
O-Ring: [1] Included
Related To: BF7806 (with Drain)



BF7808 In-Line Fuel Filter
Fits: Chevrolet, GMC Light-Duty Trucks
Replaces: GMC 25164003
O.D.: 2 5/16 (58.7)
Inlet: M16 x 1.5
Outlet: 3/8
Length: 5 11/32 (135.7)



BF7809 In-Line Fuel Filter
Contains: [2] Plastic Clips
Fits: Ford, Mercury Automotive
Replaces: Ford YF1Z-9155-CA
O.D.: 3 3/32 (78.6)
Inlet: 5/16
Outlet: 5/16
Length: 5 23/32 (145.3)



PF7812 KIT Set of 2 Fuel Elements
Notes: Filters not sold separately.
Contains: [1] Primary Fuel Element
[1] Secondary Fuel Element
Fits: Ford Light-Duty Trucks; International Engines
Replaces: Ford 3C3Z-9N184-CA
Primary
O.D.: 3 5/16 (84.1)
I.D.: 1 19/32 (40.5)
Height: 4 3/16 (106.4)
O-Ring: [2] Included
Secondary
O.D. 2 1/4
I.D. 2 1/32
Height 5 5/8



BF7813 Fuel Spin-on
Fits: Cummins Engines; DAF, Iveco Trucks
Replaces: Cummins 4897833; DAF 1399760; Fleetguard FF5420, FF5485
Thread: M20 x 1.5
O.D.: 3 11/16 (93.7)
Height: 7 1/8 (181.0)
A. Gskt: G381-A



BF7814 Fuel Spin-on
Fits: Mack Engines, Trucks; R.V.I. Trucks; Volvo Buses, Engines, Trucks
Replaces: Volvo 20430751; Donaldson P550739
Thread: M32 x 1.5
O.D.: 4 1/4 (108.0)
Height: 10 15/32 (265.9)
I.Gskt: [1] Included



BF7815 High Efficiency Fuel Spin-on
Fits: Cummins Engines; Kenworth, Mack, Peterbilt, Sterling Trucks
Replaces: Cummins 3959612; Fleetguard FF5488
Thread: 7/8 -14
O.D.: 3 23/32 (94.5)
Height: 7 5/32 (181.8)
I.Gskt: G381-A
F. Gskt: [1] Included



Measurements Are Shown In Inches And (Millimeters)

WARNING: These products can expose you to chemicals, including Diisononyl Phthalate, Carbon black extracts, Nickel, 1,3 Butadiene, Ethylene Oxide, Epichlorohydrin, which are known to the State of California to cause cancer, and Bisphenol, Ethylene Glycol, Ethylene Oxide, 1,3 Butadiene, Epichlorohydrin, which are known to the State of California to cause birth defects or other reproductive harm. For more information go to www.P65Warnings.ca.gov.

PF7816 Fuel Element with Threaded Lid
Replaces: Kubota 11420-43012; Woodgate WGF9327
O.D.: 1 1/4 (31.8)
Lid 2 9/32 (57.9)
I.D.: 1/4 (6.4)
Height: 4 5/8 (117.5)
O-Ring: [1] Included



PF7822 Fuel Element
Replaces: Robin 2286211008; Woodgate WGF9065
O.D.: 1 3/8 (34.9)
I.D.: 15/32 (11.9) One End
Height: 1 3/4 (44.4)
O-Ring: [1] Attached



PF7817 Fuel Element
Fits: Citroen Automotive
Replaces: Peugeot 190629; Woodgate WGF9355
O.D.: 2 19/32 (65.9)
Flange 3 5/32 (80.2)
I.D.: 3/4 (19.0)
Height: 2 11/32 (59.5)
O-Ring: [1] Attached



PF7823 Fuel Element
Replaces: Honda 17682-ZG5-003; Woodgate WGF9067
O.D.: 1 31/32 (50.0)
I.D.: 13/32 (10.3) One End
Height: 3 25/32 (96.0)
O-Ring: [1] Attached



PF7818 Fuel Element
Fits: Hatz Engines
Replaces: Hatz 50474300; Woodgate WGF9306
O.D.: 1 1/8 (28.6)
I.D.: 5/8 (15.9) One End
Height: 2 7/32 (56.4)
Grommets: [1] Attached



PF7824 Fuel Element
Fits: Caterpillar, Mitsubishi Lift Trucks; Toro Lawn & Garden Tractors
Replaces: Mitsubishi ME408992; Fleetguard FF5131; Woodgate WGF9103
O.D.: 1 19/32 (40.5)
I.D.: 31/32 (24.6)
Height: 1 13/32 (35.7)



PF7819 Nylon Screen Fuel Element
Replaces: Mercedes-Benz 900150; Woodgate WGF9316
O.D.: 7/8 (22.2)
I.D.: 3/8 (9.5)
Height: 1 13/16 (46.0)



PF7825 Fuel Element
Fits: Honda Engines
Replaces: Honda 17682-ZG3-003; Woodgate WGF9201
O.D.: 2 (50.8)
I.D.: 5/8 (15.9) & 1 15/32 (37.3)
Height: 5 13/32 (137.3)
O-Ring: [1] Attached



PF7820 Fuel Element with Threaded Stud
Fits: Lister-Petter Engines
Replaces: AP-Lockheed LK65300; Fleetguard FF5044; Woodgate WGF5044
O.D.: 1 1/8 (28.6)
I.D.: 3/16 (4.8)
Height: 3 (76.2)
F. Gskt: [1] Rubber Washer



PF7826 Fuel Element
Contains: [2] Threaded Bolts
Fits: Yanmar Engines
Replaces: Yanmar 114250-55120; Woodgate WGF9202
O.D.: 1 9/16 (39.7)
I.D.: 11/32 (8.7)
Height: 5 1/8 (130.2)
A. Gskt: [1] Included
Related To: PF7828, PF7876 (Long Versions)



BF7821 Fuel Element with Drain
Notes: OBSOLETE. Availability Limited to Dealer Stock.
Fits: Ford Light-Duty Trucks
Replaces: Motorcraft EFG319; Fleetguard FF5483; Woodgate WGF850-2
O.D.: 3 9/16 (90.5)
I.D.: 1 15/32 (37.3)
Height: 5 9/32 (134.1)



PF7828 Fuel Element
Contains: [2] Threaded Bolts
Fits: Yanmar Carriers
Replaces: Yanmar 114650-55120; Woodgate WGF9203
O.D.: 1 9/16 (39.7)
I.D.: 5/8 (15.9) One End
Height: 7 13/16 (198.4)
A. Gskt: [1] Included
Related To: PF7826, PF7876 (Short Versions)



Measurements Are Shown In Inches And (Millimeters)

WARNING: These products can expose you to chemicals, including Diisononyl Phthalate, Carbon black extracts, Nickel, 1,3 Butadiene, Ethylene Oxide, Epichlorohydrin, which are known to the State of California to cause cancer, and Bisphenol, Ethylene Glycol, Ethylene Oxide, 1,3 Butadiene, Epichlorohydrin, which are known to the State of California to cause birth defects or other reproductive harm. For more information go to www.P65Warnings.ca.gov.

PF7830



Nylon Screen Fuel Strainer
Fits: Komatsu Equipment; Yanmar Excavators
Replaces: Yanmar 121850-55710; Woodgate WGF9347
O.D.: 1 3/8 (34.9)
I.D.: 15/32 (11.9) One End
Height: 2 3/4 (69.9)
O-Ring: [1] Attached

BF7839



Wound Fuel Spin-on with Threaded Port
Contains: Port Thread: M36 x 1.5
Replaces: Coopers FSM4135; Woodgate WGF9368
Thread: 3/4 -16
O.D.: 2 3/32 (53.2)
 to 2 27/32 (72.2)
Height: 4 25/32 (121.4)
O-Ring: [1] Attached; [1] Included

PF7832



Fuel Element
Fits: Kubota Excavators
Replaces: Yanmar 10590G-55710; Woodgate WGF9369
O.D.: 1 31/32 (50.0)
I.D.: 25/32 (19.8) One End
Height: 3 1/8 (79.4)

BF7840



Fuel Spin-on
Replaces: J.C. Bamford 8943254630; Woodgate WGF5114
Thread: 3/4 -16
O.D.: 3 1/8 (79.4)
Height: 3 (76.2)
I.Gskt: [1] Included

PF7833



Fuel Element
Replaces: Renault 5000590728; Fleetguard FF5057; Woodgate WGF5057
O.D.: 2 1/32 (51.6)
I.D.: 1/2 (12.7)
Height: 2 21/32 (67.5)
End Seals: [2] Attached

BF7841



Fuel Spin-on
Fits: Hitachi, Takeuchi Excavators
Replaces: Nissan 16403-J6500; Woodgate WGF5141
Thread: 3/4 -16
O.D.: 3 1/8 (79.4)
Height: 3 7/8 (98.4)
I.Gskt: [1] Included

PF7836



Fuel Element
Fits: Lister-Petter Engines
Replaces: Lister 203-32470; Fleetguard FF5099; Woodgate WGF5099
O.D.: 2 5/32 (54.8)
I.D.: 5/8 (15.9) & 15/16 (23.8)
Height: 2 15/32 (62.7)
F. Gskt: [3] Included

BF7842



Wound Fuel Spin-on with Threaded Port
Contains: Port Thread: M22 x 1.5
Fits: Mitsubishi Trucks
Replaces: Mitsubishi ME132525; Woodgate WGF9377
Thread: M20 x 1.5
O.D.: 3 27/32 (97.6)
Height: 5 19/32 (142.1)
O-Ring: [1] Attached; [1] Included

BF7837



Fuel Spin-on
Fits: Kubota Engines
Replaces: Woodgate WGF9071
Thread: M20 x 1.5
O.D.: 3 3/32 (78.6)
Height: 2 21/32 (67.5)
I.Gskt: [1] Included

BF7843



In-Line Fuel Filter in Plastic Housing
Replaces: Mann & Hummel WK21; Woodgate WGF9304
O.D.: 3/4 (19.0)
Inlet: 3/16
Outlet: 3/16
Length: 2 3/8 (60.3)

BF7838



Wound Fuel Spin-on with Threaded Port
Contains: Port Thread: M22 x 1.5
Fits: Hitachi Excavators; Komatsu Lift Trucks
Replaces: Daihatsu 23303-87781; Fleetguard FF5229; Woodgate WGF9223
Thread: M20 x 1.5
O.D.: 3 7/32 (81.8)
Height: 4 25/32 (121.4)
I.Gskt: [1] Included
O-Ring: [1] Included







BF7844









In-Line Fuel Filter with Drain
Fits: Kubota Excavators
Replaces: Kubota 19099-11151; Woodgate WGF842-3
O.D.: 3 3/8 (85.7)
Inlet: 5/16
Outlet: 5/16
Length: 6 21/32 (169.1)

Measurements Are Shown In Inches And (Millimeters)

WARNING: These products can expose you to chemicals, including Diisononyl Phthalate, Carbon black extracts, Nickel, 1,3 Butadiene, Ethylene Oxide, Epichlorohydrin, which are known to the State of California to cause cancer, and Bisphenol, Ethylene Glycol, Ethylene Oxide, 1,3 Butadiene, Epichlorohydrin, which are known to the State of California to cause birth defects or other reproductive harm. For more information go to www.P65Warnings.ca.gov.

	<p>BF7845 Plastic In-Line Fuel Filter Contains: [2] Bleed Screws Fits: Mitsubishi Engines Replaces: Mitsubishi MM304900; Woodgate WGF9060 O.D.: 1 25/32 (45.2) Inlet: 5/16 Outlet: 11/32 Length: 3 27/32 (97.6)</p>
	<p>BF7847 Plastic In-Line Fuel Filter Contains: Inlet, Outlet and Return Lines Bleed Screw Fits: Robin Engines Replaces: Robin 2436210120; Woodgate WGF9341 O.D.: 2 9/32 (57.9) Length: 4 1/32 (102.4)</p>
	<p>BF7848 In-Line Fuel Filter Fits: Mercedes-Benz Automotive Replaces: Mercedes-Benz 14777901; Woodgate WGF31-5 O.D.: 1 13/32 (35.7) Inlet: 5/16 Outlet: 5/16 Length: 4 3/32 (104.0)</p>
	<p>BF7849 Plastic In-Line Fuel Filter Contains: 9/32 Inch Return Line Fits: Lombardini Engines Replaces: Lombardini 196.3730.096; Woodgate WGF9229 O.D.: 1 27/32 (46.8) Inlet: 9/32 Outlet: 9/32 Length: 3 3/8 (85.7)</p>
	<p>BF7850 Nylon In-Line Fuel Filter Replaces: Woodgate WGF9301 O.D.: 2 (50.8) Inlet: 5/16 or 3/8 In. Universal Outlet: 5/16 or 3/8 In. Universal Length: 8 1/8 (206.4)</p>
	<p>BF7851 Wire Mesh In-Line Fuel Filter in Plastic Housing Replaces: Woodgate WGF9303 O.D.: 1 15/32 (37.3) Inlet: 1/4 or 5/16 In. Universal Outlet: 1/4 or 5/16 In. Universal Length: 4 7/32 (107.2)</p>
	<p>PF7852 KIT Set of 2 Fuel Elements Fits: Ford Vans Replaces: Ford 4C2Z-9N184-BA; International 1845626-C91; Motorcraft FD4606 Primary O.D.: 3 3/4 (95.3) I.D.: 1 1/2 (38.1) One End Height: 3 1/8 (79.4) O-Ring: [2] Included Secondary O.D. 2 5/16 I.D. 15/16 Height 2 5/8</p>

	<p>BF7853 Secondary Fuel Spin-on with Drain Contains: Integral Post Seal Fits: John Deere Engines, Equipment, Trucks Replaces: John Deere RE522688 Thread: 7/8 -14 O.D.: 4 1/4 (108.0) Height: 6 11/16 (169.9) I.Gskt: [1] Included</p>
	<p>BF7855 In-Line Fuel Filter Replaces: Stihl 3503500; Woodgate WGF9310 O.D.: 13/16 (20.6) Inlet: 1/4 Outlet: 1/4 Length: 1 3/4 (44.4)</p>
	<p>BF7857 In-Line Fuel Filter with Felt Wrap Replaces: Partner 506096001; Woodgate WGF9326 O.D.: 27/32 (21.4) Inlet: 3/16 Outlet: 3/16 Length: 1 7/16 (36.5)</p>
	<p>BF7859 In-Line Fuel/Water Separator with Drain Notes: OBSOLETE. Availability Limited to Dealer Stock. Contains: 5/16 Inch Return Line Replaces: Honda 17670-ZG3-901; Woodgate WGF9373 O.D.: 2 1/16 (52.4) Inlet: 5/16 Outlet: 11/32 Length: 4 17/32 (115.1)</p>
	<p>BF7860 In-Line Fuel Filter with Felt Wrap Replaces: Woodgate WGF9383 O.D.: 25/32 (19.8) Inlet: 5/32 Outlet: 5/32 Length: 1 5/8 (41.3)</p>
	<p>BF7863 In-Line Mesh Fuel Filter Fits: Hatz Engines Replaces: Woodgate WGF9149 O.D.: 2 1/16 (52.4) Inlet: 1/4 or 5/16 In. Universal Outlet: 1/4 or 5/16 In. Universal Length: 4 3/4 (120.7)</p>
	<p>BF7864 Plastic In-Line Fuel Filter Fits: Ford Lawn & Garden Tractors Replaces: Briggs & Stratton 298090; Woodgate WGF9334 O.D.: 1 5/16 (33.3) Inlet: 5/16 Outlet: 5/16 Length: 1 3/4 (44.4)</p>

Measurements Are Shown In Inches And (Millimeters)

WARNING: These products can expose you to chemicals, including Diisononyl Phthalate, Carbon black extracts, Nickel, 1,3 Butadiene, Ethylene Oxide, Epichlorohydrin, which are known to the State of California to cause cancer, and Bisphenol, Ethylene Glycol, Ethylene Oxide, 1,3 Butadiene, Epichlorohydrin, which are known to the State of California to cause birth defects or other reproductive harm. For more information go to www.P65Warnings.ca.gov.

BF7865

Plastic In-Line Fuel Filter



Replaces: M.A.N. 81.12503.0056; Woodgate WGF31-2
O.D.: 1 3/16 (30.2)
to 1 3/8 (34.9)
Inlet: 5/16
Outlet: 5/16
Length: 4 7/32 (107.2)

BF7866

Wire Mesh Fuel Strainer with Handle



Fits: Bobcat Excavators
Replaces: Deutz 1319869; Fleetguard FF5584; Woodgate WGF9069
O.D.: 3 5/16 (84.1)
I.D.: 17/32 (13.5)
Height: 4 21/32 (118.3)
F. Gskt: [1] Included, [1] Washer
O-Ring: [1] Included
Grommets: [2] Attached

PF7869

Fuel Screen



Fits: Kobelco, Takeuchi, Terex Excavators
Replaces: Yanmar 171081-55910; Fleetguard FF5386; Woodgate WGF9302
O.D.: 1 3/8 (34.9)
I.D.: 15/32 (11.9) One End
Height: 2 1/32 (51.6)
O-Ring: [1] Attached

PF7872

Fuel Element



Fits: Hatz Engines; Wacker Equipment
Replaces: Bomag 5723413; Woodgate WGF9300
O.D.: 1 17/32 (38.9)
I.D.: 9/16 (14.3)
Height: 5 11/32 (135.7)
Grommets: [2] Attached

PF7873

Fuel Element



Fits: Yanmar Engines
Replaces: Yanmar 104200-55710; Fleetguard FF5170; Woodgate WGF9062
O.D.: 1 3/8 (34.9)
I.D.: 1/2 (12.7) One End
Height: 1 3/4 (44.4)
O-Ring: [1] Attached

PF7874

Fuel Element



Fits: Lombardini Engines
Replaces: Lombardini 2175.112; Fleetguard FF5280; Woodgate WGF9321
O.D.: 1 5/8 (41.3)
I.D.: 3/8 (9.5) & 9/16 (14.3)
Height: 2 1/16 (52.4)

PF7875

Fuel Element



Fits: Lombardini Engines
Replaces: Lombardini 2175.108; Fleetguard FF5281; Woodgate WGF9322
O.D.: 1 31/32 (50.0)
I.D.: 3/8 (9.5) & 9/16 (14.3)
Height: 2 1/16 (52.4)

PF7876

Fuel Element



Contains: [2] Threaded Bolts
Fits: Komatsu PC02-1 Excavators
Replaces: Yanmar 114350-55120; Woodgate WGF9325
O.D.: 1 9/16 (39.7)
I.D.: 5/8 (15.9) One End
Height: 6 5/32 (156.4)
A. Gskt: [1] Included
Related To: PF7826 (Short Version)
PF7828 (Long Version)

PF7877

Fuel Element



Fits: Yanmar Engines, Generators
Replaces: Yanmar 105370-55710; Woodgate WGF9374
O.D.: 1 3/16 (30.2)
I.D.: 5/8 (15.9) One End
Height: 3 13/32 (86.5)
O-Ring: [1] Attached

PF7878

Fuel Element



Fits: M.A.N. Trucks
Replaces: Mann & Hummel PU855X; Fleetguard FF5481
O.D.: 3 (76.2)
I.D.: 7/16 (11.1) & 1 1/32 (26.2)
Height: 9 3/32 (231.0)
O-Ring: [1] Included
Grommets: [1] Attached

BF7879

Fuel Spin-on



Notes: CAUTION: Furnished O-Ring must be installed on post for seal.
Fits: Cummins Marine Engines
Replaces: Cummins 3890017; Fleetguard FF5285
Thread: 13/16 -18
O.D.: 3 11/16 (93.7)
Height: 5 13/32 (137.3)
I.Gskt: G401
O-Ring: [1] Included
Related To: BF1280 (with Drain)

BF7880









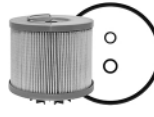

Fuel Spin-on



Fits: Ruggieri Engines
Replaces: Ruggieri 17520; Woodgate WGF9362
Thread: M16 x 1.5
O.D.: 2 31/32 (75.4)
Height: 2 31/32 (75.4)
I.Gskt: [1] Included

Measurements Are Shown In Inches And (Millimeters)

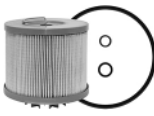
WARNING: These products can expose you to chemicals, including Diisononyl Phthalate, Carbon black extracts, Nickel, 1,3 Butadiene, Ethylene Oxide, Epichlorohydrin, which are known to the State of California to cause cancer, and Bisphenol, Ethylene Glycol, Ethylene Oxide, 1,3 Butadiene, Epichlorohydrin, which are known to the State of California to cause birth defects or other reproductive harm. For more information go to www.P65Warnings.ca.gov.

<p>BF7881</p> 	<p>Box-Style Fuel Filter with Bail Handle Replaces: Case 336430-A1; Separ 53050; Woodgate WGFS5305 Length: 2 31/32 (75.4) Width: 2 31/32 (75.4) Height: 2 1/8 (54.0)</p>	<p>PF7889-10 Fuel Element with Bail Handle Contains: Emergency By-Pass Tab Fits: Racor 900 Series Housings Replaces: Racor 2040 Series O.D.: 4 5/16 (109.5) I.D.: 5/8 (15.9) & 13/16 (20.6) Height: 3 29/32 (99.2) F. Gskt: G240 O-Ring: [1] Included End Seals: [1] Included Related To: PF7889, PF7889-30 (Media Difference)</p> 
<p>PF7882</p> 	<p>Nylon Mesh Fuel Screen with Lid Replaces: M.A.N. 81.12106.0004; Woodgate WGF9370 O.D.: 1 7/32 (31.0) Lid 1 5/8 (41.3) I.D.: 3/16 (4.8) & 1 1/16 (27.0) Height: 15/16 (23.8) O-Ring: [2] Included</p>	<p>PF7889-30 Fuel Element with Bail Handle Contains: Emergency By-Pass Tab Fits: Racor 900 Series Housings Replaces: Racor 2040 Series O.D.: 4 5/16 (109.5) I.D.: 5/8 (15.9) & 13/16 (20.6) Height: 3 29/32 (99.2) F. Gskt: G240 O-Ring: [1] Included End Seals: [1] Included Related To: PF7889, PF7889-10 (Media Difference)</p> 
<p>BF7883</p> 	<p>Fuel Spin-on Fits: Volvo Excavators, Loaders, Motor Graders Replaces: Volvo 11708555 Thread: M16 x 1.5 O.D.: 3 11/16 (93.7) Height: 4 3/8 (111.1) I.Gskt: G381-A</p>	<p>PF7890 Fuel/Water Separator Element with Bail Handle Contains: Emergency By-Pass Tab Fits: Racor 1000FH Series Housings Replaces: Racor 2020 Series O.D.: 4 5/16 (109.5) I.D.: 5/8 (15.9) & 13/16 (20.6) Height: 8 29/32 (226.2) F. Gskt: G240, [1] Included O-Ring: [1] Included Related To: PF7890-10, PF7890-30 (Media Difference)</p> 
<p>BF7886</p> 	<p>Fuel Spin-on Notes: External Post Seal Included. Fits: Renault Engines, Trucks Replaces: Mann WK940-20; Renault 5001853860, 5010412350 Thread: M18 x 1.5 O.D.: 3 11/16 (93.7) Height: 5 5/8 (142.9) I.Gskt: [1] Included F. Gskt: [1] Included</p>	<p>PF7890-10 Fuel/Water Separator Element with Bail Handle Contains: Emergency By-Pass Tab Fits: Racor 1000FH Series Housings Replaces: Racor 2020 Series O.D.: 4 5/16 (109.5) I.D.: 5/8 (15.9) & 13/16 (20.6) Height: 8 29/32 (226.2) F. Gskt: G240, [1] Included O-Ring: [1] Included Related To: PF7890, PF7890-30 (Media Difference)</p> 
<p>BF7888</p> 	<p>Fuel Spin-on Fits: Volvo Equipment Replaces: Volvo 11711074 Thread: M16 x 1.5 O.D.: 3 11/16 (93.7) Height: 5 13/32 (137.3) I.Gskt: G401</p>	<p>PF7890-30 Fuel/Water Separator Element with Bail Handle Contains: Emergency By-Pass Tab Fits: Racor 1000FH Series Housings Replaces: Racor 2020 Series O.D.: 4 5/16 (109.5) I.D.: 5/8 (15.9) & 13/16 (20.6) Height: 8 29/32 (226.2) F. Gskt: G240, [1] Included O-Ring: [1] Included Related To: PF7890, PF7890-10 (Media Difference)</p> 
<p>PF7889</p> 	<p>Fuel Element with Bail Handle Contains: Emergency By-Pass Tab Fits: Racor 900 Series Housings Replaces: Racor 2040 Series O.D.: 4 5/16 (109.5) I.D.: 5/8 (15.9) & 13/16 (20.6) Height: 3 29/32 (99.2) F. Gskt: G240 O-Ring: [1] Included End Seals: [1] Included Related To: PF7889-10, PF7889-30 (Media Difference)</p>	<p>BF7892 Fuel Spin-on Fits: Komatsu Equipment Replaces: Komatsu 600-311-8222 Thread: 3/4 -16 O.D.: 3 1/32 (77.0) Height: 4 3/32 (104.0) I.Gskt: G449-B</p> 

Measurements Are Shown In Inches And (Millimeters)

WARNING: These products can expose you to chemicals, including Diisononyl Phthalate, Carbon black extracts, Nickel, 1,3 Butadiene, Ethylene Oxide, Epichlorohydrin, which are known to the State of California to cause cancer, and Bisphenol, Ethylene Glycol, Ethylene Oxide, 1,3 Butadiene, Epichlorohydrin, which are known to the State of California to cause birth defects or other reproductive harm. For more information go to www.P65Warnings.ca.gov.

PF7894 Fuel/Water Separator Element with Relief Valve
Fits: Davco FH230 Fuel Pro, 233 Series, FH233 Diesel Pro Series Housings, 382 Series Housings
Replaces: Davco 102529; Fleetguard FS19761
O.D.: 3 13/16 (96.8)
I.D.: 21/32 (16.7) One End
Height: 7 1/32 (178.6)
O-Ring: [3] Included
Grommets: [1] Attached



PF7895 Fuel/Water Separator Element
Contains: Relief Valve
Fits: Davco FH230 Series, 233 Series, FH233 Series, 382 Series Housings
Replaces: Fleetguard FS19727
O.D.: 3 13/16 (96.8)
I.D.: 21/32 (16.7) One End
Height: 7 1/32 (178.6)
O-Ring: [3] Included
Grommets: [1] Attached



PF7896 Fuel Element
Fits: Scania Generator Sets, Trucks
Replaces: Scania 1446432; Fleetguard FF5423
O.D.: 3 5/16 (84.1)
I.D.: 1 3/8 (34.9) One End
Height: 7 7/32 (183.4)
O-Ring: [1] Included



BF7898-D Secondary Fuel/Water Separator Element with Drain
Fits: Caterpillar Skid Steer Loaders
Replaces: Caterpillar 223-0702
O.D.: 3 9/32 (83.3)
I.D.: 21/32 (16.7) One End
Height: 7 5/8 (193.7)
Grommets: [1] Attached



PF7899 Fuel Element
Contains: Viton O-Ring for high heat applications.
Fits: Perkins Engines
Replaces: Perkins CH10930, 996453
O.D.: 4 19/32 (116.7)
I.D.: 2 5/32 (54.8) One End
Height: 9 9/32 (235.7)
O-Ring: [1] Viton Included



PF7900 Fuel Element
Contains: Viton O-Ring for high heat applications.
Fits: Perkins Engines
Replaces: Perkins CH10931, 996454
O.D.: 4 29/32 (124.6)
I.D.: 2 1/16 (52.4) One End
Height: 10 5/16 (261.9)
O-Ring: [1] Viton Included



BF7903 In-Line Fuel Filter
Fits: Aston Martin, BMW, Fiat, Peugeot Automotive; Poulan Lawn Tractors
Replaces: Hastings GF95; Wix 33011
O.D.: 1 13/32 (35.7)
Inlet: 1/4
Outlet: 1/4
Length: 4 5/32 (105.6)



BF7904-D Secondary Fuel/Water Separator Element with Drain
Notes: Reverse Flow
 Tab/Keys are not needed for installation.
Fits: John Deere Engines, Equipment
Replaces: John Deere RE508202
O.D.: 3 3/8 (85.7)
I.D.: 11/16 (17.5) One End
Height: 6 1/32 (153.2)
Grommets: [1] Attached



BF7905-D Secondary Fuel/Water Separator Element with Drain
Notes: Tab/Keys are not needed for installation.
Fits: Kubota Engines; Volvo Loaders
Replaces: Omniquip 8320269; Volvo 11711183
O.D.: 3 9/32 (83.3)
I.D.: 21/32 (16.7) One End
Height: 5 31/32 (151.6)
Grommets: [1] Attached



BF7906-D Secondary Fuel/Water Separator Element with Drain
Notes: Reverse Flow
 Tab/Keys are not needed for installation.
Fits: Caterpillar Equipment
Replaces: Caterpillar 233-9856
O.D.: 3 9/32 (83.3)
I.D.: 21/32 (16.7) One End
Height: 5 31/32 (151.6)
Grommets: [1] Attached



BF7907 Fuel Spin-on
Contains: Integral Post Seal
Fits: Volvo Excavators
Replaces: Volvo 11713240, 14520542, 14520578
Thread: M20 x 1.5
O.D.: 3 11/16 (93.7)
Height: 5 5/8 (142.9)
I.Gskt: G324-A















BF7908 Fuel Spin-on
Fits: Generator Sets with Scania DC12 Engine, Trucks
Replaces: Scania 1411894; Fleetguard FF5424
Thread: M24 x 1.5
O.D.: 3 11/16 (93.7)
Height: 5 21/32 (143.7)
I.Gskt: [1] Included



Measurements Are Shown In Inches And (Millimeters)

WARNING: These products can expose you to chemicals, including Diisononyl Phthalate, Carbon black extracts, Nickel, 1,3 Butadiene, Ethylene Oxide, Epichlorohydrin, which are known to the State of California to cause cancer, and Bisphenol, Ethylene Glycol, Ethylene Oxide, 1,3 Butadiene, Epichlorohydrin, which are known to the State of California to cause birth defects or other reproductive harm. For more information go to www.P65Warnings.ca.gov.

<p>BF7909 Fuel Spin-on Fits: Deutz Engines; Volvo Loaders Replaces: KHD Deutz 1052175138; Volvo 2900777 Thread: M16 x 1.5 O.D.: 3 1/32 (77.0) Height: 2 27/32 (72.2) I.Gskt: G449-B</p> 	<p>BF7915 Fuel Spin-on Fits: Hatz Engines Replaces: Hatz 50251500; Donaldson P550345; Fleetguard FF5040 Thread: M16 x 1.5 O.D.: 3 1/32 (77.0) Height: 2 27/32 (72.2) A. Gskt: G449-B Related To: BF790 (Tall Version)</p> 
<p>PF7910 Fuel Element with Bail Handle Fits: Daewoo Excavators Replaces: Daewoo 65125035001; Donaldson P550860 O.D.: 2 5/16 (58.7) I.D.: 1/2 (12.7) Height: 4 13/32 (111.9) F. Gskt: [1] Included Grommets: [1] Attached</p> 	<p>PF7916 Fuel Element Fits: Volvo Excavators Replaces: Volvo 11708554, 11988962, VOE11988962 O.D.: 2 7/8 (73.0) I.D.: 3/8 (9.5) & 1 7/16 (36.5) Height: 3 7/8 (98.4) A. Gskt: [2] Attached O-Ring: [1] Included</p> 
<p>BF7911 Wire Mesh Supported Maximum Performance Glass Fuel Spin-on Contains: Integral Post Seal Replaces: Donaldson P550218; Fleetguard FF5347 Thread: 7/8 -16 O.D.: 4 1/4 (108.0) Height: 7 11/32 (186.5) I.Gskt: G381-A</p> 	<p>BF7917 Fuel Spin-on Notes: CAUTION: Furnished O-Ring must be installed on post for seal. Contains: Integral Post Seal Fits: Cummins Engines; Hyundai Equipment Replaces: Cummins 3973232; Fleetguard FF5580 Thread: 7/8 -14 O.D.: 3 11/16 (93.7) Height: 7 1/8 (181.0) I.Gskt: G381-A O-Ring: [1] Included</p> 
<p>BF7912 Box-Style Fuel Element with Bail Handle Fits: M.A.N. Trucks; Volvo Excavators Replaces: Deutz 01319822; Volvo 14514238; Fleetguard FS19605 Length: 3 15/32 (88.1) Width: 3 7/16 (87.3) Height: 2 1/8 (54.0) A. Gskt: [1] Attached</p> 	<p>BF7919 Fuel Spin-on Fits: John Deere Crawler Dozers, Crawler Loaders Replaces: John Deere AT279824 Thread: M16 x 1.5 O.D.: 3 11/16 (93.7) Height: 5 1/4 (133.4) I.Gskt: G381-A F. Gskt: [1] Included Related To: BF7696 (Long Version)</p> 
<p>BF7913 High Efficiency Fuel Spin-on Contains: Integral Post Seal Fits: Komatsu Equipment Replaces: Komatsu 600-311-3310, 600-311-3510, 600-319-3510 Thread: 1 1/4 -12 O.D.: 4 21/32 (118.3) Height: 11 7/32 (285.0) I.Gskt: [1] Included</p> 	<p>BF7921 Fuel/Water Separator Spin-on with Drain Fits: New Holland Loaders Replaces: New Holland 87803264 Thread: M16 x 1.5 O.D.: 3 1/32 (77.0) Height: 5 11/16 (144.5) I.Gskt: G449-B</p> 
<p>PF7914 Water Absorbing Fuel Storage Tank Element Fits: Fuel Storage Tanks Replaces: Cim-Tek EHS10, 30033; Fleetguard FS19751; Wix 24841 O.D.: 4 19/32 (116.7) I.D.: 9/16 (14.3) & 1 3/32 (27.8) Height: 9 5/16 (236.5) F. Gskt: [2] Included, [1] Metal Washer Grommets: [1] Attached</p> 	<p>BF7922 Fuel Spin-on Notes: CAUTION: Furnished O-Ring must be installed on post for seal. Fits: Case; Case-International, New Holland Equipment Replaces: Case 87803200; Fleetguard FF5612 Thread: M20 x 1.5 O.D.: 3 11/16 (93.7) Height: 7 7/32 (183.4) A. Gskt: G401 F. Gskt: [1] Included</p> 

Measurements Are Shown In Inches And (Millimeters)

WARNING: These products can expose you to chemicals, including Diisononyl Phthalate, Carbon black extracts, Nickel, 1,3 Butadiene, Ethylene Oxide, Epichlorohydrin, which are known to the State of California to cause cancer, and Bisphenol, Ethylene Glycol, Ethylene Oxide, 1,3 Butadiene, Epichlorohydrin, which are known to the State of California to cause birth defects or other reproductive harm. For more information go to www.P65Warnings.ca.gov.

BF7923

Fuel Spin-on



Contains: Integral Post Seal
Fits: John Deere 600C LC Excavator
Replaces: John Deere AT308578
Thread: 1 -14
O.D.: 3 11/16 (93.7)
Height: 6 11/16 (169.9)
I.Gskt: G401

PF7928

Fuel Element



Contains: Relief Valve
Fits: Davco FH230, FH234, DI9100 Housings
Replaces: Davco 102011, 102526, Fleetguard FS19763
O.D.: 4 3/16 (106.4)
I.D.: 2 1/32 (16.7) One End
Height: 7 1/32 (178.6)
O-Ring: [2] Included
Grommets: [1] Attached

BF7924

Fuel Spin-on



Notes: CAUTION: Furnished D-Ring must be installed on post for seal.
Contains: Integral Post Seal
Fits: Freightliner, Kenworth, Peterbilt Trucks
Replaces: Cummins 4940647; Fleetguard FF5636
Thread: 7/8 -14
O.D.: 3 23/32 (94.5)
Height: 7 5/32 (181.8)
I.Gskt: G381-A
O-Ring: [1] Included

BF7929 KIT

Set of 2 Fuel Filters



Notes: Filters not sold separately.
Contains: [1] Element
 [1] Spin-on with Drain
Fits: John Deere Equipment
Replaces: John Deere RE520906, RE523236, RE525523, RE541747; SF-Filter SK3188-SET
Spin-on
Thread: 1 -14
O.D.: 4 5/16 (109.5)
Height: 6 25/32 (172.2)
I.Gskt: [1] Included
Element
O.D. 3 23/32
I.D. 1 19/32
Height 6 9/32
O-Ring [1] Included

BF7925

Fuel/Water Separator Spin-on with Drain



Notes: Use with Conversion Adapter FD7926 on first installation only.
 See Form 349 for installation instructions.
Fits: Bobcat, Caterpillar, Gehl, J.C. Bamford, Manitou, Massey Ferguson, Terex Equipment
Replaces: Caterpillar 1R1804; Gehl 184223, J.C. Bamford 32/925423; Massey Ferguson 4224811M1; Perkins 934181, 26560201
Thread: M24 x 2.0
O.D.: 3 11/16 (93.7)
Height: 6 5/32 (156.4)
I.Gskt: G381-A

PF7930

Fuel/Water Separator Element



Contains: Relief Valve
Fits: Davco FH230 Series Fuel Pro, FH234 Series Industrial Pro
Replaces: Davco 102528; Paccar 382951PAC25; Volvo 21737499, 85120233; Fleetguard FS19765
O.D.: 4 3/16 (106.4)
I.D.: 2 1/32 (16.7) One End
Height: 6 15/16 (176.2)
O-Ring: [2] Included
Grommets: [1] Attached

FD7926

Fuel Filter Adapter



Notes: Converts base from element/housing to spin-on.
Contains: [1] Tube Saf-T-Lok
Use With: BF7925
Replaces: Caterpillar 1R1804; Gehl 184223, J.C. Bamford 32/925423; Massey Ferguson 4224811M1; Perkins 934181, 26560201
Thread: M24 x 2.0
O.D.: 3 3/8 (85.7)
Height: 1 1/2 (38.1)
O-Ring: [1] Included

BF7931

Fuel Spin-on



Fits: Equipment and Trucks with Various Deutz Diesel Engines
Replaces: Deutz 1174423
Thread: M16 x 1.5
O.D.: 3 1/32 (77.0)
Height: 4 27/32 (123.0)
I.Gskt: [1] Included

BF7927

Fuel Spin-on



Fits: Case-International, New Holland Equipment; Iveco Trucks
Replaces: Case 84818745; Iveco 500315480; New Holland 1931108
Thread: M16 x 1.5
O.D.: 4 1/4 (108.0)
Height: 7 (177.8)
I.Gskt: G401

BF7932

Fuel Spin-on



Fits: Cummins QSK 19 (Tier 3) Engine
Replaces: Cummins 4964100; Fleetguard FF5607, FF5634, FF5644
Thread: 2 1/4 -12
O.D.: 4 21/32 (118.3)
Height: 10 5/16 (261.9)
I.Gskt: [1] Included
Related To: BF46002 (Upgrade)

Measurements Are Shown In Inches And (Millimeters)

WARNING: These products can expose you to chemicals, including Diisononyl Phthalate, Carbon black extracts, Nickel, 1,3 Butadiene, Ethylene Oxide, Epichlorohydrin, which are known to the State of California to cause cancer, and Bisphenol, Ethylene Glycol, Ethylene Oxide, 1,3 Butadiene, Epichlorohydrin, which are known to the State of California to cause birth defects or other reproductive harm. For more information go to www.P65Warnings.ca.gov.

PF7934 KIT



Set of 2 Fuel Elements
Notes: Filters not sold separately.
Contains: [1] Primary Fuel Element
[1] Secondary Fuel Element
Fits: Ford Super Duty Pickups with V8-391
(6.4L) DI Turbo Diesel Engine
Replaces: Ford 8C3Z-9N184-A; Motorcraft
FD4609; Wix 33950
Primary
O.D.: 3 5/16 (84.1)
I.D.: 1 19/32 (40.5)
Height: 4 13/32 (111.9)
O-Ring: [2] Included
Secondary
O.D. 3 9/16
I.D. 3/4
Height 4 23/32

PF7935



Fuel Element
Fits: M.A.N. Trucks
Replaces: M.A.N. 51.12503.0061,
51.12503.0063; Donaldson P785373; Fleetguard
FF5629
O.D.: 3 3/4 (95.3)
I.D.: 9/16 (14.3) & 1 13/16 (46.0)
Height: 6 27/32 (173.8)
A. Gskt: [1] Attached
O-Ring: [1] Included
Grommets: [2] Attached

PF7936



Fuel Element
Fits: Scania Trucks
Replaces: Scania 1459762; Donaldson
P550653; Fleetguard FF5463, FF5684
O.D.: 3 13/32 (86.5)
I.D.: 1 1/2 (38.1) One End
Height: 7 7/32 (183.4)
O-Ring: [1] Included
Grommets: [1] Attached

BF7937



In-Line Fuel Filter
Contains: 5/16 Inch Return Line
Fits: Chevrolet, GMC Light-Duty Trucks
Replaces: GMC 15077584; Wix 33100
O.D.: 2 11/32 (59.5)
Inlet: 3/8
Outlet: 3/8
Length: 7 1/2 (190.5)

PF7938



Fuel Element
Fits: R.V.I., Volvo Trucks
Replaces: Deutz 2931530, 4901031; Renault
2931711, 7420796772, 7420998806; Volvo
2931712, 20796775, 20998805
O.D.: 3 23/32 (94.5)
I.D.: 1 7/8 (47.6) One End
Height: 6 3/8 (161.9)
O-Ring: [1] Included

PF7939



Nylon Screen Fuel Element
Fits: Freightliner, M.A.N., Sterling Trucks
Replaces: M.A.N. 51.12503.0062; Freightliner
902051; Mercedes-Benz 902051, A0000902051
O.D.: 1 31/32 (50.0)
I.D.: 29/32 (23.0) & 1 19/32 (40.5)
Height: 1 5/8 (41.3)
O-Ring: [1] Included
Related To: PF7974 (Different O-Ring)

BF7940



Fuel Spin-on
Notes: CAUTION: Furnished End Seal must be
installed on post for seal.
Contains: Integral Post Seal
Fits: Ford, Freightliner, Kenworth, Peterbilt,
Sterling Trucks; Cummins ISB Engine
Replaces: Cummins 4934845; Fleetguard
FF5632
Thread: M20 x 1.5
O.D.: 3 11/16 (93.7)
Height: 7 7/32 (183.4)
A. Gskt: G401
F. Gskt: [1] Included

BF7941



Fuel/Water Separator Spin-on with Sensor Port
Contains: Integral Post Seal
Sensor Port Thread: M10 x 1.5
Fits: Cummins ISBE Engine; DAF Trucks
Replaces: DAF 1437070; Fleetguard FS19584
Thread: M20 x 1.5
O.D.: 3 23/32 (94.5)
Height: 7 9/32 (184.9)
I.Gskt: G381-A

BF7942



Fuel/Water Separator Spin-on with Sensor Port
Contains: Integral Post Seal
Sensor Port Thread: M14 x 2.0
Fits: Cummins ISBE Engine; DAF, Kenworth,
Peterbilt Trucks
Replaces: DAF 1618993; Fleetguard FS19689
Thread: M20 x 1.5
O.D.: 3 23/32 (94.5)
Height: 7 5/16 (185.7)
I.Gskt: G381-A

BF7943



Fuel Spin-on
Fits: Mack, Volvo Trucks
Replaces: Mack 20972295; Volvo 20972293
Thread: M32 x 1.5
O.D.: 4 1/4 (108.0)
Height: 10 15/32 (265.9)
I.Gskt: [1] Included

Measurements Are Shown In Inches And (Millimeters)

WARNING: These products can expose you to chemicals, including Diisononyl Phthalate, Carbon black extracts, Nickel, 1,3 Butadiene, Ethylene Oxide, Epichlorohydrin, which are known to the State of California to cause cancer, and Bisphenol, Ethylene Glycol, Ethylene Oxide, 1,3 Butadiene, Epichlorohydrin, which are known to the State of California to cause birth defects or other reproductive harm. For more information go to www.P65Warnings.ca.gov.

BF7944

In-Line Fuel Filter



Contains: [2] Plastic Caps
Fits: Cushman Equipment
Replaces: Jacobsen 2701898; Suzuki 15410-72F01
O.D.: 2 3/4 (69.9)
Inlet: 3/8
Outlet: 3/8
Length: 4 1/4 (108.0)

BF7945

In-Line Fuel Filter



Fits: Hyundai Automotive
Replaces: GMC 25313807; Hyundai 31911-29000
O.D.: 2 3/4 (69.9)
Inlet: M14 x 1.5
Outlet: 7/16
Length: 4 1/8 (104.8)

PF7946

Fuel Element



Fits: DAF Trucks
Replaces: DAF 1450184
O.D.: 3 9/16 (90.5)
I.D.: 3/4 (19.0) & 1 7/8 (47.6)
Height: 9 3/4 (247.7)
O-Ring: [1] Included

PF7947

Fuel Element



Fits: DAF Engines, Trucks
Replaces: DAF 1616361, 1643080, 1699168
O.D.: 3 9/16 (90.5)
I.D.: 3/4 (19.0) & 1 3/4 (44.4)
Height: 9 13/16 (249.2)
O-Ring: [1] Included
Grommets: [2] Attached

BF7948

Fuel Spin-on



Contains: Integral Post Seal
Fits: Komatsu Equipment
Replaces: Komatsu 600-319-3520, 600-319-3550
Thread: 1 5/8 - 12
O.D.: 4 11/16 (119.1)
Height: 11 9/32 (286.5)
I.Gskt: [1] Included

BF7949-D

Secondary Fuel/Water Separator Element with Removable Drain



Fits: John Deere Equipment
Replaces: John Deere RE522878
O.D.: 3 1/2 (88.9)
I.D.: 1 5/32 (29.4) One End
Height: 7 21/32 (194.5)
Grommets: [1] Attached

BF7949-DM

Secondary Fuel Element with Drain Plug



Fits: John Deere PowerTech 6068TFM (6.8L) Marine Engine
Replaces: John Deere RE521538
O.D.: 3 5/16 (84.1)
I.D.: 1 5/32 (29.4) One End
Height: 7 11/32 (186.5)
F. Gskt: [1] Included
Grommets: [1] Attached

BF7950-D

Primary Fuel/Water Separator Element with Removable Drain



Fits: John Deere Equipment
Replaces: John Deere RE529643
O.D.: 3 1/2 (88.9)
I.D.: 1 5/32 (29.4) One End
Height: 7 21/32 (194.5)
Grommets: [1] Attached

BF7951-D

Secondary Fuel/Water Separator Element with Removable Drain



Fits: Agco, Case-International, J.C. Bamford, Massey Ferguson, New Holland, Valtra Equipment; Iveco Engines
Replaces: Iveco 504107584
O.D.: 3 1/2 (88.9)
I.D.: 1 5/32 (29.4) One End
Height: 7 3/8 (187.3)
Grommets: [1] Attached

BF7952-D

Secondary Fuel/Water Separator Element with Removable Drain



Fits: John Deere Tractors
Replaces: John Deere RE522868; Wix 33739
O.D.: 3 1/2 (88.9)
I.D.: 5/8 (15.9) One End
Height: 6 (152.4)
Grommets: [1] Attached

BF7954-D

Primary Fuel/Water Separator Element with Removable Drain



Fits: Case, Case-International, John Deere, New Holland Equipment
Replaces: Case 87803445; New Holland 87803444
O.D.: 3 1/2 (88.9)
I.D.: 1 5/32 (29.4) One End
Height: 5 3/4 (146.0)
Grommets: [1] Attached

BF7955













Fuel Spin-on



Fits: Liebherr Equipment
Replaces: Liebherr 7382045; Fleetguard FF5427
Thread: M16 x 1.5
O.D.: 3 23/32 (94.5)
Height: 5 3/8 (136.5)
I.Gskt: G381-A
F. Gskt: [1] Included

Measurements Are Shown In Inches And (Millimeters)

WARNING: These products can expose you to chemicals, including Diisononyl Phthalate, Carbon black extracts, Nickel, 1,3 Butadiene, Ethylene Oxide, Epichlorohydrin, which are known to the State of California to cause cancer, and Bisphenol, Ethylene Glycol, Ethylene Oxide, 1,3 Butadiene, Epichlorohydrin, which are known to the State of California to cause birth defects or other reproductive harm. For more information go to www.P65Warnings.ca.gov.

<p>BF7956-D Primary Fuel/Water Separator Element with Removable Drain Fits: J.C. Bamford Equipment with 444 Diesel Max Engine Replaces: J.C. Bamford 32/925694 O.D.: 3 1/2 (88.9) I.D.: 1 5/32 (29.4) One End Height: 5 (127.0) Grommets: [1] Attached</p> 	<p>BF7963 In-Line Fuel Filter Fits: 1999-2004 Chevrolet Tracker Replaces: GMC 30020673; ACDelco GF826 O.D.: 2 15/16 (74.6) Inlet: 5/16 Outlet: 5/16 Length: 5 1/4 (133.4)</p> 
<p>BF7957 Fuel Spin-on Contains: Integral Post Seal Fits: Komatsu Equipment Replaces: Komatsu 6754-79-6130, 6754-79-6140 Thread: M20 x 1.5 O.D.: 3 11/16 (93.7) Height: 6 23/32 (170.7) I.Gskt: G401 F. Gskt: [1] Included</p> 	<p>BF7964-D Secondary Fuel/Water Separator Element with Removable Drain Notes: Reverse Flow Tab/Keys are not needed for installation. Replaces: Ford 2C11-9176-AA, 4386518; Motorcraft EFG331 O.D.: 3 9/32 (83.3) I.D.: 2 1/32 (16.7) One End Height: 6 25/32 (172.2) Grommets: [1] Attached</p> 
<p>BF7958 In-Line Fuel Filter with Drain Fits: Volkswagen Automotive Replaces: Volkswagen 1J0127401A, 1J0127401B; Wix 33619 O.D.: 3 15/32 (88.1) Inlet: 5/16 Outlet: 5/16 Length: 7 13/16 (198.4) O-Ring: [2] Included</p> 	<p>BF7965 In-Line Fuel/Water Separator with Drain Fits: J.C. Bamford Equipment Replaces: J.C. Bamford 320/07057, 320/07155; Donaldson P765325 O.D.: 3 3/8 (85.7) Inlet: 5/16 Outlet: 3/8 Length: 7 (177.8)</p> 
<p>BF7959 In-Line Fuel Filter Contains: 5/16 Inch Return Line Fits: Kia Automotive Replaces: Kia K2A1-20-490A, OK2A11-20-490A; Wix 33598 O.D.: 2 23/32 (69.1) Inlet: 5/16 Outlet: 5/16 Length: 6 3/16 (157.2)</p> 	<p>BF7966 Fuel Spin-on Notes: CAUTION: Furnished O-Ring must be installed on post for seal. Fits: Freightliner S2 Bus Chassis; Kawasaki 70ZV Loader; Kenworth Trucks Replaces: Cummins 3978040, 4897897; Fleetguard FF5421 Thread: M20 x 1.5 O.D.: 3 11/16 (93.7) Height: 7 7/32 (183.4) I.Gskt: G381-A F. Gskt: [1] Included</p> 
<p>BF7960 In-Line Fuel Filter Fits: Ford, Mazda Light-Duty Trucks Replaces: Ford XF5Z-9155-AA, XL5E-9155-AB; Mazda Z2P1-13-470, ZZR0-13-470 O.D.: 2 7/32 (56.4) Inlet: 3/8 Outlet: 5/16 Length: 7 3/32 (180.2)</p> 	<p>BF7967 Fuel Spin-on Fits: Hino Trucks Replaces: Hino 23401-1510, S23401-1510 Thread: 3/4 -16 O.D.: 3 3/32 (78.6) Height: 3 31/32 (100.8) I.Gskt: [1] Included</p> 
<p>BF7961 In-Line Fuel Filter Fits: Toyota Light-Duty Trucks Replaces: Toyota 23030-62010; Wix 33236 O.D.: 2 17/32 (64.3) Inlet: M14 x 1.5 Outlet: M14 x 1.5 Length: 3 3/4 (95.3)</p> 	<p>BF7968 Fuel Spin-on Fits: OMC Engines Replaces: Evinrude 502905, 174144; Johnson Marine 502905, 174144 Thread: 1 -12 O.D.: 3 11/16 (93.7) Height: 4 3/8 (111.1) I.Gskt: G381-A</p> 
<p>BF7962 In-Line Fuel Filter Contains: 5/16 Inch Return Line Fits: Kia Automotive Replaces: Kia K32A-20-490; ACDelco GF782 O.D.: 2 13/16 (71.4) Inlet: 5/16 Outlet: 5/16 Length: 7 1/16 (179.4)</p> 	

Measurements Are Shown In Inches And (Millimeters)

WARNING: These products can expose you to chemicals, including Diisononyl Phthalate, Carbon black extracts, Nickel, 1,3 Butadiene, Ethylene Oxide, Epichlorohydrin, which are known to the State of California to cause cancer, and Bisphenol, Ethylene Glycol, Ethylene Oxide, 1,3 Butadiene, Epichlorohydrin, which are known to the State of California to cause birth defects or other reproductive harm. For more information go to www.P65Warnings.ca.gov.

BF7968-O Fuel/Water Separator Spin-on with Open End for Bowl



Contains: Bowl Thread: 3 1/8-10 UN 1B
Fits: Racor B32012, B32014 Marine Fuel Systems
Replaces: Racor S3214
Thread: 1 -12
O.D.: 3 25/32 (96.0)
Height: 4 1/32 (102.4)
F. Gskt: [2] Included
O-Ring: [1] Included
Related To: BF7968

BF7969 Fuel Spin-on



Contains: Integral Post Seal
Fits: Volvo-Penta Marine Engines
Replaces: Volvo-Penta 38512182, 3852413, 3862228; Wix 33247
Thread: 13/16 -18
O.D.: 3 (76.2)
Height: 3 15/32 (88.1)
I.Gskt: G449-B

BF7970 Fuel Spin-on with Drain



Fits: Jeep Liberty; Iveco Light-Duty Trucks
Replaces: Chrysler 52129238AA; Iveco 2992300, 504018807; Fleetguard FS19781
Thread: M16 x 1.5
O.D.: 3 3/8 (85.7)
Height: 6 23/32 (170.7)
I.Gskt: [1] Included
Grommets: [1] Included

BF7971-D Fuel Element with Removable Drain



Notes: Reverse Flow
Fits: John Deere Equipment
Replaces: John Deere RE522966
O.D.: 3 5/16 (84.1)
I.D.: 1 5/32 (29.4) One End
Height: 7 5/8 (193.7)
Grommets: [1] Attached

BF7971-DM Primary Fuel Element with Removable Drain



Notes: Reverse Flow
Fits: John Deere PowerTech 6068TFM (6.8L) Marine Engine
Replaces: John Deere RE521540
O.D.: 3 5/16 (84.1)
I.D.: 1 5/32 (29.4) One End
Height: 7 11/32 (186.5)
A. Gskt: [1] Included
Grommets: [1] Attached

BF7972



In-Line Fuel Filter with Sensor Port
Notes: Sensor must be removed from old filter and reinstalled on BF7972.
Contains: 5/16 Inch Drainback Valve
Plastic Filter Collar
Fits: Dodge, Freightliner, Mercedes-Benz Sprinter Vans; Jeep Grand Cherokee
Replaces: Chrysler 5117494AA, 5170896AA, 5170896AB, 5175429AB; Mercedes-Benz A6420920101, A6460920701
O.D.: 3 19/32 (91.3)
Inlet: 3/8
Height: 5 (127.0)
O-Ring: [2] Included

PF7973



Fuel Element
Contains: Integral Housing Lid
Fits: John Deere Engines, Equipment, Gen Sets
Replaces: John Deere RE515345
O.D.: 4 5/8 (117.5)
Lid 6 (152.4)
I.D.: 13/16 (20.6) One End
Height: 9 19/32 (243.7)
I.Gskt: [1] Included
Grommets: [1] Attached

PF7974



Nylon Screen Fuel Element
Fits: Freightliner, Sterling Trucks; Mercedes-Benz Engines
Replaces: Mercedes-Benz 901351, A0000901351; Freightliner 901351
O.D.: 1 31/32 (50.0)
I.D.: 29/32 (23.0) & 1 19/32 (40.5)
Height: 1 5/8 (41.3)
O-Ring: [1] Included
Related To: PF7939 (Different O-Ring)

PF7975



Nylon Fuel Element
Fits: Volvo Excavators
Replaces: Volvo 7412921
O.D.: 1 3/8 (34.9)
I.D.: 7/16 (11.1) One End
Height: 1 15/16 (49.2)
O-Ring: [1] Attached

BF7976



Fuel/Water Separator Spin-on with Drain
Fits: Citroen, Fiat, Peugeot Vans
Replaces: Citroen 190666, 190667; Fiat 46797378
Thread: M16 x 1.5
O.D.: 3 9/32 (83.3)
Height: 6 3/16 (157.2)
I.Gskt: [1] Included
Grommets: [1] Attached

Measurements Are Shown In Inches And (Millimeters)

WARNING: These products can expose you to chemicals, including Diisononyl Phthalate, Carbon black extracts, Nickel, 1,3 Butadiene, Ethylene Oxide, Epichlorohydrin, which are known to the State of California to cause cancer, and Bisphenol, Ethylene Glycol, Ethylene Oxide, 1,3 Butadiene, Epichlorohydrin, which are known to the State of California to cause birth defects or other reproductive harm. For more information go to www.P65Warnings.ca.gov.

PF7977 Fuel/Water Separator Element
Fits: Dodge Light-Duty Trucks with Cummins 5.9L Diesel Engine
Replaces: Fleetguard FS19800
O.D.: 3 3/8 (85.7)
I.D.: 13/16 (20.6) One End
Height: 4 3/32 (104.0)
O-Ring: [1] Included
Grommets: [1] Attached



PF7978 Fuel/Water Separator Element
Fits: International Engines, Trucks
Replaces: International 1878042-C91; Donaldson P550824; Fleetguard FS19947
O.D.: 3 9/32 (83.3)
I.D.: 1/2 (12.7) One End
Height: 5 7/16 (138.1)
O-Ring: [2] Included
Grommets: [1] Attached



BF7979 Fuel/Water Separator Spin-on with Drain
Notes: CAUTION: Furnished Post Seal must be installed on post for seal.
Replaces: Ashok Leyland F8835100; Fleetguard FS19636
Thread: M20 x 1.5
O.D.: 3 23/32 (94.5)
Height: 7 31/32 (202.4)
I.Gskt: G401
F. Gskt: [1] Included



PF7980 Fuel/Water Separator Element
Replaces: Cummins 4084133; Fleetguard FF5511
O.D.: 5 27/32 (148.4)
I.D.: 1 3/8 (34.9)
Height: 9 7/8 (250.8)
Grommets: [2] Attached



BF7981 Fuel Spin-on with Sensor Port
Notes: CAUTION: Furnished O-Ring must be installed on post for seal.
Contains: Sensor Port Thread: M14 x 2.0
Replaces: Tata Cummins 278607989916; Fleetguard FS1275
Thread: 13/16 -18
O.D.: 3 11/16 (93.7)
Height: 6 1/8 (155.6)
I.Gskt: G401
F. Gskt: [2] Included
O-Ring: [2] Included



PF7982 Fuel Element
Fits: Case, Hitachi, J.C. Bamford, John Deere, Link-Belt Excavators; Mitsubishi Trucks
Replaces: Hitachi 4642641; Isuzu 8-98008-840-0; S-F Filter SK3160
O.D.: 3 23/32 (94.5)
I.D.: 1 1/32 (26.2) One End
Height: 5 15/32 (138.9)
O-Ring: [3] Included
Grommets: [1] Attached
Related To: PF9803 (Short Version) PF7983, PF7984 (Long Versions)



PF7983 Fuel Element
Fits: Hitachi, John Deere Equipment
Replaces: Hitachi 4649267, 4676385; Kobelco YN21P01068R100
O.D.: 3 23/32 (94.5)
I.D.: 1 1/32 (26.2) One End
Height: 6 13/32 (162.7)
O-Ring: [2] Included
Grommets: [1] Attached
Related To: PF7982, PF9803 (Short Versions) PF7984 (Long Version) PF9868 (With Furnished O-Rings)



PF7984 Fuel Element
Fits: John Deere Excavators
Replaces: Hitachi 4679981; Isuzu 8-98074-288-0; S-F Filter SK3022
O.D.: 3 23/32 (94.5)
I.D.: 1 1/32 (26.2) One End
Height: 7 15/16 (201.6)
F. Gskt: [1] Included
O-Ring: [1] Included
Grommets: [1] Attached
Related To: PF7982, PF7983, PF9803 (Short Versions)



BF7985 Fuel/Water Separator Spin-on with Sensor Port
Notes: CAUTION: Furnished O-Ring must be installed on post for seal.
Contains: Sensor Port Thread: 1 1/4-12
Replaces: Cummins 3890063; Tata Cummins 278609119903; Fleetguard FS1299
Thread: 13/16 -18
O.D.: 3 11/16 (93.7)
Height: 5 5/16 (134.9)
I.Gskt: G401
F. Gskt: [1] Included
O-Ring: [1] Included



PF7986 Fuel Element
Fits: International Engines, Trucks
Replaces: International 3004473-C91; Donaldson P550821
O.D.: 3 23/32 (94.5)
I.D.: 1/2 (12.7) & 1 3/4 (44.4)
Height: 6 27/32 (173.8)
O-Ring: [1] G379 (Viton) Included, [1] Nitrile Included
Grommets: [2] Attached



BF7987 Fuel Spin-on
Contains: Integral Post Seal
Fits: M.T.U. 12V2000, 16V2000, 18V2000 Engines
Replaces: M.T.U. 20920601; Fleetguard FF5641; Mahle KC231; Mann & Hummel WK940/17
Thread: 1 -12
O.D.: 3 23/32 (94.5)
Height: 5 21/32 (143.7)
I.Gskt: G401



Measurements Are Shown In Inches And (Millimeters)

WARNING: These products can expose you to chemicals, including Diisononyl Phthalate, Carbon black extracts, Nickel, 1,3 Butadiene, Ethylene Oxide, Epichlorohydrin, which are known to the State of California to cause cancer, and Bisphenol, Ethylene Glycol, Ethylene Oxide, 1,3 Butadiene, Epichlorohydrin, which are known to the State of California to cause birth defects or other reproductive harm. For more information go to www.P65Warnings.ca.gov.

BF7988

Fuel Spin-on



Contains: Integral Post Seal
Fits: M.T.U. 12V2000, 12V4000 Engines
Replaces: M.T.U. 20921901; Fleetguard FF5642; Mann & Hummel WK940/23; Wix 33821
Thread: 1 -12
O.D.: 3 23/32 (94.5)
Height: 5 21/32 (143.7)
I.Gskt: G401

BF7996

Fuel Spin-on



Contains: Integral Post Seal
Fits: M.T.U. 20V8000 Engine
Replaces: M.T.U. 20922101; Donaldson P765199; Fleetguard FF5710
Thread: M39 x 1.5
O.D.: 5 3/8 (136.5)
Height: 12 1/8 (308.0)
I.Gskt: [1] Included

BF7989-D

Fuel/Water Separator Element with Removable Drain



Fits: 11/2001-on R.V.I. Midlum Trucks all with dCi16 Engine
Replaces: Renault 5001846015; Fleetguard FS19810
O.D.: 3 9/32 (83.3)
I.D.: 21/32 (16.7) One End
Height: 6 25/32 (172.2)
Grommets: [1] Attached

BF7997

Fuel Spin-on



Fits: Fendt Tractors; Volvo Equipment
Replaces: Bomag 5717966; Deutz 1182672, 1182674; Fendt F934201060010; Volvo 20805349
Thread: M18 x 1.5
O.D.: 3 23/32 (94.5)
Height: 8 5/32 (207.2)
I.Gskt: [1] Included

BF7990

Fuel Spin-on



Contains: Integral Post Seal
Fits: Caterpillar Equipment
Replaces: Agco 525517D1; Caterpillar 299-8229
Thread: M12 x 1.5
O.D.: 3 1/16 (77.8)
Height: 5 1/2 (139.7)
I.Gskt: [1] Included
O-Ring: [1] Included

BF7998

Fuel/Water Separator Spin-on with Sensor Port



Notes: CAUTION: Furnished post seal must be installed on post for seal.
Contains: Post Seal
 Sensor Port Thread: M14 x 2.0
Fits: Case-International, New Holland Tractors
Replaces: Case 87803189; New Holland 87803187
Thread: M16 x 1.5
O.D.: 3 1/32 (77.0)
Height: 6 1/2 (165.1)
I.Gskt: G449-B

BF7993

Fuel Spin-on



Contains: Integral Post Seal
Fits: Furukawa, Kato, Kobelco, Link-Belt, MDI/Yutani, Sumitomo, Tadano Equipment; Mitsubishi Engines, Trucks
Replaces: Mitsubishi ME056670
Thread: M24 x 1.5
O.D.: 3 11/16 (93.7)
Height: 6 9/16 (166.7)
I.Gskt: [1] Included

BT8301

Hydraulic Spin-on



Fits: Bolens, Ford, Hitachi, Husky, John Deere Equipment
Replaces: John Deere AM39653
Thread: 3/4 -16
O.D.: 3 3/4 (95.3)
Height: 3 31/32 (100.8)
I.Gskt: G381-A

PF7994

Nylon Mesh Fuel Strainer



Fits: International Trucks all with MaxxForce DT, MaxxForce 7, MaxxForce 9, MaxxForce 10 Engines
Replaces: International 1873910-C91
O.D.: 1 11/16 (42.9)
I.D.: 1 13/32 (35.7) One End
Height: 2 27/32 (72.2)
O-Ring: [1] Included

BT8302

Hydraulic Spin-on



Contains: Anti-Drainback Valve
 30 PSID By-Pass Valve
 Standpipe
Fits: Fiat-Allis Equipment
Replaces: Fiat 79026104
Thread: 1 -12
O.D.: 4 1/4 (108.0)
Height: 9 3/16 (233.4)
I.Gskt: G401

BF7995

Fuel Storage Tank Spin-on



Replaces: Partmo A70015
Thread: 1 1/2 -16
O.D.: 3 3/4 (95.3)
Height: 5 9/16 (141.3)
I.Gskt: [1] Included

BT8304

Hydraulic Spin-on



Fits: Joy Compressors
Replaces: Joy 1228337-20
Thread: M38 x 2.0
O.D.: 3 11/16 (93.7)
Height: 5 9/16 (141.3)
I.Gskt: [1] Included

Measurements Are Shown In Inches And (Millimeters)

WARNING: These products can expose you to chemicals, including Diisononyl Phthalate, Carbon black extracts, Nickel, 1,3 Butadiene, Ethylene Oxide, Epichlorohydrin, which are known to the State of California to cause cancer, and Bisphenol, Ethylene Glycol, Ethylene Oxide, 1,3 Butadiene, Epichlorohydrin, which are known to the State of California to cause birth defects or other reproductive harm. For more information go to www.P65Warnings.ca.gov.

PT8305



Hydraulic Element
Fits: Vickers Hydraulic Applications
Replaces: Vickers 404211
O.D.: 3 15/16 (100.0)
I.D.: 2 9/32 (57.9) One End
Height: 17 15/16 (455.6)

PT8306-10



Hydraulic Element
Fits: Zinga Hydraulic Applications
Replaces: Elgin 1032085; Zinga RE409-10
O.D.: 3 15/16 (100.0)
I.D.: 1 15/16 (49.2)
Height: 9 1/4 (235.0)
End Seals: [2] Attached
Related To: PT8306-25 (Media Difference)

PT8306-25



Hydraulic Element
Fits: Zinga Hydraulic Applications
Replaces: Zinga RE409-25
O.D.: 3 15/16 (100.0)
I.D.: 1 15/16 (49.2)
Height: 9 1/4 (235.0)
End Seals: [2] Attached
Related To: PT8306-10 (Media Difference)

BT8307-MPG



Maximum Performance Glass Hydraulic Spin-on
Notes: Can be used with OB1314 and OB1316 bases (requires optional G286-C gasket).
Fits: Gleaner, Swinger, Vermeer Equipment
Replaces: Hycon MFE16010BN2; Pall HC7500SUN4H, HC7500SUS4H
Thread: 1 1/2 -16
O.D.: 5 1/16 (128.6)
Height: 6 31/32 (177.0)
F. Gskt: G369-B
O. Gskt: G286-C, G369-V, G372, G447, G483, G704, G710
Related To: BT8421-MPG (Micron Difference)

BT8308-MPG



Maximum Performance Glass Hydraulic Spin-on
Notes: Can be used with OB1314 and OB1316 bases (requires optional G286-C gasket).
Fits: Ag-Chem, Agco, Case, Volvo Equipment; Ingersoll-Rand Compressors
Replaces: Case A177614, A177615; Gradall 91143144; Ingersoll-Rand 51608503; Pall HC7500SUN8H
Thread: 1 1/2 -16
O.D.: 5 1/16 (128.6)
Height: 10 3/4 (273.1)
F. Gskt: G369-B
O-Ring: G447
O. Gskt: G286-C, G369-V, G372, G483, G704, G710
Related To: BT8422-MPG (High Efficiency Version)

BT8308-MPG KI Set of 2 Maximum Performance Glass Hydraulic Spin-ons



Notes: Can be used with OB1314 and OB1316 bases (requires optional G286-C gasket).
Fits: Ag-Chem, Agco, Case, Volvo Equipment; Ingersoll-Rand Compressors
Replaces: Case A177614, A177615; Ingersoll-Rand 51608503; Pall HC7500SUN8H
Thread: 1 1/2 -16
O.D.: 5 1/16 (128.6)
Height: 10 3/4 (273.1)
F. Gskt: G369-B, G447
O. Gskt: G286-C, G369-V, G372, G483, G704, G710
Related To: BT8422-MPG (High Efficiency Version)

BT8309-MPG Maximum Performance Glass Hydraulic Spin-on



Notes: Can be used with OB1314 and OB1316 bases (requires optional G286-C gasket).
Fits: John Deere Equipment
Replaces: John Deere AT100973, RE45864
Thread: 1 1/2 -16
O.D.: 5 1/16 (128.6)
Height: 6 31/32 (177.0)
F. Gskt: G369-B, G447
O. Gskt: G286-C, G369-V, G372, G483, G704, G710

BT8310-MPG Maximum Performance Glass Hydraulic Spin-on



Notes: Can be used with OB1314 and OB1316 bases (requires optional G286-C gasket).
Fits: Champion Equipment
Replaces: Pall HC7500SUT8H
Thread: 1 1/2 -16
O.D.: 5 1/16 (128.6)
Height: 10 3/4 (273.1)
F. Gskt: G369-B
O. Gskt: G286-C, G369-V, G372, G447, G483, G704, G710

BT8312



Hydraulic Spin-on
Fits: Case Equipment
Use With: OB8711, OB8712, OB8720, OB8721, OB8722, OB8724, OB8731, OB8732, OB8741, OB8742, OB8743, OB8744, OB8745, OB8746 bases.
Replaces: Case L36242
Thread: 1 3/8 -12
O.D.: 3 3/4 (95.3)
Height: 9 19/32 (243.7)
I.Gskt: [1] Included

BT8314





Hydraulic Spin-on
Fits: Caterpillar Equipment
Replaces: Caterpillar 4T6915
Thread: 1 1/8 -16
O.D.: 3 11/16 (93.7)
Height: 5 5/8 (142.9)
I.Gskt: G381-A

Measurements Are Shown In Inches And (Millimeters)

WARNING: These products can expose you to chemicals, including Diisononyl Phthalate, Carbon black extracts, Nickel, 1,3 Butadiene, Ethylene Oxide, Epichlorohydrin, which are known to the State of California to cause cancer, and Bisphenol, Ethylene Glycol, Ethylene Oxide, 1,3 Butadiene, Epichlorohydrin, which are known to the State of California to cause birth defects or other reproductive harm. For more information go to www.P65Warnings.ca.gov.

BT8316-MPG Maximum Performance Glass Transmission Spin-on

Fits: Allison Transmissions
Replaces: Allison 23042062
Thread: 1 1/2 -16
O.D.: 3 11/16 (93.7)
Height: 5 9/16 (141.3)
F. Gskt: [1] Included

PT8329 Hydraulic Element

Contains: Spring Reinforced Centertube
Fits: Tamrock Drills
Replaces: Schroeder CC3
O.D.: 2 7/8 (73.0)
I.D.: 1 (25.4) One End
Height: 9 5/8 (244.5)
O-Ring: [1] Attached

PT8318-MPG Maximum Performance Glass Transmission Element

Fits: John Deere Equipment
Replaces: John Deere RE15472
O.D.: 4 9/16 (115.9)
I.D.: 2 7/32 (56.4)
Height: 5 15/32 (138.9)
A. Gskt: [2] Attached

PT8330-MPG Maximum Performance Glass Hydraulic Element

Fits: Allison Transmissions
Replaces: Allison 23040988
O.D.: 3 7/32 (81.8)
I.D.: 1 7/16 (36.5) One End
Height: 8 1/8 (206.4)
O-Ring: [1] Attached

PT8319 Hydraulic Element

Fits: Fiat, Fiat-Allis, Hitachi Equipment
Replaces: Fiat 71402469; Hitachi 4207841, 4207841A
O.D.: 1 31/32 (50.0)
I.D.: 27/32 (21.4)
Height: 5 29/32 (150.0)
O-Ring: [1] Included
Grommets: [1] Attached

PT8331-MPG Maximum Performance Glass Hydraulic Element

Contains: Reinforced Centertube
Fits: Case Equipment
Replaces: Case L52029, R51643
O.D.: 4 1/2 (114.3)
I.D.: 15/32 (11.9) & 2 1/4 (57.2)
Height: 9 (228.6)
F. Gskt: [1] Included
Grommets: [1] Attached Small End

BT8320 Hydraulic Spin-on

Fits: Case, John Deere, New Holland Equipment
Use With: OB8711, OB8712, OB8720, OB8721, OB8722, OB8724, OB8731, OB8732, OB8741, OB8742, OB8743, OB8744, OB8745, OB8746 bases
Replaces: Case D149921
Thread: 1 3/8 -12
O.D.: 4 23/32 (119.9)
Height: 11 17/32 (292.9)
I.Gskt: [1] Included

BT8333 Hydraulic Spin-on

Notes: Rated 2000 PSI minimum burst
Contains: Integral Post Seal
Fits: Caterpillar Equipment
Replaces: Caterpillar 413948
Thread: 2 -12
O.D.: 3 1/8 (79.4)
Height: 5 17/32 (140.5)

BT8323 Hydraulic Spin-on

Contains: 20 PSID By-Pass Valve
Fits: Bush Hog Lawn Tractors; Zinga Hydraulic Systems
Replaces: Zinga BE10-18
Thread: 3/4 -16
O.D.: 3 1/32 (77.0)
Height: 3 1/2 (88.9)
I.Gskt: [1] Included

BT8334 By-Pass Lube Element with Bail Handle

Contains: Reinforced Centertube
Fits: Hitachi Excavators
Replaces: Hitachi 4208241
Thread: M16 x 1.0
O.D.: 6 1/2 (165.1)
Height: 7 3/4 (196.9)
F. Gskt: [1] Included
O-Ring: [2] Included

BT8328 Hydraulic Spin-on

Contains: Anti-Drainback Valve
8 PSID By-Pass Valve
Fits: Ford Light-Duty Trucks, Vans; Sellick Lift Trucks
Replaces: Sellick 131559
Thread: 3/4 -16
O.D.: 3 11/16 (93.7)
Height: 5 15/32 (138.9)
I.Gskt: G401

PT8335 Lube Element

Contains: Bleed Hole
Fits: Kobelco Loaders; Nissan Trucks
Replaces: Kobelco 2451R131-1B; Nissan 15274-99027
O.D.: 5 1/16 (128.6)
I.D.: 19/32 (15.1)
Height: 9 3/8 (238.1)
F. Gskt: [3] Included
Grommets: [2] Attached

Measurements Are Shown In Inches And (Millimeters)

WARNING: These products can expose you to chemicals, including Diisononyl Phthalate, Carbon black extracts, Nickel, 1,3 Butadiene, Ethylene Oxide, Epichlorohydrin, which are known to the State of California to cause cancer, and Bisphenol, Ethylene Glycol, Ethylene Oxide, 1,3 Butadiene, Epichlorohydrin, which are known to the State of California to cause birth defects or other reproductive harm. For more information go to www.P65Warnings.ca.gov.

PT8338

Transmission Element



Fits: Kawasaki, Kobelco Equipment
Replaces: Kawasaki KL49060-70010
O.D.: 4 7/32 (107.2)
I.D.: 1 13/16 (46.0)
Height: 9 1/32 (229.4)
F. Gskt: [3] Included
End Seals: [2] Attached

PT8350

Hydraulic Element



Fits: Caterpillar Equipment
Replaces: Caterpillar 1R0746
O.D.: 2 7/8 (73.0)
I.D.: 1 1/16 (27.0) One End
Height: 5 5/8 (142.9)
End Seals: [1] Attached

PT8339

Hydraulic Element



Fits: Caterpillar Excavators
Replaces: Caterpillar 95-5481
O.D.: 4 1/2 (114.3)
I.D.: 2 9/32 (57.9) One End
Height: 7 3/16 (182.6)
F. Gskt: [1] Included
End Seals: [1] Attached

PT8351

Hydraulic Element



Fits: Hitachi Equipment
Replaces: Hitachi 3021593
O.D.: 2 7/8 (73.0)
I.D.: 1 11/32 (34.1)
Height: 7 15/16 (201.6)
A. Gskt: [2] Attached
F. Gskt: [1] Included

PT8341

Hydraulic Element



Fits: Caterpillar Equipment
Replaces: Caterpillar 96-6431, 99-7352
O.D.: 1 31/32 (50.0)
I.D.: 27/32 (21.4) One End
Height: 3 3/32 (78.6)
O-Ring: [1] Included
Grommets: [1] Attached

PT8352

Hydraulic Element



Fits: Daewoo, Hitachi Equipment
Replaces: Hitachi 4159320
O.D.: 2 7/8 (73.0)
I.D.: 1 11/32 (34.1) One End
Height: 4 25/32 (121.4)
A. Gskt: [2] Attached
F. Gskt: G283, [1] Included

PT8344

Hydraulic Element



Fits: Belarus Tractors
Replaces: Belarus 761000000
O.D.: 3 21/32 (92.9)
I.D.: 1 23/32 (43.7)
Height: 7 7/8 (200.0)

PT8353

Hydraulic Element



Notes: Inside-Out Flow Direction
Fits: Atlas-Weyhausen, Poclain, Volvo, Zettelmeyer Equipment
Replaces: Poclain N0250574; Volvo 6638403; Zettelmeyer 2165400
O.D.: 4 5/32 (105.6)
I.D.: 13/32 (10.3) & 2 3/4 (69.9)
Height: 10 1/4 (260.3)
Grommets: [1] Attached

PT8345

Hydraulic Element



Fits: Kobelco Loaders
Replaces: Kobelco 2446U139-F1
O.D.: 3 3/4 (95.3)
I.D.: 19/32 (15.1) & 1 5/16 (33.3)
Height: 6 1/8 (155.6)
F. Gskt: [3] Included
End Seals: [1] Attached
Grommets: [1] Attached

PT8354

Hydraulic Element



Fits: Kobelco Loaders
Replaces: Kobelco 2446U126
O.D.: 2 7/8 (73.0)
I.D.: 1 11/32 (34.1) One End
Height: 6 9/32 (159.5)
A. Gskt: [1] Attached
F. Gskt: [1] Included

BT8347

Hydraulic Spin-on



Fits: John Deere Tractors
Replaces: John Deere AL56469
Thread: 1 -12
O.D.: 3 23/32 (94.5)
Height: 7 7/32 (183.4)
I.Gskt: G401

PT8355

Hydraulic Element



Fits: Kobelco Equipment
Replaces: Kobelco 2446R204-S3
O.D.: 2 7/8 (73.0)
I.D.: 1 11/32 (34.1) One End
Height: 5 15/32 (138.9)
A. Gskt: [1] Attached

Measurements Are Shown In Inches And (Millimeters)

WARNING: These products can expose you to chemicals, including Diisononyl Phthalate, Carbon black extracts, Nickel, 1,3 Butadiene, Ethylene Oxide, Epichlorohydrin, which are known to the State of California to cause cancer, and Bisphenol, Ethylene Glycol, Ethylene Oxide, 1,3 Butadiene, Epichlorohydrin, which are known to the State of California to cause birth defects or other reproductive harm. For more information go to www.P65Warnings.ca.gov.

<p>PT8356 Hydraulic Element Fits: Kobelco Equipment Replaces: Kobelco 2451R124-1 O.D.: 3 19/32 (91.3) I.D.: 21/32 (16.7) Height: 6 5/8 (168.3) F. Gskt: [2] Included Grommets: [2] Attached</p> 	<p>BT8368 Stainless Steel Mesh Hydraulic Spin-on Fits: Fiat-Allis Equipment Use With: OB1313, OB1314, OB1315, OB1316 bases (requires optional G286-C gasket). Replaces: Fiat 73133001; Zinga LE100 Thread: 1 1/2 -16 O.D.: 5 1/16 (128.6) Height: 10 3/4 (273.1) F. Gskt: G369-B O. Gskt: G286-C, G369-V, G372, G447, G483, G704, G710</p> 
<p>BT8357 Hydraulic Spin-on Contains: 20 PSID By-Pass Valve Fits: Ford, New Holland Tractors Replaces: Ford F0NN-B486-AA Thread: 1 1/8 -16 O.D.: 3 11/16 (93.7) Height: 6 5/8 (168.3) I.Gskt: G381-A</p> 	<p>PT8370-MPG Maximum Performance Glass Hydraulic Element Fits: Schroeder Hydraulic Systems Replaces: Pall HC9700FDP9H, HC9700FKP9H, HC9700FUP9H; Parker 925778; Schroeder KS1 O.D.: 3 29/32 (99.2) I.D.: 1 13/16 (46.0) Height: 9 3/32 (231.0) Grommets: [2] Attached</p> 
<p>PT8359 Hydraulic Element Fits: Daewoo, Hitachi Equipment Replaces: Hitachi 3502410N O.D.: 3 3/8 (85.7) I.D.: 1 7/8 (47.6) Height: 11 7/16 (290.5) F. Gskt: G162 O-Ring: [2] Attached</p> 	<p>PT8371-MPG Maximum Performance Glass Hydraulic Element Fits: Donaldson Assemblies Replaces: Donaldson P165628 O.D.: 4 3/8 (111.1) I.D.: 2 7/16 (61.9) Height: 16 (406.4) A. Gskt: [1] Attached Grommets: [1] Attached</p> 
<p>PT8361 Hydraulic Element Fits: Bantam, John Deere, Koehring, Lorain Equipment Replaces: Koehring 708-6449 O.D.: 6 1/2 (165.1) I.D.: 3 15/32 (88.1) Height: 15 1/4 (387.4) O-Ring: [2] Attached</p> 	<p>PT8372 Hydraulic Element Fits: Kobelco, MDI/Yutani Equipment Replaces: Kobelco R36P0019 O.D.: 1 21/32 (42.1) I.D.: 29/32 (23.0) One End Height: 3 15/32 (88.1) O-Ring: [1] Attached</p> 
<p>PT8363 Hydraulic Element Fits: Caterpillar, Grove Equipment; Schroeder Hydraulic Systems Replaces: Caterpillar 837905; Grove 9437100641; Pall HC9700FDS9H; Schroeder KS7, KZ10 O.D.: 3 15/16 (100.0) I.D.: 1 9/16 (39.7) Height: 9 5/32 (232.6) Grommets: [2] Attached</p> 	<p>PT8375-MPG Maximum Performance Glass Hydraulic Element Fits: Timberjack Logging Equipment Replaces: Timberjack 411531 O.D.: 4 3/8 (111.1) I.D.: 2 1/32 (51.6) One End Height: 8 (203.2) O-Ring: [1] Attached</p> 
<p>PT8366 Hydraulic Element Fits: Caterpillar, Hitachi, Kobelco, Komatsu, MDI/Yutani, Mitsubishi Equipment Replaces: Caterpillar 94-4412; Hitachi 4219713; Komatsu 178-611-4160 O.D.: 5 29/32 (150.0) I.D.: 4 11/32 (110.3) Height: 17 23/32 (450.1) F. Gskt: [1] Included O. Gskt: ES3231</p> 	

Measurements Are Shown In Inches And (Millimeters)

WARNING: These products can expose you to chemicals, including Diisononyl Phthalate, Carbon black extracts, Nickel, 1,3 Butadiene, Ethylene Oxide, Epichlorohydrin, which are known to the State of California to cause cancer, and Bisphenol, Ethylene Glycol, Ethylene Oxide, 1,3 Butadiene, Epichlorohydrin, which are known to the State of California to cause birth defects or other reproductive harm. For more information go to www.P65Warnings.ca.gov.

PT8376-MPG Maximum Performance Glass Hydraulic Element



Replaces: Parker 908649
O.D.: 5 11/16 (144.5)
I.D.: 4 3/32 (104.0)
Height: 12 1/8 (308.0)
A. Gskt: [2] Attached

PT8383 Hydraulic Element



Contains: Reinforced Centertube
Fits: Hitachi Excavators
Replaces: Hitachi 4325820
O.D.: 5 29/32 (150.0)
I.D.: 4 11/32 (110.3)
Height: 17 29/32 (454.8)
A. Gskt: [2] Attached
F. Gskt: [1] Included

PT8378-MPG Maximum Performance Glass Hydraulic Element



Fits: Leach Packers
Replaces: Leach 100815, 107408
O.D.: 3 23/32 (94.5)
I.D.: 1 23/32 (43.7) One End
Height: 9 1/16 (230.2)
Grommets: [1] Attached

BT8384 Hydraulic Spin-on



Contains: 50 PSID By-Pass Valve
Fits: Liebherr, VogeLe Equipment
Replaces: Case 45144600; Linde 983-06-13, 983-06-18, 983-06-23
Thread: 3/4 -16
O.D.: 3 1/32 (77.0)
Height: 5 1/2 (139.7)
I.Gskt: [1] Included

PT8380 Wire Mesh Supported Hydraulic Element

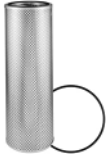

Fits: Hitachi, John Deere Equipment
Replaces: John Deere AT127608, AT147343
O.D.: 5 29/32 (150.0)
I.D.: 4 11/32 (110.3)
Height: 17 7/8 (454.0)
A. Gskt: [2] Attached
F. Gskt: [1] Included

PT8385 Hydraulic Element



Fits: DAF, Iveco, M.A.N., R.V.I., Volvo Trucks
Replaces: Volvo 1193281, 1193281-1
O.D.: 2 23/32 (69.1)
I.D.: 1 3/8 (34.9) One End
Height: 4 1/16 (103.2)
F. Gskt: [2] Included

BT8381 Hydraulic Spin-on



Fits: Dresser Equipment
Replaces: Dresser 1214275-H2
Thread: 1 1/2 -16
O.D.: 4 21/32 (118.3)
Height: 11 3/4 (298.5)
I.Gskt: [1] Included

BT8386 Hydraulic Breather Element



Fits: Clark Lift Trucks
Replaces: Clark 2370631
O.D.: 3 1/32 (77.0)
I.D.: 1 19/32 (40.5)
Height: 2 7/32 (56.4)

BT8382 Hydraulic Spin-on



Contains: 15 PSID By-Pass Valve
Fits: Ford, New Holland Tractors
Replaces: Ford F0NN-B486-BB; New Holland 82005016
Thread: 1 3/4 -16
O.D.: 5 3/8 (136.5)
Height: 9 5/8 (244.5)
I.Gskt: [1] Included

PT8387 Hydraulic Element



Contains: Reinforced Centertube
Fits: Kobelco, MDI/Yutani Equipment
Replaces: Kobelco 24046Z15
O.D.: 4 13/32 (111.9)
I.D.: 2 3/4 (69.9)
Height: 17 11/16 (449.3)
F. Gskt: [1] Included

PT8388 Hydraulic Element



Contains: Reinforced Centertube
Fits: Daewoo Equipment; Hitachi Excavators
Replaces: Hitachi 4227353
O.D.: 4 13/32 (111.9)
I.D.: 2 9/16 (65.1)
Height: 18 1/32 (458.0)
A. Gskt: [2] Attached
F. Gskt: [2] Included

Measurements Are Shown In Inches And (Millimeters)

WARNING: These products can expose you to chemicals, including Diisononyl Phthalate, Carbon black extracts, Nickel, 1,3 Butadiene, Ethylene Oxide, Epichlorohydrin, which are known to the State of California to cause cancer, and Bisphenol, Ethylene Glycol, Ethylene Oxide, 1,3 Butadiene, Epichlorohydrin, which are known to the State of California to cause birth defects or other reproductive harm. For more information go to www.P65Warnings.ca.gov.

BT8391 Hydraulic Spin-on
Fits: Ford, New Holland Tractors
Replaces: Ford SBA340500610; New Holland 9846407
Thread: 1 1/8 -16
O.D.: 3 11/16 (93.7)
Height: 5 21/32 (143.7)
I.Gskt: G401



BT8397-MPG Maximum Performance Glass Hydraulic Spin-on
Fits: John Deere Equipment
Replaces: John Deere AT147496
Thread: 1 1/2 -16
O.D.: 3 15/16 (100.0)
Height: 9 1/2 (241.3)
I.Gskt: [1] Included



PT8392 Hydraulic Element
Fits: Bobcat, Case, Daewoo, Hitachi, Hyundai, Volvo Equipment
Replaces: Case 153233A1; Clark 6655066; Hyundai 31E30018
O.D.: 1 21/32 (42.1)
I.D.: 27/32 (21.4) One End
Height: 3 7/16 (87.3)
I.Gskt: [1] Included
O-Ring: [1] Included



PT8400-MPG Maximum Performance Glass Hydraulic Element
Fits: J.C. Bamford Equipment
Replaces: J.C. Bamford 581/05601, 581/06301
O.D.: 2 27/32 (72.2)
I.D.: 9/32 (7.1) & 1 25/32 (45.2)
Height: 11 13/16 (300.0)



BT8393 Hydraulic Spin-on
Contains: 15 PSID By-Pass Valve
Fits: Ford, New Holland Tractors
Replaces: Ford F0NN-3N976-AA; New Holland 81869132
Thread: 1 1/8 -16
O.D.: 3 11/16 (93.7)
Height: 8 3/16 (208.0)
I.Gskt: G401



BT8401-MPG Maximum Performance Glass Hydraulic Spin-on
Fits: Ingersoll-Rand Compressors
Use With: OB8771, OB8772, OB8773 filter bases.
Replaces: Ingersoll-Rand 39796982
Thread: 1 3/4 -12
O.D.: 4 23/32 (119.9)
Height: 11 17/32 (292.9)
I.Gskt: [1] Included



PT8394-MPG Maximum Performance Glass Hydraulic Element
Replaces: Parker 924795
O.D.: 3 21/32 (92.9)
I.D.: 1 3/4 (44.4)
Height: 18 1/2 (469.9)
Grommets: [2] Attached



PT8403-MPG Maximum Performance Glass Hydraulic Element
Contains: Reinforced Centertube
Fits: Caterpillar Equipment
Replaces: Caterpillar 132-8875
O.D.: 3 15/16 (100.0)
I.D.: 2 9/32 (57.9)
Height: 9 5/16 (236.5)
End Seals: [2] Attached



PT8395 Hydraulic Element
Fits: Dresser, Hough Loaders
Replaces: International 940241-C2
O.D.: 7 7/16 (188.9)
I.D.: 4 13/16 (122.2)
Height: 18 1/16 (458.8)
A. Gskt: [2] Attached

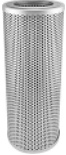

PT8404-MPG Maximum Performance Glass Hydraulic Element
Fits: Kobelco, MDI/Yutani Equipment
Replaces: Kobelco 2446U233-S2
O.D.: 3 23/32 (94.5)
I.D.: 1 15/16 (49.2) One End
Height: 9 3/16 (233.4)
A. Gskt: [1] Attached



PT8396 Hydraulic Element
Fits: V.M.E., Volvo Loaders
Replaces: Volvo M2560232
O.D.: 7 7/16 (188.9)
I.D.: 4 13/16 (122.2)
Height: 18 5/32 (461.2)
A. Gskt: [2] Attached

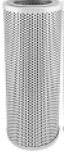

Measurements Are Shown In Inches And (Millimeters)

WARNING: These products can expose you to chemicals, including Diisononyl Phthalate, Carbon black extracts, Nickel, 1,3 Butadiene, Ethylene Oxide, Epichlorohydrin, which are known to the State of California to cause cancer, and Bisphenol, Ethylene Glycol, Ethylene Oxide, 1,3 Butadiene, Epichlorohydrin, which are known to the State of California to cause birth defects or other reproductive harm. For more information go to www.P65Warnings.ca.gov.

PT8407 Power Steering Element
Contains: 8 PSID By-Pass Valve
Fits: Freightliner, International Buses, Trucks
Replaces: Ford F0HZ-3C602-A; International 1681202-C91
O.D.: 4 1/32 (102.4)
I.D.: 7/16 (11.1) & 2 7/16 (61.9)
Height: 4 5/32 (105.6)
A. Gskt: [1] Attached



BT8413 Transmission Spin-on
Fits: Saturn Automotive
Replaces: Saturn 21002303, 21002496, 21003298
Thread: 3/4 -20
O.D.: 3 1/32 (77.0)
Height: 3 1/2 (88.9)
I.Gskt: [1] Included



PT8408 Hydraulic Element
Contains: Reinforced Centertube
Fits: John Deere Equipment
Replaces: John Deere TH103699, TH111010
O.D.: 4 13/32 (111.9)
I.D.: 2 19/32 (65.9)
Height: 18 (457.2)
O-Ring: [2] Included



PT8414-MPG Maximum Performance Glass Hydraulic Element
Fits: Broyt, V.M.E., Volvo Equipment
Replaces: Volvo 6210359, 6635975, 11026934-7, 11996150-6
O.D.: 4 31/32 (126.2)
I.D.: 13/32 (10.3) & 3 5/8 (92.1)
Height: 11 7/16 (290.5)
Related To: PT722 (Standard Media Version)



BT8409 Lube or Transmission Spin-on
Contains: Anti-Drainback Valve
 14 PSID By-Pass Valve
Fits: 2011 Mazda Tribute; Case, Case-International, Komatsu, New Holland, Vermeer Equipment
Replaces: Agco 700723604; Case 87409203; Komatsu 600-211-2110; New Holland 87415600
Thread: 3/4 -16
O.D.: 3 (76.2)
Height: 3 17/32 (89.7)
I.Gskt: [1] Included



BT8415 Transmission Spin-on
Contains: 30 PSID By-Pass Valve
 Stud Thread: M24 x 1.5
Fits: John Deere Equipment
Replaces: John Deere AT179323
Thread: 1 -12
O.D.: 3 11/16 (93.7)
Height: 6 1/16 (154.0)
I.Gskt: G401



PT8410 Hydraulic Element
Contains: Reinforced Centertube
Fits: J.C. Bamford Equipment
Replaces: J.C. Bamford 581/01801
O.D.: 6 7/8 (174.6)
I.D.: 3 5/8 (92.1)
Height: 14 3/16 (360.4)
A. Gskt: [2] Attached



BT8416 Hydraulic Spin-on
Fits: John Deere, Toro Lawn & Garden Equipment; Bobcat Equipment
Use With: OB8711, OB8712, OB8720, OB8721, OB8722, OB8724, OB8731, OB8732, OB8741, OB8742, OB8743, OB8744, OB8745, OB8746 bases.
Replaces: John Deere AM102723; Stens 120842; Toro 75-1330
Thread: 1 3/8 -12
O.D.: 3 3/4 (95.3)
Height: 4 17/32 (115.1)
I.Gskt: [1] Included



PT8411 Hydraulic Element
Contains: Reinforced Centertube
Fits: J.C. Bamford Equipment
Replaces: J.C. Bamford 32/901200
O.D.: 6 29/32 (175.4)
I.D.: 2 1/32 (16.7) & 3 5/8 (92.1)
Height: 9 13/32 (238.9)
A. Gskt: [1] Attached



BT8417 Transmission Spin-on
Contains: 30 PSID By-Pass Valve
Fits: Caterpillar, Manitou, New Holland Equipment
Replaces: Caterpillar 6E0924, 119-4740; New Holland 9968353, 9969450
Thread: 13/16 -16
O.D.: 3 1/32 (77.0)
Height: 4 13/16 (122.2)
I.Gskt: G449-B



BT8412 In-Line Hydraulic Filter
Contains: 15 PSID By-Pass Valve
Fits: Toyota Lift Trucks
Replaces: Toyota 67502-23000-71
O.D.: 4 1/4 (108.0)
Inlet: 1-14
Outlet: 1 1/16
Length: 5 11/32 (135.7)











BT8418 Hydraulic Spin-on
Notes: 2000 PSI minimum burst
Fits: Caterpillar Equipment
Replaces: Caterpillar 413950
Thread: 2 -12
O.D.: 3 1/8 (79.4)
Height: 9 17/32 (242.1)
I.Gskt: [1] Included



Measurements Are Shown In Inches And (Millimeters)

WARNING: These products can expose you to chemicals, including Diisononyl Phthalate, Carbon black extracts, Nickel, 1,3 Butadiene, Ethylene Oxide, Epichlorohydrin, which are known to the State of California to cause cancer, and Bisphenol, Ethylene Glycol, Ethylene Oxide, 1,3 Butadiene, Epichlorohydrin, which are known to the State of California to cause birth defects or other reproductive harm. For more information go to www.P65Warnings.ca.gov.

<p>PT8419</p> 	<p>In-Tank Hydraulic Element Notes: Inside-Out Flow Direction. For use on return side. Contains: 21-24 PSID By-Pass Valve Fits: Komatsu Lift Trucks Replaces: Komatsu 3EB66-11711, 3EB66-11711L O.D.: 3 9/16 (90.5) Inlet: 3/4 In. NPT Height: 6 17/32 (165.9)</p>	<p>PT8425</p> 	<p>Hydraulic Element Fits: John Deere, Takeuchi Loaders Replaces: John Deere AT204010; Takeuchi 1551101001 O.D.: 2 (50.8) I.D.: 31/32 (24.6) One End Height: 8 7/32 (208.8) I.Gskt: [1] Included O-Ring: [1] Included</p>
<p>BT8420</p> 	<p>Wire Mesh Hydraulic Spin-on Fits: Barber-Greene Equipment Use With: OB1317, OB1318, OB1319, OB1320 bases. Replaces: Zinga AE100 Thread: 1 -12 O.D.: 3 11/16 (93.7) Height: 5 13/32 (137.3) I.Gskt: G401 Related To: BT839, BT839-10 (Standard Versions)</p>	<p>BT8426-MPG</p> 	<p>Maximum Performance Glass Hydraulic Spin-on Contains: 50 PSID By-Pass Valve Fits: Caterpillar, Grove Equipment Replaces: Clark 4202505; Gehl L99184 Thread: 2 -16 O.D.: 3 3/4 (95.3) Height: 6 3/32 (154.8) I.Gskt: [1] Included</p>
<p>BT8421-MPG</p> 	<p>Maximum Performance Glass Hydraulic Spin-on Notes: Can be used with OB1314 and OB1316 bases (requires optional G286-C gasket). Fits: Donaldson HBK05 Assembly Replaces: Hycon MFE16003BN2; Ingersoll-Rand 59700674; Pall HC7500SDP4H; Donaldson P169430 Thread: 1 1/2 -16 O.D.: 5 1/16 (128.6) Height: 6 31/32 (177.0) F. Gskt: G369-B O. Gskt: G286-C, G369-V, G372, G447, G483, G704, G710 Related To: BT8307-MPG (Micron Difference)</p>	<p>PT8427</p> 	<p>Hydraulic Element Fits: Bros Compactors Replaces: GMC 25313910; Iowa Manufacturing 4517750903 O.D.: 4 3/8 (111.1) I.D.: 1 7/8 (47.6) Height: 10 3/32 (256.4) I.Gskt: [2] Included</p>
<p>BT8422-MPG</p> 	<p>High Efficiency Maximum Performance Glass Hydraulic Spin-on Notes: Can be used with OB1314 and OB1316 bases (requires optional G286-C gasket). Fits: Donaldson HBK05 Assembly Replaces: Hycon MFE160103BN2; Pall HC7500SUP8H; Donaldson P167832 Thread: 1 1/2 -16 O.D.: 5 1/16 (128.6) Height: 10 3/4 (273.1) F. Gskt: G369-B O. Gskt: G286-C, G369-V, G372, G447, G483, G704, G710 Related To: BT8308-MPG (Standard Version)</p>	<p>BT8428-MPG</p> 	<p>Maximum Performance Glass Hydraulic Spin-on Notes: Can be used with OB1318 and OB1320 bases. Fits: Various Hydraulic Applications Replaces: LHA SPE15BTA10 Thread: 1 -12 O.D.: 3 11/16 (93.7) Height: 5 15/32 (138.9) I.Gskt: G401 Related To: BT839, BT839-10 (Standard Versions)</p>
<p>BT8429</p> 	<p>Wire Mesh Hydraulic Spin-on Fits: Ingersoll-Rand Compressors Use With: OB1313, OB1314, OB1315, OB1316 bases (requires optional G286-C gasket). Replaces: Ingersoll-Rand 59879247; Zinga SE100 Thread: 1 1/2 -16 O.D.: 5 1/16 (128.6) Height: 6 31/32 (177.0) F. Gskt: G369-B O. Gskt: G286-C, G369-V, G372, G447, G483, G704, G710</p>	<p>Air Breather Element Fits: Caterpillar Lift Trucks Replaces: Caterpillar 9Y5011 O.D.: 3 1/32 (77.0) I.D.: 1 15/32 (37.3) One End Height: 2 7/32 (56.4)</p>	<p>BT8423</p>
<p>BT8423</p> 	<p>Wire Mesh Hydraulic Spin-on Fits: Ingersoll-Rand Compressors Use With: OB1313, OB1314, OB1315, OB1316 bases (requires optional G286-C gasket). Replaces: Ingersoll-Rand 59879247; Zinga SE100 Thread: 1 1/2 -16 O.D.: 5 1/16 (128.6) Height: 6 31/32 (177.0) F. Gskt: G369-B O. Gskt: G286-C, G369-V, G372, G447, G483, G704, G710</p>	<p>BT8432-MPG</p> 	<p>Maximum Performance Glass Hydraulic Spin-on Fits: Caterpillar Equipment Use With: OB8711, OB8712, OB8720, OB8721, OB8722, OB8724, OB8731, OB8732, OB8741, OB8742, OB8743, OB8744, OB8745, OB8746 bases. Replaces: Caterpillar 6E6408 Thread: 1 3/8 -12 O.D.: 4 23/32 (119.9) Height: 11 17/32 (292.9) I.Gskt: [1] Included</p>

Measurements Are Shown In Inches And (Millimeters)

WARNING: These products can expose you to chemicals, including Diisononyl Phthalate, Carbon black extracts, Nickel, 1,3 Butadiene, Ethylene Oxide, Epichlorohydrin, which are known to the State of California to cause cancer, and Bisphenol, Ethylene Glycol, Ethylene Oxide, 1,3 Butadiene, Epichlorohydrin, which are known to the State of California to cause birth defects or other reproductive harm. For more information go to www.P65Warnings.ca.gov.

PT8433-MPG Maximum Performance Glass Hydraulic Element



Fits: V.M.E., Volvo Loaders
Replaces: Volvo 11026936, 11026936-2
O.D.: 4 31/32 (126.2)
I.D.: 13/32 (10.3) & 3 5/8 (92.1)
Height: 15 11/32 (389.7)
O-Ring: [1] Attached

PT8441 Hydraulic Element



Fits: Caterpillar Compactors
Replaces: Caterpillar 77-3092
O.D.: 4 3/8 (111.1)
I.D.: 1 7/8 (47.6)
Height: 13 1/8 (333.4)
I.Gskt: [2] Included

PT8435-MPG Maximum Performance Glass In-Line Hydraulic Filter



Contains: 25 PSID By-Pass Valve
Fits: Hyster Lift Trucks
Replaces: Hyster 1337159
O.D.: 4 1/32 (102.4)
Inlet: 1
Outlet: 1
Length: 7 31/32 (202.4)
Related To: PT716 (Standard Media Version with No By-Pass Valve)

PT8442 Hydraulic Element



Fits: Ingersoll-Rand Compressors
Replaces: Ingersoll-Rand 39123229, 39123237
O.D.: 4 3/8 (111.1)
I.D.: 11/16 (17.5) & 2 7/16 (61.9)
Height: 16 1/32 (407.2)
A. Gskt: [1] Attached
Grommets: [1] Attached

PT8436 Hydraulic Element



Contains: Reinforced Centertube
Fits: Caterpillar Equipment
Replaces: Caterpillar 126-2081
O.D.: 5 19/32 (142.1)
I.D.: 3 27/32 (97.6)
Height: 16 23/32 (424.7)
I.Gskt: [2] Included

BT8443 Hydraulic or Lube Spin-on



Notes: Can be used with OB1318 and OB1320 bases.
Fits: Zinga Hydraulic Heads
Replaces: LHA SPE25-10; Zinga AE10L
Thread: 1 -12
O.D.: 3 23/32 (94.5)
Height: 8 3/16 (208.0)
I.Gskt: G401

BT8437 Hydraulic Spin-on



Contains: 25 PSID By-Pass Valve
Fits: Voith Transmissions
Replaces: Voith 90.4399.10, 90.4399.11
Thread: 1 1/2 -16
O.D.: 5 1/2 (139.7)
Height: 7 (177.8)
I.Gskt: [1] Included

BT8444 Hydraulic Spin-on



Fits: Dynapac Rollers
Replaces: Dynapac 499519; Gehl 34609074830;
 Voith 90.6103.10
Thread: 1 -12
O.D.: 3 23/32 (94.5)
Height: 8 3/16 (208.0)
I.Gskt: [1] Included

BT8439-MPG Maximum Performance Glass Hydraulic or Transmission Spin-on



Fits: Case, Komatsu, Volvo Loaders
Replaces: Case 181167A1, 254686A1
Thread: 13/16 -16
O.D.: 3 3/4 (95.3)
Height: 6 1/32 (153.2)
I.Gskt: [1] Included

BT8445 Hydraulic Spin-on



Fits: Joy Compressors
Replaces: Sullivan 190052012
Thread: 1 -12
O.D.: 3 11/16 (93.7)
Height: 5 3/8 (136.5)
I.Gskt: G381-A

BT8440-MPG Maximum Performance Glass Hydraulic Spin-on



Contains: 25 PSID By-Pass Valve
Fits: Sullair Compressors
Replaces: Sullair 250026-982, 250028-032
Thread: 31/32 -20
O.D.: 3 21/32 (92.9)
Height: 5 5/8 (142.9)
I.Gskt: [1] Included

PT8446-MPG Maximum Performance Glass Hydraulic Element



Fits: Heil Garbage Packer
Replaces: Schroeder 18LS7, 18LZ10
O.D.: 3 7/8 (98.4)
I.D.: 2 1/4 (57.2)
Height: 18 1/2 (469.9)
I.Gskt: [2] Included

Measurements Are Shown In Inches And (Millimeters)

WARNING: These products can expose you to chemicals, including Diisononyl Phthalate, Carbon black extracts, Nickel, 1,3 Butadiene, Ethylene Oxide, Epichlorohydrin, which are known to the State of California to cause cancer, and Bisphenol, Ethylene Glycol, Ethylene Oxide, 1,3 Butadiene, Epichlorohydrin, which are known to the State of California to cause birth defects or other reproductive harm. For more information go to www.P65Warnings.ca.gov.

<p>PT8447-MPG Maximum Performance Glass Hydraulic Element</p>  <p>Fits: CMI Slip Form Paver, Rotomill Replaces: Pall HC8900FDN16H, HC8900FKN16H, HC8900FUN16H O.D.: 3 25/32 (96.0) I.D.: 2 7/32 (56.4) One End Height: 16 7/8 (428.6) I.Gskt: [1] Included</p>	<p>PT8451-MPG Wire Mesh Supported Maximum Performance Glass Hydraulic Element</p>  <p>Fits: Hitachi, John Deere Equipment Replaces: John Deere AT147821, AT186554 O.D.: 1 31/32 (50.0) I.D.: 29/32 (23.0) One End Height: 6 (152.4) I.Gskt: [1] Included O-Ring: [2] Included</p>
<p>P8448 Hydraulic Element</p>  <p>Replaces: Fleetguard HFKW800T O.D.: 5 (127.0) I.D.: 3/8 (9.5) & 7/8 (22.2) Height: 4 5/32 (105.6) A. Gskt: [1] Attached F. Gskt: [1] Included</p>	<p>PT8452 Hydraulic Element</p>  <p>Notes: Inside-Out Flow Direction Fits: Barko Garbage Trucks Replaces: Parker 924450 O.D.: 3 1/2 (88.9) I.D.: 1 9/16 (39.7) Height: 9 9/32 (235.7) Grommets: [2] Attached Related To: PT8489 (Double-Length Version)</p>
<p>BT8449 Hydraulic Spin-on</p>  <p>Fits: Allis Chalmers, Barber-Greene, Case, Grove, John Deere, Steiger Equipment; Eaton Lift Trucks Replaces: Marvel 451217-5125 Thread: 1 5/16 -12 O.D.: 3 7/8 (98.4) Height: 5 25/32 (146.8) F. Gskt: [1] Included O-Ring: G247</p>	<p>PT8453 Hydraulic Element</p>  <p>Fits: John Deere Equipment Replaces: John Deere TH111011 O.D.: 3 1/2 (88.9) I.D.: 1 27/32 (46.8) Height: 13 7/8 (352.4) O-Ring: [2] Included Grommets: [2] Attached</p>
<p>BT8449-10 Hydraulic Spin-on</p>  <p>Fits: Allis Chalmers, Barber-Greene, Case, Grove, John Deere, Steiger Equipment; Eaton Lift Trucks Replaces: Marvel 451217-1110, 451217-5110 Thread: 1 5/16 -12 O.D.: 3 7/8 (98.4) Height: 5 25/32 (146.8) F. Gskt: [1] Included O-Ring: G247</p>	<p>PT8455-MPG Maximum Performance Glass Hydraulic Element</p>  <p>Notes: Inside-Out Flow Direction Fits: J.C. Bamford 426 Series, 434S, 436 Series, 456 Series Loaders; John Deere 1063 Tree Harvester; F106, F106A Motor Graders Replaces: Heil 7571101 O.D.: 4 5/32 (105.6) I.D.: 13/32 (10.3) & 2 27/32 (72.2) Height: 18 5/16 (465.1) O-Ring: [1] Attached</p>
<p>BT8450 Hydraulic Spin-on</p>  <p>Contains: Anti-Drainback Valve 15 PSID By-Pass Valve Fits: New Holland Equipment Replaces: U.C.C. UC2418; Donaldson P550269 Thread: 1 1/4 -11 BSP-PL O.D.: 5 (127.0) Height: 7 3/32 (180.2) I.Gskt: [1] Included Related To: BT351 (without Anti-Drainback, By-Pass Valve) BT8475 (Micron Difference) BT8476, BT8477 (Long Versions, Micron Difference)</p>	<p>PT8456-MPG Wire Mesh Supported Maximum Performance Glass Hydraulic Element</p>  <p>Notes: Inside-Out Flow Direction Fits: Various Hydraulic Applications Replaces: Parker 924453; Donaldson P169557 O.D.: 3 23/32 (94.5) I.D.: 1 23/32 (43.7) Height: 9 1/16 (230.2) Grommets: [2] Attached</p>

Measurements Are Shown In Inches And (Millimeters)

WARNING: These products can expose you to chemicals, including Diisononyl Phthalate, Carbon black extracts, Nickel, 1,3 Butadiene, Ethylene Oxide, Epichlorohydrin, which are known to the State of California to cause cancer, and Bisphenol, Ethylene Glycol, Ethylene Oxide, 1,3 Butadiene, Epichlorohydrin, which are known to the State of California to cause birth defects or other reproductive harm. For more information go to www.P65Warnings.ca.gov.

BT8457-MPG Maximum Performance Glass Hydraulic Spin-on



Fits: John Deere Equipment
Replaces: John Deere AT180249
Thread: 1 1/2 -16
O.D.: 4 13/16 (122.2)
Height: 11 29/32 (302.4)
I.Gskt: [1] Included

PT8462-MPG Maximum Performance Glass Hydraulic Element



Notes: Inside-Out Flow Direction
Fits: Donaldson HAK05, HDK06 Assemblies
Replaces: Donaldson P163859
O.D.: 4 3/8 (111.1)
I.D.: 3/4 (19.0) & 2 7/16 (61.9)
Height: 5 (127.0)
A. Gskt: [1] Attached

PT8458-MPG Wire Mesh Supported Maximum Performance Glass Hydraulic Element



Contains: Viton O-Ring for high heat applications.
Replaces: Parker 925837; Heil 757051, 7559101
O.D.: 2 3/8 (60.3)
I.D.: 1 (25.4) One End
Height: 9 21/32 (245.3)
O-Ring: [1] Attached

BT8463-MPG Maximum Performance Glass Hydraulic Spin-on



Fits: Various Hydraulic Applications
Use With: OB8711, OB8712, OB8720, OB8721, OB8722, OB8724, OB8731, OB8732, OB8741, OB8742, OB8743, OB8744, OB8745, OB8746 bases.
Replaces: Donaldson P165335; Fleetguard HF6556
Thread: 1 3/8 -12
O.D.: 3 3/4 (95.3)
Height: 6 1/8 (155.6)
I.Gskt: [1] Included

PT8459 Hydraulic Element



Replaces: Argo P2092301; Renault 6005019557
O.D.: 3 9/32 (83.3)
I.D.: 1 31/32 (50.0)
Height: 8 15/16 (227.0)

BT8464 Hydraulic Spin-on



Fits: Various Hydraulic Applications
Use With: OB8711, OB8712, OB8720, OB8721, OB8722, OB8724, OB8731, OB8732, OB8741, OB8742, OB8743, OB8744, OB8745, OB8746 bases.
Replaces: Donaldson P163405; Fleetguard HF6560
Thread: 1 3/8 -12
O.D.: 3 3/4 (95.3)
Height: 6 1/8 (155.6)
O-Ring: [1] Included

BT8460 Transmission Spin-on



Contains: 9 PSID By-Pass Valve
Fits: Allison Transmissions; Ford, Freightliner, GMC, Hino, International, Kenworth, Mack, Nissan, Peterbilt Trucks
Replaces: GMC 29537268, 29539579
Thread: 3/4 -20
O.D.: 2 7/8 (73.0)
Height: 3 (76.2)
I.Gskt: [1] Included

BT8465 Hydraulic Spin-on



Fits: Various Hydraulic Applications
Use With: OB8711, OB8712, OB8720, OB8721, OB8722, OB8724, OB8731, OB8732, OB8741, OB8742, OB8743, OB8744, OB8745, OB8746 bases.
Replaces: Donaldson P163558; Fleetguard HF6577
Thread: 1 3/8 -12
O.D.: 3 3/4 (95.3)
Height: 9 19/32 (243.7)
I.Gskt: [1] Included

PT8461 Hydraulic Element



Notes: Inside-Out Flow Direction
Fits: Caterpillar Graders
Replaces: Caterpillar 1R0774
O.D.: 5 1/8 (130.2)
I.D.: 3 11/32 (84.9)
Height: 11 1/16 (281.0)
A. Gskt: [2] Attached

PT8468 Hydraulic Element



Replaces: Parker 926566; Schroeder A3
O.D.: 3 (76.2)
I.D.: 1 1/16 (27.0)
Height: 4 11/16 (119.1)
A. Gskt: [2] Attached

Measurements Are Shown In Inches And (Millimeters)

WARNING: These products can expose you to chemicals, including Diisononyl Phthalate, Carbon black extracts, Nickel, 1,3 Butadiene, Ethylene Oxide, Epichlorohydrin, which are known to the State of California to cause cancer, and Bisphenol, Ethylene Glycol, Ethylene Oxide, 1,3 Butadiene, Epichlorohydrin, which are known to the State of California to cause birth defects or other reproductive harm. For more information go to www.P65Warnings.ca.gov.

PT8470



Hydraulic Element
Replaces: Parker 924451
O.D.: 3 1/2 (88.9)
I.D.: 1 9/16 (39.7)
Height: 9 9/32 (235.7)
Grommets: [2] Attached
Related To: PT8511 (Double-Length Version)

BT8475-MPG



Wire Mesh Supported Maximum Performance Glass Hydraulic Spin-on
Replaces: MP Filtri CS100A25; Woodgate WGH9176
Thread: 1 1/4 -11 BSP-PL
O.D.: 5 1/16 (128.6)
Height: 7 1/16 (179.4)

BT8471-MPG



Maximum Performance Glass Hydraulic Spin-on
Fits: Gradall Material Handlers
Replaces: Gradall 91143144
Thread: 1 1/2 -16
O.D.: 5 1/16 (128.6)
Height: 10 3/4 (273.1)
F. Gskt: [1] Included
O. Gskt: G369-V, G704, G710

BT8476



Hydraulic Spin-on
Fits: Belloli Trucks; Liebherr Loaders
Replaces: Liebherr 7010930; MP Filtri CS150P10A
Thread: 1 1/4 -11 BSP-PL
O.D.: 5 1/8 (130.2)
Height: 8 11/16 (220.7)
I.Gskt: [1] Included

BT8472



Hydraulic Spin-on
Fits: Afron Manlift
Replaces: MP Filtri CS050P25A
Thread: 3/4 -14 BSP-PL
O.D.: 3 11/16 (93.7)
Height: 5 3/8 (136.5)
I.Gskt: G381-A

BT8476-MPG



Maximum Performance Glass Hydraulic Spin-on
Fits: Belloli Trucks; Liebherr Loaders
Replaces: MP Filtri CS150A10
Thread: 1 1/4 -11 BSP-PL
O.D.: 5 1/8 (130.2)
Height: 8 11/16 (220.7)
I.Gskt: [1] Included

BT8473



Hydraulic Spin-on
Replaces: MP Filtri CS070P10A
Thread: 3/4 -14 BSP-PL
O.D.: 3 11/16 (93.7)
Height: 8 5/32 (207.2)
I.Gskt: G381-A

BT8477



Hydraulic Spin-on
Fits: Case Tractors; Manitou Equipment; TCL Topper Hedgers
Replaces: Manitou 485695; MP Filtri CS150P25A
Thread: 1 1/4 -11 BSP-PL
O.D.: 5 1/8 (130.2)
Height: 8 11/16 (220.7)
I.Gskt: [1] Included

BT8474



Hydraulic Spin-on
Replaces: MP Filtri CS070P25A
Thread: 3/4 -14 BSP-PL
O.D.: 3 11/16 (93.7)
Height: 8 5/32 (207.2)
I.Gskt: G381-A

BT8477-MPG



Wire Mesh Supported Maximum Performance Glass Hydraulic Spin-on
Fits: Manitou Loaders; TCL Topper Hedgers
Replaces: MP Filtri CS150A25; Woodgate WGH9182
Thread: 1 1/4 -11 BSP-PL
O.D.: 5 1/32 (127.8)
Height: 8 15/16 (227.0)

BT8475



Hydraulic Spin-on
Replaces: MP Filtri CS100P25A; U.C.C. UCMX1591425; Zinga SE25G
Thread: 1 1/4 -11 BSP-PL
O.D.: 5 (127.0)
Height: 7 3/32 (180.2)
I.Gskt: [1] Included
Related To: BT8450 (with Anti-Drainback Valve, 15 PSID By-Pass Valve)



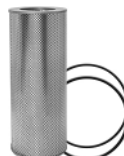







PT8478



High Pressure Hydraulic Element
Contains: Reinforced Centertube
Fits: Hitachi, John Deere, Komatsu Equipment
Replaces: Hitachi 4333469; Komatsu 7063-01-383, 2086-06-1150; Fiat 4287634, 76580323
O.D.: 7 (177.8)
I.D.: 4 5/16 (109.5)
Height: 17 3/4 (450.9)
O-Ring: [2] Included





Measurements Are Shown In Inches And (Millimeters)

WARNING: These products can expose you to chemicals, including Diisononyl Phthalate, Carbon black extracts, Nickel, 1,3 Butadiene, Ethylene Oxide, Epichlorohydrin, which are known to the State of California to cause cancer, and Bisphenol, Ethylene Glycol, Ethylene Oxide, 1,3 Butadiene, Epichlorohydrin, which are known to the State of California to cause birth defects or other reproductive harm. For more information go to www.P65Warnings.ca.gov.

<p>PT8479 Hydraulic Element Contains: Reinforced Centertube Fits: Hitachi Excavators Replaces: Hitachi 3501404 O.D.: 3 17/32 (89.7) I.D.: 1 29/32 (48.4) Height: 11 7/16 (290.5) F. Gskt: [1] Included O-Ring: [2] Attached</p> 	<p>PT8487 Power Steering Element Notes: Inside-Out Flow Direction Fits: Freightliner, Peterbilt Trucks Replaces: Donaldson P550698; Nelson 83284D O.D.: 4 (101.6) I.D.: 1 3/32 (27.8) & 1 15/32 (37.3) Height: 5 7/32 (132.6) A. Gskt: [2] Attached</p> 
<p>PT8480 Depth-Pack 2-Section In-Line Hydraulic Element Fits: Hitachi Excavators Replaces: Hitachi 4185299 O.D.: 5 1/2 (139.7) Inlet: 7/8 Outlet: 7/8 Length: 11 15/16 (303.2) O-Ring: [2] Attached, [1] Included Grommets: [2] Attached</p> 	<p>BT8488 Hydraulic Spin-on Fits: Case-International, Kubota, New Holland Tractors Replaces: Kubota 33960-82631 Thread: 1 1/8 -16 O.D.: 3 23/32 (94.5) Height: 7 1/32 (178.6) I.Gskt: [1] Included</p> 
<p>PT8481 Hydraulic Element Replaces: Parker 924732, 924734 O.D.: 2 3/4 (69.9) I.D.: 1 5/8 (41.3) Height: 8 27/32 (224.6) End Seals: [2] Attached</p> 	<p>PT8489 2-Section Hydraulic Element Notes: Inside-Out Flow Direction Contains: Grommet Seal Between Sections Fits: Various Equipment with Parker Hydraulic Systems Replaces: Parker 924792 O.D.: 3 1/2 (88.9) I.D.: 1 9/16 (39.7) Height: 18 9/16 (471.5) Grommets: [3] Attached Related To: PT8452 (Single-Length Version)</p> 
<p>PT8484 Hydraulic Element with Bail Handle Contains: 43.5 PSID By-Pass Valve Fits: J.C. Bamford Equipment Replaces: J.C. Bamford 32/910100, 32/913500 O.D.: 2 9/16 (65.1) I.D.: 1 9/32 (32.5) One End Height: 8 31/32 (227.8)</p> 	<p>PT8490-MPG Maximum Performance Glass Hydraulic Element with Bail Handle Contains: Nylon Mesh Media Replaces: Dresser AK3570 O.D.: 4 1/8 (104.8) I.D.: 2 13/32 (61.1) Height: 12 5/16 (312.7) O-Ring: [2] Attached</p> 
<p>PT8485 Hydraulic Element Fits: Schroeder Hydraulic Systems Replaces: Schroeder N10 O.D.: 1 25/32 (45.2) I.D.: 23/32 (18.3) One End Height: 5 9/32 (134.1)</p> 	<p>PT8491 Hydraulic Element Notes: Inside-Out Flow Direction Fits: Donaldson HFK08 Housing; Wagner Mining Equipment Replaces: Donaldson P161365; Fleetguard HF6489 O.D.: 6 (152.4) I.D.: 23/32 (18.3) & 3 17/32 (89.7) Height: 18 1/32 (458.0) Grommets: [1] Attached</p> 
<p>BT8486 Transmission Spin-on Fits: Cub Cadet Lawn & Garden Tractors Replaces: Cub Cadet 7233014, 9233014 Thread: 3/4 -16 O.D.: 3 3/4 (95.3) Height: 3 31/32 (100.8) I.Gskt: G381-A</p> 	

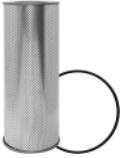
Measurements Are Shown In Inches And (Millimeters)

WARNING: These products can expose you to chemicals, including Diisononyl Phthalate, Carbon black extracts, Nickel, 1,3 Butadiene, Ethylene Oxide, Epichlorohydrin, which are known to the State of California to cause cancer, and Bisphenol, Ethylene Glycol, Ethylene Oxide, 1,3 Butadiene, Epichlorohydrin, which are known to the State of California to cause birth defects or other reproductive harm. For more information go to www.P65Warnings.ca.gov.

<p>PT8492</p> 	<p>High Pressure Hydraulic Element Contains: Reinforced Centertube Fits: John Deere Excavators; Samsung, Volvo Equipment Replaces: John Deere AT201793 O.D.: 7 (177.8) I.D.: 4 5/16 (109.5) Height: 17 3/4 (450.9) O-Ring: [1] Included</p>	<p>PT8498</p>  <p>Hydraulic Element Contains: Viton O-Ring for high heat applications Fits: Blue Bird Buses with Allison Transmissions Replaces: Parker 925835 O.D.: 2 3/8 (60.3) I.D.: 1 (25.4) One End Height: 9 5/8 (244.5) O-Ring: [1] Attached</p>
<p>BT8493</p> 	<p>Hydraulic or Transmission Spin-on Contains: Anti-Drainback Valve 14 PSID By-Pass Valve Fits: Eaton Lift Trucks Replaces: Hyster 8500023; Yale 518801624 Thread: 3/4 -16 O.D.: 3 11/16 (93.7) Height: 2 29/32 (73.8) I.Gskt: G401</p>	<p>BT8499</p>  <p>Hydraulic Spin-on Fits: John Deere Lawn & Garden Tractors Replaces: John Deere AM116156 Thread: 1 -14 O.D.: 3 11/16 (93.7) Height: 3 13/16 (96.8) I.Gskt: G381-A</p>
<p>PT8494</p> 	<p>Wire Mesh Supported Hydraulic Element Notes: Inside-Out Flow Direction Fits: Case Excavators; Donaldson HAK05 Assembly Replaces: Case S104929; Donaldson P160516 O.D.: 4 3/8 (111.1) I.D.: 23/32 (18.3) & 2 13/32 (61.1) Height: 16 1/16 (408.0) A. Gskt: [1] Attached Grommets: [1] Attached</p>	<p>BT8501-MPG</p>  <p>Maximum Performance Glass Hydraulic Spin-on Fits: John Deere Equipment Replaces: John Deere RE17380; Donaldson P551234 Thread: 1 -12 O.D.: 3 11/16 (93.7) Height: 5 13/32 (137.3) I.Gskt: G401</p>
<p>PT8495-MPG</p> 	<p>Nylon Mesh Supported Maximum Performance Glass Hydraulic Element Fits: Haulpak Trucks Replaces: Dresser AK3572 O.D.: 3 1/8 (79.4) I.D.: 1 15/16 (49.2) One End Height: 16 17/32 (419.9) O-Ring: [1] Attached</p>	<p>BT8502</p>  <p>Hydraulic Spin-on Replaces: Parker 926543; Donaldson P551550; Fleetguard HF6500 Thread: 1 -12 O.D.: 3 11/16 (93.7) Height: 5 13/32 (137.3) I.Gskt: G401</p>
<p>PT8496-MPG</p> 	<p>Maximum Performance Glass Hydraulic Element Contains: Reinforced Centertube Fits: Caterpillar Equipment Replaces: Caterpillar 132-8876 O.D.: 5 1/8 (130.2) I.D.: 3 3/8 (85.7) Height: 9 1/16 (230.2) A. Gskt: [2] Attached</p>	<p>BT8503-MPG</p>  <p>Maximum Performance Glass Hydraulic Spin-on Fits: New Holland, Versatile Tractors Replaces: New Holland 86016760; Fleetguard HF29000 Thread: M90 x 2.0 O.D.: 4 23/32 (119.9) Height: 7 11/16 (195.3) I.Gskt: [1] Included</p>
<p>BT8497-MPG</p> 	<p>Wire Mesh Supported Maximum Performance Glass Hydraulic Spin-on Fits: John Deere Skidders Replaces: John Deere AT182209 Thread: 1 -12 O.D.: 3 23/32 (94.5) Height: 8 1/8 (206.4) I.Gskt: [1] Included</p>	<p>BT8504</p>  <p>Transmission Spin-on Contains: 8 PSID By-Pass Valve Fits: Ford, New Holland Tractors Replaces: Ford D8NN-B486-CA Thread: 1 1/8 -16 O.D.: 3 11/16 (93.7) Height: 6 5/8 (168.3) I.Gskt: G381-A</p>

Measurements Are Shown In Inches And (Millimeters)

WARNING: These products can expose you to chemicals, including Diisononyl Phthalate, Carbon black extracts, Nickel, 1,3 Butadiene, Ethylene Oxide, Epichlorohydrin, which are known to the State of California to cause cancer, and Bisphenol, Ethylene Glycol, Ethylene Oxide, 1,3 Butadiene, Epichlorohydrin, which are known to the State of California to cause birth defects or other reproductive harm. For more information go to www.P65Warnings.ca.gov.

BT8505 Hydraulic Spin-on
Fits: Ford, New Holland Tractors
Replaces: Ford SBA340500410, 83939935
Thread: 1 1/8 -16
O.D.: 3 11/16 (93.7)
Height: 5 21/32 (143.7)
I.Gskt: G401



PT8511 Hydraulic Element
Contains: Grommet Seal Between Sections
Replaces: Parker 924790; Donaldson P169558; Fleetguard HF7779
O.D.: 3 1/2 (88.9)
I.D.: 1 9/16 (39.7)
Height: 18 9/16 (471.5)
Grommets: [2] Attached
Related To: PT8470 (Single-Length Version)



PT8506-MPG Maximum Performance Glass Hydraulic Element
Contains: Reinforced Centertube
Fits: Komatsu Excavators
Replaces: Komatsu 7063-51-100
O.D.: 5 1/8 (130.2)
I.D.: 3 3/8 (85.7)
Height: 11 17/32 (292.9)



BT8512 Hydraulic Spin-on
Contains: 40 PSID By-Pass Valve
Fits: Claas, Hamm, Liebherr Equipment
Replaces: Liebherr 5612546, 7004209; Rottne 480101; Fleetguard HF28989
Thread: 1 -12
O.D.: 3 23/32 (94.5)
Height: 6 23/32 (170.7)
I.Gskt: G401



PT8507-MPG Maximum Performance Glass Hydraulic Element
Fits: Komatsu Excavators
Replaces: Komatsu 7063-51-054
O.D.: 3 15/16 (100.0)
I.D.: 2 11/32 (59.5)
Height: 8 5/16 (211.1)



PT8517-MPG Wire Mesh Supported Maximum Performance Glass Hydraulic Element
Replaces: Blount 31001609, 31004339; Donaldson P560402
O.D.: 3 29/32 (99.2)
I.D.: 1 5/8 (41.3) & 1 27/32 (46.8)
Height: 18 1/2 (469.9)
A. Gskt: G310
O-Ring: [1] Included
End Seals: ES1039 Attached



BT8509-MPG Maximum Performance Glass Hydraulic Spin-on
Replaces: Pall HC7400SKN8H; PTI F4F040HCB; Donaldson P169392
Thread: 1 1/2 -16
O.D.: 3 11/16 (93.7)
Height: 8 1/16 (204.8)
I.Gskt: [1] Included



PT8519-MPG Wire Mesh Supported Maximum Performance Glass Hydraulic Element
Contains: Viton O-Ring for high heat applications.
Replaces: Pall HC8200FKS16H; Purolator Facet 8200EAL122N3; Donaldson P174547
O.D.: 3 3/32 (78.6)
I.D.: 1 1/2 (38.1) One End
Height: 16 7/8 (428.6)
O-Ring: [1] Attached



BT8510-MPG Maximum Performance Glass Hydraulic Spin-on
Fits: Hypac, Tigercat Equipment; Taylor Lift Trucks
Replaces: Pall HC7500SKT8H
Thread: 1 1/2 -16
O.D.: 5 1/16 (128.6)
Height: 10 3/4 (273.1)
F. Gskt: [1] Included



OP8709 Hydraulic Plug
Notes: To be used with PureForce Hydraulic Bases where an indicator port plug is needed.
Replaces: Donaldson P165983
Thread: 9/16 -18
Length: 1 3/16 (30.2)
O-Ring: [2] Included



OB8711 Hydraulic Filter Base
Contains: 25 PSID By-Pass Valve
Threaded Stud: 1 3/8-12
[2] Indicator Ports with Plugs
Use With: 4 Inch O.D. PureForce Filters
Replaces: Donaldson P169317
O.D.: 3 31/32 (100.8)
Inlet: 3/4 In. NPT
Outlet: 3/4 In. NPT
Height: 4 (101.6)



Measurements Are Shown In Inches And (Millimeters)

WARNING: These products can expose you to chemicals, including Diisononyl Phthalate, Carbon black extracts, Nickel, 1,3 Butadiene, Ethylene Oxide, Epichlorohydrin, which are known to the State of California to cause cancer, and Bisphenol, Ethylene Glycol, Ethylene Oxide, 1,3 Butadiene, Epichlorohydrin, which are known to the State of California to cause birth defects or other reproductive harm. For more information go to www.P65Warnings.ca.gov.

OB8712 Hydraulic Filter Base with Indicator
Contains: 25 PSID By-Pass Valve
 Threaded Stud: 1 3/8-12
 [2] Indicator Ports
 Visual Indicator Mounted on Left Side
Use With: 4 Inch O.D. PureForce Filters
Replaces: Donaldson P169310
O.D.: 3 31/32 (100.8)
Inlet: 3/4 In. NPT
Outlet: 3/4 In. NPT
Height: 4 (101.6)



OB8732 Hydraulic Filter Base with Indicator
Contains: 25 PSID By-Pass Valve
 Threaded Stud: 1 3/8-12
 [2] Indicator Ports
 Visual Indicator Mounted on Left Side
Use With: 4 Inch O.D. PureForce Filters
Replaces: Donaldson P166416
O.D.: 3 31/32 (100.8)
Inlet: 1 In. NPT
Outlet: 1 In. NPT
Height: 4 (101.6)



OB8720 Hydraulic Filter Base
Notes: OBSOLETE. Availability Limited to Dealer Stock.
Contains: Threaded Stud: 1 3/8-12
Use With: 4 Inch O.D. PureForce Filters
Replaces: Donaldson P165434
O.D.: 3 31/32 (100.8)
Inlet: 3/4 In. SAE O-Ring
Outlet: 3/4 In. SAE O-Ring
Height: 4 (101.6)



OB8741 Hydraulic Filter Base
Notes: OBSOLETE. Availability Limited to Dealer Stock.
Contains: 25 PSID By-Pass Valve
 Threaded Stud: 1 3/8-12
 [2] Indicator Ports with Plugs
Use With: 4 Inch O.D. PureForce Filters
Replaces: Donaldson P163681
O.D.: 3 31/32 (100.8)
Inlet: 1 In. SAE O-Ring
Outlet: 1 In. SAE O-Ring
Height: 4 (101.6)



OB8721 Hydraulic Filter Base
Contains: 25 PSID By-Pass Valve
 Threaded Stud: 1 3/8-12
 [2] Indicator Ports with Plugs
Use With: 4 Inch O.D. PureForce Filters
Replaces: Donaldson P167473
O.D.: 3 31/32 (100.8)
Inlet: 3/4 In. SAE O-Ring
Outlet: 3/4 In. SAE O-Ring
Height: 4 (101.6)



OB8742 Hydraulic Filter Base with Indicator
Contains: 25 PSID By-Pass Valve
 Threaded Stud: 1 3/8-12
 [2] Indicator Ports
 Visual Indicator Mounted on Left Side
Use With: 4 Inch O.D. PureForce Filters
Replaces: Donaldson P166417
O.D.: 3 31/32 (100.8)
Inlet: 1 In. SAE O-Ring
Outlet: 1 In. SAE O-Ring
Height: 4 (101.6)



OB8722 Hydraulic Filter Base with Indicator
Contains: 25 PSID By-Pass Valve
 Threaded Stud: 1 3/8-12
 [2] Indicator Ports
 Visual Indicator Mounted on Left Side
Use With: 4 Inch O.D. PureForce Filters
Replaces: Donaldson P166387
O.D.: 3 31/32 (100.8)
Inlet: 3/4 In. SAE O-Ring
Outlet: 3/4 In. SAE O-Ring
Height: 4 (101.6)



OB8743 Hydraulic Filter Base with Indicator
Notes: Normally Open
Contains: 25 PSID By-Pass Valve
 Threaded Stud: 1 3/8-12
 [2] Indicator Ports
 Single Post Indicator Mounted on Left Side
Use With: 4 Inch O.D. PureForce Filters
Replaces: Donaldson P165537
O.D.: 3 31/32 (100.8)
Inlet: 1 In. SAE O-Ring
Outlet: 1 In. SAE O-Ring
Height: 4 (101.6)



OB8724 Hydraulic Filter Base
Notes: OBSOLETE. Availability Limited to Dealer Stock.
Contains: 50 PSID By-Pass Valve
 Threaded Stud: 1 3/8-12
 [2] Indicator Ports
Use With: 4 Inch O.D. PureForce Filters
O.D.: 3 3/8 (85.7)
Inlet: 3/4 In. SAE O-Ring
Outlet: 3/4 In. SAE O-Ring
Height: 4 (101.6)



OB8744 Hydraulic Filter Base
Notes: OBSOLETE. Availability Limited to Dealer Stock.
Contains: 50 PSID By-Pass Valve
 Threaded Stud: 1 3/8-12
 [2] Indicator Ports with Plugs
Use With: 4 Inch O.D. PureForce Filters
Replaces: Donaldson P167201
O.D.: 3 3/8 (85.7)
Inlet: 1 In. SAE O-Ring
Outlet: 1 In. SAE O-Ring
Height: 4 (101.6)



OB8731 Hydraulic Filter Base
Contains: 25 PSID By-Pass Valve
 Threaded Stud: 1 3/8-12
 [2] Indicator Ports with Plugs
Use With: 4 Inch O.D. PureForce Filters
O.D.: 3 31/32 (100.8)
Inlet: 1 In. NPT
Outlet: 1 In. NPT
Height: 4 (101.6)



Measurements Are Shown In Inches And (Millimeters)

WARNING: These products can expose you to chemicals, including Diisononyl Phthalate, Carbon black extracts, Nickel, 1,3 Butadiene, Ethylene Oxide, Epichlorohydrin, which are known to the State of California to cause cancer, and Bisphenol, Ethylene Glycol, Ethylene Oxide, 1,3 Butadiene, Epichlorohydrin, which are known to the State of California to cause birth defects or other reproductive harm. For more information go to www.P65Warnings.ca.gov.

OB8745 Hydraulic Filter Base with Indicator
Notes: OBSOLETE. Availability Limited to Dealer Stock.
Contains: 50 PSID By-Pass Valve
 Threaded Stud: 1 3/8-12
 [2] Indicator Ports
 Visual Indicator Mounted on Left Side
Use With: 4 Inch O.D. PureForce Filters
O.D.: 3 31/32 (100.8)
Inlet: 1 In. SAE O-Ring
Outlet: 1 In. SAE O-Ring
Height: 4 (101.6)



OB8771 Hydraulic Filter Base
Notes: OBSOLETE. Availability Limited to Dealer Stock.
Contains: 25 PSID By-Pass Valve
 Threaded Stud: 1 3/4-12
 [2] Indicator Ports with Plugs
Use With: 5 Inch O.D. PureForce Filters
O.D.: 4 1/2 (114.3)
Inlet: 1 1/4 In. NPT
Outlet: 1 1/4 In. NPT
Height: 5 (127.0)



OP8750 Hex Head Plug
Notes: Optional for BF1223-SP, BF1329-SP. Furnished with: BF1284-SP, BF1330-SP, BF1351-SP, BF1358-SP, BF1374-SP, BF1382-SP
Thread: 9/16 -18
Length: 11/16 (17.5)
O-Ring: [1] Included



OB8772 Hydraulic Filter Base
Notes: OBSOLETE. Availability Limited to Dealer Stock.
Contains: 25 PSID By-Pass Valve
 Threaded Stud: 1 3/4-12
 [2] Indicator Ports
 Visual Indicator Mounted on Left Side
Use With: 5 Inch O.D. PureForce Filters
O.D.: 4 1/2 (114.3)
Inlet: 1 1/4 In. NPT
Outlet: 1 1/4 In. NPT
Height: 5 (127.0)



OP8751 Hex Head Plug
Notes: Optional for BF1222-SP, BF1345-SP
Thread: 7/16 -20
Length: 11/16 (17.5)
O-Ring: [1] Included



OB8773 Hydraulic Filter Base with Indicator
Notes: Normally Open
Contains: 25 PSID By-Pass Valve
 Threaded Stud: 1 3/4-12
 [2] Indicator Ports
 Single Post Indicator Mounted on Left Side
Use With: 5 Inch O.D. PureForce Filters
Replaces: Donaldson P167621
O.D.: 4 1/2 (114.3)
Inlet: 1 1/4 In. NPT
Outlet: 1 1/4 In. NPT
Height: 5 (127.0)



OP8752 Hex Head Plug
Notes: Optional for BF1204-SP, BF1205-SP, BF1249-SP, BF1283-SP, BF1346-SP, BF1348-SP, BF1355-SP
Thread: 1/2 -20
Length: 11/16 (17.5)
O-Ring: [1] Included



CFB8784 Dual Coolant Filter Base
Contains: Threaded Stud: 11/16-16
 [2] Brass Plugs
Fits: All Coolant Spin-ons with 11/16-16 Thread
Inlet: 3/8-18 NPT
Outlet: 3/8-18 NPT
Length: 8 3/16 (208.0)
Height: 2 17/32 (64.3)



OP8753 Hex Head Plug
Notes: Optional for BF1274-SP, BF1277-SP, BF1378-SPS
Thread: M14 x 2.0
Length: 11/16 (17.5)
O-Ring: [1] Included



BT8800-MPG Maximum Performance Glass Hydraulic Spin-on
Notes: Uses 2 filters per application.
Fits: John Deere Equipment
Replaces: John Deere AT209204, AT210148
Thread: 1 1/2 -16
O.D.: 4 13/16 (122.2)
Height: 11 9/16 (293.7)
I.Gskt: [1] Included



BT8801-MPG Maximum Performance Glass Hydraulic Spin-on
Fits: John Deere Equipment
Replaces: John Deere AT184206; Komatsu 1233914-H1, 1233914-H2, 1233914-H4
Thread: 1 1/2 -16
O.D.: 4 13/16 (122.2)
Height: 7 15/32 (189.7)
I.Gskt: [1] Included



Measurements Are Shown In Inches And (Millimeters)

WARNING: These products can expose you to chemicals, including Diisononyl Phthalate, Carbon black extracts, Nickel, 1,3 Butadiene, Ethylene Oxide, Epichlorohydrin, which are known to the State of California to cause cancer, and Bisphenol, Ethylene Glycol, Ethylene Oxide, 1,3 Butadiene, Epichlorohydrin, which are known to the State of California to cause birth defects or other reproductive harm. For more information go to www.P65Warnings.ca.gov.

BT8802-MPG

Maximum Performance Glass Hydraulic Spin-on
Fits: John Deere Equipment
Replaces: John Deere AT103193
Thread: 1 1/2 -16
O.D.: 4 13/16 (122.2)
Height: 7 15/32 (189.7)
I.Gskt: [1] Included



BT8831

Hydraulic Spin-on
Fits: Clark Lift Trucks
Replaces: Clark 2366807
Thread: 2 -16
O.D.: 3 11/16 (93.7)
Height: 7 7/32 (183.4)
I.Gskt: G401



BT8803-MPG

Maximum Performance Glass Hydraulic Spin-on
Fits: Hitachi Loaders
Replaces: Hitachi 4230344
Thread: 1 1/2 -16
O.D.: 4 13/16 (122.2)
Height: 11 9/16 (293.7)
I.Gskt: [1] Included



BT8832

Hydraulic Spin-on
Contains: 20 PSID By-Pass Valve
Fits: Hitachi Equipment; Hyster Lift Trucks
Replaces: Hyster 1315621
Thread: 2 -16
O.D.: 3 11/16 (93.7)
Height: 7 7/32 (183.4)
I.Gskt: G401



BT8805-MPG

Maximum Performance Glass Transmission Spin-on
Fits: John Deere Equipment
Replaces: John Deere AT167763, AT172912
Thread: 1 1/2 -16
O.D.: 4 13/16 (122.2)
Height: 11 15/32 (291.3)
I.Gskt: [1] Included



BT8833

Hydraulic or Transmission Spin-on
Contains: 35 PSID By-Pass Valve
Fits: Hyundai Loaders
Replaces: Clark 247052; Taylor 3939002
Thread: 2 -16
O.D.: 3 11/16 (93.7)
Height: 7 7/32 (183.4)
I.Gskt: G401



BT8812-MPG

Maximum Performance Glass Hydraulic Spin-on
Fits: John Deere Equipment
Replaces: John Deere AT144879
Thread: 1 1/2 -16
O.D.: 4 13/16 (122.2)
Height: 7 15/32 (189.7)
I.Gskt: [1] Included



BT8834-MPG

Maximum Performance Glass Hydraulic Spin-on
Contains: Viton gasket for high heat applications
Fits: Caterpillar Equipment; Freeman Hay Balers
Use With: OB8711, OB8712, OB8720, OB8721, OB8722, OB8724, OB8731, OB8732, OB8741, OB8742, OB8743, OB8744, OB8745, OB8746 filter bases.
Replaces: Ingersoll-Rand 39911615
Thread: 1 3/8 -12
O.D.: 3 13/16 (96.8)
Height: 9 7/16 (239.7)
I.Gskt: [1] Included



BT8813-MPG

Maximum Performance Glass Hydraulic Spin-on
Fits: John Deere Equipment
Replaces: John Deere AT140315
Thread: 1 1/2 -16
O.D.: 4 13/16 (122.2)
Height: 11 9/16 (293.7)
I.Gskt: [1] Included



BT8840-MPG

Maximum Performance Glass Hydraulic Spin-on
Notes: Rated 1000 PSI minimum burst.
Fits: Bobcat, Case, Caterpillar, Ingram, John Deere, Vermeer Equipment
Use With: OB8711, OB8712, OB8720, OB8721, OB8722, OB8724, OB8731, OB8732, OB8741, OB8742, OB8743, OB8744, OB8745, OB8746 filter bases.
Replaces: Case A165029; Clark 6630977; Melroe-Bobcat 6661248; Vermeer 81902001
Thread: 1 3/8 -12
O.D.: 3 3/4 (95.3)
Height: 6 1/8 (155.6)
I.Gskt: [1] Included



BT8830

Transmission Spin-on
Contains: 20 PSID By-Pass Valve
Fits: Case, Clark, Fiat-Allis, Gradall, Volvo Equipment
Replaces: Clark 247050; Fiat 73118171; Volvo 11993686, 119936862
Thread: 2 -16
O.D.: 3 11/16 (93.7)
Height: 5 21/32 (143.7)
I.Gskt: G401



Measurements Are Shown In Inches And (Millimeters)

WARNING: These products can expose you to chemicals, including Diisononyl Phthalate, Carbon black extracts, Nickel, 1,3 Butadiene, Ethylene Oxide, Epichlorohydrin, which are known to the State of California to cause cancer, and Bisphenol, Ethylene Glycol, Ethylene Oxide, 1,3 Butadiene, Epichlorohydrin, which are known to the State of California to cause birth defects or other reproductive harm. For more information go to www.P65Warnings.ca.gov.

BT8841-MPG Maximum Performance Glass Hydraulic Spin-on
Notes: Rated 1000 PSI minimum burst.
Fits: J.C. Bamford, John Deere, Komatsu Equipment; Ingersoll-Rand Compressors
Use With: OB8711, OB8712, OB8720, OB8721, OB8722, OB8724, OB8731, OB8732, OB8741, OB8742, OB8743, OB8744, OB8745, OB8746 filter bases.
Replaces: Ingersoll-Rand 58887936; J.C. Bamford 32/905501; John Deere AL77061; New Holland 82003166
Thread: 1 3/8 -12
O.D.: 3 3/4 (95.3)
Height: 6 3/32 (154.8)
I.Gskt: [1] Included



BT8846 Hydraulic Spin-on
Notes: Rated 1000 PSI minimum burst.
Fits: Case, Ditch Witch, Magnum, Vermeer Equipment
Use With: OB8711, OB8712, OB8720, OB8721, OB8722, OB8724, OB8731, OB8732, OB8741, OB8742, OB8743, OB8744, OB8745, OB8746 filter bases.
Replaces: Case D122562; Vermeer 67581001
Thread: 1 3/8 -12
O.D.: 3 3/4 (95.3)
Height: 6 1/8 (155.6)
I.Gskt: [1] Included



BT8842-MPG Maximum Performance Glass Hydraulic Spin-on
Notes: Rated 1000 PSI minimum burst.
Fits: Case, Caterpillar Equipment; Swinger Loaders; Thermo King Compressors
Use With: OB8711, OB8712, OB8720, OB8721, OB8722, OB8724, OB8731, OB8732, OB8741, OB8742, OB8743, OB8744, OB8745, OB8746 filter bases.
Replaces: Ford 3576-P165354; Thermo King 66-4917
Thread: 1 3/8 -12
O.D.: 3 3/4 (95.3)
Height: 6 1/8 (155.6)
I.Gskt: [1] Included



BT8847 Hydraulic Spin-on
Notes: Rated 1000 PSI minimum burst.
Fits: Toro Equipment
Use With: OB8711, OB8712, OB8720, OB8721, OB8722, OB8724, OB8731, OB8732, OB8741, OB8742, OB8743, OB8744, OB8745, OB8746 filter bases.
Replaces: Ingersoll-Rand 39136650
Thread: 1 3/8 -12
O.D.: 3 3/4 (95.3)
Height: 6 1/8 (155.6)
I.Gskt: [1] Included



BT8843-MPG Maximum Performance Glass Hydraulic Spin-on
Contains: 50 PSID Front-End By-Pass Valve By-Pass Screen
Replaces: Clark 2792962
Thread: 7/8 -14
O.D.: 3 3/4 (95.3)
Height: 6 1/32 (153.2)
I.Gskt: [1] Included



BT8848-MPG Maximum Performance Glass Hydraulic Spin-on
Notes: Rated 1000 PSI minimum burst.
Fits: John Deere, New Holland Loaders
Use With: OB8711, OB8712, OB8720, OB8721, OB8722, OB8724, OB8731, OB8732, OB8741, OB8742, OB8743, OB8744, OB8745, OB8746 filter bases.
Replaces: John Deere M124541; New Holland 9800633, 9842392, 89842392
Thread: 1 3/8 -12
O.D.: 3 3/4 (95.3)
Height: 8 1/32 (204.0)
I.Gskt: [1] Included



BT8844 Hydraulic Spin-on
Notes: Rated 1000 PSI minimum burst.
Fits: Bobcat, Michigan, TCM Loaders
Use With: OB8711, OB8712, OB8720, OB8721, OB8722, OB8724, OB8731, OB8732, OB8741, OB8742, OB8743, OB8744, OB8745, OB8746 filter bases.
Replaces: Clark 6599543
Thread: 1 3/8 -12
O.D.: 3 3/4 (95.3)
Height: 6 1/8 (155.6)
I.Gskt: [1] Included



BT8849-MPG Maximum Performance Glass Hydraulic Spin-on
Notes: Rated 1000 PSI minimum burst.
Use With: OB8711, OB8712, OB8720, OB8721, OB8722, OB8724, OB8731, OB8732, OB8741, OB8742, OB8743, OB8744, OB8745, OB8746 filter bases.
Thread: 1 3/8 -12
O.D.: 3 3/4 (95.3)
Height: 6 3/32 (154.8)
I.Gskt: [1] Included



BT8845 Hydraulic Spin-on
Notes: Rated 1000 PSI minimum burst.
Fits: Caterpillar, Dynapac Equipment
Use With: OB8711, OB8712, OB8720, OB8721, OB8722, OB8724, OB8731, OB8732, OB8741, OB8742, OB8743, OB8744, OB8745, OB8746 filter bases.
Replaces: Caterpillar 90-2900
Thread: 1 3/8 -12
O.D.: 3 3/4 (95.3)
Height: 6 1/8 (155.6)
O-Ring: [1] Included



BT8850-MPG Maximum Performance Glass Hydraulic Spin-on
Notes: Rated 1000 PSI minimum burst. NOT interchangeable with BT8851-MPG.
Fits: Case, Case-International, Caterpillar, Daewoo, Fiat-Allis, John Deere, Kawasaki, New Holland, Steiger, Thomas Equipment
Use With: OB8711, OB8712, OB8720, OB8721, OB8722, OB8724, OB8731, OB8732, OB8741, OB8742, OB8743, OB8744, OB8745, OB8746 filter bases.
Replaces: Case D94236; Caterpillar 9T5916; Fiat 73144499; John Deere RE34958
Thread: 1 3/8 -12
O.D.: 3 3/4 (95.3)
Height: 9 17/32 (242.1)
I.Gskt: [1] Included



Measurements Are Shown In Inches And (Millimeters)

WARNING: These products can expose you to chemicals, including Diisononyl Phthalate, Carbon black extracts, Nickel, 1,3 Butadiene, Ethylene Oxide, Epichlorohydrin, which are known to the State of California to cause cancer, and Bisphenol, Ethylene Glycol, Ethylene Oxide, 1,3 Butadiene, Epichlorohydrin, which are known to the State of California to cause birth defects or other reproductive harm. For more information go to www.P65Warnings.ca.gov.

BT8851-MPG



Maximum Performance Glass Hydraulic Spin-on
Notes: Rated 1000 PSI minimum burst.
 NOT interchangeable with BT8850-MPG.
Fits: Agco, Caterpillar, Cedarapids, Ford, Gehl, John Deere, New Holland, Vermeer, V.M.E., Volvo Equipment
Use With: OB8711, OB8712, OB8720, OB8721, OB8722, OB8724, OB8731, OB8732, OB8741, OB8742, OB8743, OB8744, OB8745, OB8746 filter bases.
Replaces: Agco 303506819; Caterpillar 1G8878; Cedarapids 451750014101; John Deere RE47313; New Holland 89821387; Vermeer 73113001; V.M.E. 110366077
Thread: 1 3/8 -12
O.D.: 3 3/4 (95.3)
Height: 9 19/32 (243.7)
I.Gskt: [1] Included

BT8852-MPG



Maximum Performance Glass Hydraulic Spin-on
Notes: Rated 1000 PSI minimum burst.
Fits: John Deere Equipment
Use With: OB8711, OB8712, OB8720, OB8721, OB8722, OB8724, OB8731, OB8732, OB8741, OB8742, OB8743, OB8744, OB8745, OB8746 filter bases.
Replaces: John Deere AH128449
Thread: 1 3/8 -12
O.D.: 3 3/4 (95.3)
Height: 9 19/32 (243.7)
I.Gskt: [1] Included

BT8853-MPG



Maximum Performance Glass Hydraulic Spin-on
Notes: Rated 1000 PSI minimum burst.
Fits: Case, Caterpillar Equipment
Use With: OB8711, OB8712, OB8720, OB8721, OB8722, OB8724, OB8731, OB8732, OB8741, OB8742, OB8743, OB8744, OB8745, OB8746 filter bases.
Replaces: Case N14232; John Deere RE39390
Thread: 1 3/8 -12
O.D.: 3 3/4 (95.3)
Height: 9 17/32 (242.1)
I.Gskt: [1] Included

BT8855-MPG



Maximum Performance Glass Hydraulic Spin-on
Notes: Rated 1000 PSI minimum burst.
Fits: Various Hydraulic Applications
Use With: OB8711, OB8712, OB8720, OB8721, OB8722, OB8724, OB8731, OB8732, OB8741, OB8742, OB8743, OB8744, OB8745, OB8746 filter bases.
Replaces: Donaldson P167590
Thread: 1 3/8 -12
O.D.: 3 3/4 (95.3)
Height: 9 19/32 (243.7)
I.Gskt: [1] Included

BT8856-MPG



Maximum Performance Glass Hydraulic Spin-on
Notes: Rated 1000 PSI minimum burst.
Fits: Sakai Equipment
Use With: OB8711, OB8712, OB8720, OB8721, OB8722, OB8724, OB8731, OB8732, OB8741, OB8742, OB8743, OB8744, OB8745, OB8746 filter bases.
Replaces: Koehring 853531235, 8535301235
Thread: 1 3/8 -12
O.D.: 3 3/4 (95.3)
Height: 9 19/32 (243.7)
I.Gskt: [1] Included

BT8861



Hydraulic Spin-on
Notes: Rated 1000 PSI minimum burst.
Fits: Bobcat Loaders; Case Equipment
Use With: OB8711, OB8712, OB8720, OB8721, OB8722, OB8724, OB8731, OB8732, OB8741, OB8742, OB8743, OB8744, OB8745, OB8746 filter bases.
Replaces: Case D126922; Champion 44419; Timberjack 8428088; Versatile 79446
Thread: 1 3/8 -12
O.D.: 3 3/4 (95.3)
Height: 9 19/32 (243.7)
I.Gskt: [1] Included

BT8862



Hydraulic Spin-on
Notes: Rated 1000 PSI minimum burst.
Fits: Champion, Versatile Equipment
Use With: OB8711, OB8712, OB8720, OB8721, OB8722, OB8724, OB8731, OB8732, OB8741, OB8742, OB8743, OB8744, OB8745, OB8746 filter bases.
Replaces: Case N7332
Thread: 1 3/8 -12
O.D.: 3 3/4 (95.3)
Height: 9 19/32 (243.7)
I.Gskt: [1] Included

BT8863



Hydraulic Spin-on
Notes: Rated 1000 PSI minimum burst.
Fits: Timberjack Logging Equipment
Use With: OB8711, OB8712, OB8720, OB8721, OB8722, OB8724, OB8731, OB8732, OB8741, OB8742, OB8743, OB8744, OB8745, OB8746 filter bases.
Replaces: Case D89909
Thread: 1 3/8 -12
O.D.: 3 3/4 (95.3)
Height: 9 19/32 (243.7)
O-Ring: [1] Included

BT8870-MPG



Maximum Performance Glass Hydraulic Spin-on
Notes: Can be used with OB8771, OB8772, OB8773 bases.
Fits: Case-International, Caterpillar, John Deere Equipment
Replaces: International 1971728-C1; John Deere RE51797
Thread: 1 3/4 -12
O.D.: 4 23/32 (119.9)
Height: 14 1/8 (358.8)
I.Gskt: [1] Included
Related To: BT9560-MPG (Micron Difference)











Measurements Are Shown In Inches And (Millimeters)

WARNING: These products can expose you to chemicals, including Diisononyl Phthalate, Carbon black extracts, Nickel, 1,3 Butadiene, Ethylene Oxide, Epichlorohydrin, which are known to the State of California to cause cancer, and Bisphenol, Ethylene Glycol, Ethylene Oxide, 1,3 Butadiene, Epichlorohydrin, which are known to the State of California to cause birth defects or other reproductive harm. For more information go to www.P65Warnings.ca.gov.

<p>BT8873 Hydraulic Spin-on Notes: Can be used with OB8771, OB8772, OB8773 bases. Fits: Champion, Clark, Daewoo, Link-Belt, V.M.E., Volvo Equipment Replaces: Champion 37104; Clark 243622, 965899 Thread: 1 3/4 -12 O.D.: 4 3/4 (120.7) Height: 11 17/32 (292.9) I.Gskt: [1] Included</p> 	<p>BT8878-MPG Maximum Performance Glass Hydraulic Spin-on Notes: Can be used with OB8771, OB8772, OB8773 bases. Fits: Caterpillar, Champion Equipment Replaces: Champion 45543 Thread: 1 3/4 -12 O.D.: 4 23/32 (119.9) Height: 11 17/32 (292.9) I.Gskt: [1] Included</p> 
<p>BT8874-MPG Maximum Performance Glass Hydraulic Spin-on Notes: Can be used with OB8771, OB8772, OB8773 bases. Fits: Case, Ford, John Deere, New Holland, Versatile Equipment Replaces: Case N9086, A49386; John Deere AT112393; New Holland 9821388 Thread: 1 3/4 -12 O.D.: 4 23/32 (119.9) Height: 11 17/32 (292.9) I.Gskt: [1] Included</p> 	<p>BT8879-MPG Maximum Performance Glass Hydraulic Spin-on Notes: Can be used with OB8771, OB8772, OB8773 bases. Fits: Caterpillar, Timberjack, Volvo Equipment Replaces: Timberjack F434370 Thread: 1 3/4 -12 O.D.: 4 23/32 (119.9) Height: 11 17/32 (292.9) I.Gskt: [1] Included</p> 
<p>BT8875-MPG Maximum Performance Glass Hydraulic Spin-on Notes: Can be used with OB8771, OB8772, OB8773 bases. Fits: Caterpillar Crawler Tractors Replaces: Caterpillar 9T6636 Thread: 1 3/4 -12 O.D.: 4 23/32 (119.9) Height: 7 3/4 (196.9) O-Ring: [1] Included</p> 	<p>BT8880-MPG Maximum Performance Glass Hydraulic Spin-on Notes: Can be used with OB8771, OB8772, OB8773 bases. Fits: Ford, New Holland Equipment; Versatile Tractors Replaces: New Holland 9706161, 89706161 Thread: 1 3/4 -12 O.D.: 4 23/32 (119.9) Height: 7 3/4 (196.9) I.Gskt: [1] Included</p> 
<p>BT8876-MPG Maximum Performance Glass Hydraulic Spin-on Notes: Can be used with OB8771, OB8772, OB8773 bases. Fits: Caterpillar, Champion Equipment; Ingersoll-Rand Compressors; Volvo Motor Graders Replaces: Caterpillar 9T0973; Champion 49076; Ingersoll-Rand 51302214 Thread: 1 3/4 -12 O.D.: 4 3/4 (120.7) Height: 11 19/32 (294.5) I.Gskt: [1] Included</p> 	<p>PT8883 Hydraulic Element Fits: Drott Equipment; Poclain Excavators Replaces: Case R1050586 O.D.: 3 25/32 (96.0) I.D.: 13/32 (10.3) & 2 11/16 (68.3) Height: 6 23/32 (170.7) A. Gskt: [1] Attached</p> 
<p>BT8877-MPG Maximum Performance Glass Hydraulic Spin-on Notes: Can be used with OB8771, OB8772, OB8773 bases. Fits: Various Hydraulic Applications Replaces: Donaldson P170906 Thread: 1 3/4 -12 O.D.: 4 23/32 (119.9) Height: 11 17/32 (292.9) I.Gskt: [1] Included</p> 	<p>PT8884-MPG Wire Mesh Supported Maximum Performance Glass Hydraulic Element Contains: Viton O-Ring for high heat applications. Replaces: Parker 932636Q, 983061 O.D.: 3 19/32 (91.3) I.D.: 1 29/32 (48.4) One End Height: 7 27/32 (199.2) O-Ring: [1] Attached</p> 

Measurements Are Shown In Inches And (Millimeters)

WARNING: These products can expose you to chemicals, including Diisononyl Phthalate, Carbon black extracts, Nickel, 1,3 Butadiene, Ethylene Oxide, Epichlorohydrin, which are known to the State of California to cause cancer, and Bisphenol, Ethylene Glycol, Ethylene Oxide, 1,3 Butadiene, Epichlorohydrin, which are known to the State of California to cause birth defects or other reproductive harm. For more information go to www.P65Warnings.ca.gov.

<p>PT8885-MPG</p> 	<p>Wire Mesh Supported Maximum Performance Glass Hydraulic Element Replaces: Schroeder KZ25 O.D.: 3 29/32 (99.2) I.D.: 1 5/8 (41.3) Height: 9 1/8 (231.8) Grommets: [2] Attached</p>	<p>PT8891-MPG</p> 	<p>Maximum Performance Glass 2-Section Hydraulic Element Contains: Grommet Seal Between Sections Fits: Hood Forestry Equipment Replaces: Parker 932410, 932694Q; Donaldson P174914; Fleetguard HF35000 O.D.: 3 11/16 (93.7) I.D.: 1 9/16 (39.7) One End Height: 18 15/16 (481.0) Grommets: [1] Attached</p>
<p>BT8886-MPG</p> 	<p>Maximum Performance Glass Hydraulic Spin-on Fits: Ag-Chem Ro-Gators; Caterpillar Equipment Replaces: Ag-Chem 714122; Donaldson P173702 Thread: 2 -12 O.D.: 3 1/8 (79.4) Height: 9 17/32 (242.1)</p>	<p>BT8892-MPG</p> 	<p>Maximum Performance Glass Hydraulic Spin-on Fits: Ingersoll-Rand Compressors Use With: OB8771, OB8772, OB8773 filter bases. Replaces: Ingersoll-Rand 36860336; Donaldson P165672 Thread: 1 3/4 -12 O.D.: 4 23/32 (119.9) Height: 11 17/32 (292.9) I.Gskt: [1] Included</p>
<p>PT8887</p> 	<p>Hydraulic Element Contains: Viton O-Ring for high heat applications Fits: Terex Equipment Replaces: Parker 922625; Donaldson P164556; Fleetguard HF7739 O.D.: 2 3/8 (60.3) I.D.: 1 (25.4) One End Height: 5 5/16 (134.9) O-Ring: [1] Attached</p>	<p>PT8893</p> 	<p>Hydraulic Element Fits: Caterpillar Excavators Replaces: Caterpillar 93-5369 O.D.: 4 13/32 (111.9) I.D.: 2 3/4 (69.9) Height: 11 9/16 (293.7)</p>
<p>PT8888</p> 	<p>Hydraulic Element Replaces: Schroeder CC10; Donaldson P171315; Fleetguard HF7314 O.D.: 2 7/8 (73.0) I.D.: 1 (25.4) One End Height: 9 5/8 (244.5) I.Gskt: [1] Included</p>	<p>PT8894-MPG</p> 	<p>Wire Mesh Supported Maximum Performance Glass Hydraulic Element Fits: Liebherr Excavators Replaces: Liebherr 7363107 O.D.: 1 27/32 (46.8) I.D.: 7/8 (22.2) One End Height: 3 5/16 (84.1) O-Ring: [1] Attached</p>
<p>PT8889</p> 	<p>Hydraulic Element Fits: Caterpillar Excavators Replaces: Caterpillar 94-3229 O.D.: 5 29/32 (150.0) I.D.: 4 11/32 (110.3) Height: 11 13/16 (300.0) O-Ring: [1] Included</p>	<p>PT8895-MPG</p> 	<p>Wire Mesh Supported Maximum Performance Glass Hydraulic Element Fits: Case-International, New Holland Tractors Replaces: Case N3150506; Fleetguard HF30196 O.D.: 2 3/32 (53.2) I.D.: 7/8 (22.2) One End Height: 4 9/16 (115.9) O-Ring: [1] Attached</p>
<p>BT8890-MPG</p> 	<p>Maximum Performance Glass Hydraulic Spin-on Fits: John Deere Compact Utility Tractors Replaces: John Deere LVA11522 Thread: 1 1/2 -16 O.D.: 4 21/32 (118.3) Height: 6 9/32 (159.5) I.Gskt: [1] Included</p>	<p>PT8896</p> 	<p>Hydraulic Element Fits: Samsung, Volvo Excavators Replaces: Volvo 104100130 O.D.: 5 29/32 (150.0) I.D.: 4 11/32 (110.3) Height: 17 23/32 (450.1)</p>













Measurements Are Shown In Inches And (Millimeters)

WARNING: These products can expose you to chemicals, including Diisononyl Phthalate, Carbon black extracts, Nickel, 1,3 Butadiene, Ethylene Oxide, Epichlorohydrin, which are known to the State of California to cause cancer, and Bisphenol, Ethylene Glycol, Ethylene Oxide, 1,3 Butadiene, Epichlorohydrin, which are known to the State of California to cause birth defects or other reproductive harm. For more information go to www.P65Warnings.ca.gov.

<p>PT8897-MPG Wire Mesh Supported Maximum Performance Glass Hydraulic Element Contains: 87 PSID By-Pass Valve Fits: Case Excavators Replaces: Case C2950511 O.D.: 2 7/8 (73.0) I.D.: 1 11/32 (34.1) One End Height: 15 5/32 (385.0) O-Ring: [1] Attached</p> 	<p>BT8903 Hydraulic Spin-on Fits: Industrial Applications Replaces: LHA SPE25-25; PTI F4E040DCB; Donaldson P550256 Thread: 1 -12 O.D.: 3 11/16 (93.7) Height: 8 25/32 (223.0) I.Gskt: G381-A</p> 
<p>BT8898 Hydraulic Spin-on Fits: Hitachi, Kubota Excavators, Loaders Replaces: Kubota 6813-16-2130 Thread: 1 1/8 -16 O.D.: 3 11/16 (93.7) Height: 5 21/32 (143.7) I.Gskt: G401</p> 	<p>BT8904-MPG Maximum Performance Glass Hydraulic Spin-on Notes: Rated 1000 PSI minimum burst. Dome end accepts 1/2 In. socket driver. Fits: John Deere Tractors Replaces: John Deere AL156625; Mann & Hummel WH945 Thread: 1 3/8 -12 O.D.: 3 3/4 (95.3) Height: 6 11/32 (161.1) I.Gskt: [1] Included</p> 
<p>BT8899 Hydraulic Spin-on Contains: 15 PSID By-Pass Valve By-Pass Screen Fits: New Holland Tractors Replaces: New Holland 5174044 Thread: 1 3/4 -16 O.D.: 5 3/8 (136.5) Height: 7 (177.8) I.Gskt: [1] Included</p> 	<p>BT8905 Hydraulic Spin-on Fits: Case-International, Ford, New Holland Mowers, Tractors Replaces: Ford SBA340500770, SBA340500890; New Holland 87300195, 87300196; Fleetguard HF35254 Thread: 3/4 -16 O.D.: 3 23/32 (94.5) Height: 3 7/8 (98.4) I.Gskt: G324-A</p> 
<p>BT8900 Stainless Steel Mesh Hydraulic Spin-on Contains: 100 Mesh Media Fits: Kubota Tractors Replaces: Kubota 35861-82630 Thread: 1 -12 O.D.: 3 11/16 (93.7) Height: 7 3/16 (182.6) I.Gskt: G401</p> 	<p>BT8906 Hydraulic Spin-on Contains: Retainer Ring Fits: Samsung, Volvo Excavators Replaces: Volvo 104207040; Fleetguard HF7935 Thread: M48 x 2.0 O.D.: 5 9/32 (134.1) Height: 6 27/32 (173.8) I.Gskt: [1] Included</p> 
<p>BT8901-MPG Maximum Performance Glass Hydraulic Spin-on Fits: Case-International Tractors Replaces: Case 1976934C4, 1976934C5 Thread: 1 1/2 -16 O.D.: 5 1/32 (127.8) Height: 6 31/32 (177.0) F. Gskt: G369-B, G372, G447</p> 	<p>PT8907-MPG Wire Mesh Supported Maximum Performance Glass Hydraulic Element Fits: Case-International Tractors Replaces: Case 93402-C1, 93413-C1 O.D.: 5 3/32 (129.4) I.D.: 2 9/16 (65.1) Height: 3 (76.2) A. Gskt: [2] Attached O-Ring: [3] Included Related To: PT565 (Standard Media Version)</p> 
<p>BT8902 Hydraulic Spin-on Fits: Kubota Tractors Replaces: Kubota 67955-37710 Thread: M20 x 1.5 O.D.: 3 (76.2) Height: 4 13/16 (122.2) I.Gskt: [1] Included</p> 	<p>BT8908 Hydraulic Spin-on Fits: Kubota Excavators Replaces: Kubota 68051-62220; Yanmar 172638-73730 Thread: 3/4 -16 O.D.: 3 1/32 (77.0) Height: 4 3/32 (104.0) I.Gskt: [1] Included</p> 

Measurements Are Shown In Inches And (Millimeters)

WARNING: These products can expose you to chemicals, including Diisononyl Phthalate, Carbon black extracts, Nickel, 1,3 Butadiene, Ethylene Oxide, Epichlorohydrin, which are known to the State of California to cause cancer, and Bisphenol, Ethylene Glycol, Ethylene Oxide, 1,3 Butadiene, Epichlorohydrin, which are known to the State of California to cause birth defects or other reproductive harm. For more information go to www.P65Warnings.ca.gov.

<p>PT8909</p> 	<p>Hydraulic Element Fits: Link-Belt, Sumitomo Excavators Replaces: Case 159274A1; Link-Belt KRJ3836 O.D.: 5 29/32 (150.0) I.D.: 4 11/32 (110.3) Height: 17 29/32 (454.8) A. Gskt: [2] Attached</p>	<p>BT8915</p>  <p>Hydraulic Spin-on Contains: Water Absorbent Media Replaces: Filtrac A121CW10; Woodgate WGH1792 Thread: 1 1/4 -11 BSP-PL O.D.: 5 1/8 (130.2) Height: 8 29/32 (226.2) I.Gskt: [1] Included</p>
<p>BT8910-MPG</p> 	<p>Maximum Performance Glass Hydraulic Spin-on Notes: Can be used with OB8771, OB8772, OB8773 bases. Fits: John Deere Tractors Replaces: John Deere RE38965; Donaldson P173521 Thread: 1 3/4 -12 O.D.: 4 23/32 (119.9) Height: 11 17/32 (292.9) I.Gskt: [1] Included</p>	<p>BT8916</p>  <p>Hydraulic Spin-on Notes: OBSOLETE. Availability Limited to Dealer Stock. Replaces: New Holland 87761096; Woodgate WGH1819 Thread: 3/4 -16 O.D.: 3 11/16 (93.7) Height: 8 1/16 (103.2) I.Gskt: [1] Included</p>
<p>BT8911-MPG</p> 	<p>Maximum Performance Glass Hydraulic Spin-on Fits: New Holland Loaders Use With: OB8771, OB8772, OB8773 filter bases. Replaces: New Holland 85802793; Donaldson P176779 Thread: 1 3/4 -12 O.D.: 4 23/32 (119.9) Height: 11 17/32 (292.9) I.Gskt: [1] Included</p>	<p>BT8917</p>  <p>Hydraulic Spin-on Replaces: Mitsubishi 4060100260; Woodgate WGH1825 Thread: M20 x 1.5 O.D.: 3 1/8 (79.4) Height: 3 (76.2) I.Gskt: [1] Included</p>
<p>PT8912</p> 	<p>Hydraulic Element Fits: Fiat-Allis, New Holland Motor Graders Replaces: New Holland 73125853 O.D.: 5 1/8 (130.2) I.D.: 3 3/8 (85.7) Height: 9 (228.6)</p>	<p>BT8918</p>  <p>Hydraulic Spin-on Fits: Toro Lawn & Garden Tractors Replaces: Toro 67-8110; Fleetguard HF6357; Woodgate WGH1835 Thread: 1 -12 O.D.: 3 21/32 (92.9) Height: 4 1/4 (108.0) I.Gskt: [1] Included</p>
<p>BT8913-MPG</p> 	<p>Maximum Performance Glass Hydraulic Spin-on Replaces: MP Filtri CS50A25; Woodgate WGH9166 Thread: 3/4 -14 BSP-PL O.D.: 3 3/4 (95.3) Height: 5 23/32 (145.3)</p>	<p>BT8919</p>  <p>Hydraulic Spin-on Fits: Kato Excavators Replaces: Kato 68935703032; Woodgate WGH1844 Thread: M22 x 1.5 O.D.: 3 7/8 (98.4) Height: 5 7/32 (132.6) I.Gskt: [1] Included</p>
<p>BT8914</p> 	<p>Hydraulic Spin-on Notes: OBSOLETE. Availability Limited to Dealer Stock. Contains: Threaded hex nut for removal. Replaces: Fairey-Arlon CXX3-10; Fleetguard HF35135; Woodgate WGCX3-10 Thread: M60 x 1.5 O.D.: 3 31/32 (100.8) Height: 7 1/4 (184.2)</p>	<p>BT8920</p>  <p>Hydraulic Spin-on Fits: Case-International, New Holland Tractors Replaces: Fiat-Iveco 1930986; Fleetguard HF28833; Woodgate WGH1906 Thread: M40 x 2.0 O.D.: 4 3/16 (106.4) Height: 7 1/16 (179.4) I.Gskt: [1] Included</p>

Measurements Are Shown In Inches And (Millimeters)

WARNING: These products can expose you to chemicals, including Diisononyl Phthalate, Carbon black extracts, Nickel, 1,3 Butadiene, Ethylene Oxide, Epichlorohydrin, which are known to the State of California to cause cancer, and Bisphenol, Ethylene Glycol, Ethylene Oxide, 1,3 Butadiene, Epichlorohydrin, which are known to the State of California to cause birth defects or other reproductive harm. For more information go to www.P65Warnings.ca.gov.

BT8922

Hydraulic Spin-on



Contains: 36 PSID By-Pass Valve
Replaces: Manitou 137658; Fleetguard HF6315; Woodgate WGH6315
Thread: 3/4 -16
O.D.: 3 3/4 (95.3)
Height: 5 25/32 (146.8)
I.Gskt: [1] Included

BT8935

Hydraulic Spin-on



Contains: 25 PSID By-Pass Valve
Fits: New Holland Equipment
Replaces: U.C.C. UC2408; Fleetguard HF7901; Woodgate WGUC2408
Thread: 3/4 -14 BSP-PL
O.D.: 3 3/4 (95.3)
Height: 5 3/4 (146.0)
I.Gskt: [1] Included

BT8926

Hydraulic Spin-on



Contains: 51 PSID By-Pass Valve
Fits: Deutz Tractors
Replaces: Deutz 4399525; Fleetguard HF28818; Woodgate WGH950-5
Thread: 1 -12
O.D.: 3 21/32 (92.9)
Height: 6 25/32 (172.2)
I.Gskt: [1] Included

BT8937

Hydraulic Spin-on



Replaces: Benford 17032; Fleetguard HF6327; Woodgate WGH9994
Thread: 1 1/2 -11 BSP-PL
O.D.: 5 1/32 (127.8)
Height: 7 19/32 (192.9)

BT8927

Hydraulic Spin-on



Fits: Hitachi Equipment; Kubota Excavators
Replaces: Woodgate WGH9996
Thread: 1 7/8 -12
O.D.: 5 7/32 (132.6)
Height: 6 7/8 (174.6)
I.Gskt: [1] Included

PT8939-MPG

Wire Mesh Supported Maximum Performance Glass Hydraulic Element



Fits: Demag Cranes
Replaces: Demag 69022273; Fleetguard HF35271; Woodgate WGH1736
O.D.: 4 21/32 (118.3)
I.D.: 2 11/32 (59.5)
Height: 6 9/16 (166.7)
O-Ring: [2] Attached

BT8928

Hydraulic Spin-on



Replaces: MP Filtri CS50M60; Woodgate WGH9168
Thread: 3/4 -14 BSP-PL
O.D.: 3 3/4 (95.3)
Height: 5 3/4 (146.0)

PT8940-MPG

Wire Mesh Supported Maximum Performance Glass Hydraulic Element



Fits: Manitou Equipment
Replaces: Manitou 563483; Woodgate WGH1794
O.D.: 2 23/32 (69.1)
I.D.: 1 5/32 (29.4)
Height: 6 29/32 (175.4)
O-Ring: [1] Attached

BT8930

Wire Mesh Hydraulic Spin-on



Replaces: MP Filtri CS100M125; Woodgate WGH9177
Thread: 1 1/4 -11 BSP-PL
O.D.: 5 1/16 (128.6)
Height: 7 3/32 (180.2)
I.Gskt: [1] Included

PT8941-MPG

Wire Mesh Supported Maximum Performance Glass Hydraulic Element



Notes: OBSOLETE. Availability Limited to Dealer Stock.
Replaces: Finn FC1073F025BS; Woodgate WGH1818
O.D.: 4 5/32 (105.6)
I.D.: 1 1/4 (31.8) & 2 27/32 (72.2)
Height: 19 7/16 (493.7)
O-Ring: [1] Attached

BT8931

Wire Mesh Hydraulic Spin-on



Replaces: MP Filtri CS150M60; Woodgate WGH9184
Thread: 1 1/4 -11 BSP-PL
O.D.: 5 1/16 (128.6)
Height: 9 (228.6)

PT8943-MPG











Wire Mesh Supported Maximum Performance Glass Hydraulic Element



Replaces: Demag 694400; Woodgate WGH1960
O.D.: 9 (228.6)
I.D.: 7 3/32 (180.2)
Height: 21 1/2 (546.1)
A. Gskt: [2] Attached











Measurements Are Shown In Inches And (Millimeters)

WARNING: These products can expose you to chemicals, including Diisononyl Phthalate, Carbon black extracts, Nickel, 1,3 Butadiene, Ethylene Oxide, Epichlorohydrin, which are known to the State of California to cause cancer, and Bisphenol, Ethylene Glycol, Ethylene Oxide, 1,3 Butadiene, Epichlorohydrin, which are known to the State of California to cause birth defects or other reproductive harm. For more information go to www.P65Warnings.ca.gov.

<p>PT8945-MPG</p> 	<p>Wire Mesh Supported Maximum Performance Glass Hydraulic Element Replaces: Argo V3092308; Woodgate WGH3208 O.D.: 3 17/32 (89.7) I.D.: 1 9/16 (39.7) One End Height: 9 5/32 (232.6) O-Ring: [1] Attached</p>	<p>PT8951-MPG</p> 	<p>Wire Mesh Supported Maximum Performance Glass Hydraulic Element Replaces: MP Filtri CU630A25NA; Woodgate WGH9651 O.D.: 5 1/8 (130.2) I.D.: 2 29/32 (73.8) Height: 9 13/16 (249.2) O-Ring: [2] Attached</p>
<p>PT8946-MPG</p> 	<p>Wire Mesh Supported Maximum Performance Glass Hydraulic Element Contains: 36 PSID By-Pass Valve Replaces: Argo V3052056; Woodgate WGH3556 O.D.: 1 13/16 (46.0) I.D.: 3/4 (19.0) One End Height: 7 27/32 (199.2) O-Ring: [1] Attached</p>	<p>PT8952-MPG</p> 	<p>Wire Mesh Supported Maximum Performance Glass Hydraulic Element Replaces: Stauff SL014E10B; Woodgate WGH9860 O.D.: 1 27/32 (46.8) I.D.: 1 (25.4) One End Height: 3 11/16 (93.7)</p>
<p>PT8947-MPG</p> 	<p>Wire Mesh Supported Maximum Performance Glass Hydraulic Element Fits: Caterpillar Excavators Replaces: Atlas Copco 8231-1018-04; Woodgate WGH9164 O.D.: 4 21/32 (118.3) I.D.: 2 11/32 (59.5) Height: 6 13/32 (162.7) O-Ring: [2] Attached</p>	<p>PT8954-MPG</p> 	<p>Wire Mesh Supported Maximum Performance Glass Hydraulic Element Fits: Liebherr Equipment Replaces: Hydac 110D020BNHC; Woodgate WGH11020DB O.D.: 1 27/32 (46.8) I.D.: 13/16 (20.6) One End Height: 6 1/32 (153.2) O-Ring: [1] Attached</p>
<p>PT8948-MPG</p> 	<p>Maximum Performance Glass Hydraulic Element with Bail Handle Contains: 25 PSID By-Pass Valve Replaces: MP Filtri MF1003AA10HB; Woodgate WGH9528 O.D.: 2 3/4 (69.9) I.D.: 1 5/8 (41.3) One End Height: 8 1/16 (204.8) O-Ring: [1] Attached, [1] Included</p>	<p>PT8955-MPG</p> 	<p>Wire Mesh Supported Maximum Performance Glass Hydraulic Element Fits: Roadtec Equipment Replaces: Hydac 160D010BH; Woodgate WGH16010DH O.D.: 2 23/32 (69.1) I.D.: 1 11/32 (34.1) One End Height: 4 17/32 (115.1) O-Ring: [1] Attached</p>
<p>PT8950-MPG</p> 	<p>Wire Mesh Supported Maximum Performance Glass Hydraulic Element with Bail Handle Contains: 72 PSID By-Pass Valve Replaces: MP Filtri MF7501AA25HB; Fleetguard HF35220; Woodgate WGH9592 O.D.: 5 1/8 (130.2) I.D.: 2 15/32 (62.7) One End Height: 16 7/32 (412.0) Spring: [1] Included Grommets: [1] Attached</p>	<p>PT8956-MPG</p> 	<p>Wire Mesh Supported Maximum Performance Glass Hydraulic Element with Bail Handle Contains: 43 PSID By-Pass Valve Replaces: Hydac 160R010BNHC; Woodgate WGH16010RB O.D.: 2 7/8 (73.0) I.D.: 1 13/32 (35.7) One End Height: 5 21/32 (143.7)</p>











Measurements Are Shown In Inches And (Millimeters)

WARNING: These products can expose you to chemicals, including Diisononyl Phthalate, Carbon black extracts, Nickel, 1,3 Butadiene, Ethylene Oxide, Epichlorohydrin, which are known to the State of California to cause cancer, and Bisphenol, Ethylene Glycol, Ethylene Oxide, 1,3 Butadiene, Epichlorohydrin, which are known to the State of California to cause birth defects or other reproductive harm. For more information go to www.P65Warnings.ca.gov.

<p>PT8957-MPG Wire Mesh Supported Maximum Performance Glass Hydraulic Element Replaces: Hydac 160D020BNHC; Fleetguard HF30702; Woodgate WGHH16020DB O.D.: 2 23/32 (69.1) I.D.: 1 5/16 (33.3) One End Height: 4 9/16 (115.9) O-Ring: [1] Attached</p> 	<p>PT8967-MPG Wire Mesh Supported Maximum Performance Glass Hydraulic Element Notes: Inside-Out Flow Direction Replaces: Fairey-Arlon TXW5CC25; Woodgate WGTW5CC-25 O.D.: 4 3/16 (106.4) I.D.: 13/32 (10.3) & 2 27/32 (72.2) Height: 10 9/32 (261.1) O-Ring: [1] Attached</p> 
<p>PT8958-MPG Wire Mesh Supported Maximum Performance Glass Hydraulic Element with Bail Handle Contains: 43 PSID By-Pass Valve Replaces: Hydac 165R020BN3HC; Woodgate WGHH165020RB O.D.: 2 3/8 (60.3) I.D.: 1 13/32 (35.7) One End Height: 9 (228.6)</p> 	<p>PT8969-MPG Wire Mesh Supported Maximum Performance Glass Hydraulic Element Notes: Inside-Out Flow Direction Replaces: Fairey-Arlon TXW8ACC25; Woodgate WGTW8ACC-25 O.D.: 4 31/32 (126.2) I.D.: 13/32 (10.3) & 3 5/8 (92.1) Height: 11 7/16 (290.5) O-Ring: [1] Attached</p> 
<p>PT8959-MPG Wire Mesh Supported Maximum Performance Glass Hydraulic Element Replaces: Hydac 240D005BNHC; Woodgate WGHH24005DB O.D.: 2 23/32 (69.1) I.D.: 1 9/32 (32.5) One End Height: 6 27/32 (173.8) O-Ring: [1] Attached</p> 	<p>PT8970-MPG Wire Mesh Supported Maximum Performance Glass Hydraulic Element Notes: Inside-Out Flow Direction Replaces: Fairey-Arlon TXW8BCC10; Fleetguard HF7958; Woodgate WGTW8BCC-10 O.D.: 4 31/32 (126.2) I.D.: 13/32 (10.3) & 3 5/8 (92.1) Height: 15 11/32 (389.7)</p> 
<p>PT8960-MPG Wire Mesh Supported Maximum Performance Glass Hydraulic Element Replaces: Hydac 30D010BNHC; Fleetguard HF30348; Woodgate WGHH30010DB O.D.: 1 3/8 (34.9) I.D.: 1/2 (12.7) One End Height: 3 21/32 (92.9) O-Ring: [1] Attached</p> 	<p>PT8971-MPG Wire Mesh Supported Maximum Performance Glass Hydraulic Element Notes: Inside-Out Flow Direction Replaces: Fleetguard HF7964; Woodgate WGTW8CCC-10 O.D.: 4 31/32 (126.2) I.D.: 13/32 (10.3) & 3 5/8 (92.1) Height: 18 29/32 (480.2) O-Ring: [1] Attached</p> 
<p>PT8962-MPG Wire Mesh Supported Maximum Performance Glass Hydraulic Element Fits: Telesco Pelle Loaders Replaces: Hydac 60D010BNHC; Fleetguard HF30710; Woodgate WGHH60010DB O.D.: 1 27/32 (46.8) I.D.: 7/8 (22.2) One End Height: 3 5/16 (84.1) O-Ring: [1] Attached</p> 	<p>PT8972-MPG Wire Mesh Supported Maximum Performance Glass Hydraulic Element Fits: Caterpillar Equipment Replaces: Argo V3051008; Woodgate WGH1939 O.D.: 1 25/32 (45.2) I.D.: 13/16 (20.6) One End Height: 4 3/32 (104.0) O-Ring: [1] Attached</p> 

Measurements Are Shown In Inches And (Millimeters)

WARNING: These products can expose you to chemicals, including Diisononyl Phthalate, Carbon black extracts, Nickel, 1,3 Butadiene, Ethylene Oxide, Epichlorohydrin, which are known to the State of California to cause cancer, and Bisphenol, Ethylene Glycol, Ethylene Oxide, 1,3 Butadiene, Epichlorohydrin, which are known to the State of California to cause birth defects or other reproductive harm. For more information go to www.P65Warnings.ca.gov.

<p>PT8974-MPG Wire Mesh Supported Maximum Performance Glass Hydraulic Element Replaces: Terex 15266831; Woodgate WGH1964 O.D.: 2 3/8 (60.3) I.D.: 1 13/32 (35.7) One End Height: 5 11/32 (135.7) O-Ring: [1] Attached</p> 	<p>PT8982-MPG Wire Mesh Supported Maximum Performance Glass Hydraulic Element Notes: Inside-Out Flow Direction Replaces: Fairey-Arlon TXW4CC25; Woodgate WGTW4CC-25 O.D.: 4 5/32 (105.6) I.D.: 5/8 (15.9) & 2 27/32 (72.2) Height: 7 7/16 (188.9) O-Ring: [1] Attached</p> 
<p>PT8975-MPG Wire Mesh Supported Maximum Performance Glass Hydraulic Element Fits: Caterpillar, Fiat-Hitachi Excavators; Volvo Dump Trucks Replaces: Argo V3060708; Woodgate WGH3708 O.D.: 2 3/16 (55.6) I.D.: 1 1/8 (28.6) One End Height: 2 23/32 (69.1) O-Ring: [1] Attached</p> 	<p>PT8984-MPG Wire Mesh Supported Maximum Performance Glass Hydraulic Element Contains: Viton gaskets for high heat applications Spring Locator Replaces: Fairey-Arlon 270Z105A; Woodgate WGAZ2715 O.D.: 2 29/32 (73.8) I.D.: 1 1/4 (31.8) One End Height: 4 1/8 (104.8) O-Ring: [1] Viton Attached, [1] Viton Included</p> 
<p>PT8978-MPG Wire Mesh Supported Maximum Performance Glass Hydraulic Element Replaces: MP Filtri HP1352A25NA; Woodgate WGH9268 O.D.: 2 3/32 (53.2) I.D.: 1 1/32 (26.2) One End Height: 9 1/16 (230.2) O-Ring: [1] Attached</p> 	<p>PT8985-MPG Wire Mesh Supported Maximum Performance Glass Hydraulic Element Contains: Viton gaskets for high heat applications Spring Locator Replaces: Fairey-Arlon 270Z215A; Woodgate WGAZ2721 O.D.: 2 29/32 (73.8) I.D.: 1 1/4 (31.8) One End Height: 9 11/32 (237.3) O-Ring: [1] Viton Attached, [1] Viton Included</p> 
<p>PT8980-MPG Wire Mesh Supported Maximum Performance Glass Hydraulic Element Replaces: MP Filtri HP320A06NA; Woodgate WGH9336 O.D.: 3 1/16 (77.8) I.D.: 1 17/32 (38.9) One End Height: 9 1/4 (235.0) O-Ring: [1] Attached</p> 	<p>PT8986-MPG Wire Mesh Supported Maximum Performance Glass Hydraulic Element Notes: OBSOLETE. Availability Limited to Dealer Stock. Replaces: Fairey-Arlon TXW3CC10; Woodgate WGTW3CC-10 O.D.: 2 27/32 (72.2) I.D.: 5/8 (15.9) & 1 25/32 (45.2) Height: 5 29/32 (150.0) O-Ring: [1] Attached</p> 
<p>PT8981-MPG Wire Mesh Supported Maximum Performance Glass Hydraulic Element with Bail Handle Contains: 43 PSID By-Pass Valve Replaces: Hydac 660R010BNHC; Donaldson P170619; Woodgate WGH66010RB O.D.: 4 1/2 (114.3) I.D.: 2 11/16 (68.3) One End Height: 13 1/8 (333.4)</p> 	<p>PT8987-MPG Maximum Performance Glass Hydraulic Element Notes: Inside-Out Flow Direction Replaces: Fairey-Arlon TXW2CC10; Woodgate WGTW2CC-10 O.D.: 2 27/32 (72.2) I.D.: 9/32 (7.1) & 2 (50.8) Height: 4 3/16 (106.4) O-Ring: [1] Attached</p> 

Measurements Are Shown In Inches And (Millimeters)

WARNING: These products can expose you to chemicals, including Diisononyl Phthalate, Carbon black extracts, Nickel, 1,3 Butadiene, Ethylene Oxide, Epichlorohydrin, which are known to the State of California to cause cancer, and Bisphenol, Ethylene Glycol, Ethylene Oxide, 1,3 Butadiene, Epichlorohydrin, which are known to the State of California to cause birth defects or other reproductive harm. For more information go to www.P65Warnings.ca.gov.

PT8989-MPG Maximum Performance Glass Hydraulic Element with 2 Bail Handles
Replaces: J.C. Bamford 32/910801; Fleetguard HF35203; Woodgate WGH9520
O.D.: 2 3/4 (69.9)
I.D.: 1 3/32 (27.8) One End
Height: 5 7/32 (132.6)
O-Ring: [1] Attached



PT8995-MPG Wire Mesh Supported Maximum Performance Glass Hydraulic Element
Replaces: MP Filtri HP651A10NA; Woodgate WGH9191
O.D.: 1 25/32 (45.2)
I.D.: 1 1/32 (26.2) One End
Height: 3 11/32 (84.9)
O-Ring: [1] Attached



PT8990-MPG Wire Mesh Supported Maximum Performance Glass Hydraulic Element
Replaces: Fairey-Arlon TXW12CC10; Fleetguard HF7966; Woodgate WGTW12CC-10
O.D.: 7 31/32 (202.4)
I.D.: 1/2 (12.7) & 6 3/16 (157.2)
Height: 21 15/32 (545.3)
O-Ring: [1] Attached



PT8996-MPG Wire Mesh Supported Maximum Performance Glass Hydraulic Element
Replaces: MP Filtri HP1351A25NA; Woodgate WGH9252
O.D.: 2 3/32 (53.2)
I.D.: 1 3/32 (27.8) One End
Height: 4 11/16 (119.1)
O-Ring: [1] Attached



PT8991-MPG Wire Mesh Supported Maximum Performance Glass Hydraulic Element
Replaces: Fairey-Arlon 170L210A; Woodgate WGAL1721
O.D.: 2 5/32 (54.8)
I.D.: 23/32 (18.3) One End
Height: 4 29/32 (124.6)
O-Ring: [1] Attached, [1] Included



PT8997-MPG Wire Mesh Supported Maximum Performance Glass Hydraulic Element with Bail Handle
Contains: By-Pass Valve
Replaces: MP Filtri MF1801AA10HB; Woodgate WGH9533
O.D.: 3 29/32 (99.2)
I.D.: 1 9/16 (39.7) One End
Height: 8 29/32 (226.2)
O-Ring: [1] Included



PT8992-MPG Wire Mesh Supported Maximum Performance Glass Hydraulic Element
Replaces: Fairey-Arlon 370Z205A; Woodgate WGAZ3725
O.D.: 3 11/16 (93.7)
I.D.: 1 29/32 (48.4) One End
Height: 7 27/32 (199.2)
O-Ring: [1] Attached, [1] Included



PT8998-MPG Wire Mesh Supported Maximum Performance Glass Hydraulic Element
Replaces: Fairey-Arlon 170L110A; Fleetguard HF30668; Woodgate WGAL1711
O.D.: 2 5/32 (54.8)
I.D.: 11/16 (17.5) One End
Height: 2 23/32 (69.1)
O-Ring: [1] Attached, [1] Included



PT8994-MPG Wire Mesh Supported Maximum Performance Glass Hydraulic Element
Replaces: Orenstein & Koppel 1771469; Fleetguard HF7560; Woodgate WGH4020
O.D.: 5 3/8 (136.5)
Flange: 5 15/16 (150.8)
I.D.: 3 5/32 (80.2) One End
Height: 14 3/32 (358.0)
A. Gskt: [1] Attached



PT8999-MPG Wire Mesh Supported Maximum Performance Glass Hydraulic Element
Notes: OBSOLETE. Availability Limited to Dealer Stock.
Replaces: Fairey-Arlon TXW3DCC25; Woodgate WGTW3DCC-25
O.D.: 2 27/32 (72.2)
I.D.: 5/8 (15.9) & 1 25/32 (45.2)
Height: 7 29/32 (200.8)
O-Ring: [1] Attached



H9001 Wire Mesh Supported Hydraulic Element
Contains: Reinforced Centertube
Fits: Terex Dump Trucks
Replaces: Pall HC8300FKN8H, HC8300FUN8H; Terex 15265318
O.D.: 5 31/32 (151.6)
I.D.: 4 1/8 (104.8)
Height: 8 3/16 (208.0)
I.Gskt: [2] Included



Measurements Are Shown In Inches And (Millimeters)

WARNING: These products can expose you to chemicals, including Diisononyl Phthalate, Carbon black extracts, Nickel, 1,3 Butadiene, Ethylene Oxide, Epichlorohydrin, which are known to the State of California to cause cancer, and Bisphenol, Ethylene Glycol, Ethylene Oxide, 1,3 Butadiene, Epichlorohydrin, which are known to the State of California to cause birth defects or other reproductive harm. For more information go to www.P65Warnings.ca.gov.

<p>H9007</p> 	<p>Wire Mesh Supported Hydraulic Element Contains: Reinforced Centertube Replaces: Pall HC8300FKN16H, HC8300FUN16H O.D.: 5 31/32 (151.6) I.D.: 4 1/8 (104.8) Height: 16 27/32 (427.8) I.Gskt: [2] Included</p>	<p>H9024</p>  <p>Wire Mesh Supported Hydraulic Element Notes: OBSOLETE. Availability Limited to Dealer Stock. Contains: Reinforced Centertube Replaces: Pall HC8400FKN26H, HC8400FUN26H O.D.: 6 (152.4) I.D.: 3 1/4 (82.6) Height: 25 5/8 (650.9) I.Gskt: [2] Included</p>
<p>H9013</p> 	<p>Wire Mesh Supported Hydraulic Element Contains: Reinforced Centertube Replaces: Pall HC8300FKN39H, HC8300FUN39H O.D.: 5 31/32 (151.6) I.D.: 4 1/8 (104.8) Height: 38 11/16 (982.7) I.Gskt: [2] Included</p>	<p>H9036</p>  <p>Wire Mesh Supported Hydraulic Element Replaces: Pall HC8500FKN13H, HC8500FUN13H O.D.: 3 13/16 (96.8) I.D.: 1 11/16 (42.9) Height: 12 27/32 (326.2) I.Gskt: [2] Included</p>
<p>H9014</p> 	<p>Wire Mesh Supported Hydraulic Element Contains: Reinforced Centertube Replaces: Pall HC8300FKS39H, HC8300FUS39H O.D.: 5 31/32 (151.6) I.D.: 4 5/32 (105.6) Height: 38 11/16 (982.7) I.Gskt: [2] Included</p>	<p>H9041</p>  <p>Wire Mesh Supported Hydraulic Element Replaces: Pall HC9020FKP4H, HC9020FUP4H O.D.: 1 25/32 (45.2) I.D.: 1 1/32 (26.2) One End Height: 4 1/2 (114.3) I.Gskt: [1] Included</p>
<p>H9020</p> 	<p>Wire Mesh Supported Hydraulic Element Replaces: Pall HC8400FKN16H, HC8400FUN16H O.D.: 6 (152.4) I.D.: 3 1/4 (82.6) Height: 16 7/8 (428.6) I.Gskt: [2] Included</p>	<p>H9042</p>  <p>Wire Mesh Supported Hydraulic Element Fits: Caterpillar Off-Highway Trucks Replaces: Pall HC9020FKN4H, HC9020FUN4H O.D.: 1 3/4 (44.4) I.D.: 1 1/32 (26.2) One End Height: 4 15/32 (113.5) I.Gskt: [1] Included</p>
<p>H9021</p> 	<p>Wire Mesh Supported Hydraulic Element Contains: Reinforced Centertube Replaces: Pall HC8400FKS16H, HC8400FUS16H O.D.: 6 (152.4) I.D.: 3 1/4 (82.6) Height: 16 7/8 (428.6) I.Gskt: [2] Included</p>	<p>H9043</p>  <p>Wire Mesh Supported Hydraulic Element Replaces: Pall HC9020FKS4H, HC9020FUS4H O.D.: 1 3/4 (44.4) I.D.: 1 1/32 (26.2) One End Height: 4 15/32 (113.5) I.Gskt: [1] Included</p>
		<p>H9043-V</p>  <p>Wire Mesh Supported Hydraulic Element Contains: Viton O-Ring for high heat applications. Fits: Volvo Dump Trucks Replaces: Volvo 11707525; Fleetguard HF30200 O.D.: 1 25/32 (45.2) I.D.: 1 1/32 (26.2) One End Height: 4 1/2 (114.3) O-Ring: [1] Viton Attached</p>

Measurements Are Shown In Inches And (Millimeters)

WARNING: These products can expose you to chemicals, including Diisononyl Phthalate, Carbon black extracts, Nickel, 1,3 Butadiene, Ethylene Oxide, Epichlorohydrin, which are known to the State of California to cause cancer, and Bisphenol, Ethylene Glycol, Ethylene Oxide, 1,3 Butadiene, Epichlorohydrin, which are known to the State of California to cause birth defects or other reproductive harm. For more information go to www.P65Warnings.ca.gov.

H9044 Wire Mesh Supported Hydraulic Element
Fits: Massey Ferguson Equipment
Replaces: Pall HC9020FKT4H, HC9020FUT4H
O.D.: 1 3/4 (44.4)
I.D.: 1 1/32 (26.2) One End
Height: 4 15/32 (113.5)
I.Gskt: [1] Included



H9049 Wire Mesh Supported Hydraulic Element
Replaces: Pall HC9021FKP4H, HC9021FUP4H
O.D.: 1 3/4 (44.4)
I.D.: 1 (25.4) One End
Height: 4 1/2 (114.3)
I.Gskt: [1] Included



H9045 Wire Mesh Supported Hydraulic Element
Replaces: Pall HC9020FKP8H, HC9020FUP8H
O.D.: 1 3/4 (44.4)
I.D.: 1 1/32 (26.2) One End
Height: 8 7/32 (208.8)
I.Gskt: [1] Included



H9050 Wire Mesh Supported Hydraulic Element
Replaces: Pall HC9021FKP4Z, HC9021FUP4Z
O.D.: 1 3/4 (44.4)
I.D.: 1 (25.4) One End
Height: 4 1/2 (114.3)
I.Gskt: [1] Included



H9046 Wire Mesh Supported Hydraulic Element
Replaces: Pall HC9020FKN8H, HC9020FUN8H
O.D.: 1 3/4 (44.4)
I.D.: 1 1/32 (26.2) One End
Height: 8 7/32 (208.8)
I.Gskt: [1] Included



H9051 Wire Mesh Supported Hydraulic Element
Replaces: Pall HC9021FKP8H, HC9021FUP8H
O.D.: 1 3/4 (44.4)
I.D.: 1 (25.4) One End
Height: 8 7/32 (208.8)
I.Gskt: [1] Included



H9047 Wire Mesh Supported Hydraulic Element
Replaces: Pall HC9020FKS8H, HC9020FUS8H
O.D.: 1 3/4 (44.4)
I.D.: 1 1/32 (26.2) One End
Height: 8 7/32 (208.8)
I.Gskt: [1] Included
Related To: H9052 (with Viton Gasket)



H9052 Wire Mesh Supported Hydraulic Element
Contains: Viton gasket for high heat applications
Replaces: Parker 932618Q; Fleetguard HF30237
O.D.: 1 25/32 (45.2)
I.D.: 1 (25.4) One End
Height: 8 7/32 (208.8)
I.Gskt: [1] Included
Related To: H9047 (with Buna N Gasket)



H9048 Wire Mesh Supported Hydraulic Element
Replaces: Pall HC9020FKT8H, HC9020FUT8H
O.D.: 1 3/4 (44.4)
I.D.: 1 1/32 (26.2) One End
Height: 8 7/32 (208.8)
I.Gskt: [1] Included













H9054 Wire Mesh Supported Hydraulic Element
Replaces: Pall HC9021FKT4Z, HC9021FUT4Z
O.D.: 1 3/4 (44.4)
I.D.: 1 (25.4) One End
Height: 4 1/2 (114.3)
I.Gskt: [1] Included













Measurements Are Shown In Inches And (Millimeters)

WARNING: These products can expose you to chemicals, including Diisononyl Phthalate, Carbon black extracts, Nickel, 1,3 Butadiene, Ethylene Oxide, Epichlorohydrin, which are known to the State of California to cause cancer, and Bisphenol, Ethylene Glycol, Ethylene Oxide, 1,3 Butadiene, Epichlorohydrin, which are known to the State of California to cause birth defects or other reproductive harm. For more information go to www.P65Warnings.ca.gov.

<p>H9055</p> 	<p>Wire Mesh Supported Hydraulic Element Replaces: Pall HC9021FKT8H, HC9021FUT8H O.D.: 1 3/4 (44.4) I.D.: 1 (25.4) One End Height: 8 7/32 (208.8) I.Gskt: [1] Included Related To: H9056 (with Viton Seal)</p>	<p>H9069</p> 	<p>Wire Mesh Supported Hydraulic Element Replaces: Pall HC9600FKP4H, HC9600FUP4H O.D.: 3 1/8 (79.4) I.D.: 1 11/16 (42.9) One End Height: 4 5/8 (117.5) I.Gskt: [1] Included</p>
<p>H9056</p> 	<p>Wire Mesh Supported Hydraulic Element Replaces: Pall HC9021FKT8Z, HC9021FUT8Z O.D.: 1 25/32 (45.2) I.D.: 1 1/32 (26.2) One End Height: 8 5/32 (207.2) I.Gskt: [1] Included Related To: H9055 (with Nitrile Seal)</p>	<p>H9070</p> 	<p>Wire Mesh Supported Hydraulic Element Replaces: Pall HC9600FKN4H, HC9600FUN4H O.D.: 3 1/8 (79.4) I.D.: 1 11/16 (42.9) One End Height: 4 5/8 (117.5) I.Gskt: [1] Included</p>
<p>H9058</p> 	<p>Wire Mesh Supported Hydraulic Element Replaces: Pall HC9400FKN13H, HC9400FUN13H O.D.: 3 25/32 (96.0) I.D.: 2 3/16 (55.6) Height: 13 3/16 (335.0) I.Gskt: [2] Included</p>	<p>H9071</p> 	<p>Wire Mesh Supported Hydraulic Element Fits: Bomag Paving Equipment; J.C. Bamford, V.M.E., Volvo Equipment Replaces: Pall HC9600FKS4H, HC9600FUS4H; V.M.E. 4881701; Volvo 1191331 O.D.: 3 1/8 (79.4) I.D.: 1 11/16 (42.9) One End Height: 4 5/8 (117.5) I.Gskt: [1] Included</p>
<p>H9060</p> 	<p>Wire Mesh Supported Hydraulic Element Replaces: Pall HC9400FKT13H, HC9400FUT13H O.D.: 3 25/32 (96.0) I.D.: 2 3/16 (55.6) Height: 13 3/16 (335.0) I.Gskt: [2] Included</p>	<p>H9072</p> 	<p>Wire Mesh Supported Hydraulic Element Fits: Case, John Deere Tractors Replaces: Case K946095; Pall HC9600FKT4H, HC9600FUT4H O.D.: 3 1/8 (79.4) I.D.: 1 11/16 (42.9) One End Height: 4 5/8 (117.5) I.Gskt: [1] Included</p>
<p>H9062</p> 	<p>Wire Mesh Supported Hydraulic Element Replaces: Pall HC9400FKN26H, HC9400FUN26H O.D.: 3 25/32 (96.0) I.D.: 2 3/16 (55.6) Height: 25 15/16 (658.8) I.Gskt: [2] Included</p>	<p>H9072-V</p> 	<p>Wire Mesh Supported Hydraulic Element Contains: Viton gasket for high heat applications Fits: Case Tractors Replaces: Pall HC9600FUT4Z; Woodgate WGPT9604Z O.D.: 3 3/32 (78.6) I.D.: 1 11/16 (42.9) One End Height: 4 19/32 (116.7) I.Gskt: [1] Included</p>











Measurements Are Shown In Inches And (Millimeters)

WARNING: These products can expose you to chemicals, including Diisononyl Phthalate, Carbon black extracts, Nickel, 1,3 Butadiene, Ethylene Oxide, Epichlorohydrin, which are known to the State of California to cause cancer, and Bisphenol, Ethylene Glycol, Ethylene Oxide, 1,3 Butadiene, Epichlorohydrin, which are known to the State of California to cause birth defects or other reproductive harm. For more information go to www.P65Warnings.ca.gov.

<p>H9073</p>  <p>Wire Mesh Supported Hydraulic Element Fits: Caterpillar, CMI Equipment Replaces: Pall HC9600FKP8H, HC9600FUP8H O.D.: 3 1/8 (79.4) I.D.: 1 11/16 (42.9) One End Height: 8 1/4 (209.6) I.Gskt: [1] Included</p>	<p>H9076-V</p>  <p>Wire Mesh Supported Hydraulic Element Contains: Viton gasket for high heat applications Replaces: Pall HC9600FUT8Z; WGPT9608Z O.D.: 3 3/32 (78.6) I.D.: 1 21/32 (42.1) One End Height: 8 3/16 (208.0) I.Gskt: [1] Included O-Ring: [1] Included</p>
<p>H9074</p>  <p>Wire Mesh Supported Hydraulic Element Fits: Bomag, Massey Ferguson, White Equipment Replaces: Bomag 7993014; Pall HC9600FKN8H, HC9600FUN8H O.D.: 3 1/8 (79.4) I.D.: 1 11/16 (42.9) One End Height: 8 1/4 (209.6) I.Gskt: [1] Included</p>	<p>H9077</p>  <p>Wire Mesh Supported Hydraulic Element Replaces: Pall HC9600FKP13H, HC9600FUP13H O.D.: 3 1/8 (79.4) I.D.: 1 11/16 (42.9) One End Height: 12 31/32 (329.4) I.Gskt: [1] Included</p>
<p>H9075</p>  <p>Wire Mesh Supported Hydraulic Element Fits: Bomag, Caterpillar, John Deere, Massey Ferguson, Tamrock Equipment Replaces: Pall HC9600FKS8H, HC9600FUS8H O.D.: 3 1/8 (79.4) I.D.: 1 11/16 (42.9) One End Height: 8 1/4 (209.6) I.Gskt: [1] Included</p>	<p>H9078</p>  <p>Wire Mesh Supported Hydraulic Element Fits: Wirtgen Milling Machines Replaces: Pall HC9600FKN13H, HC9600FUN13H O.D.: 3 1/8 (79.4) I.D.: 1 11/16 (42.9) One End Height: 12 31/32 (329.4) I.Gskt: [1] Included</p>
<p>H9075-V</p>  <p>Wire Mesh Supported Hydraulic Element Contains: Viton gasket for high heat applications. Fits: Volvo Motor Graders Replaces: Volvo 12733419; Parker 932655Q; Donaldson P164365 O.D.: 3 1/8 (79.4) I.D.: 1 11/16 (42.9) One End Height: 8 1/4 (209.6) I.Gskt: [1] Viton</p>	<p>H9078-V</p>  <p>Wire Mesh Supported Hydraulic Element Contains: Viton gasket for high heat applications Replaces: Case 78660C1; General Motors 23049373; International 78660-C1; Parker G01982; Schroeder SBG96001383 O.D.: 3 5/32 (80.2) I.D.: 1 23/32 (43.7) One End Height: 12 15/16 (328.6) I.Gskt: [1] Included</p>
<p>H9076</p>  <p>Wire Mesh Supported Hydraulic Element Replaces: Pall HC9600FKT8H, HC9600FUT8H O.D.: 3 1/8 (79.4) I.D.: 1 11/16 (42.9) One End Height: 8 1/4 (209.6) I.Gskt: [1] Included</p>	<p>H9079</p>  <p>Wire Mesh Supported Hydraulic Element Replaces: Pall HC9600FKS13H, HC9600FUS13H O.D.: 3 1/8 (79.4) I.D.: 1 11/16 (42.9) One End Height: 12 31/32 (329.4) I.Gskt: [1] Included</p>











Measurements Are Shown In Inches And (Millimeters)

WARNING: These products can expose you to chemicals, including Diisononyl Phthalate, Carbon black extracts, Nickel, 1,3 Butadiene, Ethylene Oxide, Epichlorohydrin, which are known to the State of California to cause cancer, and Bisphenol, Ethylene Glycol, Ethylene Oxide, 1,3 Butadiene, Epichlorohydrin, which are known to the State of California to cause birth defects or other reproductive harm. For more information go to www.P65Warnings.ca.gov.

<p>H9080</p> 	<p>Wire Mesh Supported Hydraulic Element Replaces: Pall HC9600FKT13H, HC9600FUT13H O.D.: 3 1/8 (79.4) I.D.: 1 11/16 (42.9) One End Height: 12 31/32 (329.4) I.Gskt: [1] Included</p>	<p>H9085</p>  <p>Wire Mesh Supported Hydraulic Element Replaces: Pall HC9600FUS16H, HC9600KUS16H O.D.: 3 1/8 (79.4) I.D.: 1 11/16 (42.9) One End Height: 16 7/8 (428.6) I.Gskt: [1] Included</p>
<p>H9081</p> 	<p>Wire Mesh Supported Hydraulic Element Replaces: Pall HC9600FKP13Z, HC9600FUP13Z O.D.: 3 1/8 (79.4) I.D.: 1 11/16 (42.9) One End Height: 12 31/32 (329.4) I.Gskt: [1] Included</p>	<p>H9086</p>  <p>Wire Mesh Supported Hydraulic Element Replaces: Pall HC9600FKT16H, HC9600FUT16H O.D.: 3 1/8 (79.4) I.D.: 1 11/16 (42.9) One End Height: 16 7/8 (428.6) I.Gskt: [1] Included Related To: H9087 (with Viton Gasket)</p>
<p>H9082</p> 	<p>Wire Mesh Supported Hydraulic Element Replaces: Pall HC9600FKS13Z, HC9600FUS13Z O.D.: 3 1/8 (79.4) I.D.: 1 11/16 (42.9) One End Height: 12 31/32 (329.4) I.Gskt: [1] Included</p>	<p>H9087</p>  <p>Wire Mesh Supported Hydraulic Element Contains: Viton gasket for high heat applications Replaces: Pall HC9600FKT16Z, HC9600FUT16Z O.D.: 3 1/8 (79.4) I.D.: 1 11/16 (42.9) One End Height: 16 7/8 (428.6) O-Ring: [1] Attached Related To: H9086 (with Buna N Gasket)</p>
<p>H9083</p> 	<p>Wire Mesh Supported Hydraulic Element Replaces: Pall HC9600FKP16H, HC9600FUP16H O.D.: 3 1/8 (79.4) I.D.: 1 11/16 (42.9) One End Height: 16 7/8 (428.6) I.Gskt: [1] Included</p>	<p>H9092</p>  <p>Wire Mesh Supported Hydraulic Element Contains: Reinforced Centertube Replaces: Pall HC9601FKT8H, HC9601FUT8H O.D.: 3 5/32 (80.2) I.D.: 1 11/16 (42.9) One End Height: 8 1/4 (209.6) I.Gskt: [1] Included</p>
<p>H9084</p> 	<p>Wire Mesh Supported Hydraulic Element Replaces: Pall HC9600FKN16H, HC9600FUN16H O.D.: 3 1/8 (79.4) I.D.: 1 11/16 (42.9) One End Height: 16 7/8 (428.6) I.Gskt: [1] Included</p>	<p>H9093</p>  <p>Wire Mesh Supported Hydraulic Element Contains: Reinforced Centertube Replaces: Pall HC9601FKT13H, HC9601FUT13H O.D.: 3 5/32 (80.2) I.D.: 1 11/16 (42.9) One End Height: 12 29/32 (327.8) I.Gskt: [1] Included</p>



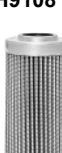







Measurements Are Shown In Inches And (Millimeters)

WARNING: These products can expose you to chemicals, including Diisononyl Phthalate, Carbon black extracts, Nickel, 1,3 Butadiene, Ethylene Oxide, Epichlorohydrin, which are known to the State of California to cause cancer, and Bisphenol, Ethylene Glycol, Ethylene Oxide, 1,3 Butadiene, Epichlorohydrin, which are known to the State of California to cause birth defects or other reproductive harm. For more information go to www.P65Warnings.ca.gov.

<p>H9096</p>  <p>Wire Mesh Supported Hydraulic Element Replaces: Pall HC9650FKN8H, HC9650FUN8H O.D.: 3 1/8 (79.4) I.D.: 1 23/32 (43.7) Height: 8 3/8 (212.7) I.Gskt: [2] Included</p>	<p>H9110</p>  <p>Wire Mesh Supported Hydraulic Element Fits: Renault Engines Replaces: Pall HC9800FKT4H, HC9800FUT4H O.D.: 2 (50.8) I.D.: 15/16 (23.8) One End Height: 4 1/2 (114.3) I.Gskt: [1] Included</p>
<p>H9097</p>  <p>Wire Mesh Supported Hydraulic Element Notes: OBSOLETE. Availability Limited to Dealer Stock. Replaces: Pall HC9650FKS8H, HC9650FUS8H O.D.: 3 1/8 (79.4) I.D.: 1 23/32 (43.7) Height: 8 3/8 (212.7) I.Gskt: [2] Included</p>	<p>H9111</p>  <p>Wire Mesh Supported Hydraulic Element Replaces: Pall HC9800FKP8H, HC9800FUP8H O.D.: 2 (50.8) I.D.: 15/16 (23.8) One End Height: 8 7/32 (208.8) I.Gskt: [1] Included</p>
<p>H9103</p>  <p>Wire Mesh Supported Hydraulic Element Contains: Reinforced Centertube Replaces: Pall HC9651FKP8H, HC9651FUP8H O.D.: 3 5/32 (80.2) I.D.: 1 11/16 (42.9) Height: 8 3/16 (208.0) I.Gskt: [2] Included</p>	<p>H9112</p>  <p>Wire Mesh Supported Hydraulic Element Fits: Massey Ferguson, Renault Tractors Replaces: Pall HC9800FKN8H, HC9800FUN8H O.D.: 2 (50.8) I.D.: 15/16 (23.8) One End Height: 8 7/32 (208.8) I.Gskt: [1] Included</p>
<p>H9107</p>  <p>Wire Mesh Supported Hydraulic Element Replaces: Pall HC9800FKP4H, HC9800FUP4H O.D.: 2 (50.8) I.D.: 15/16 (23.8) One End Height: 4 1/2 (114.3) I.Gskt: [1] Included</p>	<p>H9113</p>  <p>Wire Mesh Supported Hydraulic Element Replaces: Pall HC9800FKS8H, HC9800FUS8H O.D.: 2 (50.8) I.D.: 15/16 (23.8) One End Height: 8 7/32 (208.8) I.Gskt: [1] Included</p>
<p>H9108</p>  <p>Wire Mesh Supported Hydraulic Element Replaces: Pall HC9800FKN4H, HC9800FUN4H O.D.: 2 (50.8) I.D.: 15/16 (23.8) One End Height: 4 1/2 (114.3) I.Gskt: [1] Included</p>	<p>H9114</p>  <p>Wire Mesh Supported Hydraulic Element Replaces: Pall HC9800FKT8H, HC9800FUT8H O.D.: 2 (50.8) I.D.: 15/16 (23.8) One End Height: 8 7/32 (208.8) I.Gskt: [1] Included</p>







Measurements Are Shown In Inches And (Millimeters)

WARNING: These products can expose you to chemicals, including Diisononyl Phthalate, Carbon black extracts, Nickel, 1,3 Butadiene, Ethylene Oxide, Epichlorohydrin, which are known to the State of California to cause cancer, and Bisphenol, Ethylene Glycol, Ethylene Oxide, 1,3 Butadiene, Epichlorohydrin, which are known to the State of California to cause birth defects or other reproductive harm. For more information go to www.P65Warnings.ca.gov.

<p>H9123</p> 	<p>Wire Mesh Supported Hydraulic Element Replaces: Pall HC8800FDN16H, HC8800FKN16H O.D.: 3 13/32 (86.5) I.D.: 1 15/16 (49.2) One End Height: 16 27/32 (427.8) I.Gskt: [1] Included</p>	<p>PT9135</p> 	<p>Hydraulic Element Replaces: Argo P3071301; Fleetguard HF28802; Woodgate WGH1301 O.D.: 2 3/4 (69.9) I.D.: 1 31/32 (50.0) One End Height: 5 9/32 (134.1) O-Ring: [1] Attached, [1] Included</p>
<p>PT9129</p> 	<p>Hydraulic Element with Lift Tab Contains: By-Pass Valve Replaces: Argo K3102652; Woodgate WGH1937 O.D.: 3 29/32 (99.2) Flange 4 1/4 (108.0) I.D.: 13/32 (10.3) & 3/4 (19.0) Height: 10 31/32 (278.6)</p>	<p>PT9136</p> 	<p>Hydraulic Element Contains: By-Pass Valve Replaces: Argo P3061352; Fleetguard HF35194; Woodgate WGH1352 O.D.: 2 1/4 (57.2) I.D.: 1 1/16 (27.0) One End Height: 5 3/8 (136.5) O-Ring: [1] Attached</p>
<p>PT9131</p> 	<p>Hydraulic Element Contains: Spring Locator Fits: Volvo Trucks Replaces: Volvo 15036627; Fleetguard HF6278; Woodgate WGH6278 O.D.: 2 5/16 (58.7) I.D.: 1/2 (12.7) Height: 4 19/32 (116.7) Grommets: [2] Attached</p>	<p>PT9137</p> 	<p>Hydraulic Element Replaces: Orenstein & Koppel 1433860; Woodgate WGH1433 O.D.: 1 25/32 (45.2) I.D.: 15/16 (23.8) One End Height: 4 15/32 (113.5) O-Ring: [1] Attached</p>
<p>PT9132</p> 	<p>Hydraulic Element Replaces: Fairey-Arlon FXX110; Fleetguard HF6273; Woodgate WGF1-10 O.D.: 2 27/32 (72.2) I.D.: 2 1/32 (51.6) Height: 11 27/32 (300.8)</p>	<p>PT9139</p> 	<p>Hydraulic Element Contains: Threaded hex nut for removal. Fits: Kubota Excavators Replaces: Kubota 6948162210; Woodgate WGH1788 Thread: 1 1/2 -BSP-PL O.D.: 3 29/32 (99.2) Height: 5 5/32 (131.0)</p>
<p>PT9134</p> 	<p>Hydraulic Element Replaces: Argo P3051005; Woodgate WGH1005 O.D.: 1 25/32 (45.2) I.D.: 3/4 (19.0) One End Height: 4 1/16 (103.2) O-Ring: [1] Attached</p>	<p>PT9140</p> 	<p>Hydraulic Element Replaces: U.C.C. EIL1115; Woodgate WGH1800 O.D.: 2 11/32 (59.5) I.D.: 13/32 (10.3) & 1 1/2 (38.1) Height: 4 13/16 (122.2)</p>







Measurements Are Shown In Inches And (Millimeters)





WARNING: These products can expose you to chemicals, including Diisononyl Phthalate, Carbon black extracts, Nickel, 1,3 Butadiene, Ethylene Oxide, Epichlorohydrin, which are known to the State of California to cause cancer, and Bisphenol, Ethylene Glycol, Ethylene Oxide, 1,3 Butadiene, Epichlorohydrin, which are known to the State of California to cause birth defects or other reproductive harm. For more information go to www.P65Warnings.ca.gov.

<p>PT9142</p>  <p>Hydraulic Element with Bail Handle Contains: 25 PSID By-Pass Valve Replaces: J.C. Bamford PP1775, PPP17775; MP Filtri MF0301P25N, MF0301P25NB; Woodgate WGH1860 O.D.: 2 1/16 (52.4) I.D.: 31/32 (24.6) One End Height: 2 7/8 (73.0)</p>	<p>PT9149</p>  <p>Hydraulic Element Fits: Komatsu Excavators Replaces: Demag 76184073; Woodgate WGH1958 O.D.: 2 23/32 (69.1) I.D.: 1 9/32 (32.5) One End Height: 4 9/16 (115.9) O-Ring: [1] Attached</p>
<p>PT9143</p>  <p>Hydraulic Element with Bail Handle Contains: By-Pass Valve Replaces: MP Filtri MF0202P10NB; Woodgate WGH1882 O.D.: 1 23/32 (43.7) I.D.: 27/32 (21.4) Height: 6 23/32 (170.7) O-Ring: [1] Attached</p>	<p>PT9150</p>  <p>Wire Mesh Supported Hydraulic Element Replaces: Finn FC1260F025XS; Woodgate WGH1992 O.D.: 2 27/32 (72.2) I.D.: 5/8 (15.9) & 1 3/4 (44.4) Height: 10 7/32 (259.6)</p>
<p>PT9144</p>  <p>Hydraulic Element with Bail Handle Contains: By-Pass Valve Replaces: Schroeder 8Z10; Woodgate WGH1899 O.D.: 3 3/32 (78.6) I.D.: 1 5/8 (41.3) One End Height: 8 1/8 (206.4)</p>	<p>PT9152</p>  <p>Hydraulic Element Replaces: Argo P2092022; Fleetguard HF35266; Woodgate WGH2022 O.D.: 3 9/32 (83.3) I.D.: 1 9/16 (39.7) Height: 7 25/32 (197.6) A. Gskt: [2] Attached</p>
<p>PT9145</p>  <p>Wire Mesh Supported Hydraulic Element Replaces: Finn FFFAVL1102825AB; Woodgate WGH1902 O.D.: 2 27/32 (72.2) I.D.: 11/32 (8.7) & 1 25/32 (45.2) Height: 5 29/32 (150.0)</p>	<p>PT9153</p>  <p>Hydraulic Element Contains: By-Pass Valve Replaces: Argo P3062051; Fleetguard HF28796; Woodgate WGH2051 O.D.: 2 5/16 (58.7) I.D.: 1 1/16 (27.0) Height: 7 27/32 (199.2) O-Ring: [1] Attached</p>
<p>PT9148</p>  <p>Hydraulic Element Fits: Manitou Equipment Replaces: Manitou 46028; Woodgate WGH1934 O.D.: 3 9/16 (90.5) I.D.: 1 5/8 (41.3) One End Height: 11 13/16 (300.0) A. Gskt: [1] Attached</p>	<p>PT9157</p>  <p>Hydraulic Element Contains: By-Pass Valve Replaces: Argo P3072062; Woodgate WGH3062 O.D.: 2 3/4 (69.9) I.D.: 1 1/4 (31.8) One End Height: 7 27/32 (199.2) O-Ring: [1] Attached</p>

Measurements Are Shown In Inches And (Millimeters)

WARNING: These products can expose you to chemicals, including Diisononyl Phthalate, Carbon black extracts, Nickel, 1,3 Butadiene, Ethylene Oxide, Epichlorohydrin, which are known to the State of California to cause cancer, and Bisphenol, Ethylene Glycol, Ethylene Oxide, 1,3 Butadiene, Epichlorohydrin, which are known to the State of California to cause birth defects or other reproductive harm. For more information go to www.P65Warnings.ca.gov.

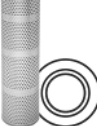
<p>PT9158</p> 	<p>Wire Mesh Hydraulic Element Fits: Vibromax Equipment Replaces: Argo V3072308; Woodgate WGH3308 O.D.: 2 1/2 (63.5) I.D.: 1 1/16 (27.0) Height: 9 3/32 (231.0) O-Ring: [1] Attached</p>
<p>PT9161</p> 	<p>Wire Mesh Supported Hydraulic Element Fits: Bobcat, Komatsu, Krone, Terex Equipment Replaces: Argo V3093308; Fleetguard HF28809; Woodgate WGH3908 O.D.: 3 17/32 (89.7) I.D.: 1 17/32 (38.9) One End Height: 13 3/32 (332.6) O-Ring: [1] Attached</p>
<p>PT9162</p> 	<p>Hydraulic Element Fits: Kato Excavators Replaces: Mitsubishi 68937001001; Fleetguard HF6305; Woodgate WGH6305 O.D.: 4 15/32 (113.5) I.D.: 2 27/32 (72.2) Height: 14 7/8 (377.8) A. Gskt: [2] Attached</p>
<p>BT9164</p> 	<p>Hydraulic Spin-on Fits: Massey Ferguson Tractors Replaces: Massey Ferguson 3581032-M2; Fleetguard HF7541; Woodgate WGH7541 Thread: M42 x 2.0 O.D.: 5 13/32 (137.3) Height: 7 1/8 (181.0) I.Gskt: [1] Included</p>
<p>PT9165</p> 	<p>Hydraulic Element Notes: OBSOLETE. Availability Limited to Dealer Stock. Replaces: Massey Ferguson 2951149-M91; Woodgate WGH7552 O.D.: 2 17/32 (64.3) I.D.: 1 1/16 (27.0) One End Height: 5 13/16 (147.6) O-Ring: [1] Attached</p>
<p>PT9167</p> 	<p>Hydraulic Element with Bail Handle Contains: By-Pass Valve Replaces: MP Filtri MF1002AP25NB; Fleetguard HF7904; Woodgate WGH9100 O.D.: 2 3/4 (69.9) I.D.: 1 3/32 (27.8) One End Height: 5 11/32 (135.7) O-Ring: [1] Attached Spring: [1] Included</p>

<p>PT9168</p> 	<p>Hydraulic Element with Attached Spring Contains: By-Pass Valve Fits: Liebherr Cranes Replaces: Liebherr 510670108; Fleetguard HF7911; Woodgate WGH9101 O.D.: 5 1/8 (130.2) I.D.: 1 15/16 (49.2) One End Height: 8 3/16 (208.0) O-Ring: [1] Included Spring: [1] Attached</p>
<p>PT9169</p> 	<p>Hydraulic Element Fits: Takeuchi Excavators; Yanmar Carriers Replaces: Yanmar 155110-0700; Woodgate WGH9104 O.D.: 4 13/32 (111.9) I.D.: 2 3/4 (69.9) Height: 8 13/16 (223.8) A. Gskt: [2] Attached O-Ring: [1] Included</p>
<p>PT9170</p> 	<p>Hydraulic Element Fits: Link-Belt, Volvo, Yanmar Excavators Replaces: Yanmar 172112-74911; Woodgate WGH9108 O.D.: 4 5/16 (109.5) I.D.: 2 3/4 (69.9) Height: 8 11/16 (220.7)</p>
<p>PT9172</p> 	<p>Hydraulic Element Fits: Hitachi, John Deere, Kubota Excavators, Loaders Replaces: Hitachi 4225846; Woodgate WGH9134 O.D.: 3 17/32 (89.7) I.D.: 1 27/32 (46.8) Height: 14 1/8 (358.8) O-Ring: [2] Attached, [3] Included</p>
<p>PT9174</p> 	<p>Hydraulic Element with Attached Spring Contains: By-Pass Valve Replaces: MP Filtri MF1002AM60NB; Woodgate WGH9146 O.D.: 2 3/4 (69.9) I.D.: 1 3/32 (27.8) One End Height: 5 11/32 (135.7) Spring: [1] Attached</p>

Measurements Are Shown In Inches And (Millimeters)

WARNING: These products can expose you to chemicals, including Diisononyl Phthalate, Carbon black extracts, Nickel, 1,3 Butadiene, Ethylene Oxide, Epichlorohydrin, which are known to the State of California to cause cancer, and Bisphenol, Ethylene Glycol, Ethylene Oxide, 1,3 Butadiene, Epichlorohydrin, which are known to the State of California to cause birth defects or other reproductive harm. For more information go to www.P65Warnings.ca.gov.

PT9175 Hydraulic Element with Bail Handle
Contains: By-Pass Valve
Replaces: J.C. Bamford 32/925100; Fleetguard HF7906, HF35210; Woodgate WGH9147
O.D.: 3 29/32 (99.2)
I.D.: 1 9/16 (39.7) One End
Height: 8 5/8 (219.1)
I.Gskt: [1] Included



PT9181 Hydraulic Element
Contains: By-Pass Valve
Fits: Telesco Pelle Loaders
Replaces: MP Filtri MF1801AP10NB; Fleetguard HF35209; Woodgate WGH9532
O.D.: 3 29/32 (99.2)
I.D.: 1 25/32 (45.2) One End
Height: 8 5/8 (219.1)
O-Ring: [1] Attached



PT9176 Hydraulic Element with Bail Handle
Contains: By-Pass Valve
Fits: Manitou Equipment
Replaces: Komatsu 21D6011130; Fleetguard HF7909, HF35216; Woodgate WGH9150
O.D.: 5 5/32 (131.0)
I.D.: 2 15/32 (62.7) One End
Height: 8 9/32 (210.3)



PT9183 Hydraulic Element with Bail Handle
Contains: By-Pass Valve
Replaces: Liebert 510665208; Woodgate WGH9554
O.D.: 5 11/32 (135.7)
I.D.: 2 9/16 (65.1) One End
Height: 7 7/8 (200.0)
O-Ring: [1] Attached



PT9178 Hydraulic Element with Attached Spring
Notes: OBSOLETE. Availability Limited to Dealer Stock.
Contains: By-Pass Valve
Fits: Manitou Equipment
Replaces: Manitou 23091; Fleetguard HF7984; Woodgate WGH9160
O.D.: 2 3/4 (69.9)
I.D.: 1 5/8 (41.3) One End
Height: 3 31/32 (100.8)
Spring: [1] Attached



PT9185 Hydraulic Element
Replaces: Fairey-Arlon TXX2-10; Fleetguard HF35111; Woodgate WGTX2-10
O.D.: 2 27/32 (72.2)
I.D.: 1 11/32 (8.7) & 1 25/32 (45.2)
Height: 4 5/32 (105.6)
O-Ring: [1] Attached



PT9179 Hydraulic Element with Attached Spring
Contains: By-Pass Valve
Replaces: MP Filtri MF0301AP25NB; Woodgate WGH9500
O.D.: 1 31/32 (50.0)
I.D.: 15/16 (23.8) One End
Height: 3 (76.2)
O-Ring: [1] Attached
Spring: [1] Attached



PT9186 Hydraulic Element
Replaces: Fairey-Arlon TXX310; Fleetguard HF6306; Woodgate WGTX3-10
O.D.: 2 27/32 (72.2)
I.D.: 9/32 (7.1) & 1 3/4 (44.4)
Height: 5 7/8 (149.2)
O-Ring: [1] Attached



PT9180 Hydraulic Element with 2 Bail Handles
Contains: By-Pass Valve
Replaces: MP Filtri MF1001P10NB; Fleetguard HF35201; Woodgate WGH9505
O.D.: 2 3/4 (69.9)
I.D.: 1 3/32 (27.8) One End
Height: 3 5/8 (92.1)
O-Ring: [1] Attached













PT9187 Hydraulic Element
Replaces: J.C. Bamford 581/05702; Fleetguard HF6307; Woodgate WGTX3D-10
O.D.: 2 27/32 (72.2)
I.D.: 5/8 (15.9) & 2 1/16 (52.4)
Height: 7 7/8 (200.0)
O-Ring: [1] Attached













Measurements Are Shown In Inches And (Millimeters)

WARNING: These products can expose you to chemicals, including Diisononyl Phthalate, Carbon black extracts, Nickel, 1,3 Butadiene, Ethylene Oxide, Epichlorohydrin, which are known to the State of California to cause cancer, and Bisphenol, Ethylene Glycol, Ethylene Oxide, 1,3 Butadiene, Epichlorohydrin, which are known to the State of California to cause birth defects or other reproductive harm. For more information go to www.P65Warnings.ca.gov.

<p>PT9188</p> 	<p>Hydraulic Element Replaces: Fairey-Arlon TXX410; Fleetguard HF6308; Woodgate WGTX4-10 O.D.: 4 5/32 (105.6) I.D.: 13/32 (10.3) & 2 27/32 (72.2) Height: 7 9/16 (192.1) O-Ring: [1] Attached</p>	<p>PT9196</p>  <p>Hydraulic Element Notes: Inside-Out Flow Direction Contains: 2 PSID By-Pass Valve Threaded hex nut for removal. Fits: Caterpillar Lift Trucks; Kubota Excavators; Mitsubishi Equipment Replaces: Kubota 6978162120; Fleetguard HF7929; Woodgate WGH1965 Thread: 3/4 NPT O.D.: 3 17/32 (89.7) Height: 6 9/16 (166.7)</p>
<p>PT9189</p> 	<p>Hydraulic Element Notes: Inside-Out Flow Direction Replaces: J.C. Bamford 32/100301; Fleetguard HF6309; Woodgate WGTX5A-10 O.D.: 4 5/32 (105.6) I.D.: 13/32 (10.3) & 2 27/32 (72.2) Height: 18 9/32 (464.3) O-Ring: [1] Attached</p>	<p>PT9197</p>  <p>Hydraulic Element Contains: 22 PSID By-Pass Valve Replaces: Argo P3062052; Fleetguard HF35263; Woodgate WGH2052 O.D.: 2 5/16 (58.7) I.D.: 1 1/32 (26.2) One End Height: 7 7/8 (200.0) O-Ring: [1] Attached</p>
<p>PT9191</p> 	<p>Hydraulic Element Fits: Case, Drott Equipment Replaces: Fairey-Arlon TXX8C10; Fleetguard HF6311; Woodgate WGTX8C-10 O.D.: 4 15/16 (125.4) I.D.: 13/32 (10.3) & 3 5/8 (92.1) Height: 18 13/16 (477.8) O-Ring: [1] Attached</p>	<p>PT9199</p>  <p>Hydraulic Element Replaces: Argo P2093301; Woodgate WGH3301 O.D.: 3 1/2 (88.9) I.D.: 1 31/32 (50.0) Height: 12 29/32 (327.8)</p>
<p>PT9193</p> 	<p>Hydraulic Element Notes: For suction side Contains: Threaded hex nut for removal. Replaces: J.C. Bamford 92/912004; Woodgate WGH1900 Thread: 3/4 -BSP-PL O.D.: 2 3/4 (69.9) Height: 3 3/4 (95.3)</p>	<p>PT9203</p>  <p>Wire Mesh Supported Hydraulic Element Replaces: Parker GO1284; Fleetguard HF7738; Woodgate WGH1983 O.D.: 1 15/32 (37.3) 2 3/8 (60.3) I.D.: 1 (25.4) One End Height: 5 5/16 (134.9) O-Ring: [1] Attached</p>
<p>PT9195</p> 	<p>Hydraulic Element Contains: 22 PSID By-Pass Valve Replaces: Argo P3051051; Fleetguard HF35267; Woodgate WGH1051 O.D.: 1 25/32 (45.2) I.D.: 13/16 (20.6) One End Height: 4 3/32 (104.0) O-Ring: [1] Attached</p>	<p>PT9208</p>  <p>Wire Mesh Supported Hydraulic Element Replaces: MP Filtri HP0371P10AN; Woodgate WGH9410 O.D.: 1 5/8 (41.3) I.D.: 27/32 (21.4) One End Height: 3 17/32 (89.7) O-Ring: [1] Attached</p>











Measurements Are Shown In Inches And (Millimeters)

WARNING: These products can expose you to chemicals, including Diisononyl Phthalate, Carbon black extracts, Nickel, 1,3 Butadiene, Ethylene Oxide, Epichlorohydrin, which are known to the State of California to cause cancer, and Bisphenol, Ethylene Glycol, Ethylene Oxide, 1,3 Butadiene, Epichlorohydrin, which are known to the State of California to cause birth defects or other reproductive harm. For more information go to www.P65Warnings.ca.gov.

<p>PT9209</p>  <p>Hydraulic Element Notes: OBSOLETE. Availability Limited to Dealer Stock. Replaces: MP Filtri HP0371P25; Woodgate WGH9411 O.D.: 1 5/8 (41.3) I.D.: 29/32 (23.0) One End Height: 3 19/32 (91.3) O-Ring: [1] Attached</p>	<p>PT9222</p>  <p>Wire Mesh Hydraulic Element Notes: For suction side Contains: Threaded hex nut for removal. Replaces: U.C.C. UCSE1319; Woodgate WGSE1319 Thread: 1/2 -14 BSP-PL O.D.: 1 13/16 (46.0) Height: 4 5/32 (105.6)</p>
<p>PT9210</p>  <p>Hydraulic Element Replaces: Argo P3052001; Woodgate WGH9434 O.D.: 1 25/32 (45.2) I.D.: 3/4 (19.0) One End Height: 7 27/32 (199.2) O-Ring: [1] Attached</p>	<p>PT9223</p>  <p>Wire Mesh Hydraulic Element Notes: For suction side Contains: Threaded hex nut for removal. Replaces: U.C.C. UCSE1320; Fleetguard HF35159; Woodgate WGSE1320 Thread: 3/4 -14 BSP-PL O.D.: 2 17/32 (64.3) Height: 4 5/16 (109.5)</p>
<p>PT9212</p>  <p>Hydraulic Element Replaces: Putzmeister 222895006; Woodgate WGH1901 O.D.: 4 (101.6) I.D.: 2 7/16 (61.9) Height: 13 3/16 (335.0) O-Ring: [2] Attached</p>	<p>PT9224</p>  <p>Wire Mesh Hydraulic Element Contains: Threaded hex nut for removal. Replaces: U.C.C. UCSE1324; Fleetguard HF6254; Woodgate WGSE1324 Thread: 1 1/2 -11 BSP-PL O.D.: 3 5/16 (84.1) Height: 7 7/8 (200.0)</p>
<p>PT9214</p>  <p>Wire Mesh Hydraulic Element with Bail Handle Replaces: Tamrock 4701416; Woodgate WGH1954 O.D.: 3 5/16 (84.1) I.D.: 9/16 (14.3) Height: 4 23/32 (119.9) F. Gskt: [1] Included, [1] Washer O-Ring: [1] Included Grommets: [2] Attached</p>	<p>PT9225</p>  <p>Wire Mesh Hydraulic Element Contains: Threaded hex nut for removal. Fits: Kubota Excavators Replaces: U.C.C. UCSE1457; Fleetguard HF7444; Woodgate WGSE1457 Thread: 1 -11 BSP-PL O.D.: 2 17/32 (64.3) Height: 5 7/16 (138.1)</p>
<p>PT9215</p>  <p>Wire Mesh Hydraulic Element Fits: Massey Ferguson Wheel Tractors Replaces: Massey Ferguson 1674984M92; Woodgate WGH9139 O.D.: 2 7/8 (73.0) I.D.: 13/32 (10.3) & 1 13/32 (35.7) Height: 6 7/32 (158.0)</p>	<p>PT9227</p>  <p>Wire Mesh Hydraulic Element with Bail Handle Contains: 25 PSID By-Pass Valve Replaces: MP Filtri MF1801AM60NB; Fleetguard HF28869; Woodgate WGH9144 O.D.: 3 29/32 (99.2) I.D.: 1 9/16 (39.7) One End Height: 8 7/8 (225.4) Spring: [1] Included</p>
<p>PT9217</p>  <p>Wire Mesh Hydraulic Element with Attached Spring Contains: 25 PSID By-Pass Valve Replaces: MP Filtri MF4002AM125NB; Woodgate WGH9561 O.D.: 5 1/8 (130.2) I.D.: 2 9/16 (65.1) One End Height: 7 7/8 (200.0) O-Ring: [1] Included Spring: [1] Attached</p>	

Measurements Are Shown In Inches And (Millimeters)

WARNING: These products can expose you to chemicals, including Diisononyl Phthalate, Carbon black extracts, Nickel, 1,3 Butadiene, Ethylene Oxide, Epichlorohydrin, which are known to the State of California to cause cancer, and Bisphenol, Ethylene Glycol, Ethylene Oxide, 1,3 Butadiene, Epichlorohydrin, which are known to the State of California to cause birth defects or other reproductive harm. For more information go to www.P65Warnings.ca.gov.

<p>PT9228</p> 	<p>Wire Mesh Hydraulic Element Notes: OBSOLETE. Availability Limited to Dealer Stock. Replaces: MP Filtri MR1001M90; Woodgate WGST120 O.D.: 2 27/32 (72.2) I.D.: 1 1/32 (8.7) & 1 25/32 (45.2) Height: 2 3/16 (55.6) O-Ring: [1] Attached</p>	<p>PT9240</p> 	<p>Hydraulic Element with Bail Handle Contains: By-Pass Valve Replaces: MP Filtri MF0301AP10NB; Fleetguard HF35199; Woodgate WGH9499 O.D.: 2 1/16 (52.4) I.D.: 29/32 (23.0) One End Height: 2 31/32 (75.4) O-Ring: [1] Attached</p>
<p>H9231</p> 	<p>Wire Mesh Supported Hydraulic Element Contains: Viton O-Ring for high heat applications Replaces: MP Filtri HP0653A06AN; Woodgate WGNP9208Z O.D.: 1 25/32 (45.2) I.D.: 15/16 (23.8) One End Height: 8 7/32 (208.8) O-Ring: [1] Viton Attached</p>	<p>PT9242</p> 	<p>Wire Mesh Supported Hydraulic Element with Bail Handle Contains: By-Pass Valve Replaces: MP Filtri MF1002AM125NB; Woodgate WGH9524 O.D.: 2 3/4 (69.9) I.D.: 1 1/8 (28.6) One End Height: 5 1/8 (130.2) O-Ring: [1] Included Spring: [1] Included</p>
<p>PT9237</p> 	<p>Wire Mesh Supported Hydraulic Element with Bail Handle Contains: By-Pass Valve Replaces: MP Filtri MF1002AP10NB; Woodgate WGH9517 O.D.: 2 3/4 (69.9) I.D.: 1 1/8 (28.6) One End Height: 5 7/32 (132.6) I.Gskt: [1] Included O-Ring: [1] Included</p>	<p>PT9244</p> 	<p>Hydraulic Element Replaces: Finn FC1073F010BS; Woodgate WGH1817 O.D.: 4 5/32 (105.6) I.D.: 1 1/8 (28.6) & 2 27/32 (72.2) Height: 20 1/2 (520.7) O-Ring: [1] Attached</p>
<p>PT9238</p> 	<p>Hydraulic Element Contains: By-Pass Valve Threaded hex nut for removal. Fits: Kubota, Takeuchi Excavators Replaces: Kubota 6865162120; Fleetguard HF28946; Woodgate WGH1982 Thread: 1 NPT O.D.: 3 9/16 (90.5) Height: 7 7/8 (200.0)</p>	<p>PT9245</p> 	<p>Wire Mesh Hydraulic Element Fits: Daewoo, Doosan Excavators, Loaders Replaces: Daewoo 24749016A; Woodgate WGH1864 O.D.: 5 7/8 (149.2) I.D.: 2 15/16 (74.6) One End Height: 6 1/16 (154.0) O-Ring: [1] Attached</p>
<p>PT9239</p> 	<p>Wire Mesh Supported Hydraulic Element with 2 Bail Handles Contains: By-Pass Valve Replaces: MP Filtri MF1001P25NB; Woodgate WGH9507 O.D.: 2 3/4 (69.9) I.D.: 1 3/32 (27.8) One End Height: 3 19/32 (91.3) O-Ring: [1] Attached</p>	<p>PT9247</p> 	<p>Wire Mesh Supported Hydraulic Element Fits: Liebherr Excavators Replaces: Liebherr 7211188; Fleetguard HF6301; Woodgate WGH9130 O.D.: 5 31/32 (151.6) I.D.: 1 25/32 (45.2) & 3 1/2 (88.9) Height: 24 1/2 (622.3) A. Gskt: [2] Attached</p>

Measurements Are Shown In Inches And (Millimeters)

WARNING: These products can expose you to chemicals, including Diisononyl Phthalate, Carbon black extracts, Nickel, 1,3 Butadiene, Ethylene Oxide, Epichlorohydrin, which are known to the State of California to cause cancer, and Bisphenol, Ethylene Glycol, Ethylene Oxide, 1,3 Butadiene, Epichlorohydrin, which are known to the State of California to cause birth defects or other reproductive harm. For more information go to www.P65Warnings.ca.gov.

PT9248 Hydraulic Element
Contains: By-Pass Valve
Fits: Manitou Equipment
Replaces: Manitou 21967; Fleetguard HF7981; Woodgate WGH9159
O.D.: 2 3/4 (69.9)
I.D.: 1 21/32 (42.1) One End
Height: 7 15/16 (201.6)



PT9256-MPG Wire Mesh Supported Hydraulic Element with Attached Spring
Contains: By-Pass Valve
Replaces: MP Filtri MF1002AA25HB; Fleetguard HF35204; Woodgate WGH9522
O.D.: 2 25/32 (70.6)
I.D.: 1 7/32 (31.0) One End
Height: 5 7/32 (132.6)
Spring: [1] Attached



PT9250 Wire Mesh Supported Hydraulic Element with Bail Handle
Contains: By-Pass Valve
Replaces: MP Filtri MF7501AP25NB; Woodgate WGH9590
O.D.: 5 1/8 (130.2)
I.D.: 2 17/32 (64.3) One End
Height: 16 5/32 (410.4)
O-Ring: [1] Included
Spring: [1] Included



PT9258 Hydraulic Element
Fits: Hyundai Excavators
Replaces: Hyundai 31EE01060; Woodgate WGH1808
O.D.: 4 23/32 (119.9)
I.D.: 2 15/16 (74.6)
Height: 8 15/16 (227.0)
A. Gskt: [2] Attached



PT9251 Hydraulic Element
Contains: Threaded hex nut for removal.
Replaces: Woodgate WGSE1371
Thread: 2 1/2 -11 BSP-PL
O.D.: 5 1/8 (130.2)
Height: 11 (279.4)



PT9260 Hydraulic Element
Replaces: Sumitomo CEJ1357; Woodgate WGH1832
O.D.: 3 (76.2)
I.D.: 1 13/16 (46.0)
Height: 5 17/32 (140.5)
O-Ring: [1] Attached



PT9254 Hydraulic Element
Replaces: Fairey-Arlon FXX310; Woodgate WGF3-10
O.D.: 4 31/32 (126.2)
I.D.: 3 5/8 (92.1)
Height: 11 7/16 (290.5)



PT9261-MPG Wire Mesh Supported Hydraulic Element with Bail Handle
Contains: By-Pass Valve
Replaces: MP Filtri MF4003AA10HB; Woodgate WGH9580
O.D.: 5 1/8 (130.2)
I.D.: 2 17/32 (64.3) One End
Height: 10 3/16 (258.8)
O-Ring: [1] Included



PT9255 Wire Mesh Supported Hydraulic Element
Replaces: Liebherr 5106622; Woodgate WGH9855
O.D.: 1 27/32 (46.8)
I.D.: 1 1/32 (26.2) One End
Height: 3 11/16 (93.7)









PT9264 Wire Mesh Supported Hydraulic Element with Bail Handle
Contains: By-Pass Valve
Replaces: MP Filtri MF1003AP10NB; Woodgate WGH1991
O.D.: 2 3/4 (69.9)
I.D.: 1 19/32 (40.5) One End
Height: 8 7/16 (214.3)
O-Ring: [1] Included













Measurements Are Shown In Inches And (Millimeters)

WARNING: These products can expose you to chemicals, including Diisononyl Phthalate, Carbon black extracts, Nickel, 1,3 Butadiene, Ethylene Oxide, Epichlorohydrin, which are known to the State of California to cause cancer, and Bisphenol, Ethylene Glycol, Ethylene Oxide, 1,3 Butadiene, Epichlorohydrin, which are known to the State of California to cause birth defects or other reproductive harm. For more information go to www.P65Warnings.ca.gov.

<p>PT9266</p> 	<p>Hydraulic Element Replaces: Parker GO2836; Woodgate WGH9876 O.D.: 1 27/32 (46.8) I.D.: 1 (25.4) One End Height: 6 25/32 (172.2)</p>	<p>PT9278</p>  <p>Wire Mesh Hydraulic Element Contains: Threaded hex nut for removal. Replaces: U.C.C. UCSE1323 Thread: 1 1/2 -11 BSP-PL O.D.: 3 3/8 (85.7) Height: 5 15/32 (138.9)</p>
<p>PT9267</p> 	<p>Wire Mesh Supported Hydraulic Element Replaces: Stauff SL020D20B; Woodgate WGH9877 O.D.: 1 27/32 (46.8) I.D.: 1 (25.4) One End Height: 6 3/4 (171.5)</p>	<p>PT9279</p>  <p>Wire Mesh Hydraulic Element Notes: For suction side Contains: Threaded hex nut for removal. Replaces: Woodgate WGSE1360 Thread: 1 1/2 -11 BSP-PL O.D.: 3 3/8 (85.7) Height: 7 7/8 (200.0)</p>
<p>PT9268</p> 	<p>Wire Mesh Supported Hydraulic Element with Bail Handle Contains: By-Pass Valve Replaces: Hydac 330R010P; Woodgate WGH33010RP O.D.: 3 23/32 (94.5) I.D.: 1 27/32 (46.8) One End Height: 7 5/8 (193.7) O-Ring: [1] Attached</p>	<p>PT9282-MPG</p>  <p>Wire Mesh Supported Maximum Performance Glass Hydraulic Element Contains: 29 PSID By-Pass Valve Replaces: Internormen 300123VG10; Woodgate WGH1793 O.D.: 2 3/16 (55.6) I.D.: 1 1/16 (27.0) One End Height: 6 27/32 (173.8) O-Ring: [1] Included</p>
<p>PT9272</p> 	<p>Wire Mesh Hydraulic Element with Bail Handle Contains: 24 PSID By-Pass Valve Replaces: MP Filtri MF4002AM60NB; Fleetguard HF28874, HF35217; Woodgate WGH9145 O.D.: 5 1/8 (130.2) I.D.: 2 9/16 (65.1) One End Height: 7 7/8 (200.0) O-Ring: [1] Included</p>	<p>PT9283-MPG</p>  <p>Wire Mesh Supported Maximum Performance Glass Hydraulic Element Fits: Caterpillar Excavators Replaces: Caterpillar 1097287; Woodgate WGH1843 O.D.: 4 21/32 (118.3) I.D.: 2 11/32 (59.5) Height: 23 5/8 (600.1) O-Ring: [2] Attached</p>
<p>PT9277</p> 	<p>Wire Mesh Hydraulic Element Notes: For suction side Contains: Threaded hex nut for removal. Replaces: U.C.C. UCSE1219; Woodgate WGSE1219 Thread: 2 -11 BSP-PL O.D.: 5 29/32 (150.0) Height: 5 15/16 (150.8)</p>	<p>PT9284-MPG</p>  <p>Wire Mesh Supported Maximum Performance Glass Hydraulic Element Notes: OBSOLETE. Availability Limited to Dealer Stock. Replaces: Argo V2092008; Woodgate WGH2008 O.D.: 3 1/4 (82.6) I.D.: 1 19/32 (40.5) Height: 7 25/32 (197.6) A. Gskt: [2] Attached</p>











Measurements Are Shown In Inches And (Millimeters)

WARNING: These products can expose you to chemicals, including Diisononyl Phthalate, Carbon black extracts, Nickel, 1,3 Butadiene, Ethylene Oxide, Epichlorohydrin, which are known to the State of California to cause cancer, and Bisphenol, Ethylene Glycol, Ethylene Oxide, 1,3 Butadiene, Epichlorohydrin, which are known to the State of California to cause birth defects or other reproductive harm. For more information go to www.P65Warnings.ca.gov.

<p>PT9286-MPG Wire Mesh Supported Maximum Performance Glass Hydraulic Element Contains: 36 PSID By-Pass Valve Replaces: Argo V3062058; Woodgate WGH2058 O.D.: 2 5/16 (58.7) I.D.: 1 1/32 (26.2) One End Height: 7 7/8 (200.0) O-Ring: [1] Attached</p> 	<p>PT9293-MPG Wire Mesh Supported Maximum Performance Glass Hydraulic Element Replaces: Parker GO2005; Woodgate WGH9698 O.D.: 2 3/8 (60.3) I.D.: 1 5/32 (29.4) & 1 7/16 (36.5) Height: 5 9/32 (134.1) O-Ring: [2] Attached</p> 
<p>PT9287-MPG Wire Mesh Supported Maximum Performance Glass Hydraulic Element Contains: 36 PSID By-Pass Valve Fits: Thwaites Dump Trucks Replaces: Argo V3052058; Woodgate WGH3557 O.D.: 1 25/32 (45.2) I.D.: 25/32 (19.8) One End Height: 7 13/16 (198.4) O-Ring: [1] Attached</p> 	<p>PT9296-MPG Wire Mesh Supported Maximum Performance Glass Hydraulic Element Replaces: Stauff SL020E10B; Woodgate WGH9880 O.D.: 1 27/32 (46.8) I.D.: 1 (25.4) One End Height: 6 3/4 (171.5)</p> 
<p>PT9288-MPG Wire Mesh Supported Maximum Performance Glass Hydraulic Element Contains: Venturi-Type Cone Fits: Liebherr Equipment Replaces: Liebherr 7360470; Fleetguard HF6247; Woodgate WGH470 O.D.: 3 15/16 (100.0) I.D.: 2 11/32 (59.5) & 2 17/32 (64.3) Height: 18 9/32 (464.3) A. Gskt: [2] Attached</p> 	<p>PT9297-MPG Wire Mesh Supported Maximum Performance Glass Hydraulic Element Replaces: Stauff SL090E10B; Woodgate WGH9961 O.D.: 3 29/32 (99.2) I.D.: 1 5/8 (41.3) One End Height: 9 1/4 (235.0)</p> 
<p>PT9289-MPG Maximum Performance Glass Hydraulic Element with 2 Bail Handles Contains: 24 PSID By-Pass Valve Replaces: MP Filtri MF1001AA25HB; Woodgate WGH9511 O.D.: 2 25/32 (70.6) I.D.: 1 3/32 (27.8) One End Height: 3 1/2 (88.9) O-Ring: [1] Included</p> 	<p>PT9300-MPG Wire Mesh Supported Maximum Performance Glass Hydraulic Element with Bail Handle Contains: 43 PSID By-Pass Valve Replaces: Hydac 240R020BNHC; Woodgate WGHH24020RB O.D.: 2 29/32 (73.8) I.D.: 1 13/32 (35.7) One End Height: 8 (203.2) O-Ring: [1] Attached</p> 
<p>PT9290-MPG Wire Mesh Supported Maximum Performance Glass Hydraulic Element with Bail Handle Contains: 24 PSID By-Pass Valve Fits: Fiat-Allis, Fiat-Hitachi Loaders Replaces: MP Filtri MF4003AA25HB; Woodgate WGH9581 O.D.: 5 1/8 (130.2) I.D.: 2 15/32 (62.7) One End Height: 10 1/4 (260.3) O-Ring: [1] Included</p> 	<p>PT9303-MPG Wire Mesh Supported Maximum Performance Glass Hydraulic Element Replaces: Hydac 660D010BNHC; Woodgate WGHH66010DB O.D.: 3 9/16 (90.5) I.D.: 1 23/32 (43.7) One End Height: 12 15/16 (328.6) O-Ring: [1] Attached</p> 
<p>PT9291-MPG Wire Mesh Supported Maximum Performance Glass Hydraulic Element Replaces: MP Filtri CU250A10NA; Woodgate WGH9633 O.D.: 3 29/32 (99.2) I.D.: 2 1/16 (52.4) Height: 8 5/16 (211.1) O-Ring: [2] Included</p> 	













Measurements Are Shown In Inches And (Millimeters)

WARNING: These products can expose you to chemicals, including Diisononyl Phthalate, Carbon black extracts, Nickel, 1,3 Butadiene, Ethylene Oxide, Epichlorohydrin, which are known to the State of California to cause cancer, and Bisphenol, Ethylene Glycol, Ethylene Oxide, 1,3 Butadiene, Epichlorohydrin, which are known to the State of California to cause birth defects or other reproductive harm. For more information go to www.P65Warnings.ca.gov.

<p>PT9304-MPG</p> 	<p>Wire Mesh Supported Maximum Performance Glass Hydraulic Element</p> <p>Replaces: Genie 60857; Hydac 75D005BNHC; Woodgate WGH75005DB</p> <p>O.D.: 2 7/32 (56.4)</p> <p>I.D.: 15/16 (23.8) One End</p> <p>Height: 6 21/32 (169.1)</p> <p>O-Ring: [1] Attached</p>	<p>PT9310-MPG</p> 	<p>Wire Mesh Supported Maximum Performance Glass Hydraulic Element</p> <p>Replaces: MP Filtri HP0651A25AN; Woodgate WGH9193</p> <p>O.D.: 1 25/32 (45.2)</p> <p>I.D.: 15/16 (23.8) One End</p> <p>Height: 3 13/32 (86.5)</p> <p>O-Ring: [1] Attached</p>
<p>PT9306-MPG</p> 	<p>Wire Mesh Supported Maximum Performance Glass Hydraulic Element</p> <p>Replaces: Fairey-Arlon TXW8CCC25; Fleetguard HF7991; Woodgate WGTW8CCC-25</p> <p>O.D.: 4 31/32 (126.2)</p> <p>I.D.: 13/32 (10.3) & 3 5/8 (92.1)</p> <p>Height: 18 29/32 (480.2)</p> <p>O-Ring: [1] Attached</p>	<p>PT9311-MPG</p> 	<p>Wire Mesh Supported Maximum Performance Glass Hydraulic Element</p> <p>Replaces: MP Filtri HP1351P10AN; Woodgate WGH9250</p> <p>O.D.: 2 3/32 (53.2)</p> <p>I.D.: 1 (25.4) One End</p> <p>Height: 4 11/16 (119.1)</p> <p>O-Ring: [1] Attached</p>
<p>PT9307-MPG</p> 	<p>Wire Mesh Supported Maximum Performance Glass Hydraulic Element</p> <p>Replaces: Demag 76204273; Woodgate WGH1708</p> <p>O.D.: 3 1/16 (77.8)</p> <p>I.D.: 1 9/16 (39.7) One End</p> <p>Height: 6 11/16 (169.9)</p> <p>O-Ring: [1] Attached</p>	<p>PT9313-MPG</p> 	<p>Wire Mesh Supported Maximum Performance Glass Hydraulic Element</p> <p>Replaces: MP Filtri HP3202A25NA; Woodgate WGH9340</p> <p>O.D.: 3 1/16 (77.8)</p> <p>I.D.: 1 9/16 (39.7) One End</p> <p>Height: 9 9/32 (235.7)</p> <p>O-Ring: [1] Attached</p>
<p>PT9308-MPG</p> 	<p>Wire Mesh Supported Maximum Performance Glass Hydraulic Element</p> <p>Fits: Daewoo Loaders; New Holland Equipment</p> <p>Replaces: Volvo 3114655; Fleetguard HF7658; Woodgate WGH1810</p> <p>O.D.: 2 7/32 (56.4)</p> <p>I.D.: 15/16 (23.8) One End</p> <p>Height: 4 1/8 (104.8)</p> <p>O-Ring: [1] Attached</p>	<p>PT9315 KIT</p> 	<p>Set of 2 Hydraulic Elements</p> <p>Contains: By-Pass Valve</p> <p>Replaces: Palfinger EA1412; Woodgate WGH1783</p> <p>Larger Element</p> <p>O.D.: 2 3/4 (69.9)</p> <p>Height: 5 11/32 (135.7)</p> <p>O-Ring: [1] Included</p> <p>Spring: [1] Included</p> <p>Smaller Element</p> <p>O.D.: 1 5/8</p> <p>Height: 1 11/32</p>
<p>PT9309-MPG</p> 	<p>Wire Mesh Supported Maximum Performance Glass Hydraulic Element</p> <p>Fits: Massey Ferguson Equipment</p> <p>Replaces: Massey Ferguson 3104387M1; Woodgate WGH1994</p> <p>O.D.: 2 3/8 (60.3)</p> <p>I.D.: 1 1/32 (26.2) One End</p> <p>Height: 5 5/16 (134.9)</p> <p>O-Ring: [1] Attached</p>	<p>BT9316-MPG</p> 	<p>Maximum Performance Glass Hydraulic Spin-on</p> <p>Replaces: MP Filtri CS70A10; Woodgate WGH9171</p> <p>Thread: 3/4 -14 BSP-PL</p> <p>O.D.: 3 25/32 (96.0)</p> <p>Height: 7 19/32 (192.9)</p> <p>I.Gskt: [1] Included</p>



Measurements Are Shown In Inches And (Millimeters)

WARNING: These products can expose you to chemicals, including Diisononyl Phthalate, Carbon black extracts, Nickel, 1,3 Butadiene, Ethylene Oxide, Epichlorohydrin, which are known to the State of California to cause cancer, and Bisphenol, Ethylene Glycol, Ethylene Oxide, 1,3 Butadiene, Epichlorohydrin, which are known to the State of California to cause birth defects or other reproductive harm. For more information go to www.P65Warnings.ca.gov.

<p>BT9318 Hydraulic Spin-on Contains: Anti-Drainback Valve 29 PSID By-Pass Valve Fits: Scania Trucks Replaces: Scania 1301696; Fleetguard HF7535; Woodgate WGH7535 Thread: M23 x 1.5 O.D.: 3 13/16 (96.8) Height: 4 5/16 (109.5) I.Gskt: G381-A</p> 	<p>PT9328-MPG Maximum Performance Glass Hydraulic Element Fits: Liebherr R984 Li Excavator Replaces: Liebherr 7366869; Fleetguard HF28848; Woodgate WGH1921 O.D.: 5 31/32 (151.6) I.D.: 1 5/8 (41.3) & 3 7/16 (87.3) Height: 32 11/16 (830.3) A. Gskt: [2] Attached</p> 
<p>BT9320 Wire Mesh Supported Hydraulic Spin-on with Removal Nut Contains: 14 PSID By-Pass Valve Replaces: CompAir 9826279; Fleetguard HF6329; Woodgate WGH6329 Thread: 1 1/2 -11 BSP-PL O.D.: 4 15/16 (125.4) Height: 7 17/32 (191.3) F. Gskt: [1] Included</p> 	<p>PT9329 Hydraulic Element with Attached Spring Fits: Renault Tractors Replaces: Renault 7701015558; Fleetguard HF6186 O.D.: 2 3/4 (69.9) I.D.: 1 (25.4) One End Height: 5 1/2 (139.7) O-Ring: [1] Included Spring: [1] Attached</p> 
<p>BT9321 Hydraulic Spin-on Fits: Kobelco Excavators; Kubota Equipment Replaces: Kobelco S15510-35110; Yanmar 155103-5110; 172179-7372 Thread: 1 1/8 -16 O.D.: 3 23/32 (94.5) Height: 6 13/16 (173.0) I.Gskt: [1] Included</p> 	<p>PT9330-MPG Wire Mesh Supported Maximum Performance Glass Hydraulic Element Fits: Bomag Paving Equipment; JLG Equipment Replaces: Hydac 110D010BNHC; Woodgate WGH11010DB O.D.: 1 7/8 (47.6) I.D.: 13/16 (20.6) One End Height: 6 1/32 (153.2) O-Ring: [1] Attached</p> 
<p>BT9324 Stainless Steel Mesh Hydraulic Spin-on Replaces: MP Filtri CS100M60; Woodgate WGH9178 Thread: 1 1/4 -11 BSP-PL O.D.: 5 1/32 (127.8) Height: 7 7/32 (183.4) I.Gskt: [1] Included</p> 	<p>PT9331 Hydraulic Element Contains: Threaded hex nut for removal. Replaces: U.C.C. UCSE1326; Woodgate WGSE1326 Thread: 2 -11 BSP-PL O.D.: 3 5/16 (84.1) Height: 10 7/32 (259.6)</p> 
<p>BT9326 Air Breather Spin-on Replaces: Woodgate WGUC4930 Thread: 3/4 -14 BSP-PL O.D.: 3 3/4 (95.3) Height: 2 5/16 (58.7) I.Gskt: [1] Included</p> 	<p>PT9337-MPG Wire Mesh Supported Maximum Performance Glass Hydraulic Element Fits: Liebherr Equipment Replaces: Caterpillar 109-7293; Liebherr 7362910; Donaldson P173188; Fleetguard HF7834 O.D.: 1 3/8 (34.9) I.D.: 1/2 (12.7) One End Height: 3 11/16 (93.7) O-Ring: [1] Attached</p> 
<p>H9327 Wire Mesh Supported Hydraulic Element Fits: Massey Ferguson Tractors Replaces: Massey Ferguson 3619594-M1; Fleetguard HF28811 O.D.: 2 (50.8) I.D.: 15/16 (23.8) One End Height: 6 5/16 (160.3) O-Ring: [1] Attached</p> 	<p>PT9338-MPG Wire Mesh Supported Maximum Performance Glass Hydraulic Element Fits: John Deere Equipment Replaces: John Deere AT162766; Fleetguard HF7989 O.D.: 5 29/32 (150.0) I.D.: 4 11/32 (110.3) Height: 17 23/32 (450.1) A. Gskt: [2] Attached O-Ring: [1] Included</p> 

Measurements Are Shown In Inches And (Millimeters)

WARNING: These products can expose you to chemicals, including Diisononyl Phthalate, Carbon black extracts, Nickel, 1,3 Butadiene, Ethylene Oxide, Epichlorohydrin, which are known to the State of California to cause cancer, and Bisphenol, Ethylene Glycol, Ethylene Oxide, 1,3 Butadiene, Epichlorohydrin, which are known to the State of California to cause birth defects or other reproductive harm. For more information go to www.P65Warnings.ca.gov.

<p>PT9340-MPG</p> 	<p>Wire Mesh Supported Maximum Performance Glass Hydraulic Element</p> <p>Notes: Inside-Out Flow Direction</p> <p>Fits: Bomag Compactors; Case Excavators; Versatile Tractors</p> <p>Replaces: Donaldson P164699; Fleetguard HF35021</p> <p>O.D.: 4 3/8 (111.1)</p> <p>I.D.: 3/4 (19.0) & 2 7/16 (61.9)</p> <p>Height: 16 1/32 (407.2)</p> <p>A. Gskt: [1] Attached</p> <p>Grommets: [1] Attached</p>	<p>BT9345</p>  <p>Hydraulic Spin-on</p> <p>Fits: Ransomes Jacobsen HR6010 Mower</p> <p>Replaces: Ransomes Jacobsen 178025</p> <p>Thread: 1 1/2 -16</p> <p>O.D.: 5 1/16 (128.6)</p> <p>Height: 10 3/4 (273.1)</p> <p>I.Gskt: G369-B</p>
<p>PT9341</p> 	<p>Hydraulic Element with Attached Spring</p> <p>Fits: Daewoo Equipment</p> <p>Replaces: Daewoo 65-05504-5021</p> <p>O.D.: 4 11/32 (110.3)</p> <p>I.D.: 2 3/16 (55.6) One End</p> <p>Height: 11 1/8 (282.6)</p> <p>A. Gskt: [1] Attached</p> <p>O-Ring: [2] Included</p>	<p>BT9346-MPG</p>  <p>Wire Mesh Supported Maximum Performance Glass Hydraulic Spin-on</p> <p>Contains: 15 PSID By-Pass Valve</p> <p>Fits: John Deere Tractors</p> <p>Replaces: John Deere RE27284</p> <p>Thread: 1 1/2 -16</p> <p>O.D.: 3 11/16 (93.7)</p> <p>Height: 5 9/16 (141.3)</p> <p>I.Gskt: [1] Included</p>
<p>PT9342-MPG</p> 	<p>Wire Mesh Supported Maximum Performance Glass Hydraulic Element</p> <p>Fits: Skytrak Telehandlers</p> <p>Replaces: Koehring 8320265; Parker 932000</p> <p>O.D.: 3 11/16 (93.7)</p> <p>I.D.: 1 19/32 (40.5)</p> <p>Height: 8 1/4 (209.6)</p> <p>Grommets: [2] Attached</p>	<p>BT9347-MPG</p>  <p>Maximum Performance Glass Hydraulic Spin-on</p> <p>Fits: Hitachi, John Deere Loaders</p> <p>Replaces: John Deere AT189924, AT195915, AT228474, AT310905</p> <p>Thread: M90 x 2.0</p> <p>O.D.: 4 23/32 (119.9)</p> <p>Height: 11 23/32 (297.7)</p> <p>I.Gskt: [1] Included</p>
<p>BT9343-MPG</p> 	<p>Maximum Performance Glass Hydraulic Spin-on</p> <p>Fits: John Deere Motor Graders</p> <p>Replaces: John Deere AT193883; Fleetguard HF6840</p> <p>Thread: 1 1/2 -16</p> <p>O.D.: 4 13/16 (122.2)</p> <p>Height: 7 15/32 (189.7)</p> <p>I.Gskt: [1] Included</p>	<p>PT9348-MPG</p>  <p>Wire Mesh Supported Maximum Performance Glass Hydraulic Element with Handle</p> <p>Contains: 25 PSID By-Pass Valve Bleed Hole Reinforced Centertube</p> <p>Fits: Hitachi Excavators</p> <p>Replaces: Hitachi 4448160, 4450003</p> <p>O.D.: 6 1/8 (155.6)</p> <p>I.D.: 3 15/16 (100.0) One End</p> <p>Height: 18 5/32 (461.2)</p> <p>I.Gskt: [1] Included</p> <p>A. Gskt: [1] Attached</p> <p>O-Ring: [1] Included</p>
<p>PT9344</p> 	<p>Hydraulic Element</p> <p>Notes: Inside-Out Flow Direction</p> <p>Replaces: Gillig 5322412002; Fleetguard HF8140</p> <p>O.D.: 4 (101.6)</p> <p>I.D.: 1 3/32 (27.8) & 1 15/32 (37.3)</p> <p>Height: 5 7/32 (132.6)</p> <p>A. Gskt: [2] Attached</p>	<p>BT9349-MPG</p>  <p>Maximum Performance Glass Hydraulic Spin-on</p> <p>Fits: Caterpillar Equipment</p> <p>Replaces: Caterpillar 184-3931; Donaldson P170310</p> <p>Thread: 2 -12</p> <p>O.D.: 3 1/8 (79.4)</p> <p>Height: 5 17/32 (140.5)</p>

Measurements Are Shown In Inches And (Millimeters)

WARNING: These products can expose you to chemicals, including Diisononyl Phthalate, Carbon black extracts, Nickel, 1,3 Butadiene, Ethylene Oxide, Epichlorohydrin, which are known to the State of California to cause cancer, and Bisphenol, Ethylene Glycol, Ethylene Oxide, 1,3 Butadiene, Epichlorohydrin, which are known to the State of California to cause birth defects or other reproductive harm. For more information go to www.P65Warnings.ca.gov.

PT9350-MPG Wire Mesh Supported Maximum Performance Glass Hydraulic Element
Replaces: O&K 1717467; Donaldson P173081; Fleetguard HF7833; Woodgate WGH4060
O.D.: 6 (152.4)
I.D.: 3 15/16 (100.0) One End
Height: 25 1/2 (647.7)



BT9356 Hydraulic Spin-on
Fits: Case-International, New Holland Equipment
Replaces: New Holland 86632018, 87027973
Thread: 1 1/2 -16
O.D.: 5 1/16 (128.6)
Height: 6 31/32 (177.0)
F. Gskt: G369-B
O. Gskt: G286-C, G369-V, G372, G447, G483, G704, G710



PT9351-MPG Wire Mesh Supported Maximum Performance Glass Hydraulic Element
Fits: Komatsu Equipment
Replaces: Komatsu 207-607-1180
O.D.: 5 15/16 (150.8)
I.D.: 3 19/32 (91.3)
Height: 7 7/8 (200.0)
Related To: PT9399-MPG (Long Version)



PT9357 Hydraulic Element
Fits: Volvo Excavators
Replaces: Volvo 14509379
O.D.: 5 29/32 (150.0)
I.D.: 4 11/32 (110.3)
Height: 17 23/32 (450.1)
O-Ring: [1] Included



PT9352 Wire Mesh Hydraulic Element
Notes: Has M10 x 1.5 threaded bushing in closed end.
Fits: Fiat-Hitachi, Hitachi Equipment
Replaces: Hitachi 4210224, 4385915; John Deere TH110133
O.D.: 5 29/32 (150.0)
I.D.: 3 13/32 (86.5) One End
Height: 5 5/16 (134.9)
O-Ring: [1] Attached



BT9358 Transmission Spin-on
Contains: Reinforced Centertube
Fits: Kubota Equipment
Replaces: Kubota TA240-59900, TA240-59901
Thread: 1 1/8 -16
O.D.: 3 25/32 (96.0)
Height: 6 15/32 (164.3)
I.Gskt: [1] Included



BT9353-MPG Maximum Performance Glass Hydraulic Spin-on
Fits: Caterpillar, John Deere Equipment
Use With: OB8771, OB8772, OB8773 filter bases.
Replaces: Caterpillar 225-4118
Thread: 1 3/4 -12
O.D.: 4 23/32 (119.9)
Height: 11 17/32 (292.9)
I.Gskt: [1] Included



PT9359-MPG Wire Mesh Supported Maximum Performance Glass Hydraulic Element with Bail Handle
Contains: 43.5 PSID By-Pass Valve
Replaces: McNeilus 1137725; Schroeder SBF0500RZ10B; Donaldson P173173
O.D.: 3 23/32 (94.5)
I.D.: 1 29/32 (48.4) One End
Height: 10 7/8 (276.2)
O-Ring: [1] Attached



PT9354-MPG Wire Mesh Supported Maximum Performance Glass Hydraulic Element
Fits: Freightliner, International, Kenworth, Mack, Peterbilt, Sterling Trucks
Replaces: International 1698964-C92; Nelson 87904M
O.D.: 3 3/8 (85.7)
I.D.: 1 1/8 (28.6)
Height: 2 23/32 (69.1)
Grommets: [2] Attached



BT9360 Hydraulic Spin-on
Fits: Komatsu Equipment
Replaces: Komatsu 4196-03-5152
Thread: M120 x 2.0
O.D.: 5 3/32 (129.4)
Height: 11 (279.4)
A. Gskt: [1] Attached
O-Ring: [1] Included













PT9355-MPG 2-Section Maximum Performance Glass Hydraulic Element with Bail Handle
Contains: Strainer Basket
Fits: Liebherr Excavators
Replaces: Liebherr 7373878; Fleetguard HF35109
O.D.: 6 1/8 (155.6)
I.D.: 3 5/32 (80.2) & 3 15/16 (100.0)
Height: 20 1/2 (520.7)
I.Gskt: [2] Included













Measurements Are Shown In Inches And (Millimeters)

WARNING: These products can expose you to chemicals, including Diisononyl Phthalate, Carbon black extracts, Nickel, 1,3 Butadiene, Ethylene Oxide, Epichlorohydrin, which are known to the State of California to cause cancer, and Bisphenol, Ethylene Glycol, Ethylene Oxide, 1,3 Butadiene, Epichlorohydrin, which are known to the State of California to cause birth defects or other reproductive harm. For more information go to www.P65Warnings.ca.gov.

<p>PT9361</p>  <p>Hydraulic Element Notes: Inside-Out Flow Direction Replaces: Zinga WE51810; Donaldson P550582 O.D.: 5 7/32 (132.6) I.D.: 3 3/8 (85.7) Height: 18 7/16 (468.3) Grommets: [2] Attached</p>	<p>BT9366-MPG</p>  <p>Maximum Performance Glass Hydraulic Spin-on Fits: Caterpillar Equipment, Trucks Replaces: Caterpillar 156-0214 Thread: 1 3/8 -12 O.D.: 3 11/16 (93.7) Height: 9 19/32 (243.7) I.Gskt: [1] Viton</p>
<p>BT9362-MPG</p>  <p>Maximum Performance Glass Hydraulic Spin-on Fits: Case, New Holland Dozers; Case-International Combines, Tractors Use With: OB8711, OB8712, OB8720, OB8721, OB8722, OB8724, OB8731, OB8732, OB8741, OB8742, OB8743, OB8744, OB8745, OB8746 filter bases. Replaces: Case 254353A1 Thread: 1 3/8 -12 O.D.: 4 23/32 (119.9) Height: 11 17/32 (292.9) O-Ring: [1] Included</p>	<p>BT9367-MPG</p>  <p>Maximum Performance Glass Hydraulic Spin-on Fits: John Deere Equipment Replaces: John Deere AT308274; Fleetguard HF29033 Thread: M90 x 2.0 O.D.: 4 23/32 (119.9) Height: 11 29/32 (302.4) I.Gskt: [1] Included</p>
<p>BT9363-MPG</p>  <p>Maximum Performance Glass Hydraulic Spin-on Fits: Volvo Excavators Use With: OB8711, OB8712, OB8720, OB8721, OB8722, OB8724, OB8731, OB8732, OB8741, OB8742, OB8743, OB8744, OB8745, OB8746 filter bases. Replaces: Volvo 11802677 Thread: 1 3/8 -12 O.D.: 3 3/4 (95.3) Height: 9 19/32 (243.7) O-Ring: [1] Included</p>	<p>BT9368-MPG</p>  <p>Maximum Performance Glass Hydraulic Spin-on Fits: John Deere Motor Graders, Skidders Replaces: John Deere AT306605 Thread: M72 x 2.0 O.D.: 3 7/8 (98.4) Height: 9 3/16 (233.4) I.Gskt: [1] Included</p>
<p>BT9364</p>  <p>Hydraulic Spin-on Contains: 50 PSID By-Pass Valve By-Pass Screen Fits: Bobcat Loaders with Kubota Engine Use With: OB8711, OB8712, OB8720, OB8721, OB8722, OB8724, OB8731, OB8732, OB8741, OB8742, OB8743, OB8744, OB8745, OB8746 filter bases. Replaces: Melroe-Bobcat 6677652 Thread: 1 3/8 -12 O.D.: 3 3/4 (95.3) Height: 6 1/8 (155.6) O-Ring: [1] Included</p>	<p>BT9369-MPG</p>  <p>Maximum Performance Glass Hydraulic Spin-on Fits: John Deere Motor Graders Replaces: John Deere AT305049; Fleetguard HF29035 Thread: M90 x 2.0 O.D.: 4 23/32 (119.9) Height: 8 29/32 (226.2) I.Gskt: [1] Included</p>
<p>BT9365-MPG</p>  <p>Maximum Performance Glass Hydraulic Spin-on Fits: Caterpillar Equipment Use With: OB8771, OB8772, OB8773 filter bases. Replaces: Caterpillar 134-3014 Thread: 1 3/4 -12 O.D.: 4 23/32 (119.9) Height: 11 1/2 (292.1) I.Gskt: [1] Included</p>	<p>BT9370-MPG</p>  <p>Maximum Performance Glass Hydraulic Spin-on Notes: Rated 1000 PSI minimum burst. Dome end accepts 1/2 In. socket driver. Fits: John Deere Mowers, Tractors Use With: OB8711, OB8712, OB8720, OB8721, OB8722, OB8724, OB8726, OB8731, OB8732, OB8740, OB8741, OB8742, OB8743, OB8744, OB8745, OB8746 filter bases. Replaces: John Deere RE205726 Thread: 1 3/8 -12 O.D.: 3 3/4 (95.3) Height: 9 27/32 (250.0) I.Gskt: [1] Included</p>

Measurements Are Shown In Inches And (Millimeters)

WARNING: These products can expose you to chemicals, including Diisononyl Phthalate, Carbon black extracts, Nickel, 1,3 Butadiene, Ethylene Oxide, Epichlorohydrin, which are known to the State of California to cause cancer, and Bisphenol, Ethylene Glycol, Ethylene Oxide, 1,3 Butadiene, Epichlorohydrin, which are known to the State of California to cause birth defects or other reproductive harm. For more information go to www.P65Warnings.ca.gov.

<p>BT9371-MPG Maximum Performance Glass Hydraulic Spin-on</p>  <p>Notes: Can be used with OB1313, OB1314, OB1315, OB1316 bases (requires optional G286-C gasket). Fits: Caterpillar, Ditch Witch Equipment; Caterpillar Off-Highway Trucks Replaces: Caterpillar 144-0832; Donaldson P167162; Fleetguard HF6777 Thread: 1 1/2 -16 O.D.: 5 1/16 (128.6) Height: 6 31/32 (177.0) F. Gskt: G447</p>	<p>PT9376 Hydraulic Element</p>  <p>Fits: John Deere Excavators, Loaders Replaces: Hitachi 4129280; John Deere AT308568 O.D.: 3 1/2 (88.9) I.D.: 1 7/8 (47.6) Height: 14 3/16 (360.4) O-Ring: [2] Included Grommets: [2] Attached</p>
<p>PT9372 Wire Supported Hydraulic Element with Bail Handle</p>  <p>Contains: 14.5 PSID By-Pass Valve Fits: Volvo Excavators Replaces: Volvo 14375005 O.D.: 2 3/8 (60.3) I.D.: 25/32 (19.8) One End Height: 9 (228.6) O-Ring: [1] Attached Spring: [1] Included</p>	<p>PT9377 Hydraulic Spin-on</p>  <p>Fits: Komatsu Dozers, Excavators Replaces: Komatsu 21N-60-12210; Fleetguard HF28894 Thread: M48 x 2.0 O.D.: 5 9/32 (134.1) Height: 11 15/32 (291.3) I.Gskt: [1] Included</p>
<p>PT9373-MPG Wire Mesh Supported Maximum Performance Glass Hydraulic Element</p>  <p>Contains: 30 PSID By-Pass Valve Fits: Bobcat Excavators; Terex Equipment Replaces: Melroe-Bobcat 5380658088 O.D.: 3 9/32 (83.3) I.D.: 1 3/4 (44.4) One End Height: 12 5/16 (312.7) O-Ring: [1] Included</p>	<p>PT9378-MPG Wire Mesh Supported Maximum Performance Glass Hydraulic Element</p>  <p>Fits: Ransomes Jacobsen HR6010 Mower Replaces: Ransomes Jacobsen 8089620; Woodgate WGH1774 O.D.: 2 3/32 (53.2) I.D.: 1 3/32 (27.8) Height: 6 3/32 (154.8) O-Ring: [1] Attached</p>
<p>PT9374 Hydraulic Element</p>  <p>Fits: Scania Trucks Replaces: Scania 1329876, 1381235; Donaldson P550220 O.D.: 3 7/16 (87.3) I.D.: 23/32 (18.3) One End Height: 4 3/16 (106.4) Grommets: [1] Attached</p>	<p>PT9379 Hydraulic Element</p>  <p>Fits: Komatsu Equipment Replaces: Komatsu 7063-51-383 O.D.: 7 (177.8) I.D.: 4 5/16 (109.5) Height: 17 3/4 (450.9) O-Ring: [1] Included</p>
<p>PT9375 Hydraulic Element</p>  <p>Fits: Hyundai Excavators Replaces: Hyundai 31E-34527 O.D.: 5 29/32 (150.0) I.D.: 3 5/16 (84.1) Height: 11 13/16 (300.0) A. Gskt: [2] Attached</p>	<p>PT9380-MPG Wire Mesh Supported Maximum Performance Glass Hydraulic Element</p>  <p>Fits: Caterpillar Equipment Replaces: Caterpillar 139-1537 O.D.: 5 1/8 (130.2) I.D.: 3 3/8 (85.7) Height: 6 31/32 (177.0) A. Gskt: [2] Attached</p>

Measurements Are Shown In Inches And (Millimeters)

WARNING: These products can expose you to chemicals, including Diisononyl Phthalate, Carbon black extracts, Nickel, 1,3 Butadiene, Ethylene Oxide, Epichlorohydrin, which are known to the State of California to cause cancer, and Bisphenol, Ethylene Glycol, Ethylene Oxide, 1,3 Butadiene, Epichlorohydrin, which are known to the State of California to cause birth defects or other reproductive harm. For more information go to www.P65Warnings.ca.gov.

<p>PT9381-MPG Wire Supported Maximum Performance Glass Hydraulic Element with Bail Handle</p>  <p>Fits: Volvo Loaders Replaces: Volvo 2906601, ZM2906601 O.D.: 3 1/16 (77.8) I.D.: 1 23/32 (43.7) One End Height: 12 5/16 (312.7) O-Ring: [1] Attached</p>	<p>BT9387 Hydraulic Spin-on</p>  <p>Contains: 10 PSID By-Pass Valve By-Pass Screen Fits: Massey Ferguson Tractors Replaces: AGCO 3383386M92; Massey Ferguson 3383386-M92; Fleetguard HF7950 Thread: M42 x 2.0 O.D.: 5 3/8 (136.5) Height: 8 5/8 (219.1) I.Gskt: [1] Included</p>
<p>BT9382 Hydraulic Spin-on</p>  <p>Contains: Hex nut for easy removal Fits: Hitachi Excavators Replaces: Hitachi 4252563; John Deere 4252563; Donaldson P550542; Fleetguard HF7553 Thread: 1 1/8 -16 O.D.: 3 11/16 (93.7) Height: 5 7/8 (149.2) I.Gskt: G381-A</p>	<p>BT9388 Power Steering Spin-on</p>  <p>Contains: 20 PSID By-Pass Valve Fits: International Thomas, Buses; Ford, Freightliner, International, Sterling, Western Star Trucks Replaces: Ford F8HZ-3C602-AA; Freightliner T1808D, VMLT1808D; International 2503221-C1 Thread: 3/4 -16 O.D.: 2 21/32 (67.5) Height: 3 1/2 (88.9) I.Gskt: [1] Included</p>
<p>PT9383-MPG Maximum Performance Glass Hydraulic Element with Spring and Bail Handle</p>  <p>Contains: 65 PSID By-Pass Valve Fits: Volvo Excavators Replaces: Volvo 14375006 O.D.: 4 1/2 (114.3) I.D.: 2 1/2 (63.5) One End Height: 16 7/32 (412.0) Spring: [1] Included</p>	<p>PT9389-MPG Wire Mesh Supported Maximum Performance Glass Hydraulic Element</p>  <p>Fits: John Deere Motor Graders Replaces: John Deere AT181127; Fleetguard HF28999 O.D.: 2 7/8 (73.0) I.D.: 1 15/32 (37.3) One End Height: 9 17/32 (242.1) O-Ring: [1] Attached</p>
<p>PT9384-MPG Wire Supported Maximum Performance Glass Hydraulic Element</p>  <p>Contains: 20 PSID By-Pass Valve Fits: Volvo Loaders Replaces: Volvo 2289977; Fleetguard HF28816 O.D.: 2 3/4 (69.9) I.D.: 1 5/8 (41.3) One End Height: 8 7/8 (225.4) O-Ring: [1] Included Grommets: [1] Attached</p>	<p>PT9390-MPG Wire Mesh Supported Maximum Performance Glass Hydraulic Element with Bail Handle</p>  <p>Contains: 43.5 PSID By-Pass Valve Fits: Caterpillar Equipment Replaces: Caterpillar 143-2849; Fleetguard ST1264 O.D.: 3 23/32 (94.5) I.D.: 1 13/16 (46.0) One End Height: 7 5/8 (193.7)</p>
<p>PT9385-MPG Maximum Performance Glass Hydraulic Element</p>  <p>Replaces: Ingersoll-Rand 52263209; Donaldson P161571; Fleetguard HF6297 O.D.: 4 3/8 (111.1) I.D.: 23/32 (18.3) & 2 13/32 (61.1) Height: 16 1/16 (408.0) A. Gskt: [1] Attached Grommets: [1] Attached</p>	<p>BT9391-MPG Maximum Performance Glass Hydraulic Spin-on</p>  <p>Fits: Case-International, New Holland Tractors Replaces: New Holland 86018758 Thread: 1 3/8 -12 O.D.: 4 23/32 (119.9) Height: 11 17/32 (292.9) I.Gskt: [1] Included</p>
<p>PT9386-MPG Wire Supported Maximum Performance Glass Hydraulic Element</p>  <p>Notes: Inside-Out Flow Direction Fits: Freightliner, Kenworth, Peterbilt Trucks Replaces: Nelson 87972A O.D.: 5 (127.0) I.D.: 7/8 (22.2) & 1 7/16 (36.5) Height: 4 1/16 (103.2) A. Gskt: [2] Attached</p>	

Measurements Are Shown In Inches And (Millimeters)

WARNING: These products can expose you to chemicals, including Diisononyl Phthalate, Carbon black extracts, Nickel, 1,3 Butadiene, Ethylene Oxide, Epichlorohydrin, which are known to the State of California to cause cancer, and Bisphenol, Ethylene Glycol, Ethylene Oxide, 1,3 Butadiene, Epichlorohydrin, which are known to the State of California to cause birth defects or other reproductive harm. For more information go to www.P65Warnings.ca.gov.

BT9392-MPG Maximum Performance Glass Hydraulic Spin-on
Fits: Caterpillar Equipment, Off-Highway Trucks
Replaces: Caterpillar 126-1814; Donaldson P170309; Wix 57397
Thread: 2 -12
O.D.: 3 1/8 (79.4)
Height: 9 17/32 (242.1)
I.Gskt: [2] Included



PT9397-MPG Wire Mesh Supported Maximum Performance Glass Hydraulic Element
Fits: Barber-Greene, Caterpillar Paving Equipment
Replaces: Caterpillar 77-5479
O.D.: 3 29/32 (99.2)
I.D.: 1 5/8 (41.3)
Height: 9 9/32 (235.7)
Grommets: [2] Attached



BT9393-MPG Maximum Performance Glass Hydraulic Spin-on
Fits: Caterpillar Equipment, Off-Highway Trucks
Replaces: Caterpillar 126-1813; Donaldson P170308
Thread: 2 -12
O.D.: 3 1/8 (79.4)
Height: 5 17/32 (140.5)
I.Gskt: [1] Included



BT9398-MPG Maximum Performance Glass Hydraulic/Transmission Spin-on
Fits: John Deere Tractors
Replaces: John Deere AL156624, RE55801; Donaldson P178619; Fleetguard HF35339
Thread: 1 3/8 -12
O.D.: 3 3/4 (95.3)
Height: 4 25/32 (121.4)
I.Gskt: [1] Included



PT9394-MPG Wire Supported Maximum Performance Glass Power Steering Element
Notes: Inside-Out Flow Direction
Fits: Kenworth, Mack Trucks
Replaces: Mack 5839870678A; Nelson 870678A
O.D.: 3 3/8 (85.7)
I.D.: 13/16 (20.6)
Height: 4 1/8 (104.8)
Grommets: [2] Attached



PT9399-MPG Maximum Performance Glass Hydraulic Element
Fits: Komatsu Excavators, Loaders
Replaces: Komatsu 209-60-77531
O.D.: 5 15/16 (150.8)
I.D.: 3 19/32 (91.3)
Height: 15 3/4 (400.0)
Related To: PT9351-MPG (Short Version)



PT9395-MPG Maximum Performance Glass Hydraulic Element
Fits: Case-International, Fendt, J.C. Bamford, Massey Ferguson Tractors
Replaces: Case 192200280705; Fleetguard HF35320
O.D.: 2 3/4 (69.9)
I.D.: 1 (25.4) One End
Height: 7 29/32 (200.8)
I.Gskt: [1] Included



BT9400-MPG Maximum Performance Glass Hydraulic Spin-on
Notes: Rated 1000 PSI minimum burst.
Contains: 50 PSID By-Pass Valve By-Pass Screen
Replaces: Dana 4209440; Kalmar 9210280007
Thread: 2 -16
O.D.: 3 3/4 (95.3)
Height: 7 7/32 (183.4)
O-Ring: [2] Attached



PT9396 Hydraulic Element
Fits: Case, Kobelco, New Holland Excavators
Replaces: Kobelco PA33H01040P1; New Holland PA33H01040P1
O.D.: 2 3/4 (69.9)
I.D.: 1 5/8 (41.3)
Height: 4 29/32 (124.6)



PT9401 Wire Mesh Supported Hydraulic Element
Contains: 3/8-16 Threaded Nut on Closed End
Fits: Hitachi Excavators
Replaces: Hitachi 4333464
O.D.: 7 7/8 (200.0)
I.D.: 4 15/32 (113.5) One End
Height: 5 15/32 (138.9)
O-Ring: [1] Attached













BT9402 Transmission Spin-on
Contains: 50 PSID By-Pass Valve
Fits: Case, New Holland Equipment
Replaces: New Holland 85817004
Thread: 13/16 -16
O.D.: 3 1/32 (77.0)
Height: 5 1/2 (139.7)
I.Gskt: [1] Included



Measurements Are Shown In Inches And (Millimeters)

WARNING: These products can expose you to chemicals, including Diisononyl Phthalate, Carbon black extracts, Nickel, 1,3 Butadiene, Ethylene Oxide, Epichlorohydrin, which are known to the State of California to cause cancer, and Bisphenol, Ethylene Glycol, Ethylene Oxide, 1,3 Butadiene, Epichlorohydrin, which are known to the State of California to cause birth defects or other reproductive harm. For more information go to www.P65Warnings.ca.gov.

<p>PT9403-MPG</p> 	<p>Wire Mesh Supported Maximum Performance Glass Hydraulic Element with Bail Handle Contains: 22 PSID By-Pass Valve Fits: John Deere, Timberjack Equipment Replaces: John Deere F061786; Donaldson P173178 O.D.: 4 1/2 (114.3) I.D.: 2 3/4 (69.9) One End Height: 16 3/16 (411.2) O-Ring: [1] Attached</p>	<p>PT9409-MPG</p> 	<p>Wire Supported Maximum Performance Glass Hydraulic Element Fits: John Deere Tractors Replaces: John Deere AL160316, AL160771; Fleetguard HF35343 O.D.: 3 3/32 (78.6) I.D.: 1 21/32 (42.1) Height: 10 1/4 (260.3) O-Ring: [2] Attached, [1] Included</p>
<p>PT9404-MPG</p> 	<p>Maximum Performance Glass Hydraulic Element Fits: Case Tractors Replaces: Case K210049; Fleetguard HF28939 O.D.: 3 1/8 (79.4) I.D.: 1 11/16 (42.9) One End Height: 4 5/8 (117.5) O-Ring: [1] Attached</p>	<p>PT9410-MPG</p> 	<p>Wire Supported Maximum Performance Glass Hydraulic Element Notes: Inside-Out Flow Direction Fits: Lull Lift Trucks Replaces: Lull 10727810, P27810 O.D.: 4 5/32 (105.6) I.D.: 13/32 (10.3) & 2 13/16 (71.4) Height: 7 15/32 (189.7) Grommets: [1] Attached</p>
<p>PT9405</p> 	<p>Hydraulic Element Fits: Caterpillar Lift Trucks Replaces: Caterpillar 92-2568; Donaldson P161413; Fleetguard HF6465 O.D.: 4 3/8 (111.1) I.D.: 2 7/16 (61.9) Height: 8 1/8 (206.4) A. Gskt: [2] Attached</p>	<p>PT9411-MPG</p> 	<p>Maximum Performance Glass Hydraulic Element Fits: Komatsu Dozers, Excavators Replaces: Komatsu 2076-07-1182 O.D.: 5 15/16 (150.8) I.D.: 3 19/32 (91.3) Height: 7 7/8 (200.0)</p>
<p>PT9406-MPG</p> 	<p>Maximum Performance Glass Hydraulic Element Fits: Caterpillar Paving Equipment Replaces: Caterpillar 1G5459 O.D.: 1 25/32 (45.2) I.D.: 1 (25.4) One End Height: 8 3/16 (208.0) O-Ring: [1] Attached</p>	<p>PT9413-MPG</p> 	<p>Maximum Performance Glass Hydraulic Element Fits: Komatsu Equipment Replaces: Komatsu 14X6031150 O.D.: 4 3/8 (111.1) I.D.: 2 13/32 (61.1) Height: 7 27/32 (199.2)</p>
<p>PT9407-MPG</p> 	<p>Maximum Performance Glass Hydraulic Element Fits: Caterpillar Equipment, Off-Highway Trucks Replaces: Caterpillar 1R1809 O.D.: 4 29/32 (124.6) I.D.: 2 1/16 (52.4) Height: 10 15/32 (265.9) I.Gskt: [1] Viton O-Ring: [1] Included</p>	<p>PT9414-MPG</p> 	<p>Wire Supported Maximum Performance Glass Hydraulic Element Fits: John Deere Forwarders, Wheeled Harvesters Replaces: John Deere F058437; Timberjack F058437; Fleetguard HF35198 O.D.: 2 3/4 (69.9) I.D.: 1 5/16 (33.3) One End Height: 5 (127.0) O-Ring: [1] Attached</p>
<p>BT9408</p> 	<p>Air Coalescer Spin-on Fits: Iveco Trucks; Mack CHN613 Truck Replaces: Cummins 3682984; Mack 279GB43M; Donaldson P566130; Fleetguard AF26113 Thread: M16 x 1.5 O.D.: 3 1/32 (77.0) Height: 2 5/16 (58.7) I.Gskt: G449-B</p>		

Measurements Are Shown In Inches And (Millimeters)

WARNING: These products can expose you to chemicals, including Diisononyl Phthalate, Carbon black extracts, Nickel, 1,3 Butadiene, Ethylene Oxide, Epichlorohydrin, which are known to the State of California to cause cancer, and Bisphenol, Ethylene Glycol, Ethylene Oxide, 1,3 Butadiene, Epichlorohydrin, which are known to the State of California to cause birth defects or other reproductive harm. For more information go to www.P65Warnings.ca.gov.

PT9415-MPG KI Set of 2 Maximum Performance Glass Transmission Elements



Notes: High capacity filters.
Fits: Allison World Transmissions with 4 Inch Sump
Replaces: Allison 29545779; GMC 29506337; John Deere AT327883; Fleetguard HF28943
Each Element:
O.D.: 3 7/32 (81.8)
I.D.: 1 17/32 (38.9) One End
Height: 5 15/16 (150.8)
F. Gskt: [2] Irregular, [2] Square Cut
O-Ring: [6] Viton Included

PT9416-MPG KI Set of 2 Maximum Performance Glass Transmission Elements



Notes: High capacity filters.
Fits: Allison World Transmissions with 2 In. or 7 In. Sump
Replaces: Allison 29545776, 29548987, 29558117, 29558328; Donaldson P179206, P560972; Fleetguard HF28944, HF35153
Each Element:
O.D.: 3 7/32 (81.8)
I.D.: 1 17/32 (38.9) One End
Height: 4 3/16 (106.4)
I.Gskt: [1] Included Each Element
F. Gskt: [2] Irregular, [2] Square Cut
O-Ring: [6] Viton Included

PT9417 Transmission Element



Fits: R.V.I., Volvo Trucks
Replaces: Renault 7401521527, 7485105048, 7485108176; Volvo 1521527, 20776259, 85108176, 85105048
O.D.: 2 17/32 (64.3)
I.D.: 1 7/32 (31.0)
Height: 5 7/8 (149.2)
A. Gskt: [2] Attached

PT9418 Hydraulic Element



Contains: Reinforced Centertube
Fits: Caterpillar Equipment
Replaces: Caterpillar 1R0778
O.D.: 5 1/8 (130.2)
I.D.: 3 3/8 (85.7)
Height: 9 (228.6)

PT9419-MPG Maximum Performance Glass Hydraulic Element



Notes: Inside-Out Flow Direction
Fits: IHC Trucks
Replaces: International 1695528-C1; Nelson 87795A
O.D.: 2 15/32 (62.7)
I.D.: 11/32 (8.7) & 1 3/32 (27.8)
Height: 5 1/32 (127.8)

PT9420-MPG Maximum Performance Glass Hydraulic Element



Fits: Komatsu CD110R-2 Crawler Carrier, D61EX-15EO, D61PX-15 Dozers, PC40MR-2, PC50MR-2, PC78MR-6, PC78US-6 Excavators
Replaces: Komatsu 21W-60-41121
O.D.: 4 3/8 (111.1)
I.D.: 2 7/16 (61.9)
Height: 3 31/32 (100.8)

BT9421-MPG Maximum Performance Glass Hydraulic Spin-on



Fits: Case Dozers; Case-International Tractors
Replaces: Case 47131182, 87404986
Thread: 1 3/8 -12
O.D.: 4 23/32 (119.9)
Height: 11 17/32 (292.9)
I.Gskt: [1] Included

BT9422 Hydraulic Spin-on



Contains: Stud Thread: M24 x 1.5
Fits: John Deere Equipment
Replaces: ZF 050132315401, 075013106101; Case/New Holland 332202A1, 8603535; John Deere AT336140
O.D.: 3 3/4 (95.3)
Height: 8 1/32 (204.0)
I.Gskt: [1] Included

PT9423 Hydraulic Element



Fits: Mercedes-Benz Trucks, Vans
Replaces: Mercedes-Benz 2690321, A0002690321; Donaldson P550744
O.D.: 2 5/16 (58.7)
I.D.: 5/8 (15.9) One End
Height: 4 1/32 (102.4)
A. Gskt: [1] Attached











PT9424 Hydraulic Element



Fits: Hitachi, John Deere Kubota Excavators
Replaces: Hitachi 4294130; John Deere 4294130
O.D.: 1 21/32 (42.1)
I.D.: 27/32 (21.4) One End
Height: 2 1/16 (52.4)
O-Ring: [1] Attached

Measurements Are Shown In Inches And (Millimeters)

WARNING: These products can expose you to chemicals, including Diisononyl Phthalate, Carbon black extracts, Nickel, 1,3 Butadiene, Ethylene Oxide, Epichlorohydrin, which are known to the State of California to cause cancer, and Bisphenol, Ethylene Glycol, Ethylene Oxide, 1,3 Butadiene, Epichlorohydrin, which are known to the State of California to cause birth defects or other reproductive harm. For more information go to www.P65Warnings.ca.gov.

<p>PT9425-MPG</p> 	<p>Maximum Performance Glass Hydraulic Element</p> <p>Fits: Barber-Greene, Caterpillar Asphalt Pavers</p> <p>Replaces: Caterpillar 123-2873</p> <p>O.D.: 3 25/32 (96.0)</p> <p>I.D.: 2 1/8 (54.0)</p> <p>Height: 8 5/32 (207.2)</p> <p>O-Ring: [1] Attached</p>	<p>PT9432-MPG</p> 	<p>Maximum Performance Glass Hydraulic Element</p> <p>Replaces: Euclid E12635052, E4099537; Hitachi 12635052, 4099537</p> <p>O.D.: 3 25/32 (96.0)</p> <p>I.D.: 2 1/8 (54.0) One End</p> <p>Height: 12 15/16 (328.6)</p> <p>I.Gskt: [1] Viton</p> <p>O-Ring: [2] Included</p>
<p>PT9426</p> 	<p>Hydraulic Breather Element</p> <p>Fits: Komatsu Compactors, Dump Trucks, Excavators, Loaders</p> <p>Replaces: Komatsu 285-62-17320; Fleetguard HF28928</p> <p>O.D.: 2 1/32 (51.6)</p> <p>I.D.: 1 15/32 (37.3)</p> <p>Height: 2 1/32 (51.6)</p>	<p>BT9433</p> 	<p>Hydraulic Spin-on</p> <p>Fits: Caterpillar Dozers, Loaders</p> <p>Replaces: Caterpillar 222-6713</p> <p>Thread: 1 3/8 -12</p> <p>O.D.: 3 3/4 (95.3)</p> <p>Height: 9 17/32 (242.1)</p> <p>O-Ring: [1] Attached</p>
<p>PT9427-MPG</p> 	<p>Maximum Performance Glass Hydraulic Element</p> <p>Notes: Inside-Out Flow Direction</p> <p>Fits: Caterpillar D10T, D11T Crawler Tractors, 793D Off-Highway Truck, 587T Pipelayer, 657G Wheel Tractor</p> <p>Replaces: Caterpillar 249-2337</p> <p>O.D.: 6 25/32 (172.2)</p> <p>I.D.: 4 1/4 (108.0)</p> <p>Height: 9 (228.6)</p> <p>A. Gskt: [2] Attached</p>	<p>PT9434</p> 	<p>Hydraulic Element</p> <p>Contains: 35 PSID By-Pass Valve</p> <p>Fits: Renault R212, R312, R322 Buses</p> <p>Replaces: Renault 5000293901; Mann & Hummel H616/1</p> <p>O.D.: 2 11/32 (59.5)</p> <p>I.D.: 1 3/16 (30.2) One End</p> <p>Height: 7 3/8 (187.3)</p> <p>O-Ring: [1] Attached</p>
<p>PT9429-MPG</p> 	<p>Maximum Performance Glass Hydraulic Element</p> <p>Fits: Caterpillar Equipment, Off-Highway Trucks</p> <p>Replaces: Caterpillar 328-3655</p> <p>O.D.: 4 29/32 (124.6)</p> <p>I.D.: 2 (50.8) One End</p> <p>Height: 10 15/32 (265.9)</p> <p>O-Ring: [1] Viton Attached</p>	<p>PT9435-MPG</p> 	<p>Maximum Performance Glass Hydraulic Element</p> <p>Fits: Volvo Dump Trucks, T450D Articulated Scraper Hauler</p> <p>Replaces: Volvo 11707544</p> <p>O.D.: 2 3/32 (53.2)</p> <p>I.D.: 29/32 (23.0) One End</p> <p>Height: 4 15/32 (113.5)</p> <p>I.Gskt: [1] Included</p> <p>O-Ring: [1] Included</p>
<p>PT9430-MPG</p> 	<p>Maximum Performance Glass Hydraulic Element</p> <p>Notes: Inside-Out Flow Direction</p> <p>Fits: Caterpillar Equipment</p> <p>Replaces: Caterpillar 104-6931</p> <p>O.D.: 5 1/8 (130.2)</p> <p>I.D.: 3 3/8 (85.7)</p> <p>Height: 7 (177.8)</p>	<p>BT9436-MPG</p> 	<p>Maximum Performance Glass Hydraulic Spin-on</p> <p>Fits: J.C. Bamford Equipment</p> <p>Replaces: J.C. Bamford 32/909000</p> <p>Thread: 1 3/8 -12</p> <p>O.D.: 3 3/4 (95.3)</p> <p>Height: 6 1/8 (155.6)</p> <p>I.Gskt: [1] Included</p>
	<p>BT9439</p> 	<p>Hydraulic Spin-on</p> <p>Contains: 14 PSID By-Pass Valve</p> <p>Fits: Ford, New Holland Tractors</p> <p>Replaces: New Holland 82983474</p> <p>Thread: 1 3/4 -16</p> <p>O.D.: 4 21/32 (118.3)</p> <p>Height: 9 15/16 (252.4)</p> <p>I.Gskt: [1] Included</p>	

Measurements Are Shown In Inches And (Millimeters)

WARNING: These products can expose you to chemicals, including Diisononyl Phthalate, Carbon black extracts, Nickel, 1,3 Butadiene, Ethylene Oxide, Epichlorohydrin, which are known to the State of California to cause cancer, and Bisphenol, Ethylene Glycol, Ethylene Oxide, 1,3 Butadiene, Epichlorohydrin, which are known to the State of California to cause birth defects or other reproductive harm. For more information go to www.P65Warnings.ca.gov.

<p>BT9440 Hydraulic Spin-on Contains: Hex nut for removal Fits: Hitachi Excavators, John Deere Excavators, Forestry Swing Machines Replaces: Hitachi 4630525 Thread: M68 x 2.0 O.D.: 3 7/16 (87.3) Height: 6 13/32 (162.7) O-Ring: [2] Attached</p> 	<p>PT9446 Hydraulic Element Notes: Inside-Out Flow Direction Contains: By-Pass Valve Fits: Caterpillar, Mitsubishi Lift Trucks Replaces: Caterpillar 9257614100; Mitsubishi 9257614100 Thread: 1 -11 BSP O.D.: 3 17/32 (89.7) Height: 11 11/16 (296.9)</p> 
<p>PT9441-MPG Maximum Performance Glass Hydraulic Element Fits: Caterpillar Equipment, Off-Highway Trucks Replaces: Caterpillar 4T3133 O.D.: 6 25/32 (172.2) I.D.: 3 15/16 (100.0) Height: 9 1/16 (230.2) A. Gskt: [2] Viton Attached</p> 	<p>PT9447 Hydraulic Element Contains: By-Pass Valve Fits: Caterpillar, Mitsubishi Lift Trucks Replaces: Caterpillar 9187505900, 9187511400; Mitsubishi 9187505900 Thread: 1 -11.5 NPT O.D.: 3 3/32 (78.6) Height: 7 17/32 (191.3)</p> 
<p>BT9442-MPG Maximum Performance Glass Hydraulic Spin-on Fits: Volvo Excavators, Forestry Carriers Replaces: Volvo 14532687 Thread: 1 1/8 -16 O.D.: 3 11/16 (93.7) Height: 5 3/8 (136.5) I.Gskt: G381-A</p> 	<p>PT9448 Hydraulic Element Notes: Inside-Out Flow Direction Contains: By-Pass Valve Fits: Caterpillar, Mitsubishi Lift Trucks Replaces: Caterpillar 9137503800; Mitsubishi 9137503800 Thread: 1 -11 BSP O.D.: 3 17/32 (89.7) Height: 6 5/16 (160.3)</p> 
<p>PT9443 Hydraulic Element with Lift Bar Fits: Hitachi, John Deere Excavators Replaces: Hitachi 4443596, 4448401 O.D.: 4 13/32 (111.9) I.D.: 2 1/8 (54.0) One End Height: 20 11/16 (525.5) I.Gskt: [1] Included O-Ring: [1] Included</p> 	<p>PT9449 Power Steering Element Fits: Mack CH612 Truck Replaces: Mack 583983213F; Nelson 83213 O.D.: 3 3/8 (85.7) I.D.: 2 (50.8) Height: 2 23/32 (69.1) Grommets: [2] Attached</p> 
<p>PT9444-MPG Maximum Performance Glass Hydraulic Element Fits: Caterpillar Equipment, Off-Highway Trucks Replaces: Caterpillar 1672009; Donaldson P550924 O.D.: 6 25/32 (172.2) I.D.: 3 15/16 (100.0) Height: 9 1/16 (230.2) A. Gskt: [2] Attached</p> 	<p>PT9450-MPG Maximum Performance Glass Hydraulic Element Fits: Kalmar Lift Trucks Replaces: Kalmar 9216890007 O.D.: 3 19/32 (91.3) I.D.: 1 29/32 (48.4) One End Height: 7 3/4 (196.9) I.Gskt: [1] Included O-Ring: [3] Included</p> 
<p>PT9445-MPG Maximum Performance Glass Hydraulic Element Fits: John Deere Dump Trucks Replaces: John Deere TT222389; Donaldson P763016 O.D.: 4 31/32 (126.2) I.D.: 3/8 (9.5) & 3 5/8 (92.1) Height: 18 29/32 (480.2) O-Ring: [1] Attached</p> 	<p>PT9451-MPG Maximum Performance Glass Hydraulic Stacked Element with Bail Handle Contains: Wire Mesh Strainer Basket Fits: Liebherr Excavators Replaces: Liebherr 7373881; Donaldson P784037 O.D.: 6 1/8 (155.6) I.D.: 3 29/32 (99.2) One End Height: 24 13/16 (630.2) I.Gskt: [2] Included</p> 

Measurements Are Shown In Inches And (Millimeters)

WARNING: These products can expose you to chemicals, including Diisononyl Phthalate, Carbon black extracts, Nickel, 1,3 Butadiene, Ethylene Oxide, Epichlorohydrin, which are known to the State of California to cause cancer, and Bisphenol, Ethylene Glycol, Ethylene Oxide, 1,3 Butadiene, Epichlorohydrin, which are known to the State of California to cause birth defects or other reproductive harm. For more information go to www.P65Warnings.ca.gov.

<p>PT9452</p> 	<p>Hydraulic Element Fits: Hitachi Excavators, Loaders; John Deere Excavators, Forestry Swing Machines Replaces: Hitachi 4656608; John Deere 4656608 O.D.: 6 1/16 (154.0) I.D.: 3 3/4 (95.3) Height: 17 1/4 (438.2) A. Gskt: [2] Attached O-Ring: [2] Included</p>	<p>BT9465</p> 	<p>Hydraulic Spin-on Replaces: Raymond 52050901 Thread: 1 -12 O.D.: 3 11/16 (93.7) Height: 5 15/32 (138.9) I.Gskt: [1] Included</p>
<p>BT9454</p> 	<p>Hydraulic Spin-on with Removal Nut Fits: Komatsu Equipment Replaces: Komatsu 7140728711, 7140728712, 7140728713 Thread: M60 x 2.0 O.D.: 4 5/32 (105.6) Height: 10 3/8 (263.5) I.Gskt: [1] Included O-Ring: [2] Attached</p>	<p>BT9466-MPG</p> 	<p>Maximum Performance Glass Hydraulic Spin-on Notes: Rated 1000 PSI minimum burst. Fits: Caterpillar Equipment Replaces: Caterpillar 3416643; Donaldson P573360, P763535; Mann & Hummel WH9803 Thread: 1 3/8 -12 O.D.: 3 3/4 (95.3) Height: 9 17/32 (242.1) I.Gskt: [1] Included</p>
<p>BT9456</p> 	<p>Transmission Spin-on Contains: Anti-Drainback Valve 30 PSID By-Pass Valve Fits: J.C. Bamford Equipment Replaces: ITL 58118062; J.C. Bamford 58118062 Thread: 1 -12 O.D.: 3 23/32 (94.5) Height: 3 5/16 (84.1) I.Gskt: G401</p>	<p>PT9468</p> 	<p>In-Line Hydraulic Spin-on Fits: Bobcat Excavators, Loaders; John Deere Loaders Replaces: Bobcat 6661022; John Deere KV13414 Thread: 9/16 -18 O.D.: 1 1/2 (38.1) to 1 23/32 (43.7) Length: 3 3/16 (81.0)</p>
<p>PT9459-MPG</p> 	<p>2-Section Maximum Performance Glass Hydraulic Element with Bail Handle Fits: Liebherr R984B, R984C Excavators Replaces: Liebherr 7373884; Filtrac WG633; Fleetguard HF35367; Wix Industrial W01AG633 O.D.: 6 1/8 (155.6) I.D.: 3 5/32 (80.2) & 3 29/32 (99.2) Height: 37 3/8 (949.3) O-Ring: [2] Attached</p>	<p>PT9469</p> 	<p>In-Line Hydraulic Filter Fits: John Deere Loggers, Excavators; Hitachi Zaxis 350L Excavator Replaces: John Deere 4452326 O.D.: 7/8 (22.2) Inlet: 5/16 Outlet: 7/32 Length: 1 15/32 (37.3) O-Ring: [1] Attached</p>
<p>PT9462</p> 	<p>Hydraulic Element Fits: Agco, Challenger Tractors Replaces: Agco 3792287M1 O.D.: 1 21/32 (42.1) I.D.: 27/32 (21.4) One End Height: 3 1/2 (88.9) O-Ring: [1] Attached</p>	<p>PT9470</p> 	<p>In-Line Hydraulic Filter Fits: John Deere Equipment Replaces: John Deere AT183869 O.D.: 1 1/2 (38.1) Inlet: 11/16-16 Outlet: 13/16-16 Length: 2 13/16 (71.4) O-Ring: [1] Attached</p>
<p>BT9464</p> 	<p>Hydraulic Spin-on Fits: Caterpillar Equipment Replaces: Caterpillar 518670, 518670X Thread: M45 x 2.0 O.D.: 3 7/16 (87.3) Height: 6 1/16 (154.0) I.Gskt: [1] Included O-Ring: [1] Included</p>	<p>BT9471</p> 	<p>Hydraulic Spin-on Contains: 40 PSID By-Pass Valve Fits: Valtra Tractors Replaces: Agco 836536797, 836579590; Valmet 20410800; Valtra V836536797 Thread: M24 x 1.5 O.D.: 3 23/32 (94.5) Height: 4 3/16 (106.4) I.Gskt: [1] Included</p>

Measurements Are Shown In Inches And (Millimeters)

WARNING: These products can expose you to chemicals, including Diisononyl Phthalate, Carbon black extracts, Nickel, 1,3 Butadiene, Ethylene Oxide, Epichlorohydrin, which are known to the State of California to cause cancer, and Bisphenol, Ethylene Glycol, Ethylene Oxide, 1,3 Butadiene, Epichlorohydrin, which are known to the State of California to cause birth defects or other reproductive harm. For more information go to www.P65Warnings.ca.gov.

PT9472 Hydraulic Element
Fits: Case, Link-Belt Excavators
Replaces: Case 159282A1; Link-Belt KHJ0738
O.D.: 6 13/32 (162.7)
I.D.: 9/16 (14.3) One End
Height: 9 7/16 (239.7)



PT9481-MPG Maximum Performance Glass Hydraulic Element
Fits: Komatsu Excavators, Loaders
Replaces: Komatsu 2076051410; Filtrec WG194
O.D.: 2 7/16 (61.9)
 Flange 2 15/16 (74.6)
I.D.: 31/32 (24.6) & 1 3/16 (30.2)
Height: 1 3/8 (34.9)



S9475 Set of 2 Foam Hydraulic Tank Breathers
Fits: Komatsu Equipment
Replaces: Komatsu 20Y6021470; Donaldson P502518
O.D.: 2 7/16 (61.9)
I.D.: 1 31/32 (50.0)
Height: 15/16 (23.8)



PT9482-MPG Maximum Performance Glass Hydraulic Element
Fits: Liebherr Excavators
Replaces: Liebherr 5618166; Filtrec WG426; Fleetguard HF35454
O.D.: 2 3/8 (60.3)
I.D.: 15/16 (23.8) One End
Height: 4 1/8 (104.8)
O-Ring: [1] Attached



PT9476-MPG Maximum Performance Glass Hydraulic Element
Fits: Kobelco, New Holland Excavators
Replaces: Case YN52V01020P1; Kobelco YN52V01020P1, YN52V01011P1; YN52V01011P2; New Holland YN52V01020P1
O.D.: 5 23/32 (145.3)
I.D.: 3 13/16 (96.8)
Height: 5 1/4 (133.4)



PT9483-MPG Maximum Performance Glass Hydraulic Element
Fits: Caterpillar Equipment, Off-Highway Trucks
Replaces: Caterpillar 3434465; Donaldson P165239; Filtrec WG917
O.D.: 5 1/8 (130.2)
I.D.: 3 5/16 (84.1)
Height: 8 15/16 (227.0)
A. Gskt: [2] Viton Attached



PT9477 Stainless Steel Mesh Hydraulic Element
Fits: Case, Fiat, Ford, New Holland Tractors
Replaces: Case 1909143; New Holland 1909143
O.D.: 1 3/4 (44.4)
I.D.: 1 (25.4) One End
Height: 3 15/16 (100.0)
A. Gskt: [1] Attached



PT9484-MPG Maximum Performance Glass Hydraulic Element
Fits: Case, New Holland Excavators
Replaces: Case 8914671; New Holland 8914671; Filtrec D120G25B
O.D.: 2 (50.8)
I.D.: 15/16 (23.8) One End
Height: 4 1/2 (114.3)
O-Ring: [1] Attached



PT9478-MPG Maximum Performance Glass Hydraulic Element
Fits: Fiat-Allis, Fiat-Hitachi, New Holland Loaders
Replaces: Case 76028203; New Holland 76028203; Donaldson P171733; Filtrec D132G25A
O.D.: 2 3/32 (53.2)
I.D.: 1 3/32 (27.8) One End
Height: 3 11/32 (84.9)
O-Ring: [1] Attached



PT9486-MPG Maximum Performance Glass Hydraulic Element
Replaces: Donaldson P171742; Filtrec D154G25A
O.D.: 3 1/16 (77.8)
I.D.: 1 19/32 (40.5) One End
Height: 5 1/2 (139.7)
O-Ring: [1] Attached



PT9479-MPG Maximum Performance Glass Hydraulic Element
Fits: J.C Bamford Loaders; MacDonald Johnston Trash Loaders
Replaces: J.C. Bamford 58100012; Donaldson P171825; Filtrec R714G10
O.D.: 2 27/32 (72.2)
I.D.: 11/32 (8.7) & 1 25/32 (45.2)
Height: 11 13/16 (300.0)













PT9487-MPG Maximum Performance Glass Hydraulic Element
Replaces: Schroeder KKS3; Donaldson P174247; Fleetguard HF30121
O.D.: 3 29/32 (99.2)
I.D.: 1 5/8 (41.3)
Height: 18 1/2 (469.9)



Measurements Are Shown In Inches And (Millimeters)

WARNING: These products can expose you to chemicals, including Diisononyl Phthalate, Carbon black extracts, Nickel, 1,3 Butadiene, Ethylene Oxide, Epichlorohydrin, which are known to the State of California to cause cancer, and Bisphenol, Ethylene Glycol, Ethylene Oxide, 1,3 Butadiene, Epichlorohydrin, which are known to the State of California to cause birth defects or other reproductive harm. For more information go to www.P65Warnings.ca.gov.

<p>PT9488-MPG</p> 	<p>Maximum Performance Glass Hydraulic Element</p> <p>Replaces: Parker 931020Q; Donaldson P174260, P566277; Filtrec D651G25AV</p> <p>O.D.: 3 29/32 (99.2)</p> <p>I.D.: 1 5/8 (41.3)</p> <p>Height: 18 1/2 (469.9)</p>	<p>PT9493-MPG</p> 	<p>Maximum Performance Glass Hydraulic Element</p> <p>Replaces: Donaldson P564860; Filtrec DHD75G10B</p> <p>O.D.: 2 7/32 (56.4)</p> <p>I.D.: 1 (25.4) One End</p> <p>Height: 6 11/16 (169.9)</p> <p>O-Ring: [1] Attached</p>
<p>PT9489-MPG</p> 	<p>Maximum Performance Glass Hydraulic Element</p> <p>Replaces: Parker 929927Q; Donaldson P566498; Filtrec D761G25AV</p> <p>O.D.: 3 25/32 (96.0)</p> <p>I.D.: 2 7/32 (56.4) One End</p> <p>Height: 12 31/32 (329.4)</p> <p>O-Ring: [1] Viton Attached</p>	<p>PT9494-MPG</p> 	<p>Maximum Performance Glass Hydraulic Element</p> <p>Replaces: Donaldson P174297; Filtrec DMD0030E20B</p> <p>O.D.: 3 9/32 (83.3)</p> <p>I.D.: 1 7/8 (47.6) One End</p> <p>Height: 10 1/32 (254.8)</p>
<p>PT9490-MPG</p> 	<p>Maximum Performance Glass Hydraulic Element</p> <p>Replaces: Hydac 240D010BNHC; Donaldson P170608, P566672; Filtrec DHD240G10B</p> <p>O.D.: 2 23/32 (69.1)</p> <p>I.D.: 1 11/32 (34.1) One End</p> <p>Height: 6 13/16 (173.0)</p> <p>O-Ring: [1] Attached</p>	<p>PT9495-MPG</p> 	<p>Maximum Performance Glass Hydraulic Element</p> <p>Replaces: Donaldson P174300; Filtrec DMD0045E10B; Mann & Hummel HD976</p> <p>O.D.: 3 9/32 (83.3)</p> <p>I.D.: 1 7/8 (47.6) One End</p> <p>Height: 14 11/16 (373.1)</p>
<p>PT9491-MPG</p> 	<p>Maximum Performance Glass Hydraulic Element</p> <p>Replaces: Liebherr 7364597; Donaldson P177002, P566673</p> <p>O.D.: 2 23/32 (69.0)</p> <p>I.D.: 1 11/32 (34.1)</p> <p>Height: 6 13/16 (173.0)</p> <p>O-Ring: [1] Attached</p>	<p>PT9496-MPG</p> 	<p>Maximum Performance Glass Hydraulic Element</p> <p>Replaces: Pall HC6400FDP26H; Filtrec R426G03</p> <p>O.D.: 3 3/8 (85.7)</p> <p>I.D.: 2 (50.8) One End</p> <p>Height: 25 21/32 (651.7)</p> <p>O-Ring: [1] Attached</p>
<p>PT9492-MPG</p> 	<p>Maximum Performance Glass Hydraulic Element</p> <p>Replaces: Hydac 330D010BH3HC; Donaldson P170595, P566701; Filtrec DHD330H10B</p> <p>O.D.: 3 9/16 (90.5)</p> <p>I.D.: 1 29/32 (48.4) One End</p> <p>Height: 6 3/8 (161.9)</p> <p>O-Ring: [1] Attached</p>	<p>PT9497-MPG</p> 	<p>Maximum Performance Glass Hydraulic Element</p> <p>Notes: OBSOLETE. Availability Limited to Dealer Stock.</p> <p>Replaces: Pall HC6400FDS26H; Donaldson P569622; Fleetguard HF30325</p> <p>O.D.: 3 3/8 (85.7)</p> <p>I.D.: 2 (50.8) One End</p> <p>Height: 25 21/32 (651.7)</p> <p>O-Ring: [1] Attached</p>

Measurements Are Shown In Inches And (Millimeters)

WARNING: These products can expose you to chemicals, including Diisononyl Phthalate, Carbon black extracts, Nickel, 1,3 Butadiene, Ethylene Oxide, Epichlorohydrin, which are known to the State of California to cause cancer, and Bisphenol, Ethylene Glycol, Ethylene Oxide, 1,3 Butadiene, Epichlorohydrin, which are known to the State of California to cause birth defects or other reproductive harm. For more information go to www.P65Warnings.ca.gov.

PT9498-MPG Maximum Performance Glass Hydraulic Element



Notes: OBSOLETE. Availability Limited to Dealer Stock.
Replaces: Donaldson P165158; Filtrec R450G06; Fleetguard HF30073
O.D.: 3 13/16 (96.8)
I.D.: 1 11/16 (42.9) One End
Height: 8 5/32 (207.2)
O-Ring: [2] Attached

PT9503-MPG Maximum Performance Glass Hydraulic Element with Bail Handle



Fits: Terex Excavators
Replaces: Terex 5368655680
O.D.: 2 9/16 (65.1)
I.D.: 1 5/16 (33.3) One End
Height: 11 9/16 (293.7)
O-Ring: [1] Attached

PT9499-MPG Maximum Performance Glass Hydraulic Element with Bail Handle



Fits: Fendt Tractors
Replaces: Fendt G716860060310; Filtrec R631G10
O.D.: 2 1/2 (63.5)
I.D.: 1 1/8 (28.6) One End
Height: 12 3/16 (309.6)
O-Ring: [1] Attached

PT9504-MPG Maximum Performance Glass Hydraulic Element



Fits: Kubota Excavators
Replaces: Kubota RG23862190
O.D.: 3 1/4 (82.6)
I.D.: 7/8 (22.2) One End
Height: 9 5/8 (244.5)
O-Ring: [1] Attached

PT9500-MPG Maximum Performance Glass Hydraulic Element with Bail Handle



Notes: OBSOLETE. Availability Limited to Dealer Stock.
Replaces: Hydac 950R010BNHC; Donaldson P170891; Filtrec RHR950G10B
O.D.: 5 21/32 (143.7)
I.D.: 3 3/4 (95.3) One End
Height: 14 9/32 (362.7)

PT9505-MPG Maximum Performance Glass Hydraulic Element



Fits: Case Excavators
Replaces: Case 159705A1; Filtrec WG544
O.D.: 3 7/32 (81.8)
I.D.: 1 25/32 (45.2) One End
Height: 8 (203.2)
O-Ring: [1] Attached

PT9501-MPG Maximum Performance Glass Hydraulic Element



Fits: Komatsu Excavators
Replaces: Komatsu 2079705120; Filtrec WG239
O.D.: 3 15/16 (100.0)
I.D.: 1 29/32 (48.4) One End
Height: 8 9/32 (210.3)
O-Ring: [1] Attached

PT9507 Hydraulic Element with Bail Handle



Contains: By-Pass Valve
Replaces: Donaldson P171557; Filtrec R151C10B
O.D.: 5 1/8 (130.2)
I.D.: 2 1/16 (52.4) One End
Height: 7 7/8 (200.0)
Spring: [1] Included

PT9502-MPG Maximum Performance Glass Hydraulic Element with Bail Handle



Contains: By-Pass Valve
Fits: J.C. Bamford 520-50 Telescopic Handler
Replaces: J.C. Bamford 32/918500; Filtrec WG326
O.D.: 2 3/8 (60.3)
I.D.: 1 11/32 (34.1) One End
Height: 10 1/32 (254.8)
O-Ring: [1] Attached











PT9508 Hydraulic Element



Replaces: Donaldson P171310; Filtrec WP412
O.D.: 2 7/8 (73.0)
I.D.: 1 1/16 (27.0) One End
Height: 4 21/32 (118.3)
O-Ring: [1] Attached



Measurements Are Shown In Inches And (Millimeters)

WARNING: These products can expose you to chemicals, including Diisononyl Phthalate, Carbon black extracts, Nickel, 1,3 Butadiene, Ethylene Oxide, Epichlorohydrin, which are known to the State of California to cause cancer, and Bisphenol, Ethylene Glycol, Ethylene Oxide, 1,3 Butadiene, Epichlorohydrin, which are known to the State of California to cause birth defects or other reproductive harm. For more information go to www.P65Warnings.ca.gov.

<p>PT9509</p> 	<p>Hydraulic Element Replaces: U.C.C. UCSE1220; Donaldson P169019; Filtrec FS142B9T125; Fleetguard HF35164 Thread: 2 1/2 -11 BSP-PL O.D.: 5 29/32 (150.0) Height: 8 5/16 (211.1)</p>	<p>PT9515</p> 	<p>Hydraulic Element Replaces: Parker 901755; Filtrec S440T149 O.D.: 5 31/32 (151.6) I.D.: 3 5/8 (92.1) Height: 9 7/8 (250.8)</p>
<p>PT9510</p> 	<p>Hydraulic Element Replaces: Parker 925572; Filtrec D111T40AV O.D.: 1 25/32 (45.2) I.D.: 1 (25.4) One End Height: 4 7/16 (112.7) O-Ring: [1] Attached</p>	<p>PT9516</p> 	<p>Wire Mesh Hydraulic Element Fits: Massey Ferguson Tractors Replaces: Massey Ferguson 1870199M92 O.D.: 2 1/2 (63.5) I.D.: 7/16 (11.1) & 1 11/16 (42.9) Height: 3 1/2 (88.9) A. Gskt: [1] Attached F. Gskt: [1] Included</p>
<p>PT9511</p> 	<p>Hydraulic Element Replaces: Donaldson P173781; Filtrec D650T60A O.D.: 3 1/2 (88.9) I.D.: 1 5/8 (41.3) One End Height: 9 1/4 (235.0) O-Ring: [2] Attached</p>	<p>PT9517</p> 	<p>Wire Mesh Hydraulic Element Replaces: Donaldson P173585; Filtrec WT1180; Wix W03AT1180 O.D.: 5 1/2 (139.7) I.D.: 4 (101.6) Height: 8 5/8 (219.1) O-Ring: [2] Attached</p>
<p>PT9513</p> 	<p>Hydraulic Element Replaces: Parker 909299; Filtrec R590T149 O.D.: 4 1/4 (108.0) I.D.: 3 1/8 (79.4) One End Height: 9 3/4 (247.7) A. Gskt: [2] Attached F. Gskt: [1] Included</p>	<p>PT9518-MPG</p> 	<p>Maximum Performance Glass Hydraulic Element Fits: Komatsu Equipment Replaces: Komatsu 2086071122, 2086071123 O.D.: 7 (177.8) I.D.: 4 5/16 (109.5) Height: 7 7/8 (200.0)</p>
<p>PT9514</p> 	<p>Hydraulic Element Notes: OBSOLETE. Availability Limited to Dealer Stock. Replaces: Fairey-Arlon ST360; Donaldson P171795; Filtrec R712T60 O.D.: 2 27/32 (72.2) I.D.: 11/32 (8.7) & 1 25/32 (45.2) Height: 5 29/32 (150.0)</p>	<p>PT9519-MPG</p> 	<p>Maximum Performance Glass Hydraulic Element Fits: Volvo Excavators Replaces: Volvo 14510898 O.D.: 2 7/8 (73.0) I.D.: 1 5/16 (33.3) One End Height: 12 1/2 (317.5) O-Ring: [1] Attached</p>





Measurements Are Shown In Inches And (Millimeters)

WARNING: These products can expose you to chemicals, including Diisononyl Phthalate, Carbon black extracts, Nickel, 1,3 Butadiene, Ethylene Oxide, Epichlorohydrin, which are known to the State of California to cause cancer, and Bisphenol, Ethylene Glycol, Ethylene Oxide, 1,3 Butadiene, Epichlorohydrin, which are known to the State of California to cause birth defects or other reproductive harm. For more information go to www.P65Warnings.ca.gov.

<p>PT9520-MPG Maximum Performance Glass Hydraulic Element</p>  <p>Fits: Case, New Holland Excavators Replaces: Case 72111326; New Holland 72111326 O.D.: 4 15/16 (125.4) I.D.: 5/8 (15.9) & 3 1/4 (82.6) Height: 22 13/16 (579.4)</p>	<p>PT9528 Hydraulic Element</p>  <p>Fits: J.C. Bamford JS290, JS330 Excavators Replaces: J.C. Bamford JSJ0075 O.D.: 7 (177.8) I.D.: 4 3/8 (111.1) Height: 13 1/8 (333.4) A. Gskt: [2] Attached</p>
<p>PT9523-MPG Maximum Performance Glass Hydraulic Element with Bail Handle</p>  <p>Fits: Bobcat, Terex Excavators Replaces: Terex 5368632568 O.D.: 3 5/16 (84.1) I.D.: 1 1/2 (38.1) One End Height: 16 1/8 (409.6) O-Ring: [1] Attached, [1] Included</p>	<p>PT9529 Hydraulic Element</p>  <p>Fits: Komatsu Excavators Replaces: Komatsu 21U6032210 O.D.: 3 1/4 (82.6) I.D.: 1 5/8 (41.3) Height: 13 1/2 (342.9)</p>
<p>PT9524-MPG Maximum Performance Glass Hydraulic Element</p>  <p>Fits: Komatsu Excavators Replaces: Komatsu 76754473 O.D.: 8 15/16 (227.0) I.D.: 7 1/16 (179.4) Height: 21 9/16 (547.7) A. Gskt: [1] Attached</p>	<p>PT9530 Hydraulic Element with Bail Handle</p>  <p>Fits: Agco, Challenger, Fendt, Massey Ferguson Tractors Replaces: Massey Ferguson F916100490010 O.D.: 3 1/4 (82.6) I.D.: 1 3/8 (34.9) One End Height: 15 3/8 (390.5) O-Ring: [1] Attached</p>
<p>PT9525-MPG Maximum Performance Glass Hydraulic Element</p>  <p>Fits: John Deere Forwarders, Wheel Harvesters Replaces: John Deere F071978 O.D.: 3 5/8 (92.1) I.D.: 1 13/16 (46.0) One End Height: 10 7/8 (276.2) O-Ring: [1] Attached</p>	<p>PT9532 Hydraulic Element</p>  <p>Fits: Caterpillar Off-Highway Trucks Replaces: Caterpillar 6E1473; Fleetguard HF35501 O.D.: 4 (101.6) I.D.: 2 5/16 (58.7) Height: 9 9/32 (235.7)</p>
<p>PT9526-MPG Maximum Performance Glass Hydraulic Element with Bail Handle</p>  <p>Fits: JLG Industries Aerial Work Platforms Replaces: JLG 7024375 O.D.: 2 5/8 (66.7) I.D.: 1 1/4 (31.8) One End Height: 11 5/8 (295.3) O-Ring: [1] Attached</p>	<p>BT9533 Hydraulic Spin-on</p>  <p>Fits: Agco, Challenger, Massey Ferguson Tractors Replaces: Agco 4300400M1; Claas 6005028192; Massey Ferguson 3619712M1 Thread: M45 x 2.0 O.D.: 5 7/16 (138.1) Height: 6 15/16 (176.2) I.Gskt: [1] Included</p>
	<p>PT9535-MPG Maximum Performance Glass Hydraulic Element</p>  <p>Fits: Valmet Forestry Equipment; Valmet, Valtra Tractors Replaces: Agco 20639610; Donaldson P763757; Valmet 31549610 O.D.: 2 15/16 (74.6) I.D.: 1 1/4 (31.8) One End Height: 7 3/32 (180.2) O-Ring: [1] Attached, [1] Included</p>

Measurements Are Shown In Inches And (Millimeters)

WARNING: These products can expose you to chemicals, including Diisononyl Phthalate, Carbon black extracts, Nickel, 1,3 Butadiene, Ethylene Oxide, Epichlorohydrin, which are known to the State of California to cause cancer, and Bisphenol, Ethylene Glycol, Ethylene Oxide, 1,3 Butadiene, Epichlorohydrin, which are known to the State of California to cause birth defects or other reproductive harm. For more information go to www.P65Warnings.ca.gov.

<p>PT9536-MPG</p> 	<p>Maximum Performance Glass Hydraulic Element</p> <p>Fits: Caterpillar Applications Replaces: Caterpillar 3481861 O.D.: 3 1/4 (82.6) I.D.: 1 1/4 (31.8) & 1 7/8 (47.6) Height: 8 7/8 (225.4) F. Gskt: [1] Included O-Ring: [2] Attached</p>	<p>PT9557</p>  <p>Hydraulic Element</p> <p>Contains: 20 PSID By-Pass Valve Fits: Hitachi Excavators; John Deere Excavators, Loaders Replaces: Hitachi 4448402, 4443773; Donaldson P502270; Fleetguard HF7691 O.D.: 6 1/8 (155.6) I.D.: 4 13/16 (122.2) One End Height: 16 31/32 (431.0) A. Gskt: [1] Attached</p>
<p>PT9537-MPG</p> 	<p>Maximum Performance Glass Hydraulic Element</p> <p>Fits: Volvo Equipment Replaces: Volvo 14532686 O.D.: 1 21/32 (42.1) I.D.: 27/32 (21.4) One End Height: 3 7/16 (87.3) O-Ring: [1] Attached</p>	<p>BT9558-MPG</p>  <p>Maximum Performance Glass Hydraulic Spin-on</p> <p>Contains: Integral Post Seal Replaces: Quincy 142136 Thread: 1 1/4 -11 BSP-PL O.D.: 4 21/32 (118.3) Height: 8 3/32 (205.6) I.Gskt: G498-A</p>
<p>BT9553</p> 	<p>Transmission Spin-on</p> <p>Contains: Anti-Drainback Valve 30 PSID By-Pass Valve Fits: J.C. Bamford Equipment Replaces: J.C. Bamford 581/18076 Thread: 1 -12 O.D.: 3 25/32 (96.0) Height: 4 27/32 (123.0) I.Gskt: [1] Included</p>	<p>PT9559-MPG</p>  <p>Wire Mesh Supported Maximum Performance Glass Hydraulic Element</p> <p>Notes: Inside-Out Flow Direction Fits: Euclid, Hitachi Dump Trucks Replaces: Euclid 4099538, E4099538; Hitachi E4099538; Donaldson P560404; Fleetguard HF30357 O.D.: 3 5/32 (80.2) I.D.: 1 9/16 (39.7) One End Height: 12 15/16 (328.6) O-Ring: [1] Attached</p>
<p>PT9554-MPG</p> 	<p>Wire Supported Maximum Performance Glass Hydraulic Element</p> <p>Fits: Link-Belt Hydraulic Truck Cranes Replaces: Link-Belt D7J0149 O.D.: 5 (127.0) I.D.: 3 1/4 (82.6) Height: 18 5/16 (465.1) End Seals: [2] Attached</p>	<p>BT9560-MPG</p>  <p>Maximum Performance Glass Hydraulic Spin-on</p> <p>Fits: Caterpillar Equipment Replaces: Caterpillar 207-5035; Donaldson P179763 Thread: 1 3/4 -12 O.D.: 4 23/32 (119.9) Height: 14 3/32 (358.0) I.Gskt: [1] Included Related To: BT8870-MPG (Micron Difference)</p>
<p>PT9555</p> 	<p>Hydraulic Element</p> <p>Contains: Reinforced Centertube Fits: Caterpillar Equipment, Off-Highway Trucks Replaces: Caterpillar 1R0773; Donaldson P165238 O.D.: 3 15/16 (100.0) I.D.: 2 9/32 (57.9) Height: 9 1/4 (235.0) A. Gskt: [2] Attached</p>	<p>BT9561</p>  <p>Hydraulic Spin-on</p> <p>Contains: Anti-Drainback Valve 22 PSID By-Pass Valve Fits: J.C. Bamford Lift Trucks, Loaders Replaces: J.C. Bamford 581/18063 Thread: 1 -12 O.D.: 3 13/16 (96.8) Height: 3 13/16 (96.8) I.Gskt: [1] Included</p>
<p>PT9556-MPG</p> 	<p>Wire Supported Maximum Performance Glass Hydraulic Element</p> <p>Fits: Caterpillar Equipment Replaces: Caterpillar 179-9806, 179-9806X; Fleetguard HF35440 O.D.: 5 19/32 (142.1) I.D.: 3 7/8 (98.4) Height: 16 11/16 (423.9) O-Ring: [2] Attached</p>	<p>P9600</p>  <p>Lube Element</p> <p>Fits: Chrysler, Dodge, Ram Automotive, Jeep Replaces: Chrysler 68191349AA O.D.: 1 31/32 (50.0) I.D.: 7/8 (22.2) Height: 6 5/32 (156.4) O-Ring: [1] Attached, [1] Included</p>

Measurements Are Shown In Inches And (Millimeters)

WARNING: These products can expose you to chemicals, including Diisononyl Phthalate, Carbon black extracts, Nickel, 1,3 Butadiene, Ethylene Oxide, Epichlorohydrin, which are known to the State of California to cause cancer, and Bisphenol, Ethylene Glycol, Ethylene Oxide, 1,3 Butadiene, Epichlorohydrin, which are known to the State of California to cause birth defects or other reproductive harm. For more information go to www.P65Warnings.ca.gov.

B9601 Lube Spin-on
Contains: 36 PSID By-Pass Valve
Fits: Atlas, Deutz-Fahr, Ditch Witch, Mecalac, Voegele Equipment; Deutz Engines; Putzmeister Pumps
Replaces: Claas 13022760; Deutz 1182552, 1183574, 1183575; Voegele 4912911424; Volvo 21640514
Thread: 1 -12
O.D.: 3 23/32 (94.5)
Height: 8 9/32 (210.3)
I.Gskt: [1] Included



B9607 By-Pass Lube Spin-on
Fits: Volvo-Penta Engines
Replaces: Volvo 21632667
Thread: 1 3/8 -16 UN-2B
O.D.: 4 11/32 (110.3)
Height: 7 5/16 (185.7)
I.Gskt: [1] Included



P9602 Lube Element
Fits: Honda ATVs
Replaces: Honda 15412KEA003
O.D.: 2 11/16 (68.3)
I.D.: 13/16 (20.6)
Height: 1 27/32 (46.8)
O-Ring: [2] Included
Grommets: [2] Attached



BF9800 Fuel Spin-on
Contains: Integral Post Seal
Fits: M.T.U. 12V4000, 16V4000, 20V4000 Diesel Engines
Replaces: M.T.U. 20922801, X00012879
Thread: M32 x 1.5
O.D.: 4 1/4 (108.0)
Height: 10 15/32 (265.9)
I.Gskt: [1] Included



P9603 Lube Element
Contains: 25 PSID By-Pass Valve
Fits: Honda TRX450ER, TRX450R ATVs
Replaces: Honda 15412-MEB-671, 15412-MEN-671
O.D.: 1 9/16 (39.7)
I.D.: 15/32 (11.9) One End
Height: 1 7/16 (36.5)
O-Ring: [1] Included
Grommets: [1] Attached



PF9801 Fuel Element
Fits: Nissan, Opel, Renault Trucks
Replaces: Nissan 16405-00QAB; Opel 4411637; Renault 7701207667
O.D.: 2 25/32 (70.6)
I.D.: 25/32 (19.8)
Height: 4 23/32 (119.9)
O-Ring: [2] Included



B9604 Lube Spin-on
Fits: Ariel Compressors
Replaces: Ariel A661, A-0661; Donaldson P554004
Thread: 1 1/8 -16
O.D.: 4 1/4 (108.0)
Height: 10 15/32 (265.9)
I.Gskt: [1] Included



BF9802 Fuel Spin-on
Fits: Equipment with M.T.U. 8V2000 M92, 8V2000 M93, 10V2000 M92, 10V2000 M93 (2004-on), 10V2000 M72 (2005-on), 16V4000R41 (2002-on), 20V4000 Engines with Common Rail Injection Systems
Replaces: M.T.U. X00042421; Mann & Hummel WDK11102/10
Thread: M32 x 1.5
O.D.: 4 1/4 (108.0)
Height: 10 15/32 (265.9)
I.Gskt: [1] Included



P9605 Lube Element
Fits: Dodge Dart, Jeep Renegade; Fiat 500
Replaces: Chrysler 68102241AA; Fiat 73500049; Ford 1565248; General Motors 93177787; Suzuki 1651185C00, 1651185E00
O.D.: 2 9/16 (65.1)
I.D.: 31/32 (24.6)
Height: 3 9/32 (83.3)
O-Ring: [1] Included















PF9803 Fuel Element
Fits: Mitsubishi BE64D Bus, FE120, FE125, FD140, FG140, FD145, FD180 Trucks; Sterling 360 Truck all with Mitsubishi 4M50 Engine
Replaces: Mitsubishi ME222133, ME222135; Nissan 16403-WK900
O.D.: 3 23/32 (94.5)
I.D.: 1 1/32 (26.2) One End
Height: 3 11/16 (93.7)
F. Gskt: [1] Included
O-Ring: [1] Included
Grommets: [1] Attached
Related To: PF7982, PF7983, PF7984 (Long Versions)



B9606 Full-Flow Lube Spin-on
Fits: Volvo-Penta Engines
Replaces: Volvo 21632664
Thread: 1 1/8 -16 UN-2B
O.D.: 4 1/2 (114.3)
Height: 7 5/16 (185.7)
I.Gskt: [1] Included



Measurements Are Shown In Inches And (Millimeters)
WARNING: These products can expose you to chemicals, including Diisononyl Phthalate, Carbon black extracts, Nickel, 1,3 Butadiene, Ethylene Oxide, Epichlorohydrin, which are known to the State of California to cause cancer, and Bisphenol, Ethylene Glycol, Ethylene Oxide, 1,3 Butadiene, Epichlorohydrin, which are known to the State of California to cause birth defects or other reproductive harm. For more information go to www.P65Warnings.ca.gov.

<p>PF9804 Fuel/Water Separator Element Fits: Freightliner Cascadia, Columbia, Business Class M2 all with Detroit Diesel DD13, DD15 Engines Replaces: Alliance ABP/N10G-FS19915; Detroit Diesel FS19915WE, A0000903651 O.D.: 5 27/32 (148.4) I.D.: 1 1/32 (26.2) One End Height: 7 19/32 (192.9) O-Ring: [2] Included Grommets: [1] Attached</p> 	<p>BF9811-SP Fuel/Water Separator Spin-on with Drain and Sensor Port Notes: CAUTION: Furnished O-Ring must be installed on post for seal. Contains: Sensor Port Thread: 9/16-18 Standpipe Fits: Caterpillar Equipment Replaces: Caterpillar 326-1642 Thread: 1 -14 O.D.: 4 1/4 (108.0) Height: 7 15/32 (189.7) I.Gskt: [1] Included O-Ring: [1] Included</p> 
<p>BF9805 In-Line Fuel Filter Contains: 1/4 Inch Vapor Line Fits: Audi, Volkswagen Automotive, Light-Duty Trucks Replaces: Volkswagen 6Q0201051C O.D.: 2 13/32 (61.1) Inlet: 1/4 Outlet: 1/4 Length: 6 15/32 (164.3)</p> 	<p>BF9812 Fuel Spin-on with Drain Contains: Integral Post Seal Replaces: Parker China Division CX180, S1117040; Sinotruk VG1408739A Thread: M16 x 1.5 O.D.: 3 5/32 (80.2) Height: 7 5/16 (185.7) I.Gskt: [1] Included</p> 
<p>BF9807 In-Line Fuel Filter Fits: John Deere Tractors Replaces: John Deere AL153517 O.D.: 2 1/8 (54.0) Inlet: 3/16 Outlet: 3/16 Length: 4 5/8 (117.5)</p> 	<p>BF9813 Fuel Spin-on with Drain Contains: Integral Post Seal Replaces: Parker China Division CX180A; Sinotruk VG1408740A Thread: M16 x 1.5 O.D.: 3 9/32 (83.3) Height: 7 15/32 (189.7)</p> 
<p>BF9808-D Secondary Fuel Element with Drain Fits: John Deere Forwarders, Tractors Replaces: John Deere RE526557; Stanadyne 37013; Fleetguard FS19978 O.D.: 3 3/16 (81.0) I.D.: 1/2 (12.7) One End Height: 6 1/16 (154.0) Grommets: [1] Attached</p> 	<p>PF9814 Fuel/Water Separator Element Contains: Relief Valve Fits: Freightliner, IHC, Kenworth, Peterbilt Trucks Replaces: Fleetguard FS19764; Davco 102527 O.D.: 4 3/16 (106.4) I.D.: 2 1/32 (16.7) One End Height: 7 1/32 (178.6) O-Ring: [2] Included</p> 
<p>BF9809-D Secondary Fuel Element with Drain Notes: Reverse Flow Fits: 7/2006-on Ford Transit Replaces: Ford 1370779, 6C11-9176-AA; Stanadyne 38034, 38640 O.D.: 3 3/16 (81.0) I.D.: 13/16 (20.6) One End Height: 7 25/32 (197.6) Grommets: [1] Attached</p> 	<p>BF9815 Fuel Spin-on Replaces: Parker China Division CX0815; Weichai Power 612600081334 Thread: M20 x 1.5 O.D.: 3 19/32 (91.3) Height: 7 1/8 (181.0) I.Gskt: [1] Included</p> 
<p>BF9810-D Secondary Fuel Element with Drain Notes: Reverse Flow Fits: 11/2004-on Ford Transit 2.0 DI TDE, 3/2004-on Transit 2.4 TDE Van Replaces: Ford 4537952, 4669224, 3C11-9176-BB; Motorcraft EFC335; Stanadyne 36621, 36994 O.D.: 3 3/16 (81.0) I.D.: 13/16 (20.6) One End Height: 7 25/32 (197.6) Grommets: [1] Attached</p> 	<p>BF9816 Fuel Spin-on Contains: Integral Post Seal Replaces: Parker China Division CX1012; DCD 4102H1510 Thread: 1 -14 O.D.: 4 1/4 (108.0) Height: 5 11/16 (144.5) I.Gskt: [1] Included</p> 

Measurements Are Shown In Inches And (Millimeters)

WARNING: These products can expose you to chemicals, including Diisononyl Phthalate, Carbon black extracts, Nickel, 1,3 Butadiene, Ethylene Oxide, Epichlorohydrin, which are known to the State of California to cause cancer, and Bisphenol, Ethylene Glycol, Ethylene Oxide, 1,3 Butadiene, Epichlorohydrin, which are known to the State of California to cause birth defects or other reproductive harm. For more information go to www.P65Warnings.ca.gov.

<p>BF9817 Fuel Spin-on Replaces: Parker China Division WBF220; Weichai Power 612630080087 Thread: M32 x 1.5 O.D.: 4 9/32 (108.7) Height: 10 11/32 (262.7) I.Gskt: [1] Included</p> 	<p>PF9825 Fuel Element Notes: OBSOLETE. Availability Limited to Dealer Stock. Replaces: Parker China Division 61021520; DCD 61021520 O.D.: 2 29/32 (73.8) I.D.: 5/8 (15.9) Height: 4 3/16 (106.4)</p> 
<p>BF9818 Fuel Spin-on with Drain Replaces: Parker China Division WBF1260A, WFB1260A Thread: 1 -14 O.D.: 4 9/32 (108.7) Height: 10 25/32 (273.8) I.Gskt: [1] Included</p> 	<p>PF9826 Fuel Element Replaces: Parker China Division 12V1030A; Jical 12VB1030A O.D.: 4 3/8 (111.1) I.D.: 31/32 (24.6) Height: 7 1/8 (181.0) Grommets: [2] Attached</p> 
<p>BF9820 Fuel Spin-on Replaces: Parker China Division WBF7886 Thread: M18 x 1.5 O.D.: 3 11/16 (93.7) Height: 5 25/32 (146.8) I.Gskt: [1] Included</p> 	<p>BF9827-D Secondary Fuel/Water Separator Element with Drain Notes: Reverse Flow Fits: Ford Transit Vans Replaces: Ford 3C11-9176-AA; 4537951; Stanadyne 36620, 36995 O.D.: 3 7/32 (81.8) I.D.: 7/8 (22.2) One End Height: 6 13/16 (173.0) Grommets: [1] Attached</p> 
<p>BF9821 Fuel Spin-on with Drain Replaces: Parker China Division CX0710B4 Thread: M20 x 1.5 O.D.: 3 1/32 (77.0) Height: 6 1/16 (154.0) I.Gskt: [1] Included</p> 	<p>BF9828-D Primary Fuel/Water Separator Element with Removable Drain Notes: Reverse Flow Fits: JCB Loaders Replaces: J.C. Bamford 32/925915; Stanadyne 38461 O.D.: 3 7/32 (81.8) I.D.: 1/2 (12.7) One End Height: 5 9/32 (134.1) Grommets: [1] Attached</p> 
<p>BF9822-D Fuel/Water Coalescer Element with Removable Drain Notes: Reverse Flow Fits: J.C. Bamford Generators, Super Loaders Replaces: J.C. Bamford 32/925975; Stanadyne 38695 O.D.: 3 7/32 (81.8) I.D.: 1/2 (12.7) One End Height: 5 9/32 (134.1) Grommets: [1] Attached</p> 	<p>PF9829 KIT Set of 2 Fuel Elements Contains: Primary and Secondary Elements - not sold separately Fits: 10/07-on Scania P230, P280, P320, P360, P400, R400, R440, R480 Trucks all with Scania DC9, DC13 Series Engine Replaces: Scania 1736248, 1736250, 1794863 Primary O.D.: 3 5/16 (84.1) I.D.: 1 1/2 (38.1) Height: 8 15/16 (227.0) O-Ring: [2] Included Secondary O.D. 3 3/4 (95.3) I.D. 1 13/16 (46.0) Height 8 5/32 (207.2)</p> 
<p>PF9823 Fuel Element with Bail Handle Replaces: Parker China Division C0607; Weichai Power 13022685 O.D.: 2 17/32 (64.3) I.D.: 1/2 (12.7) Height: 3 (76.2)</p> 	

Measurements Are Shown In Inches And (Millimeters)

WARNING: These products can expose you to chemicals, including Diisononyl Phthalate, Carbon black extracts, Nickel, 1,3 Butadiene, Ethylene Oxide, Epichlorohydrin, which are known to the State of California to cause cancer, and Bisphenol, Ethylene Glycol, Ethylene Oxide, 1,3 Butadiene, Epichlorohydrin, which are known to the State of California to cause birth defects or other reproductive harm. For more information go to www.P65Warnings.ca.gov.

<p>BF9830-D</p> 	<p>Fuel/Water Coalescer with Drain Fits: J.C. Bamford Generators, Lift Trucks, Loaders all with Dieselmex (Tier2) 444 Engine Replaces: J.C. Bamford 32/925705; Donaldson P551426 O.D.: 3 7/32 (81.8) I.D.: 7/8 (22.2) One End Height: 5 9/32 (134.1) Grommets: [1] Attached</p>	<p>BF9837-D</p> 	<p>Primary Fuel Element with Drain Notes: Reverse Flow Fits: Agco, Challenger, Massey Ferguson, Valtra Tractors all with Sisu 4.4L, 6.6L, 7.4L, 8.4L Diesel Engines Replaces: Agco V836862600; Case 162000080882; Sisu 836862600; Valtra 20366575 O.D.: 3 9/32 (83.3) I.D.: 21/32 (16.7) One End Height: 6 25/32 (172.2) Grommets: [1] Attached</p>
<p>BF9831</p> 	<p>Fuel/Water Separator Spin-on with Drain Notes: OBSOLETE. Availability Limited to Dealer Stock. Contains: Integral Post Seal Replaces: Parker China Division WBF1212; Foton Lovol 1106339100104; Weifang Hualing Diesel Power 1125AD-5705 Thread: 1 -14 O.D.: 3 19/32 (91.3) Height: 7 7/8 (200.0) I.Gskt: [1] Included</p>	<p>BF9839-D</p> 	<p>Primary Fuel Element with Drain Notes: Reverse Flow Fits: Agco, Challenger, Massey Ferguson, Valtra Equipment all with Sisu 6.6L, 7.4L, 8.4L Engines Replaces: Agco V836867591; Sisu 836867591 O.D.: 3 3/16 (81.0) I.D.: 3/4 (19.0) One End Height: 6 23/32 (170.7) Grommets: [1] Attached</p>
<p>BF9833-D</p> 	<p>Primary Fuel Element with Drain Fits: J.C. Bamford Excavators Replaces: J.C. Bamford 32/925760; Stanadyne 37932 O.D.: 3 7/32 (81.8) I.D.: 7/8 (22.2) One End Height: 6 1/16 (154.0) Grommets: [1] Attached</p>	<p>BF9841</p> 	<p>Fuel Spin-on Replaces: Parker China Division CX0710A; Faw-Xichai K1117001A; Weichai Power K1117001A Thread: M16 x 1.5 O.D.: 3 1/32 (77.0) Height: 4 13/16 (122.2) I.Gskt: [1] Included</p>
<p>BF9834</p> 	<p>Fuel Spin-on Fits: E.M.D. Marine Engines Replaces: Clark Filters FJ-33S; E.M.D. 40052587 Thread: 1 1/4 -12 O.D.: 3 11/16 (93.7) Height: 8 23/32 (221.5) I.Gskt: G381-A</p>	<p>BF9842</p> 	<p>Fuel Spin-on with Drain Fits: Foton Trucks Replaces: Foton Lovol 1106611400005, T64101003; Parker China Division WBF1235 Thread: M16 x 1.5 O.D.: 3 1/16 (77.8) Height: 5 25/32 (146.8) I.Gskt: [1] Included</p>
<p>BF9835-D</p> 	<p>Secondary Fuel Element with Drain Fits: Magnum Light Towers Replaces: Magnum Products 17647 O.D.: 3 3/16 (81.0) I.D.: 5/8 (15.9) One End Height: 5 9/32 (134.1)</p>	<p>BF9844</p> 	<p>Fuel Spin-on Replaces: Yuchai Watyuan G58001105140C Thread: 1 -14 O.D.: 4 9/32 (108.7) Height: 8 1/32 (204.0) I.Gskt: [1] Included</p>
<p>BF9836-D</p> 	<p>Secondary Fuel Element with Drain Fits: J.C. Bamford Excavators Replaces: J.C. Bamford 32/925666; Mitsubishi D07-0015; Stanadyne 37130 O.D.: 3 7/32 (81.8) I.D.: 1/2 (12.7) One End Height: 4 17/32 (115.1) Grommets: [1] Attached</p>	<p>BF9846</p> 	<p>In-Line Fuel Filter Fits: Mercedes-Benz Automotive, Engines, Vans Replaces: Chrysler 5174056AA; Mercedes-Benz 6460920001, 6460920301, 6460920501 O.D.: 3 5/8 (92.1) Inlet: 7/16 Outlet: 3/8 Length: 4 29/32 (124.6)</p>

Measurements Are Shown In Inches And (Millimeters)

WARNING: These products can expose you to chemicals, including Diisononyl Phthalate, Carbon black extracts, Nickel, 1,3 Butadiene, Ethylene Oxide, Epichlorohydrin, which are known to the State of California to cause cancer, and Bisphenol, Ethylene Glycol, Ethylene Oxide, 1,3 Butadiene, Epichlorohydrin, which are known to the State of California to cause birth defects or other reproductive harm. For more information go to www.P65Warnings.ca.gov.

BF9847-D Secondary Fuel Element with Drain
Fits: John Deere Equipment
Replaces: John Deere RE533026; Donaldson P551432
O.D.: 3 3/16 (81.0)
I.D.: 1/2 (12.7) One End
Height: 6 1/16 (154.0)
Grommets: [1] Attached



BF9858 KIT Set of 2 Fuel Filters
Contains: Port Thread: 3 3/4-10
 [1] BF1390-O Spin-on with Open Port for Bowl
 [1] Element
 Not Sold Individually
Fits: IHC MaxxForce DT, MaxxForce 7 Engines, CD, RXT, 3200, 4300 DuraStar Trucks
Replaces: International 1848671-C1, 1876533-C93, 1877516-C1
BF1390-O
Thread: 1 -14
O.D.: 4 11/32 (110.3)
Height: 6 3/16 (157.2)
I.Gskt: [1] Included
O-Ring: [1] Included
Element:
O.D. 3 9/16
I.D. 17/32
Height 4 25/32
O-Ring [1] Included



BF9848 In-Line Fuel Filter
Contains: 3/8 Inch Return Line
Fits: 2005-07 Chevrolet Cobalt; 2005-06 Pontiac Pursuit, 2010 G5; 2003-07 Saturn ION, 2004-07 ION Red Line
Replaces: Saturn 22734980; ACDelco GF824
O.D.: 2 5/32 (54.8)
Inlet: 5/16
Outlet: 5/16
Length: 4 29/32 (124.6)



BF9860 Fuel Spin-on
Notes: Fill Plug pre-installed in filter. Remove plug after pre-filling filter with fuel prior to installation on application.
Fits: Peterbilt 386 Truck; Cummins QSX15 Engine
Replaces: Cummins 3685306; Fleetguard FF5686
Thread: M90 x 2.0
O.D.: 4 23/32 (119.9)
Height: 11 9/16 (293.7)
I.Gskt: [1] Included
Related To: BF9885 (Short Version) BF46179 (Upgrade)



BF9850 Fuel Spin-on
Contains: Port for Drain/Sensor Bowl
 Port Thread: M36 x 1.5
Replaces: Weichai Power CX0812; Parker China Division CX0812
Thread: M20 x 1.5
O.D.: 3 9/16 (90.5)
Height: 7 (177.8)
I.Gskt: [1] Included



BF9851 In-Line Fuel Filter
Contains: [2] 3/8 Inch Plastic Clips
 [1] 5/16 Inch Plastic Clip
 5/16 Inch Return Line
Fits: 1998-2001 Saturn SW1, SW2, 1998-2002 SC1, SL1, SC2, SL2, 2000-02 SL
Replaces: Saturn 21009427
O.D.: 2 11/32 (59.5)
Inlet: 3/8
Outlet: 3/8
Length: 8 15/32 (215.1)



PF9861 Fuel Element
Fits: Volkswagen Beetle, Golf, Jetta
Replaces: Volkswagen 1K0127434B
O.D.: 3 9/32 (83.3)
I.D.: 3/4 (19.0) One End
Height: 4 9/16 (115.9)
O-Ring: [1] Included
Grommets: [1] Attached



BF9852 Fuel Spin-on with Drain
Replaces: Weichai Power 612600080934; Parker China Division WBF1352
Thread: M20 x 1.5
O.D.: 3 19/32 (91.3)
Height: 7 7/8 (200.0)
I.Gskt: [1] Included



PF9862 Fuel/Water Separator Element
Fits: New Holland E70, E70SR, E80 Excavators
Replaces: Komatsu YM02P01039R100; New Holland YM02P01039R100, YM02P01039S002
O.D.: 1 7/8 (47.6)
 Flange 2 9/16 (65.1)
I.D.: 13/16 (20.6) One End
Height: 2 19/32 (65.9)
O-Ring: [1] Included
Grommets: [1] Attached



BF9857 In-Line Fuel Filter
Fits: John Deere Lawn and Garden Tractors, Utility Vehicles
Replaces: John Deere AM117584, AM118131
O.D.: 3 5/16 (84.1)
Inlet: 3/8
Outlet: 3/8
Length: 6 15/16 (176.2)



BF9863 In-Line Fuel Filter
Fits: Volvo Excavators
Replaces: Volvo 7410170
O.D.: 3 7/16 (87.3)
Inlet: 1/8
Outlet: 3/16
Length: 3 19/32 (91.3)



Measurements Are Shown In Inches And (Millimeters)

WARNING: These products can expose you to chemicals, including Diisononyl Phthalate, Carbon black extracts, Nickel, 1,3 Butadiene, Ethylene Oxide, Epichlorohydrin, which are known to the State of California to cause cancer, and Bisphenol, Ethylene Glycol, Ethylene Oxide, 1,3 Butadiene, Epichlorohydrin, which are known to the State of California to cause birth defects or other reproductive harm. For more information go to www.P65Warnings.ca.gov.

BF9864 Fuel Spin-on
Contains: Integral Post Seal
Replaces: Jinan Diesel B30121010; Parker China Division BF596A
Thread: 1 1/2 -12
O.D.: 4 21/32 (118.3)
Height: 11 5/16 (287.3)
I.Gskt: [1] Included



BF9869 Fuel Spin-on with Drain
Replaces: Yuchai Watyuan 1501105020A; Donaldson P502484
Thread: 1 -14
O.D.: 4 9/32 (108.7)
Height: 7 1/8 (181.0)
I.Gskt: [1] Included



PF9865 Fuel Element
Fits: Iveco Trucks
Replaces: Iveco 504170771
O.D.: 3 3/16 (81.0)
I.D.: 1/2 (12.7) One End
Height: 5 27/32 (148.4)
O-Ring: [1] Included



PF9870 Fuel Element with Bail Handle
Fits: Dodge Pickups, 4500, 5500 Chassis Cabs; Ram Pickups, 4500HD, 5500HD Chassis Cabs all with 6-408 (6.7L) FI Turbo Diesel Engine
Replaces: Chrysler 68065608AA; Cummins 4947561; Mopar MO608
O.D.: 4 7/32 (107.2)
I.D.: 1 9/16 (39.7) One End
Height: 5 17/32 (140.5)
O-Ring: [1] Included



BF9866-O Fuel/Water Separator Spin-on with Open End for Bowl
Contains: Bowl Thread: M95 x 2.5 Integral Post Seal
Fits: John Deere Equipment
Replaces: John Deere RE532952, RE539465
Thread: 7/8 -14
O.D.: 4 3/8 (111.1)
Height: 8 11/16 (220.7)
A. Gskt: [1] Included
F. Gskt: [1] Included



BF9871-O Fuel/Water Separator Spin-on with Open End for Bowl
Contains: Bowl Thread: 3 3/4-10 2B Buttress Integral Post Seal
Fits: Freightliner, Sterling, Western Star Trucks
Replaces: Alliance ABPN122BR90FRT10; Freightliner BR90FRT10, RAIBR90FRT10; Donaldson P551066
Thread: 1 -14
O.D.: 4 5/16 (109.5)
Height: 6 5/16 (160.3)
A. Gskt: [1] Included
O-Ring: [1] Included



BF9867-O Fuel Spin-on with Open End for Bowl
Contains: Bowl Thread: M95 x 2.5 Integral Post Seal
Fits: Evobus Citaro Buses; Mercedes-Benz, Renault Trucks; Bomag Paving Equipment
Replaces: Bomag 05825015; Renault 7420754418
Thread: 1 -14
O.D.: 4 13/32 (111.9)
Height: 8 21/32 (219.9)
A. Gskt: [1] Included
O-Ring: [1] Included



PF9872 Fuel Element
Fits: Volkswagen Jetta, Beetle, Golf
Replaces: Volkswagen 1K0127434A
O.D.: 3 1/4 (82.6)
I.D.: 1 1/2 (38.1)
Height: 5 19/32 (142.1)
F. Gskt: [1] Aluminum Washer, [2] Included
O-Ring: [2] Attached



PF9868 Fuel Element
Fits: Case, Link-Belt Excavators
Replaces: New Holland KHH12030
O.D.: 3 23/32 (94.5)
I.D.: 1 1/32 (26.2) One End
Height: 6 13/32 (162.7)
O-Ring: [2] Included
Grommets: [1] Attached
Related To: PF7983 (Without Furnished O-Rings)



PF9873 Fuel Strainer
Fits: Doosan, Hitachi, John Deere, Kobelco, New Holland Excavators
Replaces: Hitachi 8972133810; John Deere 8972133810
O.D.: 1 7/16 (36.5)
I.D.: 15/32 (11.9) One End
Height: 1 15/16 (49.2)
O-Ring: [1] Attached, [1] Included



Measurements Are Shown In Inches And (Millimeters)

WARNING: These products can expose you to chemicals, including Diisononyl Phthalate, Carbon black extracts, Nickel, 1,3 Butadiene, Ethylene Oxide, Epichlorohydrin, which are known to the State of California to cause cancer, and Bisphenol, Ethylene Glycol, Ethylene Oxide, 1,3 Butadiene, Epichlorohydrin, which are known to the State of California to cause birth defects or other reproductive harm. For more information go to www.P65Warnings.ca.gov.

BF9874-DM Primary Fuel/Water Separator Element
Contains: Drain Nut
Fits: John Deere Power Tech 4045DFM, 4045TFM Marine Engines
Replaces: John Deere RE521248; Stanadyne 36559
O.D.: 3 5/32 (80.2)
I.D.: 15/16 (23.8) One End
Height: 5 5/16 (134.9)
F. Gskt: [1] Included
Grommets: [1] Attached



BF9880 Fuel Spin-on with Open Port
Contains: Port Thread: M36 x 1.5
Fits: Yuchai Diesel YC6G240-30 Truck Engine
Replaces: Yuchai Watyuan G58001105240C
Thread: 1 -14
O.D.: 4 11/32 (110.3)
Height: 9 11/16 (246.1)
I.Gskt: [1] Included
F. Gskt: [1] Included



BF9875-DM Secondary Fuel/Water Separator Element
Contains: Drain Nut
Fits: John Deere Power Tech 4045DFM, 4045TFM Marine Engines
Replaces: John Deere RE520842; Stanadyne 36503
O.D.: 3 5/32 (80.2)
I.D.: 15/16 (23.8) One End
Height: 5 5/16 (134.9)
F. Gskt: [1] Included
Grommets: [1] Attached



BF9881 In-Line Fuel Filter with Drain
Fits: J.C. Bamford Engines, Rollers, Telescopic Handlers
Replaces: J.C. Bamford 32007138
O.D.: 3 3/8 (85.7)
Inlet: 3/8
Outlet: 3/8
Length: 7 5/32 (181.8)



BF9876 Fuel Spin-on with Drain
Replaces: Yuchai Watyuan A30001105020
Thread: M14 x 1.5
O.D.: 3 1/4 (82.6)
Height: 6 21/32 (169.1)
I.Gskt: [1] Included



BF9883 Fuel Spin-on with Drain
Contains: Integral Post Seal
Fits: Case-IHC Farmall 65A, 65C, 75C, Workmaster 65 Tractors
Replaces: Iveco 504287000
Thread: M16 x 1.5
O.D.: 3 9/32 (83.3)
Height: 7 15/32 (189.7)
I.Gskt: [1] Included



BF9877 Fuel Spin-on
Fits: J.C. Bamford Excavators with Isuzu 4GB1T, 6BG1T or J.C. Bamford Dieselmax 444 Engines
Replaces: J.C. Bamford 32925856
Thread: 3/4 -16
O.D.: 3 11/16 (93.7)
Height: 4 11/32 (110.3)
I.Gskt: G381-A



BF9884 Nylon In-Line Fuel Filter in Plastic Housing
Fits: John Deere Tractors
Replaces: John Deere AL67975; Mann & Hummel WK3111
O.D.: 1 17/32 (38.9)
Inlet: 5/16
Outlet: 5/16
Length: 4 9/32 (108.7)



BF9878 Fuel Spin-on with Drain
Fits: DongFeng Trucks
Replaces: DongFeng-Cummins 1025BF11020; Parker China Division WPPA01101
Thread: M20 x 1.5
O.D.: 3 5/8 (92.1)
Height: 6 11/16 (169.9)
I.Gskt: [1] Included
F. Gskt: [1] Included



BF9885 Fuel Spin-on
Notes: Fill Plug pre-installed in filter. Remove after pre-filling filter with fuel prior to installation on application.
CAUTION: Not to be used on X15 Engines.
Fits: Kenworth, Peterbilt Trucks with Cummins ISX11.9, QSX11.9 Engines
Replaces: Cummins 2864993, 2893612; Donaldson P555776; Fleetguard FF5776; Mann WK12003
Thread: M90 x 2.0
O.D.: 4 23/32 (119.9)
Height: 8 27/32 (224.6)
I.Gskt: [1] Included
Related To: BF9860 (Long Version) BF46129 (Upgrade Version)



PF9879 Fuel Element
Fits: M.A.N. D28V V8-750, V10-900, V12-1100 Engines
Replaces: M.A.N. 51125030069; Hengst E420KPD72
O.D.: 3 9/32 (83.3)
I.D.: 1/2 (12.7) One End
Height: 10 15/32 (265.9)
O-Ring: [1] Included















BF9886 In-Line Fuel Filter
Fits: John Deere Loader, Tractors
Replaces: John Deere RE176732
O.D.: 1 29/32 (48.4)
Inlet: 9/16-18
Outlet: 9/16-18
Length: 3 7/8 (98.4)



Measurements Are Shown In Inches And (Millimeters)

WARNING: These products can expose you to chemicals, including Diisononyl Phthalate, Carbon black extracts, Nickel, 1,3 Butadiene, Ethylene Oxide, Epichlorohydrin, which are known to the State of California to cause cancer, and Bisphenol, Ethylene Glycol, Ethylene Oxide, 1,3 Butadiene, Epichlorohydrin, which are known to the State of California to cause birth defects or other reproductive harm. For more information go to www.P65Warnings.ca.gov.

<p>BF9887 Fuel Spin-on Contains: Integral Post Seal Fits: John Deere Equipment Replaces: John Deere MIU800645; Yanmar 11980255800, 11980255801 Thread: M20 x 1.5 O.D.: 3 11/16 (93.7) Height: 3 1/4 (82.6) I.Gskt: [1] Included</p> 	<p>BF9893 Fuel Spin-on Replaces: Thermo King 11-9954, 12-9954 Thread: M22 x 1.5 O.D.: 3 11/16 (93.7) Height: 4 3/8 (111.1) A. Gskt: G381-A</p> 
<p>BF9888 Fuel Spin-on Contains: Integral Post Seal Replaces: Clark FL-3WS0 Thread: 1 1/2 -12 O.D.: 4 21/32 (118.3) Height: 9 15/16 (252.4) I.Gskt: [1] Included</p> 	<p>BF9894 Fuel/Water Separator Spin-on Fits: Thermo King Refrigeration Units Replaces: Thermo King 11-8047, 11-9342, 12-9342; ACDelco TP1362 Thread: M22 x 1.5 O.D.: 3 11/16 (93.7) Height: 4 3/8 (111.1) A. Gskt: G381-A</p> 
<p>PF9889 Fuel Element Replaces: Hino S234011790 O.D.: 3 3/4 (95.3) I.D.: 1 1/16 (27.0) One End Height: 7 5/8 (193.7) I.Gskt: [1] Included O-Ring: [2] Included</p> 	<p>BF9895 KIT Set of 2 Fuel Elements Fits: Ford Super Duty Trucks with V8-406 (6.7L) FI Turbo Diesel Engine Replaces: Ford BC3Z-9N184-B; Motorcraft FD4615 Element O.D.: 4 (101.6) I.D.: 1 3/8 (34.9) One End Height: 5 1/4 (133.4) A. Gskt: [1] Attached O-Ring: [1] Included In-Line O.D. 3 15/16 I.D. Inlet: 1/2 (12.7) Height 4 9/32</p> 
<p>PF9890 Fuel Element Fits: Mitsubishi Trucks Replaces: Mitsubishi ME300361; Donaldson P502226 O.D.: 3 3/4 (95.3) I.D.: 1 1/16 (27.0) One End Height: 3 7/8 (98.4) I.Gskt: [1] Included O-Ring: [3] Included</p> 	<p>PF9897 Fuel Element Fits: Isuzu, Mitsubishi Trucks Replaces: General Motors 97726081; Isuzu 1132401940; Mitsubishi ME300647 O.D.: 3 3/4 (95.3) I.D.: 1 3/32 (27.8) One End Height: 3 7/8 (98.4) O-Ring: [1] Attached, [3] Included</p> 
<p>BF9891-D Primary Fuel Element with Drain Notes: Reverse Flow Fits: John Deere Engines, Equipment Replaces: John Deere RE541922 O.D.: 3 3/16 (81.0) I.D.: 9/16 (14.3) One End Height: 7 11/16 (195.3) Grommets: [1] Attached</p> 	<p>BF9898-O Fuel/Water Separator Spin-on with Open End for Bowl Contains: Bowl Thread: M95 x 2.5 Integral Post Seal Fits: Freightliner Cascadia, FLD, Business Class M2 Trucks Replaces: Alliance ABPN/122R-50418; Fleetguard FS19593 Thread: 1 -14 O.D.: 4 1/4 (108.0) Height: 6 5/16 (160.3) A. Gskt: [1] Included F. Gskt: [1] Included</p> 
<p>BF9892-D Secondary Fuel Element with Drain Fits: John Deere Engines, Equipment Replaces: John Deere RE544394 O.D.: 3 3/16 (81.0) I.D.: 9/16 (14.3) One End Height: 6 1/16 (154.0)</p> 	<p>PF9899 Fuel Element Replaces: Hino S234011800 O.D.: 3 17/32 (89.7) I.D.: 3/4 (19.0) Height: 5 3/8 (136.5) O-Ring: [2] Included Grommets: [2] Attached</p> 

Measurements Are Shown In Inches And (Millimeters)

WARNING: These products can expose you to chemicals, including Diisononyl Phthalate, Carbon black extracts, Nickel, 1,3 Butadiene, Ethylene Oxide, Epichlorohydrin, which are known to the State of California to cause cancer, and Bisphenol, Ethylene Glycol, Ethylene Oxide, 1,3 Butadiene, Epichlorohydrin, which are known to the State of California to cause birth defects or other reproductive harm. For more information go to www.P65Warnings.ca.gov.

PF9901 KIT Fuel Filter Kit
Contains: [1] Fuel Filter
 [1] Strainer
Fits: Freightliner Trucks
Replaces: Freightliner A0000902751
Element
O.D.: 2 13/32 (61.1)
I.D.: 17/32 (13.5) One End
Height: 5 9/16 (141.3)
O-Ring: [2] Included
Strainer
O.D. 2 (50.8)
I.D. 17/32 (13.5)
Height 2 15/16 (74.6)



PF9907 In-Line Fuel Strainer with Housing
Fits: International CD, 3600 Buses, I530E Engine
Replaces: International 1817677C91; Fleetguard FF257
Strainer
O.D.: 23/32 (18.3)
I.D.: 5/8 (15.9) One End
Height: 3 1/8 (79.4)
O-Ring: [1] Included
Housing
O.D. 1 5/8 (41.3)
I.D. 1 1/32 (26.2)
Height 2 27/32 (72.2)



BF9903-SP Fuel/Water Separator Spin-on with Drain and Sensor Port
Notes: CAUTION: Furnished O-Ring must be installed on Post for Seal
Contains: Standpipe
 Sensor Port Thread: 9/16-18
Fits: Caterpillar Equipment; Kenworth, Western Star Trucks
Replaces: Caterpillar 3261641; Fleetguard FS19968
Thread: 1 -14
O.D.: 4 1/4 (108.0)
Height: 9 7/32 (234.2)
I.Gskt: [1] Included
O-Ring: [2] Included



PF9908 KIT Fuel Filter Kit
Notes: Previously provided lubricant is no longer necessary with this KIT. All internal seals are pre-lubed.
Contains: [1] Fuel Filter
 [1] Strainer
Fits: Freightliner, Western Star Trucks with Detroit Diesel DD13, DD15, DD16 Engines
Replaces: Detroit Diesel A4700903151, A4720900451, A4720900551
Element
O.D.: 4 19/32 (116.7)
I.D.: 1 9/16 (39.7)
Height: 10 (254.0)
O-Ring: [2] Included
Strainer
O.D. 2 11/32 (59.5)
I.D. 1 9/16 (39.7)
Height 3 1/16 (77.8)



BF9904 Fuel Spin-on with Drain
Fits: Nissan Trucks
Replaces: Nissan 16400BN303, 164037F40a, 164037F400, 164037F401
Thread: 3/4 -16
O.D.: 3 3/4 (95.3)
Height: 6 9/32 (159.5)
I.Gskt: [1] Included



BF9910 Fuel Spin-on
Contains: Integral Post Seal
Fits: Cummins QSB3.3 (Tier 4) Engines; Dynapac Rollers; Komatsu Engines, Excavators; Skytrak Telehandlers
Replaces: Cummins 4942437, 4946635; Komatsu 600-311-3530, 600-319-3530
Thread: M22 x 1.5
O.D.: 3 3/32 (78.6)
Height: 5 1/2 (139.7)
I.Gskt: [1] Included



BF9905 In-Line Fuel Filter
Fits: Case, New Holland Loaders
Replaces: Case 87019604, 87548612; New Holland 87548612
O.D.: 1 29/32 (48.4)
Inlet: 3/8
Outlet: 3/8
Length: 5 5/8 (142.9)



PF9911 Fuel Element
Fits: Kubota Tractors, Utility Vehicles
Replaces: Kubota 6A32059930
O.D.: 1 13/16 (46.0)
I.D.: 1/32 (0.8) One End
Height: 2 1/8 (54.0)
O-Ring: [1] Included



BF9906 In-Line Fuel Filter
Fits: Kobelco, Komatsu, Yanmar Equipment
Replaces: Kobelco VV12905255630; New Holland YJ21P01008P2; Yanmar 12905255630
O.D.: 2 9/16 (65.1)
Inlet: 11/32
Outlet: 11/32
Length: 3 7/32 (81.8)



Measurements Are Shown In Inches And (Millimeters)

WARNING: These products can expose you to chemicals, including Diisononyl Phthalate, Carbon black extracts, Nickel, 1,3 Butadiene, Ethylene Oxide, Epichlorohydrin, which are known to the State of California to cause cancer, and Bisphenol, Ethylene Glycol, Ethylene Oxide, 1,3 Butadiene, Epichlorohydrin, which are known to the State of California to cause birth defects or other reproductive harm. For more information go to www.P65Warnings.ca.gov.

BF9912-O Fuel/Water Separator Spin-on with Open End for Bowl
Contains: Bowl Thread: 3 3/4-10 Buttress Integral Post Seal
Replaces: Atlas Copco 2914809200; Fleetguard FS19775
Thread: 1 -14
O.D.: 4 1/4 (108.0)
Height: 3 15/32 (88.1)
A. Gskt: [1] Included
F. Gskt: [1] Included



BF9917 High Efficiency Fuel Spin-on
Contains: Integral Post Seal
Fits: John Deere Equipment
Replaces: John Deere RE533910
Thread: 1 -14
O.D.: 4 11/32 (110.3)
Height: 9 1/4 (235.0)
I.Gskt: [1] Included



BF9913 Fuel Spin-on
Contains: Water Absorbent Media
Replaces: Cim-Tek 70067, CT70067; Fleetguard FS19748
Thread: 1 -12
O.D.: 3 11/16 (93.7)
Height: 8 23/32 (221.5)
I.Gskt: [1] Included



BF9918 KIT Set of 2 Fuel Filters
Notes: Port Thread: M36 x 1.5
Contains: [1] BF46062
 [1] Element, not sold separately
Fits: Chevrolet Express Vans, GMC Savana Vans, all with V8-400 (6.6L) Turbo Diesel Engine
Replaces: General Motors 19149845; ACDelco TP3013, TP1537; Baldwin BF7933 KIT
BF46062
Thread: 3 3/8 -8 UN Buttress
O.D.: 4 1/32 (102.4)
I.D.: 1 5/8 (41.3)
Height: 6 1/2 (165.1)
O-Ring: [2] Included
Grommets: [1] Attached
Element
O.D. 3 11/16 (93.7)
I.D. 1 5/8 (41.3)
Height 3 15/16 (100.0)



PF9914 KIT Set of 2 Fuel Elements
Fits: International TerraStar, 4300 Trucks with MaxxForce 7 (6.4L) Engine
Replaces: International 1884207C91, 1884207C92; Racor R33286
Primary
O.D.: 3 5/8 (92.1)
I.D.: 1 11/16 (42.9) One End
Height: 6 9/16 (166.7)
O-Ring: [1] Attached, [1] Included
Secondary
O.D. 3 11/32
I.D. 9/16
Height 6 3/16
O-Ring [1] Attached, [1] Included



PF9919 Fuel Element
Fits: Chevrolet, GMC, Isuzu Trucks
Replaces: General Motors 98037011; Isuzu 8982035990, 8981628970, 8980370110
O.D.: 3 25/32 (96.0)
I.D.: 15/32 (11.9) One End
Height: 4 9/16 (115.9)
A. Gskt: [1] Attached
O-Ring: [1] Included
Grommets: [1] Attached



BF9915 Can-Type Fuel Element
Fits: Caterpillar, Gehl, Manitou, Massey Ferguson, Merlo Equipment
Replaces: Caterpillar 2526338; Massey Ferguson 4225526M1; Perkins 26550005
O.D.: 3 7/16 (87.3)
I.D.: 3/4 (19.0) & 1 7/16 (36.5)
Height: 2 13/16 (71.4)
F. Gskt: [3] Included
O-Ring: [2] Included



BF9920 Fuel/Water Separator Spin-on with Drain
Fits: Case-IH, New Holland Tractors; Wirtgen Paving Equipment
Replaces: Case 84477362, 87366406, 87395356; New Holland 84477362, 87366406, 87395356
Thread: M85 x 2.0
O.D.: 4 11/16 (119.1)
Height: 11 1/8 (282.6)
I.Gskt: [1] Included



BF9916 Wire Mesh In-Line Fuel Strainer
Fits: John Deere Compact Track Loaders, Skid Steer Loaders
Replaces: John Deere T257865
O.D.: 1 29/32 (48.4)
Inlet: 5/16
Outlet: 5/16
Length: 3 29/32 (99.2)



BF9921-O Fuel/Water Separator Spin-on with Open End for Bowl
Contains: Pre-Fill Cup
 Integral Post Seal
 Bowl Thread: M95 x 2.5
Fits: John Deere Industrial, Marine Engines
Replaces: John Deere RE503676
Thread: 1 -14
O.D.: 4 1/4 (108.0)
Height: 8 21/32 (219.9)
A. Gskt: [1] Included
F. Gskt: [1] Included
Grommets: [1] Attached



Measurements Are Shown In Inches And (Millimeters)

WARNING: These products can expose you to chemicals, including Diisononyl Phthalate, Carbon black extracts, Nickel, 1,3 Butadiene, Ethylene Oxide, Epichlorohydrin, which are known to the State of California to cause cancer, and Bisphenol, Ethylene Glycol, Ethylene Oxide, 1,3 Butadiene, Epichlorohydrin, which are known to the State of California to cause birth defects or other reproductive harm. For more information go to www.P65Warnings.ca.gov.

BF9922-O Fuel/Water Separator Spin-on with Open End for Bowl



Notes: Inside-Out Flow Direction
Contains: Bowl Thread: M80 x 2.5
 Integral Post Seal
Fits: Mercedes-Benz Latin America Buses, Trucks
Replaces: Mercedes-Benz A3820927005; Racor R20P
Thread: 1 -14
O.D.: 3 21/32 (92.9)
Height: 4 1/8 (104.8)
A. Gskt: [1] Included
O-Ring: [1] Included
Related To: BF46021-O, BF46022-O (Micron Difference)

PF9928 Fuel/Water Separator Element



Fits: Kenworth, Peterbilt Trucks with Cummins ISL, ISX, Paccar MX, MX-13 Engines
Replaces: Paccar K371004
O.D.: 4 1/8 (104.8)
Height: 7 1/2 (190.5)
O-Ring: [1] Included
Grommets: [1] Attached

BF9923-O Fuel Spin-on with Threaded Port



Contains: Port Thread: 1 1/4-10
Fits: Atlas Copco, Bomag Equipment; Dynapac Rollers; Komatsu Excavators
Replaces: Cummins 4941237; Komatsu 600-319-4110
Thread: M24 x 1.5
O.D.: 3 3/4 (95.3)
Height: 5 1/4 (133.4)
A. Gskt: [1] Included
O-Ring: [1] Included

PF9929 Fuel/Water Separator Element



Fits: Kenworth, Peterbilt Trucks with Paccar MX-13 Engine
Replaces: Paccar K371009
O.D.: 4 1/8 (104.8)
Height: 7 1/2 (190.5)
F. Gskt: [1] Included
Grommets: [1] Attached

PF9924 KIT Fuel Filter Kit



Notes: Parts Not Sold Separately
Fits: Detroit Diesel DD13 (12.8L), DD15 (14.8L), DD16 (15.6L) Engines; Freightliner, Sterling, Western Star Trucks
Replaces: Detroit Diesel A0000904251
Coalescer
O.D.: 4 3/16 (106.4)
Height: 9 11/32 (237.3)
O-Ring: [3] Included
Final Filter
O.D.: 2 5/8 (66.7)
Height: 7 5/32 (181.8)

PA10000 Panel Air Element



Fits: Mitsubishi Lancer, Outlander Sport
Replaces: Mitsubishi 1500A513
Length: 10 5/32 (258.0)
Width: 8 3/16 (208.0)
Height: 2 3/32 (53.2)

BF9925-O Fuel/Water Separator Spin-on with Open End for Bowl



Contains: Bowl Thread: M95 x 2.5
Replaces: Racor S6464; Donaldson P551034; Fleetguard FS19538
Thread: 1 -14
O.D.: 4 1/4 (108.0)
Height: 6 5/16 (160.3)
F. Gskt: [2] Included

PA10001 Panel Air Element

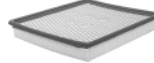

Fits: Cadillac XTS; Chevrolet Impala
Replaces: General Motors 22753242
Length: 11 5/16 (287.3)
Width: 10 (254.0)
Height: 1 25/32 (45.2)

BF9927 High Efficiency Fuel Spin-on



Fits: Kenworth, Peterbilt Trucks with Paccar MX Engines
Replaces: Paccar 1655115; Donaldson P551004; Fleetguard FF252
Thread: 1 -14
O.D.: 3 23/32 (94.5)
Height: 8 7/32 (208.8)
I.Gskt: G401

PA10002 Cabin Air Element

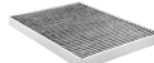

Contains: Charcoal Impregnated Media for Odor Control
Fits: Buick, Chevrolet, GMC, Saturn Automotive, Light-Duty Trucks
Replaces: ACDelco CF179C
Length: 9 9/32 (235.7)
Width: 6 25/32 (172.2)
Height: 23/32 (18.3)

PA10003 Panel Air Element

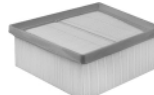

Fits: Ford Fiesta
Replaces: Ford CN1Z9601A; Motorcraft FA1914
Length: 7 3/4 (196.9)
Width: 6 5/16 (160.3)
Height: 2 3/4 (69.9)

PA10004 Panel Air Element

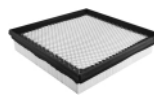

Fits: Chrysler 200, Dodge Avenger, Journey
Replaces: Chrysler 68081249AC
Length: 9 7/32 (234.2)
Width: 8 15/16 (227.0)
Height: 1 13/16 (46.0)







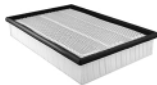

Measurements Are Shown In Inches And (Millimeters)

WARNING: These products can expose you to chemicals, including Diisononyl Phthalate, Carbon black extracts, Nickel, 1,3 Butadiene, Ethylene Oxide, Epichlorohydrin, which are known to the State of California to cause cancer, and Bisphenol, Ethylene Glycol, Ethylene Oxide, 1,3 Butadiene, Epichlorohydrin, which are known to the State of California to cause birth defects or other reproductive harm. For more information go to www.P65Warnings.ca.gov.

<p>RS10005</p> 	<p>Radial Seal Air Element Fits: Dodge Caliber; Jeep Compass, Patriot Replaces: Chrysler 4593914AB O.D.: 5 11/32 (135.7) I.D.: 3 5/32 (80.2) One End Height: 6 15/16 (176.2)</p>	<p>PA10014</p>  <p>Cabin Air Element Fits: Chevrolet Colorado; GMC Canyon Replaces: General Motors 23135671; ACDelco CF196 Length: 9 7/16 (239.7) Width: 8 (203.2) Height: 1 3/16 (30.2)</p>
<p>PA10006</p> 	<p>Panel Air Element with Foam Pad Fits: Chrysler 200 with V6-220 (3.6L) FI Engine Replaces: Chrysler 6824545AA Length: 11 15/16 (303.2) Width: 7 1/8 (181.0) Height: 1 7/8 (47.6)</p>	<p>PA10015</p>  <p>Panel Air Element Fits: Chevrolet Colorado, GMC Canyon Replaces: General Motors 94775933; ACDelco A3195C Length: 10 11/16 (271.5) Width: 10 3/32 (256.4) Height: 1 9/16 (39.7)</p>
<p>PA10007</p> 	<p>Panel Air Element with Foam Pad Fits: Renault Kangoo Vans Replaces: Renault 7701477208 Length: 14 31/32 (380.2) Width: 3 9/32 (83.3) Height: 2 5/16 (58.7)</p>	<p>PA10016</p>  <p>Cabin Air Element Notes: Single filter version of the PA4460 KIT Requires 2 filters per application. Fits: Jeep Wrangler Replaces: Chrysler 68233626AA Length: 5 27/32 (148.4) Width: 5 27/32 (148.4) Height: 25/32 (19.8)</p>
<p>PA10008</p> 	<p>Panel Air Element Fits: Nissan Rogue Replaces: Nissan 165464BA1A Length: 9 31/32 (253.2) Width: 6 25/32 (172.2) Height: 1 13/32 (35.7) A. Gskt: [1] Attached</p>	<p>PA10017</p>  <p>Cabin Air Element Fits: Ram ProMaster 1500, ProMaster 2500, ProMaster 3500 Vans Replaces: Chrysler 68169308AA Length: 9 15/16 (252.4) to 11 31/32 (304.0) Width: 8 21/32 (219.9) Height: 1/2 (12.7)</p>
<p>PA10009</p> 	<p>Cabin Air Element Fits: Chrysler 200; Jeep Cherokee Replaces: Chrysler 68223044AA Length: 9 9/32 (235.7) Width: 8 19/32 (218.3) Height: 25/32 (19.8) A. Gskt: [2] Attached</p>	<p>PA10018</p>  <p>Cabin Air Element Contains: Charcoal Impregnated Media for Odor Control Fits: Audi, Porsche, Volkswagen Automotive Replaces: Volkswagen 7H0819631A; Porsche 95557221910 Length: 10 29/32 (277.0) Width: 8 5/8 (219.1) Height: 1 11/32 (34.1) Related To: PA10034 (without Charcoal)</p>
<p>PA10010</p> 	<p>Panel Air Element Fits: 2010 Renault Megane with 4-1998cc (2.0L) Engine Replaces: Renault 820371661 Length: 9 9/16 (242.9) Width: 5 9/32 (134.1) to 7 15/32 (189.7) Height: 2 3/16 (55.6)</p>	<p>PA10020</p>  <p>Cabin Air Element with Lift Tab Fits: 1996-2001 Volkswagen Eurovan Replaces: Volkswagen 7D0819989 O.D.: 7 13/32 (188.1) I.D.: 4 11/32 (110.3) One End Height: 4 1/32 (102.4)</p>
<p>PA10011</p> 	<p>Foam Air Pre-Cleaner Contains: Flame Retardant Media Fits: Ford Super Duty Pickups with V8-406 (6.7L) FI Turbo Diesel Engine Replaces: Motorcraft FA1909 Length: 7 3/8 (187.3) Width: 6 3/8 (161.9) Height: 3 1/4 (82.6)</p>	<p>RS10021</p>  <p>Radial Seal Air Element Fits: Ram ProMaster 1500, Promaster 2500, ProMaster 3500 Vans with V6-220 (3.6L) FI Engine Replaces: Ram 4861865AA, 52022424AA O.D.: 6 17/32 (165.9) I.D.: 4 1/2 (114.3) One End Height: 12 3/8 (314.3)</p>
<p>PA10012</p> 	<p>Panel Air Element with Foam Pad Fits: Opel Movano A 3.0 CDTI; Renault Master III 3.0 DCI European Light-Duty Vehicles Replaces: Renault 8200488878, 8200283082; Nissan 1654600Q0G, 1654600QAM; Opel 4415430, 4417325, 93190266, 93181231 Length: 14 5/32 (359.6) Width: 10 3/8 (263.5) Height: 2 1/8 (54.0)</p>	

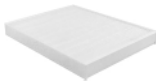









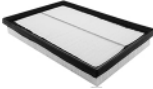



Measurements Are Shown In Inches And (Millimeters)

WARNING: These products can expose you to chemicals, including Diisononyl Phthalate, Carbon black extracts, Nickel, 1,3 Butadiene, Ethylene Oxide, Epichlorohydrin, which are known to the State of California to cause cancer, and Bisphenol, Ethylene Glycol, Ethylene Oxide, 1,3 Butadiene, Epichlorohydrin, which are known to the State of California to cause birth defects or other reproductive harm. For more information go to www.P65Warnings.ca.gov.

<p>PA10022 Panel Air Element Fits: Ram Light-Duty Trucks with V6-182 (3.0L) FI Turbo Diesel, V8-392 (6.4L) FI Engines Replaces: Chrysler 68190705AA Length: 13 7/8 (352.4) Width: 9 3/8 (238.1) Height: 2 9/32 (57.9)</p> 	<p>PA10031 Cabin Air Element Fits: Infiniti JX35, QX60; Nissan Altima, Murano, Pathfinder Replaces: Nissan 272773JC1A Length: 11 1/16 (281.0) Width: 9 21/32 (245.3) Height: 3/4 (19.0)</p> 
<p>PA10023 Panel Air Element Fits: Nissan Altima Replaces: Nissan 165463TA0A Length: 11 3/8 (288.9) Width: 11 3/8 (288.9) Height: 1 3/32 (27.8) A. Gskt: [1] Included</p> 	<p>PA10032 Cabin Air Element Fits: Mazda CX5, Mazda 3, Mazda 6 Replaces: Mazda KD4561J6X Length: 8 7/8 (225.4) Width: 7 3/4 (196.9) Height: 13/16 (20.6) A. Gskt: [1] Included</p> 
<p>PA10024 Panel Air Element Fits: Acura TLX, Honda Accord with 4-2356cc (2.4L) Engine Replaces: Honda 172205A2A00 Length: 12 1/16 (306.4) Width: 7 5/8 (193.7) Height: 2 9/32 (57.9) A. Gskt: [1] Included</p> 	<p>PA10033 Panel Air Element Contains: Flame Retardant Media Fits: Ford Mustang Replaces: Ford FR3Z-9601-A; Motorcraft FA1918 Length: 11 3/16 (284.2) Width: 10 3/16 (258.8) Height: 2 9/32 (57.9)</p> 
<p>PA10025 Panel Air Element Fits: Mazda Automotive Replaces: Mazda PE07133A0A Length: 10 21/32 (270.7) Width: 7 1/16 (179.4) Height: 1 5/16 (33.3) A. Gskt: [1] Included</p> 	<p>PA10034 Cabin Air Element Fits: Audi, Porsche, Volkswagen Automotive Replaces: Volkswagen 7H0819631 Length: 10 29/32 (277.0) Width: 8 5/8 (219.1) Height: 1 11/32 (34.1) Related To: PA10018 (Charcoal Version)</p> 
<p>PA10026 Panel Air Element Fits: Honda Odyssey Replaces: Honda 17220-RV0A00 Length: 11 29/32 (302.4) Width: 6 23/32 (170.7) Height: 2 3/32 (53.2) A. Gskt: [1] Included</p> 	<p>RS10035 Radial Seal Air Element Fits: Ford Rangers; Mazda, Toyota Light-Duty Trucks Replaces: Toyota 178010C010, 178010C01000, 178010C020; Donaldson P902609; Fleetguard AF26501 O.D.: 8 1/2 (215.9) I.D.: 4 5/8 (117.5) One End Height: 6 3/4 (171.5)</p> 
<p>PA10027 Panel Air Element Fits: Hyundai Tucson; Kia Sportage Replaces: Hyundai 28113-2S000; Kia 28113-2S000 Length: 10 5/32 (258.0) Width: 6 13/32 (162.7) Height: 1 7/8 (47.6)</p> 	<p>PA10036 Cabin Air Element Contains: Charcoal Impregnated Media for Odor Control Fits: Mercedes-Benz Automotive Replaces: Mercedes-Benz 2468300018, A2468300018 Length: 10 3/32 (256.4) Width: 10 1/32 (254.8) Height: 1 3/4 (44.4)</p> 
<p>PA10028 Panel Air Element Fits: Lexus CT200h; Toyota Prius Replaces: Toyota 17801-37020 Length: 8 3/4 (222.3) Width: 7 3/8 (187.3) Height: 1 13/32 (35.7)</p> 	<p>PA10038 Panel Air Element Fits: Chevrolet Spark Replaces: General Motors 96910360 Length: 11 13/32 (289.7) Width: 6 1/8 (155.6) Height: 1 1/8 (28.6) A. Gskt: [1] Included</p> 
<p>PA10030 Cabin Air Element Fits: Chrysler Town & Country, Dodge Grand Caravan, Ram Cargo Vans Replaces: Chrysler 68127809AA Length: 8 15/16 (227.0) Width: 7 7/8 (200.0) Height: 1 3/16 (30.2)</p> 	<p>PA10039 Panel Air Element Fits: Chevrolet Sonic Replaces: General Motors 96950990 Length: 9 17/32 (242.1) Width: 6 25/32 (172.2) Height: 1 31/32 (50.0)</p> 

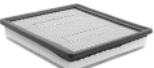
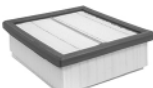

Measurements Are Shown In Inches And (Millimeters)

WARNING: These products can expose you to chemicals, including Diisononyl Phthalate, Carbon black extracts, Nickel, 1,3 Butadiene, Ethylene Oxide, Epichlorohydrin, which are known to the State of California to cause cancer, and Bisphenol, Ethylene Glycol, Ethylene Oxide, 1,3 Butadiene, Epichlorohydrin, which are known to the State of California to cause birth defects or other reproductive harm. For more information go to www.P65Warnings.ca.gov.

<p>PA10040</p> 	<p>Panel Air Element Fits: Lexus, Toyota Automotive Replaces: Toyota 17801-38010 Length: 10 5/8 (269.9) Width: 7 3/32 (180.2) Height: 1 3/8 (34.9)</p>	<p>PA10058</p>  <p>Panel Air Element Fits: Acura, Honda Automotive, Light-Duty Trucks Replaces: Honda 172205J6A10 Length: 11 9/16 (293.7) Width: 6 1/2 (165.1) Height: 1 7/8 (47.6) A. Gskt: [1] Included</p>
<p>PA10041</p> 	<p>Cabin Air Element Fits: Subaru Impreza, Forester, Outback Sport, WRX, WRX Sti Replaces: Subaru 72880FG000, 72880FG0009P Length: 9 3/16 (233.4) Width: 8 13/16 (223.8) Height: 2 1/4 (57.2) A. Gskt: [1] Included</p>	<p>PA10059</p>  <p>Panel Air Element Fits: 2016-20 Honda Civic Replaces: Honda 172205BAA00; Wix WA10416 Length: 9 1/4 (235.2) Width: 7 3/16 (182.6) Height: 1 13/16 (45.7) A. Gskt: [1] Included</p>
<p>PA10042</p> 	<p>Cabin Air Element Fits: Hyundai Santa Fe; Kia Sorento Replaces: Hyundai 1UF79AQ000, 2BF79AQ000, 971331U000 Length: 10 5/16 (261.9) Width: 8 7/32 (208.8) Height: 1 3/16 (30.2)</p>	<p>PA10060</p>  <p>Panel Air Element Fits: Chevrolet Caprice, SS; Pontiac G8 Replaces: General Motors 92066873 Length: 12 31/32 (329.4) Width: 6 (152.4) to 9 15/32 (240.5) Height: 2 1/32 (51.6)</p>
<p>PA10043</p> 	<p>Cabin Air Element Fits: Chrysler 300, Dodge Challenger, Charger Replaces: Chrysler 68071668AA Length: 10 7/8 (276.2) Width: 7 7/8 (200.0) Height: 1 3/16 (30.2)</p>	<p>PA10061</p>  <p>Oval Air Element with Foam Notes: O.D. Includes Foam Fits: Ford Super-Duty Trucks with (6.7L) Engines Replaces: Ford HC3Z9601A; Motorcraft FA1927 O.D.: 8 1/16 (204.8) to 11 1/32 (280.2) I.D.: 3 23/32 (94.5) & 6 11/16 (169.9) to Height: 9 9/16 (242.9) Related To: PA10068 (w/o attached foam)</p>
<p>PA10044</p> 	<p>Panel Air Element with Pull Tabs Fits: Hyundai Sonata; Kia Optima Replaces: Hyundai 28113C1100, 28113D3300 Length: 10 29/32 (277.0) Width: 7 27/32 (199.2) Height: 1 11/16 (42.9)</p>	<p>PA10062</p>  <p>Air Element with Foam Wrap Contains: Sensor Port Fits: Chevrolet Cruze Replaces: General Motors 39030321; ACDelco A3220C O.D.: 5 21/32 (143.7) to 6 7/32 (158.0) Height: 6 13/16 (173.0)</p>
<p>PA10045</p> 	<p>Panel Air Element with Foam Pad Fits: Toyota Sequoia, Tacoma, Tundra Replaces: Toyota 178010S020, 178010P100 Length: 11 25/32 (299.2) Width: 10 7/32 (259.6) Height: 2 9/16 (65.1)</p>	<p>PA10063</p>  <p>Panel Air Element with Foam Pad Fits: 2016-19 Chevrolet Colorado, 2016-19 GMC Canyon with 2.8L Turbo Diesel Engine Replaces: General Motors Corp. 23248945; ACDelco A3216C; Wix WA10427 Length: 10 23/32 (272.0) Width: 10 1/32 (255.0) Height: 1 7/8 (48)</p>
<p>PA10046</p> 	<p>Panel Air Element with Foam Pad Fits: Jeep Renegade; Ram ProMaster City; Fiat 500X Replaces: Chrysler 68247339AA, K68247339AA; Fiat 51977574 Length: 8 3/16 (208.0) Width: 7 13/32 (188.1) Height: 2 17/32 (64.3)</p>	<p>PA10064</p>  <p>Panel Air Element Fits: Honda HR-V with (1.8L) Engine Replaces: Honda 1722051BH00 Length: 9 (228.6) Width: 8 19/32 (218.3) Height: 1 15/16 (49.2) A. Gskt: [1] Included</p>
<p>PA10047</p> 	<p>Panel Air Element Fits: Honda CRV with (2.4L) Engines Replaces: Honda 172205LAA00 Length: 11 1/8 (282.6) Width: 7 1/2 (190.5) Height: 2 (50.8) A. Gskt: [1] Included</p>	<p>PA10057</p>  <p>Panel Air Element Fits: Honda Civic, CR-V Replaces: Honda 172205AAA00 Length: 9 11/16 (246.1) Width: 5 5/8 (142.9) Height: 2 5/16 (58.7) A. Gskt: [1] Included</p>



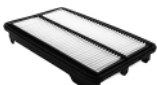
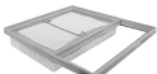







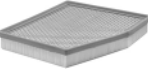
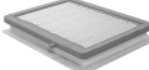

Measurements Are Shown In Inches And (Millimeters)

WARNING: These products can expose you to chemicals, including Diisononyl Phthalate, Carbon black extracts, Nickel, 1,3 Butadiene, Ethylene Oxide, Epichlorohydrin, which are known to the State of California to cause cancer, and Bisphenol, Ethylene Glycol, Ethylene Oxide, 1,3 Butadiene, Epichlorohydrin, which are known to the State of California to cause birth defects or other reproductive harm. For more information go to www.P65Warnings.ca.gov.

<p>PA10066 Panel Air Element  Fits: Kia Soul, Soul EV Replaces: Kia 97133B2000 Length: 8 1/4 (209.6) Width: 6 15/32 (164.3) Height: 1 (25.4)</p>	<p>PA10075 Panel Air Element with Foam Pad  Fits: 2016-20 BMW X1, 2018-20 X2; 2015-19 Mini Cooper, 2016-19 Cooper Clubman, 2017-20 Cooper Countryman Replaces: BMW (Bavarian Motor Works) 13718513944; Hastings Premium Filters AF1728; Wix WA9792 Length: 11 3/8 (289.1) Width: 10 27/32 (275.1) Height: 2 9/32 (57.9)</p>
<p>PA10067 Cabin Air Element  Contains: Charcoal Impregnated Media for Odor Control. Fits: Kia Sorento Replaces: Kia C6C79AC000 Length: 10 9/32 (261.1) Width: 7 29/32 (200.8) Height: 1 3/16 (30.2)</p>	<p>PA10076 Panel Air Element  Fits: 2018-20 Buick Enclave; 2017-20 Cadillac XT5; 2019-20 Chevrolet Blazer, 2018-20 Traverse; 2017-20 GMC Acadia Replaces: General Motors Corp. 23321606; Wix WA10718 Length: 14 1/8 (359.2) Width: 10 7/32 (259.8) Height: 1 23/32 (43.7)</p>
<p>PA10068 Oval Air Element  Fits: Ford Super Duty Trucks with (6.2L), (6.8L) Engines Replaces: Ford HC3Z9601B; Motorcraft FA1928 O.D.: 6 29/32 (175.4) to 9 7/8 (250.8) I.D.: 3 23/32 (94.5) & 6 11/16 (169.9) Height: 9 9/16 (242.9) Related To: PA10061 (w/attached foam)</p>	<p>PA10077 Panel Air Element with Foam Pad  Fits: 2016-19 Chevrolet Malibu; 2017-19 Buick LaCrosse Replaces: General Motors 23430312; ACDelco A3208C Length: 13 3/4 (349.3) Width: 9 3/32 (231.0) Height: 1 21/32 (42.1)</p>
<p>PA10069 Panel Air Element  Fits: 2015-19 Acura TLX, 2013-17 Honda Accord Replaces: Honda 172205J2A00, 172205G0A00 Length: 12 5/32 (308.6) Width: 7 7/16 (189.0) Height: 1 17/32 (38.6) A. Gskt: [1] Included</p>	<p>PA10078 Panel Air Element  Fits: 2016-19 Chevrolet Volt Replaces: ACDelco A3217C Length: 11 15/32 (291.1) Width: 8 7/8 (225) Height: 1 1/4 (32)</p>
<p>PA10070 Panel Air Element  Fits: Ford C-Max, Fusion, Lincoln MKZ all with 4-122 (2.0L) FI Hybrid Engine Replaces: Ford DG9Z-9601-A; Motorcraft FA1911 Length: 9 1/4 (235.0) Width: 8 1/8 (206.4) Height: 1 5/8 (41.3)</p>	<p>PA10080 Panel Air Element with Pull Tabs  Fits: 2017-20 Hyundai Santa Fe, 2017-18 Santa Fe Sport, 2020 Palisade; 2015-20 Kia Sedona, 2016-20 Sorento, 2020 Telluride Replaces: Hyundai 28113A9100; Kia 28113A9100; Luber-finer AF5245; Wix WA10271 Length: 11 11/16 (296.9) Width: 8 1/2 (215.9) Height: 1 11/16 (42.9) A. Gskt: [1] Included</p>
<p>PA10071 Panel Air Element  Fits: Infiniti M35, M37, Q70 Replaces: Nissan 16546EJ70A Length: 8 3/16 (208.0) Width: 6 31/32 (177.0) Height: 1 3/4 (44.4) A. Gskt: [1] Included</p>	<p>PA10081 Cabin Air Element  Fits: 2017-18 Hyundai Elantra, 2018-19 Elantra GT; 2018-19 Kia Rio Replaces: Hyundai 97133F2000 Length: 9 3/8 (238.0) Width: 7 11/16 (195.1) Height: 1 1/16 (26.9)</p>
<p>PA10072 Panel Air Element  Fits: Acura RDX Replaces: Honda 17220R8AA01 Length: 11 15/16 (303.2) Width: 7 29/32 (200.8) Height: 1 5/8 (41.3) A. Gskt: [1] Included</p>	<p>PA10082 Cabin Air Element  Fits: 2014-18 Nissan Versa, 2015-18 Versa Note, 2016-18 Tiida, 2017-18 Micra, 2017-19 Note Replaces: Nissan 272771KK0A, 272781KK0A Length: 8 13/16 (223.5) Width: 8 1/4 (210) Height: 25/32 (20)</p>
<p>PA10073 Panel Air Element  Fits: Acura MDX Replaces: Acura 172205J6A00 Length: 11 5/8 (295.3) Width: 6 7/8 (174.6) Height: 1 5/8 (41.3)</p>	

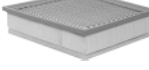
Measurements Are Shown In Inches And (Millimeters)

WARNING: These products can expose you to chemicals, including Diisononyl Phthalate, Carbon black extracts, Nickel, 1,3 Butadiene, Ethylene Oxide, Epichlorohydrin, which are known to the State of California to cause cancer, and Bisphenol, Ethylene Glycol, Ethylene Oxide, 1,3 Butadiene, Epichlorohydrin, which are known to the State of California to cause birth defects or other reproductive harm. For more information go to www.P65Warnings.ca.gov.

<p>PA10083 Cabin Air Element Fits: 2018 Fiat 500L, 2016-17 500X; 2015-17 Jeep Renegade Replaces: Chrysler 68267921AA; Fram CF11810; Luber-finer CAF1919C Length: 8 17/32 (217) Width: 6 3/16 (157) Height: 1 3/16 (30) Related To: PA10154 (without Charcoal)</p> 	<p>PA10090 Panel Air Element Fits: 2018-19 Honda Accord with 2.0L Turbo Engine Replaces: Honda 172206B2A00 Length: 8 7/16 (214.3) Width: 8 1/8 (206.4) Height: 1 29/32 (48.4) A. Gskt: [1] Included</p> 
<p>PA10084 Panel Air Element Fits: 2017-19 Chrysler Pacifica with (3.6L) Engine Replaces: Chrysler 68214516AA Length: 9 3/4 (247.9) Width: 9 3/8 (238.0) Height: 1 9/16 (39.9)</p> 	<p>PA10091 Panel Air Element with Foam and Pull Tab Fits: 2018-19 Chevrolet Equinox, GMC Terrain Replaces: ACDelco A3226C; General Motors Corp. 23279657 Length: 10 11/16 (271) Width: 8 13/32 (213) Height: 1 5/8 (41)</p> 
<p>PA10085 Cabin Air Element Fits: 2015-18 RAM ProMaster City Replaces: Chrysler 68103578AA; Citroen 6479-62; Fiat 77364561; Peugeot 6479-63 Length: 7 27/32 (199.5) Width: 7 (178) Height: 1 25/32 (45)</p> 	<p>PA10093 Panel Air Element with Foam Pad Fits: 2015-19 Ford Transit-150, Transit-250, Transit-350, Transit-350 HD Replaces: Motorcraft FA1916 Length: 10 27/32 (275.1) Width: 9 13/32 (239.0) Height: 2 7/8 (72.9)</p> 
<p>PA10086 Panel Air Element Fits: 2017-19 Hyundai Elantra, 2018-19 Elantra GT, Kona, 2019 Veloster; 2019 Kia Forte Replaces: Hyundai 28113F2000; Fram CA12057; Luber-finer AF5265; Wix WA10420 Length: 9 13/32 (239.0) Width: 6 3/8 (162.1) Height: 2 1/8 (53.6)</p> 	<p>PA10094 Panel Air Element Fits: 2017-19 Chevrolet Camaro Replaces: ACDelco A3223C; General Motors Corporation 23323508 Length: 11 31/32 (304.0) Width: 10 7/16 (264.9) Height: 3 (51.1)</p> 
<p>PA10087 Panel Air Element Fits: 2018-19 Nissan Titan Replaces: Nissan 16546EZ31A Length: 11 9/16 (293.8) Width: 10 (254) Height: 1 17/32 (38.5) A. Gskt: [1] Included</p> 	<p>PA10095 Panel Air Element with Foam Pad Fits: 2017-19 Chevrolet Silverado 2500 HD, Silverado 3500 HD; GMC Sierra 2500 HD, Sierra 3500 HD Replaces: ACDelco A3231C, A3257C; GM General Motors 84262965; Wix WA10695 Length: 11 1/32 (279.9) Width: 10 29/32 (277.1) Height: 2 27/32 (71.9)</p> 
<p>PA10088 Panel Air Element Fits: 2017-19 Honda CR-V, 2018 Clarity Replaces: Honda 172205PHA00; Wix WA10675 Length: 10 7/8 (276.1) Width: 7 11/32 (186.4) Height: 1 15/16 (49.5) A. Gskt: [1] Included</p> 	<p>PA10096 Panel Air Element Fits: 2016-19 Nissan Titan XD Replaces: Nissan 16546EZ40A Length: 12 19/32 (320.0) Width: 8 3/4 (222.0) Height: 2 9/32 (57.9)</p> 
<p>PA10089 Panel Air Element Fits: 2015-19 Audi A3 2015-18 Quattro, S3 2016 Audi TT 2016-19 Audi TT Quattro 2015 Volkswagen Golf 2015-17 Volkswagen Golf R 2015-16 Volkswagen GTI 2018 Volkswagen Tiguan Limited Volkswagen European Light-Duty Vehicles, Golf MK7 1.6, Golf MK7 2.0 Replaces: Volkswagen 5Q0129620B, 5Q0129620D Length: 11 1/2 (292.1) Width: 6 31/32 (177.0) Height: 2 3/4 (70.1)</p> 	<p>PA10097 Cabin Air Element Contains: Charcoal Impregnated Media for Odor Control Fits: 2019 Lexus ES300h, 2019 ES350, 2016-19 RX350, 2018-19 RX350L, 2017-19 RX450h; 2019 Toyota Avalon, 2018-19 Camry, 2019 C-HR, 2017 Prius, 2017-18 Prius Prime Replaces: Toyota 871390E040, 8713958010, 871390K070 Length: 8 15/32 (215) Width: 7 9/32 (185) Height: 1 5/32 (29)</p> 

Measurements Are Shown In Inches And (Millimeters)

WARNING: These products can expose you to chemicals, including Diisononyl Phthalate, Carbon black extracts, Nickel, 1,3 Butadiene, Ethylene Oxide, Epichlorohydrin, which are known to the State of California to cause cancer, and Bisphenol, Ethylene Glycol, Ethylene Oxide, 1,3 Butadiene, Epichlorohydrin, which are known to the State of California to cause birth defects or other reproductive harm. For more information go to www.P65Warnings.ca.gov.

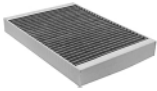
PA10098 Cabin Air Element

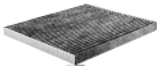
Contains: Charcoal Impregnated Media for Odor Control
Fits: 2017-19 Volvo S90, 2019 V60, 2018-19 V90, 2017-19 V90 Cross Country, 2018-19 XC60, 2019-19 XC90
Replaces: Alco Filters MS-6518C; Mann+Hummel CUK34003; Volvo 31407748
Length: 13 3/16 (335.0)
Width: 9 3/8 (238)
Height: 1 9/16 (39.9)

PA10099 Cabin Air Element

Contains: Charcoal Impregnated Media for Odor Control
Fits: 2018-19 Infiniti QX60, Nissan Maxima, Murano, Pathfinder; 2018 Nissan Altima. (07/19/19)
Replaces: Nissan 272779NM0A; Wix WP10009
Length: 10 31/32 (278.9)
Width: 9 9/16 (243.1)
Height: 25/32 (19.6)

SA10100 Foam Air Filter

Fits: 2015-19 Ford Transit with 5-195 (3.2L) Engine
Replaces: Ford Motor Co. CK4Z9601C; Motorcraft FA1921
Length: 6 1/2 (165.1)
Width: 2 1/4 (57.2)
Height: 3 1/8 (79.5)

PA10101 Panel Air Element with Foam Pad

Fits: 2018-19 Volkswagen Atlas with 2.0L and 3.6L Engines
Replaces: Volkswagen 3QF129620; Luber-finer AF3623; Wix WA10778
Length: 12 5/8 (321.1)
Width: 6 11/16 (169.9)
Height: 2 15/32 (63)

PA10102 Panel Air Element

Fits: 2016-18 Volkswagen Golf SportWagen, 2016-19 GTI, 2017-18 Volkswagen Golf, Golf Alltrack, 2018 Golf R
Replaces: Volkswagen 5QM129620
Length: 11 15/32 (291.1)
Width: 6 15/16 (176.0)
Height: 2 5/8 (67.1)

PA10103 Cabin Air Element

Fits: Ford Light and Medium-Duty Trucks
Replaces: Ford Motor Co. FL3Z19N619A; Motorcraft FP79; Fram CF12150; Luber-finer CAF1953P; Wix WP10266
Length: 10 5/32 (258.1)
Width: 8 1/16 (205.0)
Height: 1 9/16 (39.9)

PA10104 Cabin Air Element

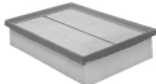
Fits: 2013-14 Ford Mustang
Replaces: Ford Motor Co. DR3Z19N619A; Motorcraft FP72
Length: 8 1/32 (204.0)
Width: 7 1/8 (181.1)
Height: 15/16 (23.9)

PA10106 Panel Air Element

Contains: [4] Supports
Fits: 2017-19 Kia Niro, Hyundai Ioniq
Replaces: Hyundai 28113G2700; Kia 28113G2100; Wix WA10770
Length: 13 19/32 (344.9)
Width: 10 3/16 (259.1)
Height: 2 9/16 (65)
A. Gskt: [1] Included

PA10107 Panel Air Element

Fits: 2017-21 Lexus RX450h, 2018-21 RX450hL; 2017-19 Toyota Highlander
Replaces: Toyota 178010P090; Fram CA12378; Luber-finer AF5270; Wix WA10716
Length: 10 7/16 (264.9)
Width: 7 11/32 (186.4)
Height: 2 9/32 (57.9)

PA10108 Cabin Air Element

Fits: 2019 Toyota Corolla, 2017-19 Prius, 2017-18 Prius Prime, 2019 Prius AWD-e, 2019 RAV 4
Replaces: Toyota 8713928020; Fram CF12157; Luber-finer CAF1950P; Mann & Hummel CU22032; Wix WP10320
Length: 8 1/2 (215.9)
Width: 7 3/8 (186.9)
Height: 1 1/8 (29)













PA10109 Air Element

Contains: [1] Tube of Lubricant
Fits: Audi Automotive
Replaces: Audi 8K0133843; Mann & Hummel C16114X; WIX 49143
O.D.: 7 11/32 (186.5)
I.D.: 4 (101.6) One End
Height: 6 19/32 (167.5)
O-Ring: [1] Included

PA10110 Air Element

Contains: [1] Tube of Lubricant
Fits: Audi A6, A6 Quattro
Replaces: Audi 4F0133843; Mann & Hummel C171371X; Wix 49846
O.D.: 6 17/32 (165.9)
I.D.: 1 1/8 (28.6) & 3 1/4 (82.6)
Height: 6 3/16 (157.2)
I.Gskt: [1] Included
O-Ring: [1] Included

PA10111 Air Element with Foam Wrap

Fits: Audi Automotive
Replaces: Volkswagen 4G0133843; Mann & Hummel C16005; WIX 49243
O.D.: 3 11/32 (84.9)
I.D.: 1 1/8 (28.6) & 3 17/32 (89.7)
Height: 7 3/8 (187.3)

Measurements Are Shown In Inches And (Millimeters)

WARNING: These products can expose you to chemicals, including Diisononyl Phthalate, Carbon black extracts, Nickel, 1,3 Butadiene, Ethylene Oxide, Epichlorohydrin, which are known to the State of California to cause cancer, and Bisphenol, Ethylene Glycol, Ethylene Oxide, 1,3 Butadiene, Epichlorohydrin, which are known to the State of California to cause birth defects or other reproductive harm. For more information go to www.P65Warnings.ca.gov.

<p>PA10112 Air Element Fits: Mercedes-Benz Automotive Replaces: Mercedes-Benz 120943702; WIX 42194 O.D.: 11 29/32 (302.4) I.D.: 8 19/32 (218.3) Height: 4 7/32 (107.2)</p> 	<p>PA10118 Conical-Shaped Air Element with Handle Fits: Honda S2000 Replaces: Honda 17220-PCX-003; WIX 42726 O.D.: 3 25/32 (96.0) to 7 5/16 (185.7) Inlet: 3 7/16 Height: 10 11/32 (262.7)</p> 
<p>PA10113 Air Element Fits: 2015 Audi A1; 2009-10 Seat Altea, Leon; 2015 Volkswagen Caddy, 2012-15 Jetta. (06/14/19) Replaces: VAG (Volkswagen/Audi Group) 3C0129620; Volkswagen 1F0129620; Wix 49013 O.D.: 5 13/32 (137.3) I.D.: 2 5/8 (66.8) One End Height: 8 11/16 (220.7)</p> 	<p>PA10119 Air Element Fits: Audi A8 Quattro Replaces: Audi 4E0129620; WIX 49620 O.D.: 5 31/32 (151.6) I.D.: 3 13/32 (86.5) Height: 7 1/4 (184.2)</p> 
<p>PA10114 Air Element Fits: Mercedes-Benz E320 Replaces: Mercedes-Benz 6460940104, A6460940104; WIX 49405 O.D.: 4 23/32 (119.9) I.D.: 2 (50.8) One End Height: 17 1/16 (433.4)</p> 	<p>PA10120 Oblong Air Element Fits: Mercedes-Benz 260, 300 Series Replaces: Mercedes-Benz 20948704; Wix 42174 O.D.: 12 11/32 (313.5) to 15 27/32 (402.4) I.D.: 9 1/4 (235.0) & 12 3/4 (323.8) to Height: 3 9/32 (83.3)</p> 
<p>PA10115 Air Element Fits: Saab Automotive Replaces: Saab 7514722; Wix 46329, 42320 O.D.: 5 31/32 (151.6) I.D.: 3 1/2 (88.9) Height: 9 9/32 (235.7)</p> 	<p>PA10121 Oval Air Element with Foam Wrap Fits: Land Rover Range Rover Replaces: Land Rover PHE000050; Mann & Hummel C18161; Wix 42892 O.D.: 5 11/32 (135.7) to 7 1/16 (179.4) I.D.: 4 13/32 (68.3) & 4 15/32 (111.9) One End Height: 9 3/8 (238.1)</p> 
<p>PA10116 Oblong Air Element Fits: Mercedes-Benz Automotive Replaces: Mercedes-Benz 10947804; WIX 46050 O.D.: 15 3/8 (390.5) I.D.: 11 17/32 (292.9) Height: 3 5/32 (80.2)</p> 	<p>PA10122 Air Element Fits: Porsche 911 Replaces: Porsche 99711013030, 99711013031; WIX 49330 O.D.: 6 3/8 (161.9) 4 5/8 (117.5) I.D.: 4 31/32 (126.2) & 3 1/4 (82.6) Height: 6 21/32 (169.1)</p> 
<p>PA10117 Air Element with Foam Wrap Fits: Audi A6, A6 Quattro Replaces: Volkswagen 4G0133843K; WIX 49343 O.D.: 6 5/32 (156.4) I.D.: 17/32 (13.5) & 3 3/32 (78.6) Height: 4 13/16 (122.2)</p> 	<p>PA10123 Air Element Fits: 1999- 2000 Saab 9-3, 1999-2009 9-5 Replaces: Saab 4572491, 5173166, 55560911; Wix 42830 O.D.: 6 29/32 (175.8) I.D.: 3 23/32 (94.5) Height: 5 15/32 (138.9) A. Gskt: [2] Included</p> 

Measurements Are Shown In Inches And (Millimeters)

WARNING: These products can expose you to chemicals, including Diisononyl Phthalate, Carbon black extracts, Nickel, 1,3 Butadiene, Ethylene Oxide, Epichlorohydrin, which are known to the State of California to cause cancer, and Bisphenol, Ethylene Glycol, Ethylene Oxide, 1,3 Butadiene, Epichlorohydrin, which are known to the State of California to cause birth defects or other reproductive harm. For more information go to www.P65Warnings.ca.gov.

PA10124 Oblong Cabin Air Element
Contains: Charcoal Impregnated Media for Odor Control
Fits: Audi A8 Quattro, S8
Replaces: Volkswagen 4E0819439A; WIX 49361
Length: 15 31/32 (405.6)
Width: 8 13/16 (223.8)
Height: 2 19/32 (65.9)



PA10125 Oval Air Element
Contains: Center Band
Fits: Porsche Boxster, Cayman
Replaces: Porsche 98711013300; WIX 49015
O.D.: 3 9/32 (83.3)
to 7 11/16 (195.3)
I.D.: 6 1/16 (47.6) & 6 1/16 (154.0) One End
Height: 12 15/32 (316.7)



PA10126 Air Element
Fits: Audi A8 Quattro, S8
Replaces: Audi 4E0129620D; Volkswagen 4E0129620D; WIX 49241
O.D.: 5 31/32 (151.6)
I.D.: 3 13/32 (86.5)
Height: 6 3/32 (154.8)



SA10127 Crankcase Breather Element
Fits: Ford Automotive, Light-Duty Trucks
Replaces: Ford B2TZ-6A631-A; WIX 42841, CW6841
O.D.: 2 7/32 (56.4)
I.D.: 1 13/32 (35.7)
Height: 1 13/16 (46)
F. Gskt: [1] Included



PA10128 Cabin Air Element
Fits: 2015-19 Hyundai Sonata
Replaces: Hyundai C2H79AP000, 97133C2000; Wix WP10155
Length: 8 29/32 (226.1)
Width: 7 11/16 (195.1)
Height: 1 3/16 (30)



PA10129 Cabin Air Element
Fits: 2019 Acura RDX; 2016-19 Honda Civic, HRV, 2017-19 CR-V, 2011-15 CR-Z, 2009-19 Fit, 2010-19 Insight, 2018-19 Odyssey
Replaces: Honda 80292TBAA11, 80292-TF0-G01, 80291TF0G01, 80291TF0E01, 80291T5RA01
Length: 8 7/32 (209.0)
Width: 8 1/32 (204.0)
Height: 1 3/16 (30)



PA10130 Cabin Air Element
Contains: Charcoal Impregnated Media for Odor Control
Fits: Buick, Cadillac, Chevrolet Automotive
Replaces: General Motors Corp. 13271191; Wix 24590, 24191
Length: 9 7/16 (239.7)
Width: 7 15/16 (201.6)
Height: 1 1/8 (28.6)

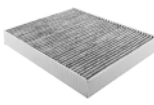

PA10131 Cabin Air Element
Fits: Hyundai Ioniq, Tucson
Replaces: Hyundai 87902E250A, 971332E250; WIX 24761
Length: 9 13/32 (238.9)
Width: 7 7/16 (188.9)
Height: 25/32 (19.8)



PA10132 Cabin Air Element
Contains: Charcoal Impregnated Media for Odor Control
Fits: 2016-19 Lexus GS F, 2017 GS Turbo, RC Turbo, 2016-17 GS200t, IS200t, RC200t, 2018 GS300, 2013-19 GS350, 2013-18 GS450h, 2017 IS Turbo, 2014-15 IS250, 2016-19 IS300, RC300, 2014-19 IS350, 2015-19 RC F, RC350
Replaces: Toyota 8713930100; Wix WP10099
Length: 8 3/4 (222.2)
Width: 8 (203.2)
Height: 1 5/32 (29.2)

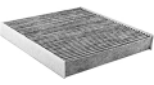

PA10133 Cabin Air Element
Fits: Ford Fusion, Lincoln MKZ, Mercury Milan
Replaces: Ford AE5Z-19N619-A; Motorcraft FP67; Wix 24367
Length: 10 1/2 (266.7)
Width: 8 5/16 (211.1)
Height: 1 1/2 (38.1)



PA10134 Cabin Air Element
Contains: Charcoal Impregnated Media for Odor Control
Fits: BMW Automotive
Replaces: BMW (Bavarian Motor Works) 64119237554, 64119237555; Wix 24255
Length: 9 3/4 (247.7)
Width: 7 13/16 (198.4)
Height: 1 9/16 (39.7)
A. Gskt: [2] Included



PA10135 Cabin Air Element
Fits: 2015-19 Ford Mustang
Replaces: Ford Motor FR3Z19N619A; Motorcraft FP78
Length: 10 1/8 (257.0)
Width: 7 29/32 (200.7)
Height: 1 3/16 (30)



PA10136 Cabin Air Element
Fits: Mazda CX-7
Replaces: Mazda EG2-16-1P11; WIX 24579
Length: 8 1/2 (215.9)
Width: 7 3/4 (196.9)
Height: 31/32 (24.6)













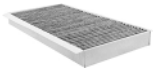

PA10137 Cabin Air Element
Fits: Nissan Automotive
Replaces: Nissan 999M1VS007; WIX 49352
Length: 10 13/32 (264.3)
Width: 7 15/32 (189.7)
Height: 25/32 (19.8)

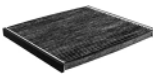

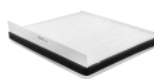
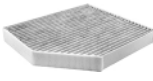
Measurements Are Shown In Inches And (Millimeters)

WARNING: These products can expose you to chemicals, including Diisononyl Phthalate, Carbon black extracts, Nickel, 1,3 Butadiene, Ethylene Oxide, Epichlorohydrin, which are known to the State of California to cause cancer, and Bisphenol, Ethylene Glycol, Ethylene Oxide, 1,3 Butadiene, Epichlorohydrin, which are known to the State of California to cause birth defects or other reproductive harm. For more information go to www.P65Warnings.ca.gov.

<p>PA10138 Cabin Air Element Contains: Charcoal Impregnated Media for Odor Control Fits: Audi A6 Quattro, A7 Quattro, A8 Quattro, S7, S8 Replaces: Volkswagen 4H0819439; WIX 24439 Length: 10 1/16 (255.6) Width: 9 31/32 (253.2) Height: 1 3/8 (34.9)</p> 	<p>PA10144 Cabin Air Element Fits: Ford GT, Mustang Replaces: Ford 4R3Z-19N619-AA; Motorcraft FP53; WIX 24687 Length: 8 1/32 (204.0) Width: 7 3/32 (180.2) Height: 31/32 (24.6)</p> 
<p>PA10139 Cabin Air Element Fits: Hyundai Veracruz Replaces: Hyundai 87903J000A, 971333J00, 97133J000A, 97133J100; Mann & Hummel CU26001; WIX 24753 Length: 9 7/8 (250.8) Width: 7 7/8 (200.0) Height: 1 3/16 (30.2)</p> 	<p>PA10145 KIT Set of 2 Cabin Air Elements Notes: Uses 2 filters per application. Fits: Nissan Armada, Pathfinder Armada, Titan Replaces: Nissan 999M1VP055; WIX 24854 Length: 8 7/8 (225.4) Width: 3 31/32 (100.8) Height: 31/32 (24.6)</p> 
<p>PA10140 Cabin Air Element Contains: Charcoal Impregnated Media for Odor Control Fits: Saab 9-3, 9-3X Replaces: General Motors 93172129; Saab 93172129; WIX 24525 Length: 13 1/16 (331.8) Width: 7 19/32 (192.9) Height: 1 3/16 (30.2) Related To: PA10177 (without Charcoal)</p> 	<p>PA10146 Cabin Air Element Fits: Fiat 500 Replaces: Chrysler 68096453AA; WIX 24053 Length: 7 5/8 (193.7) Width: 7 13/32 (188.1) Height: 1 3/16 (30.2)</p> 
<p>PA10141 Cabin Air Element Contains: Charcoal Impregnated Media for Odor Control Fits: Lexus LS400; Toyota Highlander Replaces: Toyota 87139-50010, 87139-YZZ02; Wix 24481 Length: 9 5/16 (236.5) Width: 8 13/32 (213.5) Height: 11/16 (17.5) A. Gskt: [1] Included</p> 	<p>PA10147 Cabin Air Element Fits: Ford Fiesta, Ecosport Replaces: Ford BE8Z-19N-619A; WIX 24619 Length: 9 7/16 (239.7) Width: 7 15/32 (189.7) Height: 31/32 (24.6) A. Gskt: [2] Included</p> 
<p>PA10142 Cabin Air Element Fits: Ford Focus, Transit Connect, ZX2 Replaces: Ford XS4H-16N619-AB, XS4Z-19N619-AA, YS4Z-19N619-DB; Motorcraft FP32, FP38; WIX 24808, 524808 Length: 13 3/4 (349.3) Width: 8 21/32 (219.9) Height: 1 3/16 (30.2)</p> 	<p>PA10148 Cabin Air Element Fits: Hyundai Equus, Genesis Replaces: Hyundai 87903M000A, 971333M000; WIX 24300 Length: 9 31/32 (253.2) Width: 8 3/4 (222.3) Height: 1 3/16 (30.2) A. Gskt: [2] Included</p> 
<p>PA10143 Cabin Air Element Notes: Uses 2 filters per application. Contains: Charcoal Impregnated Media for Odor Control Fits: Audi Automotive; Porsche Macan Replaces: Audi 8K0819439A; WIX 24227 Length: 11 1/32 (280.2) Width: 10 (254.0) Height: 1 3/8 (34.9)</p> 	<p>PA10149 Cabin Air Element Fits: Mazda 6 Replaces: Mazda GS3L61148; Wix 24148 Length: 9 1/16 (230.2) Width: 7 25/32 (197.6) Height: 31/32 (24.6)</p> 
<p>PA10152 KIT Set of 2 Cabin Air Elements Notes: Uses 2 filters per application. Contains: Charcoal Impregnated Media for Odor Control Fits: Mercedes-Benz Automotive Replaces: Mercedes-Benz 1648300218, A164830021864; WIX 49376 Each Filter: Length: 9 29/32 (251.6) Width: 5 9/32 (134.1) Height: 1 17/32 (38.9)</p> 	<p>PA10150 Cabin Air Element Fits: Chrysler PT Cruiser Replaces: Chrysler 5058040AA, 82206886; WIX 24725 Length: 9 1/32 (229.4) Width: 4 17/32 (115.1) Height: 1 3/16 (30.2)</p> 

Measurements Are Shown In Inches And (Millimeters)

WARNING: These products can expose you to chemicals, including Diisononyl Phthalate, Carbon black extracts, Nickel, 1,3 Butadiene, Ethylene Oxide, Epichlorohydrin, which are known to the State of California to cause cancer, and Bisphenol, Ethylene Glycol, Ethylene Oxide, 1,3 Butadiene, Epichlorohydrin, which are known to the State of California to cause birth defects or other reproductive harm. For more information go to www.P65Warnings.ca.gov.

PA10153 Cabin Air Element
Fits: Volvo Automotive
Replaces: Volvo 9204626; WIX 24818, 524818
Length: 11 3/8 (288.9)
Width: 10 1/4 (260.3)
Height: 29/32 (23)
A. Gskt: [1] Attached
Related To: PA10200 (Charcoal Version)



PA10160 Cabin Air Element
Fits: Suzuki Grand Vitara
Replaces: Suzuki 9586164J01, 9586164J00; WIX 24200
Length: 10 5/8 (269.9)
Width: 7 13/16 (198.4)
Height: 7/8 (22.2)
A. Gskt: [1] Included



PA10154 Cabin Air Element
Fits: Fiat 500L
Replaces: Fiat 68212070AA; WIX WP10106
Length: 8 5/8 (219.1)
Width: 6 1/4 (158.8)
Height: 1 3/16 (30.2)
Related To: PA10083 (Charcoal Impregnated Media)



PA10161 Cabin Air Element
Contains: Charcoal Impregnated Media for Odor Control.
Fits: Cadillac STS, XLR; Chevrolet Corvette
Replaces: ACDelco CF131C; GM 10345066; Wix 24480
Length: 11 1/2 (292.1)
Width: 7 5/16 (185.7)
Height: 1 3/32 (27.8)
A. Gskt: [1] Attached

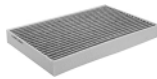

PA10155 Cabin Air Element
Fits: Kia Automotive
Replaces: Kia 97133-2F000, 97133-2F010; WIX 49353
Length: 9 7/16 (239.7)
Width: 8 1/4 (209.6)
Height: 21/32 (16.7)



PA10162 Cabin Air Element
Contains: Charcoal Impregnated Media for Odor Control.
Fits: Porsche Panamera
Replaces: Porsche 97057362300; WIX 24110
Length: 9 31/32 (253.2)
Width: 8 1/2 (215.9)
Height: 1 3/8 (34.9)



PA10156 Cabin Air Element
Contains: Charcoal Impregnated Media for Odor Control
Fits: Volvo Automotive
Replaces: Volvo 30676484, 30780377; WIX 49354
Length: 9 23/32 (246.9)
Width: 8 9/32 (210.3)
Height: 1 3/8 (34.9)
A. Gskt: [2] Included
Related To: PA10166 (without Charcoal)



PA10163 Cabin Air Element
Contains: Charcoal Impregnated Media for Odor Control
Fits: Nissan 370Z with (3.7L) Engine
Replaces: Nissan B72771EA0B, B72771EA0A; WIX 24099
Length: 8 17/32 (216.7)
Width: 7 7/8 (200.0)
Height: 25/32 (19.8)

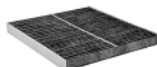

PA10157 Cabin Air Element
Fits: Scion FR-S
Replaces: Scion SU003032112; WIX 24212
Length: 7 1/4 (184.2)
Width: 7 1/16 (179.4)
Height: 1 5/32 (29.4)



PA10164 Cabin Air Element
Fits: Cadillac CTS, SRX, STS
Replaces: GMC 1562718, 25740404; WIX 24869, 524869
Length: 10 7/16 (265.1)
Width: 9 7/32 (234.2)
Height: 15/16 (23.8)
Related To: PA10201 (with Attached Gasket)



PA10158 Cabin Air Element
Contains: Charcoal Impregnated Media for Odor Control
Fits: Infiniti EX35, QX50, QX70
Replaces: Nissan B72771CA0A, B72771CA1A; WIX 24007
Length: 13 11/16 (347.7)
Width: 10 1/16 (255.6)
Height: 25/32 (19.8)



PA10165 Cabin Air Element
Fits: Suzuki Kizashi
Replaces: Suzuki 9586157L00; WIX 24120
Length: 9 21/32 (245.3)
Width: 8 1/2 (215.9)
Height: 13/16 (20.6)

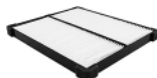

PA10159 Cabin Air Element
Fits: Kia Soul
Replaces: Kia 97133-2K000; WIX 24600
Length: 7 3/32 (180.2)
Width: 6 5/16 (160.3)
Height: 1 (25.4)











PA10166 Cabin Air Element
Fits: Volvo Automotive
Replaces: Volvo 8687389; WIX 24688
Length: 9 23/32 (246.9)
Width: 8 9/32 (210.3)
Height: 1 3/8 (34.9)
Related To: PA10156 (with Charcoal)

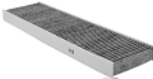

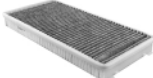
Measurements Are Shown In Inches And (Millimeters)

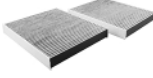
WARNING: These products can expose you to chemicals, including Diisononyl Phthalate, Carbon black extracts, Nickel, 1,3 Butadiene, Ethylene Oxide, Epichlorohydrin, which are known to the State of California to cause cancer, and Bisphenol, Ethylene Glycol, Ethylene Oxide, 1,3 Butadiene, Epichlorohydrin, which are known to the State of California to cause birth defects or other reproductive harm. For more information go to www.P65Warnings.ca.gov.

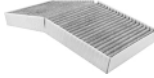
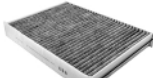
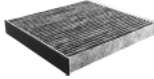
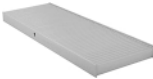
<p>PA10167 Cabin Air Element Fits: Honda S2000 Replaces: Honda 79830S2A003; WIX 24803 Length: 6 9/16 (166.7) Width: 6 3/8 (161.9) Height: 9/16 (14.3) A. Gskt: [4] Attached</p> 	<p>PA10174 Cabin Air Element Fits: Volvo Automotive Replaces: Volvo 91712968, 9184130; WIX 24821, 524821, WP6855 Length: 10 1/4 (260.3) Width: 6 5/8 (168.3) Height: 1 7/32 (31)</p> 
<p>PA10168 Cabin Air Element Contains: Charcoal Impregnated Media for Odor Control Fits: Mini Cooper, Clubman Replaces: BMW 64319127516; WIX 49367 Length: 17 13/32 (442.1) Width: 4 23/32 (119.9) Height: 1 3/16 (30.2)</p> 	<p>PA10175 KIT Set of 2 Cabin Air Elements Notes: Uses 2 filters per application. Contains: Charcoal Impregnated Media for Odor Control Fits: Mercedes-Benz Automotive Replaces: Mercedes-Benz 2308300418; WIX 49356 Each Filter Length: 8 13/16 (223.8) Width: 7 27/32 (199.2) Height: 1 9/16 (39.7)</p> 
<p>PA10169 Cabin Air Element Contains: Charcoal Impregnated Media for Odor Control. Fits: Porsche Automotive Replaces: Porsche 99757121900, 99657121901; WIX 24202 Length: 12 5/16 (312.7) Width: 6 1/32 (153.2) Height: 1 11/32 (34.1) A. Gskt: [1] Included</p> 	<p>PA10176 Cabin Air Element Fits: Kia Sorento Replaces: Kia 97133-3E260, 97133-3E270; WIX 24794 Length: 8 9/32 (210.3) Width: 4 15/32 (113.5) Height: 23/32 (18.3)</p> 
<p>PA10170 KIT Set of 2 Cabin Air Elements Notes: Uses 2 filters per application. Contains: Charcoal Impregnated Media for Odor Control Fits: BMW Automotive Replaces: BMW 64119163328, 64119163329, 64119272642; WIX 24329 Length: 9 23/32 (246.9) Width: 8 1/8 (206.4) Height: 1 3/16 (30.2)</p> 	<p>PA10177 Cabin Air Element Notes: Fold flaps out for installation. Fits: Saab 9-3, 9-3X Replaces: General Motors 93172299; Saab 9179905; WIX 24472 Length: 13 1/8 (333.4) Width: 6 13/32 (162.7) Height: 1 3/16 (30.2) Related To: PA10140 (with Charcoal)</p> 
<p>PA10171 Cabin Air Element with Pull Tab Fits: Mazda 6 Replaces: Mazda GK3J61148; WIX 24907 Length: 8 15/16 (227.0) Width: 8 5/16 (211.1) Height: 31/32 (24.6)</p> 	<p>PA10178 Cabin Air Element Contains: Charcoal Impregnated Media for Odor Control Fits: Mercedes-Benz Automotive Replaces: Mercedes-Benz 1718300418, 1728350047, A1718300418, A1728350047; WIX 49373 Length: 14 9/32 (362.7) Width: 7 (177.8) Height: 1 3/8 (34.9)</p> 
<p>PA10172 Cabin Air Element Contains: Charcoal Impregnated Media for Odor Control Fits: Volvo Automotive Replaces: Volvo 30767024; WIX 49355 Length: 10 7/8 (276.2) Width: 7 9/16 (192.1) Height: 1 1/4 (31.8) A. Gskt: [2] Included</p> 	<p>PA10179 Cabin Air Element Contains: Charcoal Impregnated Media for Odor Control Fits: Lexus Automotive Replaces: Toyota 87139-50030, 87139-YZZ01; Wix 24893 Length: 9 1/16 (230.2) Width: 8 1/2 (215.9) Height: 1 1/8 (28.6) A. Gskt: [2] Included</p> 
<p>PA10173 Cabin Air Element Fits: Saturn L Series, LW Series Replaces: Saturn 88997039, 90464424; WIX 24865, 524865 Length: 16 1/16 (408.0) Width: 5 11/16 (144.5) Height: 15/16 (23.8)</p> 	

Measurements Are Shown In Inches And (Millimeters)

WARNING: These products can expose you to chemicals, including Diisononyl Phthalate, Carbon black extracts, Nickel, 1,3 Butadiene, Ethylene Oxide, Epichlorohydrin, which are known to the State of California to cause cancer, and Bisphenol, Ethylene Glycol, Ethylene Oxide, 1,3 Butadiene, Epichlorohydrin, which are known to the State of California to cause birth defects or other reproductive harm. For more information go to www.P65Warnings.ca.gov.

PA10180 KIT Set of 2 Cabin Air Elements
Notes: Requires 2 filters per application.
Contains: Charcoal Impregnated Media for Odor Control
Fits: Mercedes-Benz Applications
Replaces: Mercedes-Benz 2218300718, A2218300718; WIX 24218
Each Filter:
Length: 10 11/32 (262.7)
Width: 7 1/4 (184.2)
Height: 1 3/16 (30.2)

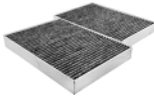

PA10186 KIT Set of 2 Cabin Air Elements
Notes: Uses 2 filters per application.
Fits: Maybach 57, 62; Mercedes-Benz Automotive
Replaces: Mercedes-Benz 2108300018, 2108301018, A2108300018, A2108301018; WIX 24783, 524783
Each Filter:
Length: 10 1/32 (254.8)
Width: 5 17/32 (140.5)
Height: 1 19/32 (40.5)
A. Gskt: [1] Attached Each Element



PA10181 Cabin Air Element
Fits: Pontiac G8; Chevrolet Caprice
Replaces: ACDelco CF182; General Motors 92184248; WIX 49248
Length: 10 5/8 (269.9)
Width: 9 7/16 (239.7)
Height: 25/32 (19.8)



PA10188 Cabin Air Element
Contains: Charcoal Impregnated Media for Odor Control
Fits: Jaguar S-Type, Super V8; Lincoln LS
Replaces: Ford 2R8Z-19N619-BA; Motorcraft FP45; WIX 24757, 49378
Length: 9 27/32 (250.0)
Width: 7 5/32 (181.8)
Height: 1 11/16 (42.9)
A. Gskt: [2] Attached

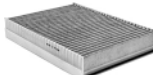

PA10182 Cabin Air Element
Contains: Charcoal Impregnated Media for Odor Control
Fits: Infiniti Automotive
Replaces: Nissan 272771ME0B; WIX 24021
Length: 8 7/16 (214.3)
Width: 8 3/8 (212.7)
Height: 1 3/16 (30.2)

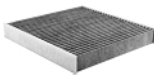

PA10189 Cabin Air Element
Contains: Charcoal Impregnated Media for Odor Control
Fits: Audi Automotive
Replaces: Volkswagen 4B0819439C; WIX 24765
Length: 11 13/16 (300.0)
Width: 8 1/16 (204.8)
Height: 1 3/16 (30.2)

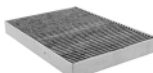

PA10183 Cabin Air Element
Fits: Mercedes-Benz Automotive
Replaces: Mercedes-Benz 1638350047; Mann & Hummel CU2338; WIX 24867, 524867
Length: 9 11/32 (237.3)
Width: 8 1/2 (215.9)
Height: 1 17/32 (38.9)
A. Gskt: [1] Attached



PA10190 Cabin Air Element
Contains: Charcoal Impregnated Media for Odor Control.
Fits: Lexus LS460, LS600h
Replaces: Toyota 8713950060; Wix 24160
Length: 8 13/32 (213.5)
Width: 7 5/8 (193.7)
Height: 1 1/8 (28.6)

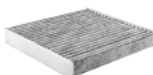

PA10184 Cabin Air Element
Contains: Charcoal Impregnated Media for Odor Control
Fits: Land Rover LR3, LR4, Range Rover Sport
Replaces: Land Rover JKR500020; Mann & Hummel CUK2747; Wix 49369
Length: 10 9/16 (268.3)
Width: 6 7/32 (158.0)
Height: 1 3/16 (30.2)



PA10191 KIT Set of 2 Cabin Air Elements
Fits: Mazda 2
Replaces: Mazda D65161J6X; WIX 24036
Larger Filter:
Length: 9 23/32 (246.9)
Width: 3 29/32 (99.2)
to 3 29/32 (99.2)
Height: 21/32 (16.7)
A. Gskt: [1] Attached to Larger Filter
Smaller Filter:
O.D. Length: 9 23/32 (246.9)
I.D. Width: 4 (101.6)
Height: 21/32 (16.7)

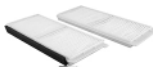

PA10185 Cabin Air Element
Contains: Charcoal Impregnated Media for Odor Control
Fits: Smart Fortwo; Volkswagen Automotive
Replaces: Mercedes-Benz 4518300018, A518300018; WIX 49351
Length: 8 19/32 (218.3)
Width: 8 15/32 (215.1)
Height: 1 (25.4)

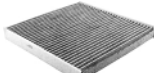







PA10192 Cabin Air Element
Fits: BMW Automotive
Replaces: BMW 64319142115; WIX 49371
Length: 32 3/4 (831.9)
Width: 4 13/16 (122.2)
Height: 1 (25.4)
A. Gskt: [2] Included

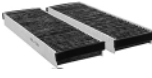

Measurements Are Shown In Inches And (Millimeters)

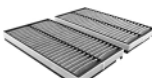
WARNING: These products can expose you to chemicals, including Diisononyl Phthalate, Carbon black extracts, Nickel, 1,3 Butadiene, Ethylene Oxide, Epichlorohydrin, which are known to the State of California to cause cancer, and Bisphenol, Ethylene Glycol, Ethylene Oxide, 1,3 Butadiene, Epichlorohydrin, which are known to the State of California to cause birth defects or other reproductive harm. For more information go to www.P65Warnings.ca.gov.

<p>PA10193 KIT</p> 	<p>Set of 2 Cabin Air Elements Notes: Set consists of two different shaped elements. Fits: Subaru Forester with 4-2458cc (2.5L) FI Engine Replaces: Subaru G3210FC200; WIX 24010 Each Filter: Length: 7 15/16 (201.6) Width: 4 7/16 (112.7) Height: 1 9/16 (39.7)</p>	<p>PA10199 KIT</p>  <p>Set of 2 Cabin Air Elements Notes: Uses 2 filters per application. Fits: Hyundai Santa Fe, Sonata, XG350 Replaces: Hyundai 97619-3D000; WIX 24853 Each Filter: Length: 10 1/8 (257.2) Width: 3 7/8 (98.4) Height: 1 1/2 (38.1)</p>
<p>PA10194</p> 	<p>Cabin Air Element Contains: With Pull Tabs Fits: Mazda CX-3 with (2.0L) Engine Replaces: Mazda D09W-61-J6X, DB9L-61-J6X, 87139-WB001; WIX WP10267 Length: 8 3/32 (205.6) Width: 7 27/32 (199.2) Height: 1 5/16 (33.3) A. Gskt: [1] Included</p>	<p>PA10200</p>  <p>Cabin Air Element Contains: Charcoal Impregnated Media for Odor Control Fits: Volvo Automotive Replaces: Volvo 9171756 Length: 11 3/8 (288.9) Width: 10 1/4 (260.3) Height: 29/32 (23) A. Gskt: [1] Attached Related To: PA10153 (Non-Charcoal Version)</p>
<p>PA10195 KIT</p> 	<p>Set of 2 Cabin Air Elements Notes: Uses 2 filters per application. Fits: Mazda Automotive Replaces: Mazda BBM461J6X; WIX 24046 Length: 9 27/32 (250.0) Width: 4 3/32 (104.0) Height: 7/8 (22.2) A. Gskt: [1] Attached to one filter</p>	<p>PA10201</p>  <p>Cabin Air Element with Pull Tab Fits: Hyundai Elantra, Entourage, Tiburon; Kia Sedona Replaces: Hyundai 97133-2D000; WIX 24689 Length: 10 11/32 (262.7) Width: 9 3/8 (238.1) Height: 1 3/16 (30.2) A. Gskt: [1] Attached Related To: PA10164 (without Attached Gasket)</p>
<p>PA10196 KIT</p> 	<p>Set of 2 Cabin Air Elements Notes: Uses 2 filters per application. Fits: Audi A6, R8; Lamborghini Gallardo Replaces: Audi 4F0898438A, 4F0819439A; WIX 49375 Length: 12 (304.8) Width: 3 15/16 (100.0) Height: 1 5/32 (29.4) A. Gskt: [1] Attached Each Element</p>	<p>PA10202</p>  <p>Cabin Air Element Fits: Suzuki SX4 Replaces: Suzuki 9586080J00; WIX 49700 Length: 8 1/32 (204.0) Width: 7 19/32 (192.9) Height: 1 7/8 (47.6) A. Gskt: [1] Included</p>
<p>PA10197</p> 	<p>Cabin Air Element Contains: Charcoal Impregnated Media for Odor Control Fits: Mercedes-Benz Automotive Replaces: Mercedes-Benz 2128300318; Mann & Hummel CUK2551; WIX 49357 Length: 11 3/16 (284.2) Width: 10 3/16 (258.8) Height: 3 5/16 (84.1) A. Gskt: [1] Included</p>	<p>PA10203 KIT</p>  <p>Set of 3 Cabin Air Elements Notes: Uses 3 filters per application. Fits: Buick Park Avenue; Cadillac Seville Replaces: GMC 52472175, 52482839; WIX 24874 Each Filter: Length: 10 17/32 (267.5) Width: 2 21/32 (67.5) Height: 25/32 (19.8)</p>
<p>PA10198 KIT</p> 	<p>Set of 2 Cabin Air Elements Notes: Uses 2 filters per application. Contains: Charcoal Impregnated Media for Odor Control Fits: BMW Automotive Replaces: BMW 64319171858, 64316935822, 64316935823; WIX 49374 Each Filter Length: 12 11/16 (322.3) Width: 6 15/16 (176.2) Height: 1 3/16 (30.2) A. Gskt: [1] Attached Each Filter</p>	<p>PA10204 KIT</p>  <p>Set of 2 Cabin Air Elements Notes: Uses 2 filters per application. Fits: Mazda MPV Van, RX8 Replaces: Mazda LDY4-61-J6X; WIX 24826 Length: 9 1/8 (231.8) Width: 4 3/32 (104.0) Height: 27/32 (21.4) A. Gskt: [1] Attached Each Filter</p>

Measurements Are Shown In Inches And (Millimeters)

WARNING: These products can expose you to chemicals, including Diisononyl Phthalate, Carbon black extracts, Nickel, 1,3 Butadiene, Ethylene Oxide, Epichlorohydrin, which are known to the State of California to cause cancer, and Bisphenol, Ethylene Glycol, Ethylene Oxide, 1,3 Butadiene, Epichlorohydrin, which are known to the State of California to cause birth defects or other reproductive harm. For more information go to www.P65Warnings.ca.gov.

PA10205 KIT Set of 2 Cabin Air Elements
Notes: Uses 2 filters per application.
Contains: Charcoal Impregnated Media for Odor Control
Fits: Maybach 57, 62, 57S, 62S, Landulet; Mercedes-Benz Automotive
Replaces: Mercedes-Benz 2108300218; WIX 24778, 524778
Larger Filter:
Length: 9 7/32 (234.2)
Width: 8 7/16 (214.3)
Height: 1 23/32 (43.7)
A. Gskt: [2] Attached to Each Filter
Smaller Filter:
O.D. Length: 8 13/32 (223.8)
I.D. Width: 7 15/16 (201.6)
Height: 1 23/32 (43.7)



PA10210 KIT Set of 2 Cabin Air Elements
Notes: Uses 2 filters per application.
Contains: Charcoal Impregnated Media for Odor Control
Fits: Lexus ES300
Replaces: Toyota 88880-33020; WIX 24895
Top Filter:
Length: 10 9/32 (261.1)
Width: 5 5/8 (142.9)
Height: 25/32 (19.8)
A. Gskt: [2] Attached on Top Filter
Bottom Filter:
O.D. Length: 10 9/32 (261.1)
I.D. Width: 5 17/32 (140.5)
Height: 25/32

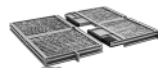

PA10206 KIT Set of 2 Cabin Air Elements
Notes: Uses 2 filters per application.
Fits: Land Rover Discovery, Range Rover
Replaces: Land Rover BTR8037; WIX 24898
Each Filter:
Length: 8 17/32 (216.7)
Width: 7 23/32 (196.1)
Height: 1 1/32 (26.2)



PA10211 KIT Set of 2 Cabin Air Elements
Notes: Uses 2 filters per application.
Fits: Chevrolet Tracker; Suzuki Grand Vitara, XL-7
Replaces: GMC 91175923; Suzuki 9586165D00; WIX 24899
Each Filter:
Length: 8 3/4 (222.3)
Width: 4 5/16 (109.5)
Height: 11/16 (17.5)
A. Gskt: [1] Attached Each Filter



PA10207 Cabin Air Element
Contains: Charcoal Impregnated Media for Odor Control.
Fits: Mercedes-Benz Automotive
Replaces: Mercedes-Benz 2118300018, A2118300018; Wix 24726
Length: 12 1/4 (311.2)
Width: 10 11/16 (271.5)
Height: 1 11/32 (34.1)
A. Gskt: [1] Attached

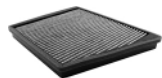

PA10212 KIT Cabin Air Element
Contains: Charcoal Impregnated Media for Odor Control
[1] Foam Strip
Fits: Saab 9-5
Replaces: Saab 12758728; WIX 49370
Length: 12 13/16 (325.4)
Width: 7 7/8 (200.0)
Height: 2 3/16 (55.6)

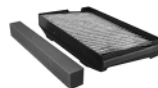

PA10208 KIT Set of 2 Cabin Air Elements
Notes: Uses 2 filters per application.
Contains: Charcoal Impregnated Media for Odor Control
Fits: BMW Automotive
Replaces: BMW 64316945586; WIX 49585
Each Filter
Length: 11 27/32 (300.8)
Width: 5 1/4 (133.4)
Height: 1 9/16 (39.7)

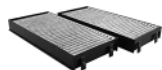

PA10213 Cabin Air Element
Fits: Chevrolet Camaro
Replaces: ACDelco CF178; General Motors 92234714; WIX 24014
Length: 9 29/32 (251.6)
Width: 9 5/8 (244.5)
Height: 25/32 (19.8)
A. Gskt: [1] Included

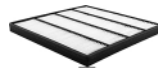

PA10209 KIT Set of 2 Cabin Air Elements
Notes: Uses 2 filters per application.
Contains: [1] Metal Clip
Fits: Nissan Frontier, Xterra
Replaces: Nissan B7200-3S500; WIX 24856
Each Filter:
Length: 9 1/8 (231.8)
Width: 8 9/32 (210.3)
Height: 15/16 (23.8)
A. Gskt: [1] Attached Each Filter



PA10214 Cabin Air Element
Notes: Uses 2 filters per application.
Fits: Ford Thunderbird; Lincoln LS
Replaces: Ford XW4Z-19N619-AC; WIX 24884
Length: 11 3/8 (288.9)
Width: 7 11/16 (195.3)
Height: 31/32 (24.6)
A. Gskt: [1] Attached





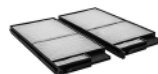





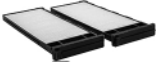

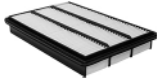

PA10215 KIT Set of 2 Cabin Air Elements
Notes: Uses 2 filters per application.
Fits: Lexus LX470; Toyota Landcruiser
Replaces: Toyota 88568-60010; WIX 24908
Each Filter:
Length: 11 31/32 (304.0)
Width: 5 1/8 (130.2)
Height: 25/32 (19.8)



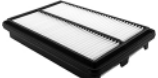
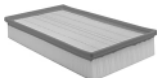



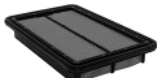







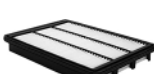

Measurements Are Shown In Inches And (Millimeters)

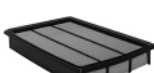
WARNING: These products can expose you to chemicals, including Diisononyl Phthalate, Carbon black extracts, Nickel, 1,3 Butadiene, Ethylene Oxide, Epichlorohydrin, which are known to the State of California to cause cancer, and Bisphenol, Ethylene Glycol, Ethylene Oxide, 1,3 Butadiene, Epichlorohydrin, which are known to the State of California to cause birth defects or other reproductive harm. For more information go to www.P65Warnings.ca.gov.

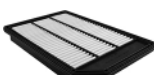
<p>PA10216 KIT</p> 	<p>Set of 2 Cabin Air Elements Notes: Uses 2 filters per application. Fits: Nissan Altima, Pathfinder, QX4 Replaces: Nissan 27274-7J125, 999M1VP003; WIX 24863 Each Filter: Length: 10 21/32 (270.7) Width: 4 1/4 (108.0) Height: 15/16 (23.8) A. Gskt: [1] Attached Each Filter</p>	<p>PA10224</p>  <p>Panel Air Element Fits: Suzuki SX4 Replaces: Suzuki 13780-80J00; WIX 49005 Length: 11 3/32 (281.8) Width: 5 3/8 (136.5) Height: 1 11/16 (42.9) A. Gskt: [1] Included</p>
<p>PA10217</p> 	<p>Panel Air Element Notes: For Battery Pack Fits: Ford Escape Hybrid; Mercury Mariner Hybrid Replaces: Ford 5M6Z-19N619-AA, 5M6H-19N619-AD; Wix 24477 Length: 4 13/16 (122.2) Width: 3 15/32 (88.1) Height: 25/32 (19.8)</p>	<p>PA10225</p>  <p>Panel Air Element Fits: Mitsubishi Montero Replaces: Mitsubishi MR404849, MR571476; WIX 42369 Length: 14 5/32 (359.6) Width: 9 7/32 (234.2) Height: 2 1/32 (51.6) A. Gskt: [1] Attached</p>
<p>PA10218</p> 	<p>Panel Air Element Fits: Scion iQ Replaces: Toyota 1780140040; Mann & Hummel C34003; WIX 49740 Length: 13 3/32 (332.6) Width: 5 3/8 (136.5) Height: 1 3/8 (34.9)</p>	<p>PA10226</p>  <p>Panel Air Element Fits: Jaguar Automotive Replaces: Jaguar EAC1828, GFE1088, JLM9548; Wix 46004 Length: 16 5/8 (422.3) Width: 5 3/8 (136.5) Height: 1 9/32 (32.5)</p>
<p>PA10219</p> 	<p>Panel Air Element Fits: Mazda 2 with 4-1498cc (1.5L) FI Engine Replaces: Mazda ZJ0113Z40; WIX 49640 Length: 12 3/8 (314.3) Width: 7 29/32 (200.8) Height: 1 3/8 (34.9)</p>	<p>PA10227</p>  <p>Panel Air Element Fits: Acura ILX, Honda Civic Hybrid with 4-1497cc (1.5L) FI Engine Replaces: Honda 17220RW0A01; WIX 49091 Length: 7 13/32 (188.1) Width: 7 1/16 (179.4) Height: 1 27/32 (46.8) A. Gskt: [1] Included</p>
<p>PA10220</p> 	<p>Panel Air Element Fits: Honda Fit with 4-1497cc (1.5L) FI Engine Replaces: Honda 172205R0008; WIX WA10212 Length: 7 25/32 (197.6) Width: 5 9/16 (141.3) Height: 2 (50.8) A. Gskt: [1] Attached</p>	<p>PA10228</p>  <p>Panel Air Element Fits: Acura TL Replaces: Honda 17220-RDA-A10; Wix 49224 Length: 12 15/16 (328.6) Width: 5 7/8 (149.2) Height: 1 31/32 (50) A. Gskt: [1] Attached</p>
<p>PA10221</p> 	<p>Panel Air Element Fits: 2010-13 Acura MDX, ZDX Replaces: Acura 17220-RYE-A10; Wix 49610 Length: 10 31/32 (278.9) Width: 7 1/16 (179.1) Height: 1 3/4 (44.4) A. Gskt: [1] Included</p>	<p>PA10229</p>  <p>Panel Air Element Fits: Mercedes-Benz Automotive Replaces: Mercedes-Benz 6040940504, 6040940604; WIX 42462 Length: 13 7/32 (335.8) Width: 7 15/32 (189.7) Height: 2 1/4 (57.2)</p>
<p>PA10222</p> 	<p>Panel Air Element Fits: 2006-08 Infiniti M35 Replaces: Nissan 16546-EG000; Wix 49001 Length: 10 31/32 (278.4) Width: 7 1/4 (183.9) Height: 2 1/32 (51.6) A. Gskt: [1] Included</p>	<p>PA10230</p>  <p>Panel Air Element Fits: Kia Sportage with 4-122 (2.0L) FI Turbo Engine Replaces: Kia 281133W500; WIX 49047 Length: 11 9/32 (286.5) Width: 6 15/32 (164.3) Height: 2 3/32 (53.2) A. Gskt: [1] Included</p>
<p>PA10223</p> 	<p>Panel Air Element Contains: Locking tabs on both sides. Fits: Hyundai Sonata; Kia Optima Replaces: Hyundai 28113C1500; WIX WA10301 Length: 11 (279.4) Width: 8 5/8 (219.1) Height: 1 23/32 (43.7) A. Gskt: [1] Attached</p>	<p>PA10231</p>  <p>Panel Air Element Fits: Mazda Miata Replaces: Mazda FS0-513-Z40; WIX 42486 Length: 10 5/32 (258.0) Width: 6 1/2 (165.1) Height: 1 9/16 (39.7)</p>





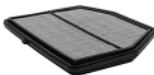
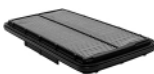







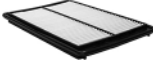



Measurements Are Shown In Inches And (Millimeters)

WARNING: These products can expose you to chemicals, including Diisononyl Phthalate, Carbon black extracts, Nickel, 1,3 Butadiene, Ethylene Oxide, Epichlorohydrin, which are known to the State of California to cause cancer, and Bisphenol, Ethylene Glycol, Ethylene Oxide, 1,3 Butadiene, Epichlorohydrin, which are known to the State of California to cause birth defects or other reproductive harm. For more information go to www.P65Warnings.ca.gov.

<p>PA10232 Panel Air Element Fits: Hyundai Genesis, Equus Replaces: Hyundai 28113-3M100; WIX 49004 Length: 10 21/32 (270.7) Width: 7 3/4 (196.9) to 11 23/32 (297.7) Height: 2 1/8 (54) A. Gskt: [1] Included</p> 	<p>PA10240 Panel Air Element Fits: Suzuki XL-7 Replaces: Suzuki 13780-52D00; WIX 42737 Length: 10 9/16 (268.3) Width: 8 29/32 (226.2) Height: 1 7/8 (47.6) A. Gskt: [1] Attached</p> 
<p>PA10233 Panel Air Element Fits: Lexus Automotive Replaces: Toyota 17801-50060; WIX 46493 Length: 11 1/16 (281.0) Width: 5 9/16 (141.3) to 9 7/32 (234.2) Height: 2 1/16 (52.4) A. Gskt: [1] Attached</p> 	<p>PA10241 Panel Air Element Fits: Hyundai Genesis Replaces: Hyundai 28113-3M000; WIX 49100 Length: 11 21/32 (296.1) Width: 8 15/16 (227.0) Height: 1 23/32 (43.7) A. Gskt: [1] Included</p> 
<p>PA10234 Panel Air Element Fits: Kia Borrego with V6-3778cc (3.8L), V8-282 (4.6L) Engines Replaces: Kia 28113-2J000; Wix 49600 Length: 11 5/8 (295.3) Width: 8 5/16 (211.1) Height: 1 3/8 (34.9) A. Gskt: [1] Included</p> 	<p>PA10242 Panel Air Element Fits: Dodge Viper; Mazda RX-8 Replaces: Mazda N3H1-13-Z40; Wix 46835 Length: 14 3/4 (374.7) Width: 8 31/32 (227.8) Height: 1 15/16 (49.2) A. Gskt: [1] Attached</p> 
<p>PA10235 Panel Air Element Fits: Infiniti FX45, Q45 Replaces: Nissan 16546-60U00; WIX 46053 Length: 10 31/32 (278.6) Width: 7 3/8 (187.3) Height: 1 23/32 (43.7)</p> 	<p>PA10243 Oval Air Filter Fits: Mercedes-Benz Automotive Replaces: Mercedes-Benz A6510940104, 6510940104 Length: 13 3/4 (349.3) Width: 6 29/32 (175.4) Height: 3 3/4 (95.3) I.Gskt: [1] Included</p> 
<p>PA10236 Panel Air Element Fits: Suzuki Kizashi Replaces: Suzuki 1378057L00; WIX 49008 Length: 12 21/32 (321.5) Width: 8 9/32 (210.3) Height: 1 9/16 (39.7) A. Gskt: [1] Included</p> 	<p>PA10244 Panel Air Element Fits: Chevrolet Epica; Suzuki Verona Replaces: GMC 96328718; Suzuki 13780-86Z00; WIX 42838 Length: 10 7/8 (276.2) Width: 9 23/32 (246.9) Height: 1 25/32 (45.2) A. Gskt: [1] Attached</p> 
<p>PA10237 Panel Air Element Fits: Hyundai Genesis Coupe Replaces: Hyundai 281132M000; Wix 49110 Length: 10 9/16 (268.3) Width: 8 3/4 (222.3) Height: 2 1/8 (54) A. Gskt: [1] Included</p> 	<p>PA10245 Panel Air Element Fits: Mitsubishi Montero, Montero Sport Replaces: Mitsubishi MD620837; Wix 46308 Length: 9 3/4 (247.7) Width: 8 13/16 (223.8) Height: 1 15/16 (49.2)</p> 
<p>PA10238 Panel Air Element Fits: Suzuki Grand Vitara Replaces: Suzuki 13780-78K00; WIX 49800 Length: 9 7/16 (239.7) Width: 8 17/32 (216.7) Height: 2 (50.8) A. Gskt: [1] Included</p> 	<p>PA10246 Set of 2 Air Elements Notes: For Right and Left Hand Sides Fits: Mercedes-Benz Automotive Replaces: Mercedes-Benz A6420942004, A6420941804, 6420942404, 6420942304, 6420942004, 6420941804 Length: 12 1/32 (305.6) Width: 7 17/32 (191.3) Height: 4 (101.6)</p> 
<p>PA10239 Panel Air Element Fits: Nissan Murano, Pathfinder; Infiniti QX60 Replaces: Nissan 165463KY0A; Wix WA10267 Length: 11 1/32 (280.2) Width: 9 1/2 (241.3) Height: 1 1/16 (27) A. Gskt: [1] Included</p> 	<p>PA10247 Panel Air Element Fits: Honda Insight Replaces: Honda 17220-PHM-000; Wix 46499 Length: 10 5/8 (269.9) Width: 5 21/32 (143.7) Height: 1 7/32 (31)</p> 













Measurements Are Shown In Inches And (Millimeters)

WARNING: These products can expose you to chemicals, including Diisononyl Phthalate, Carbon black extracts, Nickel, 1,3 Butadiene, Ethylene Oxide, Epichlorohydrin, which are known to the State of California to cause cancer, and Bisphenol, Ethylene Glycol, Ethylene Oxide, 1,3 Butadiene, Epichlorohydrin, which are known to the State of California to cause birth defects or other reproductive harm. For more information go to www.P65Warnings.ca.gov.

<p>PA10248 Panel Air Element Fits: Mazda MX-5 Miata Replaces: Mazda LFG1-13-Z40; WIX 42863 Length: 11 7/8 (301.6) Width: 6 5/16 (160.3) Height: 1 23/32 (43.7) A. Gskt: [1] Included</p> 	<p>PA10257 Air Element Notes: Left hand side. Fits: BMW Automotive Replaces: BMW 13717577458 Length: 14 31/32 (380.2) Width: 11 5/8 (295.3) Height: 4 11/32 (110.3) A. Gskt: [1] Included</p> 
<p>PA10249 Panel Air Element Fits: Pontiac Solstice, Saturn Sky all with 4-145 (2.4L) Engine Replaces: ACDelco A3076C; GMC 15287103; WIX 49066 Length: 14 1/2 (368.3) Width: 9 7/16 (239.7) Height: 1 1/8 (28.6) A. Gskt: [1] Attached</p> 	<p>PA10258 Panel Air Element Fits: Honda Accord, Prelude Replaces: Honda 17220-P13-000; Wix 46110 Length: 13 3/16 (335.0) Width: 6 1/16 (154.0) Height: 2 (50.8)</p> 
<p>PA10250 Panel Air Element Fits: Kia Amanti Replaces: Kia 28113-3F900; WIX 49900 Length: 6 5/16 (160.3) Width: 6 (152.4) to 8 15/32 (215.1) Height: 1 25/32 (45.2) A. Gskt: [1] Included</p> 	<p>PA10259 Panel Air Element Fits: Jeep Liberty, T.J, Wrangler Replaces: Chrysler 5019443AA; Wix 42156 Length: 10 15/32 (265.9) Width: 6 15/32 (164.3) Height: 2 (50.8) A. Gskt: [1] Attached</p> 
<p>PA10251 Panel Air Element Fits: Kia Forte5, Forte Koup Replaces: Kia 28113A5800; Wix WA10059 Length: 10 1/2 (266.7) Width: 5 3/4 (146.0) Height: 2 5/32 (54.8)</p> 	<p>PA10260 Panel Air Element Fits: Acura Legend, TL Replaces: Acura 17220-PY3-000; Wix 46092 Length: 10 7/16 (265.1) Width: 8 21/32 (219.9) Height: 1 31/32 (50)</p> 
<p>PA10253 Panel Air Element Fits: Mitsubishi Diamante Replaces: Mitsubishi MR187912; Wix 546456, 46456 Length: 9 7/8 (250.8) Width: 8 5/16 (211.1) Height: 2 3/32 (53.2) A. Gskt: [1] Attached</p> 	<p>PA10261 Panel Air Element Fits: Hyundai Genesis with V8-5038cc (5.0L) FI Engine Replaces: Hyundai 28113M500; WIX 49650 Length: 8 17/32 (216.7) Width: 3 1/16 (77.8) Height: 27/32 (21.4) A. Gskt: [1] Included</p> 
<p>PA10254 Panel Air Element Fits: Hyundai Genesis Coupe Replaces: Hyundai 281132M200; Wix WA10022 Length: 11 5/8 (295.3) Width: 6 7/16 (163.5) Height: 2 (50.8)</p> 	<p>PA10262 Air Element Notes: Right hand side. Fits: BMW Automotive Replaces: BMW (Bavarian Motor Works) 13717577457 Length: 14 31/32 (380.2) Width: 11 21/32 (296.1) Height: 4 31/32 (126.2) A. Gskt: [1] Included</p> 
<p>PA10255 Panel Air Element Fits: Infiniti M45, M56 Replaces: ACDelco AF3939; Nissan 16546EH000; WIX 49290 Length: 9 9/32 (235.7) Width: 9 1/8 (231.8) Height: 2 1/8 (54) A. Gskt: [1] Included</p> 	<p>PA10263 Panel Air Element Fits: Acura TL Replaces: Honda 17220-PGE-A00; WIX 42023 Length: 12 11/16 (322.3) Width: 6 7/32 (158.0) Height: 1 19/32 (40.5) A. Gskt: [1] Attached</p> 
<p>PA10256 Panel Air Element Fits: Honda Accord Hybrid Replaces: Honda 172205K0A00; WIX WA10124 Length: 7 1/8 (181.0) Width: 5 19/32 (142.1) Height: 2 1/16 (52.4)</p> 	<p>PA10264 Panel Air Element Fits: Acura RL Replaces: Honda 17220-P5A-000; WIX 546245, 46245 Length: 10 15/32 (265.9) Width: 9 15/16 (252.4) Height: 1 9/16 (39.7)</p> 

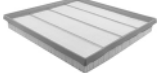
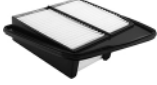





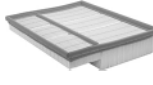
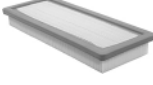
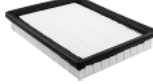
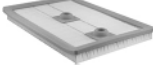

Measurements Are Shown In Inches And (Millimeters)

WARNING: These products can expose you to chemicals, including Diisononyl Phthalate, Carbon black extracts, Nickel, 1,3 Butadiene, Ethylene Oxide, Epichlorohydrin, which are known to the State of California to cause cancer, and Bisphenol, Ethylene Glycol, Ethylene Oxide, 1,3 Butadiene, Epichlorohydrin, which are known to the State of California to cause birth defects or other reproductive harm. For more information go to www.P65Warnings.ca.gov.

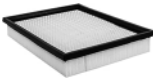
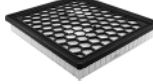
<p>PA10265 Panel Air Element Fits: Hyundai Genesis Coup with V6-3778cc (3.8L) Engine Replaces: Hyundai 281132M010; WIX 49006 Length: 10 9/16 (268.3) Width: 8 3/4 (222.3) Height: 2 1/8 (54) A. Gskt: [1] Included</p> 	<p>PA10273 Panel Air Element Fits: Hyundai Genesis; 2017-18 Genesis G80 with (3.8L) Engines Replaces: Hyundai 28113B1000; WIX WA10163 Length: 13 5/16 (338.1) Width: 9 1/4 (235.0) Height: 1 23/32 (43.7) A. Gskt: [1] Included</p> 
<p>PA10266 Panel Air Element Fits: Honda CR-Z Hybrid Replaces: Honda 17220-RTW-000; WIX 49390 Length: 6 11/32 (161.1) Width: 5 31/32 (151.6) Height: 1 13/16 (46) A. Gskt: [1] Included</p> 	<p>PA10274 Air Element Contains: Sensor Port Fits: Cadillac ATS; Chevrolet Cruze Replaces: ACDelco A3202C; General Motors 13367308; WIX WA10646 O.D.: 4 31/32 (126.2) to 5 1/2 (139.7) I.D.: 2 27/32 (72.2) & 2 7/8 (73.0) to Height: 6 13/16 (173)</p> 
<p>PA10267 Panel Air Element Fits: 2007-11 Lexus GS350, 2006-07 GS430, 2006-13 IS250, 2006-13 IS350 Replaces: Toyota 17810-31110, Wix 49146 Length: 9 9/32 (235.5) Width: 9 9/32 (235.5) Height: 2 1/8 (54.1) A. Gskt: [1] Included</p> 	<p>PA10275 Panel Air Element Fits: 2016-18 Toyota Prius, 2019 Prius AWD-e, 2012-19 Prius C, 2017-19 Prius Prime Replaces: Toyota 17801-21060; Wix WA10000 Length: 6 31/32 (176.8) Width: 4 11/16 (119.1) Height: 1 7/16 (36.6)</p> 
<p>PA10268 Panel Air Element Fits: Suzuki SX4 Replaces: Suzuki 1378054L00; WIX 49340 Length: 11 23/32 (297.7) Width: 5 7/8 (149.2) Height: 1 23/32 (43.7) A. Gskt: [1] Included</p> 	<p>PA10276 Panel Air Element Fits: 2017 Lexus GS Turbo, IS Turbo, RC Turbo, 2016-17 GS200t, IS200t, RC200t, 2018-19 GS300, 2013-19 GS350, 2013-18 GS450h, 2014-15 IS250, 2016-19 IS300, RC300, 2014-19 IS350, 2015-19 RC350 Replaces: Toyota 17801331170; Wix 49240 Length: 9 1/8 (231.9) Width: 9 1/32 (229.1) Height: 2 1/8 (54.1)</p> 
<p>PA10269 Panel Air Element Fits: Honda Insight Hybrid with 4-1339cc (1.3L) Engine Replaces: Honda 17220-RBJ-000; WIX 49270 Length: 6 13/16 (173.0) Width: 6 1/32 (153.2) Height: 1 21/32 (42.1) A. Gskt: [1] Attached</p> 	<p>PA10277 Panel Air Element Fits: Various BMW automotive Replaces: BMW (Bavarian Motor Works) 13717571355, 13717605913; Wix 49555 Length: 10 7/8 (276.1) Width: 10 9/32 (261.1) Height: 1 3/8 (34.8)</p> 
<p>PA10270 Panel Air Element Fits: Acura TSX Replaces: Acura 17220-RL5A00; WIX 49200 Length: 9 7/16 (239.7) Width: 8 9/32 (210.3) Height: 2 5/32 (54.8) A. Gskt: [1] Included</p> 	<p>PA10278 Panel Air Element Fits: BMW Automotive Replaces: BMW 13717542294; WIX 49056 Length: 3 3/8 (85.7) to 10 17/32 (267.5) Width: 3 3/8 (85.7) to 10 7/16 (265.1) Height: 1 31/32 (50)</p> 
<p>PA10271 Panel Air Element Fits: Hyundai Sonata Hybrid, Kia Optima Replaces: Kia 281133S100 Length: 10 29/32 (277.0) Width: 8 15/16 (227.0) Height: 1 21/32 (42.1) A. Gskt: [1] Included</p> 	<p>PA10279 Panel Air Element Fits: Audi Q7; Land Rover Range Rover; Porsche Cayenne; Volkswagen Touareg Replaces: Volkswagen 7L0129620; WIX 42859 Length: 15 7/16 (392.1) Width: 7 5/16 (185.7) Height: 2 9/32 (57.9) Related To: PA10340 (with Foam Pad)</p> 
<p>PA10272 Panel Air Element Fits: Kia Soul Replaces: Kia 28113-2K000; Wix 49400 Length: 9 13/16 (249.2) Width: 5 1/8 (130.2) Height: 2 5/32 (54.8) A. Gskt: [1] Included</p> 	



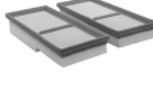
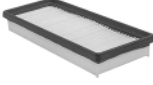
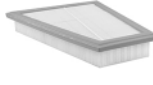

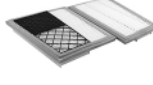

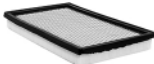

Measurements Are Shown In Inches And (Millimeters)

WARNING: These products can expose you to chemicals, including Diisononyl Phthalate, Carbon black extracts, Nickel, 1,3 Butadiene, Ethylene Oxide, Epichlorohydrin, which are known to the State of California to cause cancer, and Bisphenol, Ethylene Glycol, Ethylene Oxide, 1,3 Butadiene, Epichlorohydrin, which are known to the State of California to cause birth defects or other reproductive harm. For more information go to www.P65Warnings.ca.gov.

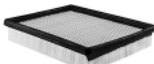
<p>PA10280</p> 	<p>Panel Air Element with Foam Pad Fits: Volvo Automotive Replaces: Volvo 30637444; Wix 46938 Length: 9 7/32 (234.2) Width: 8 1/8 (206.4) Height: 2 5/8 (66.7)</p>	<p>PA10288</p>  <p>Panel Air Element Fits: Mercedes-Benz Automotive Replaces: Mercedes-Benz 6040940004, 6040940104, 6040941404; WIX 546321, 46321, 42525 Length: 11 5/8 (295.3) Width: 8 29/32 (226.2) Height: 2 1/4 (57.2)</p>
<p>PA10281</p> 	<p>Panel Air Element Fits: 2011-12 BMW Z4; 2007-16 MINI Cooper, 2012-17 Cooper Countryman, 2013-16 Cooper Paceman Replaces: BMW (Bavarian Motor Works) 13717568728; Wix 49728 Length: 14 7/32 (361.4) Width: 5 23/32 (145.3) Height: 1 9/16 (39.9)</p>	<p>PA10289</p>  <p>Panel Air Element Fits: Mini Cooper Replaces: BMW 13721477840; Mann & Hummel C2237; WIX 42799 Length: 8 17/32 (216.7) Width: 6 9/16 (166.7) Height: 1 5/16 (33.3)</p>
<p>PA10282</p> 	<p>Panel Air Element Fits: 2016-18 Audi A3 Sportback e-tron; 2013-18 Volkswagen Jetta Replaces: Volkswagen 4E129620; Wix WA10072 Length: 10 19/32 (269.0) Width: 7 1/2 (190.5) Height: 31/32 (24.6)</p>	<p>PA10290</p>  <p>Panel Air Element Fits: Volkswagen Automotive Replaces: Volkswagen 07K129620, 7K129620; Wix 49186 Length: 16 15/16 (430.2) Width: 5 1/8 (130.2) Height: 1 19/32 (40.5)</p>
<p>PA10283</p> 	<p>Panel Air Element Fits: Saab 9-3 Series Replaces: General Motors 55557597; Saab 12786800; WIX 46915 Length: 11 5/8 (295.3) Width: 9 7/32 (234.2) Height: 1 7/8 (47.6)</p>	<p>PA10291</p>  <p>Panel Air Element Fits: Buick, Chevrolet Automotive Replaces: General Motors 55560894; WIX 49894 Length: 11 13/32 (289.7) Width: 10 3/16 (258.8) Height: 1 11/16 (42.9)</p>
<p>PA10284</p> 	<p>Panel Air Element Fits: Land Rover LR4, Range Rover, Range Rover Sport Replaces: Land Rover LR011593; Wix 49593 Length: 13 5/8 (346.1) Width: 6 13/32 (162.7) Height: 1 15/16 (49.2)</p>	<p>PA10292</p>  <p>Panel Air Element Fits: 2003-06 Volvo XC90 Replaces: Volvo 30741594, 8638600; Wix 42823 Length: 12 15/16 (328.7) Width: 8 15/32 (215.1) Height: 2 1/4 (57.2)</p>
<p>PA10285</p> 	<p>Panel Air Element with Foam Pad Fits: Audi A4, A5, Allroad, Q5 Replaces: Audi 8K0133843E; WIX 49043 Length: 12 5/8 (320.7) Width: 5 (127.0) Height: 2 17/32 (64.3)</p>	<p>PA10293</p>  <p>Set of 2 Panel Air Elements Notes: Uses 2 filters per application. Fits: Chrysler Crossfire; Mercedes-Benz SLK320 Replaces: Chrysler 5098424AA; Mercedes-Benz A1120940304; WIX 42822 Length: 10 9/16 (268.3) Width: 4 11/16 (119.1) Height: 1 15/16 (49.2)</p>
<p>PA10286</p> 	<p>Panel Air Element Fits: 2008-15 Smart ForTwo Replaces: Mercedes-Benz A0010940301, 10940301; Luber-finer AF3914; Wix 49301 Length: 10 17/32 (267.7) Width: 4 3/8 (111.5) Height: 1 13/32 (36.1)</p>	<p>PA10294</p>  <p>Panel Air Element Fits: BMW Automotive Replaces: BMW 13717582908; WIX 49208 Length: 10 23/32 (272.3) Width: 9 7/8 (250.8) Height: 2 (50.8)</p>
<p>PA10287</p> 	<p>Panel Air Element Fits: Porsche Automotive Replaces: Porsche 99611013152; Mann & Hummel C54165 Length: 20 15/16 (531.8) Width: 7 5/32 (181.8) Height: 1 21/32 (42.1)</p>	<p>PA10295</p>  <p>Set of 2 Panel Air Elements Fits: Mercedes-Benz Automotive Replaces: Mercedes-Benz 6420940404; Wix 42468 Larger Filter: Length: 10 3/4 (273.1) Width: 7 19/32 (192.9) Height: 1 11/32 (34.1) Smaller Filter: O.D. Length: 9 27/32 (250.0) I.D. Width: 8 3/16 (208.0) Height: 1 13/32 (35.7)</p>

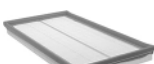
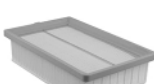

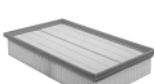
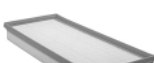
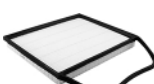

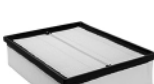
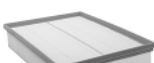
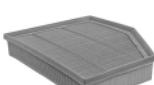
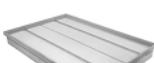
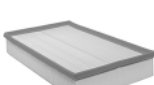
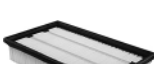



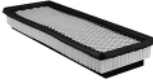
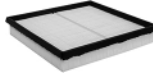
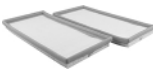

Measurements Are Shown In Inches And (Millimeters)

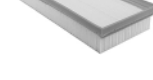
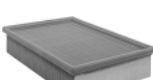
WARNING: These products can expose you to chemicals, including Diisononyl Phthalate, Carbon black extracts, Nickel, 1,3 Butadiene, Ethylene Oxide, Epichlorohydrin, which are known to the State of California to cause cancer, and Bisphenol, Ethylene Glycol, Ethylene Oxide, 1,3 Butadiene, Epichlorohydrin, which are known to the State of California to cause birth defects or other reproductive harm. For more information go to www.P65Warnings.ca.gov.

<p>PA10296 Panel Air Element Fits: Mini Cooper Replaces: BMW 13721491749; WIX 42800 Length: 10 27/32 (275.4) Width: 6 17/32 (165.9) Height: 1 5/16 (33.3)</p> 	<p>PA10305 Panel Air Element Fits: Mercedes-Benz C250, SLK250 Replaces: Mercedes-Benz 2710940304, A2710940304; WIX 49094 Length: 12 3/8 (314.3) Width: 4 1/32 (102.4) to 5 3/4 (146.0) Height: 1 7/8 (47.6)</p> 
<p>PA10297 Panel Air Element Fits: Cadillac XLR; Chevrolet Corvette Replaces: ACDelco A2945C; General Motors Corp. 10342024; Wix 42821 Length: 9 3/8 (238.1) Width: 7 1/8 (181.0) Height: 1 5/8 (41.3)</p> 	<p>PA10306 Panel Air Element Fits: Mercedes-Benz Automotive Replaces: Mercedes-Benz 6040940904; Wix 42620 Length: 9 1/4 (235.0) Width: 7 29/32 (200.8) Height: 1 13/16 (46)</p> 
<p>PA10298 Panel Air Element Notes: Uses 2 filters per application. Fits: Mercedes-Benz CLK430 Replaces: Mercedes-Benz 40941604; WIX 542052, 42052 Length: 13 7/32 (335.8) Width: 7 15/32 (189.7) Height: 1 1/4 (31.8)</p> 	<p>PA10307 Panel Air Element with Foam Pad Fits: Fiat 500L Replaces: Fiat 68202151AA; WIX WA10084 Length: 9 3/16 (233.4) Width: 5 9/16 (141.3) Height: 2 1/4 (57.2)</p> 
<p>PA10299 Panel Air Element Fits: Mercedes-Benz Automotive Replaces: Mercedes-Benz 2760940004, A2760940004; Wix 49034 Length: 16 11/16 (423.9) Width: 7 29/32 (200.8) Height: 1 3/8 (34.9)</p> 	<p>PA10308 Panel Air Element Fits: Mercedes-Benz E320 Replaces: Mercedes-Benz 1120940104, 1120940204; WIX 42213 Length: 12 13/32 (315.1) Width: 7 15/32 (189.7) Height: 2 5/16 (58.7)</p> 
<p>PA10300 Panel Air Element Fits: Jaguar X-Type Replaces: Jaguar 1X439601AA, C2S00002; WIX 42625 Length: 14 13/16 (376.2) Width: 6 3/32 (154.8) Height: 1 11/16 (42.9)</p> 	<p>PA10309 Panel Air Element Fits: BMW Automotive Replaces: BMW (Bavarian Motor Works) 13717556961; Wix 49461 Length: 13 29/32 (353.2) Width: 11 5/16 (287.3) Height: 1 3/8 (34.9) A. Gskt: [1] Included</p> 
<p>PA10301 Panel Air Element with Foam Pad Fits: Volvo XC90 Replaces: Volvo 3068029-3; Wix 49293 Length: 8 31/32 (227.8) Width: 8 5/8 (219.1) Height: 2 5/8 (66.7)</p> 	<p>PA10310 Panel Air Element Fits: Audi Automotive Replaces: Volkswagen 6C133843; WIX 42972 Length: 10 13/32 (264.3) Width: 8 11/32 (211.9) Height: 2 11/16 (68.3)</p> 
<p>PA10302 Panel Air Element Fits: Land Rover LR3, Range Rover Sport Replaces: Land Rover PHE000112; WIX 49112 Length: 11 29/32 (302.4) Width: 8 7/8 (225.4) Height: 2 5/16 (58.7)</p> 	<p>PA10311 Panel Air Element Fits: BMW Automotive Replaces: BMW 13717521033; WIX 42839 Length: 11 19/32 (294.5) Width: 6 1/8 (155.6) to 9 3/32 (231.0) Height: 1 13/16 (46)</p> 
<p>PA10303 Panel Air Element Fits: BMW X5 Replaces: BMW (Bavarian Motor Works) 13717548888; Wix 49888 Length: 14 (355.6) Width: 9 9/16 (242.9) Height: 1 1/2 (38.1)</p> 	<p>PA10312 Panel Air Element Fits: Volvo S80 Replaces: Volvo 9186361; WIX 42749 Length: 13 15/16 (354.0) Width: 8 15/32 (215.1) Height: 2 1/4 (57.2)</p> 
<p>PA10304 Panel Air Element Fits: Jaguar Automotive Replaces: Jaguar AJ82766, C2Z15037 Length: 11 21/32 (296.1) Width: 6 23/32 (170.7) Height: 2 7/32 (56.4)</p> 	

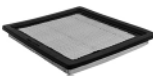

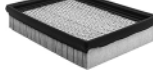







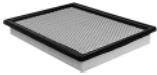

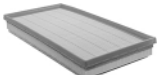
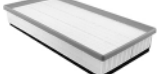
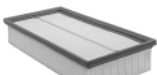
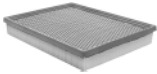
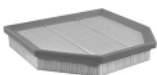
Measurements Are Shown In Inches And (Millimeters)

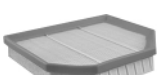
WARNING: These products can expose you to chemicals, including Diisononyl Phthalate, Carbon black extracts, Nickel, 1,3 Butadiene, Ethylene Oxide, Epichlorohydrin, which are known to the State of California to cause cancer, and Bisphenol, Ethylene Glycol, Ethylene Oxide, 1,3 Butadiene, Epichlorohydrin, which are known to the State of California to cause birth defects or other reproductive harm. For more information go to www.P65Warnings.ca.gov.

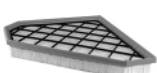
<p>PA10313</p> 	<p>Panel Air Element with Foam Pad Fits: Fiat 500 with 4-1368cc (1.4L) FI Turbo Engine Replaces: Mopar 52022346AA; WIX WA10006 Length: 11 7/8 (301.6) Width: 4 7/16 (112.7) Height: 1 5/8 (41.3)</p>	<p>PA10321</p>  <p>Panel Air Element Fits: BMW Automotive Replaces: BMW 13721247405; WIX 42168 Length: 9 5/16 (236.5) Width: 9 3/16 (233.4) Height: 1 21/32 (42.1)</p>
<p>PA10314</p> 	<p>Set of 2 Air Elements Notes: Uses 2 filters per application. Fits: Mercedes-Benz Automotive Replaces: Mercedes-Benz 1560940504, A1560940404, A1560940504; WIX 49504 Length: 12 3/16 (309.6) Width: 6 1/8 (155.6) Height: 15/16 (23.8)</p>	<p>PA10323</p>  <p>Panel Air Element Fits: Honda Civic, CRX Replaces: Honda 17220-PM7-000; Wix 546158, 46158 Length: 7 13/16 (198.4) Width: 6 13/16 (173.0) Height: 1 15/32 (37.3)</p>
<p>PA10315</p> 	<p>Panel Air Element Fits: Jaguar Vanden Plas, XJ8, XJR Replaces: Jaguar NJA3558AA; WIX 42461 Length: 12 1/8 (308.0) Width: 7 1/4 (184.2) Height: 1 15/16 (49.2)</p>	<p>PA10324</p>  <p>Panel Air Element Fits: Mercedes-Benz Automotive Replaces: Mercedes-Benz 2780940004; WIX 49704 Length: 12 21/32 (321.5) Width: 5 5/16 (134.9) Height: 1 7/8 (47.6)</p>
<p>PA10316</p> 	<p>Panel Air Element Fits: Cadillac CTS-V; Land Rover LR2; Volkswagen Derby Replaces: ACDelco A1623C; GMC 25750701; WIX 42827 Length: 11 (279.4) Width: 7 1/4 (184.2) Height: 2 11/32 (59.5)</p>	<p>PA10325</p>  <p>Panel Air Element Fits: Fiat 500 Replaces: Chrysler 68073648AA; Wix 49048 Length: 15 5/32 (385.0) Width: 5 1/4 (133.4) Height: 1 5/8 (41.3)</p>
<p>PA10317</p> 	<p>Panel Air Element Fits: Volvo XC90 with V8-4414cc (4.4L) Engine Replaces: Volvo 3063655-1; WIX 49242 Length: 12 (304.8) Width: 9 1/16 (230.2) Height: 2 9/32 (57.9)</p>	<p>PA10326</p>  <p>Panel Air Element Notes: Right hand side. Fits: BMW X5 Replaces: BMW 13717548897; WIX 49897 Length: 11 5/8 (295.3) Width: 9 1/32 (229.4) Height: 1 1/2 (38.1)</p>
<p>PA10318</p> 	<p>Panel Air Element Fits: Briggs & Stratton Engines Replaces: Briggs & Stratton 805113; WIX 542442, 42442 Length: 7 1/16 (179.4) Width: 6 9/32 (159.5) Height: 5/8 (15.9)</p>	<p>PA10327</p>  <p>Panel Air Element with Foam Precleaner Fits: Volkswagen Golf, Golf SportWagen with 4-1968cc (2.0L) FI Turbo Diesel Engine Replaces: Volkswagen 5QM129620A; WIX WA10317 Length: 11 1/2 (292.1) Width: 6 31/32 (177.0) Height: 3 5/32 (80.2)</p>
<p>PA10319</p> 	<p>Panel Air Element Fits: BMW Automotive with 6-2979cc (3.0L) FI Turbo Engine Replaces: BMW (Bavarian Motor Works) 13717599285; Wix 49285 Length: 11 3/16 (284.2) Width: 10 5/16 (261.9) Height: 1 9/32 (32.5)</p>	<p>PA10328</p>  <p>Panel Air Element Fits: Ford Automotive Replaces: Ford E9BZ-9601-A; Motorcraft FA1064; Wix 546227, 46227 Length: 8 5/32 (207.2) Width: 5 27/32 (148.4) Height: 1 15/32 (37.3)</p>
<p>PA10320</p> 	<p>Panel Air Element with Foam Pad Fits: Volvo Automotive Replaces: Volvo 30745344; Wix 49344 Length: 9 3/8 (238.1) Width: 8 7/32 (208.8) Height: 2 7/32 (56.4)</p>	<p>PA10329</p>  <p>Panel Air Element Notes: Left hand side. Fits: BMW X5 Replaces: BMW 13717548898; WIX 49898 Length: 11 5/8 (295.3) Width: 9 1/32 (229.4) Height: 1 1/2 (38.1)</p>

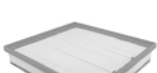

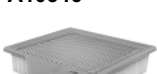

Measurements Are Shown In Inches And (Millimeters)

WARNING: These products can expose you to chemicals, including Diisononyl Phthalate, Carbon black extracts, Nickel, 1,3 Butadiene, Ethylene Oxide, Epichlorohydrin, which are known to the State of California to cause cancer, and Bisphenol, Ethylene Glycol, Ethylene Oxide, 1,3 Butadiene, Epichlorohydrin, which are known to the State of California to cause birth defects or other reproductive harm. For more information go to www.P65Warnings.ca.gov.

<p>PA10330 Panel Air Element Fits: Pontiac GTO Replaces: General Motors Corp. 92082656; Wix 46913 Length: 11 1/4 (285.8) Width: 8 29/32 (226.2) Height: 1 17/32 (38.9)</p> 	<p>PA10339 Panel Air Element Fits: Porsche 911 Replaces: Porsche 99611013171; WIX 49171 Length: 20 11/16 (525.5) Width: 7 3/32 (180.2) Height: 1 9/16 (39.7)</p> 
<p>PA10331 Panel Air Element with Foam Pad Fits: Volvo S40, V40 Replaces: Volvo 30850831; WIX 42897 Length: 13 1/2 (342.9) Width: 6 21/32 (169.1) Height: 1 11/16 (42.9)</p> 	<p>PA10340 Panel Air Element with Foam Pad Fits: Porsche Cayenne; Volkswagen Touareg Replaces: Volkswagen 7P0129620A; WIX 49920 Length: 15 (381.0) Width: 7 5/16 (185.7) Height: 2 3/8 (60.3) Related To: PA10279 (without Foam Pad)</p> 
<p>PA10332 Panel Air Element Fits: Saab 9-3 Replaces: Saab 4876074; WIX 49074 Length: 12 1/16 (306.4) Width: 5 7/8 (149.2) Height: 2 9/32 (57.9)</p> 	<p>PA10341 Panel Air Element Fits: Volvo Automotive Replaces: Volvo 1336397-3; WIX 546198, 46198 Length: 11 5/16 (287.3) Width: 8 3/8 (212.7) Height: 1 19/32 (40.5)</p> 
<p>PA10333 Panel Air Element Notes: For Left Side Fits: BMW M3, M4, M5, M6 Replaces: BMW 13727843283; WIX WA10041 Length: 9 1/4 (235.0) Width: 8 3/8 (212.7) Height: 1 15/32 (37.3)</p> 	<p>PA10342 Panel Air Element Fits: BMW Mini Cooper Replaces: BMW 13727529261; Mann & Hummel C2245; WIX 49260 Length: 8 15/32 (215.1) Width: 6 1/2 (165.1) Height: 1 7/8 (47.6)</p> 
<p>PA10334 Panel Air Element Notes: For Right Side Fits: BMW M3, M4, M5, M6 Replaces: BMW 13727843284; WIX WA10042 Length: 9 1/4 (235.0) Width: 8 3/8 (212.7) Height: 1 15/32 (37.3)</p> 	<p>PA10343 Panel Air Element with Foam Pad Fits: Toyota Highlander with 3.5L Hybrid Engine Replaces: Toyota 1780131141; WIX WA10313 Length: 9 1/16 (230.2) Width: 8 17/32 (216.7) Height: 1 9/16 (39.7)</p> 
<p>PA10335 Panel Air Element with Foam Pad Fits: BMW X5 with 6-2993cc (3.0L) FI Turbo Diesel Engine Replaces: BMW 13717798342; WIX 49342 Length: 12 3/4 (323.8) Width: 10 1/16 (255.6) Height: 1 31/32 (50)</p> 	<p>PA10344 Panel Air Element Fits: Cadillac CTS with V6-217 (3.6L) FI Turbo Replaces: ACDelco A3185C; General Motors 22844634; WIX WA10400 Length: 12 3/16 (309.6) Width: 9 1/4 (235.0) Height: 1 15/32 (37.3)</p> 
<p>PA10336 Panel Air Element Fits: Mini Cooper, Countryman Replaces: ACDelco AF3604; BMW 13717534825; WIX 49825 Length: 19 7/16 (493.7) Width: 3 5/16 (84.1) Height: 2 1/4 (57.2)</p> 	<p>PA10345 Panel Air Element with Foam Pad Fits: Buick Regal; Saab 9-5 Replaces: ACDelco A3172C; GMC 13319421; WIX 49421 Length: 11 7/16 (290.5) Width: 10 5/32 (258.0) Height: 2 1/16 (52.4)</p> 
<p>PA10337 Panel Air Element Fits: Jaguar Automotive Replaces: Jaguar C2P16933, 0C2P16933; WIX 49033 Length: 9 3/4 (247.7) Width: 6 9/32 (159.5) Height: 2 11/32 (59.5)</p> 	<p>PA10346 Panel Air Element Fits: Ford Mustang Replaces: Ford AR3Z-9601-B; Motorcraft FA1897; Wix 49201 Length: 9 21/32 (245.3) Width: 8 19/32 (218.3) Height: 2 5/32 (54.8)</p> 
<p>PA10338 Panel Air Element Fits: Porsche Panamera Replaces: Porsche 97011022001; WIX 49055 Length: 26 31/32 (685.0) Width: 4 27/32 (123.0) Height: 2 9/32 (57.9)</p> 	

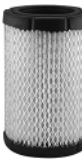
Measurements Are Shown In Inches And (Millimeters)

WARNING: These products can expose you to chemicals, including Diisononyl Phthalate, Carbon black extracts, Nickel, 1,3 Butadiene, Ethylene Oxide, Epichlorohydrin, which are known to the State of California to cause cancer, and Bisphenol, Ethylene Glycol, Ethylene Oxide, 1,3 Butadiene, Epichlorohydrin, which are known to the State of California to cause birth defects or other reproductive harm. For more information go to www.P65Warnings.ca.gov.

<p>RS10347</p> 	<p>Radial Seal Air Element Fits: Mercedes-Benz Automotive Replaces: Mercedes-Benz 2710940204, A2710940204; WIX 49214 O.D.: 5 1/4 (133.4) I.D.: 2 25/32 (70.6) One End Height: 9 7/8 (250.8)</p>	<p>PA10353</p>  <p>Air Element Fits: Smart Fortwo with 3-799cc (0.8L) Engine Replaces: Mann & Hummel C1041; Wix 49068 O.D.: 3 17/32 (89.7) I.D.: 1 15/16 (49.2) Height: 5 5/16 (134.9)</p>
<p>RS10348</p> 	<p>Radial Seal Air Element Fits: Chevrolet HHR with 4-122 (2.0L) FI Turbo Replaces: ACDelco A3099C; General Motors 20774655; WIX 49459 O.D.: 4 13/32 (111.9) I.D.: 2 23/32 (69.1) One End Height: 7 5/32 (181.8)</p>	<p>PA10354</p>  <p>Air Element Fits: Cadillac Eldorado; Chevrolet Corvette; Dodge Charger Replaces: Chrysler 2402368; Ford ECJ-9601-B; Wix 542070, DT70, 42070 O.D.: 12 13/16 (325.4) I.D.: 11 1/32 (280.2) Height: 2 5/32 (54.8)</p>
<p>RS10349</p> 	<p>Radial Seal Air Element Contains: Mounting Band Fits: Ford Mustang V8-281 (4.6L) FI Engine Replaces: Motorcraft FA1895; WIX 49601 O.D.: 6 3/32 (154.8) I.D.: 4 (101.6) One End Height: 10 3/8 (263.5)</p>	<p>PA10355</p>  <p>Air Element Fits: Ford, Lincoln, Mercury Automotive Replaces: Ford C0AE-9601-B; Motorcraft FA5; Wix 542053, DT53, 42053 O.D.: 13 1/8 (333.4) I.D.: 10 5/8 (269.9) Height: 2 11/32 (59.5)</p>
<p>RS10350</p> 	<p>Conical Air Element Contains: Mounting Band Fits: Ford Mustang with V8-330 (5.4L) FI Supercharged Engine Replaces: Motorcraft FA1896; WIX 49896 O.D.: 5 21/32 (143.7) to 7 17/32 (191.3) I.D.: 5 3/8 (136.5) One End Height: 9 1/16 (230.2)</p>	<p>PA10356</p>  <p>Air Element Fits: Ford Mustang II Replaces: Ford D5ZF-9601-AA; Motorcraft FA605; Wix 542079, 42079 O.D.: 13 9/16 (344.5) I.D.: 11 11/32 (288.1) Height: 1 7/8 (47.6)</p>
<p>RS10351</p> 	<p>Air Element with Foam Wrap Fits: Volvo S60 R, V70 R Replaces: Volvo 8671488; WIX 42829 O.D.: 4 5/8 (117.5) I.D.: 3 1/16 (77.8) One End Height: 12 5/16 (312.7)</p>	<p>PA10357</p>  <p>Air Element Fits: Nissan Automotive, Light-Duty Trucks Replaces: Nissan 16546-U6710; Wix 42908 O.D.: 11 3/16 (284.2) I.D.: 9 3/32 (231.0) Height: 2 3/8 (60.3)</p>
<p>PA10352</p> 	<p>Air Element Fits: Ford Automotive, Engines, Trucks Replaces: Ford C3AZ-9601-B, C4AZ-9601-A; Motorcraft FA6; Wix 542056, 42300, 42056 O.D.: 9 3/4 (247.7) Top: 10 3/8 (263.5) I.D.: 7 7/16 (188.9) Height: 2 1/2 (63.5)</p>	<p>PA10358</p>  <p>Panel Air Element Fits: Mercedes-Benz Automotive Replaces: Mercedes-Benz 30946104; Wix 42365 Length: 13 1/16 (331.8) Width: 6 5/32 (156.4) Height: 1 21/32 (42.1)</p>
	<p>SA10359</p>  <p>Crankcase Breather Filter in Metal Housing Fits: Buick, Cadillac, Chevrolet, GMC, Pontiac Automotive, Light-Duty Trucks Replaces: General Motors Corp. 557240, 6424244; Wix 46987, 42993 Length: 2 5/8 (66.7) Width: 1 (25.4) Height: 2 17/32 (64.3)</p>	

Measurements Are Shown In Inches And (Millimeters)

WARNING: These products can expose you to chemicals, including Diisononyl Phthalate, Carbon black extracts, Nickel, 1,3 Butadiene, Ethylene Oxide, Epichlorohydrin, which are known to the State of California to cause cancer, and Bisphenol, Ethylene Glycol, Ethylene Oxide, 1,3 Butadiene, Epichlorohydrin, which are known to the State of California to cause birth defects or other reproductive harm. For more information go to www.P65Warnings.ca.gov.

SA10360 Crankcase Breather Filter in Plastic Housing
Contains: 13/16 In. Fitting
Fits: Buick, Cadillac, Chevrolet, GMC, Pontiac Automotive, Light-Duty Trucks
Replaces: General Motors Corp. 8996724, 25096399; Wix 42994
Length: 1 31/32 (50.0)
Width: 1 13/16 (46.0)
Height: 1 19/32 (40.5)



PA10368 Cabin Air Element
Contains: Charcoal Impregnated Media for Odor Control
Fits: Mercedes-Benz Automotive
Replaces: Mercedes-Benz 2038300118, 2038300918, 203830091864; Wix 24118
Length: 10 27/32 (275.4) to 13 (330.2)
Width: 7 11/32 (186.5)
Height: 1 11/32 (34.1)

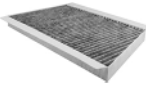

SA10361 Crankcase Breather Filter in Plastic Housing
Fits: AMC Automotive, Jeep
Replaces: Chrysler 3236695, J3236695; Wix 46988
Length: 1 7/8 (47.6)
Width: 1 15/32 (37.3)
Height: 1 7/16 (36.5)



PA10369 Cabin Air Element
Contains: Charcoal Impregnated Media for Odor Control
Fits: Buick LaCrosse, Regal, Verano; Cadillac ATS, XTS; Chevrolet Camaro, Cruze, Impala
Replaces: ACDelco CF184; General Motors Corp. 13356914, 13356916; Wix 24211
Length: 9 7/16 (239.7)
Width: 8 1/32 (204.0)
Height: 1 3/16 (30.2)

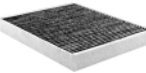

PA10362 Cabin Air Element
Fits: Pontiac Vibe; Toyota Tacoma
Replaces: General Motors Corp. 88970273; Wix 49358, 24871, 524871
Length: 8 1/16 (204.8)
Width: 8 1/16 (204.8)
Height: 25/32 (19.8)



PA10370 KIT Set of 2 Cabin Air Elements
Notes: Requires 2 filters per application.
Contains: Charcoal Impregnated Media for Odor Control
Fits: BMW X3, X4
Replaces: BMW (Bavarian Motor Works) 64319237157, 64319237158, 64319312318, 64319313316; Wix WP2076, SP2076
Length: 7 3/8 (187.3)
Width: 7 3/8 (187.3)
Height: 1 (25.4)

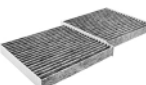

PA10363 Cabin Air Element
Contains: Charcoal Impregnated Media for Odor Control
Fits: Lexus GX470, RX330; Toyota 4Runner, Avalon, Camry, FJ Cruiser
Replaces: Toyota 87139-33010, 87139-YZZ03; Wix 24905
Length: 8 1/2 (215.9)
Width: 8 7/16 (214.3)
Height: 29/32 (23)
A. Gskt: [2] Attached

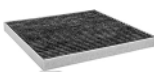

PA10371 Cabin Air Element
Fits: Hyundai Elantra
Replaces: Hyundai 87902L000A; Wix 24270
Length: 10 3/8 (263.5)
Width: 7 17/32 (191.3)
Height: 25/32 (19.8)
A. Gskt: [1] Attached

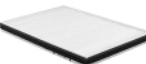

PA10364 Cabin Air Element
Fits: Hyundai Elantra
Replaces: Hyundai 87902-H000A
Length: 9 7/16 (239.7)
Width: 7 23/32 (196.1)
Height: 25/32 (19.8)
A. Gskt: [2] Included



PA10372 Cabin Air Element
Fits: Mitsubishi Mirage
Replaces: Mitsubishi 7850A002; Wix WP10125
Length: 6 31/32 (177.0)
Width: 6 31/32 (177.0)
Height: 3/4 (19)



PA10365 KIT Set of 2 Cabin Air Elements
Fits: Dodge Nitro; Jeep Liberty
Replaces: Chrysler 68033193AA; Wix 49093
Length: 7 1/8 (181.0)
Width: 3 19/32 (91.3)
Height: 25/32 (19.8)



PA10373 Cabin Air Element
Fits: Chevrolet Aveo, Aveo5; Pontiac G3, Wave
Replaces: General Motors Corp. 96435888, 96539649; Wix 24685
Length: 9 1/16 (230.2)
Width: 7 7/8 (200.0)
Height: 3/4 (19)
A. Gskt: [1] Attached



PA10367 Cabin Air Element with Pull Tab
Fits: Nissan Sentra
Replaces: Nissan 278913DF0A
Length: 10 5/32 (258.0)
Width: 5 29/32 (150.0)
Height: 31/32 (24.6)





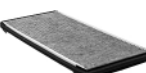



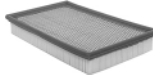
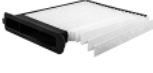

PA10374 Cabin Air Element
Contains: Charcoal Impregnated Media for Odor Control.
Fits: BMW X5; Land Rover Range Rover
Replaces: BMW (Bavarian Motor Works) 64318409044; Wix 24827
Length: 21 9/32 (540.5)
Width: 10 (254.0)
Height: 1 9/32 (32.5)
A. Gskt: [1] Attached



Measurements Are Shown In Inches And (Millimeters)

WARNING: These products can expose you to chemicals, including Diisononyl Phthalate, Carbon black extracts, Nickel, 1,3 Butadiene, Ethylene Oxide, Epichlorohydrin, which are known to the State of California to cause cancer, and Bisphenol, Ethylene Glycol, Ethylene Oxide, 1,3 Butadiene, Epichlorohydrin, which are known to the State of California to cause birth defects or other reproductive harm. For more information go to www.P65Warnings.ca.gov.

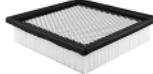
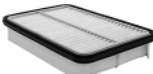
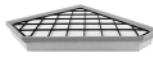
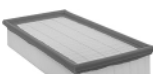
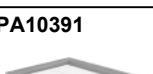
<p>PA10375</p> 	<p>Cabin Air Element Contains: Charcoal Impregnated Media for Odor Control Fits: BMW Automotive Replaces: BMW (Bavarian Motor Works) 64319071935; Wix 24673, 24473 Length: 26 19/32 (675.5) Width: 4 19/32 (116.7) Height: 1 3/32 (27.8) A. Gskt: [1] Included</p>	<p>PA10384</p> 	<p>Panel Air Element Fits: Ford GT, F-150 Pickups Replaces: Ford XL3Z-9601-AA; Wix 42572 Length: 12 7/8 (327.0) Width: 7 21/32 (194.5) Height: 1 7/8 (47.6)</p>
<p>PA10376</p> 	<p>Cabin Air Element Fits: Nissan Versa Replaces: Nissan 27891EL00A; Wix 24829 Length: 9 3/8 (238.1) Width: 6 21/32 (169.1) Height: 1 13/32 (35.7) A. Gskt: [1] Included</p>	<p>PA10385</p> 	<p>Panel Air Element with Foam Pad Fits: BMW 760Li, Apina B7; Rolls Royce Phantom Replaces: BMW (Bavarian Motor Works) 13717505007; Wix 46939 Length: 11 5/8 (295.3) Width: 7 3/16 (182.6) Height: 2 7/16 (61.9)</p>
<p>PA10378</p> 	<p>Panel Air Element Fits: Honda Civic with 1.3L Hybrid Engine Replaces: Honda 17220-RMX-000; Wix 49157 Length: 7 19/32 (192.9) Width: 7 1/32 (178.6) Height: 1 9/32 (32.5) A. Gskt: [1] Included</p>	<p>PA10386</p> 	<p>Panel Air Element Fits: Chevrolet Astra; Saturn Astra Replaces: General Motors Corp. 90531003, 93192885; Saturn 9117557; Wix 49522 Length: 11 1/2 (292.1) Width: 9 1/4 (235.0) Height: 1 5/8 (41.3)</p>
<p>PA10379</p> 	<p>Panel Air Element Fits: Mitsubishi Lancer, Outlander Replaces: Mitsubishi 1500A023; Wix 49023 Length: 10 9/16 (268.3) Width: 7 9/32 (184.9) Height: 2 1/8 (54) A. Gskt: [1] Attached</p>	<p>PA10387</p> 	<p>Panel Air Element Fits: Chevrolet Camaro Replaces: ACDelco A3137C; General Motors Corp. 92196275; Wix 49475 Length: 11 3/16 (284.2) Width: 9 1/4 (235.0) Height: 2 5/32 (54.8)</p>
<p>PA10380</p> 	<p>Panel Air Element Fits: Honda City, Fit Replaces: Honda 17220-RB0-000; Wix 49460 Length: 6 13/16 (173.0) Width: 6 21/32 (169.1) Height: 1 13/16 (46) A. Gskt: [1] Included</p>	<p>PA10388</p> 	<p>Panel Air Element Fits: 2019-20 Lexus UX200, ES300h; Toyota Avalon, Corolla, 2016-19 Mirai, 2018-20 Camry Hybrid, C-HR, 2019 RAV4 Replaces: Toyota 17801F0020, 178010T060, 1780177050; Luber-finer AF5286; Wix WA10807 Length: 10 11/16 (271.5) Width: 5 31/32 (151.4) Height: 1 15/32 (37.6)</p>
<p>PA10381</p> 	<p>Panel Air Element Fits: 2016-19 Acura ILX Replaces: Honda 17220R4HA00; Wix WA10334 Length: 11 9/16 (293.9) Width: 9 21/32 (245.1) Height: 1 3/8 (35.1)</p>	<p>PA10389</p> 	<p>Air Element Fits: Chevrolet Volt Replaces: ACDelco A3148C; General Motors Corp. 20871244; Wix 49244 Length: 7 17/32 (191.3) Width: 7 1/8 (181.0) Height: 1 23/32 (43.7)</p>
<p>PA10382</p> 	<p>Panel Air Element Fits: Geo Prizm; Toyota Corolla, Celica Replaces: Toyota 17801-16040; Wix 546242, 46242 Length: 9 27/32 (250.0) Width: 6 3/16 (157.2) Height: 1 11/16 (42.9)</p>	<p>PA10390</p> 	<p>Panel Air Element Fits: Cadillac ATS, CTS; Chevrolet Camaro Replaces: ACDelco A3178C; General Motors Corp. 20857930; Wix 49830 Length: 12 1/4 (311.2) Width: 2 3/4 (69.9) to 11 (279.4) Height: 1 1/8 (28.6) A. Gskt: [1] Included</p>
<p>PA10383</p> 	<p>Panel Air Element Fits: BMW 750iL, X5 Replaces: BMW (Bavarian Motor Works) 13721702907; Wix 49907 Length: 11 5/16 (287.3) Width: 5 29/32 (150.0) Height: 2 7/32 (56.4)</p>	<p>PA10391</p> 	<p>Panel Air Element Fits: Chevrolet Trax Replaces: General Motors Corp. 95021102; Wix WA10255 Length: 9 1/8 (231.8) Width: 6 11/32 (161.1) Height: 2 5/16 (58.7)</p>









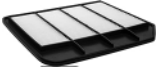
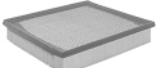

Measurements Are Shown In Inches And (Millimeters)

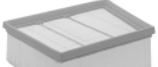
WARNING: These products can expose you to chemicals, including Diisononyl Phthalate, Carbon black extracts, Nickel, 1,3 Butadiene, Ethylene Oxide, Epichlorohydrin, which are known to the State of California to cause cancer, and Bisphenol, Ethylene Glycol, Ethylene Oxide, 1,3 Butadiene, Epichlorohydrin, which are known to the State of California to cause birth defects or other reproductive harm. For more information go to www.P65Warnings.ca.gov.

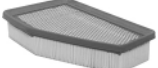
<p>PA10392 Panel Air Element  Fits: Land Rover Discovery Sport, Range Rover Evoque, LR2 Replaces: Land Rover LR029078; Wix WA10007 Length: 7 1/16 (179.4) Width: 8 7/16 (214.3) to 11 7/16 (290.5) Height: 2 5/16 (58.7)</p>	<p>PA10400 Cabin Air Element  Fits: Honda CR-V, Insight Replaces: Honda 80291-ST3-505, 80291-ST3-E01; Wix 24877 Length: 8 29/32 (226.2) Width: 7 27/32 (199.2) Height: 1 1/8 (28.6)</p>
<p>PA10393 Panel Air Element  Fits: BMW X3 with 4-1995cc (2.0) FI Turbo Diesel, 4-1997cc (2.0) Turbo Engines Replaces: BMW (Bavarian Motor Works) 13717601868; Wix 49468 Length: 12 9/32 (311.9) Width: 10 1/8 (257.2) Height: 1 15/32 (37.3)</p>	<p>PA10401 Cabin Air Element  Contains: Charcoal Impregnated Media for Odor Control. Fits: 2017-20 Chrysler Pacifica Replaces: Chrysler 68308950AB; Wix WP10316 Length: 9 7/8 (251.0) Width: 8 7/32 (209.0) Height: 25/32 (20.1)</p>
<p>PA10394 Panel Air Element  Fits: BMW Automotive Replaces: BMW (Bavarian Motor Works) 13717602643; Wix WA10403, WA10257 Length: 10 19/32 (269.1) Width: 8 5/8 (219.1) Height: 1 15/32 (37.3)</p>	<p>PA10402 Cabin Air Element  Fits: 2015-20 Nissan Rogue, 2019-20 Rogue Sport Replaces: Nissan 272774BU0A; Mann & Hummel CU25003, FP25003; Wix WP10179 Length: 9 7/8 (251.0) Width: 7 3/32 (180.1) Height: 1 3/8 (35.1)</p>
<p>PA10395 Panel Air Element  Fits: BMW Automotive Replaces: BMW (Bavarian Motor Works) 13718507320; Wix WA10005 Length: 8 31/32 (227.8) Width: 8 1/32 (204.0) Height: 1 5/8 (41.3)</p>	<p>PA10403 Panel Air Element  Fits: 2016-2020 Chevrolet Spark Replaces: General Motors Corporation 95238310; Wix WA10415 Length: 8 1/16 (204.7) Width: 6 3/32 (154.7) Height: 1 15/32 (37.6) A. Gskt: [1] Included</p>
<p>PA10396 Cabin Air Element  Fits: 2018-20 Jeep Wrangler, 2020 Gladiator Replaces: Chrysler 68301863AA; Luber-finer CAF10022P; Wix WP10371 Length: 9 7/16 (240.0) Width: 7 7/8 (200.0) Height: 21/32 (17)</p>	<p>PA10404 Cabin Air Element  Contains: Charcoal Impregnated Media for Odor Control. Fits: 2015-19 Audi A3, A3 Quattro; 2015-16 S3; 2016-17 A3 Sportback e-tron, TT Quattro; 2015 Volkswagen Golf SportWagen; 2015-17 Golf; 2015-18 e-Golf; Golf; 2015-19 Golf R, GTI; 2018-19 Atlas; Volkswagen European Light-Duty Vehicles Replaces: Volkswagen 5Q0819653; Fram CF11643; Luber-finer CAF1945C; Mann & Hummel CUK26009; Wix WP10159 Length: 10 (254.0) Width: 9 1/4 (235.0) Height: 1 1/4 (32)</p>
<p>PA10397 Panel Air Element  Fits: Chevrolet Automotive Replaces: General Motors Corp. 25043246; Wix 46140 Length: 6 21/32 (169.1) Width: 6 21/32 (169.1) Height: 1 9/16 (39.7)</p>	<p>PA10405 Oval Air Element  Fits: 2014-19 Chevrolet Corvette Replaces: General Motors Corp. 23107355; ACDelco A3191C; Fram CA12062; Luber-finer AF6191; Wix WA10171 O.D.: 5 1/8 (130.0) To 9 5/8 (244.1) I.D.: 2 13/32 (61.0) & 6 7/8 (175.0) To Height: 8 13/32 (213.6)</p>
<p>PA10398 Panel Air Element  Fits: Audi, Volkswagen Automotive Replaces: Volkswagen 859129620; Wix 46240 Length: 12 1/4 (311.2) Width: 7 1/4 (184.2) Height: 2 7/32 (56.4)</p>	
<p>PA10399 Air Element  Replaces: General Motors Corp. 6422468; Wix 42032 O.D.: 5 5/16 (134.9) I.D.: 4 (101.6) Height: 2 7/32 (56.4)</p>	

Measurements Are Shown In Inches And (Millimeters)

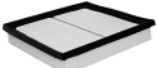
WARNING: These products can expose you to chemicals, including Diisononyl Phthalate, Carbon black extracts, Nickel, 1,3 Butadiene, Ethylene Oxide, Epichlorohydrin, which are known to the State of California to cause cancer, and Bisphenol, Ethylene Glycol, Ethylene Oxide, 1,3 Butadiene, Epichlorohydrin, which are known to the State of California to cause birth defects or other reproductive harm. For more information go to www.P65Warnings.ca.gov.

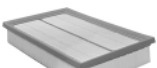
<p>PA10406 Panel Air Element Fits: 2017-21 Nissan Armada; 2011-13 Infiniti QX56, 2014-20 QX80 Replaces: Nissan 165461LA0A; Fram CA11002; Luber-finer AF5193; Wix WA10298 Length: 13 5/16 (338.1) Width: 12 7/16 (316.0) Height: 1 5/16 (33.5) A. Gskt: [1] Included</p> 	<p>PA10414 Panel Air Element Fits: 2019-20 Lexus ES350; Toyota Avalon, RAV4, 2018-20 Camry, 2020 Highlander Replaces: Toyota 17801F0050; Wix WA10859 Length: 9 9/16 (242.6) Width: 8 3/4 (222.0) Height: 1 27/32 (46.5)</p> 
<p>PA10407 Panel Air Element Fits: 2017-20 Honda Civic with 2.0L Turbo Engine Replaces: Honda 172205BFA00; Wix WA10967 Length: 9 11/16 (246.4) Width: 6 21/32 (168.9) Height: 1 25/32 (45)</p> 	<p>PA10415 Panel Air Element Fits: 2016-20 Mazda CX-3, 2017-18 Mazda 3 Sport Replaces: Mazda PEHH133A0; Luber-finer AF5261; Wix WA10395 Length: 8 15/16 (227.1) Width: 8 11/32 (211.8) Height: 1 9/16 (39.9) A. Gskt: [1] Included</p> 
<p>PA10408 Panel Air Element Fits: 2018-20 Ford EcoSport Replaces: Ford Motor GN1Z9601A; Motorcraft FA1935; Wix WA10831 Length: 8 7/16 (214.4) Width: 6 1/4 (158.5) Height: 2 11/16 (68.1)</p> 	<p>PA10416 Panel Air Element Fits: 2021 Cadillac Escalade; 2021 Chevrolet Suburban, Tahoe, 2019-20 Silverado 1500; 2021 GMC Yukon, Yukon XL, 2020 Sierra 1500 Replaces: ACDelco A3246C; GM General Motors 84121217; Fram CA12404; Luber-finer AF9243; Wix WA10941 Length: 12 11/16 (322.1) Width: 9 3/4 (247.4) Height: 2 9/32 (57.9)</p> 
<p>PA10409 Panel Air Element Fits: 2019-20 Jeep Cherokee with 2.4L & 3.2L Engines Replaces: Chrysler 68245310AA Length: 10 7/8 (276.2) Width: 6 15/16 (176.5) Height: 2 1/4 (57.4)</p> 	<p>PA10417 Panel Air Element with Foam Pad Fits: 2021 Cadillac Escalade; 2021 Chevrolet Suburban, Tahoe, 2019-20 Silverado 1500, 2020 Silverado 2500 HD, Silverado 3500 HD; 2021 GMC Yukon, Yukon XL, 2019-20 Sierra 1500; 2020 Sierra 2500 HD, Sierra 3500 HD Replaces: ACDelco A3244C; GM General Motors 84121219; Luber-finer AF9244; Wix WA10942 Length: 12 11/16 (322.1) Width: 9 3/4 (247.4) Height: 3 1/16 (78)</p> 
<p>PA10410 Panel Air Element Fits: 2018-20 Jeep Wrangler, 2020 Gladiator Replaces: Chrysler 68257030AA; Luber-finer AF5277; Wix WA10841 Length: 12 5/32 (309.1) Width: 7 1/32 (178.6) Height: 2 9/32 (57.9)</p> 	<p>PA10418 Panel Air Element Fits: 2019-20 Nissan Altima Replaces: Nissan 165466CA0A; Luber-finer AF10040; Wix WA10947 Length: 9 5/8 (244.6) Width: 8 31/32 (228.1) Height: 1 1/8 (29) A. Gskt: [1] Included</p> 
<p>PA10411 Cabin Air Element Fits: 2016-20 Hyundai Tucson, 2019 Veloster, 2019-20 Veloster N; 2017-19 Kia Sportage Replaces: Hyundai 97133D3000; Fram CF12160; Luber-finer CAF1948P; Mann & Hummel CU23019; Wix WP10265 Length: 8 13/16 (224.0) Width: 7 7/8 (199.9) Height: 1 3/32 (27.9)</p> 	<p>PA10419 Panel Air Element Fits: 2019-21 Subaru Ascent, Forester, 2018-21 Crosstrek, 2017-21 Impreza, 2020-22 Legacy, Outback Replaces: Subaru 16546AA16A; Fram CA12295; Luber-finer AF5293; Wix WA10713 Length: 9 3/32 (230.9) Width: 8 5/8 (218.9) Height: 1 9/16 (39.9)</p> 
<p>PA10412 Cabin Air Element Contains: Charcoal Impregnated Media for Odor Control Fits: 2016-20 Toyota Tacoma Replaces: Toyota 8850804010 Length: 8 3/32 (205.5) Width: 8 (202.9) Height: 25/32 (19.8)</p> 	<p>PA10420 Panel Air Element Fits: 2019-21 Volkswagen Golf, Jetta Replaces: Volkswagen 5QM129620B; Luber-finer AF3635; Wix WA11003 Length: 10 29/32 (277.0) Width: 6 23/32 (170.7) Height: 1 15/16 (49.2)</p> 











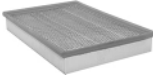

Measurements Are Shown In Inches And (Millimeters)

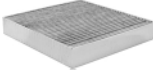
WARNING: These products can expose you to chemicals, including Diisononyl Phthalate, Carbon black extracts, Nickel, 1,3 Butadiene, Ethylene Oxide, Epichlorohydrin, which are known to the State of California to cause cancer, and Bisphenol, Ethylene Glycol, Ethylene Oxide, 1,3 Butadiene, Epichlorohydrin, which are known to the State of California to cause birth defects or other reproductive harm. For more information go to www.P65Warnings.ca.gov.

<p>PA10421 Panel Air Element with Foam Pad Fits: 2019-22 Volvo S60, V60, 2018-21 V90, 2017-22 S90, 2021-22 V60 Cross Country, 2017-21 V90 Cross Country, 2018-22 XC60, 2016-22 XC90 Replaces: Volvo 31370089; Luber-finer AF3629; Wix WA10360 Length: 7 7/8 (200.0) to 11 5/16 (287.3) Width: 5 23/32 (145.3) to 9 7/32 (234.2) Height: 2 7/16 (61.9)</p> 	<p>PA10427 Panel Air Element Fits: 2020-21 Ford F-250 Super Duty, F-350 Super Duty, 2020 F-450 Super Duty, F-550 Super Duty trucks Replaces: Ford Motor LC3Z9601A; Motorcraft FA1950 Length: 12 3/8 (313.9) Width: 11 3/8 (288.8) Height: 2 7/32 (56.4)</p> 
<p>PA10422 Panel Air Element Fits: 2016 Scion iA; 2019-20 Toyota Yaris, 2017-19 Yaris iA Replaces: Mazda P53N133A0; Toyota 17801WB001; Luber-finer AF5262; Mann+Hummel C23018; Wix WA10408 Length: 8 15/16 (227.1) Width: 6 25/32 (172.5) Height: 1 5/8 (40.9) A. Gskt: [1] Included</p> 	<p>PA10428 Panel Air Element with Foam Pad Fits: 2020-21 Ford F-250 Super Duty, F-350 Super Duty, 2020 F-450 Super Duty, 2020-21 F-550 Super Duty, F-600 Super Duty Trucks Use With: SA10429 (Pre-Cleaner) Replaces: Ford Motor LC3Z9601B; Motorcraft FA1951 Length: 12 13/32 (315.0) Width: 11 3/8 (289.1) Height: 3 (75.9)</p> 
<p>PA10423 Panel Air Element with Foam Pad Fits: 2018-20 Chevrolet Express Van 2500, Express Van 3500; GMC Savana 2500, Savana 3500. All with 4.3L Engine. Replaces: AC Delco A3228C; GM General Motors 84065602; Luber-finer AF5301; Wix WA10836 Length: 18 5/32 (461.0) Width: 6 31/32 (177.0) Height: 1 1/2 (38.1)</p> 	<p>SA10429 Foam Pre-Cleaner Fits: 2020 Ford F-250 Super Duty, F-350 Super Duty, F-450 Super Duty, F-550 Super Duty trucks Use With: PA10428 (Panel Air Element) Replaces: Ford Motor LC3Z9601C; Motorcraft FA1952 Length: 10 3/4 (273.0) Width: 3 3/8 (86.1) Height: 1 13/16 (46)</p> 
<p>PA10424 Panel Air Element with Foam Pad Fits: 2018-21 Nissan Kicks, 2020-21 Versa Replaces: Nissan 165465RB1A; Luber-finer AF10035; Wix WA10908 Length: 7 3/4 (197.1) Width: 5 7/8 (149.1) Height: 1 13/32 (36.1) A. Gskt: [1] Included</p> 	<p>PA10430 Panel Air Element with Foam Pad Fits: 2021 Buick Envision, 2018-20 Buick Regal Sportback, Regal TourX; 2019-21 Cadillac XT4, 2018-21 Chevrolet Malibu Replaces: ACDelco A3210C; GM General Motors 23430313; Luber-finer AF3210; Mann+Hummel C35015; Wix WA10419 Length: 13 25/32 (350.0) Width: 9 1/8 (231.4) Height: 2 1/16 (52.1)</p> 
<p>PA10425 Panel Air Element Fits: 2017-19 Nissan NV2500, 2019 NV3500, 2017 Titan, 2016-18 Titan XD Replaces: Nissan 16546EZ31B; Wix WA10680 Length: 11 11/32 (288.0) Width: 10 31/32 (278.9) Height: 1 1/2 (38.1) A. Gskt: [1] Included</p> 	<p>PA10431 Cabin Air Element Fits: 2019-22 Ford Ranger Replaces: Ford Motor KB3Z19N619A; Motorcraft FP88; Luber-finer CAF1963P; Wix WP10410 Length: 9 5/32 (232.9) Width: 8 1/2 (215.9) Height: 1 3/16 (30)</p> 
<p>PA10426 Panel Air Element with Foam Pad Contains: Flame Retardant Media Fits: 2020-21 Chevrolet Silverado 2500 HD, Silverado 3500 HD, GMC Sierra 2500 HD, Sierra 3500 HD w/6.6L Turbo Diesel Eng. Replaces: ACDelco A3248C; GM General Motors 84554703; Luber-finer LAF9248; Wix WA11057 Length: 13 3/8 (340.1) Width: 9 1/8 (231.9) Height: 3 (75.9)</p> 	<p>PA10433 Panel Air Element with Pull Tab Fits: 2018-21 Honda Accord Replaces: Honda 1722-06A-0A00; Fram CA12290; Luber-finer AF5296; Wix WA10813 Length: 7 13/16 (198.4) Width: 6 13/16 (173.0) Height: 2 3/32 (53.1) A. Gskt: [1] Included</p> 
	<p>PA10435 Panel Air Element with Foam Pad Fits: 2019-21 Jeep Cherokee Replaces: Chrysler 68320315AB; Fram CA12372; Luber-finer AF10031; Wix WA11042 Length: 15 15/16 (404.9) Width: 6 1/4 (159.0) Height: 2 9/32 (57.9)</p> 

Measurements Are Shown In Inches And (Millimeters)

WARNING: These products can expose you to chemicals, including Diisononyl Phthalate, Carbon black extracts, Nickel, 1,3 Butadiene, Ethylene Oxide, Epichlorohydrin, which are known to the State of California to cause cancer, and Bisphenol, Ethylene Glycol, Ethylene Oxide, 1,3 Butadiene, Epichlorohydrin, which are known to the State of California to cause birth defects or other reproductive harm. For more information go to www.P65Warnings.ca.gov.

<p>PA10436 Panel Air Element Fits: 2019-22 Ford Transit Connect; 2020-22 Escape, 2021-22 Bronco Sport; 2020-22 Lincoln Corsair Replaces: Ford Motor JX6Z9601A; Motorcraft FA1939; Luber-finer AF6939; Wix WA10981 Length: 10 1/2 (267.0) Width: 8 1/32 (204.0) Height: 1 21/32 (41.9)</p> 	<p>CV15001 Crankcase Breather Fits: Mercedes-Benz Actros I Series, Actros II Series Trucks with Mercedes-Benz OM501LA, OM502LA Engines Replaces: Mercedes-Benz 5410100080 O.D.: 2 1/4 (57.2) I.D.: 1 3/4 (44.4) One End Height: 4 13/16 (122.2) O-Ring: [1] Attached, [1] Included</p> 
<p>PA10438 Panel Air Element Fits: 2019-21 RAM 1500, 2021 1500 Classic Replaces: Chrysler 68386779AA; 68441763AA Length: 13 25/32 (350.0) Width: 9 3/8 (238.0) Height: 1 31/32 (50)</p> 	<p>CV15002 Crankcase Breather Fits: Case Dump Trucks; Case-IH Steiger, Steiger Tractors; New Holland Combines Replaces: Iveco 504209107 Length: 10 11/32 (262.7) Width: 5 15/32 (138.9) Height: 31/32 (24.6) A. Gskt: [2] Attached</p> 
<p>PA10439 Cabin Air Element Contains: Charcoal Impregnated Media for Odor Control Fits: 2019-21 Nissan Altima Replaces: Nissan 272776CA0A, 272776CA1A; Luber-finer CAF10027C; Wix WP10447 Length: 8 15/32 (214.9) Width: 7 29/32 (200.9) Height: 1 3/8 (35.1)</p> 	<p>CV15003 Crankcase Breather Fits: Detroit Diesel Series 50, Series 60 Engines Replaces: Detroit Diesel 23522898; Racor CCV5524808 O.D.: 3 25/32 (96.0) I.D.: 7/8 (22.2) One End Height: 5 31/32 (151.6) O-Ring: [2] Included</p> 
<p>PA10440 Cabin Air Element Fits: 2021-22 Ford Bronco Sport, Mustang Mach-E, 2020-22 Escape, Explorer, 2020-21 Police Interceptor Utility; 2020-22 Lincoln Aviator, Corsair Replaces: Ford Motor JX6Z19N619BA; Motorcraft FP89; Luber-finer CAF10059P Length: 10 7/8 (276.1) Width: 8 29/32 (226.1) Height: 1 9/16 (39.9)</p> 	<p>CV15004 Crankcase Breather Fits: Spiracle Crankcase Ventilation Systems for Various Diesel Trucks and Equipment Replaces: Donaldson P607673 O.D.: 5 3/32 (129.4) I.D.: 2 1/8 (54.0) One End Height: 7 19/32 (192.9)</p> 
<p>PA10441 Panel Air Element Fits: 2020-22 Ford Explorer, 2020-21 Police Interceptor Utility Replaces: Ford Motor L1MZ9601A; Motorcraft FA1947; Luber-finer AF6947; Wix WA10910 Length: 11 13/16 (300.0) Width: 5 5/8 (143.0) Height: 2 9/32 (57.9)</p> 	<p>CV15005 Crankcase Breather Fits: Caterpillar, John Deere Marine Engines Replaces: John Deere RE530346; Fleetguard CV55018 O.D.: 5 1/16 (128.6) I.D.: 1 1/4 (31.8) One End Height: 8 1/16 (204.8) O-Ring: [2] Included</p> 
<p>CV15000 Crankcase Breather Fits: Autocar, Cummins, Freightliner, IHC, Kenworth, Mack, Peterbilt, Volvo Trucks with Cummins ISM, ISX Engines Replaces: Cummins 3683918, 3685528, 391476, 4312011, 4312013; Fleetguard CV50031, CV50633, CV50634, CV50617, CV50601, CV50607 Length: 11 1/8 (282.6) Width: 8 15/16 (227.0) Height: 2 21/32 (67.5) A. Gskt: [2] Attached</p> 	<p>CV15006 Crankcase Breather Contains: Instruction Sheet Foam Tubing Cap Replacement Washers Fits: Case Dozers; Case-International Tractors; New Holland Dozers, Motor Graders; Steyr Tractors Replaces: Case 87304662; New Holland 87304662 O.D.: 5 3/4 (146.0) Height: 3 5/16 (84.1) O-Ring: [2] Included</p> 

Measurements Are Shown In Inches And (Millimeters)

WARNING: These products can expose you to chemicals, including Diisononyl Phthalate, Carbon black extracts, Nickel, 1,3 Butadiene, Ethylene Oxide, Epichlorohydrin, which are known to the State of California to cause cancer, and Bisphenol, Ethylene Glycol, Ethylene Oxide, 1,3 Butadiene, Epichlorohydrin, which are known to the State of California to cause birth defects or other reproductive harm. For more information go to www.P65Warnings.ca.gov.

CV15007 Crankcase Breather
Fits: Caterpillar C13, C15 On-Highway Engines
Replaces: Racor CV55603-02, CV55603-03; Caterpillar 3286272, 3805839; IHC (International Harvester) 3007357C1
O.D.: 3 9/16 (90.5)
Lid 4 9/16 (115.9)
I.D.: 1/2 (12.7) & 23/32 (18.3)
Height: 9 31/32 (253.2)
O-Ring: [2] Attached



CV15008 Crankcase Breather
Fits: Caterpillar C13, C15
Replaces: Caterpillar 2968325, 3805840; Racor CV55603; Fleetguard CV50304
O.D.: 3 11/16 (93.7)
Top 4 7/16 (112.5)
Height: 8 1/2 (215.9)
O-Ring: [2] Attached



CV15010 Crankcase Breather
Fits: Blue Bird, IC Corporation, New Flyer, Solaris, Thomas Buses; Autocar, Capacity of Texas, Ford, Freightliner, International, Kenworth, Mack Ottawa, Peterbilt, Rainier, RAM, Sterling Medium/Heavy-Duty Trucks; RAM Light-Duty Trucks
Replaces: Chrysler 68002433AA, 68002433AB; Cummins 4936636; Dorman 904418; Dynapac 4812041782; Fleetguard CV52001
Length: 16 3/8 (415.5)
Width: 6 7/8 (174.8)
Height: 2 31/32 (75.4)
O-Ring: [3] Attached



CV15011 Crankcase Breather
Fits: Mitsubishi Trucks; Tadano Cranes
Replaces: Isuzu 8976063180; Mitsubishi ME302763
O.D.: 2 27/32 (71.9)
I.D.: 1 1/16 (26.9)
Height: 3 1/32 (77.0)
O-Ring: [1] Included



CV15015 Crankcase Breather
Fits: Caterpillar Marine Engines
Replaces: Caterpillar 2747913; Racor CCV5527410; Donaldson P636077; Wix WS10116
O.D.: 5 3/32 (129.3)
Height: 8 1/32 (203.7)
O-Ring: [2] Included



BA16000 Air Dryer Filter
Contains: [4] Bolts and Nuts
 [4] Locking Pins
Fits: Volvo Dump Trucks, Excavators; European FH Serie Trucks
Replaces: EvoBus 4294695; Haldex 78964, 83212, 92528, 93522; Iveco 42535061; Renault 5001826800; Volvo 20424148, 20546795, 20773824
O.D.: 6 (152.4)
Height: 6 3/8 (161.9)
O-Ring: [1] Included



PE17000 Diesel Exhaust Fluid Filter
Contains: Plug and Filter Removal Tool
Fits: Autocar, Blue Bird, DAF, Ford, Foton, Freightliner, Heuliez, Hino, International, Isuzu, Iveco, Kenworth, Mack, Peterbilt, R.V.I., Spartan, Solaris, Volvo, Western Star, and Off-Hwy Equipment using Diesel Exhaust Fluid
Replaces: Bosch 1457436033; Caterpillar 3783187; Cummins 5303604; Daf 2014774; Fendt V837079423; Fiat 47364243; Fleetguard UF101; Isuzu 8981694030; Iveco 47364243; John Deere RE554498; Mack 21516231; New Holland 47364243; Volvo 21516229; Wix W74B191
O.D.: 1 3/4 (44.3)
I.D.: 29/32 (22.9) & 13/16 (20.3)
Height: 3 23/32 (94.5)
O-Ring: [2] Attached



PE17001 Diesel Exhaust Fluid Strainer
Fits: Mack, Nissan UD and Volvo Trucks
Replaces: Mack 82269261; Nissan 5282269261
O.D.: 15/16 (23.8)
 1 13/16 (46.0)
I.D.: 25/32 (19.8) One End
Height: 7 17/32 (191.3)

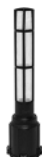

PE17002 KIT Diesel Exhaust Fluid Filter Kit
Contains: Frost Compensation Membrane, Spray Lubricant, Instruction Sheet
Fits: Freightliner 108SD, 114SD, 122SD, Business Class M2 106, Cascadia, Cascadia Evolution, Coronado, Coronado SD, M2 106, M2 112; Kenworth T880; Mercedes Benz European Trucks; Western Star 4900EX, 4900FA, 4900SA, 5700XE, 6900XD
Replaces: Bomag 4388378; Claas 0019999480; Cummins 4388378; Daf 2122909; Fleetguard UF106; FONHO Automotive Co., Ltd. UT4702; Freightliner 1421089; Mann+Hummel U58/7KIT, U58/9KIT; Mercedes-Benz A0001420589, A0001420789, A0001420989, A0001421089; Paccar 2122909PE;
O.D.: 1 11/16 (42.7)
I.D.: 19/32 (15.2) One End
Height: 3 5/32 (80)
O-Ring: [1] Included
Filter Housing
O.D. 2 15/16
Height 4
O-Ring [1] Attached



Measurements Are Shown In Inches And (Millimeters)

WARNING: These products can expose you to chemicals, including Diisononyl Phthalate, Carbon black extracts, Nickel, 1,3 Butadiene, Ethylene Oxide, Epichlorohydrin, which are known to the State of California to cause cancer, and Bisphenol, Ethylene Glycol, Ethylene Oxide, 1,3 Butadiene, Epichlorohydrin, which are known to the State of California to cause birth defects or other reproductive harm. For more information go to www.P65Warnings.ca.gov.

18002



Transmission Filter

Notes: Pan gasket contains [14] bolt holes.
Fits: 1992-99 Ford, 1991-95 Lincoln, 1992-95 Mercury Automotive with AOD-E, AODE-W Transmissions (2WD, RWD)
Replaces: Ford F2VY-7A098-A; Wix 51877, 58877
Length: 8 3/4 (222.3)
Width: 7 1/8 (181.0)
Height: 4 27/32 (123)
Pan Gasket: [1] Included

18004



Transmission Filter

Notes: Pan gasket contains [14] bolt holes.
Fits: Chrysler, Eagle, Mitsubishi Automotive, Vans with Torque-Flite 40TE, 41AE, 41TE, (A604) Transmissions (FWD, 4 Spd. with Overdrive)
Replaces: Chrysler 4505048
Length: 7 3/16 (182.6)
Width: 6 29/32 (175.4)
O-Ring: [1] Included
Pan Gasket: [1] Included

18007



Transmission Filter

Contains: [1] Plastic Neck Seal
[1] Information Sheet
Fits: 1991-96 Chevrolet, GMC Light-Duty Trucks, Vans, 1994-99 AM General, 1993-97 Jaguar Automotive with 4L80-E Electronic Transmission (RWD, 4 Spd.)
Replaces: GMC 8684221
Length: 8 17/32 (216.7)
Width: 7 (177.8)

18009



Transmission Filter

Notes: Pan gasket contains [16] bolt holes.
Contains: [2] Plastic Neck Seals
[2] Filters
Fits: 2006-11 Buick Lucerne, 1993-2011 Cadillac, 1995-99, 2001-03 Oldsmobile Aurora, 2004-05 Pontiac Bonneville with 4T80-E Electronic Transmission (FWD, 4 Spd.)
Replaces: General Motors Corp. 8684953; Wix 51895, 58895
Length: 9 17/32 (242.1)
Width: 5 1/2 (139.7)
Height: 1 5/8 (41.3)
Pan Gasket: [1] Included

18010



Transmission Filter

Notes: Pan gasket contains [16] bolt holes.
Contains: [1] Plastic Neck Seal
[1] Information Sheet
Fits: 1994-96, 2004-07 Buick, 1994-2006 Cadillac, 1993-on Chevrolet, 1996-2000, 2003-08 Isuzu, 1993-2004 Oldsmobile, 1993-2002 Pontiac, 2006-09 Saab Automotive; 1993-on GMC Light-Duty Trucks, Vans, with 4L6 Transmission
Replaces: GMC 24200796
Length: 9 1/2 (241.3)
Width: 7 17/32 (191.3)
Height: 3 3/4 (95.3)
Pan Gasket: [1] Included

18011



Transmission Filter

Notes: Pan gasket contains [21] bolt holes.
Fits: 1996-99, 2002-04 Infiniti, 1993-2002 Mercury Villager, 1992-2002 Nissan Automotive with 4F20E Transmission (FWD)
Replaces: Nissan 31728-80X03; Wix 58602
Length: 6 7/32 (158.0)
Width: 5 23/32 (145.3)
Height: 1 5/32 (29.4)
Pan Gasket: [1] Included

18012



Transmission Filter

Notes: Pan gasket contains [14] bolt holes.
Fits: 2001-2004 Chevrolet Tracker, 1986-87 Isuzu Light-Duty Trucks, 1995-2002 Kia Sportage, 1989-2005 Suzuki, 1982-86, 1991-97 Toyota Automotive
Replaces: Toyota 35303-30060; Wix 51951, 58951
Length: 5 3/4 (146.0)
Width: 5 23/32 (145.3)
Height: 3/8 (9.5)
F. Gskt: [1] Included
Pan Gasket: [1] Included

18013



Transmission Filter

Notes: Pan gasket contains [15] bolt holes.
Contains: Clip for Solenoid Wire
Fits: 1985-88 Chevrolet Spectrum; 1989-93 Geo; 1985-2001 Toyota Automotive with A140E, A140L Transmissions (FWD, 4 Spd.)
Replaces: Toyota 35330-32022; Wix 58994, 51994
Length: 7 5/8 (193.7)
Width: 4 15/32 (113.5)
Height: 21/32 (16.7)
Pan Gasket: [1] Included

18022



Transmission Filter

Notes: Can only be used with 2 1/4 In. deep pan.
Contains: [1] Plastic Neck Seal
Instruction Sheet
Fits: 1991-2011 Buick, Chevrolet, 1991-95 Cadillac, 1991-2004 Oldsmobile, 1992-2009 Pontiac, 2005-09 Saturn Automotive with 4T60-E Electronic Transmissions (FWD, 4 Spd.)
Replaces: GMC 24206433
Length: 10 19/32 (269.1)
Width: 6 13/16 (173.0)
Height: 2 5/32 (54.8)
Related To: 20014 (with Pan Gasket)

18024



Transmission Filter

Notes: Pan gasket contains [18] bolt holes.
Contains: [1] Mounting Bolt
[1] Rubber Seal
Fits: 1989-on Ford Automotive, Light-Duty Trucks, 1991-2009 Mazda Light-Duty Trucks, 1998-2001 Mercury Mountaineer with A4LD Transmission (RWD, 4 Spd.)
Replaces: Ford F9TZ-7A098-C; Mazda ZL2L-21-500
Length: 11 1/2 (292.1)
Width: 5 15/32 (138.9)
Height: 1 1/16 (27.0)
O-Ring: [2] Attached
Pan Gasket: [1] Included

Measurements Are Shown In Inches And (Millimeters)

WARNING: These products can expose you to chemicals, including Diisononyl Phthalate, Carbon black extracts, Nickel, 1,3 Butadiene, Ethylene Oxide, Epichlorohydrin, which are known to the State of California to cause cancer, and Bisphenol, Ethylene Glycol, Ethylene Oxide, 1,3 Butadiene, Epichlorohydrin, which are known to the State of California to cause birth defects or other reproductive harm. For more information go to www.P65Warnings.ca.gov.

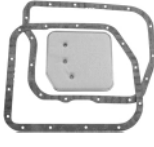
<p>18025 Transmission Filter</p>  <p>Notes: Pan gasket contains [18] bolt holes. Contains: [1] Mounting Bolt [1] Rubber Seal Fits: Ford, Mazda Automotive, Light-Duty Trucks, Vans with A4LD Transmission (4WD, RWD, 4 Spd., Deep Pan) Replaces: Ford 85GT-7A098-AC; Mazda ZZL2-21-500 Length: 11 1/2 (292.1) Width: 5 15/32 (138.9) Height: 2 9/32 (57.9) Pan Gasket: [1] Included</p>	<p>18033 Transmission Filter</p>  <p>Notes: [1] Pan gasket contains [17] bolt holes. [1] Pan gasket contains [19] bolt holes. Contains: Mounting Bracket Fits: Ford Automotive with AX4N, AX4S Transmissions (FWD, 4 Spd., Deep Pan) Replaces: Ford F5DZ-7A098-A Length: 7 13/32 (188.1) Width: 7 1/16 (179.4) Height: 2 7/32 (56.4) Pan Gasket: [2] Included</p>
<p>18027 Transmission Filter</p>  <p>Notes: Reuse OEM gasket. Contains: [1] Plastic Neck Seal Fits: 2000-04 AM General, 2002-06 Cadillac Escalade, 1997-on Chevrolet, GMC Light-Duty Trucks, Vans with 4L80-E Electronic Transmission (RWD, 4 Spd.) Replaces: GMC 24208847 Length: 8 17/32 (216.7) Width: 7 1/8 (181.0) Height: 1 1/8 (28.6)</p>	<p>18034 Transmission Filter</p>  <p>Notes: Pan gasket contains [19] bolt holes. Fits: Ford, Mercury Automotive, Vans with AX4S, AX4N Transmissions (Shallow Pan) Replaces: Ford F6DZ-7A098-A Length: 7 13/32 (188.1) Width: 7 1/16 (179.4) Pan Gasket: [1] Included</p>
<p>18029 Transmission Filter</p>  <p>Notes: Pan gasket contains [14] bolt holes. Fits: 1994-on Ford, 1996-2011 Lincoln, Mercury Automotive with AOD-E Transmission (4WD, RWD) Replaces: Ford F4TZ-7A098-A, F6AZ-7A098-A Length: 9 9/16 (242.9) Width: 7 1/8 (181.0) Height: 2 3/4 (69.9) Grommets: [1] Attached Pan Gasket: [1] Included</p>	<p>18055 Transmission Filter</p>  <p>Notes: Both pan gaskets contain [14] bolt holes. Fits: Dodge Automotive, Light-Duty Trucks, Vans, Jeep Light-Duty Trucks with 42RE, 46RE, 47RE Transmissions Replaces: Chrysler 52118789 Length: 7 3/16 (182.6) Width: 7 1/8 (181.0) Height: 31/32 (24.6) Pan Gasket: [2] Included</p>
<p>18031 Transmission Filter</p>  <p>Notes: Pan gasket contains [13] bolt holes. Fits: 1975-83 Buick, Oldsmobile, Pontiac, 1980 Cadillac, 1976-83 Chevrolet Automotive, 1977-80, 1983 GMC Light-Duty Trucks with THM350, THM350C, THM375B Transmissions (RWD, 3 Spd., Buick Built) Replaces: GMC 8641910; WIX 51894, 58894 Length: 7 15/32 (189.7) Width: 7 (177.8) F. Gskt: [1] Included Pan Gasket: [1] Included</p>	<p>18056 Transmission Filter</p>  <p>Notes: Pan gasket contains [16] bolt holes. Contains: [1] Plastic Neck Seal Fits: 2004-07 Buick Rainier, 1999-2006 Cadillac Escalade, 1998-on Chevrolet, GMC Light-Duty Trucks, Vans, 2003-07 Hummer H2, 1998-2008 Isuzu, 1993-2004 Oldsmobile Bravada, 2004-06 Pontiac GTO, 2005-09 Saab Replaces: GMC 24208576 Length: 9 7/16 (239.7) Width: 7 17/32 (191.3) Height: 4 23/32 (119.9) Pan Gasket: [1] Included</p>
<p>18032 Transmission Filter</p>  <p>Notes: Both pan gaskets contain [14] bolt holes. Fits: AMC, Chrysler, Mitsubishi Automotive, Light-Duty Trucks, Vans, International Light-Duty Trucks, Jeep with Torque-Flite "6" (904), "6" (999), "8" (727) Transmissions (RWD) Replaces: Chrysler 3515966, 3515996; International 732931-C2; Jeep J8123042 Length: 7 3/32 (180.2) Width: 6 5/8 (168.3) Pan Gasket: [2] Included</p>	<p>18057 Transmission Filter</p>  <p>Notes: Pan gasket contains [12] bolt holes. Contains: [1] Plastic Neck Seal Fits: GMC, Saturn Automotive with 4T40E Transmission Replaces: GMC 8685185, 24203770 Length: 13 3/8 (339.7) Width: 8 1/16 (204.8) Height: 1 25/32 (45.2) Pan Gasket: [1] Included</p>

Measurements Are Shown In Inches And (Millimeters)

WARNING: These products can expose you to chemicals, including Diisononyl Phthalate, Carbon black extracts, Nickel, 1,3 Butadiene, Ethylene Oxide, Epichlorohydrin, which are known to the State of California to cause cancer, and Bisphenol, Ethylene Glycol, Ethylene Oxide, 1,3 Butadiene, Epichlorohydrin, which are known to the State of California to cause birth defects or other reproductive harm. For more information go to www.P65Warnings.ca.gov.

18104

Transmission Filter



Notes: Can only be used with 2 1/4 In. deep pan.
Pan gasket contains [14] bolt holes.
Fits: Chrysler Automotive, Vans with Torque-Flite 30TH A404 Transmissions (FWD, 3 Spd., Deep Pan)
Replaces: Chrysler 4269649
Length: 7 3/16 (182.6)
Width: 6 1/16 (154.0)
Height: 11/16 (17.5)
F. Gskt: [1] Included
Pan Gasket: [1] Included

18198

Transmission Filter



Notes: Pan gasket contains [14] bolt holes.
Fits: Ford Light-Duty Trucks, Vans with AOD, AOT Transmissions (4WD, RWD, 4 Spd.)
Replaces: Ford E5TZ-7A098-C
Length: 8 31/32 (227.8)
Width: 6 15/16 (176.2)
Height: 2 5/32 (54.8)
F. Gskt: [1] Included
Pan Gasket: [1] Included

18139

Transmission Filter



Notes: Pan gasket contains [19] bolt holes.
Contains: Plastic Neck Seal
Fits: 1984-94 Buick, Oldsmobile, 1985-92 Cadillac, 1984-93 Chevrolet, 1985-91 Pontiac Automotive; 1983 GMC Light-Duty Trucks with 4T60-E (THM440) Transmission (FWD), 4 Spd.
Replaces: General Motors Corp. 8682471; Wix 51942, 551942, 58942
Length: 10 19/32 (269.1)
Width: 6 13/16 (173.0)
Height: 2 1/8 (54)
Pan Gasket: [1] Included

18236

Transmission Filter



Notes: Pan gasket contains [21] bolt holes.
Fits: Allison AT540 Series Transmissions (RWD)
Replaces: GMC 6884270
Length: 11 3/4 (298.5)
Width: 6 1/2 (165.1)
O-Ring: [1] Included
O. Gskt: G1973
Pan Gasket: G1972
Related To: 19992 (Different Media)

18155

Transmission Filter



Notes: Pan gasket contains [16] bolt holes.
Fits: 1987-91 Avanti II; 1986-93 Buick, 1991-93 Cadillac, 1982-95 Chevrolet, 1988-93 Oldsmobile, 1983-93 Pontiac Automotive, 1982-93 GMC Light-Duty Trucks with 4L60 (THM700-R4) Transmission (RWD, 4 Spd. with Overdrive)
Replaces: GMC 25011237
Length: 8 1/16 (204.8)
Width: 7 7/8 (200.0)
Height: 4 1/4 (108.0)
Pan Gasket: [1] Included

18245

Transmission Filter

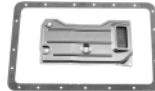

Notes: Pan gasket contains [19] bolt holes.
Fits: Jeep with AW4 Transmission (RWD)
Replaces: Chrysler 83504032
Length: 9 11/16 (246.1)
Width: 5 1/8 (130.2)
Height: 25/32 (19.8)
Pan Gasket: [1] Included

18163

Transmission Filter



Notes: Pan gasket contains [15] bolt holes.
Fits: 1985-88 Chevrolet Nova, 1999-2002 Chevrolet Prizm, 1989-97 Geo Prizm, 1983-2002 Toyota Automotive with A130L, A131L, A132L Transmissions (FWD, 3 Spd.)
Replaces: Toyota 35330-20010; Wix 51960, 58960
Length: 8 1/8 (206.4)
Width: 4 1/2 (114.3)
Height: 3/4 (19)
Pan Gasket: [1] Included

18264

Transmission Filter



Notes: Pan gasket contains [20] bolt holes.
Fits: Ford Automotive, Light-Duty Trucks, Vans with E40D, 4R100 Transmissions (2WD, RWD, Shallow Pan)
Replaces: Ford YC3Z-7A098-AA
Length: 11 1/2 (292.1)
Width: 6 29/32 (175.4)
Height: 4 3/16 (106.4)
Pan Gasket: [1] Included

18171

Transmission Filter



Notes: Pan gasket contains [17] bolt holes.
Contains: [1] Metal Mounting Bracket
Fits: Ford Automotive, Vans with AXOD, AX4N Transmissions (FWD, 4 Spd.)
Replaces: Ford E6DZ-7A098-A
Length: 7 11/32 (186.5)
Width: 7 1/16 (179.4)
Height: 2 11/16 (68.3)
Pan Gasket: [1] Included

18267

Transmission Filter



Notes: Pan gasket contains [20] bolt holes.
Fits: Ford, Mazda Automotive with 4F27E, J39A Transmissions (FWD, 4 Spd. with Overdrive)
Replaces: Ford XS4Z-7A098-AB; Mazda FN01-21-500
Length: 7 (177.8)
Width: 4 29/32 (124.6)
Height: 2 1/16 (52.4)
Pan Gasket: [1] Included

Measurements Are Shown In Inches And (Millimeters)

WARNING: These products can expose you to chemicals, including Diisononyl Phthalate, Carbon black extracts, Nickel, 1,3 Butadiene, Ethylene Oxide, Epichlorohydrin, which are known to the State of California to cause cancer, and Bisphenol, Ethylene Glycol, Ethylene Oxide, 1,3 Butadiene, Epichlorohydrin, which are known to the State of California to cause birth defects or other reproductive harm. For more information go to www.P65Warnings.ca.gov.

18268 Transmission Filter

Notes: Pan gasket contains [19] bolt holes.
Fits: 1991-2003 Ford Escort, 1991-99 Mercury Tracer with 4EAT-F Transmission (FWD, 4 Spd.); 1994-2001 Kia Sephia, 1991-98 Mazda 323, MX3, Protege with F4A-EL Transmission (FWD, 4 Spd.)
Replaces: Ford F1CZ-7A098-A; Mazda FU61-21-500B; Wix 58995, 51995
Length: 5 9/32 (134.1)
Width: 5 1/32 (127.8)
Height: 1 15/16 (49.2)
O-Ring: [1] Included
Pan Gasket: [1] Included

19996 Transmission Filter

Notes: Pan gasket contains [19] bolt holes.
Fits: Lexus, Toyota Automotive, Light-Duty Trucks all with A343F Transmission
Replaces: Toyota 35330-60030
Length: 12 (304.8)
Width: 5 5/16 (134.9)
Height: 2 3/32 (53.2)
Pan Gasket: [1] Included

19640 Transmission Filter

Notes: Pan gasket contains [14] bolt holes.
Fits: Ford Automotive, Light-Duty Trucks, Vans with AOD, AOT Transmissions (2WD, RWD, 4 Spd.)
Replaces: Ford E1AZ-7A098-A; WIX 51939, 58939
Length: 8 15/16 (227.0)
Width: 6 7/8 (174.6)
Height: 13/16 (20.6)
F. Gskt: [1] Included
Pan Gasket: [1] Included

19999 Transmission Filter Kit

Notes: Pan gasket contains [15] bolt holes.
Contains: [1] Transmission Filter [1] Spin-on
 Spin-on has Anti-Drainback Valve
Fits: 2007 Chrysler 300C SRT8, 2007-09 Aspen, 2000-11 Dodge Dakota, 2000-09 Durango, 2002-10 Jeep Grand Cherokee, Liberty, 2004 TJ, Wrangler, 2007 Mitsubishi Ranger with 45RFE, 55RFE Transmissions (2WD, RWD, Multi-Spd. with Overdrive)
Replaces: Chrysler 4799662, 4800029AA
Spin-on
Thread: M20 x 1.5
O.D.: 2 11/16 (68.3)
Height: 4 (101.6)
I.Gskt: [1] Included
Pan Gasket: [1] Included
Pan-Type
O.D. Length: 11 11/16 (296.9)
I.D. Width: 6 3/32 (154.8)
Height: 4 7/32 (107.2)
O-Ring [1] Grommet, [1] Pan Gasket

19739 Transmission Filter

Notes: Pan gasket contains [21] bolt holes.
Contains: [1] 7 Inch Outlet Tube
Fits: Allison MT640, MT650 Series Transmissions (RWD, Deep Pan)
Replaces: Allison 29502302; GMC 6834831
Length: 12 5/8 (320.7)
Width: 8 19/32 (218.3)
Height: 1 1/4 (31.8)
O-Ring: [2] Included
O. Gskt: G1973 (Fiber Gasket)
Grommets: [1] Attached
Pan Gasket: G1972
Related To: 19992 (Shallow Pan)

20000 Transmission Filter Kit

Notes: Pan gasket contains [15] bolt holes.
Contains: [1] Transmission Filter [1] Spin-on
 Spin-on has Anti-Drainback Valve
Fits: 2007 Chrysler 300C SRT8, 2007-09 Aspen, 2000-11 Dodge Dakota, 2000-09 Durango, 2001-10 Jeep Grand Cherokee, 2002-07 Liberty, 2004 TJ, Wrangler, 2006-07 Mitsubishi Raider with 45RFE, 55RFE Transmission
Replaces: Chrysler 4799507, 4799662
Spin-on
Thread: M20 x 1.5
O.D.: 2 11/16 (68.3)
Height: 4 5/8 (117.5)
I.Gskt: [1] Included
Pan Gasket: [1] Included
Pan-Type
O.D. Width: 5 19/32 (142.1)
I.D. Length: 11 11/16 (296.9)
Height: 4 5/8 (117.5)
O-Ring [1] Grommet, [1] Pan Gasket

19828 Transmission Filter

Notes: Pan gasket contains [17] bolt holes.
Contains: [1] Filter-to-Valve Metal Body Gasket
Fits: Ford Automotive, Light-Duty Trucks, Vans with C-6 Transmission (Late, 2WD, RWD, Shallow Pan, Aluminum Case)
Replaces: Ford D5AZ-7A098-BA
Length: 9 3/16 (233.4)
Width: 6 13/16 (173.0)
F. Gskt: [1] Included
Pan Gasket: [1] Included

19992 Transmission Filter

Notes: Pan gasket contains [21] bolt holes.
Fits: Allison AT540 Series Transmissions (RWD, Mesh Screen, Shallow Pan)
Replaces: Allison 29503617; GMC 6837428
Length: 11 3/4 (298.5)
Width: 6 1/2 (165.1)
O-Ring: [1] Included
Pan Gasket: G1972
Related To: 18236 (Different Media) 19739 (Deep Pan)

20002 Transmission Filter

Fits: Ford, Lincoln, Mercury Light-Duty Trucks all with 5R55W Transmission
Replaces: Motorcraft FT140
Length: 13 13/32 (340.5)
Width: 6 21/32 (169.1)
Height: 3 7/16 (87.3)

Measurements Are Shown In Inches And (Millimeters)

WARNING: These products can expose you to chemicals, including Diisononyl Phthalate, Carbon black extracts, Nickel, 1,3 Butadiene, Ethylene Oxide, Epichlorohydrin, which are known to the State of California to cause cancer, and Bisphenol, Ethylene Glycol, Ethylene Oxide, 1,3 Butadiene, Epichlorohydrin, which are known to the State of California to cause birth defects or other reproductive harm. For more information go to www.P65Warnings.ca.gov.

<p>20003</p> 	<p>Transmission Filter Fits: 2002-06 Chevrolet Avalanche, 2001-11 Silverado, GMC Sierra Series Light-Duty Trucks, 2001-06 Chevrolet Suburban, GMC Yukon, 2001, 2003 Chevrolet Tahoe, 2006 Hummer H1 with LCT 1000, 2000, 2400 Series Replaces: Allison 29537966 Length: 9 7/16 (239.7) Width: 6 13/32 (162.7) Height: 5 1/8 (130.2) Related To: 20017 (with Pan Gasket)</p>	<p>20010</p>  <p>Transmission Filter Notes: Pan gasket contains [13] bolt holes. Fits: Hyundai Elantra, Accent Replaces: Hyundai 46321-22731 Length: 7 1/16 (179.4) Width: 6 15/16 (176.2) Height: 2 1/32 (16.7) Pan Gasket: [1] Included</p>
<p>20004</p> 	<p>Transmission Filter Fits: 2002-06 Chevrolet Avalanche, 2001-11 Silverado, GMC Sierra Series Light-Duty Trucks, 2001-06 Chevrolet Suburban, GMC Yukon, 2001, 2003 Chevrolet Tahoe, 2006 Hummer H1 with LCT 1000, 2000, 2400 Series Replaces: Allison 29537965 Length: 9 7/16 (239.7) Width: 6 13/32 (162.7) Height: 4 21/32 (118.3) Related To: 20016 (with Pan Gasket)</p>	<p>20011</p>  <p>Transmission Filter Notes: Pan gasket contains [13] bolt holes. Fits: 2005 Chrysler 300C, 2005-10 300; 2004-11 Dodge Dakota, 2003-10 Jeep Liberty, 2004-06 T.J., 2004-09 Wrangler; 2011-on Dodge Pickups, 2006-10 Charger, 2006-09 Durango; 2006-on Mitsubishi Raider Replaces: Chrysler 52852913AB Length: 7 1/4 (184.2) Width: 6 7/8 (174.6) Height: 1 7/16 (36.5) O-Ring: [1] Included Pan Gasket: [1] Included</p>
<p>20005</p> 	<p>Transmission Filter Contains: [1] Plastic Neck Seal Fits: Ford E Series Vans, F Series Super Duty Pickups Replaces: Ford 3C3P-7G186-AF, 3C3Z-7A098-AA; Motorcraft FT144 Length: 11 7/16 (290.5) Width: 4 1/16 (103.2) Height: 6 3/32 (154.8)</p>	<p>20012</p>  <p>Transmission Filter Notes: Pan gasket contains [20] bolt holes. Fits: 1998-2001 Mitsubishi Montero, 1999-2002 Montero Sport with V5A517 Transmission (FWD, 5 Spd.) Replaces: Mitsubishi MR357710 Length: 10 7/8 (276.2) Width: 5 15/16 (150.8) Height: 1 3/4 (44.4) Pan Gasket: [1] Included</p>
<p>20006</p> 	<p>Transmission Filter Contains: [2] Rubber Neck Seals Fits: 2003-08 Ford Explorer, 2007 Explorer Sport Trac, 2004-05 Thunderbird, 2005-on Mustang, 2003-06 Lincoln LS, 2002-05 Mercury Mountaineer Replaces: Ford 3W4Z-7A098-AB; Motorcraft FT142; Wix 58844 Length: 13 13/32 (340.5) Width: 6 21/32 (169.1) Height: 1 9/32 (32.5)</p>	<p>20013</p>  <p>Transmission Filter Notes: Pan gasket contains [20] bolt holes. Fits: 2000-04, 2006 Mitsubishi Montero, 2003-04 Montero Sport with AW30-40LE Transmission (RWD, 4 Spd.) Replaces: Mitsubishi MR528836 Length: 11 19/32 (294.5) Width: 5 15/16 (150.8) Height: 1 3/4 (44.4) Pan Gasket: [1] Included</p>
<p>20007</p> 	<p>Transmission Filter Contains: [2] Rubber Neck Seals Fits: 2002, 2004 Ford Thunderbird; 2003-04, 2006-08 Jaguar X-Type; 2000-02 Lincoln LS Replaces: Ford XW4Z-7A098-BB; Motorcraft FT117 Length: 13 1/4 (336.5) Width: 6 1/8 (155.6) Height: 2 (50.8)</p>	<p>20014</p>  <p>Transmission Filter Notes: Pan gasket contains [20] bolt holes. CAUTION: Can only be used with 2 1/4 In. pan. Fits: 1991-2011 Buick, Chevrolet, 1991-95 Cadillac, 1991-2004 Oldsmobile, 1992-09 Pontiac, 2005-09 Saturn Automotive with 4T60-E Electronic Transmissions (FWD, 4 Spd.) Replaces: Wix 58837 Length: 10 19/32 (269.1) Width: 6 13/16 (173.0) Height: 2 5/32 (54.8) Pan Gasket: [1] Included Related To: 18022 (without Pan Gasket)</p>
<p>20008</p> 	<p>Transmission Filter Notes: Pan gasket contains [18] bolt holes. Fits: Lexus, Toyota Automotive Replaces: Toyota 35330-08010 Length: 7 3/32 (180.2) Width: 6 19/32 (167.5) Height: 1 3/16 (30.2) O-Ring: [1] Included Pan Gasket: [1] Included</p>	<p>20015</p>  <p>Transmission Filter Notes: Pan gasket contains [18] bolt holes. Fits: Lexus, Scion, Toyota Automotive, Light-Duty Trucks Replaces: Toyota 35330-06010; 35330-0W010 Length: 7 19/32 (192.9) Width: 7 1/32 (178.6) Height: 1 5/8 (41.3) O-Ring: [1] Included Pan Gasket: [1] Included</p>

Measurements Are Shown In Inches And (Millimeters)

⚠ WARNING: These products can expose you to chemicals, including Diisononyl Phthalate, Carbon black extracts, Nickel, 1,3 Butadiene, Ethylene Oxide, Epichlorohydrin, which are known to the State of California to cause cancer, and Bisphenol, Ethylene Glycol, Ethylene Oxide, 1,3 Butadiene, Epichlorohydrin, which are known to the State of California to cause birth defects or other reproductive harm. For more information go to www.P65Warnings.ca.gov.

20016 Transmission Filter

Notes: Pan gasket contains [12] bolt holes.
Contains: Rubber Neck Seal
Fits: 2002-06 Chevrolet Avalanche, 2001-on Silverado, GMC Sierra Light-Duty Trucks; 2001-06 Chevrolet Suburban, GMC Yukon; 2006 Hummer H1 with 2400 Series Transmissions (Shallow Pan)
Replaces: Allison 29537965; General Motors 29537965
Length: 9 7/16 (239.7)
Width: 6 13/32 (162.7)
Height: 4 21/32 (118.3)
Pan Gasket: [1] Included
Related To: 20004 (without Pan Gasket)

20017 Transmission Filter

Notes: Pan gasket contains [12] bolt holes.
Contains: Rubber Neck Seal
Fits: 2002-06 Chevrolet Avalanche, 2001-on Silverado, GMC Sierra Light-Duty Trucks; 2001-06 Chevrolet Suburban, GMC Yukon; 2006 Hummer H1 with 2400 Series Transmissions (Deep Pan)
Replaces: Allison 29537966; General Motors 29537966
Length: 9 7/16 (239.7)
Width: 6 13/32 (162.7)
Height: 4 29/32 (124.6)
Pan Gasket: [1] Included
Related To: 20003 (without Pan Gasket)

20018 Transmission Filter

Notes: Pan gasket contains [21] bolt holes.
Contains: Rubber Neck Seal
Fits: 2006-07 Ford Explorer, 2009-on Explorer Sport Trac; 2006-on Mercury Mountaineer
Replaces: Ford 6L2Z-7A098-AA; Motorcraft FT160
Length: 9 1/8 (231.8)
Width: 7 11/16 (195.3)
Height: 3 5/8 (92.1)
Pan Gasket: [1] Included

20019 Transmission Filter

Notes: Pan gasket contains [21] bolt holes.
Contains: Rubber Neck Seal
Fits: 2008-on Ford Expedition, Expedition EL, 2008 Explorer, Mercury Mountaineer
Replaces: Ford 7L1Z-7A098-A; Motorcraft FT171; Wix 58099
Length: 9 7/8 (250.8)
Width: 9 1/16 (230.2)
Height: 3 3/4 (95.3)
Pan Gasket: [1] Included

20020 Transmission Filter

Notes: Pan gasket contains [16] bolt holes.
Contains: Plastic Neck Seal
Fits: 2004-12 Chevrolet Colorado, GMC Canyon; 2009 GMC Envoy, Envoy Denali; 2006-10 Hummer H3, H3 SUT; 2006-08 Isuzu
Replaces: General Motors 24225323; Isuzu 8-24225-323-6
Length: 9 7/16 (239.7)
Width: 6 3/8 (161.9)
Height: 4 23/32 (119.9)
Pan Gasket: [1] Included

20021 Transmission Filter

Notes: Pan gasket contains [1] Rubber Neck Seal
Contains: [1] Rubber Neck Seal
Fits: Blue Bird Micro Bird Buses, Collins Buses, Ford F53 Motorhome Chassis, Light-Duty Trucks and Vans, IHC City Star CF500, CF600 Trucks all with 5R110W-HI/Torque Transmission
Replaces: Ford 8C3Z-7A098-D; Motorcraft FT180
Length: 11 17/32 (292.9)
Width: 4 11/32 (110.3)
Height: 6 1/4 (158.8)
A. Gskt: [1] Attached

20022 Transmission Filter

Notes: Pan gasket contains [18] bolt holes.
Contains: [1] Metal Neck Seal
Fits: Cadillac; Chevrolet Light-Duty Trucks; GMC Sierra Series Light-Duty Trucks
Length: 8 3/4 (222.3)
Width: 6 1/2 (165.1)
Height: 6 5/16 (160.3)
Pan Gasket: [1] Included

20023 Transmission Filter

Notes: Pan gasket contains [20] bolt holes.
Contains: [1] Metal Neck Seal
Fits: Lexus, Toyota Light-Duty Trucks
Replaces: Toyota 35330-60050
Length: 10 3/16 (258.8)
Width: 6 3/16 (157.2)
Height: 2 3/32 (53.2)
Pan Gasket: [1] Included

20024 Transmission Filter

Notes: Pan gasket contains [12] bolt holes.
Contains: [1] Metal Neck Seal
Fits: 2006-07 Ford Explorer, 2009-on Explorer Sport Trac; 2006-on Mercury Mountaineer
Replaces: Chrysler 5078555AA
Length: 7 3/32 (180.2)
Width: 6 3/16 (157.2)
Height: 3 31/32 (100.8)
Pan Gasket: [1] Included

20025 Transmission Filter

Notes: Pan gasket contains [12] bolt holes.
Contains: [1] Metal Neck Seal
Fits: 2008-10 Dodge Light-Duty Trucks; 2011-14 Ram Light-Duty Trucks, 4500HD, 5500HD Chassis Cab; 2008 Sterling Bullet all with 6-408 (6.7L) FI Turbo Diesel Engine with 6 Speed 68 RFE Transmission
Replaces: Chrysler 68019688AA
Length: 9 9/16 (242.9)
Width: 7 3/4 (196.9)
Height: 2 23/32 (69.1)
Grommets: [1] Attached

20026 Transmission Filter

Notes: Pan gasket contains [20] bolt holes.
Contains: [1] Metal Neck Seal
Fits: 2007-12 Dodge Caliber, 2007-17 Jeep Compass, Patriot
Replaces: Chrysler 5191890AA
Length: 5 3/32 (129)
Width: 4 11/32 (110)
Height: 1 15/16 (49)
O-Ring: [1] Attached
Pan Gasket: [1] Included

Measurements Are Shown In Inches And (Millimeters)

WARNING: These products can expose you to chemicals, including Diisononyl Phthalate, Carbon black extracts, Nickel, 1,3 Butadiene, Ethylene Oxide, Epichlorohydrin, which are known to the State of California to cause cancer, and Bisphenol, Ethylene Glycol, Ethylene Oxide, 1,3 Butadiene, Epichlorohydrin, which are known to the State of California to cause birth defects or other reproductive harm. For more information go to www.P65Warnings.ca.gov.

20027

Transmission Filter



Notes: Pan gasket contains [12] holes.
Contains: [1] Metal Neck Seal
Fits: 2011-17 Chrysler 200, 2013-17 300, 2007-08 & 2017 Pacifica, 2007-18 Sebring, 2008-16 Town & Country. 2011-2014 Dodge, 2013 Durango, 2008-19 Grand Caravan, 2009-18 Journey, 2012-15 RAM C/V Cargo Van, 2014-18, ProMaster 1500, ProMaster 2500, ProMaster 3500
Replaces: Chrysler 68018555AA
Length: 7 3/32 (180)
Width: 6 3/16 (157)
Height: 3 1/4 (82)
Pan Gasket: [1] Included

20028

Transmission Filter



Notes: Pan gasket contains [19] bolt holes.
Fits: 2016-19 Ford E-350 Super Duty Vans, 2017-19 E-450 Super Duty Vans., 2011-19 F-250 Super Duty Pickups, 2011-19 F-350 Super Duty Pickups, 2011-19 F-450 Super Duty Trucks, 2011-19 F-550 Super Duty Trucks, 2012-19 F650 Trucks, 2016-19 F750 Trucks, 2017-19 F53
Replaces: Ford Motor Corp. BC3Z7A098B, BC3P7G186BE; Motorcraft FT187
Length: 11 1/16 (281)
Width: 9 15/32 (240)
Height: 2 1/4 (57)
O-Ring: [1] Attached
Pan Gasket: [1] Included

20029

Transmission Filter



Notes: Pan gasket contains [21] bolt holes
Contains: [1] Rubber Neck Seal
Fits: 2012-18 Ford Expedition, 2011-19 F-150 Pickup, 2017-19 F-250 Super Duty Pickup, 2013 Ford Lobo, 2011-19 Mustang; 2015-18 Lincoln Navigator; 2015-17 Mobility Ventures MV-1; 2019 Ford F-450 Super Duty Pickup; 2019 Ford F-550 Super Duty Pickup
Replaces: Ford Motor Co. BL3Z7A098A; Motorcraft FT188
Length: 9 27/32 (249.9)
Width: 9 3/32 (230.9)
Height: 4 29/32 (125)
Pan Gasket: [1] Included

20030

Transmission Filter



Notes: Pan gasket contains [12] bolt holes.
Contains: [1] Rubber Neck Seal
Fits: 2013 Chevrolet Silverado 2500 HD, Silverado 3500 HD; 2013 GMC Sierra 2500 HD, Sierra 3500 HD
Replaces: General Motors Corp. 29542824
Length: 10 5/32 (258.1)
Width: 7 3/32 (180.1)
Height: 4 31/32 (126)
Pan Gasket: [1] Included

20031

Magnetic In-Line Universal Transmission Filter



Contains: [2] Hoses
 [4] Clamps
Replaces: WIX 51964, 58964
O.D.: 2 5/32 (54.8)
Inlet: 5/16
Outlet: 5/16
Length: 4 15/32 (113.5)

20033

Transmission Filter



Notes: Pan gasket contains [18] bolt holes.
Contains: Plastic Neck Seal
Fits: 2007 BMW X3, X5, 2008 X6, all with L6 (3.0L) Engine
Replaces: BMW (Bavarian Motor Works) 24236595
Length: 8 3/4 (222.3)
Width: 7 1/2 (190.5)
Height: 5 1/8 (130.2)
Pan Gasket: [1] Included

20035

Transmission Filter



Notes: Pan gasket contains [17] bolt holes.
Fits: 1990-93 Lexus, 1988-93, 1996-2000 Toyota Automotive with A540E, A540H Transmissions (FWD)
Replaces: Toyota 35330-32030; Wix 51888, 58888
Length: 8 (203.2)
Width: 5 1/32 (127.8)
Height: 11/16 (17.5)
Pan Gasket: [1] Included

20037

Transmission Filter



Notes: Pan gasket contains [21] bolt holes.
Fits: 1991-96, 1999-2002 Infiniti G20, 1991-on Nissan Automotive with RL4F03A Transmission (4 Spd.)
Replaces: Nissan 31728-31X01; Wix 51996, 58996
Length: 6 1/4 (158.8)
Width: 5 3/4 (146.0)
Height: 3/8 (9.5)
Pan Gasket: [1] Included

20041

Transmission Filter



Notes: OBSOLETE. Availability Limited to Dealer Stock.
 Both pan gaskets contain [16] bolt holes.
Fits: 1991-2000 BMW Automotive with 4L30-E Transmission (4 Spd.)
Replaces: BMW (Bavarian Motor Works) 24111218899; Wix 51983, 58983
Length: 9 5/8 (244.5)
Width: 6 1/16 (154.0)
Height: 1 3/4 (44.4)
Pan Gasket: [2] Included

20042

Transmission Filter



Notes: Pan gasket contains [18] bolt holes.
Fits: 1998-2002 Chevrolet Prizm, 1993-97 Geo Prizm, 1985-2002 Toyota Automotive with A245E Transmission (4 Spd.)
Replaces: General Motors Corp. 94853372; Toyota 35330-12030; Wix 58605
Length: 7 5/8 (193.7)
Width: 5 (127.0)
Height: 29/32 (23)
Pan Gasket: [1] Included

Measurements Are Shown In Inches And (Millimeters)

WARNING: These products can expose you to chemicals, including Diisononyl Phthalate, Carbon black extracts, Nickel, 1,3 Butadiene, Ethylene Oxide, Epichlorohydrin, which are known to the State of California to cause cancer, and Bisphenol, Ethylene Glycol, Ethylene Oxide, 1,3 Butadiene, Epichlorohydrin, which are known to the State of California to cause birth defects or other reproductive harm. For more information go to www.P65Warnings.ca.gov.

20043 Transmission Filter
Notes: Pan gasket contains [17] bolt holes.
Fits: 1994-2001 Lexus, 1994-2004 Toyota Avalon, 2001-04 Camry, 1999-2001 Solara with A541E Transmission
Replaces: Toyota 35330-33010; Wix 58614
Length: 8 (203.2)
Width: 5 1/32 (127.8)
Height: 23/32 (18.3)
Pan Gasket: [1] Included

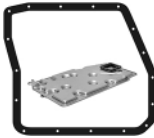

20044 Transmission Filter
Notes: Pan gasket contains [20] bolt holes.
Fits: 1996-97 Lexus, 1995-2000 Toyota Light-Duty Trucks with A343F (4WD, 4 Spd.) Transmission
Replaces: Toyota 35330-60020; Wix 58610
Length: 12 3/8 (314.3)
Width: 5 5/16 (134.9)
Height: 1 27/32 (46.8)
Pan Gasket: [1] Included



20045 Transmission Filter
Notes: Pan gasket contains [4] bolt holes.
Fits: 1995-98 Audi Cabriolet, 1995-2008 Volkswagen Automotive with AG4 (097) Transmission (FWD, 4 Spd.)
Replaces: Volkswagen 1M325429; Wix 58609
Length: 7 11/16 (195.3)
Width: 6 3/16 (157.2)
Height: 1 5/16 (33.3)
Pan Gasket: [1] Included



20046 Transmission Filter
Notes: Pan gasket contains [14] bolt holes.
Fits: 1991-2005 Acura Automotive with MPYA Transmission (FWD, 4 Spd.)
Replaces: Honda 25420-PY4-000; Wix 58615
Length: 6 13/16 (173.0)
Width: 3 27/32 (97.6)
Height: 3 1/8 (79.4)
O-Ring: [1] Included
Pan Gasket: [1] Included



20048 Transmission Filter
Fits: 2004-on Chrysler, 2002-on Dodge, 2005-on Jeep, 1996-on Mercedes-Benz Automotive with 722.6 Transmission (RWD, 5 Spd. with Electronic Overdrive)
Replaces: Mercedes-Benz 1402770095; Wix 58845
Length: 7 3/8 (187.3)
Width: 4 29/32 (124.6)
Height: 2 (50.8)
O-Ring: [1] Attached
Pan Gasket: [1] Included



20050 Transmission Filter
Notes: Pan gasket contains [19] bolt holes.
Fits: 1998-2000 Lexus GS300, 1998-2000 GS400
Replaces: Toyota 35330-30050
Length: 7 5/8 (193.7)
Width: 6 9/16 (166.7)
Height: 29/32 (23)
Pan Gasket: [1] Included



20051 Transmission Filter
Notes: Pan gasket contains [19] bolt holes.
Fits: 2009-10 Pontiac Vibe; 2004-07 Scion xA, xB, 2008-on xD; 2000-on Toyota Automotive with U340E Transmission (FWD, 4 Spd.)
Replaces: Toyota 35330-20020, 35330-0W020; Wix 58324
Length: 7 7/32 (183.4)
Width: 6 5/8 (168.3)
Height: 1 3/8 (34.9)
O-Ring: [1] Included
Pan Gasket: [1] Included



20052 Transmission Filter
Notes: Pan gasket contains [22] bolt holes.
Contains: Rubber Neck Seal
Fits: 2002 BMW Z3 with 5L40-E Transmission (Shallow Pan)
Replaces: BMW (Bavarian Motor Works) 24722000
Length: 11 3/8 (288.9)
Width: 7 5/32 (181.8)
Height: 4 7/8 (123.8)
Pan Gasket: [1] Included



20053 Transmission Filter
Notes: Pan gasket contains [11] bolt holes.
Fits: 1965-69 Ford Automotive (Except Fairlane), 1965-69 Mercury with C4 Transmission (RWD, Aluminum Case)
Replaces: Ford C5AZ-7A098-C; Motorcraft FT36, FT36-A; Wix 51923, 58923
Length: 7 21/32 (194.5)
Width: 4 1/8 (104.8)
Height: 7/16 (11.1)
Pan Gasket: [1] Included



20054 Transmission Filter
Notes: Pan gasket contains [18] bolt holes.
Fits: 2003-07 Pontiac Vibe; 2003-06 Toyota Matrix XR, 2007-08 Matrix, 2003-08 Corolla
Replaces: Toyota 35330-12040; Wix 58040
Length: 7 1/8 (181.0)
Width: 5 (127.0)
Height: 1 (25.4)
Pan Gasket: [1] Included



20055 Transmission Filter
Notes: Pan gasket contains [12] bolt holes.
Fits: 1978-87 Chevrolet Chevette, 1972-74 LUV, 1998 Tracker, 1989-97 Geo Tracker, 1975-83 Fiat, 1987 GMC Light-Duty Trucks, 1983-93 Lada, 1969-75 Opel, 1980-87 Pontiac, 1989-98 Suzuki Sidekick with 3L30 Transmissions (RWD, 3 Spd.)
Replaces: General Motors Corp. 25010641; Wix 51889, 58889
Length: 6 7/8 (174.6)
Width: 4 5/8 (117.5)
F. Gskt: [1] Included
Pan Gasket: [1] Included

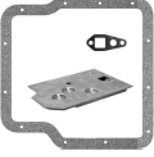

Measurements Are Shown In Inches And (Millimeters)

WARNING: These products can expose you to chemicals, including Diisononyl Phthalate, Carbon black extracts, Nickel, 1,3 Butadiene, Ethylene Oxide, Epichlorohydrin, which are known to the State of California to cause cancer, and Bisphenol, Ethylene Glycol, Ethylene Oxide, 1,3 Butadiene, Epichlorohydrin, which are known to the State of California to cause birth defects or other reproductive harm. For more information go to www.P65Warnings.ca.gov.

20057

Transmission Filter



Notes: Pan gasket contains [13] bolt holes.
Fits: 1981-94 Ford, Mercury, 2000 Volkswagen Automotive with ATX Transmission (FWD, 3 Spd.)
Replaces: Ford E9FZ-7A098-A; Wix 51921, 58921
Length: 6 13/16 (173.0)
Width: 6 1/8 (155.6)
F. Gskt: [1] Included
Pan Gasket: [1] Included

20058

Transmission Filter



Notes: Both pan gaskets contain [16] bolt holes.
Fits: 1981-90 Buick, Cadillac, 1981-88, 1990 Chevrolet, Oldsmobile, 1981-89 Pontiac Automotive, 1982-85, 1987 GMC Light-Duty Trucks with THM200-4R Transmission (RWD, 4 Spd. with Overdrive)
Replaces: General Motors Corp. 8634223; Wix 551896, 51896, 58896
Length: 9 7/32 (234.2)
Width: 6 (152.4)
Height: 4 9/16 (115.9)
Pan Gasket: [2] Included

20060

Transmission Filter

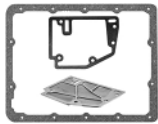

Notes: Pan gasket contains [14] bolt holes.
Fits: 1987-89 Dodge, 1987-89 Mitsubishi Light-Duty Trucks, 1980-97, 2001 Toyota Automotive, Light-Duty Trucks, Vans, 1983-85 Isuzu, 1980-97 Volvo Automotive
Replaces: Toyota 35303-30050; Volvo 1239829-3; Wix 51945, 58945
Length: 5 3/16 (131.8)
Width: 3 27/326 (78.3)
Height: 11/32 (8.7)
F. Gskt: [1] Included
Pan Gasket: [1] Included

20061

Transmission Filter



Notes: Pan gasket contains [19] bolt holes.
Fits: 1992-2000 Lexus, 1986-2002 Toyota Automotive with A340E Transmission (RWD)
Replaces: Toyota 35330-30011; Wix 51805, 58805
Length: 8 11/32 (211.9)
Width: 5 1/8 (130.2)
Pan Gasket: [1] Included

20062

Transmission Filter

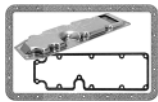

Notes: Pan gasket contains [19] bolt holes.
Fits: 1989 Isuzu Trooper, Trooper II, 1985-97 Toyota, 1995-2002 Mitsubishi Automotive
Replaces: Toyota 35330-35010; Wix 51884, 58884
Length: 12 7/32 (310.4)
Width: 3 15/16 (100.0)
Height: 5/8 (15.9)
F. Gskt: [1] Included
Pan Gasket: [1] Included

20063

Transmission Element

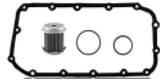

Notes: Pan gasket contains [14] bolt holes.
Fits: 2008-11 Acura TL; 2007-2012 Honda Odyssey
Replaces: Honda 25450P4V013; WIX 58732
O.D.: 1 3/4 (44.4)
I.D.: 11/32 (8.7) One End
Height: 2 3/32 (53.2)
O-Ring: [2] Included

20064

Transmission Filter



Notes: Pan gasket contains [16] bolt holes.
Fits: 1996-99 Acura SLX, 1994-2002 Honda Passport, 1989-2004 Isuzu Automotive with 4L30-E Transmission (4WD, RWD, 4 Spd.)
Replaces: Isuzu 8-96015-062-0; Wix 51876, 58876
Length: 9 1/8 (231.8)
Width: 6 1/16 (154.0)
Height: 1 7/32 (31)
Pan Gasket: [1] Included

20065

Transmission Filter



Notes: Pan gasket contains [19] bolt holes.
Fits: 1990-97 Lexus, 1993-98 Toyota Supra with A341E Transmission (RWD)
Replaces: Toyota 35330-50010; Wix 58603
Length: 8 3/32 (205.6)
Width: 6 1/4 (158.8)
Height: 31/32 (24.6)
Pan Gasket: [1] Included

20066

Transmission Filter



Notes: Pan gasket contains [20] bolt holes.
Fits: 1990-99 Subaru Automotive with 4EAT Transmission (FWD, 4 Spd.)
Replaces: Subaru 31728-AA011; Wix 51969, 58969
Length: 8 27/32 (224.6)
Width: 6 1/2 (165.1)
Height: 1 3/32 (27.8)
O-Ring: [2] Attached
Pan Gasket: [1] Included

20067

Transmission Filter



Notes: Pan gasket contains [17] bolt holes.
Contains: [1] Filter-to-Valve Metal Body Gasket
Fits: 1965-74 Ford, 1962 Jeep, 1959-74 Lincoln, 1965-74 Mercury Automotive, Light-Duty Trucks, Vans with C6 Transmission (Early, RWD, Aluminum Case)
Replaces: Ford C6AZ-7A098-A; Motorcraft FT37A, FT38A; Wix 51920, 58920
Length: 9 3/16 (233.4)
Width: 6 1/4 (158.8)
F. Gskt: [1] Included
Pan Gasket: [1] Included

20068

Transmission Filter

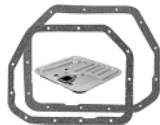



Notes: Both pan gaskets contain [13] bolt holes.
Fits: 1993-2001 Hyundai Automotive with F4A32 Transmission
Replaces: Hyundai 46321-22050; Wix 58601
Length: 6 15/16 (176.2)
Width: 6 11/16 (169.9)
Height: 21/32 (16.7)
A. Gskt: [1] Attached
Pan Gasket: [2] Included

Measurements Are Shown In Inches And (Millimeters)

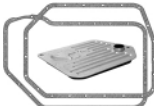
WARNING: These products can expose you to chemicals, including Diisononyl Phthalate, Carbon black extracts, Nickel, 1,3 Butadiene, Ethylene Oxide, Epichlorohydrin, which are known to the State of California to cause cancer, and Bisphenol, Ethylene Glycol, Ethylene Oxide, 1,3 Butadiene, Epichlorohydrin, which are known to the State of California to cause birth defects or other reproductive harm. For more information go to www.P65Warnings.ca.gov.

20069 Transmission Filter

Notes: One Pan gasket contains [22] bolt holes. One Pan gasket contains [27] bolt holes.
Fits: 2002-03 Audi S6 Avant, 1997-2005 Jaguar S-Type, Vanden Plas, XJ8, XK8, 2004-06 Volkswagen with 5HP24 (01L) Transmission (5 Spd.)
Replaces: Audi 1L325429; Jaguar JLM20216
Length: 9 25/32 (248.4)
Width: 7 7/8 (200.0)
Height: 1 11/32 (34.1)
O-Ring: [1] Included
Pan Gasket: [2] Included

20070 Transmission Filter

Notes: Pan gasket contains [20] bolt holes.
Fits: RAM 3500, 4500, 5500 with 6.4L & 6.7L Engines
Replaces: Ram 68224232AA
Length: 17 1/16 (433.1)
Width: 12 13/16 (325.1)
Height: 2 1/16 (52.1)
Pan Gasket: [1] Included

20071 Transmission Filter

Notes: Pan Gasket contains [18] bolt holes.
Fits: 2007-18 Lexus ES350, 2010-15 RX350, RS450h, 2014-18 ES300h, 2016 NX200t, 2016-21 X300h, 2018-21 NX300; 2008-17 Toyota Camry, 2010-18 Avalon, 2011-17 Sienna, 2009-16 Venza
Replaces: Toyota 3533033050, 3533048020
Length: 7 5/32 (181.6)
Width: 4 5/8 (117.6)
Height: 2 9/32 (57.9)
O-Ring: [1] Attached
Pan Gasket: [1] Included

20072 Transmission Filter

Notes: Pan gasket contains [18] bolt holes.
Fits: 2019-22 Ford Expedition, Ranger, 2021 Bronco, 2022 Explorer, 2017-2021 F-150, 2018 Lobo, 2020-21 Mustang, 2020 Police Interceptor Utility; 2019-21 Lincoln Navigator
Replaces: Motorcraft FT202; FT215; Ford Motor HL3Z7A098A, L1MZ7A098A
Length: 8 31/32 (227.6)
Width: 6 5/16 (160.5)
Height: 1 21/32 (41.9)
Grommets: [1] Included
Pan Gasket: [1] Included

BW21000 Coolant Spin-on without Chemicals

Fits: Long Life Used with Extended Service Coolant.
Replaces: Donaldson DBC4086; Fleetguard WF2130
Thread: M16 x 1.5
O.D.: 3 11/16 (93.7)
Height: 5 7/16 (138.1)
I.Gskt: [1] Included

PT23000 Hydraulic Element with Bail Handle

Fits: FBO Hydraulic Systems
Replaces: FBO CR6001; MP Filtri MF4003P25NB; Donaldson P171576
O.D.: 5 1/8 (130.2)
I.D.: 2 1/2 (63.5) One End
Height: 10 3/16 (258.8)
I.Gskt: [1] Included
Spring: [1] Included

PT23001 Hydraulic Element with Bail Handle

Fits: MP Filtri Hydraulic Systems
Replaces: MP Filtri MF4003P10NB
O.D.: 5 1/8 (130.2)
I.D.: 2 9/16 (65.1) One End
Height: 10 3/16 (258.8)
I.Gskt: [1] Included

PT23002 Hydraulic Element

Fits: Mahle Applications
Replaces: Mahle P11015MIC25; Filtrac DMD0015D20B
O.D.: 3 1/4 (82.6)
I.D.: 1 7/8 (47.6) One End
Height: 5 9/16 (141.3)











PT23003 Hydraulic Element with Bail Handle

Fits: FBO Hydraulic Systems
Replaces: FBO CR2501
O.D.: 5 1/8 (130.2)
I.D.: 2 (50.8) One End
Height: 6 (152.4)
I.Gskt: [1] Included
Spring: [1] Included

PT23004 Hydraulic Element with Bail Handle

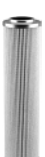
Notes: OBSOLETE. Availability Limited to Dealer Stock.
Fits: Eppensteiner Hydraulic Systems
Replaces: Eppensteiner 6300P10S0000
O.D.: 3 9/16 (90.5)
I.D.: 4 1/4 (108.0) One End
Height: 15 3/8 (390.5)
I.Gskt: [1] Included

PT23005 Hydraulic Element with Bail Handle

Fits: MP Filtri Hydraulic Systems
Replaces: MP Filtri MF1003P25NB
O.D.: 2 11/16 (68.3)
I.D.: 1 9/16 (39.7)
Height: 8 1/2 (215.9)
I.Gskt: [1] Included
Spring: [1] Included

Measurements Are Shown In Inches And (Millimeters)

WARNING: These products can expose you to chemicals, including Diisononyl Phthalate, Carbon black extracts, Nickel, 1,3 Butadiene, Ethylene Oxide, Epichlorohydrin, which are known to the State of California to cause cancer, and Bisphenol, Ethylene Glycol, Ethylene Oxide, 1,3 Butadiene, Epichlorohydrin, which are known to the State of California to cause birth defects or other reproductive harm. For more information go to www.P65Warnings.ca.gov.

<p>PT23006</p>  <p>Hydraulic Element Fits: Argo Hydraulic Systems Replaces: Argo P3052051 O.D.: 1 13/16 (46.0) I.D.: 13/16 (20.6) One End Height: 7 7/8 (200.0) I.Gskt: [1] Included</p>	<p>PT23011</p>  <p>Hydraulic Element Contains: 3-11 Inch BSP Threaded Stud Fits: U.C.C. Hydraulic Systems Replaces: U.C.C. UCSE1221 O.D.: 5 13/16 (147.6) I.D.: 3 1/2 (88.9) Height: 10 11/16 (271.5) I.Gskt: [2] Included</p>
<p>PT23007</p>  <p>Hydraulic Element Fits: Argo Hydraulic Systems Replaces: Argo P3052052 O.D.: 1 13/16 (46.0) I.D.: 13/16 (20.6) One End Height: 7 7/8 (200.0) I.Gskt: [1] Included</p>	<p>PT23012</p>  <p>Hydraulic Element Notes: OBSOLETE. Availability Limited to Dealer Stock. Fits: MP Filtri Hydraulic Systems Replaces: MP Filtri CU250M90N O.D.: 3 29/32 (99.2) I.D.: 2 1/16 (52.4) Height: 8 3/16 (208.0) I.Gskt: [2] Included</p>
<p>PT23008</p>  <p>Hydraulic Element Notes: OBSOLETE. Availability Limited to Dealer Stock. Fits: Eppensteiner Hydraulic Systems Replaces: Eppensteiner 1063P10A000P O.D.: 2 9/32 (57.9) I.D.: 1 9/32 (32.5) Height: 6 5/16 (160.3) I.Gskt: [2] Included</p>	<p>PT23013</p>  <p>Hydraulic Element with Bail Handle Notes: OBSOLETE. Availability Limited to Dealer Stock. Contains: By-Pass Valve Fits: Donaldson FHK Assemblies Replaces: Donaldson P171536 O.D.: 3 29/32 (99.2) I.D.: 1 5/8 (41.3) Height: 8 1/16 (204.8) I.Gskt: [1] Included Spring: [1] Included</p>
<p>PT23009</p>  <p>Hydraulic Element Fits: Mahle Hydraulic Systems Replaces: Mahle PL13030RN O.D.: 2 1/4 (57.2) I.D.: 1 3/16 (30.2) Height: 9 3/4 (247.7) I.Gskt: [2] Included</p>	<p>PT23014</p>  <p>Hydraulic Element Notes: OBSOLETE. Availability Limited to Dealer Stock. Fits: Mahle Applications Replaces: Mahle PI8530DRG100 O.D.: 3 3/16 (81.0) I.D.: 1 7/8 (47.6) One End Height: 10 1/16 (255.6)</p>
<p>PT23010</p>  <p>Hydraulic Element Fits: Liebherr Applications Replaces: Liebherr 10044538 O.D.: 3 1/2 (88.9) I.D.: 1 9/16 (39.7) Height: 12 15/16 (328.6) O-Ring: [2] Attached</p>	<p>PT23015</p>  <p>Hydraulic Element Notes: OBSOLETE. Availability Limited to Dealer Stock. Contains: Stud Thread: 1-11 BSP Fits: OMT Hydraulic Systems Replaces: OMT SP86A100GR125 O.D.: 3 29/32 (99.2) I.D.: 1 5/8 (41.3) Height: 8 1/16 (204.8)</p>

Measurements Are Shown In Inches And (Millimeters)

 **WARNING:** These products can expose you to chemicals, including Diisononyl Phthalate, Carbon black extracts, Nickel, 1,3 Butadiene, Ethylene Oxide, Epichlorohydrin, which are known to the State of California to cause cancer, and Bisphenol, Ethylene Glycol, Ethylene Oxide, 1,3 Butadiene, Epichlorohydrin, which are known to the State of California to cause birth defects or other reproductive harm. For more information go to www.P65Warnings.ca.gov.

PT23016



Hydraulic Element

Contains: Threaded Stud
Fits: OMT Hydraulic Systems
Replaces: OMT SP86A114GR125
Thread: 1 1/4 BSP-PL
O.D.: 3 1/4 (82.6)
Height: 5 1/2 (139.7)

PT23022



Hydraulic Element

Notes: OBSOLETE. Availability Limited to Dealer Stock.
Fits: Mahle Applications
Replaces: Mahle P18430DRG60; Filtrec DMD0030B60B
O.D.: 3 3/16 (81.0)
I.D.: 1 7/8 (47.6) One End
Height: 10 1/16 (255.6)

PT23017



Hydraulic Element with Bail Handle

Fits: Donaldson FHK/FSK Assemblies
Replaces: Donaldson P171529
O.D.: 2 3/4 (69.9)
I.D.: 1 5/32 (29.4) One End
Height: 3 5/32 (80.2)
I.Gskt: [1] Included
Spring: [1] Included

PT23023



Hydraulic Element

Notes: OBSOLETE. Availability Limited to Dealer Stock.
Fits: Mahle Applications
Replaces: Mahle P18445DRG60; Filtrec DMD0045B60B
O.D.: 3 1/4 (82.6)
I.D.: 1 7/8 (47.6) One End
Height: 14 5/8 (371.5)

PT23018



Hydraulic Element

Fits: MP Filtri Hydraulic Assemblies
Replaces: MP Filtri HP0652M60NA
O.D.: 1 25/32 (45.2)
I.D.: 1 (25.4)
Height: 4 15/32 (113.5)
I.Gskt: [1] Included

PT23024



Hydraulic Element

Fits: MP Filtri Hydraulic Assemblies
Replaces: MP Filtri CU250M60N
O.D.: 3 13/32 (86.5)
I.D.: 2 1/8 (54.0)
Height: 8 3/8 (212.7)
I.Gskt: [2] Included

PT23019



Hydraulic Element with Bail Handle

Notes: OBSOLETE. Availability Limited to Dealer Stock.
Contains: By-Pass Valve
Fits: MP Filtri Applications
Replaces: MP Filtri MF4003M60NB; Filtrec R164T60B
O.D.: 5 1/16 (128.6)
I.D.: 2 1/2 (63.5) One End
Height: 10 3/8 (263.5)
O-Ring: [1] Attached
Spring: [1] Included

PT23025



Hydraulic Element

Notes: OBSOLETE. Availability Limited to Dealer Stock.
Fits: Eppensteiner Applications
Replaces: Eppensteiner 2225G25A000P; Filtrec DVD2225B25B
O.D.: 2 7/8 (73.0)
I.D.: 1 9/16 (39.7) One End
Height: 8 13/16 (223.8)
O-Ring: [1] Attached

PT23020



Hydraulic Element

Fits: Mahle Hydraulic Assemblies
Replaces: Mahle P18330DKG40
O.D.: 3 3/16 (81.0)
I.D.: 1 7/8 (47.6) One End
Height: 10 1/32 (254.8)

PT23027













Hydraulic Element with Bail Handle

Notes: OBSOLETE. Availability Limited to Dealer Stock.
Fits: Parker Hydraulic Assemblies
Replaces: Parker 939893Q
O.D.: 9 1/8 (231.8)
I.D.: 4 1/4 (108.0) One End
Height: 11 (279.4)









Measurements Are Shown In Inches And (Millimeters)

WARNING: These products can expose you to chemicals, including Diisononyl Phthalate, Carbon black extracts, Nickel, 1,3 Butadiene, Ethylene Oxide, Epichlorohydrin, which are known to the State of California to cause cancer, and Bisphenol, Ethylene Glycol, Ethylene Oxide, 1,3 Butadiene, Epichlorohydrin, which are known to the State of California to cause birth defects or other reproductive harm. For more information go to www.P65Warnings.ca.gov.

<p>PT23028-MPG Maximum Performance Glass Hydraulic Element</p>  <p>Fits: Hydac Applications Replaces: Hydac 240D010BHHC O.D.: 2 11/16 (68.3) I.D.: 1 5/16 (33.3) One End Height: 6 13/16 (173.0) O-Ring: [1] Attached</p>	<p>PT23033-MPG Maximum Performance Glass Hydraulic Element</p>  <p>Fits: VogeLe Hydraulic Assemblies Replaces: VogeLe 9624541001 O.D.: 4 1/2 (114.3) I.D.: 2 23/32 (69.1) Height: 15 23/32 (399.3) I.Gskt: [2] Included</p>
<p>PT23029-MPG Maximum Performance Glass Hydraulic Element</p>  <p>Fits: MP Filtri Applications Replaces: MP Filtri HP3202A10NA O.D.: 3 1/16 (77.8) I.D.: 1 1/2 (38.1) One End Height: 9 1/4 (235.0) O-Ring: [1] Attached</p>	<p>PT23034-MPG Maximum Performance Glass Hydraulic Element</p>  <p>Fits: Parker Hydraulic Assemblies Replaces: Parker G01068 O.D.: 3 3/8 (85.7) I.D.: 2 1/8 (54.0) One End Height: 7 3/4 (196.9) I.Gskt: [1] Included</p>
<p>PT23030-MPG Maximum Performance Glass Hydraulic Element</p>  <p>Fits: Pall Applications Replaces: Pall HC8800FKS16H O.D.: 3 3/8 (85.7) I.D.: 1 15/16 (49.2) One End Height: 16 7/8 (428.6) O-Ring: [1] Attached</p>	<p>PT23035-MPG Maximum Performance Glass Hydraulic Element with Bail Handle</p>  <p>Fits: MP Filtri Hydraulic Assemblies Replaces: MP Filtri 1003A25HB O.D.: 2 5/8 (66.7) I.D.: 1 3/8 (34.9) One End Height: 8 1/8 (206.4) I.Gskt: [1] Included</p>
<p>PT23031-MPG Maximum Performance Glass Hydraulic Element</p>  <p>Notes: OBSOLETE. Availability Limited to Dealer Stock. Fits: Hydac Hydraulic Assemblies Replaces: Hydac 60103D10BN O.D.: 2 1/8 (54.0) I.D.: 25/32 (19.8) Height: 2 5/8 (66.7) A. Gskt: [1] Attached F. Gskt: [1] Included</p>	<p>PT23036-MPG Maximum Performance Glass Hydraulic Element</p>  <p>Fits: MP Filtri Hydraulic Assemblies Replaces: MP Filtri HP0371A10A O.D.: 1 3/8 (34.9) I.D.: 1 1/4 (31.8) Height: 3 1/2 (88.9) I.Gskt: [1] Included</p>
<p>PT23032-MPG Maximum Performance Glass Hydraulic Element</p>  <p>Fits: Argo Equipment Replaces: Argo V3060706 O.D.: 2 1/8 (54.0) I.D.: 1 1/8 (28.6) One End Height: 2 23/32 (69.1) I.Gskt: [1] Included</p>	<p>PT23037-MPG Maximum Performance Glass Hydraulic Element</p>  <p>Fits: Hydac Hydraulic Assemblies Replaces: Hydac 60D005BNHC O.D.: 1 27/32 (46.8) I.D.: 7/8 (22.2) One End Height: 3 5/16 (84.1) I.Gskt: [1] Included</p>

Measurements Are Shown In Inches And (Millimeters)

WARNING: These products can expose you to chemicals, including Diisononyl Phthalate, Carbon black extracts, Nickel, 1,3 Butadiene, Ethylene Oxide, Epichlorohydrin, which are known to the State of California to cause cancer, and Bisphenol, Ethylene Glycol, Ethylene Oxide, 1,3 Butadiene, Epichlorohydrin, which are known to the State of California to cause birth defects or other reproductive harm. For more information go to www.P65Warnings.ca.gov.

<p>PT23038-MPG Maximum Performance Glass Hydraulic Element</p>  <p>Fits: Hydac Hydraulic Assemblies Replaces: Hydac 110D005BNHC O.D.: 13/16 (20.6) I.D.: 1 13/16 (46.0) One End Height: 5 7/8 (149.2) I.Gskt: [1] Included</p>	<p>PT23043-MPG Maximum Performance Glass Hydraulic Element</p>  <p>Fits: Hydac Hydraulic Assemblies Replaces: Hydac 10D010BHHC O.D.: 1 13/16 (46.0) I.D.: 13/16 (20.6) Height: 6 (152.4) I.Gskt: [1] Included</p>
<p>PT23039-MPG Maximum Performance Glass Hydraulic Element with Bail Handle</p>  <p>Contains: By-Pass Valve Fits: Hydac Hydraulic Assemblies Replaces: Hydac 110R010BNHC O.D.: 2 (50.8) I.D.: 13/16 (20.6) One End Height: 6 3/8 (161.9) I.Gskt: [1] Included</p>	<p>PT23044-MPG Maximum Performance Glass Hydraulic Element</p>  <p>Fits: MP Filtri Hydraulic Assemblies Replaces: MP Filtri CU250A25N O.D.: 3 29/32 (99.2) I.D.: 2 1/16 (52.4) Height: 8 3/8 (212.7) I.Gskt: [2] Included</p>
<p>PT23040-MPG Maximum Performance Glass Hydraulic Element</p>  <p>Fits: Mahle Applications Replaces: Mahle PI3115SM10 O.D.: 3 3/16 (81.0) I.D.: 1 7/8 (47.6) One End Height: 5 5/8 (142.9)</p>	<p>PT23045-MPG Maximum Performance Glass Hydraulic Element</p>  <p>Fits: Hydac Hydraulic Assemblies Replaces: Hydac 330D010BNHC O.D.: 3 1/2 (88.9) I.D.: 1 15/16 (49.2) Height: 6 5/16 (160.3) I.Gskt: [1] Included</p>
<p>PT23041-MPG Maximum Performance Glass Hydraulic Element with Bail Handle</p>  <p>Fits: MP Filtri Hydraulic Assemblies Replaces: MP Filtri MF180A25HB, Filtrec WG440 O.D.: 4 (101.6) I.D.: 1 7/16 (36.5) One End Height: 8 1/2 (215.9) I.Gskt: [1] Included</p>	<p>PT23046-MPG Maximum Performance Glass Hydraulic Element</p>  <p>Fits: Hydac Hydraulic Assemblies Replaces: Hydac 330D020BNHC O.D.: 3 1/2 (88.9) I.D.: 1 15/16 (49.2) Height: 6 1/4 (158.8) I.Gskt: [1] Included</p>
<p>PT23042-MPG Maximum Performance Glass Hydraulic Element</p>  <p>Fits: Tamrock Equipment Replaces: Tamrock 4004080 O.D.: 2 13/16 (71.4) I.D.: 1 13/16 (46.0) One End Height: 13 3/4 (349.3)</p>	<p>PT23047-MPG Maximum Performance Glass Hydraulic Element</p>  <p>Fits: MP Filtri Hydraulic Assemblies Replaces: MP Filtri HP1352A10NA O.D.: 2 1/8 (54.0) I.D.: 1 1/8 (28.6) One End Height: 9 1/8 (231.8) I.Gskt: [1] Included</p>

Measurements Are Shown In Inches And (Millimeters)

WARNING: These products can expose you to chemicals, including Diisononyl Phthalate, Carbon black extracts, Nickel, 1,3 Butadiene, Ethylene Oxide, Epichlorohydrin, which are known to the State of California to cause cancer, and Bisphenol, Ethylene Glycol, Ethylene Oxide, 1,3 Butadiene, Epichlorohydrin, which are known to the State of California to cause birth defects or other reproductive harm. For more information go to www.P65Warnings.ca.gov.

PT23048-MPG Maximum Performance Glass Hydraulic Element with Bail Handle



Fits: Donaldson Housings
Replaces: Donaldson P171561; Filtrec R160G10B
O.D.: 5 1/8 (130.2)
I.D.: 2 9/16 (65.1) One End
Height: 7 7/8 (200.0)
O-Ring: [1] Attached

PT23053-MPG Maximum Performance Glass Hydraulic Element



Notes: OBSOLETE. Availability Limited to Dealer Stock.
Fits: Eppensteiner Hydraulic Assemblies
Replaces: Eppensteiner 2460H10SLC00P
O.D.: 3 1/8 (79.4)
I.D.: 1 1/2 (38.1)
Height: 15 (381.0)
I.Gskt: [1] Included

PT23049-MPG Maximum Performance Glass Hydraulic Element



Fits: Mahle Applications
Replaces: Mahle PI4145SM25; Filtrec DMD0045E20B
O.D.: 3 1/4 (82.6)
I.D.: 1 7/8 (47.6) One End
Height: 14 9/16 (369.9)

PT23054-MPG Maximum Performance Glass Hydraulic Element



Notes: OBSOLETE. Availability Limited to Dealer Stock.
Fits: Eppensteiner Applications
Replaces: Eppensteiner 2460H10SLA000P
O.D.: 2 7/8 (73.0)
I.D.: 1 9/16 (39.7) One End
Height: 14 3/4 (374.7)
O-Ring: [1] Attached

PT23050-MPG Maximum Performance Glass Hydraulic Element



Notes: OBSOLETE. Availability Limited to Dealer Stock.
Fits: MP Filtri Applications
Replaces: MP Filtri HP3203A10NA; Filtrec D152G10A
O.D.: 3 1/16 (77.8)
I.D.: 1 9/16 (39.7) One End
Height: 14 13/16 (376.2)
O-Ring: [1] Attached

PT23055-MPG Maximum Performance Glass Hydraulic Element



Notes: OBSOLETE. Availability Limited to Dealer Stock.
Fits: Eppensteiner Applications
Replaces: Eppensteiner 232H10XLA00P
O.D.: 1 5/8 (41.3)
I.D.: 5/8 (15.9) One End
Height: 3 1/8 (79.4)
O-Ring: [1] Attached

PT23051-MPG Maximum Performance Glass Hydraulic Element



Fits: Tamrock Equipment
Replaces: Tamrock 400479
O.D.: 7 7/8 (200.0)
I.D.: 1/2 (12.7) & 6 5/8 (168.3)
Height: 26 (660.4)

PT23056-MPG Maximum Performance Glass Hydraulic Element



Notes: OBSOLETE. Availability Limited to Dealer Stock.
Fits: Eppensteiner Applications
Replaces: Eppensteiner 225H10XLC000P
O.D.: 3 (76.2)
I.D.: 1 9/16 (39.7) One End
Height: 9 1/8 (231.8)
O-Ring: [1] Attached

PT23052-MPG Maximum Performance Glass Hydraulic Element



Fits: Hydac Hydraulic Assemblies
Replaces: Hydac 660D010BHHC
O.D.: 3 3/8 (85.7)
I.D.: 1 7/8 (47.6)
Height: 13 (330.2)
I.Gskt: [1] Included

PT23057-MPG Maximum Performance Glass Hydraulic Element



Notes: OBSOLETE. Availability Limited to Dealer Stock.
Fits: Eppensteiner Applications
Replaces: Eppensteiner 2460H20LLH000P
O.D.: 3 (76.2)
I.D.: 1 9/16 (39.7) One End
Height: 14 3/4 (374.7)
O-Ring: [1] Attached

PT23058-MPG Maximum Performance Glass Hydraulic Element



Notes: OBSOLETE. Availability Limited to Dealer Stock.
Fits: Parker Hydraulic Assemblies
Replaces: Parker G02832
O.D.: 1 27/32 (46.8)
I.D.: 1 (25.4) One End
Height: 3 23/32 (94.5)

PT23058-MPG Maximum Performance Glass Hydraulic Element



Notes: OBSOLETE. Availability Limited to Dealer Stock.
Fits: Parker Hydraulic Assemblies
Replaces: Parker G02832
O.D.: 1 27/32 (46.8)
I.D.: 1 (25.4) One End
Height: 3 23/32 (94.5)











Measurements Are Shown In Inches And (Millimeters)

WARNING: These products can expose you to chemicals, including Diisononyl Phthalate, Carbon black extracts, Nickel, 1,3 Butadiene, Ethylene Oxide, Epichlorohydrin, which are known to the State of California to cause cancer, and Bisphenol, Ethylene Glycol, Ethylene Oxide, 1,3 Butadiene, Epichlorohydrin, which are known to the State of California to cause birth defects or other reproductive harm. For more information go to www.P65Warnings.ca.gov.

<p>PT23059-MPG Maximum Performance Glass Hydraulic Element</p>  <p>Fits: Kalmer Applications Replaces: Kalmer 9239440053 O.D.: 2 5/8 (66.7) I.D.: 1 1/8 (28.6) Height: 9 5/8 (244.5) I.Gskt: [1] Included F. Gskt: [1] Backup Ring, [1] Included</p>	<p>PT23064-MPG Maximum Performance Glass Hydraulic Element</p>  <p>Fits: MP Filtri Hydraulic Systems Replaces: MP Filtri HP0372A10A O.D.: 1 3/8 (34.9) I.D.: 13/16 (20.6) One End Height: 7 (177.8) I.Gskt: [1] Included</p>
<p>PT23060-MPG Maximum Performance Glass Hydraulic Element with Bail Handle</p>  <p>Fits: Hydac Applications Replaces: Hydac 240R010BNHC O.D.: 2 3/4 (69.9) I.D.: 1 5/8 (41.3) One End Height: 7 11/16 (195.3) O-Ring: [1] Attached</p>	<p>PT23065-MPG Maximum Performance Glass Hydraulic Element with Bail Handle</p>  <p>Notes: OBSOLETE. Availability Limited to Dealer Stock. Fits: Hydac Applications Replaces: Hydac 2600R010BNHC O.D.: 5 1/2 (139.7) I.D.: 3 3/4 (95.3) Height: 36 11/16 (931.9) I.Gskt: [1] Included</p>
<p>PT23061-MPG Maximum Performance Glass Hydraulic Element with Bail Handle</p>  <p>Fits: Hydac Applications Replaces: Hydac 330R010BNHC O.D.: 3 3/8 (85.7) I.D.: 1 7/8 (47.6) One End Height: 7 7/8 (200.0)</p>	<p>PT23066-MPG Maximum Performance Glass Hydraulic Element</p>  <p>Fits: Hydac Hydraulic Systems Replaces: Hydac 140D010BNHC O.D.: 1 13/16 (46.0) I.D.: 13/16 (20.6) One End Height: 7 3/8 (187.3) I.Gskt: [1] Included</p>
<p>PT23062-MPG Maximum Performance Glass Hydraulic Element with Bail Handle</p>  <p>Fits: Hydac Applications Replaces: Hydac 1300R010BNHC; Filtrec RHR1300610B O.D.: 5 5/16 (134.9) I.D.: 3 3/4 (95.3) One End Height: 19 7/16 (493.7) I.Gskt: [1] Included</p>	<p>PT23067-MPG Maximum Performance Glass Hydraulic Element</p>  <p>Fits: Hydac Hydraulic Systems Replaces: Hydac 140D020BNHC O.D.: 1 13/16 (46.0) I.D.: 1 1/8 (28.6) One End Height: 7 3/8 (187.3) I.Gskt: [1] Included</p>
<p>PT23063-MPG Maximum Performance Glass Hydraulic Element with Bail Handle</p>  <p>Replaces: Donaldson P171544 O.D.: 3 29/32 (99.2) I.D.: 1 5/8 (41.3) One End Height: 9 27/32 (250.0) I.Gskt: [1] Included Spring: [1] Included</p>	<p>PT23068-MPG Maximum Performance Glass Hydraulic Element</p>  <p>Notes: OBSOLETE. Availability Limited to Dealer Stock. Fits: Eppensteiner Applications Replaces: Eppensteiner 20045H10XLA000P, 20045H10SLA000P; Filtrec DVD20045E10B O.D.: 3 1/8 (79.4) I.D.: 1 5/8 (41.3) One End Height: 15 11/16 (398.5) O-Ring: [1] Attached</p>











Measurements Are Shown In Inches And (Millimeters)

WARNING: These products can expose you to chemicals, including Diisononyl Phthalate, Carbon black extracts, Nickel, 1,3 Butadiene, Ethylene Oxide, Epichlorohydrin, which are known to the State of California to cause cancer, and Bisphenol, Ethylene Glycol, Ethylene Oxide, 1,3 Butadiene, Epichlorohydrin, which are known to the State of California to cause birth defects or other reproductive harm. For more information go to www.P65Warnings.ca.gov.

<p>PT23070-MPG Maximum Performance Glass Hydraulic Element</p>  <p>Fits: Pall Hydraulic Systems Replaces: Pall HC2252FKT19H O.D.: 3 5/8 (92.1) I.D.: 1 3/4 (44.4) & 2 1/8 (54.0) Height: 18 7/8 (479.4) I.Gskt: [1] Included</p>	<p>PT23076-MPG Maximum Performance Glass Hydraulic Element</p>  <p>Fits: Pall Hydraulic Systems Replaces: Pall HC9100FKS8Z O.D.: 2 3/4 (69.9) I.D.: 1 5/16 (33.3) Height: 8 1/4 (209.6) I.Gskt: [1] Included</p>
<p>PT23071-MPG Maximum Performance Glass Hydraulic Element</p>  <p>Notes: OBSOLETE. Availability Limited to Dealer Stock. Fits: Parker Hydraulic Systems Replaces: Parker 939905Q O.D.: 3 (76.2) I.D.: 1 (25.4) Height: 5 7/8 (149.2) I.Gskt: [1] Included</p>	<p>PT23077-MPG Maximum Performance Glass Hydraulic Element</p>  <p>Fits: MP Filtri Hydraulic Systems Replaces: MP Filtri HP0372A06A O.D.: 1 5/8 (41.3) I.D.: 13/16 (20.6) Height: 7 (177.8) I.Gskt: [1] Included</p>
<p>PT23072-MPG Maximum Performance Glass Hydraulic Element</p>  <p>Notes: OBSOLETE. Availability Limited to Dealer Stock. Contains: By-Pass Valve Fits: Eppensteiner Hydraulic Systems Replaces: Eppensteiner 20330H10SLS004P O.D.: 4 (101.6) I.D.: 2 3/8 (60.3) One End Height: 10 7/8 (276.2) End Seals: [1] Attached</p>	<p>PT23078-MPG Maximum Performance Glass Hydraulic Element</p>  <p>Fits: Parker Hydraulic Systems Replaces: Parker G01938Q O.D.: 2 5/8 (66.7) I.D.: 1 1/8 (28.6) Height: 9 5/8 (244.5) O-Ring: [1] Attached</p>
<p>PT23073-MPG Maximum Performance Glass Hydraulic Element</p>  <p>Notes: OBSOLETE. Availability Limited to Dealer Stock. Fits: MP Filtri Hydraulic Systems Replaces: MP Filtri HP0201A10HA O.D.: 1 1/8 (34.9) I.D.: 21/32 (16.7) Height: 3 15/16 (100.0) I.Gskt: [1] Included</p>	<p>PT23079-MPG Maximum Performance Glass Hydraulic Element</p>  <p>Fits: Parker Applications Replaces: Parker G01946 O.D.: 3 9/16 (90.5) I.D.: 1 7/8 (47.6) One End Height: 7 7/8 (200.0) O-Ring: [1] Attached</p>
<p>PT23074-MPG Maximum Performance Glass Hydraulic Element</p>  <p>Notes: OBSOLETE. Availability Limited to Dealer Stock. Fits: Pall Hydraulic Systems Replaces: Pall HC9021FKS4H O.D.: 1 3/4 (44.4) I.D.: 1 1/8 (28.6) Height: 4 1/2 (114.3) I.Gskt: [1] Included</p>	<p>PT23080-MPG Maximum Performance Glass Hydraulic Element</p>  <p>Fits: Parker Applications Replaces: Parker G04276 O.D.: 3 11/16 (93.7) I.D.: 1 13/16 (46.0) Height: 7 15/16 (201.6) F. Gskt: [1] Backup Ring, [1] Included O-Ring: [2] Included</p>
<p>PT23075-MPG Maximum Performance Glass Hydraulic Element</p>  <p>Notes: OBSOLETE. Availability Limited to Dealer Stock. Fits: MP Filtri Hydraulic Systems Replaces: MP Filtri HP1352A10HA O.D.: 2 (50.8) I.D.: 1 1/4 (31.8) One End Height: 9 1/4 (235.0) I.Gskt: [1] Included</p>	

Measurements Are Shown In Inches And (Millimeters)

WARNING: These products can expose you to chemicals, including Diisononyl Phthalate, Carbon black extracts, Nickel, 1,3 Butadiene, Ethylene Oxide, Epichlorohydrin, which are known to the State of California to cause cancer, and Bisphenol, Ethylene Glycol, Ethylene Oxide, 1,3 Butadiene, Epichlorohydrin, which are known to the State of California to cause birth defects or other reproductive harm. For more information go to www.P65Warnings.ca.gov.

<p>PT23081-MPG Maximum Performance Glass Hydraulic Element</p>  <p>Fits: Parker Applications Replaces: Parker G04284 O.D.: 3 11/16 (93.7) I.D.: 1 3/4 (44.4) Height: 12 9/16 (319.1) F. Gskt: [1] Backup Ring, [1] Included O-Ring: [2] Included</p>	<p>PT23086-MPG Maximum Performance Glass Hydraulic Element</p>  <p>Fits: Hydac Hydraulic Systems Replaces: Hydac 30D010BH3HC O.D.: 1 1/4 (31.8) I.D.: 3/8 (9.5) One End Height: 3 5/8 (92.1) O-Ring: [1] Attached</p>
<p>PT23082-MPG Maximum Performance Glass Hydraulic Element</p>  <p>Fits: Argo Hydraulic Systems Replaces: Argo V3052006 O.D.: 1 3/4 (44.4) I.D.: 3/4 (19.0) One End Height: 7 13/16 (198.4) O-Ring: [1] Attached</p>	<p>PT23087-MPG Maximum Performance Glass Hydraulic Element</p>  <p>Fits: Hydac Hydraulic Systems Replaces: Hydac 35D003BNHC O.D.: 2 1/4 (57.2) I.D.: 15/16 (23.8) One End Height: 2 13/16 (71.4) O-Ring: [1] Attached</p>
<p>PT23083-MPG Maximum Performance Glass Hydraulic Element</p>  <p>Fits: Argo Hydraulic Systems Replaces: Argo V3052008 O.D.: 1 3/4 (44.4) I.D.: 3/4 (19.0) One End Height: 7 3/4 (196.9) O-Ring: [1] Attached</p>	<p>PT23088-MPG Maximum Performance Glass Hydraulic Element</p>  <p>Fits: Hydac Hydraulic Systems Replaces: Hydac 35D010BNHC O.D.: 2 1/8 (54.0) I.D.: 15/16 (23.8) One End Height: 2 3/4 (69.9) O-Ring: [1] Attached</p>
<p>PT23084-MPG Maximum Performance Glass Hydraulic Element</p>  <p>Fits: Argo Hydraulic Systems Replaces: Argo V3062306 O.D.: 2 1/8 (54.0) I.D.: 1 1/8 (28.6) One End Height: 9 1/8 (231.8) O-Ring: [1] Attached</p>	<p>PT23089-MPG Maximum Performance Glass Hydraulic Element</p>  <p>Fits: Hydac Hydraulic Systems Replaces: Hydac 500D010BNHC O.D.: 3 1/2 (88.9) I.D.: 1 7/8 (47.6) One End Height: 10 (254.0) O-Ring: [1] Attached</p>
<p>PT23085-MPG Maximum Performance Glass Hydraulic Element</p>  <p>Fits: Argo Applications Replaces: Argo V308330; Filtrec D841G10A O.D.: 3 1/16 (77.8) I.D.: 1 1/2 (38.1) One End Height: 9 3/16 (233.4) O-Ring: [1] Attached</p>	<p>PT23090-MPG Maximum Performance Glass Hydraulic Element</p>  <p>Fits: Hydac Hydraulic Systems Replaces: Hydac 55D010BNHC O.D.: 2 1/8 (54.0) I.D.: 15/16 (23.8) One End Height: 4 5/8 (117.5) O-Ring: [1] Attached</p>

Measurements Are Shown In Inches And (Millimeters)

WARNING: These products can expose you to chemicals, including Diisononyl Phthalate, Carbon black extracts, Nickel, 1,3 Butadiene, Ethylene Oxide, Epichlorohydrin, which are known to the State of California to cause cancer, and Bisphenol, Ethylene Glycol, Ethylene Oxide, 1,3 Butadiene, Epichlorohydrin, which are known to the State of California to cause birth defects or other reproductive harm. For more information go to www.P65Warnings.ca.gov.

PT23091-MPG Maximum Performance Glass Hydraulic Element



Fits: Hydac Hydraulic Systems
Replaces: Hydac 95D010BNHC
O.D.: 2 1/8 (54.0)
I.D.: 15/16 (23.8) One End
Height: 8 1/8 (206.4)
O-Ring: [1] Attached

PT23096-MPG Maximum Performance Glass Hydraulic Element



Notes: OBSOLETE. Availability Limited to Dealer Stock.
Fits: Eppensteiner Hydraulic Systems
Replaces: Eppensteiner 232H10XLC000P
O.D.: 1 13/16 (46.0)
I.D.: 15/16 (23.8) One End
Height: 3 1/8 (79.4)
O-Ring: [1] Attached

PT23092-MPG Maximum Performance Glass Hydraulic Element



Fits: Parker Hydraulic Systems
Replaces: Parker 938309Q
O.D.: 2 1/8 (54.0)
I.D.: 15/16 (23.8) One End
Height: 8 1/8 (206.4)
O-Ring: [1] Attached

PT23097-MPG Maximum Performance Glass Hydraulic Element with Bail Handle



Fits: MP Filtri Hydraulic Systems
Replaces: MP Filtri MF0301A10NB
O.D.: 2 (50.8)
I.D.: 15/16 (23.8) One End
Height: 3 (76.2)
I.Gskt: [1] Included
Spring: [1] Included

PT23093-MPG Maximum Performance Glass Hydraulic Element



Fits: Internormen Applications
Replaces: Internormen 1E24010VG30EP
O.D.: 2 3/8 (60.3)
I.D.: 1 5/16 (33.3)
Height: 9 (228.6)
O-Ring: [1] Attached

PT23098-MPG Maximum Performance Glass Hydraulic Element with Bail Handle



Fits: MP Filtri Hydraulic Systems
Replaces: MP Filtri MF1802A10NB
O.D.: 3 7/8 (98.4)
I.D.: 1 1/2 (38.1) One End
Height: 17 1/8 (435.0)
I.Gskt: [1] Included
Spring: [1] Included

PT23094-MPG Maximum Performance Glass Hydraulic Element



Notes: OBSOLETE. Availability Limited to Dealer Stock.
Fits: Internormen Hydraulic Systems
Replaces: Internormen 1E36010VG30EP
O.D.: 2 5/8 (66.7)
I.D.: 15/16 (23.8) One End
Height: 12 1/8 (308.0)
O-Ring: [1] Attached

PT23100-MPG Maximum Performance Glass Hydraulic Element



Notes: OBSOLETE. Availability Limited to Dealer Stock.
Fits: Argo Hydraulic Systems
Replaces: Argo V3051056
O.D.: 1 11/16 (42.9)
I.D.: 3/4 (19.0) One End
Height: 4 1/8 (104.8)
I.Gskt: [1] Included

PT23095-MPG Maximum Performance Glass Hydraulic Element



Fits: Internormen Hydraulic Systems
Replaces: Internormen 1E9010VG30EP
O.D.: 1 3/4 (44.4)
I.D.: 13/16 (20.6) One End
Height: 6 3/4 (171.5)
O-Ring: [1] Attached

PT23101-MPG Maximum Performance Glass Hydraulic Element



Fits: Parker Hydraulic Systems
Replaces: Parker 1181289070
O.D.: 4 1/8 (104.8)
I.D.: 1 1/8 (28.6) & 2 13/16 (71.4)
Height: 15 3/4 (400.0)
I.Gskt: [1] Included

PT23102-MPG Maximum Performance Glass Hydraulic Element with Bail Handle













Notes: OBSOLETE. Availability Limited to Dealer Stock.
Fits: Hydac Hydraulic Systems
Replaces: Hydac 160R020BNHC
O.D.: 2 13/16 (71.4)
I.D.: 1 5/16 (33.3) One End
Height: 5 3/8 (136.5)
I.Gskt: [1] Included

PT23102-MPG Maximum Performance Glass Hydraulic Element with Bail Handle

Notes: OBSOLETE. Availability Limited to Dealer Stock.
Fits: Hydac Hydraulic Systems
Replaces: Hydac 160R020BNHC
O.D.: 2 13/16 (71.4)
I.D.: 1 5/16 (33.3) One End
Height: 5 3/8 (136.5)
I.Gskt: [1] Included









Measurements Are Shown In Inches And (Millimeters)

WARNING: These products can expose you to chemicals, including Diisononyl Phthalate, Carbon black extracts, Nickel, 1,3 Butadiene, Ethylene Oxide, Epichlorohydrin, which are known to the State of California to cause cancer, and Bisphenol, Ethylene Glycol, Ethylene Oxide, 1,3 Butadiene, Epichlorohydrin, which are known to the State of California to cause birth defects or other reproductive harm. For more information go to www.P65Warnings.ca.gov.

<p>PT23103-MPG Maximum Performance Glass Hydraulic Element with Bail Handle</p>  <p>Fits: Hydac Hydraulic Systems Replaces: Hydac 165R010BN3HC O.D.: 2 1/4 (57.2) I.D.: 1 5/16 (33.3) One End Height: 9 (228.6) I.Gskt: [1] Included</p>	<p>PT23108-MPG Maximum Performance Glass Hydraulic Element</p>  <p>Fits: Hydac Hydraulic Systems Replaces: Hydac 100DN010BNHC O.D.: 1 3/4 (44.4) I.D.: 13/16 (20.6) Height: 9 3/4 (247.7) I.Gskt: [1] Included</p>
<p>PT23104-MPG Maximum Performance Glass Hydraulic Element with Bail Handle</p>  <p>Notes: OBSOLETE. Availability Limited to Dealer Stock. Contains: By-Pass Valve Fits: Hydac Hydraulic Systems Replaces: Hydac 260R005BNHC O.D.: 5 1/2 (139.7) I.D.: 3 13/16 (96.8) One End Height: 36 11/16 (931.9) I.Gskt: [1] Included</p>	<p>PT23109-MPG Maximum Performance Glass Hydraulic Element</p>  <p>Notes: OBSOLETE. Availability Limited to Dealer Stock. Fits: Hydac Hydraulic Systems Replaces: Hydac 100DN025BNHC O.D.: 1 3/4 (44.4) I.D.: 13/16 (20.6) Height: 9 3/4 (247.7) I.Gskt: [1] Included</p>
<p>PT23105-MPG Maximum Performance Glass Hydraulic Element with Bail Handle</p>  <p>Notes: OBSOLETE. Availability Limited to Dealer Stock. Contains: By-Pass Valve Fits: Hydac Hydraulic Assemblies Replaces: Hydac 60R010BNHC O.D.: 1 15/16 (49.2) I.D.: 13/16 (20.6) One End Height: 4 (101.6) I.Gskt: [1] Included</p>	<p>PT23110-MPG Maximum Performance Glass Hydraulic Element</p>  <p>Fits: Hydac Applications Replaces: Hydac 160DN010BNHC, 1268869; Eppensteiner 20160H10SLA000P, 20160H10XLA000P; Filtrec XD160G10A O.D.: 3 1/16 (77.8) I.D.: 1 19/32 (40.5) One End Height: 6 3/16 (157.2) O-Ring: [1] Attached</p>
<p>PT23106-MPG Maximum Performance Glass Hydraulic Element with Bail Handle</p>  <p>Notes: OBSOLETE. Availability Limited to Dealer Stock. Contains: By-Pass Valve Fits: Hydac Hydraulic Systems Replaces: Hydac 660R020BNHC O.D.: 4 1/2 (114.3) I.D.: 2 11/16 (68.3) One End Height: 13 1/8 (333.4) I.Gskt: [1] Included</p>	<p>PT23111-MPG Maximum Performance Glass Hydraulic Element</p>  <p>Fits: Hydac Applications Replaces: Hydac 250DN010BNHC O.D.: 3 1/16 (77.8) I.D.: 1 9/16 (39.7) Height: 9 3/4 (247.7) O-Ring: [1] Attached</p>
<p>PT23107-MPG Maximum Performance Glass Hydraulic Element</p>  <p>Fits: Hydac Hydraulic Systems Replaces: Hydac 40DN010BNHC O.D.: 1 3/4 (44.4) I.D.: 3/4 (19.0) Height: 3 13/16 (96.8) I.Gskt: [1] Included</p>	<p>PT23112-MPG Maximum Performance Glass Hydraulic Element</p>  <p>Fits: Hydac Applications Replaces: Hydac 250DN025BNHC O.D.: 3 (76.2) I.D.: 1 9/16 (39.7) One End Height: 9 9/16 (242.9) O-Ring: [1] Attached</p>
	<p>PT23113-MPG Maximum Performance Glass Hydraulic Element</p>  <p>Notes: OBSOLETE. Availability Limited to Dealer Stock. Fits: Hydac Applications Replaces: Hydac 400DN006BNHC O.D.: 3 1/16 (77.8) I.D.: 1 1/2 (38.1) One End Height: 15 11/16 (398.5) O-Ring: [1] Attached</p>













Measurements Are Shown In Inches And (Millimeters)

WARNING: These products can expose you to chemicals, including Diisononyl Phthalate, Carbon black extracts, Nickel, 1,3 Butadiene, Ethylene Oxide, Epichlorohydrin, which are known to the State of California to cause cancer, and Bisphenol, Ethylene Glycol, Ethylene Oxide, 1,3 Butadiene, Epichlorohydrin, which are known to the State of California to cause birth defects or other reproductive harm. For more information go to www.P65Warnings.ca.gov.

<p>PT23114-MPG Maximum Performance Glass Hydraulic Element</p>  <p>Fits: Hydac Hydraulic Systems Replaces: Hydac 400DN010BNHC O.D.: 3 1/8 (79.4) I.D.: 1 1/2 (38.1) One End Height: 15 11/16 (398.5) I.Gskt: [1] Included</p>	<p>PT23120-MPG Maximum Performance Glass Hydraulic Element</p>  <p>Fits: Hydac Hydraulic Systems Replaces: Hydac 630RN010BNHC O.D.: 5 1/8 (130.2) I.D.: 2 11/16 (68.3) Height: 15 3/4 (400.0) I.Gskt: [2] Included</p>
<p>PT23115-MPG Maximum Performance Glass Hydraulic Element</p>  <p>Notes: OBSOLETE. Availability Limited to Dealer Stock. Fits: Hydac Hydraulic Systems Replaces: Hydac 63RN010BNHC O.D.: 2 1/8 (54.0) I.D.: 1 1/8 (28.6) Height: 6 1/4 (158.8) I.Gskt: [2] Included</p>	<p>PT23122 Hydraulic Strainer</p>  <p>Contains: 3 PSID By-Pass Valve Threaded Hex Nut Replaces: Schroeder SS150100 O.D.: 3 7/32 (81.8) Height: 8 9/16 (217.5)</p>
<p>PT23116-MPG Maximum Performance Glass Hydraulic Element</p>  <p>Notes: OBSOLETE. Availability Limited to Dealer Stock. Fits: Pall Hydraulic Systems Replaces: Pall HC0600FKS16H O.D.: 6 (152.4) I.D.: 3 1/2 (88.9) Height: 15 11/16 (398.5) I.Gskt: [2] Included</p>	<p>PT23123 Hydraulic Strainer</p>  <p>Contains: 3 PSID By-Pass Valve Threaded Hex Nut Replaces: Schroeder SS125100 O.D.: 3 3/16 (81.0) Height: 6 9/16 (166.7)</p>
<p>PT23117-MPG Maximum Performance Glass Hydraulic Element</p>  <p>Fits: Hydac Hydraulic Systems Replaces: Hydac 100RN010BNHC O.D.: 2 1/4 (57.2) I.D.: 1 1/8 (28.6) Height: 9 13/16 (249.2) I.Gskt: [2] Included</p>	<p>PT23124 Hydraulic Strainer</p>  <p>Contains: 3 PSID By-Pass Valve Threaded Nut: 2 Inch NPT Fits: Schroeder Industries Hydraulic Systems Replaces: Schroeder SS2100; Fleetguard HF6264; Wix 57453 O.D.: 4 3/16 (106.4) Height: 7 7/32 (183.4)</p>
<p>PT23118-MPG Maximum Performance Glass Hydraulic Element</p>  <p>Notes: OBSOLETE. Availability Limited to Dealer Stock. Fits: Hydac Hydraulic Systems Replaces: Hydac 160RN010BNHC O.D.: 3 15/16 (100.0) I.D.: 2 (50.8) Height: 6 1/4 (158.8) I.Gskt: [2] Included</p>	<p>PT23125-MPG Maximum Performance Glass Hydraulic Element</p>  <p>Fits: Schroeder Industries Hydraulic Systems Replaces: Schroeder KSX3V; Donaldson P566412 O.D.: 3 3/16 (81.0) I.D.: 1 19/32 (40.5) Height: 9 5/16 (236.5) I.Gskt: [2] Included</p>
<p>PT23119-MPG Maximum Performance Glass Hydraulic Element</p>  <p>Notes: OBSOLETE. Availability Limited to Dealer Stock. Fits: Hydac Applications Replaces: Hydac 400RN010BNHC O.D.: 5 1/16 (128.6) I.D.: 2 3/4 (69.9) One End Height: 9 3/4 (247.7) O-Ring: [2] Attached</p>	

Measurements Are Shown In Inches And (Millimeters)

WARNING: These products can expose you to chemicals, including Diisononyl Phthalate, Carbon black extracts, Nickel, 1,3 Butadiene, Ethylene Oxide, Epichlorohydrin, which are known to the State of California to cause cancer, and Bisphenol, Ethylene Glycol, Ethylene Oxide, 1,3 Butadiene, Epichlorohydrin, which are known to the State of California to cause birth defects or other reproductive harm. For more information go to www.P65Warnings.ca.gov.

<p>PT23126-MPG Maximum Glass Performance Hydraulic Element</p>  <p>Fits: Pall Hydraulic Applications Replaces: Pall HC9021FUS4H O.D.: 1 25/32 (45.2) I.D.: 1 (25.4) One End Height: 4 1/2 (114.3) I.Gskt: [1] Included</p>	<p>PT23133-MPG Maximum Performance Glass Hydraulic Element</p>  <p>Fits: Various Pall Hydraulic Applications Replaces: Pall HC2618FKP18H; Parker 934179Q; Donaldson P566705 O.D.: 6 (152.4) I.D.: 2 5/8 (66.7) Height: 17 13/16 (452.4)</p>
<p>PT23127-MPG Maximum Performance Glass Hydraulic Element</p>  <p>Fits: Allison EV40, EV50 Transmission Replaces: General Motors Corp. 29545785 O.D.: 3 7/32 (81.8) I.D.: 1 17/32 (38.9) One End Height: 4 3/16 (106.4) O-Ring: [2] Included</p>	<p>PT23135-MPG Maximum Performance Glass Hydraulic Element</p>  <p>Fits: Parker Hydraulic Systems Replaces: Parker 932633Q O.D.: 2 3/8 (60.3) I.D.: 31/32 (24.6) One End Height: 9 23/32 (246.9) O-Ring: [1] Attached</p>
<p>PT23128-MPG Maximum Performance Glass Hydraulic Element</p>  <p>Fits: Hydac Applications O.D.: 1 27/32 (46.8) I.D.: 7/8 (22.2) One End Height: 6 1/32 (153.2) O-Ring: [1] Attached</p>	<p>PT23136 Hydraulic Element</p>  <p>Contains: Threaded Nut: 7/8-14 Fits: Ford Tractors Replaces: Ford C5NN7B155A O.D.: 3 15/32 (88.1) I.D.: 5/8 (15.9) Height: 4 31/32 (126.2) A. Gskt: [1] Included F. Gskt: [1] Included</p>
<p>PT23129-MPG Maximum Performance Glass Hydraulic Element</p>  <p>Fits: Hydac Hydraulic Applications Replaces: Hydac 24D020BN3HCV O.D.: 2 3/4 (69.9) I.D.: 1 11/32 (34.1) One End Height: 6 13/16 (173.0) I.Gskt: [1] Included</p>	<p>PT23137 Hydraulic Element</p>  <p>Fits: Driltech Equipment Replaces: Driltech 318553; ACDelco PF1770; Donaldson P161917 O.D.: 4 3/8 (111.1) I.D.: 23/32 (18.3) & 2 7/16 (61.9) Height: 13 1/32 (331.0) A. Gskt: [1] Included Grommets: [1] Attached</p>
<p>PT23131-MPG Maximum Performance Glass Hydraulic Element</p>  <p>Fits: Schroeder Hydraulic Applications Replaces: Schroeder 8TSX7 O.D.: 3 1/16 (77.8) I.D.: 1 11/16 (42.9) One End Height: 8 9/32 (210.3) I.Gskt: [1] Included</p>	<p>PT23138 Hydraulic Element</p>  <p>Fits: Deutz-Fahr Tractors Replaces: SDF 4417454; Hengst E84H; Mann & Hummel H10592 O.D.: 3 7/8 (98.4) I.D.: 2 5/16 (58.7) Height: 9 (228.6)</p>
<p>PT23132-MPG Maximum Performance Glass Hydraulic Element</p>  <p>Fits: Hydac Applications Replaces: Hydac 110D003BH3HC; Fleetguard ST1038 O.D.: 1 27/32 (46.8) I.D.: 7/8 (22.2) One End Height: 6 1/32 (153.2) I.Gskt: [1] Included</p>	<p>PT23139-MPG Maximum Performance Glass Hydraulic Element</p>  <p>Fits: Heil Hydraulic Systems Replaces: Heil 750912030 O.D.: 4 7/8 (123.8) I.D.: 2 3/4 (69.9) One End Height: 19 7/8 (504.8) F. Gskt: [1] Included O-Ring: [2] Attached</p>

Measurements Are Shown In Inches And (Millimeters)

WARNING: These products can expose you to chemicals, including Diisononyl Phthalate, Carbon black extracts, Nickel, 1,3 Butadiene, Ethylene Oxide, Epichlorohydrin, which are known to the State of California to cause cancer, and Bisphenol, Ethylene Glycol, Ethylene Oxide, 1,3 Butadiene, Epichlorohydrin, which are known to the State of California to cause birth defects or other reproductive harm. For more information go to www.P65Warnings.ca.gov.

BT23140-MPG

Maximum Performance Glass Hydraulic Spin-on
Fits: Ditchwitch, Genie, Pall, Vickers Hydraulic Systems
Replaces: Pall HC7500SUP4Z
Thread: 1 1/2 -16
O.D.: 5 3/32 (129.4)
Height: 6 21/32 (169.1)
F. Gskt: [2] Included



PT23142

Hydraulic Element
Fits: Schroeder Applications
Replaces: Schroeder C10; Filtrec WP603
O.D.: 2 15/16 (74.6)
I.D.: 1 (25.4) One End
Height: 4 15/16 (125.4)
O-Ring: [1] Attached



PT23143

Hydraulic Element
Fits: Schroeder Applications
Replaces: Schroeder N3
O.D.: 1 13/16 (46.0)
I.D.: 13/16 (20.6) One End
Height: 5 5/16 (134.9)
O-Ring: [1] Attached



PT23144

Hydraulic Element
Notes: OBSOLETE. Availability Limited to Dealer Stock.
Fits: Domange Applications
Replaces: Domange FD45P10
O.D.: 3 5/8 (92.1)
I.D.: 3/8 (9.5) & 2 1/2 (63.5)
Height: 8 7/8 (225.4)
Grommets: [1] Attached



PT23145

Hydraulic Element
Fits: Parker Applications
Replaces: Parker HPR1619
O.D.: 1 7/32 (31.0)
I.D.: 17/32 (13.5)
Height: 1 1/4 (31.8)



PT23146

Hydraulic Element
Notes: OBSOLETE. Availability Limited to Dealer Stock.
Contains: By-Pass Valve
Fits: Argo Applications
Replaces: Argo K3092062; Filtrec WP457
O.D.: 3 1/4 (82.6)
I.D.: 1 1/2 (38.1) One End
Height: 7 13/16 (198.4)
O-Ring: [1] Attached



PT23147

Hydraulic Element with Bail Handle
Notes: OBSOLETE. Availability Limited to Dealer Stock.
Contains: 22 PSID By-Pass Valve
Fits: Manitou Applications
Replaces: Mahle 7686470, 852369MIC25; MP Filtri MF4001P25NB
O.D.: 5 1/2 (139.7)
I.D.: 2 1/16 (52.4)
Height: 5 11/32 (135.7)
O-Ring: [1] Included
Spring: [1] Included



PT23149

Hydraulic Element
Fits: Liebherr Applications
Replaces: Liebherr 7367204
O.D.: 3 5/16 (84.1)
I.D.: 1 11/16 (42.9)
Height: 7 1/2 (190.5)
End Seals: [2] Attached



PT23150

Hydraulic Element
Notes: OBSOLETE. Availability Limited to Dealer Stock.
Fits: Parker Applications
Replaces: Caterpillar 311536; Parker 924449
O.D.: 3 5/8 (92.1)
I.D.: 1 3/4 (44.4)
Height: 9 5/16 (236.5)
Grommets: [2] Attached



PT23151

Hydraulic Element
Notes: OBSOLETE. Availability Limited to Dealer Stock.
Fits: Argo Applications
Replaces: Arco K3134062
O.D.: 5 (127.0)
I.D.: 3 1/2 (88.9) One End
Height: 18 (457.2)
O-Ring: [1] Attached
Spring: [1] Attached







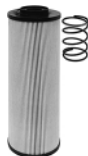





PT23152

Hydraulic Element with Bail Handle
Contains: By-Pass Valve
Fits: MP Filtri Applications
Replaces: MP Filtri MF7501P10NB; Donaldson P171581
O.D.: 5 5/16 (134.9)
I.D.: 2 1/2 (63.5)
Height: 16 (406.4)
Spring: [1] Included



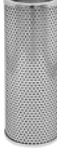









Measurements Are Shown In Inches And (Millimeters)

WARNING: These products can expose you to chemicals, including Diisononyl Phthalate, Carbon black extracts, Nickel, 1,3 Butadiene, Ethylene Oxide, Epichlorohydrin, which are known to the State of California to cause cancer, and Bisphenol, Ethylene Glycol, Ethylene Oxide, 1,3 Butadiene, Epichlorohydrin, which are known to the State of California to cause birth defects or other reproductive harm. For more information go to www.P65Warnings.ca.gov.

<p>PT23154 Hydraulic Element Fits: Parker Applications Replaces: Parker 908642 O.D.: 3 15/16 (100.0) I.D.: 2 3/8 (60.3) Height: 13 1/16 (331.8) A. Gskt: [2] Attached F. Gskt: [1] Included</p> 	<p>PT23160 Hydraulic Element Fits: PTI Applications Replaces: Bosch 1457431909, 1457431109, 1457431914; PTI PG050CH; Donaldson P174293 O.D.: 3 1/4 (82.6) I.D.: 1 7/8 (47.6) One End Height: 5 5/8 (142.9)</p> 
<p>PT23155 Hydraulic Element Fits: PTI Applications Replaces: PTI PG120DH; Donaldson P174298; Eppensteiner 18.1045P25E000P O.D.: 3 5/16 (84.1) I.D.: 2 (50.8) One End Height: 14 11/16 (373.1)</p> 	<p>PT23161 Hydraulic Element Notes: OBSOLETE. Availability Limited to Dealer Stock. Fits: Parker Applications Replaces: Parker 907233, G01070; Donaldson P170095 O.D.: 3 1/2 (88.9) I.D.: 2 3/16 (55.6) One End Height: 8 1/16 (204.8) O-Ring: [1] Attached</p> 
<p>PT23156 Hydraulic Element Fits: Caterpillar Applications Replaces: Caterpillar 3I1714; Fleetguard HF7728 O.D.: 5 5/8 (142.9) I.D.: 4 (101.6) Height: 12 3/16 (309.6) A. Gskt: [2] Attached F. Gskt: [1] Included (Adhesive Backed)</p> 	<p>PT23162 Hydraulic Element Notes: OBSOLETE. Availability Limited to Dealer Stock. Fits: Argo Applications Replaces: Argo P2072301 O.D.: 2 1/2 (63.5) I.D.: 1 3/16 (30.2) Height: 9 (228.6)</p> 
<p>PT23158 Hydraulic Element Notes: OBSOLETE. Availability Limited to Dealer Stock. Fits: Domange Applications Replaces: Domange FD66P10 O.D.: 4 31/32 (126.2) I.D.: 1/2 (12.7) & 3 5/8 (92.1) Height: 13 13/16 (350.8) Grommets: [1] Attached</p> 	<p>PT23163 Hydraulic Element Fits: Fairey-Arlon Applications Replaces: Fairey-Arlon TXX3ER10 O.D.: 2 13/16 (71.4) I.D.: 1/4 (6.4) & 1 3/4 (44.4) Height: 11 13/16 (300.0)</p> 
<p>PT23159 Hydraulic Element Notes: OBSOLETE. Availability Limited to Dealer Stock. Fits: Voegele Applications Replaces: Voegele 9606671002 O.D.: 4 1/32 (102.4) I.D.: 1/4 (6.4) Height: 12 11/16 (322.3)</p> 	<p>PT23164 Hydraulic Element Notes: OBSOLETE. Availability Limited to Dealer Stock. Fits: Argo Applications Replaces: Argo P3051052 O.D.: 1 13/16 (46.0) I.D.: 13/16 (20.6) One End Height: 4 3/16 (106.4) O-Ring: [1] Attached</p> 
	<p>PT23165 Hydraulic Element Notes: OBSOLETE. Availability Limited to Dealer Stock. Contains: By-Pass Valve Fits: Argo Applications Replaces: Argo K3092552 O.D.: 3 9/16 (90.5) I.D.: 2 5/16 (58.7) One End Height: 11 1/8 (282.6) O-Ring: [1] Attached</p> 













Measurements Are Shown In Inches And (Millimeters)

WARNING: These products can expose you to chemicals, including Diisononyl Phthalate, Carbon black extracts, Nickel, 1,3 Butadiene, Ethylene Oxide, Epichlorohydrin, which are known to the State of California to cause cancer, and Bisphenol, Ethylene Glycol, Ethylene Oxide, 1,3 Butadiene, Epichlorohydrin, which are known to the State of California to cause birth defects or other reproductive harm. For more information go to www.P65Warnings.ca.gov.

<p>PT23166</p>  <p>Hydraulic Element Fits: Parker Applications Replaces: Parker 907234, G01071; Donaldson P170096 O.D.: 3 1/2 (88.9) I.D.: 2 3/16 (55.6) One End Height: 8 1/16 (204.8) O-Ring: [1] Attached</p>	<p>PT23176</p>  <p>Hydraulic Element with Bail Handle Contains: By-Pass Valve Fits: MP Filtri Applications Replaces: MP Filtri MF1003M60NB O.D.: 2 13/16 (71.4) I.D.: 1 9/16 (39.7) One End Height: 8 7/8 (225.4) O-Ring: [1] Attached</p>
<p>PT23170</p>  <p>Hydraulic Element Notes: OBSOLETE. Availability Limited to Dealer Stock. Fits: Parker Applications Replaces: Parker 924467 O.D.: 5 9/16 (141.3) I.D.: 4 (101.6) Height: 12 1/8 (308.0) A. Gskt: [2] Attached F. Gskt: [1] Included (Adhesive Backed)</p>	<p>PT23178</p>  <p>Wire Supported Hydraulic Element Contains: By-Pass Valve Threaded Stud Fits: U.C.C. Applications Replaces: U.C.C. UCSE5104 O.D.: 3 5/16 (84.1) Height: 8 1/16 (204.8)</p>
<p>PT23172</p>  <p>Hydraulic Element Fits: Parker Applications Replaces: Parker 924730 O.D.: 2 3/4 (69.9) I.D.: 1 13/16 (46.0) Height: 9 (228.6) A. Gskt: [2] Attached</p>	<p>PT23179</p>  <p>Hydraulic Element Contains: By-Pass Valve Fits: U.C.C. Applications Replaces: U.C.C. UCSE5105 O.D.: 3 1/2 (88.9) I.D.: 2 1/2 (63.5) One End Height: 10 5/16 (261.9)</p>
<p>PT23173</p>  <p>Hydraulic Element Notes: OBSOLETE. Availability Limited to Dealer Stock. Fits: Parker Applications Replaces: Parker 922787 O.D.: 5 13/16 (147.6) I.D.: 4 1/16 (103.2) Height: 12 1/8 (308.0) A. Gskt: [2] Attached</p>	<p>PT23180</p>  <p>Hydraulic Element Notes: OBSOLETE. Availability Limited to Dealer Stock. Contains: By-Pass Valve Fits: U.C.C. Applications Replaces: U.C.C. UCSE5107 O.D.: 5 15/16 (150.8) I.D.: 3 (76.2) One End Height: 8 1/2 (215.9)</p>
<p>PT23174</p>  <p>Hydraulic Element with Bail Handle Fits: Hydac Applications Replaces: Hydac 270R015MM O.D.: 3 1/2 (88.9) I.D.: 1 1/2 (38.1) One End Height: 16 1/4 (412.8) O-Ring: [1] Attached</p>	<p>PT23181</p>  <p>Hydraulic Element Fits: Parker Applications Replaces: Parker 924455 O.D.: 3 13/16 (96.8) I.D.: 2 (50.8) Height: 9 3/8 (238.1) Grommets: [2] Attached</p>
<p>PT23175</p>  <p>Hydraulic Element Notes: OBSOLETE. Availability Limited to Dealer Stock. Contains: By-Pass Valve Threaded End Fits: U.C.C. Applications Replaces: U.C.C. UCSE5102 O.D.: 2 1/2 (63.5) I.D.: 1 3/8 (34.9) One End Height: 5 13/16 (147.6)</p>	









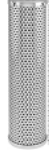

Measurements Are Shown In Inches And (Millimeters)

WARNING: These products can expose you to chemicals, including Diisononyl Phthalate, Carbon black extracts, Nickel, 1,3 Butadiene, Ethylene Oxide, Epichlorohydrin, which are known to the State of California to cause cancer, and Bisphenol, Ethylene Glycol, Ethylene Oxide, 1,3 Butadiene, Epichlorohydrin, which are known to the State of California to cause birth defects or other reproductive harm. For more information go to www.P65Warnings.ca.gov.

<p>PT23182 Hydraulic Element Fits: Parker Applications Replaces: Parker 924456 O.D.: 3 13/16 (96.8) I.D.: 2 (50.8) Height: 9 3/8 (238.1) Grommets: [2] Attached</p> 	<p>PT23188 Hydraulic Element with Bail Handle Notes: OBSOLETE. Availability Limited to Dealer Stock. Contains: By-Pass Valve Fits: MP Filtri Applications Replaces: MP Filtri MF4001M60NB O.D.: 5 3/16 (131.8) I.D.: 2 (50.8) Height: 6 (152.4) O-Ring: [1] Attached Spring: [1] Included</p> 
<p>PT23183 Hydraulic Element Notes: OBSOLETE. Availability Limited to Dealer Stock. Fits: Vickers Applications Replaces: Vickers 941056 O.D.: 4 (101.6) I.D.: 2 15/16 (74.6) Height: 6 15/16 (176.2) O-Ring: [2] Attached, [1] Included</p> 	<p>PT23190 Hydraulic Element Fits: Komatsu Applications Replaces: Komatsu 79560373 O.D.: 2 13/16 (71.4) I.D.: 1 1/2 (38.1) One End Height: 4 1/16 (103.2) O-Ring: [1] Attached</p> 
<p>PT23184 Hydraulic Element Fits: Vickers Applications Replaces: Vickers 36192 O.D.: 4 (101.6) I.D.: 2 15/16 (74.6) Height: 6 15/16 (176.2) O-Ring: [2] Attached, [1] Included</p> 	<p>PT23193-MPG Maximum Performance Glass Hydraulic Element Contains: By-Pass Valve Backup O-Ring Fits: International Applications Replaces: International 3224623-R1, 3405722-R1, 3405722-R2, 3405729-R1 O.D.: 2 3/8 (60.3) I.D.: 15/16 (23.8) One End Height: 2 13/16 (71.4) O-Ring: [1] Attached, [1] Included</p> 
<p>PT23185 Hydraulic Element Fits: MP Filtri Applications Replaces: MP Filtri CU630M90N O.D.: 5 5/16 (134.9) I.D.: 3 (76.2) Height: 9 13/16 (249.2) O-Ring: [2] Attached</p> 	<p>PT23195-MPG Maximum Performance Glass Hydraulic Element Notes: OBSOLETE. Availability Limited to Dealer Stock. Fits: Fairey-Arlon Applications Replaces: Fairey-Arlon MW1GDL20; Filtrec D410G25 O.D.: 2 5/16 (58.7) I.D.: 1 1/16 (27.0) One End Height: 4 13/16 (122.2) O-Ring: [1] Attached</p> 
<p>PT23186 Hydraulic Element Contains: Stud Thread: 2-11 BSP Fits: MP Filtri Applications Replaces: MP Filtri MPA280G1M90, STR1403SG1M90; Donaldson FIOA500, P171901 O.D.: 5 5/32 (131.0) Height: 10 15/16 (277.8) O-Ring: [1] Attached</p> 	<p>PT23196-MPG Maximum Performance Glass Hydraulic Element Notes: OBSOLETE. Availability Limited to Dealer Stock. Fits: Fairey-Arlon Applications Replaces: Fairey-Arlon TXW3CC25, TXW3GDL20 O.D.: 2 13/16 (71.4) I.D.: 1 13/16 (46.0) Height: 5 7/8 (149.2)</p> 
<p>PT23187 Hydraulic Element Fits: Fairey-Arlon Applications Replaces: Fairey-Arlon ST560 O.D.: 4 1/4 (108.0) I.D.: 3 (76.2) One End Height: 10 1/8 (257.2)</p> 	<p>PT23197-MPG Maximum Performance Glass Hydraulic Element Fits: Fairey-Arlon Applications Replaces: Fairey-Arlon 370L122A O.D.: 3 11/16 (93.7) I.D.: 1 29/32 (48.4) One End Height: 3 29/32 (99.2) O-Ring: [1] Included</p> 

Measurements Are Shown In Inches And (Millimeters)

WARNING: These products can expose you to chemicals, including Diisononyl Phthalate, Carbon black extracts, Nickel, 1,3 Butadiene, Ethylene Oxide, Epichlorohydrin, which are known to the State of California to cause cancer, and Bisphenol, Ethylene Glycol, Ethylene Oxide, 1,3 Butadiene, Epichlorohydrin, which are known to the State of California to cause birth defects or other reproductive harm. For more information go to www.P65Warnings.ca.gov.

<p>PT23198-MPG</p> 	<p>Maximum Performance Glass Hydraulic Element</p> <p>Notes: OBSOLETE. Availability Limited to Dealer Stock.</p> <p>Contains: By-Pass Valve</p> <p>Fits: Fendt Applications</p> <p>Replaces: Argo V3062088; Fendt G178860060030</p> <p>O.D.: 2 1/2 (63.5)</p> <p>I.D.: 1 3/16 (30.2) One End</p> <p>Height: 9 1/4 (235.0)</p> <p>O-Ring: [1] Attached</p>	<p>PT23204-MPG</p> 	<p>Maximum Performance Glass Hydraulic Element</p> <p>Notes: OBSOLETE. Availability Limited to Dealer Stock.</p> <p>Fits: P.T.I. Applications</p> <p>Replaces: P.T.I. PG050JH; Donaldson P174293</p> <p>O.D.: 3 5/16 (84.1)</p> <p>I.D.: 2 (50.8) One End</p> <p>Height: 5 9/16 (141.3)</p> <p>O-Ring: [1] Attached</p>
<p>PT23200-MPG</p> 	<p>Maximum Performance Glass Hydraulic Element</p> <p>Fits: Fairey-Arlon Applications</p> <p>Replaces: Fairey-Arlon MXW2GDL10; Filtrac D411G10</p> <p>O.D.: 2 5/16 (58.7)</p> <p>I.D.: 1 1/16 (27.0) One End</p> <p>Height: 9 3/4 (247.7)</p> <p>O-Ring: [1] Attached</p>	<p>PT23205-MPG</p> 	<p>Maximum Performance Glass Hydraulic Element</p> <p>Notes: OBSOLETE. Availability Limited to Dealer Stock.</p> <p>Fits: Pall Applications</p> <p>Replaces: Pall HC9800FDS4Z, HC9800FKS4Z; Donaldson P566394</p> <p>O.D.: 2 (50.8)</p> <p>I.D.: 15/16 (23.8) One End</p> <p>Height: 4 1/2 (114.3)</p> <p>O-Ring: [1] Attached</p>
<p>PT23201-MPG</p> 	<p>Maximum Performance Glass Hydraulic Element</p> <p>Fits: Fairey-Arlon Applications</p> <p>Replaces: Fairey-Arlon TXW3DCC10, TXW3DGDL10</p> <p>O.D.: 2 7/8 (73.0)</p> <p>I.D.: 3/8 (9.5) & 1 15/16 (49.2)</p> <p>Height: 7 7/8 (200.0)</p>	<p>PT23206-MPG</p> 	<p>Maximum Performance Glass Hydraulic Element</p> <p>Fits: Hydac Applications</p> <p>Replaces: Hydac 160D010BNHC</p> <p>O.D.: 2 11/16 (68.3)</p> <p>I.D.: 1 1/4 (31.8) One End</p> <p>Height: 4 9/16 (115.9)</p> <p>O-Ring: [1] Attached</p>
<p>PT23202-MPG</p> 	<p>Maximum Performance Glass Hydraulic Element</p> <p>Fits: Schroeder Hydraulic Systems</p> <p>Replaces: Schroeder NS7, NZ10; Fleetguard HF7351</p> <p>O.D.: 1 3/4 (44.4)</p> <p>I.D.: 3/4 (19.0) One End</p> <p>Height: 5 3/8 (136.5)</p> <p>O-Ring: [1] Attached</p>	<p>PT23207-MPG</p> 	<p>Maximum Performance Glass Hydraulic Element</p> <p>Fits: Hydac Applications</p> <p>Replaces: Hydac 160D005BNHC</p> <p>O.D.: 2 3/4 (69.9)</p> <p>I.D.: 1 7/16 (36.5) One End</p> <p>Height: 4 5/8 (117.5)</p> <p>F. Gskt: [1] Included</p> <p>O-Ring: [1] Attached, [1] Backup O-Ring</p>
<p>PT23203-MPG</p> 	<p>Maximum Performance Glass Hydraulic Element</p> <p>Fits: Schroeder Applications</p> <p>Replaces: Schroeder CS7, CZ10; Donaldson P171311</p> <p>O.D.: 2 3/4 (69.9)</p> <p>I.D.: 1 (25.4) One End</p> <p>Height: 4 3/4 (120.7)</p> <p>O-Ring: [1] Attached</p>	<p>PT23209-MPG</p> 	<p>Maximum Performance Glass Hydraulic Element</p> <p>Fits: Pall Applications</p> <p>Replaces: Pall HC2252FKS10H</p> <p>O.D.: 3 15/16 (100.0)</p> <p>I.D.: 1 7/8 (47.6) One End</p> <p>Height: 9 3/16 (233.4)</p> <p>Grommets: [1] Attached</p>
		<p>PT23211-MPG</p> 	<p>Maximum Performance Glass Hydraulic Element</p> <p>Fits: Schroeder Applications</p> <p>Replaces: Schroeder KKS1, KKZ3; Cim-Tek 30144</p> <p>O.D.: 3 7/8 (98.4)</p> <p>I.D.: 1 5/8 (41.3)</p> <p>Height: 18 1/2 (469.9)</p> <p>F. Gskt: [1] Included</p> <p>O-Ring: [2] Attached</p>

Measurements Are Shown In Inches And (Millimeters)

WARNING: These products can expose you to chemicals, including Diisononyl Phthalate, Carbon black extracts, Nickel, 1,3 Butadiene, Ethylene Oxide, Epichlorohydrin, which are known to the State of California to cause cancer, and Bisphenol, Ethylene Glycol, Ethylene Oxide, 1,3 Butadiene, Epichlorohydrin, which are known to the State of California to cause birth defects or other reproductive harm. For more information go to www.P65Warnings.ca.gov.

PT23212-MPG Maximum Performance Glass Hydraulic Element
Notes: OBSOLETE. Availability Limited to Dealer Stock.
Fits: Parker Applications
Replaces: Parker 940054Q
O.D.: 2 3/4 (69.9)
I.D.: 1 3/8 (34.9) One End
Height: 5 (127.0)
O-Ring: [1] Attached



PT23217-MPG Maximum Performance Glass Hydraulic Element
Fits: Pall Applications
Replaces: Pall HC9604FKS8Z
O.D.: 1 5/32 (29.4)
I.D.: 2 (50.8) One End
Height: 8 (203.2)
O-Ring: [1] Attached



PT23213-MPG Maximum Performance Glass Hydraulic Element
Fits: Parker Applications
Replaces: Parker 924452, 924452Q
O.D.: 3 11/16 (93.7)
I.D.: 2 (50.8)
Height: 9 1/8 (231.8)
Grommets: [2] Attached



PT23218-MPG Maximum Performance Glass Hydraulic Element
Notes: OBSOLETE. Availability Limited to Dealer Stock.
Fits: Pall Applications
Replaces: Pall HC9021FKS4Z
O.D.: 1 5/8 (41.3)
I.D.: 15/16 (23.8) One End
Height: 4 1/2 (114.3)
O-Ring: [1] Attached



PT23214-MPG Maximum Performance Glass Hydraulic Element
Notes: OBSOLETE. Availability Limited to Dealer Stock.
Fits: Fairey-Arlon Applications
Replaces: Fairey-Arlon TXW5GDL6; Donaldson P763010
O.D.: 4 1/8 (104.8)
I.D.: 5/8 (15.9) & 2 13/16 (71.4)
Height: 10 1/4 (260.3)



PT23219-MPG Maximum Performance Glass Hydraulic Element
Fits: Pall Applications
Replaces: Pall HC9600FDS4Z, HC9600FKS4Z, HC9600FUS4Z
O.D.: 3 5/32 (80.2)
I.D.: 1 1/8 (28.6) One End
Height: 4 7/32 (107.2)



PT23215-MPG Maximum Performance Glass Hydraulic Element
Fits: Fairey-Arlon Applications
Replaces: Fairey-Arlon TXW4CC10, TXW4GDL10; Donaldson P171826
O.D.: 4 5/16 (109.5)
I.D.: 3 (76.2) One End
Height: 7 9/16 (192.1)



PT23220-MPG Maximum Performance Glass Hydraulic Element
Fits: Hydac Applications
Replaces: Hydac 1262386, 280D010BNHC, 280D010BN3HC; Donaldson P560141
O.D.: 2 3/4 (69.9)
I.D.: 1 3/8 (34.9) One End
Height: 14 (355.6)
O-Ring: [1] Attached



PT23216-MPG Maximum Performance Glass Hydraulic Element
Fits: Fairey-Arlon Applications
Replaces: Fairey-Arlon 370L222A
O.D.: 3 11/16 (93.7)
I.D.: 1 29/32 (48.4) One End
Height: 7 27/32 (199.2)
F. Gskt: [1] Included
O-Ring: [1] Attached













PT23221-MPG Maximum Performance Glass Hydraulic Element
Notes: OBSOLETE. Availability Limited to Dealer Stock.
Fits: Fairey-Arlon Applications
Replaces: Fairey-Arlon 370L323A, 370P310, 370Z310A, 370Z323A, 820P325, 820P335, 870P310
O.D.: 3 3/4 (95.3)
I.D.: 1 7/8 (47.6) One End
Height: 12 5/8 (320.7)
F. Gskt: [1] Included
O-Ring: [1] Attached



Measurements Are Shown In Inches And (Millimeters)

WARNING: These products can expose you to chemicals, including Diisononyl Phthalate, Carbon black extracts, Nickel, 1,3 Butadiene, Ethylene Oxide, Epichlorohydrin, which are known to the State of California to cause cancer, and Bisphenol, Ethylene Glycol, Ethylene Oxide, 1,3 Butadiene, Epichlorohydrin, which are known to the State of California to cause birth defects or other reproductive harm. For more information go to www.P65Warnings.ca.gov.

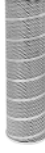
<p>PT23223-MPG Maximum Performance Glass Hydraulic Element</p>  <p>Fits: Pall, Parker Applications Replaces: Pall HC8900FUS13H; Filtrac D612G10 O.D.: 3 3/4 (95.3) I.D.: 2 1/4 (57.2) One End Height: 12 7/8 (327.0) O-Ring: [1] Attached</p>	<p>PT23229-MPG Maximum Performance Glass Hydraulic Element with Bail Handle</p>  <p>Fits: MP Filtri Applications Replaces: MP Filtri MF4002A25HB, MF4002A25NB O.D.: 5 5/16 (134.9) I.D.: 2 1/2 (63.5) One End Height: 8 5/16 (211.1) O-Ring: [1] Attached Spring: [1] Included</p>
<p>PT23224-MPG Maximum Performance Glass Hydraulic Element</p>  <p>Fits: Pall Applications Replaces: Pall HC8900FDT13H, HC8900FKT13H, HC8900FUT13H O.D.: 3 3/4 (95.3) I.D.: 2 1/8 (54.0) One End Height: 12 7/8 (327.0) O-Ring: [1] Attached</p>	<p>PT23230-MPG Maximum Performance Glass Hydraulic Element</p>  <p>Notes: OBSOLETE. Availability Limited to Dealer Stock. Fits: Parker Applications Replaces: Parker 976191, G01069 O.D.: 3 1/2 (88.9) I.D.: 2 1/4 (57.2) One End Height: 7 7/8 (200.0) O-Ring: [1] Attached</p>
<p>PT23226-MPG Maximum Performance Glass Hydraulic Element</p>  <p>Notes: OBSOLETE. Availability Limited to Dealer Stock. Fits: Pall Applications Replaces: Pall HC9604FL516Z O.D.: 3 1/8 (79.4) I.D.: 2 (50.8) Height: 16 9/16 (420.7) O-Ring: [1] Attached</p>	<p>PT23231-MPG Maximum Performance Glass Hydraulic Element</p>  <p>Fits: Pall Applications Replaces: Pall HC8900FDN13H, HC8900FKN13H, HC8900FUN13H O.D.: 3 3/4 (95.3) I.D.: 2 1/8 (54.0) One End Height: 12 7/8 (327.0) O-Ring: [1] Attached</p>
<p>PT23227-MPG Maximum Performance Glass Hydraulic Element</p>  <p>Fits: Schroeder Applications Replaces: Schroeder 27KS15, 27KZ25, KKK15, KKK25 O.D.: 4 (101.6) I.D.: 1 15/16 (49.2) Height: 27 11/16 (703.3) O-Ring: [2] Attached</p>	<p>PT23232-MPG Maximum Performance Glass Hydraulic Element</p>  <p>Fits: Fairey-Arlon Applications Replaces: Fairey-Arlon TXW5AGDL6 O.D.: 4 1/8 (104.8) I.D.: 3/8 (9.5) & 2 3/4 (69.9) Height: 18 1/4 (463.6)</p>
<p>PT23228-MPG Maximum Performance Glass Hydraulic Element</p>  <p>Notes: OBSOLETE. Availability Limited to Dealer Stock. Fits: Pall Applications Replaces: Pall HC8900FDP13H, HC8900FKP13H, HC8900FUP13H O.D.: 3 3/4 (95.3) I.D.: 2 1/8 (54.0) One End Height: 12 7/8 (327.0) O-Ring: [1] Attached</p>	<p>PT23233-MPG Maximum Performance Glass Hydraulic Element</p>  <p>Notes: OBSOLETE. Availability Limited to Dealer Stock. Fits: Parker Applications Replaces: Parker FTBE1B10Q, G02070 O.D.: 2 7/32 (56.4) I.D.: 1 3/32 (27.8) Height: 5 7/32 (132.6) O-Ring: [2] Attached</p>
	<p>PT23234-MPG Maximum Performance Glass Hydraulic Element</p>  <p>Fits: Fairey-Arlon Applications Replaces: Fairey-Arlon TXW8CCC3, TXW8CGDL3; Donaldson P174573 O.D.: 5 (127.0) I.D.: 7/16 (11.1) & 3 9/16 (90.5) Height: 18 7/8 (479.4)</p>

Measurements Are Shown In Inches And (Millimeters)

WARNING: These products can expose you to chemicals, including Diisononyl Phthalate, Carbon black extracts, Nickel, 1,3 Butadiene, Ethylene Oxide, Epichlorohydrin, which are known to the State of California to cause cancer, and Bisphenol, Ethylene Glycol, Ethylene Oxide, 1,3 Butadiene, Epichlorohydrin, which are known to the State of California to cause birth defects or other reproductive harm. For more information go to www.P65Warnings.ca.gov.

PT23235-MPG Maximum Performance Glass Hydraulic Element with Bail Handle
Notes: OBSOLETE. Availability Limited to Dealer Stock.
Fits: Pall Applications
Replaces: Pall HF8904FKS16H
O.D.: 3 27/32 (97.6)
I.D.: 2 17/32 (64.3) One End
Height: 16 11/32 (415.1)
O-Ring: [1] Attached



PT23240-MPG Maximum Performance Glass Hydraulic Element
Fits: Pall Applications
Replaces: Pall HC9801FDS8Z, HC9801FKS8Z, HC9801FUS8Z
O.D.: 2 (50.8)
I.D.: 1 (25.4) One End
Height: 8 9/16 (217.5)
O-Ring: [1] Attached



PT23236-MPG Maximum Performance Glass Hydraulic Element with Bail Handle
Notes: OBSOLETE. Availability Limited to Dealer Stock.
Fits: Pall Applications
Replaces: Pall HC8904FKS1Z
O.D.: 3 27/32 (97.6)
I.D.: 2 17/32 (64.3) One End
Height: 16 11/32 (415.1)
O-Ring: [1] Attached



PT23241-MPG Maximum Performance Glass Hydraulic Element
Fits: Hydac Applications
Replaces: Hydac 2055748, 660D020BN3HC, 660D020BNHC2
O.D.: 3 3/4 (95.3)
I.D.: 2 1/8 (54.0) One End
Height: 12 7/8 (327.0)
O-Ring: [1] Attached



PT23237-MPG Maximum Performance Glass Hydraulic Element
Fits: Pall Applications
Replaces: Pall HC6400FDS16H, HC6400FKS16H, HC6400FUS16H
O.D.: 3 3/8 (85.7)
I.D.: 1 15/16 (49.2)
Height: 16 13/16 (427.0)
O-Ring: [1] Attached



PT23242-MPG Maximum Performance Glass Hydraulic Element
Fits: Pall Applications
Replaces: Pall HC6400FDN16H, HC6400FKN16H, HC6400FUN16H
O.D.: 3 3/8 (85.7)
I.D.: 1 15/16 (49.2) One End
Height: 16 13/16 (427.0)
O-Ring: [1] Attached



PT23238-MPG Maximum Performance Glass Hydraulic Element
Notes: OBSOLETE. Availability Limited to Dealer Stock.
Fits: Pall Applications
Replaces: Pall HC6400FDN13H, HC6400FKN13H, HC6400FUN13H
O.D.: 3 7/16 (87.3)
I.D.: 2 (50.8) One End
Height: 12 7/8 (327.0)
O-Ring: [1] Attached



PT23243-MPG Maximum Performance Glass Hydraulic Element with Bail Handle
Notes: OBSOLETE. Availability Limited to Dealer Stock.
Fits: Hydac Applications
Replaces: Hydac 2066373, 500R020BN3HC, 500R020BNHC2
O.D.: 3 11/16 (93.7)
I.D.: 1 7/8 (47.6) One End
Height: 10 13/16 (274.6)
O-Ring: [1] Attached



PT23239-MPG Maximum Performance Glass Hydraulic Element
Fits: Pall Applications
Replaces: Pall HC8300FKT16H
O.D.: 5 7/8 (149.2)
I.D.: 4 1/2 (114.3)
Height: 20 9/32 (515.1)
O-Ring: [2] Attached













PT23244-MPG Maximum Performance Glass Hydraulic Element
Fits: Hydac Applications
Replaces: Hydac 1252802, 1260899, 2055746, 660D005BN3HC, 660D005BNHC
O.D.: 3 9/16 (90.5)
I.D.: 1 13/16 (46.0) One End
Height: 12 7/8 (327.0)
O-Ring: [1] Attached













Measurements Are Shown In Inches And (Millimeters)

WARNING: These products can expose you to chemicals, including Diisononyl Phthalate, Carbon black extracts, Nickel, 1,3 Butadiene, Ethylene Oxide, Epichlorohydrin, which are known to the State of California to cause cancer, and Bisphenol, Ethylene Glycol, Ethylene Oxide, 1,3 Butadiene, Epichlorohydrin, which are known to the State of California to cause birth defects or other reproductive harm. For more information go to www.P65Warnings.ca.gov.

<p>PT23245-MPG Maximum Performance Glass Hydraulic Element</p>  <p>Fits: Argo Applications Replaces: Argo V5124006 O.D.: 4 3/4 (120.7) Flange 5 3/8 (136.5) I.D.: 2 5/16 (58.7) & 3 (76.2) Height: 18 (457.2) O-Ring: [2] Attached</p>	<p>PT23250-MPG Maximum Performance Glass Hydraulic Element</p>  <p>Fits: Pall Applications Replaces: Pall HC6400FDN26H, HC6400FKN26H, HC6400FUN26H O.D.: 3 7/16 (87.3) I.D.: 1 7/8 (47.6) One End Height: 25 11/16 (652.5) O-Ring: [1] Attached</p>
<p>PT23246-MPG Maximum Performance Glass Hydraulic Element</p>  <p>Fits: Pall Applications Replaces: Pall HC9600FDN8Z, HC9600FKN8Z, HC9600FUN8Z O.D.: 3 1/2 (88.9) I.D.: 1 9/16 (39.7) One End Height: 8 3/8 (212.7) O-Ring: [1] Attached</p>	<p>PT23251-MPG Maximum Performance Glass Hydraulic Element</p>  <p>Fits: Parker Applications Replaces: Parker 933802Q, 987141, G00801 O.D.: 5 9/16 (141.3) I.D.: 4 (101.6) Height: 12 1/8 (308.0) A. Gskt: [2] Attached F. Gskt: [1] Included (Adhesive Backed)</p>
<p>PT23247-MPG Maximum Performance Glass Hydraulic Element</p>  <p>Fits: Parker Applications Replaces: Parker G02088, FTCE2B10Q O.D.: 3 11/16 (93.7) I.D.: 1 13/16 (46.0) & 1 15/16 (49.2) Height: 12 3/4 (323.8) O-Ring: [2] Attached</p>	<p>PT23252-MPG Maximum Performance Glass Hydraulic Element with Bail Handle</p>  <p>Notes: OBSOLETE. Availability Limited to Dealer Stock. Fits: Volvo EC160, EW160 Excavators Replaces: Volvo 11705962 O.D.: 3 11/16 (93.7) I.D.: 1 13/16 (46.0) One End Height: 17 1/2 (444.5) O-Ring: [1] Attached</p>
<p>PT23248-MPG Maximum Performance Glass Hydraulic Element</p>  <p>Fits: Pall Applications Replaces: Pall HC8300FDT39Z, HC8300FKT39Z, HF8300FUT39Z O.D.: 6 (152.4) I.D.: 4 1/2 (114.3) Height: 38 1/2 (977.9) O-Ring: [2] Attached</p>	<p>PT23253-MPG Maximum Performance Glass Hydraulic Element with Bail Handle</p>  <p>Fits: Hydac Applications Replaces: Hydac 2059112, 1300R020BNHC, 1300R020BN3HC, 1300R020BNHC2 O.D.: 5 5/8 (142.9) I.D.: 3 3/4 (95.3) One End Height: 18 7/8 (479.4) O-Ring: [1] Attached</p>
<p>PT23249-MPG Maximum Performance Glass Hydraulic Element</p>  <p>Notes: OBSOLETE. Availability Limited to Dealer Stock. Fits: Pall Applications Replaces: Pall HC8300FDS16H, HC8300FKS16H, HC8300FUS16H O.D.: 6 (152.4) I.D.: 4 1/32 (102.4) Height: 16 7/8 (428.6) O-Ring: [2] Attached</p>	<p>PT23254-MPG Maximum Performance Glass Hydraulic Element</p>  <p>Fits: Mahle Applications Replaces: Mahle PI2245SMXVST3, PI2245SMVST3 O.D.: 3 1/4 (82.6) I.D.: 1 13/16 (46.0) One End Height: 14 11/16 (373.1)</p>









Measurements Are Shown In Inches And (Millimeters)

WARNING: These products can expose you to chemicals, including Diisononyl Phthalate, Carbon black extracts, Nickel, 1,3 Butadiene, Ethylene Oxide, Epichlorohydrin, which are known to the State of California to cause cancer, and Bisphenol, Ethylene Glycol, Ethylene Oxide, 1,3 Butadiene, Epichlorohydrin, which are known to the State of California to cause birth defects or other reproductive harm. For more information go to www.P65Warnings.ca.gov.

<p>PT23255-MPG Maximum Performance Glass Hydraulic Element</p>  <p>Notes: OBSOLETE. Availability Limited to Dealer Stock. Contains: Reinforced Centertube Fits: Pall Applications Replaces: Pall HC8300FDP39Z, HC8300FKP39Z, HC8300FUP39Z O.D.: 6 (152.4) I.D.: 4 1/32 (102.4) Height: 38 5/8 (981.1) O-Ring: [2] Attached</p>	<p>PT23261-MPG Maximum Performance Glass Hydraulic Element</p>  <p>Notes: OBSOLETE. Availability Limited to Dealer Stock. Fits: Fairey-Arlon Applications Replaces: Fairey-Arlon 270L201A, 270L221A, 270Z221A O.D.: 3 (76.2) I.D.: 1 7/16 (36.5) One End Height: 9 1/2 (241.3) O-Ring: [1] Attached, [1] Included</p>
<p>PT23257-MPG Maximum Performance Glass Hydraulic Element</p>  <p>Notes: OBSOLETE. Availability Limited to Dealer Stock. Fits: Hydac Applications Replaces: Hydac 1277896, 3106934015M O.D.: 3 3/4 (95.3) I.D.: 2 1/4 (57.2) One End Height: 9 7/16 (239.7)</p>	<p>PT23263-MPG Maximum Performance Glass Hydraulic Element</p>  <p>Notes: OBSOLETE. Availability Limited to Dealer Stock. Fits: Pall Applications Replaces: HC9801FDS4H, HC9801FKS4H O.D.: 2 (50.8) I.D.: 7/8 (22.2) One End Height: 4 1/2 (114.3) O-Ring: [1] Attached</p>
<p>PT23258-MPG Maximum Performance Glass Hydraulic Element</p>  <p>Notes: OBSOLETE. Availability Limited to Dealer Stock. Fits: Mahle Applications Replaces: Mahle 852126SMVST25, 852126SMXVST25 O.D.: 1 3/4 (44.4) I.D.: 15/16 (23.8) One End Height: 4 1/2 (114.3) O-Ring: [1] Attached</p>	<p>PT23264-MPG Maximum Performance Glass Hydraulic Element</p>  <p>Fits: Hydac Applications Replaces: Hydac 1277952, 201RK015BN3HC O.D.: 3 15/32 (88.1) I.D.: 1 19/32 (40.5) Height: 12 29/32 (327.8) O-Ring: [2] Attached</p>
<p>PT23259-MPG Maximum Performance Glass Hydraulic Element with Bail Handle</p>  <p>Notes: OBSOLETE. Availability Limited to Dealer Stock. Fits: Hydac Applications Replaces: Hydac 660R003BNHC O.D.: 4 3/8 (111.1) I.D.: 2 9/16 (65.1) One End Height: 13 (330.2) O-Ring: [1] Attached</p>	<p>PT23265-MPG Maximum Performance Glass Hydraulic Element</p>  <p>Notes: OBSOLETE. Availability Limited to Dealer Stock. Fits: Hydac Applications Replaces: Hydac 1252797, 280D005BN3HC, 280D005BNHC, 280D005BNHC3 O.D.: 2 3/8 (60.3) I.D.: 1 1/32 (26.2) One End Height: 14 (355.6) O-Ring: [1] Attached</p>
<p>PT23260-MPG Maximum Performance Glass Hydraulic Element</p>  <p>Fits: Pall Applications Replaces: HC9020FDP4Z, HC9020FKP4Z, HC9020FUP4Z O.D.: 1 3/4 (44.4) I.D.: 15/16 (23.8) One End Height: 4 3/8 (111.1)</p>	<p>PT23266-MPG Maximum Performance Glass Hydraulic Element</p>  <p>Fits: Pall Applications Replaces: Pall HC9800FDP8Z, HF9800FKP8Z, HF9800FUP8Z O.D.: 2 1/16 (52.4) I.D.: 1 (25.4) One End Height: 8 1/8 (206.4) O-Ring: [1] Attached</p>

Measurements Are Shown In Inches And (Millimeters)

WARNING: These products can expose you to chemicals, including Diisononyl Phthalate, Carbon black extracts, Nickel, 1,3 Butadiene, Ethylene Oxide, Epichlorohydrin, which are known to the State of California to cause cancer, and Bisphenol, Ethylene Glycol, Ethylene Oxide, 1,3 Butadiene, Epichlorohydrin, which are known to the State of California to cause birth defects or other reproductive harm. For more information go to www.P65Warnings.ca.gov.

<p>PT23267-MPG Maximum Performance Glass Hydraulic Element</p>  <p>Fits: Hydac Applications Replaces: Hydac 100RK015BN3HC O.D.: 2 7/16 (61.9) I.D.: 1 1/16 (27.0) Height: 8 3/8 (212.7) O-Ring: [2] Attached</p>	<p>PT23273-MPG Maximum Performance Glass Hydraulic Element</p>  <p>Fits: Fairey-Arlon Applications Replaces: Fairey-Arlon 370L305A, 370L322A, 370P305, 370Z305A O.D.: 3 11/16 (93.7) I.D.: 1 7/8 (47.6) One End Height: 12 5/8 (320.7) O-Ring: [1] Attached</p>
<p>PT23269-MPG Maximum Performance Glass Hydraulic Element</p>  <p>Notes: OBSOLETE. Availability Limited to Dealer Stock. Fits: Pall Applications Replaces: Pall HC9600FDN4Z, HC9600FKN4Z, HC9600FUN4Z O.D.: 3 1/8 (79.4) I.D.: 1 7/8 (47.6) One End Height: 4 11/32 (110.3) O-Ring: [1] Attached</p>	<p>PT23274-MPG Maximum Performance Glass Hydraulic Element</p>  <p>Notes: OBSOLETE. Availability Limited to Dealer Stock. Fits: Pall Applications Replaces: Pall HC2237FDT6H; Parker G03183, PR3183 O.D.: 3 1/2 (88.9) I.D.: 1 15/16 (49.2) One End Height: 8 1/2 (215.9) O-Ring: [1] Attached</p>
<p>PT23270-MPG Maximum Performance Glass Hydraulic Element</p>  <p>Notes: OBSOLETE. Availability Limited to Dealer Stock. Fits: Pall Applications Replaces: Pall HC9020FDT4ZZ, HC9020FKT4Z, HC9020FUT4Z O.D.: 1 3/4 (44.4) I.D.: 15/16 (23.8) One End Height: 4 1/2 (114.3) O-Ring: [1] Attached</p>	<p>PT23275-MPG Maximum Performance Glass Hydraulic Element</p>  <p>Notes: OBSOLETE. Availability Limited to Dealer Stock. Fits: Schroeder Applications Replaces: Schroeder KSX7V O.D.: 3 1/8 (79.4) I.D.: 1 13/32 (35.7) Height: 9 5/16 (236.5) O-Ring: [2] Attached</p>
<p>PT23271-MPG Maximum Performance Glass Hydraulic Element</p>  <p>Notes: OBSOLETE. Availability Limited to Dealer Stock. Fits: Pall Applications Replaces: Pall HC9600FDS16Z, HC9600FKS16Z, HC9600FUS16Z O.D.: 3 (76.2) I.D.: 1 11/32 (34.1) One End Height: 16 15/32 (418.3) O-Ring: [1] Attached</p>	<p>PT23276-MPG Maximum Performance Glass Hydraulic Element</p>  <p>Notes: OBSOLETE. Availability Limited to Dealer Stock. Fits: Pall Applications Replaces: Pall HC2237FDT13H O.D.: 3 9/16 (90.5) I.D.: 1 9/16 (39.7) One End Height: 12 15/16 (328.6) O-Ring: [1] Attached</p>
<p>PT23272-MPG Maximum Performance Glass Hydraulic Element</p>  <p>Fits: Hydac Applications Replaces: Hydac 2055758, 280D003BN3HC, 280D003BNHC O.D.: 2 3/4 (69.9) I.D.: 1 3/8 (34.9) One End Height: 14 (355.6) O-Ring: [1] Attached</p>	<p>PT23277-MPG Maximum Performance Glass Hydraulic Element</p>  <p>Fits: Pall Applications Replaces: Pall HC8900FDS13Z, HC8900FKS13Z, HC900FUS13Z O.D.: 3 13/16 (96.8) I.D.: 2 1/4 (57.2) One End Height: 13 (330.2) O-Ring: [1] Viton Attached Related To: PT23223-MPG (Standard Gasket)</p>
	<p>PT23278-MPG Maximum Performance Glass Hydraulic Element</p>  <p>Notes: OBSOLETE. Availability Limited to Dealer Stock. Fits: Pall Applications Replaces: Pall HC9100FKT13Z O.D.: 2 13/16 (71.4) I.D.: 1 15/16 (49.2) One End Height: 13 (330.2) O-Ring: [1] Attached</p>

Measurements Are Shown In Inches And (Millimeters)

WARNING: These products can expose you to chemicals, including Diisononyl Phthalate, Carbon black extracts, Nickel, 1,3 Butadiene, Ethylene Oxide, Epichlorohydrin, which are known to the State of California to cause cancer, and Bisphenol, Ethylene Glycol, Ethylene Oxide, 1,3 Butadiene, Epichlorohydrin, which are known to the State of California to cause birth defects or other reproductive harm. For more information go to www.P65Warnings.ca.gov.

PT23279-MPG Maximum Performance Glass Hydraulic Element



Fits: Pall Applications
Replaces: Pall HC9600FDN16Z, HC9600FKN16Z, HC9600FUN16Z
O.D.: 3 1/8 (79.4)
I.D.: 1 11/32 (34.1) One End
Height: 16 15/32 (418.3)
O-Ring: [1] Attached

PT23284-MPG Maximum Performance Glass Hydraulic Element



Notes: OBSOLETE. Availability Limited to Dealer Stock.
Fits: Parker Applications
Replaces: Parker 925838, G01316Q
O.D.: 2 3/16 (55.6)
I.D.: 1 1/32 (26.2)
Height: 9 11/16 (246.1)
O-Ring: [1] Attached

PT23280-MPG Maximum Performance Glass Hydraulic Element



Notes: OBSOLETE. Availability Limited to Dealer Stock.
Fits: Pall Applications
Replaces: Pall HC9800FDN4Z, HC9800FKN4Z, HC9800FUN4Z
O.D.: 1 31/32 (50.0)
I.D.: 7/8 (22.2) One End
Height: 4 1/2 (114.3)
O-Ring: [1] Attached

PT23285-MPG Maximum Performance Glass Hydraulic Element



Fits: Pall Applications
Replaces: Pall HC9020FDT8Z, HC9020FKT8Z, HC9020FUT8Z
O.D.: 1 3/4 (44.4)
I.D.: 15/16 (23.8) One End
Height: 8 3/16 (208.0)
O-Ring: [1] Viton Attached

PT23281-MPG Maximum Performance Glass Hydraulic Element



Fits: Fairey-Arlon Applications
Replaces: Fairey-Arlon 270L205A, 270L222A, 270Z205A, 270Z222A
O.D.: 3 7/8 (98.4)
I.D.: 1 9/32 (32.5) One End
Height: 9 9/16 (242.9)
O-Ring: [1] Attached, [1] Included

PT23286-MPG Maximum Performance Glass Hydraulic Element



Fits: Pall Applications
Replaces: Pall HC9800FDT4Z, HC9800FKT4Z, HC9800FUT4Z
O.D.: 2 (50.8)
I.D.: 15/16 (23.8) One End
Height: 4 1/2 (114.3)
O-Ring: [1] Attached

PT23282-MPG Maximum Performance Glass Hydraulic Element



Fits: Schroeder Applications
Replaces: Schroeder 27KS1, 27KZ3, KKKZ3; Donaldson P174246, P566278, P566279
O.D.: 4 (101.6)
I.D.: 1 3/4 (44.4)
Height: 27 11/16 (703.3)
O-Ring: [2] Attached

PT23287-MPG Maximum Performance Glass Hydraulic Element



Fits: Hydac Applications
Replaces: Hydac 2055761, 280D020BN3HC, 280D020BNHC, 280D020BNHC2
O.D.: 2 3/4 (69.9)
I.D.: 1 3/8 (34.9) One End
Height: 14 (355.6)
O-Ring: [1] Attached

PT23283-MPG Maximum Performance Glass Hydraulic Element



Notes: OBSOLETE. Availability Limited to Dealer Stock.
Fits: Pall Applications
Replaces: Pall HC8900FDS8Z, HC8900FKS8Z, HC8900FUS8Z
O.D.: 3 3/4 (95.3)
I.D.: 2 1/8 (54.0) One End
Height: 8 1/16 (204.8)
O-Ring: [1] Attached











PT23289-MPG Maximum Performance Glass Hydraulic Element



Notes: OBSOLETE. Availability Limited to Dealer Stock.
Fits: Pall Applications
Replaces: P.T.I. (PTI/textron) PG050HH
O.D.: 3 5/32 (80.2)
I.D.: 1 15/32 (37.3)
Height: 5 9/16 (141.3)











Measurements Are Shown In Inches And (Millimeters)

WARNING: These products can expose you to chemicals, including Diisononyl Phthalate, Carbon black extracts, Nickel, 1,3 Butadiene, Ethylene Oxide, Epichlorohydrin, which are known to the State of California to cause cancer, and Bisphenol, Ethylene Glycol, Ethylene Oxide, 1,3 Butadiene, Epichlorohydrin, which are known to the State of California to cause birth defects or other reproductive harm. For more information go to www.P65Warnings.ca.gov.

<p>PT23290-MPG Maximum Performance Glass Hydraulic Element</p>  <p>Fits: Fairey-Arlon Applications Replaces: Fairey-Arlon 170L205A, 170Z222A, 170Z205A O.D.: 2 1/8 (54.0) I.D.: 3/4 (19.0) One End Height: 4 13/16 (122.2) O-Ring: [1] Attached, [1] Included</p>	<p>PT23297 Hydraulic Element</p>  <p>Fits: Schroeder Applications Replaces: Schroeder KM150 O.D.: 3 15/16 (100.0) I.D.: 1 11/16 (42.9) Height: 9 5/16 (236.5) O-Ring: [2] Attached</p>
<p>PT23291-MPG Maximum Performance Glass Hydraulic Element</p>  <p>Fits: Parker Applications Replaces: Parker 929923, 929923Q O.D.: 3 3/4 (95.3) I.D.: 2 5/16 (58.7) One End Height: 12 7/8 (327.0) O-Ring: [1] Attached</p>	<p>PT23306 Wire Mesh Media Hydraulic Strainer</p>  <p>Contains: Threaded End: 2 1/8-8 NPT Fits: Case, New Holland Loaders Replaces: New Holland L128515 O.D.: 4 7/32 (107.2) Height: 9 1/4 (235.0)</p>
<p>PT23292-MPG Maximum Performance Glass Hydraulic Element</p>  <p>Fits: International Applications Replaces: Case 1328276C1 O.D.: 2 1/8 (54.0) I.D.: 15/16 (23.8) One End Height: 4 11/16 (119.1) O-Ring: [1] Attached</p>	<p>PT23308 Hydraulic Element</p>  <p>Notes: OBSOLETE. Availability Limited to Dealer Stock. Fits: Argo Applications Replaces: Argo P3072000 O.D.: 2 3/4 (69.9) I.D.: 1 1/32 (26.2) One End Height: 7 27/32 (199.2) O-Ring: [1] Attached</p>
<p>PT23294-MPG Maximum Performance Glass Hydraulic Element</p>  <p>Fits: Pall Applications Replaces: Pall HC9020FDS4Z, HC9020FKS4Z, HC9020FUS4Z O.D.: 1 11/16 (42.9) I.D.: 15/16 (23.8) One End Height: 4 3/8 (111.1) O-Ring: [1] Attached</p>	<p>PT23309 Hydraulic Element</p>  <p>Notes: OBSOLETE. Availability Limited to Dealer Stock. Fits: Argo Applications Replaces: Argo P3051002 O.D.: 1 25/32 (45.2) I.D.: 13/16 (20.6) One End Height: 4 3/32 (104.0) O-Ring: [1] Attached</p>
<p>PT23295-MPG Maximum Performance Glass Hydraulic Element</p>  <p>Fits: Manitou Applications Replaces: Manitou 236094 O.D.: 2 11/16 (68.3) I.D.: 1 1/8 (28.6) One End Height: 9 5/8 (244.5) O-Ring: [1] Attached</p>	<p>PT23310 Hydraulic Element</p>  <p>Notes: OBSOLETE. Availability Limited to Dealer Stock. Contains: By-Pass Valve Fits: Argo Applications Replaces: Argo K3092072 O.D.: 3 9/32 (83.3) I.D.: 1 5/8 (41.3) One End Height: 8 (203.2) O-Ring: [1] Attached</p>











Measurements Are Shown In Inches And (Millimeters)

WARNING: These products can expose you to chemicals, including Diisononyl Phthalate, Carbon black extracts, Nickel, 1,3 Butadiene, Ethylene Oxide, Epichlorohydrin, which are known to the State of California to cause cancer, and Bisphenol, Ethylene Glycol, Ethylene Oxide, 1,3 Butadiene, Epichlorohydrin, which are known to the State of California to cause birth defects or other reproductive harm. For more information go to www.P65Warnings.ca.gov.

<p>PT23311 Hydraulic Element  Notes: OBSOLETE. Availability Limited to Dealer Stock. Fits: Eppensteiner Applications Replaces: Eppensteiner 290P10A000P O.D.: 2 3/32 (53.2) I.D.: 1/32 (0.8) & 1/16 (1.6) Height: 5 7/8 (149.2) O-Ring: [1] Attached</p>	<p>PT23316 Hydraulic Element  Notes: OBSOLETE. Availability Limited to Dealer Stock. Fits: Mahle Applications Replaces: Mahle 852438MIC10 O.D.: 3 29/32 (99.2) I.D.: 1 29/32 (48.4) & 2 1/16 (52.4) Height: 6 1/4 (158.8) O-Ring: [1] Attached</p>
<p>PT23312 Hydraulic Element  Notes: OBSOLETE. Availability Limited to Dealer Stock. Fits: Eppensteiner Applications Replaces: Eppensteiner 2225P25A00P O.D.: 2 15/16 (74.6) I.D.: 1 1/2 (38.1) One End Height: 8 15/16 (227.0) O-Ring: [1] Attached</p>	<p>PT23317 Hydraulic Element  Notes: OBSOLETE. Availability Limited to Dealer Stock. Fits: Mahle Applications Replaces: Mahle 852439MIC10 O.D.: 3 15/16 (100.0) I.D.: 2 (50.8) & 2 1/2 (63.5) Height: 8 1/2 (215.9) O-Ring: [1] Attached</p>
<p>PT23313 Hydraulic Element  Notes: OBSOLETE. Availability Limited to Dealer Stock. Fits: Fairey-Arlon Applications Replaces: Fairey-Arlon TXX7A10 O.D.: 4 31/32 (126.2) I.D.: 3/8 (9.5) & 3 5/8 (92.1) Height: 9 27/32 (250.0)</p>	<p>PT23318 Hydraulic Element  Notes: OBSOLETE. Availability Limited to Dealer Stock. Fits: Mahle Applications Replaces: Mahle 852754MIC25 O.D.: 4 (101.6) I.D.: 2 1/2 (63.5) Height: 19 (482.6) O-Ring: [2] Attached</p>
<p>PT23314 Hydraulic Element  Notes: OBSOLETE. Availability Limited to Dealer Stock. Fits: Fairey-Arlon Applications Replaces: Fairey-Arlon TXX10 O.D.: 2 27/32 (72.2) I.D.: 11/32 (8.7) Height: 2 5/32 (54.8)</p>	<p>PT23319 Hydraulic Element  Notes: OBSOLETE. Availability Limited to Dealer Stock. Fits: Mahle Applications Replaces: Mahle 852493MIC10 O.D.: 1 21/32 (42.1) I.D.: 29/32 (23.0) Height: 3 5/8 (92.1) O-Ring: [2] Attached</p>
<p>PT23315 Hydraulic Element  Notes: OBSOLETE. Availability Limited to Dealer Stock. Fits: Mahle Applications Replaces: Mahle 852436MIC10 O.D.: 5 1/16 (128.6) I.D.: 2 21/32 (67.5) & 2 13/16 (71.4) Height: 12 9/16 (319.1) O-Ring: [1] Attached</p>	<p>PT23320 Hydraulic Element  Notes: OBSOLETE. Availability Limited to Dealer Stock. Fits: Mahle Applications Replaces: Mahle 852443MIC25 O.D.: 2 5/16 (58.7) I.D.: 15/16 (23.8) & 1 5/16 (33.3) Height: 4 1/16 (103.2) O-Ring: [1] Attached</p>

Measurements Are Shown In Inches And (Millimeters)

WARNING: These products can expose you to chemicals, including Diisononyl Phthalate, Carbon black extracts, Nickel, 1,3 Butadiene, Ethylene Oxide, Epichlorohydrin, which are known to the State of California to cause cancer, and Bisphenol, Ethylene Glycol, Ethylene Oxide, 1,3 Butadiene, Epichlorohydrin, which are known to the State of California to cause birth defects or other reproductive harm. For more information go to www.P65Warnings.ca.gov.

<p>PT23321</p>  <p>Hydraulic Element Notes: OBSOLETE. Availability Limited to Dealer Stock. Fits: Mahle Applications Replaces: Mahle 852444MIC25 O.D.: 2 9/32 (57.9) I.D.: 13/16 (20.6) & 1 9/32 (32.5) Height: 7 3/32 (180.2) O-Ring: [1] Attached</p>	<p>PT23326</p>  <p>Hydraulic Element Notes: OBSOLETE. Availability Limited to Dealer Stock. Fits: Eppensteiner Applications Replaces: Eppensteiner 20015G25A000P O.D.: 2 7/16 (61.9) I.D.: 1 3/8 (34.9) One End Height: 7 (177.8) O-Ring: [1] Attached</p>
<p>PT23322</p>  <p>Hydraulic Element Notes: OBSOLETE. Availability Limited to Dealer Stock. Fits: Mahle Applications Replaces: Mahle 852126MICVST10 O.D.: 1 3/4 (44.4) I.D.: 1 (25.4) One End Height: 4 15/32 (113.5) O-Ring: [1] Attached</p>	<p>PT23327</p>  <p>Hydraulic Element Notes: OBSOLETE. Availability Limited to Dealer Stock. Fits: Fairey-Arlon Applications Replaces: Fairey-Arlon ST3D60; Donaldson CRS120.6, P171796 O.D.: 2 13/16 (71.4) I.D.: 5/8 (15.9) & 1 3/4 (44.4) Height: 7 7/8 (200.0) O-Ring: [1] Attached</p>
<p>PT23323</p>  <p>Hydraulic Element Notes: OBSOLETE. Availability Limited to Dealer Stock. Fits: Parker Applications Replaces: Parker 908643; Donaldson P173617, P168481 O.D.: 4 1/4 (108.0) I.D.: 3 1/16 (77.8) Height: 9 13/16 (249.2) F. Gskt: [1] Included End Seals: [2] Attached</p>	<p>PT23328</p>  <p>Hydraulic Element Notes: OBSOLETE. Availability Limited to Dealer Stock. Contains: 1 1/4 Inch NPT Threaded Stud Fits: Flow-Ezy Applications Replaces: Flow-Ezy P10114100, P20114100 O.D.: 3 13/32 (86.5) I.D.: 2 9/16 (65.1) One End Height: 5 15/32 (138.9)</p>
<p>PT23324</p>  <p>Hydraulic Element Fits: Parker Applications Replaces: Parker 924791; Donaldson P169559 O.D.: 3 21/32 (92.9) I.D.: 1 3/4 (44.4) Height: 18 1/2 (469.9) Grommets: [2] Attached</p>	<p>PT23329</p>  <p>Hydraulic Element Notes: OBSOLETE. Availability Limited to Dealer Stock. Contains: 1/2-14 Inch BSP Threaded Stud Fits: MP Filtri Applications Replaces: MP Filtri MPA025G1M90 O.D.: 2 7/8 (73.0) I.D.: 1 11/32 (34.1) One End Height: 4 3/32 (104.0)</p>
<p>PT23325</p>  <p>Hydraulic Element Notes: OBSOLETE. Availability Limited to Dealer Stock. Fits: Eppensteiner Applications Replaces: Eppensteiner 2360G252P, 2360G25C000P; Donaldson P561439 O.D.: 3 1/16 (77.8) I.D.: 1 19/32 (40.5) One End Height: 11 1/16 (281.0) O-Ring: [1] Attached</p>	<p>PT23330</p>  <p>Hydraulic Element Notes: OBSOLETE. Availability Limited to Dealer Stock. Contains: 1 1/4-11 Inch BSP Threaded Stud Fits: MP Filtri Applications Replaces: MP Filtri MPA095G1M90, STR1001SG1M90 O.D.: 4 1/32 (102.4) I.D.: 2 11/32 (59.5) One End Height: 6 3/32 (154.8)</p>
	<p>PT23331</p>  <p>Hydraulic Element Notes: OBSOLETE. Availability Limited to Dealer Stock. Fits: Parker Applications Replaces: Parker 909309 O.D.: 5 1/2 (139.7) I.D.: 4 3/16 (106.4) Height: 12 3/16 (309.6) F. Gskt: [1] Included End Seals: [1] Attached</p>

Measurements Are Shown In Inches And (Millimeters)

WARNING: These products can expose you to chemicals, including Diisononyl Phthalate, Carbon black extracts, Nickel, 1,3 Butadiene, Ethylene Oxide, Epichlorohydrin, which are known to the State of California to cause cancer, and Bisphenol, Ethylene Glycol, Ethylene Oxide, 1,3 Butadiene, Epichlorohydrin, which are known to the State of California to cause birth defects or other reproductive harm. For more information go to www.P65Warnings.ca.gov.

PT23332 Hydraulic Element
Notes: OBSOLETE. Availability Limited to Dealer Stock.
Fits: Parker Applications
Replaces: Parker 922627, G01280, G01280Q
O.D.: 2 11/32 (59.5)
I.D.: 1 13/32 (35.7)
Height: 5 5/16 (134.9)
O-Ring: [1] Attached



PT23338-MPG Maximum Performance Glass Hydraulic Element
Notes: OBSOLETE. Availability Limited to Dealer Stock.
Fits: Argo Applications
Replaces: Argo V3051018
O.D.: 1 13/16 (46.0)
I.D.: 13/16 (20.6) One End
Height: 4 1/16 (103.2)
O-Ring: [1] Attached



PT23333 Hydraulic Element
Notes: OBSOLETE. Availability Limited to Dealer Stock.
Contains: 3/4-14 Inch BSP Threaded Stud By-Pass Valve
Fits: U.C.C. Hydraulics Applications
Replaces: U.C.C. UCSE5101
O.D.: 2 1/2 (63.5)
I.D.: 1 31/32 (50.0) One End
Height: 4 9/32 (108.7)



PT23339-MPG Maximum Performance Glass Hydraulic Element
Notes: OBSOLETE. Availability Limited to Dealer Stock.
Fits: Argo Applications
Replaces: Argo V3082318
O.D.: 3 1/16 (77.8)
I.D.: 1 9/16 (39.7) One End
Height: 9 5/32 (232.6)
O-Ring: [1] Attached



PT23334 Hydraulic Element
Notes: OBSOLETE. Availability Limited to Dealer Stock.
Contains: 1 1/2-11 Inch BSP Threaded Stud By-Pass Valve
Fits: U.C.C. Hydraulics Applications
Replaces: U.C.C. UCSE5103
O.D.: 3 13/32 (86.5)
I.D.: 2 9/16 (65.1) One End
Height: 5 15/32 (138.9)



PT23340-MPG Maximum Performance Glass Hydraulic Element
Notes: OBSOLETE. Availability Limited to Dealer Stock.
Fits: Eppensteiner Applications
Replaces: Eppensteiner 2225H20SLC000P
O.D.: 3 1/16 (77.8)
I.D.: 1 19/32 (40.5) One End
Height: 9 3/32 (231.0)
O-Ring: [1] Attached



PT23335 Hydraulic Element
Notes: OBSOLETE. Availability Limited to Dealer Stock.
Contains: 3-11 Inch BSP Threaded Stud
Fits: U.C.C. Hydraulics Applications
Replaces: U.C.C. UCSE5108
O.D.: 5 29/32 (150.0)
I.D.: 4 5/16 (109.5) One End
Height: 10 23/32 (272.3)



PT23341-MPG Maximum Performance Glass Hydraulic Element
Notes: OBSOLETE. Availability Limited to Dealer Stock.
Fits: Eppensteiner Applications
Replaces: Eppensteiner 2460H20SLC000P; Donaldson P561451
O.D.: 3 1/16 (77.8)
I.D.: 1 19/32 (40.5) One End
Height: 15 (381.0)
O-Ring: [1] Attached



PT23336 Hydraulic Element
Notes: OBSOLETE. Availability Limited to Dealer Stock.
Fits: Vickers Applications
Replaces: Vickers 361741; Donaldson P168446, P173584
O.D.: 4 1/32 (102.4)
I.D.: 2 29/32 (73.8)
Height: 6 1/4 (158.8)
O-Ring: [1] Attached, [1] Included



PT23342-MPG Maximum Performance Glass Hydraulic Element
Notes: OBSOLETE. Availability Limited to Dealer Stock.
Fits: Eppensteiner Applications
Replaces: Eppensteiner 1361H10SLA000P
O.D.: 3 15/16 (100.0)
I.D.: 2 7/16 (61.9)
Height: 9 5/16 (236.5)
O-Ring: [2] Attached



PT23337 Hydraulic Element
Notes: OBSOLETE. Availability Limited to Dealer Stock.
Fits: Vickers Applications
Replaces: Vickers 361739
O.D.: 2 7/16 (61.9)
I.D.: 1 1/2 (38.1)
Height: 3 3/4 (95.3)
O-Ring: [1] Included



PT23343-MPG Maximum Performance Glass Hydraulic Element
Notes: OBSOLETE. Availability Limited to Dealer Stock.
Fits: Fairey-Arlon Applications
Replaces: Fairey-Arlon TXW14CC10, TXW14GDL10; Fleetguard HF35134
O.D.: 7 31/32 (202.4)
I.D.: 9/16 (14.3) & 6 3/16 (157.2)
Height: 42 29/32 (1089.8)
O-Ring: [1] Attached



Measurements Are Shown In Inches And (Millimeters)

WARNING: These products can expose you to chemicals, including Diisononyl Phthalate, Carbon black extracts, Nickel, 1,3 Butadiene, Ethylene Oxide, Epichlorohydrin, which are known to the State of California to cause cancer, and Bisphenol, Ethylene Glycol, Ethylene Oxide, 1,3 Butadiene, Epichlorohydrin, which are known to the State of California to cause birth defects or other reproductive harm. For more information go to www.P65Warnings.ca.gov.

PT23344-MPG Maximum Performance Glass Hydraulic Element



Notes: OBSOLETE. Availability Limited to Dealer Stock.
Fits: Fairey-Arlon Applications
Replaces: Fairey-Arlon TXW3BCC10, TXW3BGDL10
O.D.: 4 3/16 (106.4)
I.D.: 13/32 (10.3) & 2 13/16 (71.4)
Height: 5 1/2 (139.7)
O-Ring: [1] Attached

PT23350-MPG Maximum Performance Glass Hydraulic Element



Notes: OBSOLETE. Availability Limited to Dealer Stock.
Fits: Fairey-Arlon Applications
Replaces: Fairey-Arlon 270Z1FFA
O.D.: 2 15/16 (74.6)
I.D.: 1 1/4 (31.8) One End
Height: 4 3/16 (106.4)
O-Ring: [1] Included

PT23346-MPG Maximum Performance Glass Hydraulic Element



Notes: OBSOLETE. Availability Limited to Dealer Stock.
Fits: Fairey-Arlon Applications
Replaces: Fairey-Arlon 330X101, 370L1FFA, 370L120A, 370Z1FFA, 370Z120, 830X101
O.D.: 3 3/4 (95.3)
I.D.: 1 15/16 (49.2) & 1 29/32 (48.4)
Height: 4 1/8 (104.8)
O-Ring: [1] Attached, [1] Included

PT23351-MPG Maximum Performance Glass Hydraulic Element



Notes: OBSOLETE. Availability Limited to Dealer Stock.
Fits: Fairey-Arlon Applications
Replaces: Fairey-Arlon 370L101A
O.D.: 3 11/16 (93.7)
I.D.: 1 15/16 (49.2)
Height: 4 1/16 (103.2)
O-Ring: [1] Attached, [1] Included

PT23347-MPG Maximum Performance Glass Hydraulic Element



Notes: OBSOLETE. Availability Limited to Dealer Stock.
Fits: Fairey-Arlon Applications
Replaces: Fairey-Arlon MXW2CC25, MXW2GDL20
O.D.: 2 11/32 (59.5)
I.D.: 1 1/16 (27.0) One End
Height: 9 25/32 (248.4)

PT23352-MPG Maximum Performance Glass Hydraulic Element



Notes: OBSOLETE. Availability Limited to Dealer Stock.
Fits: Fairey-Arlon Applications
Replaces: Fairey-Arlon 170L1FFA, 170Z1FFA, 170L120A
O.D.: 3 23/32 (94.5)
I.D.: 25/32 (19.8) & 1 29/32 (48.4)
Height: 17 3/32 (434.2)
O-Ring: [1] Attached, [1] Included

PT23348-MPG Maximum Performance Glass Hydraulic Element



Notes: OBSOLETE. Availability Limited to Dealer Stock.
Fits: Fairey-Arlon Applications
Replaces: Fairey-Arlon 330X301, 370L3FFA, 370L320A, 370Z3FFA, 830X301
O.D.: 3 11/16 (93.7)
I.D.: 1 7/32 (31.0) & 1 29/32 (48.4)
Height: 12 19/32 (319.9)
O-Ring: [1] Attached, [1] Included

PT23353-MPG Maximum Performance Glass Hydraulic Element



Notes: OBSOLETE. Availability Limited to Dealer Stock.
Fits: FBO Applications
Replaces: FBO 456.51; Donaldson P171746
O.D.: 3 1/16 (77.8)
I.D.: 1 19/32 (40.5) One End
Height: 14 3/4 (374.7)
O-Ring: [1] Attached

PT23349-MPG Maximum Performance Glass Stacked Hydraulic Element



Notes: OBSOLETE. Availability Limited to Dealer Stock.
Fits: Fairey-Arlon Applications
Replaces: Fairey-Arlon TXW8DCC25, TXW8DGDL20
O.D.: 5 29/32 (150.0)
I.D.: 4 5/32 (105.6)
Height: 16 13/16 (427.0)
O-Ring: [1] Attached

PT23354-MPG Maximum Performance Glass Hydraulic Element



Notes: OBSOLETE. Availability Limited to Dealer Stock.
Fits: FBO Applications
Replaces: FBO 456.53; Donaldson P171748
O.D.: 3 1/16 (77.8)
I.D.: 1 19/32 (40.5) One End
Height: 14 3/4 (374.7)
O-Ring: [1] Attached

PT23355-MPG Maximum Performance Glass Hydraulic Element



Notes: OBSOLETE. Availability Limited to Dealer Stock.
Fits: Hycon Applications
Replaces: Hycon HC8400FUP16H; Donaldson P169438
O.D.: 5 31/32 (151.6)
I.D.: 3 1/4 (82.6)
Height: 16 13/16 (427.0)
O-Ring: [2] Attached











PT23355-MPG Maximum Performance Glass Hydraulic Element



Notes: OBSOLETE. Availability Limited to Dealer Stock.
Fits: Hycon Applications
Replaces: Hycon HC8400FUP16H; Donaldson P169438
O.D.: 5 31/32 (151.6)
I.D.: 3 1/4 (82.6)
Height: 16 13/16 (427.0)
O-Ring: [2] Attached

Measurements Are Shown In Inches And (Millimeters)

WARNING: These products can expose you to chemicals, including Diisononyl Phthalate, Carbon black extracts, Nickel, 1,3 Butadiene, Ethylene Oxide, Epichlorohydrin, which are known to the State of California to cause cancer, and Bisphenol, Ethylene Glycol, Ethylene Oxide, 1,3 Butadiene, Epichlorohydrin, which are known to the State of California to cause birth defects or other reproductive harm. For more information go to www.P65Warnings.ca.gov.

<p>PT23356-MPG Maximum Performance Glass Hydraulic Element</p>  <p>Fits: Hydac Applications Replaces: Hydac 280D101BH3HC O.D.: 2 3/4 (69.9) I.D.: 1 5/16 (33.3) One End Height: 14 (355.6) O-Ring: [1] Attached</p>	<p>PT23361-MPG Maximum Performance Glass Hydraulic Element</p>  <p>Notes: OBSOLETE. Availability Limited to Dealer Stock. Fits: Hydac Applications Replaces: Hydac 1260905, 2055754, 240D003BNHC, 240D003BNHC2, 240D003BN3HC O.D.: 2 23/32 (69.1) I.D.: 1 11/32 (34.1) One End Height: 6 13/16 (173.0) O-Ring: [1] Attached</p>
<p>PT23357-MPG Maximum Performance Glass Hydraulic Element</p>  <p>Fits: Hydac Applications Replaces: Hydac 160D003BNHC O.D.: 2 3/4 (69.9) I.D.: 1 3/4 (44.4) One End Height: 4 1/2 (114.3) O-Ring: [1] Attached</p>	<p>PT23362-MPG Maximum Performance Glass Hydraulic Element with Bail Handle</p>  <p>Notes: OBSOLETE. Availability Limited to Dealer Stock. Contains: By-Pass Valve Fits: Hydac Applications Replaces: Hydac 2060548, 850R020BNHC, 850F020BNHC2, 850R020BN3HC O.D.: 4 1/2 (114.3) I.D.: 2 9/16 (65.1) & 2 23/32 (69.1) Height: 15 1/2 (393.7) O-Ring: [1] Attached</p>
<p>PT23358-MPG Maximum Performance Glass Hydraulic Element</p>  <p>Fits: Hydac Applications Replaces: Hydac 1262051, 75D020BNHC, 75D020BN3HC, 75D020BNHC2 O.D.: 2 7/32 (56.4) I.D.: 1 (25.4) One End Height: 6 11/16 (169.9) O-Ring: [1] Attached</p>	<p>PT23363-MPG Maximum Performance Glass Hydraulic Element</p>  <p>Fits: Hydac Applications Replaces: Hydac 1260907, 2055736, 330D003BNHC, 330D003BNHC2, 330D003BN3HC O.D.: 3 9/16 (90.5) I.D.: 1 29/32 (48.4) One End Height: 6 3/8 (161.9) O-Ring: [1] Attached</p>
<p>PT23359-MPG Maximum Performance Glass Hydraulic Element with Bail Handle</p>  <p>Notes: OBSOLETE. Availability Limited to Dealer Stock. Fits: Hydac Applications Replaces: Hydac 500R005BNHC O.D.: 3 3/4 (95.3) I.D.: 1 15/16 (49.2) One End Height: 11 (279.4) O-Ring: [1] Attached</p>	<p>PT23364-MPG Maximum Performance Glass Hydraulic Element with Bail Handle</p>  <p>Notes: OBSOLETE. Availability Limited to Dealer Stock. Contains: By-Pass Valve Fits: Hydac Applications Replaces: Hydac 1263016, 2059104, 660R005BNHC, 660R005BNHC2 O.D.: 4 1/2 (114.3) I.D.: 2 9/16 (65.1) & 2 23/32 (69.1) Height: 12 3/8 (314.3) O-Ring: [1] Attached</p>
<p>PT23360-MPG Maximum Performance Glass Hydraulic Element with Bail Handle</p>  <p>Notes: OBSOLETE. Availability Limited to Dealer Stock. Contains: By-Pass Valve Fits: Hydac Applications Replaces: Hydac 2059110, 1300R005BNHC, 1300R005BNHC2 O.D.: 5 21/32 (143.7) I.D.: 3 3/4 (95.3) & 3 25/32 (96.0) Height: 19 1/32 (483.4) O-Ring: [1] Attached</p>	<p>PT23365-MPG Maximum Performance Glass Hydraulic Element</p>  <p>Fits: Hydac Applications Replaces: Hydac 2055988, 240D003BHHC, 240D003BHHC2 O.D.: 2 23/32 (69.1) I.D.: 1 11/32 (34.1) One End Height: 6 13/16 (173.0) O-Ring: [1] Attached</p>

Measurements Are Shown In Inches And (Millimeters)

WARNING: These products can expose you to chemicals, including Diisononyl Phthalate, Carbon black extracts, Nickel, 1,3 Butadiene, Ethylene Oxide, Epichlorohydrin, which are known to the State of California to cause cancer, and Bisphenol, Ethylene Glycol, Ethylene Oxide, 1,3 Butadiene, Epichlorohydrin, which are known to the State of California to cause birth defects or other reproductive harm. For more information go to www.P65Warnings.ca.gov.

PT23366-MPG Maximum Performance Glass Hydraulic Element with Bail Handle



Contains: By-Pass Valve
Fits: Hydac Applications
Replaces: Hydac 2066035, 550R003BNHC, 500R003BNHC2
O.D.: 2 23/32 (69.1)
I.D.: 1 25/32 (45.2) & 1 29/32 (48.4)
Height: 10 9/32 (261.1)
O-Ring: [1] Attached

PT23372-MPG Maximum Performance Glass Hydraulic Element



Notes: OBSOLETE. Availability Limited to Dealer Stock.
Fits: Hydac Applications
Replaces: Hydac 2056437, 330D003BHHC, 330D003BHHC2
O.D.: 3 17/32 (89.7)
I.D.: 1 29/32 (48.4) One End
Height: 6 3/8 (161.9)
O-Ring: [1] Attached

PT23367-MPG Maximum Performance Glass Hydraulic Element



Notes: OBSOLETE. Availability Limited to Dealer Stock.
Fits: Hydac Applications
Replaces: Hydac 2056688, 30D003BH3HC
O.D.: 1 3/8 (34.9)
I.D.: 15/32 (11.9) One End
Height: 3 21/32 (92.9)
O-Ring: [1] Attached

PT23373-MPG Maximum Performance Glass Hydraulic Element



Notes: OBSOLETE. Availability Limited to Dealer Stock.
Fits: Hydac Applications
Replaces: Hydac 2055929, 140D005BNHC, 140D005BNHC2
O.D.: 1 27/32 (46.8)
I.D.: 7/8 (22.2) One End
Height: 7 19/32 (192.9)
O-Ring: [1] Attached

PT23369-MPG Maximum Performance Glass Hydraulic Element



Notes: OBSOLETE. Availability Limited to Dealer Stock.
Fits: Hydac Applications
Replaces: Hydac 2055973, 110D003BHHC, 110D003BHHC2
O.D.: 1 27/32 (46.8)
I.D.: 7/8 (22.2) One End
Height: 6 1/32 (153.2)
O-Ring: [1] Attached

PT23374-MPG Maximum Performance Glass Hydraulic Element



Fits: Hydac Applications
Replaces: Hydac 2055958, 60D003BHHC, 60D003BHHC2
O.D.: 1 27/32 (46.8)
I.D.: 7/8 (22.2) One End
Height: 3 5/16 (84.1)
O-Ring: [1] Attached

PT23370-MPG Maximum Performance Glass Hydraulic Element



Notes: OBSOLETE. Availability Limited to Dealer Stock.
Fits: Hydac Applications
Replaces: Hydac 2055737, 330D005BNHC, 330D005BNHC2
O.D.: 3 9/16 (90.5)
I.D.: 1 29/32 (48.4) One End
Height: 6 3/8 (161.9)
O-Ring: [1] Attached

PT23375-MPG Maximum Performance Glass Hydraulic Element with Bail Handle



Contains: By-Pass Valve
Fits: Hydac Applications
Replaces: Hydac 2059097, 110R020BNHC, 110R020BNHC2
O.D.: 2 1/32 (51.6)
I.D.: 7/8 (22.2) & 15/16 (23.8)
Height: 6 9/32 (159.5)
O-Ring: [1] Attached

PT23371-MPG Maximum Performance Glass Hydraulic Element



Fits: Hydac Applications
Replaces: Hydac 2055906, 110D003BNHC, 110D003BN3HC
O.D.: 1 27/32 (46.8)
I.D.: 7/8 (22.2) One End
Height: 6 1/32 (153.2)
O-Ring: [1] Attached











PT23376-MPG Maximum Performance Glass Hydraulic Element



Fits: Hydac Applications
Replaces: Hydac 2055984, 160D003BHHC, 160D003BHHC2
O.D.: 2 23/32 (69.1)
I.D.: 1 11/32 (34.1) One End
Height: 4 17/32 (115.1)
O-Ring: [1] Attached











Measurements Are Shown In Inches And (Millimeters)

WARNING: These products can expose you to chemicals, including Diisononyl Phthalate, Carbon black extracts, Nickel, 1,3 Butadiene, Ethylene Oxide, Epichlorohydrin, which are known to the State of California to cause cancer, and Bisphenol, Ethylene Glycol, Ethylene Oxide, 1,3 Butadiene, Epichlorohydrin, which are known to the State of California to cause birth defects or other reproductive harm. For more information go to www.P65Warnings.ca.gov.

<p>PT23377-MPG Maximum Performance Glass Hydraulic Element</p>  <p>Notes: OBSOLETE. Availability Limited to Dealer Stock. Fits: Hydac Applications Replaces: Hydac 12556542, 2056542, 30D005BN3HC O.D.: 1 3/8 (34.9) I.D.: 1/2 (12.7) One End Height: 3 21/32 (92.9) O-Ring: [1] Attached</p>	<p>PT23382-MPG Maximum Performance Glass Hydraulic Element</p>  <p>Notes: OBSOLETE. Availability Limited to Dealer Stock. Fits: Mahle Applications Replaces: Mahle PI3211SMVST10, PI3211SMXVST10 O.D.: 1 27/32 (46.8) I.D.: 1 (25.4) One End Height: 9 11/16 (246.1) O-Ring: [1] Attached</p>
<p>PT23378-MPG Maximum Performance Glass Hydraulic Element</p>  <p>Notes: OBSOLETE. Availability Limited to Dealer Stock. Fits: Hydac Applications Replaces: Hydac 2055928, 140D003BNHC, 140D003BNHC2 O.D.: 1 27/32 (46.8) I.D.: 7/8 (22.2) One End Height: 7 19/32 (192.9) O-Ring: [1] Attached</p>	<p>PT23383-MPG Maximum Performance Glass Hydraulic Element</p>  <p>Fits: Mahle Applications Replaces: Mahle PI5230SMVST6, PI5230SMXVST6 O.D.: 3 9/32 (83.3) I.D.: 1 27/32 (46.8) One End Height: 10 1/32 (254.8) O-Ring: [1] Attached</p>
<p>PT23379-MPG Maximum Performance Glass Hydraulic Element</p>  <p>Notes: OBSOLETE. Availability Limited to Dealer Stock. Fits: Hydac Applications Replaces: Hydac 2022902, 60D003BNHC, 60D003BNHC2 O.D.: 1 27/32 (46.8) I.D.: 7/8 (22.2) One End Height: 3 5/16 (84.1) O-Ring: [1] Attached</p>	<p>PT23384-MPG Maximum Performance Glass Hydraulic Element</p>  <p>Notes: OBSOLETE. Availability Limited to Dealer Stock. Fits: Mahle Applications Replaces: Mahle PI3205SMXVST10 O.D.: 1 7/8 (47.6) I.D.: 1 (25.4) One End Height: 3 3/4 (95.3) O-Ring: [1] Attached</p>
<p>PT23380-MPG Maximum Performance Glass Hydraulic Element</p>  <p>Fits: Pall Applications Replaces: Pall HC8900FDT8H, HC8900FKT8H, HC8900FUT8H O.D.: 3 25/32 (96.0) I.D.: 2 7/32 (56.4) One End Height: 8 3/32 (205.6) O-Ring: [1] Attached</p>	<p>PT23385-MPG Maximum Performance Glass Hydraulic Element</p>  <p>Notes: OBSOLETE. Availability Limited to Dealer Stock. Fits: Mahle Applications Replaces: Mahle PI2230SMVST3, PI2230SMXVST3 O.D.: 3 1/4 (82.6) I.D.: 1 27/32 (46.8) One End Height: 10 1/32 (254.8) O-Ring: [1] Attached</p>
<p>PT23381-MPG Maximum Performance Glass Hydraulic Element</p>  <p>Notes: OBSOLETE. Availability Limited to Dealer Stock. Fits: Mahle Applications Replaces: Mahle PI3245SMVST10, PI3245SMXVST10 O.D.: 3 9/32 (83.3) I.D.: 1 27/32 (46.8) One End Height: 14 11/16 (373.1) O-Ring: [1] Attached</p>	<p>PT23386-MPG Maximum Performance Glass Hydraulic Element</p>  <p>Fits: Mahle Applications Replaces: Mahle PI3230SMXVST10 O.D.: 3 5/16 (84.1) I.D.: 1 7/8 (47.6) Height: 10 (254.0)</p>













Measurements Are Shown In Inches And (Millimeters)

WARNING: These products can expose you to chemicals, including Diisononyl Phthalate, Carbon black extracts, Nickel, 1,3 Butadiene, Ethylene Oxide, Epichlorohydrin, which are known to the State of California to cause cancer, and Bisphenol, Ethylene Glycol, Ethylene Oxide, 1,3 Butadiene, Epichlorohydrin, which are known to the State of California to cause birth defects or other reproductive harm. For more information go to www.P65Warnings.ca.gov.

<p>PT23387-MPG</p> 	<p>Maximum Performance Glass Hydraulic Element</p> <p>Notes: OBSOLETE. Availability Limited to Dealer Stock.</p> <p>Fits: Mahle Applications</p> <p>Replaces: Mahle PI4205SMXVST25</p> <p>O.D.: 1 27/32 (46.8)</p> <p>I.D.: 1 (25.4) One End</p> <p>Height: 3 11/16 (93.7)</p> <p>O-Ring: [1] Attached</p>	<p>PT23393-MPG</p> 	<p>Maximum Performance Glass Hydraulic Element</p> <p>Notes: OBSOLETE. Availability Limited to Dealer Stock.</p> <p>Fits: Pall Applications</p> <p>Replaces: Pall HC8200FKT13Z</p> <p>O.D.: 3 (76.2)</p> <p>I.D.: 1 1/2 (38.1) One End</p> <p>Height: 13 (330.2)</p> <p>O-Ring: [2] Attached</p>
<p>PT23388-MPG</p> 	<p>Maximum Performance Glass Hydraulic Element</p> <p>Notes: OBSOLETE. Availability Limited to Dealer Stock.</p> <p>Fits: Mahle Applications</p> <p>Replaces: Mahle 852444SM10, 852444SMX10</p> <p>O.D.: 2 9/32 (57.9)</p> <p>I.D.: 1 9/32 (32.5) One End</p> <p>Height: 7 3/32 (180.2)</p> <p>O-Ring: [1] Attached</p>	<p>PT23394-MPG</p> 	<p>Maximum Performance Glass Hydraulic Element</p> <p>Fits: Pall Applications</p> <p>Replaces: Pall HC6500FKS16H</p> <p>O.D.: 3 25/32 (96.0)</p> <p>I.D.: 2 7/32 (56.4) One End</p> <p>Height: 16 13/16 (427.0)</p> <p>O-Ring: [1] Attached</p>
<p>PT23389-MPG</p> 	<p>Maximum Performance Glass Hydraulic Element</p> <p>Fits: Pall Applications</p> <p>Replaces: Pall HC9801FDP8H, HC9801FUP8H, HC9801FKP8H</p> <p>O.D.: 2 (50.8)</p> <p>I.D.: 15/16 (23.8) One End</p> <p>Height: 8 3/16 (208.0)</p> <p>O-Ring: [1] Attached</p>	<p>PT23395-MPG</p> 	<p>Maximum Performance Glass Hydraulic Element</p> <p>Fits: Pall Applications</p> <p>Replaces: Pall HC9600FKS8Z</p> <p>O.D.: 3 1/16 (77.8)</p> <p>I.D.: 1 23/32 (43.7) One End</p> <p>Height: 8 1/4 (209.6)</p> <p>O-Ring: [1] Attached</p>
<p>PT23390-MPG</p> 	<p>Maximum Performance Glass Hydraulic Element</p> <p>Notes: OBSOLETE. Availability Limited to Dealer Stock.</p> <p>Fits: Fairey-Arlon Applications</p> <p>Replaces: Fairey-Arlon TXW8AC CZ</p> <p>O.D.: 4 31/32 (126.2)</p> <p>I.D.: 13/32 (10.3) & 3 5/8 (92.1)</p> <p>Height: 11 7/16 (290.5)</p> <p>O-Ring: [1] Attached</p>	<p>PT23396-MPG</p> 	<p>Maximum Performance Glass Hydraulic Element</p> <p>Fits: Pall Applications</p> <p>Replaces: Pall HC9601FUP8H</p> <p>O.D.: 3 1/16 (77.8)</p> <p>I.D.: 1 11/16 (42.9) One End</p> <p>Height: 8 1/4 (209.6)</p> <p>O-Ring: [1] Attached</p>
<p>PT23391-MPG</p> 	<p>Maximum Performance Glass Hydraulic Element</p> <p>Notes: OBSOLETE. Availability Limited to Dealer Stock.</p> <p>Fits: Fairey-Arlon Applications</p> <p>Replaces: Fairey-Arlon TXW3DCC3</p> <p>O.D.: 2 7/8 (73.0)</p> <p>I.D.: 5/8 (15.9) & 1 7/8 (47.6)</p> <p>Height: 7 15/16 (201.6)</p> <p>O-Ring: [1] Attached</p>	<p>PT23397-MPG</p> 	<p>Maximum Performance Glass Hydraulic Element</p> <p>Notes: OBSOLETE. Availability Limited to Dealer Stock.</p> <p>Fits: Pall Applications</p> <p>Replaces: Pall HC9601FDT8Z</p> <p>O.D.: 3 (76.2)</p> <p>I.D.: 1 13/16 (46.0) One End</p> <p>Height: 8 5/16 (211.1)</p> <p>O-Ring: [1] Attached</p>
<p>PT23392-MPG</p> 	<p>Maximum Performance Glass Hydraulic Element</p> <p>Notes: OBSOLETE. Availability Limited to Dealer Stock.</p> <p>Fits: Fairey-Arlon Applications</p> <p>Replaces: Fairey-Arlon TXW5ACC3</p> <p>O.D.: 4 3/16 (106.4)</p> <p>I.D.: 13/32 (10.3) & 2 13/16 (71.4)</p> <p>Height: 18 5/16 (465.1)</p> <p>O-Ring: [1] Attached</p>		













Measurements Are Shown In Inches And (Millimeters)

WARNING: These products can expose you to chemicals, including Diisononyl Phthalate, Carbon black extracts, Nickel, 1,3 Butadiene, Ethylene Oxide, Epichlorohydrin, which are known to the State of California to cause cancer, and Bisphenol, Ethylene Glycol, Ethylene Oxide, 1,3 Butadiene, Epichlorohydrin, which are known to the State of California to cause birth defects or other reproductive harm. For more information go to www.P65Warnings.ca.gov.

<p>PT23398-MPG Maximum Performance Glass Hydraulic Element</p>  <p>Fits: Pall Applications Replaces: Pall HC9601FKP8Z O.D.: 3 1/16 (77.8) I.D.: 1 11/16 (42.9) One End Height: 8 1/4 (209.6) O-Ring: [1] Attached</p>	<p>PT23404-MPG Maximum Performance Glass Hydraulic Element</p>  <p>Notes: OBSOLETE. Availability Limited to Dealer Stock. Fits: Pall Applications Replaces: Pall HC8300FKS8H O.D.: 6 (152.4) I.D.: 4 5/32 (105.6) Height: 8 5/32 (207.2) O-Ring: [2] Attached</p>
<p>PT23399-MPG Maximum Performance Glass Hydraulic Element with Bail Handle</p>  <p>Notes: OBSOLETE. Availability Limited to Dealer Stock. Fits: Pall Applications Replaces: Pall HC8904FKT16Z O.D.: 3 27/32 (97.6) I.D.: 2 17/32 (64.3) One End Height: 6 11/32 (161.1) O-Ring: [1] Attached</p>	<p>PT23405-MPG Maximum Performance Glass Hydraulic Element</p>  <p>Notes: OBSOLETE. Availability Limited to Dealer Stock. Fits: Pall Applications Replaces: Pall HC8300FKS8Z O.D.: 6 (152.4) I.D.: 4 1/2 (114.3) Height: 8 1/4 (209.6) O-Ring: [2] Attached</p>
<p>PT23400-MPG Maximum Performance Glass Hydraulic Element</p>  <p>Notes: OBSOLETE. Availability Limited to Dealer Stock. Fits: Pall Applications Replaces: Pall HC9801FUP4H O.D.: 2 1/32 (51.6) I.D.: 15/16 (23.8) One End Height: 4 1/2 (114.3) O-Ring: [1] Attached</p>	<p>PT23406-MPG Maximum Performance Glass Hydraulic Element</p>  <p>Notes: OBSOLETE. Availability Limited to Dealer Stock. Fits: Pall Applications Replaces: Pall HC8904FKS13H O.D.: 3 13/16 (96.8) I.D.: 2 1/2 (63.5) One End Height: 14 7/8 (377.8) O-Ring: [1] Attached</p>
<p>PT23401-MPG Maximum Performance Glass Hydraulic Element</p>  <p>Notes: OBSOLETE. Availability Limited to Dealer Stock. Fits: Pall Applications Replaces: Pall HC8900FKN13Z O.D.: 3 25/32 (96.0) I.D.: 2 7/32 (56.4) One End Height: 12 29/32 (327.8) O-Ring: [1] Attached</p>	<p>PT23407-MPG Maximum Performance Glass Hydraulic Element</p>  <p>Fits: Pall Applications Replaces: Pall HC9604FKT8H, HC9604FKT8Z O.D.: 3 1/8 (79.4) I.D.: 1 15/16 (49.2) Height: 8 (203.2) O-Ring: [1] Attached</p>
<p>PT23402-MPG Maximum Performance Glass Hydraulic Element</p>  <p>Notes: OBSOLETE. Availability Limited to Dealer Stock. Fits: Pall Applications Replaces: Pall HC8800FKP16Z O.D.: 3 13/32 (86.5) I.D.: 1 31/32 (50.0) One End Height: 16 13/16 (427.0) O-Ring: [1] Attached</p>	<p>PT23408-MPG Maximum Performance Glass Hydraulic Element</p>  <p>Notes: OBSOLETE. Availability Limited to Dealer Stock. Fits: Pall Applications Replaces: Pall HC9601FKP4Z O.D.: 3 1/16 (77.8) I.D.: 1 11/16 (42.9) One End Height: 4 21/32 (118.3) O-Ring: [1] Attached</p>
<p>PT23403-MPG Maximum Performance Glass Hydraulic Element</p>  <p>Notes: OBSOLETE. Availability Limited to Dealer Stock. Fits: Pall Applications Replaces: Pall HC8300FKT8H O.D.: 6 (152.4) I.D.: 4 5/32 (105.6) Height: 8 5/32 (207.2) O-Ring: [2] Attached</p>	<p>PT23409-MPG Maximum Performance Glass Hydraulic Element</p>  <p>Notes: OBSOLETE. Availability Limited to Dealer Stock. Fits: Pall Applications Replaces: Pall HC8900FKT16Z O.D.: 3 25/32 (96.0) I.D.: 2 7/32 (56.4) One End Height: 16 29/32 (429.4) O-Ring: [1] Attached</p>













Measurements Are Shown In Inches And (Millimeters)

WARNING: These products can expose you to chemicals, including Diisononyl Phthalate, Carbon black extracts, Nickel, 1,3 Butadiene, Ethylene Oxide, Epichlorohydrin, which are known to the State of California to cause cancer, and Bisphenol, Ethylene Glycol, Ethylene Oxide, 1,3 Butadiene, Epichlorohydrin, which are known to the State of California to cause birth defects or other reproductive harm. For more information go to www.P65Warnings.ca.gov.

<p>PT23410-MPG Maximum Performance Glass Hydraulic Element</p>  <p>Notes: OBSOLETE. Availability Limited to Dealer Stock. Fits: Pall Applications Replaces: Pall HC9800FKS13H O.D.: 1 31/32 (50.0) I.D.: 31/32 (24.6) One End Height: 12 31/32 (329.4) O-Ring: [1] Attached</p>	<p>PT23416-MPG Maximum Performance Glass Hydraulic Element</p>  <p>Fits: Pall Applications Replaces: Pall HC8200FKN13Z O.D.: 3 (76.2) I.D.: 1 1/2 (38.1) One End Height: 13 (330.2) O-Ring: [1] Attached</p>
<p>PT23411-MPG Maximum Performance Glass Hydraulic Element with Bail Handle</p>  <p>Notes: OBSOLETE. Availability Limited to Dealer Stock. Fits: Pall Applications Replaces: Pall HC8314FKP39Z O.D.: 6 (152.4) I.D.: 3 25/32 (96.0) & 3 15/16 (100.0) Height: 36 1/2 (927.1) O-Ring: [2] Attached</p>	<p>PT23417-MPG Maximum Performance Glass Hydraulic Element</p>  <p>Notes: OBSOLETE. Availability Limited to Dealer Stock. Fits: Pall Applications Replaces: Pall HC9604FKN16Z O.D.: 3 3/32 (78.6) I.D.: 2 1/32 (51.6) One End Height: 16 9/16 (420.7) O-Ring: [1] Attached</p>
<p>PT23412-MPG Maximum Performance Glass Hydraulic Element</p>  <p>Notes: OBSOLETE. Availability Limited to Dealer Stock. Fits: Pall Applications Replaces: Pall HC8900FKT8Z O.D.: 3 25/32 (96.0) I.D.: 2 7/32 (56.4) One End Height: 8 3/32 (205.6) O-Ring: [1] Attached</p>	<p>PT23418-MPG Maximum Performance Glass Hydraulic Element</p>  <p>Notes: OBSOLETE. Availability Limited to Dealer Stock. Fits: Pall Applications Replaces: Pall HC9801FKP4H O.D.: 2 (50.8) I.D.: 15/16 (23.8) Height: 4 1/2 (114.3) O-Ring: [1] Attached</p>
<p>PT23413-MPG Maximum Performance Glass Hydraulic Element</p>  <p>Notes: OBSOLETE. Availability Limited to Dealer Stock. Fits: Pall Applications Replaces: Pall HC9901FKT26H O.D.: 3 3/4 (95.3) I.D.: 2 5/16 (58.7) Height: 25 7/8 (657.2) O-Ring: [1] Attached</p>	<p>PT23419-MPG Maximum Performance Glass Hydraulic Element</p>  <p>Notes: OBSOLETE. Availability Limited to Dealer Stock. Fits: Pall Applications Replaces: Pall HC9100FKN8Z O.D.: 2 3/4 (69.9) I.D.: 1 5/16 (33.3) One End Height: 8 1/4 (209.6) O-Ring: [1] Attached</p>
<p>PT23414-MPG Maximum Performance Glass Hydraulic Element</p>  <p>Fits: Pall Applications Replaces: Pall HC9606FKS8H O.D.: 3 1/16 (77.8) I.D.: 1 23/32 (43.7) One End Height: 8 1/4 (209.6) O-Ring: [1] Attached</p>	<p>PT23420-MPG Maximum Performance Glass Hydraulic Element</p>  <p>Notes: OBSOLETE. Availability Limited to Dealer Stock. Fits: Pall Applications Replaces: Pall HC9400FKP26H O.D.: 3 25/32 (96.0) I.D.: 2 7/32 (56.4) Height: 25 27/32 (656.4) O-Ring: [2] Attached</p>
<p>PT23415-MPG Maximum Performance Glass Hydraulic Element</p>  <p>Notes: OBSOLETE. Availability Limited to Dealer Stock. Fits: Pall Applications Replaces: Pall HC6400FKT16H O.D.: 3 13/32 (86.5) I.D.: 1 31/32 (50.0) One End Height: 16 13/16 (427.0) O-Ring: [1] Attached</p>	<p>PT23421-MPG Maximum Performance Glass Hydraulic Element</p>  <p>Notes: OBSOLETE. Availability Limited to Dealer Stock. Fits: Pall Applications Replaces: Pall HC9400FKS39Z O.D.: 3 25/32 (96.0) I.D.: 2 7/32 (56.4) Height: 38 13/16 (985.8) O-Ring: [2] Attached</p>











Measurements Are Shown In Inches And (Millimeters)

WARNING: These products can expose you to chemicals, including Diisononyl Phthalate, Carbon black extracts, Nickel, 1,3 Butadiene, Ethylene Oxide, Epichlorohydrin, which are known to the State of California to cause cancer, and Bisphenol, Ethylene Glycol, Ethylene Oxide, 1,3 Butadiene, Epichlorohydrin, which are known to the State of California to cause birth defects or other reproductive harm. For more information go to www.P65Warnings.ca.gov.

<p>PT23422-MPG Maximum Performance Glass Hydraulic Element</p>  <p>Notes: OBSOLETE. Availability Limited to Dealer Stock. Fits: Pall Applications Replaces: Pall HC9901FKP26H O.D.: 3 13/16 (96.8) I.D.: 2 3/16 (55.6) Height: 25 13/16 (655.6) O-Ring: [2] Attached</p>	<p>PT23428-MPG Maximum Performance Glass Hydraulic Element with Bail Handle</p>  <p>Notes: OBSOLETE. Availability Limited to Dealer Stock. Fits: Pall Applications Replaces: Pall HC8304FKS39Z O.D.: 5 13/32 (137.3) I.D.: 3 25/32 (96.0) & 3 15/16 (100.0) Height: 36 1/2 (927.1) O-Ring: [2] Attached</p>
<p>PT23423-MPG Maximum Performance Glass Hydraulic Element</p>  <p>Notes: OBSOLETE. Availability Limited to Dealer Stock. Fits: Pall Applications Replaces: Pall HC9601FUP16H O.D.: 3 1/16 (77.8) I.D.: 1 13/16 (46.0) One End Height: 17 (431.8) O-Ring: [1] Attached</p>	<p>PT23429-MPG Maximum Performance Glass Hydraulic Element</p>  <p>Notes: OBSOLETE. Availability Limited to Dealer Stock. Fits: Pall Applications Replaces: Pall HC9601FKP13H O.D.: 3 1/16 (77.8) I.D.: 1 11/16 (42.9) One End Height: 13 (330.2) O-Ring: [1] Attached</p>
<p>PT23424-MPG Maximum Performance Glass Hydraulic Element with Bail Handle</p>  <p>Notes: OBSOLETE. Availability Limited to Dealer Stock. Fits: Pall Applications Replaces: Pall HC8304FKP9Z O.D.: 5 13/32 (137.3) I.D.: 3 25/32 (96.0) & 3 15/16 (100.0) Height: 36 1/2 (927.1) O-Ring: [2] Attached</p>	<p>PT23430-MPG Maximum Performance Glass Hydraulic Element</p>  <p>Notes: OBSOLETE. Availability Limited to Dealer Stock. Fits: Pall Applications Replaces: Pall HC2217FDT6H O.D.: 2 23/32 (69.1) I.D.: 1 11/32 (34.1) One End Height: 6 13/16 (173.0) O-Ring: [1] Attached</p>
<p>PT23425-MPG Maximum Performance Glass Hydraulic Element with Bail Handle</p>  <p>Notes: OBSOLETE. Availability Limited to Dealer Stock. Fits: Pall Applications Replaces: Pall HC8304FKN39Z O.D.: 5 13/32 (137.3) I.D.: 3 25/32 (96.0) & 3 15/16 (100.0) Height: 36 1/2 (927.1) O-Ring: [2] Attached</p>	<p>PT23431-MPG Maximum Performance Glass Hydraulic Element with Bail Handle</p>  <p>Notes: OBSOLETE. Availability Limited to Dealer Stock. Fits: Pall Applications Replaces: Pall HC8314FKN39H O.D.: 6 (152.4) I.D.: 3 25/32 (96.0) & 3 15/16 (100.0) Height: 36 1/2 (927.1) O-Ring: [2] Attached</p>
<p>PT23426-MPG Maximum Performance Glass Hydraulic Element with Bail Handle</p>  <p>Notes: OBSOLETE. Availability Limited to Dealer Stock. Fits: Pall Applications Replaces: Pall HC2792628314FKN39Z O.D.: 6 (152.4) I.D.: 3 25/32 (96.0) & 3 15/16 (100.0) Height: 36 1/2 (927.1) O-Ring: [2] Attached</p>	<p>PT23432-MPG Maximum Performance Glass Hydraulic Element</p>  <p>Notes: OBSOLETE. Availability Limited to Dealer Stock. Fits: Pall Applications Replaces: Pall HC9801FUT13Z O.D.: 2 1/32 (51.6) I.D.: 29/32 (23.0) One End Height: 13 (330.2) O-Ring: [1] Attached</p>
<p>PT23427-MPG Maximum Performance Glass Hydraulic Element with Bail Handle</p>  <p>Notes: OBSOLETE. Availability Limited to Dealer Stock. Fits: Pall Applications Replaces: Pall HC8304FKN16Z O.D.: 5 13/32 (137.3) I.D.: 3 25/32 (96.0) & 3 15/16 (100.0) Height: 14 21/32 (372.3) O-Ring: [2] Attached</p>	<p>PT23433-MPG Maximum Performance Glass Hydraulic Element</p>  <p>Notes: OBSOLETE. Availability Limited to Dealer Stock. Fits: Pall Applications Replaces: Pall HC8900FDN8H O.D.: 3 25/32 (96.0) I.D.: 2 7/32 (56.4) One End Height: 8 3/32 (205.6) O-Ring: [1] Attached</p>











Measurements Are Shown In Inches And (Millimeters)

WARNING: These products can expose you to chemicals, including Diisononyl Phthalate, Carbon black extracts, Nickel, 1,3 Butadiene, Ethylene Oxide, Epichlorohydrin, which are known to the State of California to cause cancer, and Bisphenol, Ethylene Glycol, Ethylene Oxide, 1,3 Butadiene, Epichlorohydrin, which are known to the State of California to cause birth defects or other reproductive harm. For more information go to www.P65Warnings.ca.gov.

<p>PT23434-MPG Maximum Performance Glass Hydraulic Element</p>  <p>Notes: OBSOLETE. Availability Limited to Dealer Stock. Fits: Pall Applications Replaces: Pall HC9400FKN39H O.D.: 3 25/32 (96.0) I.D.: 2 7/32 (56.4) Height: 38 13/16 (985.8) O-Ring: [2] Attached</p>	<p>PT23440-MPG Maximum Performance Glass Hydraulic Element</p>  <p>Notes: OBSOLETE. Availability Limited to Dealer Stock. Fits: Pall Applications Replaces: Pall HC8800FKN13H O.D.: 3 13/32 (86.5) I.D.: 1 31/32 (50.0) One End Height: 12 29/32 (327.8) O-Ring: [1] Attached</p>
<p>PT23435-MPG Maximum Performance Glass Hydraulic Element</p>  <p>Notes: OBSOLETE. Availability Limited to Dealer Stock. Fits: Pall Applications Replaces: Pall HC6500FKS26H O.D.: 3 13/16 (96.8) I.D.: 2 3/8 (60.3) One End Height: 25 11/16 (652.5) O-Ring: [1] Attached</p>	<p>PT23441-MPG Maximum Performance Glass Hydraulic Element</p>  <p>Fits: Pall Applications Replaces: Pall HC9604FKT13H O.D.: 3 3/16 (81.0) I.D.: 2 (50.8) One End Height: 12 11/16 (322.3) O-Ring: [1] Attached</p>
<p>PT23436-MPG Maximum Performance Glass Hydraulic Element</p>  <p>Notes: OBSOLETE. Availability Limited to Dealer Stock. Fits: Pall Applications Replaces: Pall HC9601FUP4Z O.D.: 3 1/16 (77.8) I.D.: 1 11/16 (42.9) One End Height: 4 21/32 (118.3) O-Ring: [1] Attached</p>	<p>PT23442-MPG Maximum Performance Glass Hydraulic Element</p>  <p>Fits: Pall Applications Replaces: Pall HC8700FKN8H O.D.: 1 31/32 (50.0) I.D.: 31/32 (24.6) Height: 8 13/32 (213.5) O-Ring: [2] Attached</p>
<p>PT23437-MPG Maximum Performance Glass Hydraulic Element</p>  <p>Notes: OBSOLETE. Availability Limited to Dealer Stock. Fits: Pall Applications Replaces: Pall HC9801FKP8H O.D.: 2 (50.8) I.D.: 15/16 (23.8) One End Height: 8 1/4 (209.6) O-Ring: [1] Attached</p>	<p>PT23443-MPG Maximum Performance Glass Hydraulic Element</p>  <p>Notes: OBSOLETE. Availability Limited to Dealer Stock. Fits: Pall Applications Replaces: Pall HC8700FKS8H O.D.: 1 31/32 (50.0) I.D.: 31/32 (24.6) Height: 8 13/32 (213.5) O-Ring: [2] Attached</p>
<p>PT23438-MPG Maximum Performance Glass Hydraulic Element</p>  <p>Notes: OBSOLETE. Availability Limited to Dealer Stock. Fits: Pall Applications Replaces: Pall HC9606FKS13Z O.D.: 3 1/16 (77.8) I.D.: 1 23/32 (43.7) One End Height: 12 31/32 (329.4) O-Ring: [1] Attached</p>	<p>PT23444-MPG Maximum Performance Glass Hydraulic Element</p>  <p>Fits: Parker Applications Replaces: Parker 932629Q O.D.: 2 11/32 (59.5) I.D.: 1 13/32 (35.7) One End Height: 9 19/32 (243.7) O-Ring: [1] Attached</p>
<p>PT23439-MPG Maximum Performance Glass Hydraulic Element with Bail Handle</p>  <p>Notes: OBSOLETE. Availability Limited to Dealer Stock. Fits: Pall Applications Replaces: Pall HC8314FKT39H O.D.: 6 (152.4) I.D.: 3 25/32 (96.0) & 3 15/16 (100.0) Height: 36 1/2 (927.1) O-Ring: [2] Attached</p>	









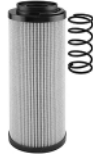

Measurements Are Shown In Inches And (Millimeters)

WARNING: These products can expose you to chemicals, including Diisononyl Phthalate, Carbon black extracts, Nickel, 1,3 Butadiene, Ethylene Oxide, Epichlorohydrin, which are known to the State of California to cause cancer, and Bisphenol, Ethylene Glycol, Ethylene Oxide, 1,3 Butadiene, Epichlorohydrin, which are known to the State of California to cause birth defects or other reproductive harm. For more information go to www.P65Warnings.ca.gov.

<p>PT23445-MPG Maximum Performance Glass Hydraulic Element</p>  <p>Fits: Parker Applications Replaces: Parker G02082 O.D.: 3 17/32 (89.7) I.D.: 2 1/32 (51.6) & 2 1/2 (63.5) Height: 8 3/32 (205.6) O-Ring: [2] Attached</p>	<p>PT23450-MPG Maximum Performance Glass Hydraulic Element with Bail Handle</p>  <p>Fits: Sennebogen Applications Replaces: Sennebogen 27417 O.D.: 3 23/32 (94.5) I.D.: 1 25/32 (45.2) & 1 29/32 (48.4) Height: 24 3/32 (612.0) O-Ring: [1] Attached, [1] Included</p>
<p>PT23446-MPG Maximum Performance Glass Hydraulic Element</p>  <p>Notes: OBSOLETE. Availability Limited to Dealer Stock. Fits: Parker Applications Replaces: Parker 924794 O.D.: 3 11/16 (93.7) I.D.: 1 15/16 (49.2) Height: 18 7/16 (468.3) Grommets: [2] Attached</p>	<p>PT23451 Hydraulic Element</p>  <p>Fits: Donaldson Applications Replaces: Cim-Tek R320C20P; Donaldson P550216 O.D.: 6 1/16 (154.0) I.D.: 2 5/8 (66.7) Height: 17 13/16 (452.4) A. Gskt: [2] Attached</p>
<p>PT23447-MPG Maximum Performance Glass Hydraulic Element</p>  <p>Fits: Parker Applications Replaces: Parker G02058 O.D.: 1 3/4 (44.4) I.D.: 1 (25.4) Height: 4 11/16 (119.1) O-Ring: [2] Attached</p>	<p>PT23453 Hydraulic Element</p>  <p>Notes: OBSOLETE. Availability Limited to Dealer Stock. Fits: Fairey-Arlon Applications Replaces: Fairey-Arlon TXX1010; Liebherr 7000250; Fleetguard HF6272 O.D.: 7 31/32 (202.4) I.D.: 9/16 (14.3) & 6 3/16 (157.2) Height: 13 (330.2) A. Gskt: [1] Attached</p>
<p>PT23448-MPG Maximum Performance Glass Hydraulic Element</p>  <p>Notes: OBSOLETE. Availability Limited to Dealer Stock. Fits: Parker Applications Replaces: Parker G02064 O.D.: 1 13/16 (46.0) I.D.: 15/16 (23.8) Height: 8 7/16 (214.3) O-Ring: [2] Attached</p>	<p>PT23454 Hydraulic Element</p>  <p>Fits: Finn Filter Applications Replaces: Finn Filter FFP1053015 O.D.: 7 3/32 (180.2) I.D.: 4 5/32 (105.6) Height: 7 7/8 (200.0) O-Ring: [2] Attached</p>
<p>PT23449-MPG Maximum Performance Glass Hydraulic Element</p>  <p>Fits: Schroeder Applications Replaces: Schroeder KKKS3 O.D.: 3 15/16 (100.0) I.D.: 1 11/16 (42.9) Height: 28 (711.2) O-Ring: [2] Attached</p>	<p>PT23455 Hydraulic Element</p>  <p>Fits: Finn Filter Applications Replaces: Finn Filter FFP1053015 O.D.: 5 29/32 (150.0) I.D.: 3 1/2 (88.9) Height: 6 7/16 (163.5) O-Ring: [2] Attached</p>

Measurements Are Shown In Inches And (Millimeters)

WARNING: These products can expose you to chemicals, including Diisononyl Phthalate, Carbon black extracts, Nickel, 1,3 Butadiene, Ethylene Oxide, Epichlorohydrin, which are known to the State of California to cause cancer, and Bisphenol, Ethylene Glycol, Ethylene Oxide, 1,3 Butadiene, Epichlorohydrin, which are known to the State of California to cause birth defects or other reproductive harm. For more information go to www.P65Warnings.ca.gov.

<p>PT23456</p>  <p>Hydraulic Element Fits: MP Filtri Applications Replaces: MP Filtri CU250P10N; Donaldson C2501, P171667 O.D.: 3 29/32 (99.2) I.D.: 2 1/32 (51.6) Height: 8 1/4 (209.6) A. Gskt: [2] Attached</p>	<p>PT23462</p>  <p>Hydraulic Element with Bail Handle Notes: OBSOLETE. Availability Limited to Dealer Stock. Contains: By-Pass Valve Fits: Sofima Applications Replaces: Sofima CRE055CV1; Donaldson CR2014, P171546 O.D.: 3 29/32 (99.2) I.D.: 1 19/32 (40.5) One End Height: 10 1/4 (260.3) O-Ring: [1] Attached Spring: [1] Included</p>
<p>PT23457</p>  <p>Hydraulic Element Notes: OBSOLETE. Availability Limited to Dealer Stock. Fits: MP Filtri Applications Replaces: MP Filtri CU630P10N; Donaldson C6301, P171674 O.D.: 5 1/8 (130.2) I.D.: 3 (76.2) Height: 9 27/32 (250.0) A. Gskt: [2] Attached</p>	<p>PT23463</p>  <p>Hydraulic Element Fits: Sofima Applications Replaces: Sofima CCH152CD1, CH152CD11; Donaldson CM2501, P171722 O.D.: 1 25/32 (45.2) I.D.: 1 (25.4) One End Height: 4 15/32 (113.5) O-Ring: [1] Attached</p>
<p>PT23458</p>  <p>Hydraulic Element Fits: MP Filtri Applications Replaces: MP Filtri CU630P25N; Donaldson C6303, P171675 O.D.: 5 1/8 (130.2) I.D.: 3 (76.2) Height: 9 27/32 (250.0) A. Gskt: [2] Attached</p>	<p>PT23464</p>  <p>Hydraulic Element Contains: [6] Bolts Fits: U.C.C. Hydraulic Applications Replaces: U.C.C. Hydraulic UCAB116310; Donaldson P171855, TCO501 O.D.: 1 1/2 (38.1) Cap 2 31/32 (75.4) Height: 5 29/32 (150.0) F. Gskt: [1] Included</p>
<p>PT23459</p>  <p>Hydraulic Element Notes: OBSOLETE. Availability Limited to Dealer Stock. Fits: MP Filtri Applications Replaces: Caterpillar 3I2087; MP Filtri MR1004P10A; Donaldson CRS1601 O.D.: 2 13/16 (71.4) I.D.: 5/8 (15.9) & 1 3/4 (44.4) Height: 11 13/16 (300.0) A. Gskt: [1] Attached</p>	<p>PT23465</p>  <p>Hydraulic Element with Bail Handle Notes: OBSOLETE. Availability Limited to Dealer Stock. Contains: By-Pass Valve Fits: Venieri Applications Replaces: Venieri 102028; Donaldson P173048, P180014 O.D.: 2 3/4 (69.9) I.D.: 1 5/32 (29.4) One End Height: 6 13/16 (173.0) O-Ring: [1] Attached Spring: [1] Included</p>
<p>PT23460</p>  <p>Hydraulic Element Notes: OBSOLETE. Availability Limited to Dealer Stock. Fits: MP Filtri Applications Replaces: MP Filtri MF0202P25NB; Donaldson P171839 O.D.: 1 21/32 (42.1) I.D.: 29/32 (23.0) & 1 1/32 (26.2) Height: 6 11/16 (169.9) O-Ring: [1] Attached</p>	<p>PT23467</p>  <p>Hydraulic Element with Bail Handle Contains: By-Pass Valve Fits: Donaldson Applications Replaces: Donaldson CR8006, P171583 O.D.: 5 1/8 (130.2) I.D.: 2 17/32 (64.3) One End Height: 15 29/32 (404.0) O-Ring: [1] Attached Spring: [1] Included</p>
<p>PT23461</p>  <p>Hydraulic Element Fits: Parker Applications Replaces: Parker 937726 O.D.: 4 3/16 (106.4) I.D.: 13/32 (10.3) & 2 27/32 (72.2) Height: 10 1/4 (260.3) A. Gskt: [1] Attached</p>	

Measurements Are Shown In Inches And (Millimeters)

WARNING: These products can expose you to chemicals, including Diisononyl Phthalate, Carbon black extracts, Nickel, 1,3 Butadiene, Ethylene Oxide, Epichlorohydrin, which are known to the State of California to cause cancer, and Bisphenol, Ethylene Glycol, Ethylene Oxide, 1,3 Butadiene, Epichlorohydrin, which are known to the State of California to cause birth defects or other reproductive harm. For more information go to www.P65Warnings.ca.gov.

PT23468



Hydraulic Element with Bail Handle

Contains: By-Pass Valve
Fits: Donaldson Applications
Replaces: Donaldson CR1256, P171589
O.D.: 3 29/32 (99.2)
I.D.: 1 19/32 (40.5) One End
Height: 6 29/32 (175.4)
O-Ring: [1] Attached
Spring: [1] Included

PT23473



Hydraulic Element

Fits: MP Filtri Applications
Replaces: MP Filtri SF503M90
O.D.: 4 23/32 (119.9)
I.D.: 3 1/32 (77.0)
Height: 7 25/32 (197.6)

PT23469



Hydraulic Element with Bail Handle

Notes: OBSOLETE. Availability Limited to Dealer Stock.
Contains: By-Pass Valve
Fits: Mahle Applications
Replaces: Mahle 852378DRG60; Donaldson CR2206, P171595
O.D.: 5 1/8 (130.2)
I.D.: 2 17/32 (64.3) One End
Height: 5 23/32 (145.3)
O-Ring: [1] Attached
Spring: [1] Included

PT23474



Hydraulic Element

Notes: OBSOLETE. Availability Limited to Dealer Stock.
Contains: Threaded End: 1-11 BSP
Fits: MP Filtri Applications
Replaces: MP Filtri STR0704SG1M90, MPA050G1M90; Donaldson FIOA90, P171877
O.D.: 2 7/8 (73.0)
Height: 5 27/32 (148.4)

PT23470



Hydraulic Element

Fits: MP Filtri Applications
Replaces: MP Filtri CU100M90N; Donaldson C100, P171657
O.D.: 2 3/4 (69.9)
I.D.: 1 3/8 (34.9)
Height: 5 1/8 (130.2)
O-Ring: [2] Attached

PT23475



Hydraulic Element

Contains: Threaded Stud: 2-11 BSP
Fits: MP Filtri Applications
Replaces: MP Filtri STR1004SG1M90; Donaldson FIOA220, P760151
O.D.: 4 1/32 (102.4)
Height: 8 31/32 (227.8)

PT23471



Hydraulic Element

Fits: MP Filtri Applications
Replaces: MP Filtri CU630M60N; Donaldson C6306, P171677
O.D.: 5 1/8 (130.2)
I.D.: 3 (76.2)
Height: 9 27/32 (250.0)
O-Ring: [2] Attached

PT23476



Hydraulic Element

Fits: Parker Applications
Replaces: Parker 924739; Donaldson P171248; Fleetguard HF7777, HF7778
O.D.: 2 3/4 (69.9)
I.D.: 1 11/16 (42.9)
Height: 8 21/32 (219.9)
A. Gskt: [2] Attached

PT23472



Hydraulic Element

Fits: MP Filtri Applications
Replaces: MP Filtri SF510M90
O.D.: 3 29/32 (99.2)
I.D.: 2 9/16 (65.1)
Height: 7 25/32 (197.6)

PT23477



Hydraulic Element

Fits: Parker Applications
Replaces: Parker 925774
O.D.: 3 29/32 (99.2)
I.D.: 1 21/32 (42.1)
Height: 9 1/4 (235.0)
O-Ring: [2] Attached

Measurements Are Shown In Inches And (Millimeters)

WARNING: These products can expose you to chemicals, including Diisononyl Phthalate, Carbon black extracts, Nickel, 1,3 Butadiene, Ethylene Oxide, Epichlorohydrin, which are known to the State of California to cause cancer, and Bisphenol, Ethylene Glycol, Ethylene Oxide, 1,3 Butadiene, Epichlorohydrin, which are known to the State of California to cause birth defects or other reproductive harm. For more information go to www.P65Warnings.ca.gov.

PT23478 Hydraulic Element with 2 Bail Handles
Contains: By-Pass Valve
Fits: Sofima Applications
Replaces: Sofima 52808; Donaldson CR50, CR60, P171518, P171524
O.D.: 2 3/4 (69.9)
I.D.: 1 5/32 (29.4)
Height: 3 11/32 (84.9)
O-Ring: [1] Attached
Spring: [1] Included



PT23483-MPG Maximum Performance Glass Hydraulic Element
Notes: OBSOLETE. Availability Limited to Dealer Stock.
Fits: Atlas Applications
Replaces: Atlas 4653961; Fairey-Arlon TXW11CC10, TXW11GDL10
O.D.: 7 31/32 (202.4)
I.D.: 9/16 (14.3) & 6 3/16 (157.2)
Height: 17 5/16 (439.7)
O-Ring: [1] Attached



PT23479 Hydraulic Element with Bail Handle
Notes: OBSOLETE. Availability Limited to Dealer Stock.
Contains: By-Pass Valve
Fits: Sofima Applications
Replaces: Sofima CRE055MN1
O.D.: 3 29/32 (99.2)
I.D.: 1 19/32 (40.5)
Height: 10 1/4 (260.3)
O-Ring: [1] Attached
Spring: [1] Included



PT23484-MPG Maximum Performance Glass Hydraulic Element
Notes: OBSOLETE. Availability Limited to Dealer Stock.
Fits: Caterpillar Applications
Replaces: Caterpillar 9J6472; Komatsu 21T6012460; Fleetguard HF30479
O.D.: 3 3/32 (78.6)
I.D.: 1 11/16 (42.9) One End
Height: 4 21/32 (118.3)
O-Ring: [1] Attached



PT23480 Hydraulic Element with Bail Handle
Notes: OBSOLETE. Availability Limited to Dealer Stock.
Contains: By-Pass Valve
Fits: Sofima Applications
Replaces: Sofima TE55MCV1; Donaldson CR125, P171584
O.D.: 3 29/32 (99.2)
I.D.: 1 19/32 (40.5)
Height: 6 29/32 (175.4)
O-Ring: [1] Attached
Spring: [1] Included



PT23485-MPG Maximum Performance Glass Hydraulic Element
Notes: OBSOLETE. Availability Limited to Dealer Stock.
Fits: Dana Applications
Replaces: Dana 57727; Cim-Tek E130030167; Donaldson P170102
O.D.: 6 3/32 (154.8)
I.D.: 2 5/8 (66.7)
Height: 17 27/32 (453.2)
O-Ring: [2] Attached



PT23481 Hydraulic Element
Notes: OBSOLETE. Availability Limited to Dealer Stock.
Contains: Threaded Stud: 1 1/4-11 BSP
Fits: U.F.I. Applications
Replaces: U.F.I. Filters ESA31B10WMF; Donaldson FIOA130, P171885
O.D.: 4 1/32 (102.4)
Height: 7 11/16 (195.3)



PT23486-MPG Maximum Performance Glass Hydraulic Element
Notes: OBSOLETE. Availability Limited to Dealer Stock.
Fits: Donaldson Applications
Replaces: Donaldson P164707, P161927
O.D.: 7 7/16 (188.9)
I.D.: 4 27/32 (123.0) One End
Height: 22 1/32 (559.6)
A. Gskt: [1] Attached



PT23482 Hydraulic Element
Contains: Threaded Stud: 1 1/2-11 BSP
Fits: U.F.I. Applications
Replaces: U.F.I. Filters ESA31B12WMF; Donaldson FIOA180, P172452
O.D.: 4 1/32 (102.4)
Height: 7 11/16 (195.3)













PT23487-MPG Maximum Performance Glass Hydraulic Element
Notes: OBSOLETE. Availability Limited to Dealer Stock.
Fits: Fairey-Arlon Applications
Replaces: Fairey-Arlon TXW5AGDL20; Donaldson CRS28003, P171821; Fleetguard HF35127
O.D.: 4 3/16 (106.4)
I.D.: 13/32 (10.3) & 2 13/16 (71.4)
Height: 18 5/16 (465.1)
O-Ring: [1] Attached



Measurements Are Shown In Inches And (Millimeters)

WARNING: These products can expose you to chemicals, including Diisononyl Phthalate, Carbon black extracts, Nickel, 1,3 Butadiene, Ethylene Oxide, Epichlorohydrin, which are known to the State of California to cause cancer, and Bisphenol, Ethylene Glycol, Ethylene Oxide, 1,3 Butadiene, Epichlorohydrin, which are known to the State of California to cause birth defects or other reproductive harm. For more information go to www.P65Warnings.ca.gov.

<p>PT23488-MPG Maximum Performance Glass Hydraulic Element</p>  <p>Notes: OBSOLETE. Availability Limited to Dealer Stock. Fits: Fairey-Arlon Applications Replaces: Fairey-Arlon TXW6ACC10; Donaldson CRS3002, P172461; Fleetguard HF7962 O.D.: 4 31/32 (126.2) I.D.: 13/32 (10.3) & 3 5/8 (92.1) Height: 8 1/4 (209.6) O-Ring: [1] Attached</p>	<p>PT23493-MPG Maximum Performance Glass Hydraulic Element with Bail Handle</p>  <p>Contains: By-Pass Valve Fits: Hydac Applications Replaces: Hydac 330R020BN3HC; Donaldson HR33003, P173170 O.D.: 3 23/32 (94.5) I.D.: 1 25/32 (45.2) & 1 29/32 (48.4) Height: 7 3/32 (180.2) O-Ring: [1] Attached</p>
<p>PT23489-MPG Maximum Performance Glass Hydraulic Element</p>  <p>Fits: Fairey-Arlon Applications Replaces: Caterpillar 3I1957; Fairey-Arlon 270L123A; Donaldson 40753, P173030; Fleetguard HF30714 O.D.: 2 29/32 (73.8) I.D.: 1 1/4 (31.8) One End Height: 3 29/32 (99.2) O-Ring: [1] Attached, [1] Included</p>	<p>PT23494-MPG Maximum Performance Glass Hydraulic Element</p>  <p>Fits: Hydac Applications Replaces: Hydac 60D020BN3HCV; Donaldson DT0060D25UM, P566653 O.D.: 1 27/32 (46.8) I.D.: 7/8 (22.2) One End Height: 3 5/16 (84.1) O-Ring: [1] Attached</p>
<p>PT23490-MPG Maximum Performance Glass Hydraulic Element</p>  <p>Fits: Fairey-Arlon Applications Replaces: Caterpillar 3I1955; Fairey-Arlon 870P110 O.D.: 3 11/16 (93.7) I.D.: 1 29/32 (48.4) One End Height: 3 29/32 (99.2) F. Gskt: [1] Included O-Ring: [1] Attached</p>	<p>PT23495-MPG Maximum Performance Glass Hydraulic Element</p>  <p>Fits: J.C. Bamford Applications Replaces: J.C. Bamford 32/925363 O.D.: 1 21/32 (42.1) I.D.: 29/32 (23.0) & 1 1/32 (26.2) Height: 8 (203.2) O-Ring: [1] Attached</p>
<p>PT23491-MPG Maximum Performance Glass Hydraulic Element</p>  <p>Fits: Genie Applications Replaces: Genie 20880; Donaldson CM29002 O.D.: 1 25/32 (45.2) I.D.: 1 (25.4) One End Height: 8 1/4 (209.6) O-Ring: [1] Attached</p>	<p>PT23496-MPG Maximum Performance Glass Hydraulic Element with Bail Handle</p>  <p>Contains: By-Pass Valve Fits: Liebherr Applications Replaces: Liebherr 510670408; Donaldson CR32502, P171555 O.D.: 5 1/8 (130.2) I.D.: 2 1/32 (51.6) One End Height: 8 1/32 (204.0) O-Ring: [1] Attached Spring: [1] Included</p>
<p>PT23492-MPG Maximum Performance Glass Hydraulic Element</p>  <p>Fits: Hydac Applications Replaces: Hydac 2060902, 1074D03BN O.D.: 1 25/32 (45.2) I.D.: 1 (25.4) One End Height: 4 15/32 (113.5) O-Ring: [1] Attached</p>	<p>PT23497-MPG Maximum Performance Glass Hydraulic Element with Bail Handle</p>  <p>Notes: OBSOLETE. Availability Limited to Dealer Stock. Fits: Liebherr Applications Replaces: Liebherr 7621306, 7624324; Fleetguard HF35330 O.D.: 6 (152.4) I.D.: 3 11/32 (84.9) Height: 13 1/2 (342.9) O-Ring: [2] Attached</p>

Measurements Are Shown In Inches And (Millimeters)

WARNING: These products can expose you to chemicals, including Diisononyl Phthalate, Carbon black extracts, Nickel, 1,3 Butadiene, Ethylene Oxide, Epichlorohydrin, which are known to the State of California to cause cancer, and Bisphenol, Ethylene Glycol, Ethylene Oxide, 1,3 Butadiene, Epichlorohydrin, which are known to the State of California to cause birth defects or other reproductive harm. For more information go to www.P65Warnings.ca.gov.

PT23498-MPG Maximum Performance Glass Hydraulic Element



Notes: OBSOLETE. Availability Limited to Dealer Stock.
Fits: Linde Applications
Replaces: Linde 9831601; Donaldson P763004
O.D.: 1 31/32 (50.0)
I.D.: 31/32 (24.6) One End
Height: 8 1/4 (209.6)
O-Ring: [1] Attached

PT23503-MPG Maximum Performance Glass Hydraulic Element



Notes: OBSOLETE. Availability Limited to Dealer Stock.
Fits: MP Filtri Applications
Replaces: MP Filtri HP1352A03NA; Donaldson P171737
O.D.: 2 3/32 (53.2)
I.D.: 1 3/32 (27.8) One End
Height: 9 1/16 (230.2)
O-Ring: [1] Attached

PT23499-MPG Maximum Performance Glass Hydraulic Element

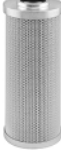

Fits: Manitou Applications
Replaces: Manitou 236095
O.D.: 2 23/32 (69.1)
I.D.: 1 3/16 (30.2) One End
Height: 6 29/32 (175.4)
O-Ring: [1] Attached

PT23504-MPG Maximum Performance Glass Hydraulic Element



Notes: OBSOLETE. Availability Limited to Dealer Stock.
Fits: MP Filtri Applications
Replaces: MP Filtri MR1004A25A; Donaldson CRS16003
O.D.: 2 27/32 (72.2)
I.D.: 11/32 (8.7) & 1 25/32 (45.2)
Height: 11 13/16 (300.0)
O-Ring: [1] Attached

PT23500-MPG Maximum Performance Glass Hydraulic Element with Bail Handle



Contains: By-Pass Valve
Fits: MP Filtri Applications
Replaces: MP Filtri MF1001A10HB; Donaldson CR5002, CR6002, P171519, P171525
O.D.: 2 3/4 (69.9)
I.D.: 1 5/32 (29.4)
Height: 3 11/32 (84.9)
O-Ring: [1] Attached
Spring: [1] Included

PT23505-MPG Maximum Performance Glass Hydraulic Element with Bail Handle



Contains: By-Pass Valve
Fits: MP Filtri Applications
Replaces: MP Filtri MF7501A10HB; Donaldson CR80002, P171579
O.D.: 5 1/8 (130.2)
I.D.: 2 9/16 (65.1) One End
Height: 15 29/32 (404.0)
O-Ring: [1] Attached

PT23501-MPG Maximum Performance Glass Hydraulic Element with 2 Bail Handles



Contains: By-Pass Valve
Fits: MP Filtri Applications
Replaces: MP Filtri MF1002A25HB; Donaldson CR5003, P171532
O.D.: 2 3/4 (69.9)
I.D.: 1 5/32 (29.4)
Height: 5 1/8 (130.2)
O-Ring: [1] Attached
Spring: [1] Included

PT23506-MPG Maximum Performance Glass Hydraulic Element



Notes: OBSOLETE. Availability Limited to Dealer Stock.
Fits: Pall Applications
Replaces: Pall HC8500FDS13H; Fleetguard HF30287
O.D.: 3 13/16 (96.8)
I.D.: 1 11/16 (42.9)
Height: 12 7/8 (327.0)
O-Ring: [2] Attached

PT23502-MPG Maximum Performance Glass Hydraulic Element



Fits: MP Filtri Applications
Replaces: MP Filtri CU630A10N; Donaldson C63002, P171672
O.D.: 5 1/8 (130.2)
I.D.: 3 (76.2)
Height: 9 27/32 (250.0)
O-Ring: [2] Attached

PT23507-MPG Maximum Performance Glass Hydraulic Element



Fits: Pall Applications
Replaces: Pall HC9600FKN13Z
O.D.: 3 1/16 (77.8)
I.D.: 1 23/32 (43.7) One End
Height: 12 31/32 (329.4)
O-Ring: [1] Attached

Measurements Are Shown In Inches And (Millimeters)
WARNING: These products can expose you to chemicals, including Diisononyl Phthalate, Carbon black extracts, Nickel, 1,3 Butadiene, Ethylene Oxide, Epichlorohydrin, which are known to the State of California to cause cancer, and Bisphenol, Ethylene Glycol, Ethylene Oxide, 1,3 Butadiene, Epichlorohydrin, which are known to the State of California to cause birth defects or other reproductive harm. For more information go to www.P65Warnings.ca.gov.

PT23508-MPG Maximum Performance Glass Hydraulic Element



Fits: Pall Applications
Replaces: Pall HC0101FDT18H, HC2618FKT18H; Donaldson P170103, P566708
O.D.: 6 3/32 (154.8)
I.D.: 2 5/8 (66.7)
Height: 17 27/32 (453.2)
A. Gskt: [2] Attached

PT23513-MPG Maximum Performance Glass Hydraulic Element



Fits: Parker Applications
Replaces: Caterpillar 311717; Parker 932624Q, G01301, G01301Q; Donaldson P170068
O.D.: 2 3/8 (60.3)
I.D.: 1 13/32 (35.7) One End
Height: 5 5/16 (134.9)
O-Ring: [1] Attached

PT23509-MPG Maximum Performance Glass Hydraulic Element



Fits: Parker Applications
Replaces: Parker G04167Q
O.D.: 3 3/32 (78.6)
I.D.: 1 23/32 (43.7) One End
Height: 8 1/4 (209.6)
O-Ring: [1] Attached

PT23514-MPG Maximum Performance Glass Hydraulic Element



Fits: Parker Applications
Replaces: Parker 925789, 932670Q, 415VQ; Donaldson P174624, P566272
O.D.: 3 29/32 (99.2)
I.D.: 1 21/32 (42.1)
Height: 9 1/4 (235.0)
O-Ring: [2] Attached

PT23510-MPG Maximum Performance Glass Hydraulic Element



Fits: Parker Applications
Replaces: Parker 930367Q
O.D.: 1 25/32 (45.2)
I.D.: 1 (25.4) One End
Height: 4 15/32 (113.5)
O-Ring: [1] Attached

PT23515-MPG Maximum Performance Glass Hydraulic Element



Fits: Parker Applications
Replaces: Parker 932678Q; Donaldson DTHF4188UM, P566275
O.D.: 3 29/32 (99.2)
I.D.: 1 21/32 (42.1)
Height: 18 1/2 (469.9)
O-Ring: [2] Attached

PT23511-MPG Maximum Performance Glass Hydraulic Element



Notes: OBSOLETE. Availability Limited to Dealer Stock.
Fits: Parker Applications
Replaces: Parker 933800Q; Donaldson P170063
O.D.: 5 5/8 (142.9)
I.D.: 4 (101.6)
Height: 11 29/32 (302.4)
A. Gskt: [2] Attached
F. Gskt: [1] Included

PT23516-MPG Maximum Performance Glass Hydraulic Element



Fits: Parker Applications
Replaces: Parker FTBE2810Q, G02076; Fleetguard HF7704
O.D.: 2 3/8 (60.3)
I.D.: 1 5/32 (29.4) & 1 7/16 (36.5)
Height: 9 9/16 (242.9)
O-Ring: [2] Attached

PT23512-MPG Maximum Performance Glass Hydraulic Element



Notes: OBSOLETE. Availability Limited to Dealer Stock.
Fits: Parker Applications
Replaces: Parker 933135Q
O.D.: 2 3/8 (60.3)
I.D.: 1 13/32 (35.7) One End
Height: 5 5/16 (134.9)
O-Ring: [1] Attached











PT23517-MPG Maximum Performance Glass Hydraulic Element



Contains: [2] Stacked Elements
Fits: Sandvik Applications
Replaces: Sandvik 86727289; Fleetguard HF35130
O.D.: 4 31/32 (126.2)
I.D.: 13/32 (10.3) & 3 5/8 (92.1)
Height: 22 27/32 (580.2)
O-Ring: [1] Attached

Measurements Are Shown In Inches And (Millimeters)

WARNING: These products can expose you to chemicals, including Diisononyl Phthalate, Carbon black extracts, Nickel, 1,3 Butadiene, Ethylene Oxide, Epichlorohydrin, which are known to the State of California to cause cancer, and Bisphenol, Ethylene Glycol, Ethylene Oxide, 1,3 Butadiene, Epichlorohydrin, which are known to the State of California to cause birth defects or other reproductive harm. For more information go to www.P65Warnings.ca.gov.

<p>PT23518-MPG Maximum Performance Glass Hydraulic Element</p>  <p>Fits: Schroeder Applications Replaces: Schroeder CCS7, CCZ10 O.D.: 2 7/8 (73.0) I.D.: 1 3/32 (27.8) Height: 9 1/2 (241.3) O-Ring: [1] Attached</p>	<p>PT23523-MPG Maximum Performance Glass Hydraulic Element with Bail Handle</p>  <p>Contains: By-Pass Valve Fits: Sofima Applications Replaces: Sofima CRE055FD1, RS55FD1 O.D.: 3 29/32 (99.2) I.D.: 1 19/32 (40.5) One End Height: 10 1/4 (260.3) O-Ring: [1] Attached</p>
<p>PT23519-MPG Maximum Performance Glass Hydraulic Element</p>  <p>Fits: Schroeder Applications Replaces: Schroeder KKS7, KKZ10; Cim-Tek 30142; Donaldson P174249 O.D.: 3 29/32 (99.2) I.D.: 1 21/32 (42.1) Height: 18 1/2 (469.9) O-Ring: [2] Attached</p>	<p>PT23524-MPG Maximum Performance Glass Hydraulic Element</p>  <p>Notes: OBSOLETE. Availability Limited to Dealer Stock. Fits: U.F.I. Filter Applications Replaces: U.F.I. EPA12NFD; Donaldson FM18003, P171709 O.D.: 1 21/32 (42.1) I.D.: 7/8 (22.2) One End Height: 7 1/32 (178.6) O-Ring: [1] Attached</p>
<p>PT23520-MPG Maximum Performance Glass Hydraulic Element</p>  <p>Fits: Schroeder Hydraulic Applications Replaces: Schroeder BBS7, BBZ7; Donaldson P560400 O.D.: 4 31/32 (126.2) I.D.: 3 5/16 (84.1) Height: 18 5/16 (465.1) A. Gskt: [2] Attached</p>	<p>BT23525-MPG Maximum Performance Glass Hydraulic Spin-on</p>  <p>Fits: Case, Case-IH, John Deere, Kalmar, New Holland Equipment Replaces: Hydac 90MA020BN; Fleetguard HF30399 Thread: 1 1/2 -16 O.D.: 3 3/4 (95.3) Height: 5 9/16 (141.3) F. Gskt: [1] Included</p>
<p>PT23521-MPG Maximum Performance Glass Hydraulic Element with Bail Handle</p>  <p>Fits: Schwing Applications Replaces: Schwing 10190588; Donaldson P564845, P566352 O.D.: 3 27/32 (97.6) I.D.: 2 9/16 (65.1) Height: 15 9/32 (388.1) O-Ring: [2] Attached</p>	<p>PT23526 Hydraulic Element</p>  <p>Contains: [2] 1/4 Inch Bolt Holes By-Pass Valve Fits: Fendt Tractors Replaces: Fendt F285102050010; Fleetguard HF35309 O.D.: 6 7/32 (158.0) I.D.: 2 17/32 (64.3) Height: 3 9/16 (90.5)</p>
<p>PT23522-MPG Maximum Performance Glass Hydraulic Element</p>  <p>Notes: OBSOLETE. Availability Limited to Dealer Stock. Fits: Sennebogen Applications Replaces: Sennebogen 3751027324; Donaldson P560403 O.D.: 3 3/32 (78.6) I.D.: 1 5/8 (41.3) One End Height: 16 13/16 (427.0) O-Ring: [1] Attached</p>	<p>PT23527 Hydraulic Strainer</p>  <p>Notes: OBSOLETE. Availability Limited to Dealer Stock. Fits: Claas Tractors Replaces: Claas 7665380 O.D.: 2 3/4 (69.9) I.D.: 31/32 (24.6) Height: 2 29/32 (73.8)</p>
	<p>PT23528-MPG Maximum Performance Glass Power Steering Element</p>  <p>Notes: OBSOLETE. Availability Limited to Dealer Stock. Fits: Ponsse Forestry Machines Replaces: Ponsse 36673 O.D.: 2 1/8 (54.0) I.D.: 7/8 (22.2) One End Height: 2 5/8 (66.7) O-Ring: [1] Attached, [2] Included</p>

Measurements Are Shown In Inches And (Millimeters)

WARNING: These products can expose you to chemicals, including Diisononyl Phthalate, Carbon black extracts, Nickel, 1,3 Butadiene, Ethylene Oxide, Epichlorohydrin, which are known to the State of California to cause cancer, and Bisphenol, Ethylene Glycol, Ethylene Oxide, 1,3 Butadiene, Epichlorohydrin, which are known to the State of California to cause birth defects or other reproductive harm. For more information go to www.P65Warnings.ca.gov.

PT23530 Hydraulic Strainer Element
Contains: Threaded End: 1 1/2 BSP/G
Fits: Sennebogen 825M, 870 Material Handlers with Cummins QSB6.7 Engine
Replaces: Sennebogen 27376; Donaldson P550825
O.D.: 3 3/8 (85.7)
Height: 12 3/16 (309.6)



BT23536 Wire Mesh Transmission Strainer
Contains: By-Pass Valve
Fits: Case Dozers, Loaders, Cable Layers
Replaces: Case D37035
O.D.: 2 5/8 (66.7)
I.D.: 1 7/32 (31.0) One End
Height: 4 3/4 (120.7)
O-Ring: [1] Attached



PT23531-MPG Maximum Performance Glass Hydraulic Element
Fits: John Deere Dump Trucks, Loaders
Replaces: John Deere AT335977; Donaldson P574195
O.D.: 3 11/16 (93.7)
I.D.: 1 7/8 (47.6) One End
Height: 21 23/32 (551.7)
O-Ring: [2] Attached



BT23537 Hydraulic Spin-on
Fits: Agco Tractors with Cummins Engines
Replaces: Massey Ferguson 3616579M2, 3907580M2, 4303303M1, 6907580M1
Thread: M42 x 2.0-6G
O.D.: 5 7/16 (138.1)
Height: 3 15/16 (100)
I.Gskt: [1] Included



PT23532-MPG Maximum Performance Glass Hydraulic Element
Fits: John Deere Engines, Forestry and Logging Equipment
Replaces: John Deere F058908; Timberjack T058908
O.D.: 2 11/16 (68.3)
I.D.: 1 5/16 (33.3)
Height: 7 1/2 (190.5)
O-Ring: [1] Attached



BT23539 Hydraulic Spin-on
Contains: Water Absorbing Media
Fits: Tigercat Grapple Skidders; Feller Bunchers with Cummins Engines
Replaces: Tigercat AY052; Donaldson P561183; Fleetguard HF35477
Thread: 1 1/2 -16
O.D.: 5 1/32 (127.8)
Height: 10 11/16 (271.5)
F. Gskt: [2] Included
O-Ring: [1] Included



PT23533 Hydraulic Element
Contains: Threaded End
Fits: Komatsu PC800, PF850, PC1100, PC1250, PC2000 Series Excavators
Replaces: Komatsu 21N6231221
O.D.: 2 3/8 (60.3)
I.D.: 1 1/2 (38.1) One End
Height: 7 7/8 (200.0)



BT23540 Hydraulic Spin-on
Fits: John Deere Tractors
Replaces: John Deere RE161181; Donaldson P564042; Fleetguard HF35484
Thread: 1 1/4 -12
O.D.: 3 27/32 (97.6)
Height: 9 23/32 (246.9)
A. Gskt: [1] Included
O-Ring: [1] Attached



PT23535 Hydraulic Strainer Spin-on
Contains: Threaded Stud: 1 Inch NPT
Fits: Caterpillar, Mitsubishi Lift Trucks
Replaces: Caterpillar 8137523600
O.D.: 3 31/32 (100.8)
Height: 3 19/32 (91.3)



BT23542-MPG Maximum Performance Glass Hydraulic Spin-on
Fits: Case-International Tractors, Harvesters; New Holland Tractors
Replaces: Case 84487937, 87413809; New Holland 84487937, 87413809
Thread: 1 3/4 -12
O.D.: 4 25/32 (121.4)
Height: 14 1/4 (362.0)
I.Gskt: [1] Attached











PT23544-MPG Maximum Performance Glass Hydraulic Element
Fits: Hamm HD120, HD130, HD275, 3412, 3307 Rollers
Replaces: Wirtgen 1285491; Hamm 1285491, 3001285491; Fleetguard HF29065
O.D.: 3 3/32 (78.6)
I.D.: 1 9/32 (32.5) One End
Height: 9 1/2 (241.3)

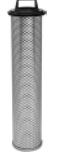

Measurements Are Shown In Inches And (Millimeters)

WARNING: These products can expose you to chemicals, including Diisononyl Phthalate, Carbon black extracts, Nickel, 1,3 Butadiene, Ethylene Oxide, Epichlorohydrin, which are known to the State of California to cause cancer, and Bisphenol, Ethylene Glycol, Ethylene Oxide, 1,3 Butadiene, Epichlorohydrin, which are known to the State of California to cause birth defects or other reproductive harm. For more information go to www.P65Warnings.ca.gov.

<p>PT23545-MPG Maximum Performance Glass Hydraulic Element</p>  <p>Fits: Volvo Excavators, Pipelayers Replaces: Volvo 14569658, 14690316 O.D.: 7 (177.8) I.D.: 4 5/16 (109.5) Height: 17 1/32 (432.6) A. Gskt: [1] Included</p>	<p>PT23561-MPG Maximum Performance Glass Hydraulic Element with Blank Band</p>  <p>Fits: Bobcat Loaders Replaces: Bobcat 7024037 O.D.: 3 13/32 (86.5) I.D.: 1 3/8 (34.9) One End Height: 8 3/32 (205.6)</p>
<p>PT23546-MPG Maximum Performance Glass Hydraulic Element with Blank Band</p>  <p>Fits: Volvo Excavators Replaces: Volvo 14539482, 14688861; Donaldson P502494; Fleetguard HF3551 O.D.: 5 29/32 (150.0) I.D.: 4 1/16 (103.2) Height: 17 1/32 (432.6) A. Gskt: [1] Attached</p>	<p>PT23565-MPG Maximum Performance Glass Hydraulic Element with Handle</p>  <p>Fits: Claas Combines; Ingersoll-Rand Compressors; Terex Loaders Replaces: Argo V3093408; Filtrec WG966; Wix R01E15GA O.D.: 3 17/32 (89.7) Lid 4 5/32 (105.6) I.D.: 2 1/16 (52.4) One End Height: 15 (381.0) O-Ring: [1] Attached</p>
<p>BT23555-MPG Maximum Performance Glass Hydraulic Spin-on</p>  <p>Contains: 15 PSID Bypass Valve Fits: Case-International Tractors; New Holland Tractors; Steyer Tractors Replaces: Case 84257511; Donaldson P765662; Mann & Hummel W14005; Wix 57794 Thread: 1 3/4 -16 UN O.D.: 5 3/8 (136.5) Height: 7 (177.8) A. Gskt: [1] Included Grommets: [1] Attached</p>	<p>PT23566-MPG Maximum Performance Glass Hydraulic Element with Handle</p>  <p>Replaces: Argo V3094108; Filtrec WG967; Wix R21G15GA O.D.: 3 17/32 (89.7) Lid 4 3/16 (106.4) I.D.: 2 1/16 (52.4) One End Height: 17 17/32 (445.3) O-Ring: [1] Attached</p>
<p>PT23556-MPG Maximum Performance Glass Hydraulic Element</p>  <p>Fits: Schroeder Hydraulic Applications Replaces: Schroeder 9V5Z10; Donaldson P572998 O.D.: 2 7/8 (73.0) I.D.: 1 1/2 (38.1) One End Height: 9 9/16 (242.9) O-Ring: [1] Attached</p>	<p>PT23567-MPG Maximum Performance Glass Hydraulic Element</p>  <p>Replaces: Clark 251223; Filtrec WG846; Wix W01AG846 O.D.: 2 13/16 (71.4) I.D.: 1 5/8 (41.3) Height: 7 15/16 (201.6) O-Ring: [2] Attached</p>
<p>PT23560 Hydraulic Element</p>  <p>Fits: Hitachi Excavators Replaces: Hitachi 4688140 O.D.: 3 5/16 (84.1) I.D.: 1 1/2 (38.1) Height: 6 13/32 (162.7) A. Gskt: [1] Included</p>	<p>PT23568-MPG Maximum Performance Glass Hydraulic Element</p>  <p>Fits: Hamm Rollers Replaces: Hamm 02038889, 2038889; Filtrec WG726 O.D.: 1 3/4 (44.4) I.D.: 13/16 (20.6) One End Height: 6 21/32 (169.1) O-Ring: [1] Attached</p>

Measurements Are Shown In Inches And (Millimeters)

WARNING: These products can expose you to chemicals, including Diisononyl Phthalate, Carbon black extracts, Nickel, 1,3 Butadiene, Ethylene Oxide, Epichlorohydrin, which are known to the State of California to cause cancer, and Bisphenol, Ethylene Glycol, Ethylene Oxide, 1,3 Butadiene, Epichlorohydrin, which are known to the State of California to cause birth defects or other reproductive harm. For more information go to www.P65Warnings.ca.gov.

PT23569-MPG Maximum Performance Glass Hydraulic Element



Fits: Internormen Applications
Replaces: Internormen 300209
O.D.: 2 3/4 (69.9)
I.D.: 1 5/8 (41.3) One End
Height: 11 31/32 (304.0)
O-Ring: [1] Included

PT23574-MPG Maximum Performance Glass Hydraulic Element



Fits: Komatsu Dozers, Excavators
Replaces: Komatsu 20Y6021410
O.D.: 2 3/4 (69.9)
I.D.: 1 25/32 (45.2) & 1 25/32 (45.2)
Height: 1 1/4 (31.8)
A. Gskt: [2] Included

PT23570-MPG Maximum Performance Glass Hydraulic Element



Replaces: Internormen 300093; Filtrec RLR70E20B5; Wix R64D20EV5
O.D.: 1 25/32 (45.2)
I.D.: 29/32 (23.0) One End
Height: 6 9/16 (166.7)
O-Ring: [1] Included

PT23575-MPG Maximum Performance Glass Hydraulic Element



Replaces: Linde 0009831645, 9831645; Filtrec DHD55G05V; Wix D44B05GV
O.D.: 2 7/32 (56.4)
I.D.: 1 (25.4) One End
Height: 4 21/32 (118.3)
O-Ring: [1] Viton Attached

PT23571-MPG Maximum Performance Glass Hydraulic Element



Contains: Slotted Pan Screw M4x12 [fully threaded] UNI EN ISO mounted and secured by means of loctite
Fits: JLG Industries Inc. M400AJP, M400AJPN Aerial Lifts
Replaces: JLG Industries Inc. 7021616; Filtrec WG908
O.D.: 1 3/32 (27.8)
I.D.: 11/32 (8.7) One End
Height: 3 5/32 (80.2)
O-Ring: [1] Attached

PT23576-MPG Maximum Performance Glass Hydraulic Element



Fits: Linde Applications
Replaces: Linde 0009831644, 9831644; Hydac 0095D005BN4HCV, 95D005BN4HCV
O.D.: 2 7/32 (56.4)
I.D.: 1 1/32 (26.2) One End
Height: 8 9/32 (210.3)
O-Ring: [1] Attached

PT23572-MPG Maximum Performance Glass Hydraulic Element



Contains: [1] Backup O-Ring
Fits: Kalmar Applications
Replaces: Kalmar 9239440052
O.D.: 2 3/32 (53.2)
I.D.: 1 1/4 (31.8)
Height: 8 21/32 (219.9)
O-Ring: [2] Included

PT23577-MPG Maximum Performance Glass Hydraulic Element



Contains: 3 PSID By-Pass Valve
Fits: Linde Applications
Replaces: Linde 0009831643, 9831643
O.D.: 3 23/32 (94.5)
I.D.: 1 29/32 (48.4) One End
Height: 15 27/32 (402.4)
I.Gskt: [1] Included

PT23573-MPG Maximum Performance Glass Hydraulic Element



Fits: Kalmar Applications
Replaces: Kalmar 9238551184
O.D.: 1 21/32 (42.1)
I.D.: 5/8 (15.9) One End
Height: 3 1/2 (88.9)
O-Ring: [1] Included
Grommets: [1] Attached

PT23578-MPG Maximum Performance Glass Hydraulic Element



Fits: Putzmeister Applications
Replaces: Putzmeister 273827007
O.D.: 1 27/32 (46.8)
I.D.: 1 (25.4) One End
Height: 15 3/4 (400.0)











PT23579-MPG Maximum Performance Glass Hydraulic Element



Replaces: Sandvik 73833256; Filtrec R734G10; Parker PR4411; Wix R20D10GP
O.D.: 4 31/32 (126.2)
I.D.: 13/32 (10.3) & 3 5/8 (92.1)
Height: 9 27/32 (250.0)

Measurements Are Shown In Inches And (Millimeters)

WARNING: These products can expose you to chemicals, including Diisononyl Phthalate, Carbon black extracts, Nickel, 1,3 Butadiene, Ethylene Oxide, Epichlorohydrin, which are known to the State of California to cause cancer, and Bisphenol, Ethylene Glycol, Ethylene Oxide, 1,3 Butadiene, Epichlorohydrin, which are known to the State of California to cause birth defects or other reproductive harm. For more information go to www.P65Warnings.ca.gov.

<p>PT23580-MPG</p> 	<p>Maximum Performance Glass Hydraulic Element Fits: COE, Inc. Orchard Equipment Replaces: Schroeder 9VZ10, 9VS7; Filtrec WG486; Wix W01AG486 O.D.: 2 7/8 (73.0) I.D.: 1 17/32 (38.9) One End Height: 9 1/2 (241.3) O-Ring: [1] Attached</p>	<p>PT23586</p> 	<p>Hydraulic Element Contains: 14.5 PSID By-Pass Valve 1 3/8-12 UNF-2B Thread Fits: TMC Applications Replaces: TMC 214A752081 O.D.: 3 17/32 (89.7) Height: 6 9/16 (166.7)</p>
<p>PT23581-MPG</p> 	<p>Maximum Performance Glass Hydraulic Element with Bail Handle Contains: 43.5 PSID By-Pass Valve Replaces: Terex 8520065; Filtrec WG820 O.D.: 4 1/2 (114.3) Flange 4 5/8 (117.5) I.D.: 2 19/32 (65.9) One End Height: 16 7/32 (412.0) O-Ring: [1] Attached</p>	<p>PT23587</p> 	<p>Hydraulic Element Fits: Komatsu Excavators Replaces: Komatsu 76233773, 79671973; Filtrec WX470 O.D.: 5 9/32 (134.1) I.D.: 3 19/32 (91.3) Height: 2 27/32 (72.2) A. Gskt: [2] Attached</p>
<p>PT23582-MPG</p> 	<p>Maximum Performance Glass Hydraulic Element Fits: VogeLe Applications Replaces: VogeLe 9624531001 O.D.: 4 1/32 (102.4) I.D.: 2 7/16 (61.9) Height: 13 1/16 (331.8) I.Gskt: [2] Included</p>	<p>PT23588</p> 	<p>Hydraulic Element Contains: M6 Thread Fits: Putzmeister Applications Replaces: Putzmeister 294073005 O.D.: 3 31/32 (100.8) I.D.: 2 13/32 (61.1) Height: 19 (482.6) O-Ring: [2] Attached</p>
<p>PT23583-MPG</p> 	<p>Maximum Performance Glass Hydraulic Element Fits: Wirtgen Equipment Replaces: Wirtgen 90200; Argo V3094006; Wix W01AG572 O.D.: 3 17/32 (89.7) I.D.: 1 19/32 (40.5) One End Height: 15 11/16 (398.5) O-Ring: [1] Attached</p>	<p>PT23589</p> 	<p>Hydraulic Element Contains: M8 Thread Fits: Putzmeister Applications Replaces: Putzmeister 416341 O.D.: 6 (152.4) I.D.: 3 15/16 (100.0) Height: 20 5/16 (515.9) O-Ring: [2] Attached</p>
<p>PT23585</p> 	<p>Hydraulic Element Fits: Hyster Applications Replaces: Hyster 2037740 O.D.: 3 15/16 (100.0) I.D.: 1 1/4 (31.8) & 1 9/16 (39.7) Height: 11 1/32 (280.2) Grommets: [1] Attached</p>	<p>PT23590</p> 	<p>Hydraulic Element Fits: Terex Applications Replaces: Terex 1409828 O.D.: 3 1/16 (77.8) I.D.: 1 19/32 (40.5) One End Height: 11 1/16 (281.0) O-Ring: [1] Attached</p>
		<p>PT23591-MPG</p> 	<p>Maximum Performance Glass Hydraulic Element Fits: Liebherr Dozers, Loaders Replaces: Liebherr 10324849; Filtrec WG1021; Uniflux XH1099 O.D.: 5 31/32 (151.6) I.D.: 3 15/16 (100.0) One End Height: 14 7/32 (361.2) O-Ring: [1] Attached</p>

Measurements Are Shown In Inches And (Millimeters)

WARNING: These products can expose you to chemicals, including Diisononyl Phthalate, Carbon black extracts, Nickel, 1,3 Butadiene, Ethylene Oxide, Epichlorohydrin, which are known to the State of California to cause cancer, and Bisphenol, Ethylene Glycol, Ethylene Oxide, 1,3 Butadiene, Epichlorohydrin, which are known to the State of California to cause birth defects or other reproductive harm. For more information go to www.P65Warnings.ca.gov.

PT23592 Hydraulic Element
Fits: Case, Link-Belt Excavators
Replaces: Case KRJ10590; New Holland KRJ10590
O.D.: 5 29/32 (150.0)
I.D.: 3 7/16 (87.3) One End
Height: 7 23/32 (196.1)
I.Gskt: [1] Included



BT23604 Hydraulic Spin-on
Fits: Komatsu Loaders
Replaces: Komatsu 4181834160
Thread: M45 x 1.5
O.D.: 3 9/32 (83.1)
Height: 6 1/8 (155.4)
O-Ring: [1] Attached



PT23595-MPG Maximum Performance Glass Hydraulic Element
Fits: Various Industrial Hydraulic Applications
Replaces: Galbreath A4968, GBA4968; Killer Filter KF1059169; Main Filter MF0066085
O.D.: 3 29/32 (99.2)
I.D.: 2 1/4 (57.2)
Height: 18 1/2 (469.9)
I.Gskt: [2] Included



BT23605-MPG Maximum Performance Glass Hydraulic Spin-on
Contains: 15 PSID Bypass Valve
Fits: Case-International Tractors; New Holland Tractors; Steyr Tractors
Replaces: Case 84248043; Donaldson P765704; Wix 57421
Thread: 1 3/4 -16 UN
O.D.: 5 3/8 (136.5)
Height: 9 5/8 (244.5)
A. Gskt: [1] Included
Grommets: [1] Attached



PT23597-MPG Maximum Performance Glass Hydraulic Element
Fits: Komatsu PC220LC-8 Excavators
Replaces: Komatsu 20Y9701820, 706311046; Fleetguard HF35530; Wix W01AG515
O.D.: 3 3/4 (95.5)
I.D.: 1 31/32 (50.3)
Height: 9 5/32 (232.4)
O-Ring: [1] Attached



BT23607-MPG Maximum Performance Glass Hydraulic Spin-on
Contains: Threaded Hex-nut for removal.
Fits: Case Excavators, Motor Graders; Link-Belt Excavators all with Isuzu Engines
Replaces: Case KHJ17730, 47635916
Thread: M45 x 2.0-6H
O.D.: 3 7/16 (87.3)
Height: 6 17/32 (165.9)
O-Ring: [1] Attached



PT23598-MPG Maximum Performance Glass Hydraulic Element
Contains: Reinforced Centertube
Fits: Takeuchi Loaders
Replaces: Takeuchi 1551103900; Sakura H-79861; Wix R64F10N
O.D.: 4 13/32 (111.9)
I.D.: 2 3/4 (69.9)
Height: 11 3/4 (298.5)
A. Gskt: [2] Attached



BT23609-MPG Maximum Performance Glass Hydraulic Spin-on
Replaces: Donaldson P170546; Racor 944049Q; Fleetguard HF35438
Thread: 1 3/4 -12 UN
O.D.: 4 3/4 (120.7)
Height: 14 1/4 (362.0)
I.Gskt: [1] Included



PT23600 Hydraulic Element
Contains: Guides
Fits: Hyundai Excavators
Replaces: Hyundai E1310212, E1310212A, E13102124
O.D.: 5 15/16 (150.8)
I.D.: 3 5/16 (84.1)
Height: 17 15/16 (455.6)



BT23611 Lube Spin-on
Contains: Anti-Drainback Valve
50 PSID By-Pass Valve
Fits: Hyster Applications
Replaces: Hyster 4020588, 2075558
Thread: 1 -12
O.D.: 3 11/16 (93.7)
Height: 5 15/32 (138.9)
A. Gskt: G401



BT23603-MPG Maximum Performance Glass Hydraulic Spin-on
Fits: John Deere Tractors
Replaces: John Deere LVA13038
Thread: 1 1/2 -16 UN-2B
O.D.: 4 21/32 (118.3)
Height: 6 9/32 (159.5)
A. Gskt: [1] Included



PT23613-MPG Maximum Performance Glass Hydraulic Stacked Element with Bail Handle
Fits: Liebherr R954C Litronic Excavator
Replaces: Liebherr 11065673
O.D.: 6 5/32 (156)
Height: 21 (533.4)
O-Ring: [2] Attached



Measurements Are Shown In Inches And (Millimeters)

WARNING: These products can expose you to chemicals, including Diisononyl Phthalate, Carbon black extracts, Nickel, 1,3 Butadiene, Ethylene Oxide, Epichlorohydrin, which are known to the State of California to cause cancer, and Bisphenol, Ethylene Glycol, Ethylene Oxide, 1,3 Butadiene, Epichlorohydrin, which are known to the State of California to cause birth defects or other reproductive harm. For more information go to www.P65Warnings.ca.gov.

BT23617

Hydraulic Spin-on



Fits: Komatsu Loaders
Replaces: Komatsu 4171834130; Fleetguard HF8144
Thread: 1 1/8 -16
O.D.: 3 23/32 (94.2)
Height: 5 3/8 (136.4)
A. Gskt: [1] Included

BT23619-MPG

Maximum Performance Glass Hydraulic Spin-on



Fits: John Deere Forestry Equipment, Loaders
Replaces: John Deere AT367635; Wix WL10185
Thread: 1 3/8 -12
O.D.: 3 3/4 (95.2)
Height: 8 1/32
O-Ring: [1] Attached

PT23624

Wire Mesh Hydraulic Element



Contains: Bolt Hole M10 x 1.5 Enclosed End
Fits: Volvo Excavators, Pipelayers
Replaces: Volvo 14530989
O.D.: 7 7/8 (199.9)
I.D.: 4 1/2 (114.0) One End
Height: 5 11/32 (135.4)
O-Ring: [1] Attached

PT23625

Wire Mesh Hydraulic Element



Contains: Bolt Hole M10 x 1.5 Enclosed End
Fits: Volvo Excavators, Forestry Equipment
Replaces: Volvo 114100010
O.D.: 7 7/8 (199.9)
I.D.: 3 27/32 (97.8) One End
Height: 3 25/32 (95.8)
O-Ring: [1] Attached

BT23628

Hydraulic Spin-on



Contains: Threaded Stud: M24 x 1.5
35 PSID By-Pass Valve
Fits: John Deere Loaders
Replaces: John Deere AT466863
O.D.: 3 23/32 (94.5)
Height: 5 11/16 (169.9)
A. Gskt: [1] Included

PT23629

Hydraulic Steering Element



Notes: Inside-Out Flow Direction
Contains: Bypass
Fits: Freightliner 108SD, 114SD, 122SD, Business Class M2 106, Business Class M2 112, Business Class M2, Cascadia, Cascadia Evolution, Coronado, Coronado SD, M2 106, M2 112, MT45, MT55; Western Star 4700, 4900EX, 4900FA, 4900SA, 5700XE, 6900XD Trucks
Replaces: Freightliner 1417927000; Fleetguard HF35387
O.D.: 2 5/16 (58.9)
I.D.: 23/32 (18.0) One End
Height: 2 13/16 (71.4)
Grommets: [1] Attached

BT23630

Spin-on Transmission Filter



Fits: 1999-2004 Hyundai Sonata, 2001 XG300, 2002-05 XG350, 2001-09 Santa Fe, 2001-06 Elantra, 2004-08 Tiburon, 2006-09 Tucson, 2008-on Veracruz; 2003-on Kia Magentis, Optima, 2005-09 Amanti, 2007-on Rondo, 2008-on Sedona
Replaces: Hyundai 46322-39000; Kia 46322-39000
Thread: M20 x 1.5
O.D.: 3 1/32 (77.0)
Height: 3 13/32 (86.5)
I.Gskt: [1] Included

BT23631

Transmission Filter



Contains: Anti-Drainback Valve
Wire Mesh By-Pass Screen
Fits: 1999-on Subaru Forester, Impreza, Legacy, Outback, Outback Sport, 2006-07 B9 Tribeca with R4AX-EL (ECB) Transmission (4 Spd.)
Replaces: Subaru 38325-AA032, 38325-KA000
Thread: M20 x 1.5
O.D.: 2 25/32 (70.6)
Height: 2 5/8 (66.7)
I.Gskt: [1] Included

PT23633

Oval Hydraulic Element



Notes: Furnished gasket has 6 bolt holes.
Fits: IHC Wheel Tractors
Replaces: Motorcraft FH42; IHC (International Harvester) 388081-R1, 3888081-R2, 388085-R1, 388085-R2, 403431-R92; Wix 51470, 551470
O.D.: 4 5/8 (117.6)
to 7 1/4 (184.1)
I.D.: 1 7/16 (36.6) & 2 7/8 (72.9)
Height: 3 7/32 (81.8)
A. Gskt: [2] Included
F. Gskt: [1] Included

PT23637-MPG

Maximum Performance Glass Hydraulic Element with Bail Handle

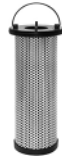

Contains: By-Pass Valve
Fits: Bobcat Loaders
Replaces: Bobcat 7012314; Wix WL10395
O.D.: 3 17/32 (89.9)
I.D.: 1 27/32 (47.0) One End
Height: 10 1/2 (267.0)
O-Ring: [1] Attached

PA30000

Cabin Air Element



Fits: 1/2014-on Ford Transit 2.2 TDCI, 2012-on Transit Custom 2.2 Duratorq all with T22DDOP Engine
Replaces: Ford 1812679
Length: 10 15/16 (277.8)
Width: 9 1/8 (231.8)
Height: 31/32 (24.6)
A. Gskt: [2] Attached

PA30001











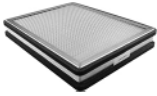

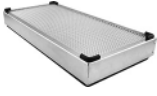
Cab Air Element

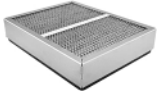

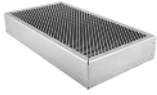
Fits: Caterpillar Excavators
Replaces: Caterpillar 3639402
Length: 7 7/8 (200.0)
Width: 7 1/8 (181.0)
Height: 21/32 (16.7)
A. Gskt: [1] Attached



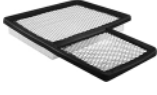









Measurements Are Shown In Inches And (Millimeters)

WARNING: These products can expose you to chemicals, including Diisononyl Phthalate, Carbon black extracts, Nickel, 1,3 Butadiene, Ethylene Oxide, Epichlorohydrin, which are known to the State of California to cause cancer, and Bisphenol, Ethylene Glycol, Ethylene Oxide, 1,3 Butadiene, Epichlorohydrin, which are known to the State of California to cause birth defects or other reproductive harm. For more information go to www.P65Warnings.ca.gov.

<p>PA30002 Cab Air Element with Pull Strap Fits: Caterpillar Equipment Replaces: Caterpillar 2902287 Length: 14 3/32 (358.0) Width: 11 7/32 (285.0) Height: 2 3/16 (55.6) A. Gskt: [2] Attached</p> 	<p>RS30009 Radial Seal Inner Air Element Fits Inside: RS30008 Fits: John Deere Combines Replaces: John Deere HXE11091 O.D.: 8 1/8 (206.4) I.D.: 6 7/8 (174.6) Height: 20 31/32 (532.6)</p> 
<p>PA30003 Cab Air Element Fits: Fiat-Allis/Fiat-Hitachi Loaders Replaces: New Holland 79109003 Length: 19 9/32 (489.7) Width: 8 31/32 (227.8) Height: 2 23/32 (69.1) A. Gskt: [5] Attached</p> 	<p>PA30010 Air Element Replaces: Donaldson B120439 O.D.: 12 19/32 (319.9) I.D.: 7 27/32 (199.2) One End Height: 17 7/16 (442.9)</p> 
<p>PA30004 Cab Air Element with Pull Strap Contains: Charcoal Impregnated Media for Odor Control Fits: Caterpillar Dozers, Loaders Replaces: Caterpillar 1752834 Length: 12 3/16 (309.6) Width: 9 17/32 (242.1) Height: 2 3/16 (55.6) A. Gskt: [1] Attached</p> 	<p>PA30011 Air Element Fits: Generac Generators Replaces: Generac C8127 O.D.: 6 21/32 (169.1) I.D.: 5 3/32 (129.4) Height: 3 3/16 (81.0)</p> 
<p>PA30005 Cab Air Element Contains: Charcoal Impregnated Media for Odor Control. Fits: John Deere Sprayers, Tractors Replaces: John Deere RE199682 Length: 12 19/32 (319.9) Width: 6 21/32 (169.1) Height: 1 15/16 (49.2)</p> 	<p>PA30012 Air Element Fits: Kohler Engines Replaces: Kohler 32063035 O.D.: 6 21/32 (144.5) I.D.: 3 (76.2) & 3 7/8 (98.4) to Height: 1 23/32 (43.7)</p> 
<p>PA30006 Cab Air Element Fits: John Deere Combines, Forage Harvesters Replaces: John Deere H220870; Fleetguard AF27961 Length: 12 19/32 (319.9) Width: 5 1/8 (130.2) Height: 1 7/8 (47.6)</p> 	<p>PA30013 Air Element Fits: Joy Compressors Replaces: Joy 360628319 O.D.: 9 3/8 (238.1) I.D.: 7 9/16 (192.1) Height: 4 5/8 (117.5)</p> 
<p>PA30007 Panel Air Element Fits: Yamaha Golf Carts Replaces: Yamaha JN6E445001, JN6E445000, JN6E44500100, JN0E445000 Length: 12 29/32 (327.8) Width: 10 3/32 (256.4) Height: 1 17/32 (38.9)</p> 	<p>PA30014 Oval Air Element Fits: Kawasaki, Mule Utility Vehicles with FC540V Engine Replaces: Kawasaki 110132143 O.D.: 3 1/4 (82.6) to 7 7/16 (188.9) I.D.: 1 13/16 (22.2) & 5 15/16 (150.8) Height: 3 1/8 (79.4) A. Gskt: [2] Attached</p> 
<p>RS30008 Radial Seal Outer Air Element Fits: John Deere Combines Use With: RS30009 Replaces: John Deere HXE11090 O.D.: 14 7/32 (361.2) I.D.: 8 (203.2) Height: 23 17/32 (597.7)</p> 	

Measurements Are Shown In Inches And (Millimeters)

WARNING: These products can expose you to chemicals, including Diisononyl Phthalate, Carbon black extracts, Nickel, 1,3 Butadiene, Ethylene Oxide, Epichlorohydrin, which are known to the State of California to cause cancer, and Bisphenol, Ethylene Glycol, Ethylene Oxide, 1,3 Butadiene, Epichlorohydrin, which are known to the State of California to cause birth defects or other reproductive harm. For more information go to www.P65Warnings.ca.gov.

<p>PA30015 Air Element Fits: Atlas Copco Compressors Replaces: Atlas Copco 1613872000 O.D.: 4 5/8 (117.5) I.D.: 2 5/8 (66.7) Height: 5 5/16 (134.9)</p> 	<p>PA30021 Air Element Contains: Flame Retardant Media Fits: Daihatsu S-80 Trucks Replaces: Daihatsu 1780187508 O.D.: 4 3/32 (104.0) I.D.: 2 1/4 (57.2) Height: 6 9/32 (159.5) A. Gskt: [2] Attached</p> 
<p>PA30016 Oval Air Element Contains: Two holes in metal end Fits: Tecumseh Engines Replaces: Briggs & Stratton 35403 O.D.: 2 (50.8) to 8 (203.2) I.D.: 13/16 (20.6) & 6 3/4 (171.5) Height: 2 5/16 (58.7)</p> 	<p>PA30022 Oval Air Element Contains: One hole in metal end Fits: Briggs & Stratton 196700 Engine; Cub Cadet 933E, 933R, 1027 Mowers Replaces: Briggs & Stratton 493910 O.D.: 2 (50.8) to 7 1/4 (184.2) I.D.: 1 (25.4) & 6 (152.4) Height: 2 3/16 (55.6)</p> 
<p>PA30017 Oval Air Element with Foam Wrap Fits: John Deere LX178, LX188 Lawn Tractors Replaces: John Deere M115978 O.D.: 4 (101.6) to 8 9/16 (217.5) I.D.: 1 13/16 (46.0) & 4 5/8 (117.5) to Height: 2 7/16 (61.9)</p> 	<p>PA30023 Air Element Fits: Vortex Housings Replaces: Vortex VF-100D O.D.: 7 3/8 (187.3) I.D.: 3 1/2 (88.9) Height: 10 (254.0) A. Gskt: [1] Included</p> 
<p>PA30018 Oval Air Element Contains: Two holes in metal end Fits: Tecumseh Engines Replaces: Tecumseh 36356 O.D.: 4 9/32 (108.7) to 7 5/32 (181.8) I.D.: 1 (25.4) & 6 (152.4) Height: 3 1/8 (79.4)</p> 	<p>PA30024 Air Element Fits: Target Concrete Saws Replaces: Target 168323 O.D.: 3 27/32 (97.6) I.D.: 2 3/8 (60.3) Height: 3 7/32 (81.8)</p> 
<p>PA30019 Air Element Fits: Homelite Concrete Saws Replaces: Homelite 46073 O.D.: 4 9/32 (108.7) I.D.: 2 (50.8) Height: 2 17/32 (64.3)</p> 	<p>PA30025 Air Element Fits: Joy Compressors Replaces: Joy 1663206 O.D.: 7 3/8 (187.3) I.D.: 5 3/16 (131.8) Height: 3 5/16 (84.1)</p> 
<p>PA30020 Air Element Fits: Kohler Applications Replaces: Kohler 2808304 O.D.: 4 1/2 (114.3) I.D.: 3 1/16 (77.8) Height: 4 5/16 (109.5)</p> 	<p>PA30026 Inner Air Element Fits Inside: PA1980-FN Fits: Ford Buses, Trucks Replaces: Donaldson P524815 O.D.: 7 9/32 (184.9) Flange 8 15/32 (215.1) I.D.: 21/32 (16.7) & 6 3/16 (157.2) Height: 9 21/32 (245.3) A. Gskt: [1] Attached F. Gskt: [1] Included</p> 

Measurements Are Shown In Inches And (Millimeters)

WARNING: These products can expose you to chemicals, including Diisononyl Phthalate, Carbon black extracts, Nickel, 1,3 Butadiene, Ethylene Oxide, Epichlorohydrin, which are known to the State of California to cause cancer, and Bisphenol, Ethylene Glycol, Ethylene Oxide, 1,3 Butadiene, Epichlorohydrin, which are known to the State of California to cause birth defects or other reproductive harm. For more information go to www.P65Warnings.ca.gov.

PA30027 Air Element
Fits: Case Construction Equipment, Tractors
Replaces: Air Refiner ARM5233
O.D.: 8 1/16 (204.8)
I.D.: 1/4 (6.4) & 5 25/32 (146.8)
Height: 4 3/4 (120.7)
A. Gskt: [2] Attached
Grommets: [1] Attached



PA30028 Air Element
Fits: Nelson Housings
Replaces: Nelson 89102A
O.D.: 7 7/8 (200.0)
I.D.: 4 5/8 (117.5)
Height: 4 3/16 (106.4)



PA30029 Oval Air Element
Fits: Briggs & Stratton Engines; Cub Cadet 804 Lawn Tractor
Replaces: Briggs & Stratton 393406
O.D.: 3 5/16 (84.1) to 5 1/16 (128.6)
I.D.: 2 1/4 (57.2) & 4 1/16 (103.2)
Height: 2 1/8 (54.0)



PA30030 Air Element
Fits: Kohler Engines
Replaces: Kohler 3208306
O.D.: 4 3/16 (106.4) to 5 11/16 (144.5)
I.D.: 2 9/16 (65.1) & 3 7/8 (98.4)
Height: 3 1/16 (77.8)



PA30031 Oval Air Element
Fits: Cub Cadet, Toro Lawn & Garden Equipment; Kohler Engines
Replaces: Kohler 1208305
O.D.: 3 13/16 (96.8) to 4 1/2 (114.3)
I.D.: 2 1/2 (63.5) & 3 1/8 (79.4)
Height: 2 7/8 (73.0)
A. Gskt: [1] Attached



PA30032 Outer Air Element with Pull Tab
Fits: Massey Ferguson Tractors, Loaders
Use With: PA30033
Replaces: Massey Ferguson 3824035M1
O.D.: 5 1/4 (133.4)
I.D.: 1/2 (12.7) & 3 1/4 (82.6)
Height: 11 7/8 (301.6)
I.Gskt: [2] Included
F. Gskt: [1] Washer Included



PA30033 Inner Air Element
Fits Inside: PA30032
Fits: Massey Ferguson Tractors, Loaders
Replaces: Massey Ferguson 3824036M1
O.D.: 2 15/16 (74.6)
I.D.: 15/32 (11.9) & 2 15/32 (62.7)
Height: 11 1/4 (285.8)
F. Gskt: [1] Washer Included



PA30034 Air Breather Element
Contains: Flame Retardant Media
Fits: Chevrolet, Dodge, Jeep Automotive, Light-Duty Trucks
Replaces: General Motors 6421660
O.D.: 3 1/4 (82.6)
I.D.: 1 31/32 (50.0) One End
Height: 3 21/32 (92.9)
F. Gskt: [1] Included



PA30035 Air Breather Element
Contains: Flame Retardant Media
Fits: Clark Lift Trucks
Replaces: Clark 1618319
O.D.: 3 1/4 (82.6)
I.D.: 1 1/2 (38.1) One End
Height: 2 1/16 (52.4)
F. Gskt: [1] Included



PA30036 Air Element in Disposable Housing
Fits: John Deere Lawn Tractors
Replaces: John Deere AM101283
O.D.: 4 1/2 (114.3)
I.D.: 1 1/2 (38.1) One End
Height: 7 3/8 (187.3)



PA30037 Air Element in Disposable Housing
Fits: Railroad Applications; Fire Equipment
Replaces: Farr 71338008
O.D.: 9 3/4 (247.7)
I.D.: 5 31/32 (151.6) One End
Height: 19 3/4 (501.7)



PA30038 Air Element in Disposable Housing
Fits: Pierce Fire Trucks
Replaces: Farr 400470002
O.D.: 11 1/2 (292.1)
Inlet: 7
Height: 16 29/32 (429.4)



PA30039 Air Element in Disposable Housing
Fits: Pierce Arrow Fire Trucks
Replaces: Farr 99842004
O.D.: 13 1/2 (342.9)
Inlet: 6 25/32
Outlet: 6 25/32
Height: 25 19/32 (650.1)











Measurements Are Shown In Inches And (Millimeters)

WARNING: These products can expose you to chemicals, including Diisononyl Phthalate, Carbon black extracts, Nickel, 1,3 Butadiene, Ethylene Oxide, Epichlorohydrin, which are known to the State of California to cause cancer, and Bisphenol, Ethylene Glycol, Ethylene Oxide, 1,3 Butadiene, Epichlorohydrin, which are known to the State of California to cause birth defects or other reproductive harm. For more information go to www.P65Warnings.ca.gov.

<p>PA30040</p> 	<p>Air Element in Disposable Housing Fits: Pierce Arrow Fire Trucks Replaces: Farr 71338010 O.D.: 10 29/32 (277.0) I.D.: 7 (177.8) One End Height: 19 11/16 (500.1)</p>	<p>PA30048 Cab Air Element Fits: Massey Ferguson Equipment Replaces: Massey Ferguson 3038997-M1 Length: 30 (762.0) Width: 5 31/32 (151.6) Height: 2 1/8 (54.0) A. Gskt: [1] Attached</p> 
<p>PA30041</p> 	<p>Air Element in Disposable Housing Fits: Farr ECO-SM Medium Duty On-Road Vehicles High Inlet Configuration Replaces: Farr 99842010 O.D.: 13 1/2 (342.9) Inlet: 7 Outlet: 7 Height: 16 19/32 (421.5)</p>	<p>PA30049 Cab Air Element Fits: Massey Ferguson Tractors Replaces: Massey Ferguson 536836M1, 536836M2 Length: 44 15/16 (1141.4) Width: 4 (101.6) Height: 2 3/16 (55.6) A. Gskt: [1] Attached</p> 
<p>PA30042</p> 	<p>Air Element in Disposable Housing Fits: Alaska Marine Engines Replaces: Air Refiner ARM2842 O.D.: 8 (203.2) I.D.: 4 (101.6) One End Height: 10 9/16 (268.3)</p>	<p>PA30050 Panel Air Element Fits: Briggs & Stratton Engines Replaces: Briggs & Stratton 272218 Length: 7 (177.8) Width: 3 1/2 (88.9) Height: 1 1/2 (38.1)</p> 
<p>PA30043</p> 	<p>Air Element in Disposable Housing Fits: Spartan Fire Trucks Replaces: Farr 62891004 O.D.: 13 1/2 (342.9) Inlet: 6 15/16 Outlet: 6 15/16 Height: 19 13/16 (503.2)</p>	<p>PA30051 Panel Air Element Fits: Briggs & Stratton Engines Replaces: Briggs & Stratton 710265 Length: 6 11/32 (161.1) Width: 3 1/2 (88.9) Height: 15/16 (23.8)</p> 
<p>PA30044</p> 	<p>Cab Air Element Fits: Caterpillar Integrated Tool Carriers, Wheel Loaders Replaces: Caterpillar 1118738 Length: 15 3/8 (390.5) Width: 3 5/8 (92.1) Height: 1/2 (12.7)</p>	<p>PA30052 Panel Air Element Fits: 1991-96 E-Z-GO Marathon Golf Carts Replaces: E-Z-GO 26855G01 Length: 8 9/16 (217.5) Width: 5 3/32 (129.4) Height: 1 11/32 (34.1)</p> 
<p>PA30045</p> 	<p>Panel Air Element Fits: New Holland Harvesters Various Models Replaces: Case 86545652; Donaldson P783687; Wix 49129 Length: 23 5/8 (600.1) Width: 4 9/32 (108.7) Height: 2 7/32 (56.4)</p>	<p>PA30053 Panel Air Element Fits: Cub Cadet Chippers Replaces: Tecumseh 36046 Length: 3 27/32 (97.6) Width: 3 7/16 (87.3) Height: 1 1/4 (31.8)</p> 
		<p>PA30054 Panel Air Element Fits: Briggs & Stratton Engines Replaces: Briggs & Stratton 710266 Length: 8 11/32 (211.9) Width: 3 31/32 (100.8) Height: 1 3/32 (27.8)</p> 
		<p>PA30055 Panel Air Element Fits: Honda Engines, Lawn Mowers Replaces: Honda 17211Z8B901 Length: 5 1/8 (130.2) Width: 4 7/16 (112.7) Height: 7/8 (22.2)</p> 
		<p>PA30056 Panel Air Element Fits: Tecumseh Engines Replaces: Tecumseh 35500 Length: 7 1/8 (181.0) Width: 2 3/16 (55.6) Height: 3/4 (19.0)</p> 

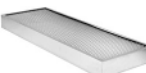









Measurements Are Shown In Inches And (Millimeters)

WARNING: These products can expose you to chemicals, including Diisononyl Phthalate, Carbon black extracts, Nickel, 1,3 Butadiene, Ethylene Oxide, Epichlorohydrin, which are known to the State of California to cause cancer, and Bisphenol, Ethylene Glycol, Ethylene Oxide, 1,3 Butadiene, Epichlorohydrin, which are known to the State of California to cause birth defects or other reproductive harm. For more information go to www.P65Warnings.ca.gov.

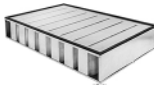
<p>RS30057 Radial Seal Outer Air Element Fits: Donaldson FRG Housings Use With: RS30058 Replaces: Donaldson P549523 O.D.: 12 3/32 (307.2) I.D.: 6 25/32 (172.2) One End Height: 18 1/2 (469.9)</p> 	<p>RS30062 Radial Seal Air Element Fits: Volvo Genset Engines Replaces: Volvo 21377913 O.D.: 9 1/8 (231.8) I.D.: 5 29/32 (150.0) One End Height: 18 5/16 (465.1)</p> 
<p>RS30058 Radial Seal Inner Air Element Fits Inside: RS30057 Fits: Donaldson FRG Housings Replaces: Donaldson P549530 O.D.: 6 7/8 (174.6) I.D.: 5 1/4 (133.4) One End Height: 17 27/32 (453.2)</p> 	<p>PA30063 Air Element Fits: Ford, New Holland Lawn & Garden Equipment Replaces: New Holland SBA408620002 O.D.: 3 9/32 (83.3) Flange 5 (127.0) I.D.: 1/4 (6.4) & 1 3/4 (44.4) Height: 7 11/32 (186.5) A. Gskt: [2] Attached</p> 
<p>RS30059-FN Radial Seal Outer Air Element with Fins Use With: RS3885 Replaces: Donaldson P601790 O.D.: 8 3/16 (208.0) Fins 9 11/32 (237.3) I.D.: 4 5/32 (105.6) One End Height: 16 1/2 (419.1)</p> 	<p>PA30064 Cab Air Element Fits: Challenger, Gleaner, Massey Ferguson Combines Replaces: Massey Ferguson 71393893 Length: 23 11/16 (601.7) Width: 9 (228.6) Height: 2 3/16 (55.6)</p> 
<p>RS30060-FN Radial Seal Outer Air Element with Fins Fits: Donaldson FRG06 Air Cleaners Use With: RS30061 Replaces: Donaldson P549271 O.D.: 5 9/32 (134.1) I.D.: 3 13/32 (86.5) One End Height: 15 (381.0)</p> 	<p>RS30065 Radial Seal Air Element Notes: Must use RS30065 KIT (with Lid) on first installation only. Use RS30065 (Element only) on subsequent applications. Fits: Applications previously using RS5362. Mercedes-Benz Trucks Replaces: Mercedes-Benz A0040942404; Baldwin RS5362 O.D.: 15 7/8 (403.2) I.D.: 8 23/32 (221.5) One End Height: 12 11/16 (322.3)</p> 
<p>RS30061 Radial Seal Inner Air Element Fits Inside: RS30060-FN Fits: Donaldson FRG06 Air Cleaners Replaces: Donaldson P549277 O.D.: 3 9/16 (90.5) I.D.: 2 13/16 (71.4) One End Height: 14 21/32 (372.3)</p> 	<p>RS30065 KIT Radial Seal Air Element with Lid Notes: Must use RS30065 KIT (with Lid) on first installation only. Use RS30065 (Element only) on subsequent applications. Fits: Applications previously using RS5362. Mercedes-Benz Trucks Replaces: Mercedes-Benz A0040942404; Baldwin RS5362; Donaldson P785542; Fleetguard AF26165 Element and Lid O.D.: 15 7/8 (403.2) Lid 20 15/32 (519.9) I.D.: 8 23/32 (221.5) One End Height: 13 5/16 (338.1) F. Gskt: [1] Included Element Only O.D. 15 7/8 (403.2) I.D. 8 23/32 (221.5) Height 12 11/16 (322.3)</p> 









Measurements Are Shown In Inches And (Millimeters)

WARNING: These products can expose you to chemicals, including Diisononyl Phthalate, Carbon black extracts, Nickel, 1,3 Butadiene, Ethylene Oxide, Epichlorohydrin, which are known to the State of California to cause cancer, and Bisphenol, Ethylene Glycol, Ethylene Oxide, 1,3 Butadiene, Epichlorohydrin, which are known to the State of California to cause birth defects or other reproductive harm. For more information go to www.P65Warnings.ca.gov.

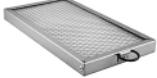
<p>PA30066 Oval Air Element Fits: Caterpillar CT660 Truck Replaces: Caterpillar 3903433 O.D.: 16 3/8 (415.9) to 21 3/4 (552.4) I.D.: 7 5/32 (181.8) & 12 7/16 (315.9) Height: 7 23/32 (196.1)</p> 	<p>PA30072 Secondary Air Element Fits: Caterpillar, Claas Equipment Use With: CA30071 Replaces: Caterpillar 2525002 O.D.: 8 1/4 (209.6) to 10 7/8 (276.2) Height: 1 11/16 (42.9)</p> 
<p>PA30067 Air Element with Foam Wrap Fits: Quincy Compressors Replaces: Quincy 127357E004 O.D.: 8 1/4 (209.6) I.D.: 4 9/16 (115.9) Height: 9 5/8 (244.5)</p> 	<p>PA30073 Air Element in Disposable Housing Notes: Inside-Out Flow Direction Contains: Bleed Valve Fits: Various Buses, Equipment and Trucks with Farr ECO-Style Air Filters Replaces: Farr 94973007 O.D.: 11 (279.4) Inlet: 6 7/8 Height: 19 3/4 (501.7)</p> 
<p>PA30068 Air Element Fits: Cub Cadet Lawn Tractor Replaces: Donaldson P131321 O.D.: 4 1/16 (103.2) Flange 5 9/32 (134.1) I.D.: 1/4 (6.4) & 1 15/32 (37.3) Height: 6 1/32 (153.2) A. Gskt: [1] Included F. Gskt: [1] Wing Nut</p> 	<p>PA30074 Dynacell Panel Air Element Fits: Railroad and Marine Applications Length: 29 1/2 (749.3) Width: 19 (482.6) Height: 5 (127.0)</p> 
<p>PA30069 Conical-Shaped Air Element Fits: Caterpillar Marine Engines Replaces: Caterpillar 2076870 O.D.: 7 1/4 (184.2) to 12 1/4 (311.2) I.D.: 10 1/8 (257.2) One End Height: 15 (381.0)</p> 	<p>PA30075 Wire Mesh Supported Air Element Fits: Caterpillar Marine Engines Replaces: Caterpillar 2436350 O.D.: 8 7/16 (214.3) I.D.: 6 1/2 (165.1) One End Height: 7 (177.8)</p> 
<p>PA30070 Wire Mesh Supported Air Element Fits: Caterpillar Marine Engines Replaces: Caterpillar 1777375 O.D.: 8 25/32 (223.0) I.D.: 7 7/16 (188.9) One End Height: 10 11/32 (262.7)</p> 	<p>PA30076 Conical-Shaped Air Element Fits: Caterpillar 3412, 3412B, 3412E Marine Engines Replaces: Caterpillar 6I0384 O.D.: 7 (177.8) to 8 3/4 (222.3) I.D.: 5 3/4 (146.0) & 7 1/2 (190.5) Height: 12 (304.8)</p> 
<p>CA30071 Channel Flow Primary Air Element Fits: Caterpillar, Claas Equipment Use With: PA30072 Replaces: Caterpillar 2525001; Claas 1094005 O.D.: 9 1/16 (230.2) to 11 11/16 (296.9) Height: 7 3/4 (196.9) A. Gskt: [1] Attached</p> 	<p>RS30077 Radial Seal Outer Air Element Fits: Dynapac CC122, CC122C Rollers Use With: RS30078 Replaces: Dynapac 380295; Donaldson P782299 O.D.: 5 1/32 (127.8) I.D.: 3 5/32 (80.2) One End Height: 9 23/32 (246.9)</p> 

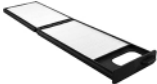
Measurements Are Shown In Inches And (Millimeters)

WARNING: These products can expose you to chemicals, including Diisononyl Phthalate, Carbon black extracts, Nickel, 1,3 Butadiene, Ethylene Oxide, Epichlorohydrin, which are known to the State of California to cause cancer, and Bisphenol, Ethylene Glycol, Ethylene Oxide, 1,3 Butadiene, Epichlorohydrin, which are known to the State of California to cause birth defects or other reproductive harm. For more information go to www.P65Warnings.ca.gov.

<p>RS30078</p>  <p>Radial Seal Inner Air Element Fits Inside: RS30077 Fits: Dynapac CC122, CC122C Rollers Replaces: Dynapac 380294; Donaldson P782300 O.D.: 3 5/16 (84.1) I.D.: 2 3/8 (60.3) One End Height: 9 3/32 (231.0)</p>	<p>RS30088</p>  <p>Radial Seal Inner Air Element Fits Inside: RS30087 Fits: Hammel Red Giant Shredder with Caterpillar C18 Engine Replaces: Donaldson P785395, X770688 O.D.: 8 23/32 (221.5) I.D.: 7 1/32 (178.6) One End Height: 22 31/32 (583.4)</p>
<p>CA30079</p>  <p>Channel Flow Air Element Fits: McCormick Tractors; New Holland Loaders; Skyjack Telehandlers Replaces: Donaldson P608675 O.D.: 5 1/8 (130.2) to 12 7/8 (327.0) Height: 11 5/16 (287.3)</p>	<p>RS30090-FN</p>  <p>Radial Seal Outer Air Element with Fins Fits: International 4900 Series Trucks with HT570 Engine, 7400 WorkStar with DT466, MaxxFace DT, MaxxFace 9 Engines, 7500 WorkStar with HT530, MaxxFace 10 Engines Replaces: International 3532801C1 O.D.: 10 1/4 (260.3) Fins 12 (304.8) I.D.: 6 1/2 (165.1) Height: 15 7/8 (403.2) Related To: RS4636 (without Fins)</p>
<p>PA30080</p>  <p>Cab Air Element with Pull Ring Fits: Caterpillar Equipment Replaces: Caterpillar 1858154; Donaldson P616850 Length: 9 21/32 (245.3) Width: 5 5/16 (134.9) Height: 25/32 (19.8)</p>	<p>RS30091</p>  <p>Radial Seal Outer Air Element Fits: Fendt Tractors Use With: RS30092 Replaces: Fendt H916201091050; Donaldson P783400; Fleetguard AF26205 O.D.: 10 31/32 (278.6) I.D.: 5 13/16 (147.6) One End Height: 18 3/16 (462.0)</p>
<p>PA30081</p>  <p>Cab Air Element Notes: Two filters hinged together. Fits: Kobelco, New Holland Excavators Replaces: New Holland YN50V01014P1, YN50V01014P1 Length: 18 29/32 (480.2) Width: 4 7/8 (123.8) Height: 19/32 (15.1) A. Gskt: [1] Attached Each Element</p>	<p>RS30092</p>  <p>Radial Seal Inner Air Element Fits Inside: RS30091 Fits: Fendt Tractors Replaces: Fendt H916201091060; Donaldson P783401; Fleetguard AF26206 O.D.: 5 29/32 (150.0) I.D.: 4 7/16 (112.7) One End Height: 17 1/8 (435.0)</p>
<p>PA30086</p>  <p>Panel Air Element Notes: For air conditioning. Fits: John Deere Equipment Replaces: John Deere RE198488 Length: 15 1/4 (387.3) Width: 4 29/32 (124.6) Height: 1 7/32 (31.0)</p>	<p>PA30093</p>  <p>Cab Air Element Fits: Kenworth T680, Peterbilt 579 Truck Replaces: Peterbilt X1987001 Length: 8 15/16 (227.0) Width: 7 7/8 (200.0) Height: 1 3/16 (30.2)</p>
<p>RS30087</p>  <p>Radial Seal Outer Air Element Fits: Hammel Red Giant Shredder with Caterpillar C18 Engine Use With: RS30088 Replaces: Donaldson P785394, X770688 O.D.: 14 (355.6) I.D.: 9 (228.6) One End Height: 25 (635.0)</p>	<p>PA30094</p>  <p>Cab Air Element Fits: Case, Link-Belt Excavators Replaces: Case KHR13340, MMR80030 Length: 8 7/8 (225.4) Width: 6 27/32 (173.8) Height: 1 5/16 (33.3) A. Gskt: [1] Attached</p>

Measurements Are Shown In Inches And (Millimeters)

WARNING: These products can expose you to chemicals, including Diisononyl Phthalate, Carbon black extracts, Nickel, 1,3 Butadiene, Ethylene Oxide, Epichlorohydrin, which are known to the State of California to cause cancer, and Bisphenol, Ethylene Glycol, Ethylene Oxide, 1,3 Butadiene, Epichlorohydrin, which are known to the State of California to cause birth defects or other reproductive harm. For more information go to www.P65Warnings.ca.gov.

PA30095

Oval Air Element



Fits: Challenger, Massey Ferguson Tractors
Replaces: Massey Ferguson 4375638M1
O.D.: 7 15/16 (201.6)
 to 11 1/4 (285.8)
I.D.: 1 9/16 (39.7) & 4 3/8 (111.1) to
Height: 8 1/16 (204.8)

PA30096

Cab Air Element with Pull Tabs

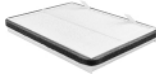

Fits: Case, Link-Belt Excavators
Replaces: Case KHR13330
Length: 9 1/2 (241.3)
Width: 7 (177.8)
Height: 1 3/32 (27.8)
A. Gskt: [1] Attached

PA30098

Cab Air Element



Fits: Caterpillar Pipelayers
Replaces: Caterpillar 2894225
Length: 16 17/32 (419.9)
Width: 5 (127.0)
Height: 1 3/16 (30.2)
A. Gskt: [1] Attached

RS30099

Radial Seal Oval Air Element

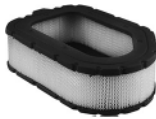

Fits: Kohler Engines
Replaces: Kohler 6208304S
O.D.: 5 9/16 (141.3)
I.D.: 3 1/4 (82.6) One End
Height: 8 5/8 (219.1)

PA30100

Inner Air Element



Fits Inside: PA30101
Fits: Gehl Excavators; Wacker/Wacker Neuson
 Excavators, Wheel Dumpers
Replaces: J.C. Bamford 16546LC50A; Kubota
 K3271-82240; Nissan 16546LC50A
O.D.: 2 1/8 (54.0)
I.D.: 1 11/16 (42.9) One End
Height: 7 3/16 (182.6)

PA30101

Outer Air Element



Fits: Gehl Excavators; Wacker/Wacker Neuson
 Excavators, Wheel Dumpers
Use With: PA30100
Replaces: J.C. Bamford 32/925742; Kubota
 K3271-82240; Nissan 16546LC50A
O.D.: 3 5/8 (92.1)
I.D.: 2 5/16 (58.7) One End
Height: 7 1/16 (179.4)

CA30102

Channel Flow EXO Air Element



Fits: Kenworth Trucks
Replaces: Paccar P611698
O.D.: 11 3/8 (288.9)
 to 18 23/32 (475.5)
Height: 6 1/2 (165.1)
A. Gskt: [1] Attached

CA30103

Channel Flow EXO Air Element



Fits: Mercedes-Benz Actros II, Antos, Arocs
 European Trucks
Replaces: Mercedes-Benz 40946904,
 A0040946904; Donaldson DBA3745
O.D.: 7 3/8 (187.3)
 to 18 7/16 (468.3)
Height: 8 27/32 (224.6)
A. Gskt: [1] Attached
O.D. Flange: 8 7/32 to 19 3/8
Related To: CA30104 (Tall Version)
 CA30105 (Short Version)

CA30104

Channel Flow EXO Air Element



Fits: Mercedes-Benz Actros II, Antos, Arocs
 European Trucks
Replaces: Mercedes-Benz 40946804,
 A0040946804; Donaldson DBA3746
O.D.: 7 3/8 (187.3)
 to 18 7/16 (468.3)
Height: 10 1/4 (260.3)
A. Gskt: [1] Attached
O.D. Flange: 8 7/32 to 19 3/8
Related To: CA30103
 CA30105 (Short Versions)

CA30105

Channel Flow EXO Air Element



Fits: Mercedes-Benz Actros II, Antos, Arocs
 European Trucks
Replaces: Mercedes-Benz A0040947204,
 40947204; Mann & Hummel CP49001
O.D.: 7 3/8 (187.3)
 To 18 7/16 (468.3)
Height: 7 5/8 (193.7)
A. Gskt: [1] Included
O.D. Flange: 8 7/32 to 19 3/8
Related To: CA30104 (Tall Version)
 CA30103 (Short Version)

RS30106

Radial Seal Cab Air Element



Fits: Fendt Tractors
Replaces: Fendt H931812140600
O.D.: 6 3/8 (161.9)
I.D.: 3 23/32 (94.5) One End
Height: 11 3/4 (298.5)

PA30107

Foam Cab Air Element



Fits: Peterbilt 579 Trucks with Cummins ISX,
 Paccar MX Series Engines
Replaces: Peterbilt W2084001
Length: 10 7/16 (265.1)
Width: 6 1/2 (165.1)
Height: 3/8 (9.5)

PA30108











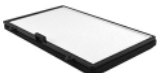

Inner Air Element



Fits Inside: PA30109
Fits: Daewoo, Terex Excavators; Doosan
 Loaders
Replaces: Daewoo 24749057; Donaldson
 P902312
O.D.: 6 3/8 (161.9)
I.D.: 21/32 (16.7) & 5 9/32 (134.1)
Height: 17 25/32 (451.6)
A. Gskt: [1] Attached





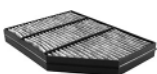





Measurements Are Shown In Inches And (Millimeters)

WARNING: These products can expose you to chemicals, including Diisononyl Phthalate, Carbon black extracts, Nickel, 1,3 Butadiene, Ethylene Oxide, Epichlorohydrin, which are known to the State of California to cause cancer, and Bisphenol, Ethylene Glycol, Ethylene Oxide, 1,3 Butadiene, Epichlorohydrin, which are known to the State of California to cause birth defects or other reproductive harm. For more information go to www.P65Warnings.ca.gov.

<p>PA30109 Outer Air Element Fits: Daewoo, Terex Excavators; Doosan Loaders Use With: PA30108 Replaces: Daewoo 24749051; Donaldson P902311 O.D.: 10 27/32 (275.4) I.D.: 21/32 (16.7) & 6 17/32 (165.9) Height: 19 7/16 (493.7) A. Gskt: [1] Attached</p> 	<p>PA30117 Set of 2 Cab Air Elements Notes: Requires 2 filters per application. Fits: John Deere Harvesters, Tractors Replaces: John Deere L155288 Each Filter: Length: 8 7/32 (208.8) Width: 5 23/32 (145.3) Height: 7/8 (22.2) A. Gskt: [1] Attached Each Filter</p> 
<p>PA30110 Cab Air Element Fits: Case, Hyundai Loaders Replaces: Hyundai 71LB00290 Length: 11 9/16 (293.7) Width: 6 31/32 (177.0) Height: 31/32 (24.6) A. Gskt: [1] Attached</p> 	<p>PA30118 Primary Air Element Fits: Wirtgen SP15, SP15i Slipform Pavers Use With: PA30119 Replaces: Atlas-Weyhausen 8049126; Bomag 5821494; Sullair 274256; Wirtgen 2142670 O.D.: 5 7/16 (138.1) to 10 1/4 (260.3) I.D.: 1 1/16 (27.0) & 4 13/16 (122.2) to Height: 6 11/16 (169.9)</p> 
<p>RS30112 Radial Seal Air Element Fits: Hino Trucks Replaces: Hino 17801E0130 O.D.: 12 9/32 (311.9) I.D.: 6 31/32 (177.0) One End Height: 16 1/2 (419.1)</p> 	<p>PA30119 Secondary Air Element Fits: Wirtgen SP15, SP15i Slipform Pavers Use With: PA30118 Replaces: Atlas-Weyhausen 8049127; Bomag 5821495; Sullair 274381; Wirtgen 2142671 O.D.: 5 5/8 (142.9) to 9 (228.6) Height: 1 9/16 (39.7)</p> 
<p>PA30113 Pre-Filter Cab Air Element Fits: R.V.I., Volvo Trucks, Vans with Volvo D11K, D13C, D13K, D16G, D16K Engines Replaces: Renault 7482379897; Volvo 82354791 Length: 10 23/32 (272.3) Width: 7 23/32 (196.1) Height: 25/32 (19.8)</p> 	<p>RS30120 Radial Seal Inner Air Element Fits Inside: RS30121 Fits: Case, Case-International, New Holland Tractors Replaces: Case 87517153; J.C. Bamford 32/926032 O.D.: 5 3/4 (146.0) I.D.: 4 7/8 (123.8) One End Height: 10 (254.0)</p> 
<p>PA30114 Cab Air Element Fits: Volvo European Trucks, Vans Replaces: Renault 7482348995; Volvo 82348995 Length: 11 7/8 (301.6) Width: 7 29/32 (200.8) Height: 1 1/4 (31.8) O-Ring: [1] Included</p> 	<p>RS30121 Radial Seal Outer Air Element Fits: Case, Case-International, New Holland Tractors Use With: RS30120 Replaces: Case 87517154; J.C. Bamford 32/926031 O.D.: 10 7/8 (276.2) I.D.: 5 3/4 (146.0) One End Height: 12 1/4 (311.2)</p> 
<p>PA30115 Cab Air Element Fits: Case Excavators Replaces: Case KHR27540 Length: 7 29/32 (200.8) Width: 7 3/16 (182.6) Height: 21/32 (16.7)</p> 	<p>PA30122 Panel Air Element Fits: Mercedes-Benz Trucks Replaces: Mercedes-Benz A9608300018 Length: 12 5/16 (312.7) Width: 8 27/32 (224.6) Height: 1 7/16 (36.5)</p> 
<p>RS30116 Radial Seal Outer Air Element Fits: R.V.I. Trucks Replaces: Renault 5001865725; Donaldson P785530 O.D.: 12 3/16 (309.6) I.D.: 6 31/32 (177.0) One End Height: 21 7/8 (555.6)</p> 	<p>PA30123 Cab Air Element Fits: Mercedes-Benz Trucks Replaces: Mercedes-Benz A9608300118 Length: 12 5/16 (312.7) Width: 8 27/32 (224.6) Height: 1 7/16 (36.5)</p> 













Measurements Are Shown In Inches And (Millimeters)

WARNING: These products can expose you to chemicals, including Diisononyl Phthalate, Carbon black extracts, Nickel, 1,3 Butadiene, Ethylene Oxide, Epichlorohydrin, which are known to the State of California to cause cancer, and Bisphenol, Ethylene Glycol, Ethylene Oxide, 1,3 Butadiene, Epichlorohydrin, which are known to the State of California to cause birth defects or other reproductive harm. For more information go to www.P65Warnings.ca.gov.

<p>PA30124 Panel Air Element Fits: Mercedes-Benz Trucks Replaces: Mercedes-Benz 9608300218, A9608300218 Length: 12 5/16 (312.7) Width: 8 27/32 (224.6) Height: 1 7/16 (36.5)</p> 	<p>RS30130 Radial Seal Outer Air Element Fits: Mercedes-Benz Latin American Buses, South American Buses, Trucks, Vans Use With: RS5676 Replaces: Agco 6211381M1; Mercedes-Benz 3760948204, A3760948204 O.D.: 10 7/16 (265.1) I.D.: 5 5/8 (142.9) One End Height: 17 1/4 (438.2)</p> 
<p>PA30125 Air Element Fits: Scania Stationary and Marine Engines Replaces: Scania 1332341; Donaldson B125011; Fleetguard AH8513 O.D.: 12 19/32 (319.9) I.D.: 5 (127.0) One End Height: 10 5/16 (261.9)</p> 	<p>CA30131 Channel Flow EXO Air Element Contains: Three Bolts Included Fits: Freightliner Trucks with Cummins Engines Replaces: Donaldson P621097; Freightliner P621097 O.D.: 12 1/16 (306.4) Flange: 14 27/32 (377.0) Height: 8 3/32 (205.6) A. Gskt: [1] Included</p> 
<p>PA30126 Cab Air Element Fits: Case-International, New Holland Harvesters, Windrowers Replaces: Case 84058793 Length: 20 5/32 (512.0) Width: 6 7/8 (174.6) Height: 1 15/32 (37.3)</p> 	<p>CA30132 Channel Flow EXO Air Element Contains: Four Bolts Included Fits: Freightliner 114SD; Western Star 4700 Trucks with Cummins and Detroit Diesel Engines Replaces: Freightliner P619498; Western Star Truck P619498; Donaldson P634517 O.D.: 12 1/16 (306.4) Flange: 14 27/32 (377.0) Height: 10 (254.0) A. Gskt: [1] Included</p> 
<p>PA30127 Cab Air Element with Pull Tab Fits: Bobcat Utility Vehicles Replaces: Bobcat 6693221 Length: 11 7/32 (285.0) Width: 7 (177.8) Height: 29/32 (23.0) A. Gskt: [2] Attached</p> 	<p>RS30128 Radial Seal Outer Air Element Fits: Donaldson Housings Use With: RS30129 Replaces: Donaldson P786197, X770683; Atlas Copco 3222188161 O.D.: 14 (355.6) I.D.: 9 (228.6) One End Height: 19 7/16 (493.7)</p> 
<p>RS30129 Radial Seal Inner Air Element Fits Inside: RS30128 Fits: Donaldson Housings Replaces: Donaldson P786198, X770683 O.D.: 9 1/32 (229.4) I.D.: 7 1/32 (178.6) One End Height: 17 7/16 (442.9)</p> 	<p>RS30133 Radial Seal Outer Air Element Fits: Blue Bird All American School Buses with Cummins ISB, ISC Engines Use With: RS30134 Replaces: Blue Bird 10013632; Racor 500375001, 500375001BB O.D.: 12 3/8 (314.3) I.D.: 7 11/16 (195.3) One End Height: 20 5/8 (523.9)</p> 
<p>RS30134 Radial Seal Inner Air Element Fits Inside: RS30133 Fits: Blue Bird All American School Buses with Cummins ISB, ISC Engines Replaces: Blue Bird 10013633; Farr 500443001 O.D.: 7 3/16 (182.6) I.D.: 4 13/16 (122.2) One End Height: 20 1/2 (520.7)</p> 	

Measurements Are Shown In Inches And (Millimeters)

WARNING: These products can expose you to chemicals, including Diisononyl Phthalate, Carbon black extracts, Nickel, 1,3 Butadiene, Ethylene Oxide, Epichlorohydrin, which are known to the State of California to cause cancer, and Bisphenol, Ethylene Glycol, Ethylene Oxide, 1,3 Butadiene, Epichlorohydrin, which are known to the State of California to cause birth defects or other reproductive harm. For more information go to www.P65Warnings.ca.gov.

<p>RS30135 Radial Seal Outer Air Element Fits: Atlas Copco Drilling Equipment Use With: RS30136 Replaces: Atlas Copco 3222188151; Donaldson P785590 O.D.: 12 1/8 (308.0) I.D.: 7 (177.8) One End Height: 20 5/8 (523.9)</p> 	<p>RS30142 Radial Seal Air Element Notes: Must use RS30142 KIT on first installation. Contains: Flame Retardant Media Fits: Scania Trucks Replaces: Scania 1869993, 1869995 O.D.: 11 15/16 (303.2) I.D.: 6 19/32 (167.5) One End Height: 18 1/8 (460.4) Related To: RS30142 KIT (with Lid)</p> 
<p>RS30136 Radial Seal Inner Air Element Fits Inside: RS30135 Fits: Atlas Copco Drilling Equipment Replaces: Atlas Copco 3222188154 O.D.: 7 1/16 (179.4) I.D.: 5 3/4 (146.0) One End Height: 18 13/32 (467.5)</p> 	<p>RS30142 KIT Radial Seal Air Element with Lid Notes: Element only is RS30142 Fits: Scania Trucks Replaces: Scania 1868883, 1869995; Baldwin RS5542 O.D.: 11 15/16 (303.2) Lid 14 3/8 (365.1) I.D.: 6 19/32 (167.5) One End Height: 18 1/8 (460.4)</p> 
<p>PA30137 Cab Air Element Fits: Caterpillar Excavators, Material Handlers Replaces: Caterpillar 2931184 Length: 23 3/16 (589.0) Width: 4 1/2 (114.3) Height: 7/8 (22.2)</p> 	<p>RS30143 Radial Seal Air Element Notes: Must use RS30143 KIT (with Lid) on first installation. Contains: Flame Retardant Media Fits: Scania Trucks Replaces: Scania 1728817, 1869992, 1869994; Baldwin RS5671; Donaldson P785519 O.D.: 11 29/32 (302.4) I.D.: 6 5/8 (168.3) One End Height: 21 9/32 (540.5)</p> 
<p>PA30138 Panel Air Element Fits: Industrial Applications Replaces: Airguard DP40-217; Farr 49880008 Length: 19 1/2 (495.3) Width: 9 1/2 (241.3) Height: 1 3/4 (44.4)</p> 	<p>RS30143 KIT Radial Seal Air Element with Lid Notes: Element only is RS30143. Contains: Flame Retardant Media Fits: Scania Trucks Replaces: Scania 1728817, 1869992, 1869994; Baldwin RS5671; Donaldson P785519 O.D.: 11 29/32 (302.4) Lid 15 1/8 (384.2) I.D.: 6 5/8 (168.3) One End Height: 21 9/32 (540.5)</p> 
<p>PA30139 Panel Air Element Fits: Industrial Applications Replaces: CLC Air DP40-220; Farr 049880007, 49880007 Length: 19 1/2 (495.3) Width: 11 1/2 (292.1) Height: 1 3/4 (44.4)</p> 	<p>PA30144 Panel Air Element Fits: Wacker Vibratory Rammers Replaces: Wacker 157193 Length: 6 5/8 (168.3) Width: 3 3/4 (95.3) Height: 2 1/8 (54.0)</p> 
<p>PA30140 Cab Air Element with Pull Tab Fits: Peterbilt 388 with Cummins ISX (11.9L), (15.0L), Paccar MX Engines Replaces: Peterbilt 5S014010; Donaldson P629015 Length: 10 1/32 (254.8) Width: 7 15/16 (201.6) Height: 1 7/32 (31.0)</p> 	<p>PA30145 Outer Air Element Fits: Hyundai R360LC-7A, R450LC-7 Excavators, HL770, HL770-7 Loaders, all with Cummins Engines Use With: PA30146 Replaces: Hyundai 11NB20120, 11NB20120A, 14L101560; Fleetguard AF26664 O.D.: 12 3/32 (307.2) I.D.: 15/16 (23.8) & 7 11/16 (195.3) Height: 21 25/32 (553.2) A. Gskt: [1] Attached</p> 
<p>PA30141 Cab Air Element with Pull Tab Fits: Case Excavators Replaces: Case KHR27260; New Holland KRH27260 Length: 9 1/4 (235.0) Width: 7 7/32 (183.4) Height: 1 13/32 (35.7)</p> 	

Measurements Are Shown In Inches And (Millimeters)

WARNING: These products can expose you to chemicals, including Diisononyl Phthalate, Carbon black extracts, Nickel, 1,3 Butadiene, Ethylene Oxide, Epichlorohydrin, which are known to the State of California to cause cancer, and Bisphenol, Ethylene Glycol, Ethylene Oxide, 1,3 Butadiene, Epichlorohydrin, which are known to the State of California to cause birth defects or other reproductive harm. For more information go to www.P65Warnings.ca.gov.

<p>PA30146 Inner Air Element  Fits Inside: PA30145 Fits: Hyundai R360LC-7A, R450LC-7 Excavators, HL770, HL770-7 Loaders, all with Cummins Engines Replaces: Hyundai 11NB20130, 14L101570; Fleetguard AF27843 O.D.: 7 5/8 (193.7) I.D.: 5/8 (15.9) & 6 1/16 (154.0) Height: 21 (533.4) A. Gskt: [1] Attached</p>	<p>PA30153 Breather Filter  Fits: Volvo Excavators, Loaders Replaces: Volvo 4361204 O.D.: 3 5/32 (80.2) Height: 2 29/32 (73.8)</p>
<p>RS30147 Radial Seal Air Element  Fits: JLG 450AJ, 460SJ, 3394RT, 4394RT Aerial Lifts with Deutz D2.9L4 Engine Replaces: JLG 70003937 O.D.: 4 1/8 (104.8) I.D.: 2 5/16 (58.7) One End Height: 11 21/32 (296.1) I.Gskt: [1] Attached</p>	<p>PA30154 Foam Cab Air Element  Fits: Caterpillar Backhoe/Loaders Replaces: Caterpillar 2067514; Fleetguard AF55756 Length: 8 15/16 (227.0) Width: 2 1/2 (63.5) Height: 3/4 (19.0)</p>
<p>PA30148 Cab Air Element with Pull Tab  Fits: Komatsu Graders Replaces: Komatsu 23B8099310 Length: 8 3/16 (208.0) Width: 4 9/16 (115.9) Height: 19/32 (15.1) A. Gskt: [1] Attached</p>	<p>PA30155 Foam Cab Air Element  Fits: Mercedes/Evobus Citaro Replaces: Mercedes-Benz 18353447; Mann & Hummel CU481110 Length: 18 11/32 (465.9) Width: 8 31/32 (227.8) Height: 25/32 (19.8)</p>
<p>PA30149 Panel Air Element with Foam Pad  Fits: 10/2001-7/2004 Renault Mascott 110 DCI, 130 DCI, 150 DCI with DCI 2.8 Engine Replaces: Renault 5001847123, 5010317300, 7702295409 Length: 12 15/32 (316.7) Width: 10 9/32 (261.1) Height: 2 17/32 (64.3)</p>	<p>PA30156 Cab Air Element  Fits: Dressta, Komatsu Dozers Replaces: Komatsu 4270722130 Length: 11 13/16 (300.0) Width: 7 17/32 (191.3) Height: 25/32 (19.8)</p>
<p>PA30150 Cab Air Element  Fits: Komatsu Excavators Replaces: Komatsu 2A59791551 Length: 8 11/32 (211.9) Width: 7 5/8 (193.7) Height: 1 3/32 (27.8) A. Gskt: [1] Attached</p>	<p>PA30157 Hydraulic Tank Breather  Fits: Komatsu Excavators, Loaders Replaces: Komatsu 4236035460 O.D.: 1 31/32 (50.0) I.D.: 1 13/32 (35.7) Height: 19/32 (15.1)</p>
<p>PA30151 Cab Air Element with Pull Tab  Fits: Kobelco, New Holland Excavators Replaces: New Holland LQ50V01008P1 Length: 9 7/16 (239.7) Width: 7 11/16 (195.3) Height: 1 17/32 (38.9)</p>	<p>PA30158 Air Element  Fits: Donaldson Housings Replaces: Donaldson B105002 O.D.: 10 1/2 (266.7) I.D.: 5 (127.0) One End Height: 15 (381.0)</p>
<p>PA30152 Cab Air Element  Fits: Komatsu Excavators Replaces: Komatsu 2089797740 Length: 7 25/32 (197.6) Width: 4 1/32 (102.4) Height: 3/4 (19.0)</p>	<p>RS30159 Radial Seal Outer Air Element  Fits: Hitachi, John Deere Equipment Use With: RS30160 Replaces: Hitachi 4700940; John Deere AXE42066; Donaldson P608116 O.D.: 9 9/16 (242.9) Flange: 12 3/16 (309.6) I.D.: 7 1/4 (184.2) One End Height: 20 3/8 (517.5)</p>











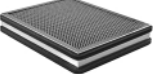

Measurements Are Shown In Inches And (Millimeters)

WARNING: These products can expose you to chemicals, including Diisononyl Phthalate, Carbon black extracts, Nickel, 1,3 Butadiene, Ethylene Oxide, Epichlorohydrin, which are known to the State of California to cause cancer, and Bisphenol, Ethylene Glycol, Ethylene Oxide, 1,3 Butadiene, Epichlorohydrin, which are known to the State of California to cause birth defects or other reproductive harm. For more information go to www.P65Warnings.ca.gov.

<p>RS30160 Radial Seal Inner Air Element Fits Inside: RS30159 Fits: Hitachi, John Deere Equipment Replaces: Donaldson P608391 O.D.: 5 15/16 (150.8) I.D.: 4 9/32 (108.7) One End Height: 19 21/32 (499.3)</p> 	<p>PA30166 Foam Cab Air Element Fits: Freightliner Cascadia Evolution Replaces: Freightliner VCCT1000917R; Donaldson P628395 Length: 9 17/32 (242.1) Width: 6 23/32 (170.7) Height: 1/4 (6.4)</p> 
<p>RS30161 Radial Seal Outer Air Element Fits: John Deere Equipment Use With: RS30162 Replaces: John Deere AN221846; Donaldson P611539 O.D.: 8 1/4 (209.6) Flange 9 31/32 (253.2) I.D.: 5 23/32 (145.3) One End Height: 18 7/8 (479.4)</p> 	<p>RS30168 Radial Seal Outer Air Element Fits: Liebherr-Mobilkrane LTM 1130-5.1 Mobile Cranes Use With: RS30169 Replaces: Hitachi 59004010; Liebherr 10278553; Mann & Hummel C23632/1; Tada 99707015285 O.D.: 8 7/8 (225.4) I.D.: 4 15/16 (125.4) One End Height: 14 (355.6)</p> 
<p>RS30162 Radial Seal Inner Air Element Fits Inside: RS30161 Replaces: John Deere Equipment O.D.: 5 5/16 (134.9) I.D.: 3 11/16 (93.7) One End Height: 17 7/16 (442.9)</p> 	<p>RS30169 Radial Seal Inner Air Element Fits Inside: RS30168 Fits: Liebherr-Mobilkrane LTM 1130-5.1 Mobile Cranes Replaces: Mann & Hummel CF1250 O.D.: 4 1/4 (108.0) I.D.: 3 9/16 (90.5) One End Height: 13 1/4 (336.5)</p> 
<p>PA30163 Conical-Shaped Inner Air Element Fits Inside: PA5584 Fits: Hyster, Yale Equipment Replaces: Donaldson P603729 O.D.: 1 5/16 (33.3) Flange 2 5/8 (66.7) I.D.: 1 3/4 (44.4) One End Height: 10 1/4 (260.3)</p> 	<p>PA30170 Air Element Contains: Threaded Stud Fits: M.T.U. Diesel Engines Replaces: M.T.U. 180945802; Donaldson B120472; Fleetguard AH24332 O.D.: 12 19/32 (319.9) I.D.: 7 27/32 (199.2) One End Height: 17 15/16 (455.6)</p> 
<p>PA30164 Panel Air Element with Pull Tabs Fits: Komatsu Dozers Replaces: Komatsu 12Y9791181 Length: 26 1/16 (662.0) Width: 2 1/2 (63.5) Height: 19/32 (15.1) A. Gskt: [1] Included</p> 	<p>PA30171 Air Element Contains: Threaded Stud Fits: M.T.U. Applications Replaces: M.T.U. 170941202; Donaldson B105036; Hifi/Jura Filtration SAB105036; Mann & Hummel C27040 O.D.: 10 9/16 (268.3) I.D.: 5 1/16 (128.6) One End Height: 16 15/16 (430.2)</p> 
<p>PA30165 Foam Cab Air Element Fits: Freightliner Cascadia Evolution Replaces: Freightliner VCCT1000906J; Donaldson P628394 Length: 9 1/32 (229.4) Width: 5 1/32 (127.8) Height: 1/4 (6.4)</p> 	<p>PA30172 Foam Cab Air Element Fits: Liebherr Dozers, Loaders Replaces: Liebherr 7622972 Length: 14 31/32 (380.2) Width: 9 21/32 (245.3) Height: 1 3/16 (30.2)</p> 
	<p>PA30173 Cab Air Element Fits: Liebherr Dozers, Loaders Replaces: Liebherr 7622130 Length: 9 27/32 (250.0) Width: 7 13/16 (198.4) Height: 25/32 (19.8)</p> 

Measurements Are Shown In Inches And (Millimeters)

WARNING: These products can expose you to chemicals, including Diisononyl Phthalate, Carbon black extracts, Nickel, 1,3 Butadiene, Ethylene Oxide, Epichlorohydrin, which are known to the State of California to cause cancer, and Bisphenol, Ethylene Glycol, Ethylene Oxide, 1,3 Butadiene, Epichlorohydrin, which are known to the State of California to cause birth defects or other reproductive harm. For more information go to www.P65Warnings.ca.gov.

<p>PA30174</p> 	<p>Cab Air Element Fits: John Deere Excavators Replaces: John Deere FYA00001490 Length: 9 19/32 (243.7) Width: 9 1/8 (231.8) Height: 1 5/16 (33.3)</p>	<p>RS30182</p> 	<p>Radial Seal Outer Air Element Fits: New Holland Harvesters Use With: RS30181 Replaces: New Holland 84072431; Donaldson P789638; Fleetguard AF26214 O.D.: 11 1/32 (280.2) I.D.: 5 13/16 (147.6) One End Height: 22 29/32 (581.8)</p>
<p>RS30175</p> 	<p>Radial Seal Air Element Fits: MAN Buses Replaces: M.A.N. 81.08405-0030; Sullair 88291008-318; Donaldson P788716; Fleetguard AF27974 O.D.: 11 3/32 (281.8) I.D.: 7 7/16 (188.9) One End Height: 22 5/32 (562.8)</p>	<p>PA30183</p> 	<p>Cab Air Element Contains: Charcoal Impregnated Media for Odor Control Fits: Caterpillar Loaders Replaces: Caterpillar 3483432 Length: 13 15/32 (342.1) Width: 10 19/32 (269.1) Height: 2 3/16 (55.6) A. Gskt: [2] Attached</p>
<p>PA30177</p> 	<p>Cab Air Element Fits: Case, New Holland Dozers, Motor Graders Replaces: Case 75326979; New Holland 75326979 Length: 10 5/32 (258.0) Width: 6 17/32 (165.9) Height: 27/32 (21.4)</p>	<p>PA30185</p> 	<p>Cab Air Element Fits: Caterpillar Loaders Replaces: Caterpillar 3535058 Length: 15 3/4 (400.0) Width: 6 3/8 (161.9) Height: 2 1/8 (54.0)</p>
<p>PA30179</p> 	<p>Foam Cab Air Element Fits: Caterpillar Loaders, Off-Highway Trucks Replaces: Caterpillar 1868228; Donaldson P505965 Length: 15 5/32 (385.0) Width: 5 23/32 (145.3) Height: 13/32 (10.3)</p>	<p>RS30187XP</p> 	<p>Extreme Performance Nano Radial Seal Outer Air Element Notes: Inside-Out Flow Direction. Contains: Inlet Adapter Fits: Peterbilt 389 Trucks Replaces: Paccar X011623 O.D.: 13 3/32 (332.6) I.D.: 4 5/8 (117.5) & 7 5/8 (193.7) Height: 25 7/8 (657.35) F. Gskt: [1] Included Related To: RS5287XP (Standard Housing Gasket)</p>
<p>RS30180</p> 	<p>Radial Seal Air Element Fits: M.A.N. Lions City C, L LE, GL LE Buses Replaces: M.A.N. 81083040093; Donaldson P782998 O.D.: 9 11/16 (246.1) I.D.: 4 19/32 (116.7) One End Height: 19 5/32 (486.6)</p>	<p>PA30188</p> 	<p>Cab Air Element Fits: R.V.I., Volvo European Trucks Replaces: Renault 5001867491, 7421396525, 7485134455; Volvo 20559447, 21396525, 85134455 Length: 8 (203.2) Width: 3 19/32 (91.3) Height: 3/4 (19.0)</p>
<p>RS30181</p> 	<p>Radial Seal Inner Air Element Fits Inside: RS30182 Fits: Fendt Combines; Massey Ferguson, New Holland Harvesters Replaces: New Holland 84072430; Massey Ferguson D46485600; Donaldson P781203; Fleetguard AF26215 O.D.: 5 29/32 (150.0) I.D.: 4 13/32 (111.9) One End Height: 22 3/32 (561.2)</p>	<p>PA30189</p> 	<p>Air Element with Foam Wrap Contains: Bolt Hole Fits: Robin Engines Replaces: Subaru 26332610A1 O.D.: 6 29/32 (175.4) I.D.: 1/4 (6.4) & 5 9/16 (141.3) Height: 2 15/32 (62.7) Grommets: [1] Attached</p>
		<p>PA30190</p> 	<p>Cab Air Element Fits: Caterpillar Excavators, Forestry Equipment, Hydraulic Power Units, Material Handlers Replaces: Caterpillar 2931183 Length: 23 5/8 (600.1) Width: 4 7/8 (123.8) Height: 1 1/32 (26.2)</p>

Measurements Are Shown In Inches And (Millimeters)

WARNING: These products can expose you to chemicals, including Diisononyl Phthalate, Carbon black extracts, Nickel, 1,3 Butadiene, Ethylene Oxide, Epichlorohydrin, which are known to the State of California to cause cancer, and Bisphenol, Ethylene Glycol, Ethylene Oxide, 1,3 Butadiene, Epichlorohydrin, which are known to the State of California to cause birth defects or other reproductive harm. For more information go to www.P65Warnings.ca.gov.

RS30191 Radial Seal Inner Air Element
Fits Inside: RS30191
Replaces: Reytor IT3098S; Baldwin RS5295; Donaldson P623172; Fleetguard AA2986
O.D.: 6 23/32 (170.7)
I.D.: 6 1/16 (154.0) One End
Height: 15 11/16 (398.5)



CA30201 Channel Flow EXO Primary Air Element with Handles
Fits: Caterpillar Generators, Gen Set Engines, Industrial Engines, Marine Engines
Use With: PA30200 (Secondary Air Element)
Replaces: Caterpillar 2089065; Perkins SEV551H4; Wix WA11036
O.D.: 21 5/8 (549.7)
Height: 11 3/32 (281.7)



RS30192 Radial Seal Outer Air Element
Use With: RS30191
Replaces: Reytor IT3098; Baldwin RS5296; Donaldson P623166; Fleetguard AA2986
O.D.: 11 (279.4)
I.D.: 7 11/16 (195.3) One End
Height: 16 15/16 (430.2)



CA30202 Channel Flow EXO Primary Air Element with Handles
Fits: Caterpillar Generators, Gen Sets, Industrial Engines, Marine Engines
Use With: PA30200 (Secondary Air Element)
Replaces: Caterpillar 2262779; Donaldson P635236; Wix WA10929
O.D.: 21 5/8 (549.7)
Height: 8 3/32 (205.5)



PA30193-FN Outer Air Element with Fins
Fits: Iveco Cursor 87 Engine; Winpower DR250I4 Generator with Iveco Cursor 87 TE1D Engine
Use With: PA30194
Replaces: Iveco 8019342
O.D.: 9 7/32 (234.4)
 Fins 11 11/32 (288.3)
I.D.: 21/32 (16.5) & 4 27/32 (122.9)
Height: 18 1/32 (458.0)
A. Gskt: [1] Included
F. Gskt: [1] Rubber Washer



PA30204 Crankcase Breather
Fits: Volvo Marine Engines
Replaces: Volvo 843736, 876069, 876069-6, 876069-9
O.D.: 3 5/16 (84.1)
I.D.: 1 5/8 (41.3) One End
Height: 6 7/16 (163.5)
F. Gskt: [1] Included



PA30194 Inner Air Element
Fits Inside: PA30193-FN
Fits: Iveco Cursor 87 Engine; Winpower DR250I4 Generator with Iveco Cursor 87 TE1D Engine
Replaces: Iveco 8034304
O.D.: 5 27/32 (148.1)
I.D.: 5/8 (16) & 4 5/32 (105.2)
Height: 17 11/16 (449.3)
A. Gskt: [1] Included
F. Gskt: [1] Rubber Washer



PA30206 Conical-Shaped Air Element
Contains: Flame Retardant Media
Fits: Hyster Lift Trucks
Replaces: Donaldson P616742; Hyster 1620142; Yale 580069337
O.D.: 5 (127.0)
 Flange 6 3/16 (157.2)
I.D.: 3 5/32 (80.2) One End
Height: 13 3/16 (335.0)
A. Gskt: [1] Included



PA30200 Secondary Air Element with Handles
Fits: Caterpillar Generators, Gen Set Engines, Industrial Engines, Marine Engines
Use With: CA30201 (Channel Flow Primary Air Element), CA30202 (Channel Flow Primary Air Element)
Replaces: Caterpillar 2089066; Donaldson P636759; Wix WA10930
O.D.: 19 3/8 (492.5)
Height: 1 19/32 (40.1)
A. Gskt: [1] Included



PA30207 Conical-Shaped Outer Air Element
Fits: John Deere Loaders, Tractors
Use With: PA30208
Replaces: Donaldson P609221; John Deere RE282286
O.D.: 5 1/8 (130.2)
 Flange 6 3/16 (157.2)
I.D.: 3 5/32 (80.2) One End
Height: 13 3/16 (335.0)
A. Gskt: [1] Included













PA30208 Conical-Shaped Inner Air Element
Fits Inside: PA30207
Fits: John Deere Loaders, Tractors
Replaces: Donaldson P608599; John Deere RE282287
O.D.: 2 7/8 (73.0)
 Flange 3 7/8 (98.4)
I.D.: 2 3/8 (60.3) One End
Height: 12 25/32 (324.6)



Measurements Are Shown In Inches And (Millimeters)

WARNING: These products can expose you to chemicals, including Diisononyl Phthalate, Carbon black extracts, Nickel, 1,3 Butadiene, Ethylene Oxide, Epichlorohydrin, which are known to the State of California to cause cancer, and Bisphenol, Ethylene Glycol, Ethylene Oxide, 1,3 Butadiene, Epichlorohydrin, which are known to the State of California to cause birth defects or other reproductive harm. For more information go to www.P65Warnings.ca.gov.

<p>RS30209</p> 	<p>Radial Seal Outer Air Element Fits: Agco, Challenger, Massey Ferguson Tractors Replaces: Agco 3607884M91, 3607884M92; Hifi/Jura Filtration SA16370; Wix WA10404 O.D.: 4 3/16 (106.4) I.D.: 2 (50.8) Height: 10 1/8 (257.2)</p>	<p>RS30220</p> 	<p>Radial Seal Outer Air Element Fits: JLG Industries Inc. 600S, 600SJ, 800A, 800AJ Aerial Lifts with Ford 2.5L Engine; Freeman Balers, John Deere Loaders, Swinger Loaders Use With: RS30221 (John Deere Applications) Replaces: JLG Industries Inc. 70005008; John Deere AT338105 O.D.: 5 5/32 (131.3) I.D.: 3 19/32 (90.9) One End Height: 12 1/2 (317.5)</p>
<p>PA30211</p> 	<p>Air Element Fits: Caterpillar, Mitsubishi Lift Trucks Replaces: Caterpillar 9206107410 O.D.: 5 1/4 (133.4) I.D.: 2 1/32 (16.7) & 4 1/8 (104.8) Height: 11 31/32 (304.0) A. Gskt: [1] Included F. Gskt: [1] Included</p>	<p>RS30221</p> 	<p>Radial Seal Inner Air Element Fits Inside: RS30220 (John Deere Applications) Fits: Freeman Balers, John Deere Loaders, Swinger Loaders Replaces: John Deere AT336803; Donaldson P629465; Wix WA10385 O.D.: 3 3/4 (95.2) 2 13/32 (61.2) I.D.: 2 1/8 (53.6) One End Height: 11 11/32 (288)</p>
<p>RS30212</p> 	<p>Radial Seal Outer Air Element Fits: John Deere Tractors; Massey Ferguson Wheel Tractors; New Holland Tractors Use With: RS30213 Replaces: Agco 6223618M1; Massey Ferguson 6223618M1; John Deere DQ59138, SJ17532; New Holland 87344135; Fleetguard AF25174 O.D.: 6 7/8 (174.5) I.D.: 3 31/32 (101.1) One End Height: 13 31/32 (354.6)</p>	<p>RS30222XP</p> 	<p>Extreme Performance Nano Radial Seal Outer Air Element Fits: Chevrolet, Ford, GMC, Nissan UD Medium-Duty Trucks Use With: RS3501 Replaces: Nissan 16546NY108; Ford Motor Co. F3HZ-9601-A; General Motors Corp. 15619013; John Deere RE34962; Donaldson P812175; Wix 46433NP O.D.: 9 9/32 (236.0) I.D.: 5 5/32 (131.1) One End Height: 12 3/4 (324.1) Related To: RS2863 (Standard Media Version)</p>
<p>RS30213</p> 	<p>Radial Seal Inner Air Element Fits Inside: RS30212 Fits: John Deere Tractors; Massey Ferguson Wheel Tractors; New Holland Tractors Replaces: Agco 6223619M1; John Deere DQ59139; Massey Ferguson 6223619M1; New Holland 87344136; Fleetguard AF25176 O.D.: 4 1/8 (104.9) I.D.: 3 3/8 (85.9) One End Height: 13 7/32 (335.8)</p>	<p>RS30223</p> 	<p>Radial Seal Outer Air Element Fits: Case, New Holland Motor Graders Use With: RS30224 Replaces: Case 84286399 O.D.: 9 21/32 (245.3) I.D.: 5 17/32 (140.5) One End Height: 19 13/32 (492.9)</p>
<p>RS30216</p> 	<p>Radial Seal Outer Air Element Fits: Dynapac Compactors, Rollers Use With: RS30217 Replaces: Atlas Copco 4700394690, 3222188144; Dynapac 394690, 4700394690; Donaldson X770691, P785390 O.D.: 11 (279.4) I.D.: 5 25/32 (146.8) One End Height: 20 11/16 (525.5)</p>	<p>RS30224</p> 	<p>Radial Seal Inner Air Element Fits Inside: RS30223 Fits: Case, New Holland Motor Graders Replaces: Case 84286397; New Holland 84286397 O.D.: 5 11/16 (144.5) I.D.: 5 5/32 (131.0) One End Height: 19 (482.6)</p>
<p>RS30217</p> 	<p>Radial Seal Inner Air Element Fits Inside: RS30216 Fits: Dynapac Compactors, Rollers Replaces: Atlas Copco 4700394691, 3222188144; Dynapac 394691, 4700394691; Donaldson X770691 O.D.: 5 29/32 (150.0) I.D.: 4 7/16 (112.7) One End Height: 18 5/16 (465.1)</p>		

Measurements Are Shown In Inches And (Millimeters)

WARNING: These products can expose you to chemicals, including Diisononyl Phthalate, Carbon black extracts, Nickel, 1,3 Butadiene, Ethylene Oxide, Epichlorohydrin, which are known to the State of California to cause cancer, and Bisphenol, Ethylene Glycol, Ethylene Oxide, 1,3 Butadiene, Epichlorohydrin, which are known to the State of California to cause birth defects or other reproductive harm. For more information go to www.P65Warnings.ca.gov.

RS30225 Radial Seal Outer Air Element
Fits: International, New Holland Tractors
Use With: RS30226
Replaces: New Holland 87741560; Fleetguard AF26345
O.D.: 12 1/16 (306.4)
I.D.: 7 3/4 (196.9) One End
Height: 13 11/16 (347.7)



PA30233-FN Air Element with Fins
Fits: Manitou Lift Trucks
Replaces: Manitou 710467; Fiat 920007502; GPC FC280K; Donaldson P771511
O.D.: 7 15/16 (201.6)
Fins: 9 13/16 (249.2)
I.D.: 2 1/32 (16.7) & 3 9/16 (90.5)
Height: 13 5/8 (346.1)
A. Gskt: [1] Included
F. Gskt: [1] Included



RS30226 Radial Seal Inner Air Element
Fits Inside: RS30225
Fits: International, New Holland Tractors
Replaces: New Holland 87741569; Fleetguard AF26346
O.D.: 7 3/16 (182.6)
I.D.: 5 27/32 (148.4) One End
Height: 12 3/4 (323.8)



RS30234 Radial Seal Air Element
Fits Inside: PA5583
Fits: Bobcat 5600 Turbo, 5610 Utility Vehicles
Replaces: Bobcat 6983022; Donaldson P602427
O.D.: 3 1/16 (77.8)
I.D.: 2 1/16 (52.4) One End
Height: 12 21/32 (321.5)



RS30227 Radial Seal Air Element
Fits: Bobcat, Polaris Utility Vehicles
Replaces: Bobcat 7016038
O.D.: 5 1/2 (139.4)
I.D.: 2 11/32 (59.4) One End
Height: 8 21/32 (219.7)



PA30235 Outer Air Element
Contains: Flame Retardant Media
Fits: Claas, Liebherr, V.M.E., Volvo Equipment; Iveco, M.A.N., Mercedes-Benz Trucks
Use With: PA3494, PA3857
Replaces: Iveco 2996154, 41272534; Mercedes-Benz A0040945004; Donaldson P786829
O.D.: 11 15/16 (303.2)
I.D.: 7/16 (11.1) & 7 17/32 (191.3)
Height: 18 21/32 (473.9)
A. Gskt: [1] Included
F. Gskt: [1] Metal Included
Related To: PA2776 (Standard Media Version)



PA30228 Panel Air Element
Fits: Hyundai Excavators
Replaces: Hyundai 11Q690510
Length: 8 1/4 (209.6)
Width: 4 5/8 (117.5)
Height: 25/32 (19.8)



RS30236 Radial Seal Air Element
Contains: Flame Retardant Media
Fits: R.V.I., Mack Truck
Replaces: Renault 5001865724; Volvo 20732730; Donaldson P786892
O.D.: 9 11/16 (246.1)
I.D.: 4 7/8 (123.8) One End
Height: 14 5/8 (371.5)
Related To: RS5301 (Standard Media Version)



PA30229 Panel Air Element
Fits: Hyundai Excavators
Replaces: Hyundai AM880002002, XJAU0153, 11N690760; Donaldson P753339; Fleetguard AF26474
Length: 9 (228.6)
Width: 4 5/32 (105.6)
Height: 25/32 (19.8)



RS30237 Radial Seal Inner Air Element
Fits Inside: RS5756
Fits: Blue Bird All-American Buses with Cummins ISB (5.9L) Engine
Replaces: Blue Bird 10004114; Parker 500455001
O.D.: 7 1/2 (190.5)
I.D.: 4 1/8 (104.8) One End
Height: 19 13/32 (492.9)



RS30232 Radial Seal Outer Air Element with Blank Band
Fits: Fendt Combines; Massey Ferguson Harvesters; Van Hool Astromega TD927, AG300 Buses
Replaces: Massey Ferguson D46485500; DAF 1146384, 1525439; Van Hool 20276705; Volvo 1155727, 41155727; Donaldson P781199
O.D.: 10 31/32 (278.6)
I.D.: 5 13/16 (147.6) One End
Height: 22 29/32 (581.8)



Measurements Are Shown In Inches And (Millimeters)

WARNING: These products can expose you to chemicals, including Diisononyl Phthalate, Carbon black extracts, Nickel, 1,3 Butadiene, Ethylene Oxide, Epichlorohydrin, which are known to the State of California to cause cancer, and Bisphenol, Ethylene Glycol, Ethylene Oxide, 1,3 Butadiene, Epichlorohydrin, which are known to the State of California to cause birth defects or other reproductive harm. For more information go to www.P65Warnings.ca.gov.

RS30238 Radial Seal Outer Air Element
Fits: Hino Trucks
Use With: RS30239 (Radial Seal Inner Air Element)
Replaces: Hino 178013360, S178013360, S179021140; Donaldson P500176, P503360, P849038, P849078; Fleetguard AF26523; Wix WA10233
O.D.: 8 1/2 (215.6)
I.D.: 4 3/4 (120.6) One End
Height: 13 17/32 (343.7)



RS30239 Radial Seal Inner Air Element
Fits Inside: RS30238 (Radial Seal Outer Air Element)
Fits: Hino Trucks
Replaces: Hino S178013371; Donaldson P503370; Fleetguard AF26521; Wix WA10235
O.D.: 4 11/32 (110.2)
I.D.: 3 5/8 (91.7) One End
Height: 13 1/8 (333.5)



RS30242 Radial Seal Inner Air Element
Replaces: Ingersoll-Rand 35393651
O.D.: 3 15/32 (88.1)
I.D.: 2 1/2 (63.5) One End
Height: 12 9/16 (319.1)



PA30243 Outer Air Element
Fits: Hitachi Excavators; John Deere Excavators
Use With: PA30244
Replaces: Hitachi 4642122; Donaldson P789077; Hifi/Jura Filtration SA18087
O.D.: 9 7/32 (234.2)
I.D.: 5 3/16 (131.8) One End
Height: 14 1/4 (362.0)
A. Gskt: [1] Included



PA30244 Inner Air Element
Fits Inside: PA30243
Fits: Hitachi Excavators; John Deere Excavators
Replaces: Hitachi 4642117; Donaldson P788912
O.D.: 5 5/32 (131.0)
I.D.: 21/32 (16.7) & 3 15/16 (100.0)
Height: 11 1/16 (281.0)
A. Gskt: [1] Included
F. Gskt: [1] Included



PA30249 Cab Air Element
Fits: Caterpillar Loaders, Lift Trucks
Replaces: Caterpillar 3657606; Wix WP10366
Length: 13 19/32 (344.9)
Width: 4 3/4 (120.9)
Height: 2 1/4 (56.9)

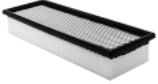

PA30251 Cab Air Element
Contains: Charcoal Impregnated Media for Odor Control.
Fits: John Deere Tractors
Replaces: John Deere L156225, L209778
Length: 7 23/32 (196.1)
Width: 5 1/8 (130.2)
Height: 1 9/16 (39.7)



PA30252 Cab Air Filter
Fits: Kubota Tractors
Replaces: Kubota T185571600
Length: 12 3/16 (309.6)
Width: 4 1/32 (102.4)
Height: 1 11/16 (42.9)
A. Gskt: [1] Included



PA30253 Cab Air Element with Pull Tabs
Fits: Atlas Copco Equipment
Replaces: Atlas Copco 3222325376
Length: 15 1/8 (384.0)
Width: 6 11/16 (169.9)
Height: 2 1/8 (54.1)
A. Gskt: [1] Included

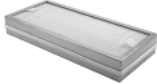

PA30255 Foam Cab Air Element in Plastic Housing
Contains: [3] Metal Clips
Fits: Bobcat Loaders
Replaces: Bobcat 7193354
Length: 12 3/4 (324.1)
Width: 2 5/8 (67.1)
Height: 1 3/16 (30.2)

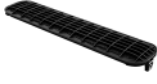

RS30257 Radial Seal Outer Air Element
Fits: Bomag Compactors; Dina Linner, Dina Runner Buses; John Deere Excavators
Use With: RS5329
Replaces: Fleetguard AF26483
O.D.: 8 27/32 (224.5)
I.D.: 7 1/8 (180.8) One End
Height: 16 13/16 (427)



PA30258 Cab Air Element
Fits: Liebherr Equipment
Replaces: Liebherr 10097542
Length: 14 23/32 (373.9)
Width: 13 17/32 (343.9)
Height: 1 3/16 (30)
A. Gskt: [1] Included

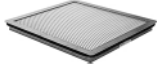

PA30260 Felt Cabin Air Element with Foam Pad
Fits: International 4300, 7300, 7400, 7500, 7500 WorkStar, 7600 WorkStar Trucks
Replaces: IHC (International Harvester) CFFN6100
Length: 15 21/32 (397.3)
Width: 4 11/32 (110)
Height: 1 1/32 (26.4)













Measurements Are Shown In Inches And (Millimeters)

WARNING: These products can expose you to chemicals, including Diisononyl Phthalate, Carbon black extracts, Nickel, 1,3 Butadiene, Ethylene Oxide, Epichlorohydrin, which are known to the State of California to cause cancer, and Bisphenol, Ethylene Glycol, Ethylene Oxide, 1,3 Butadiene, Epichlorohydrin, which are known to the State of California to cause birth defects or other reproductive harm. For more information go to www.P65Warnings.ca.gov.

<p>PA30261 Cab Air Element  Fits: Kubota KX040-4, KX057-4, KX121-3S, KX121-3ST Super Series, U35-4, U45S, U45ST Excavators Kubota SVL75-2C, SV95-2SC Loaders Kubota M100GXDT, M110GXDT, M126GXDT, M135GXDT, M6040 Series, M6-141, M6-141DTC, M7-151, M7-171, M8540 Series, M9960 Series Tract Replaces: Kubota 6A67175090 Length: 7 (177.8) Width: 4 3/4 (120.5) Height: 11/16 (17)</p>	<p>PA30271 Cab Air Element  Fits: New Holland, Versatile Tractors Replaces: Case 9707323 Length: 40 25/32 (1036.1) Width: 8 1/32 (204.0) Height: 2 19/32 (66) A. Gskt: [1] Included</p>
<p>PA30262 Nylon Mesh Screen Cab Air Filter  Fits: Case 1221E, 1221EXR, 1221F Loaders; Hyundai R80-7, R80-7A, R110-7, R110-7A, R140LC-7, R140W-7, R140LC-7A, R140W-7A, R140LC-9, R140W-9, R160LC-7, R160LC-7A, R160LC-9, R170W-7, R170W-7A, R170W-9, R180LC-7, R180LC-7A, R180LC-9, R200W-7, R200W-7A, R210-7 Replaces: Hyundai 11N690770 Length: 7 25/32 (197.6) Width: 7 19/32 (192.9) Height: 13/32 (10.5)</p>	<p>PA30272 Cab Air Element  Fits: Komatsu Loaders Replaces: Komatsu 4230752410 Length: 14 7/32 (361.4) Width: 8 3/8 (212.3) Height: 1 3/16 (30)</p>
<p>PA30263 Panel Air Element  Fits: Polaris Ranger 900 Crew, Ranger 900 XP, Ranger 1000 Diesel, Ranger 1000 Diesel Crew, Ranger Crew 1000 PS, Ranger Crew 1000XP 6P, Ranger Crew 1000XP MD, Ranger Crew 1000XP NB, Ranger Crew 1000XP PS, Ranger Crew 1000XP PS, RZR 570 Utility Vehicles Replaces: Polaris 7081706 Length: 11 7/32 (285.2) Width: 8 3/16 (208) Height: 1 13/16 (46)</p>	<p>RS30273 Radial Seal Outer Air Element  Contains: [1] Grease Packet Fits: Kubota Tractors, Utility Vehicles Use With: RS30274 (Radial Seal Inner Air Element) Replaces: Kubota 1G31911210; Mann & Hummel C10007; Wix WA10428 O.D.: 3 15/16 (100.1) I.D.: 2 1/8 (54.1) One End Height: 7 19/32 (193)</p>
<p>PA30264 Cab Air Element with Pull Tab  Contains: Metal Bracket Fits: Caterpillar Loaders, Tractors Replaces: Caterpillar 1510914 Length: 16 5/8 (421.9) Width: 5 9/16 (141.0) Height: 2 9/16 (65.3) A. Gskt: [1] Included</p>	<p>RS30274 Radial Seal Inner Air Element  Fits Inside: RS30273 (Radial Seal Outer Air Element) Fits: Kubota Tractors, Utility Vehicles Replaces: Kubota K759182360; Wix WA10430 O.D.: 2 1/8 (53.6) I.D.: 1 5/8 (41.4) One End Height: 6 23/32 (170.9) A. Gskt: [1] Included</p>
<p>PA30266 Secondary Air Element  Fits: Case-International, New Holland Tractors Use With: PA30275 Replaces: Caterpillar 3466694; New Holland 73337833 Length: 11 21/32 (295.9) Width: 6 5/8 (167.9) Height: 1 1/2 (38.1)</p>	<p>PA30275 Primary Air Element  Fits: Case-International, New Holland Tractors; Caterpillar Crawler Tractors, Excavators, Forestry Equipment, Loaders, Paving Equipment, Material Handlers; Tong Yang Moolsan Tractors Use With: PA30268 Replaces: Case 73337834; Caterpillar 3466693; New Holland 73337834; Mann & Hummel C34540 O.D.: 8 1/32 (203.7) To 13 7/32 (336.0) Height: 8 11/32 (211.6)</p>
<p>PA30269 Cabin Air Element  Fits: Kenworth Trucks T800, T880 Replaces: Paccar F371018 Length: 8 27/32 (225.0) Width: 7 27/32 (199.0) Height: 13/32 (10.0)</p>	<p>PA30276 Foam Cab Air Element  Fits: Case 521E, 521EXT, 521F Series, 621E, 621E XR, 621E XT, 721E, E21EXR, 721EXT, 821E, 821EXT, 821F, 821FXR, 821FXT, 921E, 921F, 1021F, 1121F Loaders; New Holland W130B, W130B TC, W170B, W170B LR, W170C, W190B, W190C, W230C, W270B Loaders Replaces: Case 76303499, 84389987; New Holland 76303499, 84389987 Length: 16 5/16 (414) Width: 6 1/2 (165) Height: 3/4 (19)</p>
<p>PA30270 Panel Air Element  Fits: Caterpillar Loaders Replaces: Caterpillar 2902288 Length: 14 21/32 (372.1) Width: 3 25/32 (96.0) Height: 1 3/8 (35.1)</p>	

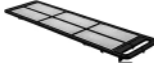
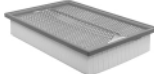
Measurements Are Shown In Inches And (Millimeters)

WARNING: These products can expose you to chemicals, including Diisononyl Phthalate, Carbon black extracts, Nickel, 1,3 Butadiene, Ethylene Oxide, Epichlorohydrin, which are known to the State of California to cause cancer, and Bisphenol, Ethylene Glycol, Ethylene Oxide, 1,3 Butadiene, Epichlorohydrin, which are known to the State of California to cause birth defects or other reproductive harm. For more information go to www.P65Warnings.ca.gov.

<p>PA30277 Foam Cab Air Element Fits: Mack Trucks Replaces: Mack 3543H9638 Length: 10 (254.0) Width: 9 7/8 (251.0) Height: 25/32 (20.1)</p> 	<p>RS30290 Radial Seal Outer Air Element Fits: Caterpillar 374F L, 390F L Excavators; MH3295 Material Handler; PM620, PM622, RM500B Paving Equipment Use With: RS30291 Replaces: Caterpillar 3754301 O.D.: 14 7/32 (360.9) I.D.: 8 29/32 (226.3) One End Height: 26 23/32 (678.9)</p> 
<p>PA30279 Panel Air Element Fits: Honda Small Engines Replaces: Honda 17210ZJ1841, 17210ZJ1842; Oregon 30436; Rotary Gas 10678, 10961; Stens 102164; Wix WA10562 Length: 8 3/4 (222.5) Width: 6 17/32 (166.1) Height: 1 1/4 (32) A. Gskt: [1] Included</p> 	<p>RS30291 Radial Seal Inner Air Element Fits Inside: RS30290 Fits: Caterpillar Excavators, Material Handlers, Paving Equipment. Replaces: Caterpillar 3754302 O.D.: 9 3/32 (231.1) I.D.: 7 1/8 (180.6) One End Height: 26 13/32 (670.8)</p> 
<p>PA30281 Foam Cab Air Element Fits: Kenworth K270 (2014-18), T170 (2019), T270 (2019), T300 (2018-19), T370 (2014-19), T400 (2013-19), T440 (2017-19), T470 (2019), T660 (2014-18) Trucks Replaces: Kenworth SR2000059 Length: 12 3/32 (307) Width: 3 5/32 (80) Height: 31/32 (24.5)</p> 	<p>PA30292 Cab Air Element with Foam Pad and Pull Tabs Fits: John Deere 450H Series, 450J, 550H, 550J, 550J Series, 550K, 650H, 650J, 650J Series, 650K, 700H LGP, 700J Series, 700K, 750J Series, 750K, 850J, 850J Series, 850JR, 850K, 1050K Dozers, Motor Graders; 605K, 655K, 755K Loaders Replaces: John Deere AT315957 Length: 26 1/16 (661.9) Width: 2 15/32 (63.0) Height: 19/32 (15.2) A. Gskt: [1] Included</p> 
<p>RS30282 Radial Seal Outer Air Element Fits: Bobcat Loaders Replaces: Bobcat 6687262; Donaldson P628323; Fleetguard AF26116; Mann+Hummel C10010; Wix WA10405 O.D.: 3 17/32 (89.4) I.D.: 2 9/32 (57.7) Height: 7 5/32 (181.9)</p> 	<p>PA30293 Cab Air Element Fits: Komatsu PC78US-8, PC78UU-8, PC228US-8, PC228USLC-8 Excavators Replaces: Komatsu ND1455301210; Nippon 1455301210 Length: 17 11/16 (449.6) Width: 4 13/16 (121.9) Height: 19/32 (15)</p> 
<p>PA30284 Air Element Fits: Cummins X3.3 Generator Engine Replaces: Cummins 1404157; Fleetguard AF26044 O.D.: 6 1/2 (165.4) I.D.: 1 31/32 (50.0) Height: 5 7/32 (132.3)</p> <p>Image Not Available.</p>	<p>PA30299 Cab Air Element Fits: Caterpillar 1450, 1450AL, 1450CWS, 1450WTS, 1470, 1550 CWS, 1550 WTS. 1570, 2054, 2056, 2058, 2064, 2066, W330 Combines; 6610, 6650, 6710, 6750, 6810, 6850, 6910, 6950 Forage Harvesters Replaces: John Deere AZ43412 Length: 14 3/4 (374.9) Width: 9 9/16 (243.1) Height: 2 27/32 (71.9)</p> 
<p>RS30285 Radial Seal Outer Air Element Fits: Perkins Generators Use With: RS5392 Replaces: Perkins 2652C831 O.D.: 10 31/32 (278.9) I.D.: 5 25/32 (147.1) One End Height: 16 7/16 (417.6)</p> 	<p>PA30301 Air Element Fits: Gardner Denver, Ingersoll-Rand, Schramm Air Compressors Replaces: Gardner Denver 2010945; Ingersoll-Rand W104069; Schramm OUH37810A; WIX 46063 O.D.: 4 7/16 (112.7) I.D.: 2 13/16 (71.4) Height: 4 1/2 (114.3)</p> 
<p>PA30287 Foam Cab Air Element Fits: Kenworth W900 Trucks Replaces: Kenworth R19501 Length: 8 3/16 (208.0) Width: 6 1/32 (153.4) Height: 1 3/16 (30)</p> 	

Measurements Are Shown In Inches And (Millimeters)

WARNING: These products can expose you to chemicals, including Diisononyl Phthalate, Carbon black extracts, Nickel, 1,3 Butadiene, Ethylene Oxide, Epichlorohydrin, which are known to the State of California to cause cancer, and Bisphenol, Ethylene Glycol, Ethylene Oxide, 1,3 Butadiene, Epichlorohydrin, which are known to the State of California to cause birth defects or other reproductive harm. For more information go to www.P65Warnings.ca.gov.

PA30302 Air Element

Fits: Tecumseh Engines
Replaces: Lauson-Tecumseh 35066; Wix 542419, 42419
O.D.: 1 25/32 (45.2)
I.D.: 13/16 (20.6)
Height: 2 7/8 (73)

RS30308 Radial Seal Inner Air Element

Fits Inside: RS30307
Replaces: Kamaz CF1820; Mann+Hummel CF1820; Pozarli AV785
O.D.: 7 3/32 (179.8)
I.D.: 6 3/8 (161.8) One End
Height: 17 1/2 (444.5)
O-Ring: [1] Attached

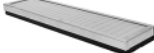
PA30303 Oblong Air Element

Fits: Briggs & Stratton Engines
Replaces: Briggs & Stratton 393292; Wix 46176
O.D.: 3 27/32 (97.6) to 9 11/16 (246.1)
I.D.: 2 11/32 (59.5) & 8 3/16 (208.0) to
Height: 2 1/2 (63.5)

PA30309 Replacement for Ecolite Air Element in Disposable Housing

Replaces: Racor 400820020
O.D.: 11 (279.4)
Inlet: 7
Outlet: 7 3/32
Height: 16 5/8 (422.7)

PA30304 Cab Air Element

Fits: Case Loaders; New Holland Loaders, Telehandlers, Trenchers
Replaces: Case 84376814; Wix WP10360
Length: 16 15/16 (430.0)
Width: 4 11/32 (110.0)
Height: 1 3/16 (30)
A. Gskt: [1] Included

PA30310 Cab Air Element with Pull Tabs

Fits: Caterpillar Loaders, Crawler Tractors
Replaces: Caterpillar 3293243; Wix WP10237
Length: 9 21/32 (245.1)
Width: 6 1/2 (165.1)
Height: 1 (25.7)
A. Gskt: [1] Included

RS30305 Radial Seal Outer Air Element

Fits: Claas Tractors; Iveco Buses; Tadano Cranes; Wirtgen Paving Equipment
Use With: RS30306
Replaces: Claas 05006151; GPC FC2247; Iveco 42553413; Mann+Hummel C301530; Mercedes-Benz A0040943704, 40943704; Power System 490031, 480031; Pozarli AJ159; Wirtgen 182496; Fleetguard AF4185
O.D.: 11 11/16 (297.2)
I.D.: 7 27/32 (198.9) One End
Height: 22 3/16 (563.6)

RS30311 Radial Seal Outer Air Element

Fits: New Holland Harvesters
Replaces: Case 84443964; New Holland 84443964; Donaldson P786106; Fleetguard AF27952; Wix WA10761
O.D.: 12 9/32 (311.9)
I.D.: 6 15/16 (176.5) One End
Height: 28 1/32 (712.0)

RS30306 Radial Seal Inner Air Element

Fits Inside: RS30305
Fits: Claas Tractors; Neoplan Buses; Wirtgen Paving Equipment
Replaces: Claas 005006161, 500616, 500616.1; Liebherr 11291030; Mann+Hummel CF1830; M.A.N. 81.08405-0028; Mercedes-Benz A0040943904, 40943904; Pozarli AJ169; Sullair 88291008-317; Wirtgen 182497; Fleetguard AF27973; Wix 49169
O.D.: 7 3/32 (179.8)
I.D.: 6 3/8 (161.8) One End
Height: 20 1/16 (509.5)
O-Ring: [1] Attached











RS30313 Radial Seal Outer Air Element

Fits: Blue Bird All-American Buses
Replaces: Blue Bird 10004112; Racor 10004112; Fleetguard AF4335; Wix WA10653
O.D.: 11 9/16 (293.9)
I.D.: 5 13/16 (147.6) One End
Height: 16 3/4 (425.2)

RS30307 Radial Seal Outer Air Element

Fits: Liebherr Dump Trucks, Excavators; Terex Loaders
Use With: RS30308
Replaces: Liebherr 10278562; Mann+Hummel C301330
O.D.: 11 11/16 (297.2)
I.D.: 7 27/32 (198.9) One End
Height: 19 5/8 (498.6)

PA30314 Air Element in Disposable Housing

Fits: Mobile and Stationary Gas and Diesel Engines
Replaces: Farr 071338005, 71338005; Racor 071338005, 71338005; Fleetguard AH1195
O.D.: 13 1/2 (343.2)
I.D.: 7 1/16 (179.6) One End
Height: 16 5/8 (421.9)

Measurements Are Shown In Inches And (Millimeters)

WARNING: These products can expose you to chemicals, including Diisononyl Phthalate, Carbon black extracts, Nickel, 1,3 Butadiene, Ethylene Oxide, Epichlorohydrin, which are known to the State of California to cause cancer, and Bisphenol, Ethylene Glycol, Ethylene Oxide, 1,3 Butadiene, Epichlorohydrin, which are known to the State of California to cause birth defects or other reproductive harm. For more information go to www.P65Warnings.ca.gov.

<p>PA30315</p>  <p>Air Element in Disposable Housing Fits: Mobile and Stationary Gas and Diesel Engines Replaces: Racor 71338007; Fleetguard AH19056 O.D.: 11 1/32 (279.9) I.D.: 7 3/32 (179.8) One End Height: 25 11/16 (652.3)</p>	<p>PA30320</p>  <p>Air Element in Disposable Housing Fits: Custom Applications Replaces: Racor 400820021 O.D.: 11 (279.4) Inlet: 6.09 Outlet: 7.00 Height: 16 7/8 (428.2)</p>
<p>PA30316</p>  <p>Air Element in Disposable Housing Fits: Custom Applications Replaces: Racor 071338013, 71338013 O.D.: 13 1/2 (343.2) I.D.: 8 1/16 (204.7) One End Height: 25 29/32 (658.1)</p>	<p>PA30321</p>  <p>Air Element in Disposable Housing Fits: Mobile and Stationary Gas and Diesel Engines Replaces: Racor 400820026 O.D.: 6 25/32 (172.5) Inlet: 6 Outlet: 6 Height: 20 (508)</p>
<p>PA30317</p>  <p>Air Element in Disposable Housing Fits: Mobile and Stationary Gas and Diesel Engines Replaces: Racor 062891010, 62891010 O.D.: 13 1/2 (343.2) Inlet: 7 Outlet: 7 Height: 15 1/32 (381.8)</p>	<p>PA30322</p>  <p>Air Element in Disposable Housing Fits: Blue Bird Wanderlodge buses with Detroit Diesel Series 60 Engine Replaces: Farr 99842007; Wix 49998 O.D.: 13 1/2 (342.6) Inlet: 7 Outlet: 7 Height: 18 (457.5)</p>
<p>PA30318</p>  <p>Air Element in Disposable Housing Fits: Custom Applications Replaces: Racor 062891012, 62891012 O.D.: 11 (279.4) Inlet: 7.08 Outlet: 7.00 Height: 19 17/32 (496.1)</p>	<p>PA30323</p>  <p>Air Element in Disposable Housing Fits: Mobile and Stationary Gas and Diesel Engines Replaces: Farr 76955000; Racor 076955000 O.D.: 13 1/2 (343.2) Inlet: 10 Outlet: 8 1/16 Height: 25 7/8 (657.4)</p>
<p>PA30319</p>  <p>Air Element in Disposable Housing Fits: Small Mobile and Stationary Engines for under the hood or outside, direct or remote applications Replaces: Racor 124923000 O.D.: 11 1/32 (279.9) Inlet: 7 Outlet: 7 3/32 Height: 25 23/32 (653.5)</p>	<p>PA30324</p>  <p>Cab Air Element Contains: Charcoal Impregnated Media for Odor Control. Fits: Case Loaders; New Holland Loaders, Telehandlers, Trenchers Replaces: Case 84376815 Length: 16 15/16 (430.0) Width: 4 11/32 (110.0) Height: 1 3/16 (30) A. Gskt: [1] Included</p>
	<p>PA30325</p>  <p>Cab Air Element Fits: Mack Anthem, Granite Pinnacle Trucks Replaces: Mack 85151124, 85112361; Donaldson P636368; Wix WP10278 Length: 9 7/8 (251.0) Width: 9 13/16 (249.5) Height: 1 (25.2)</p>

Measurements Are Shown In Inches And (Millimeters)

WARNING: These products can expose you to chemicals, including Diisononyl Phthalate, Carbon black extracts, Nickel, 1,3 Butadiene, Ethylene Oxide, Epichlorohydrin, which are known to the State of California to cause cancer, and Bisphenol, Ethylene Glycol, Ethylene Oxide, 1,3 Butadiene, Epichlorohydrin, which are known to the State of California to cause birth defects or other reproductive harm. For more information go to www.P65Warnings.ca.gov.

RS30327 Radial Seal Outer Air Element
Fits: Custom applications using Donaldson 15 inch ERB2 air housing
Use With: RS30328
Replaces: Donaldson P785426, X770687; Fleetguard AF4271; Wix WA10668
O.D.: 12 3/32 (306.8)
I.D.: 7 (177.5) One End
Height: 22 15/16 (582.4)



PA31000 Primary EnduraPanel Air
Fits: Cummins QSB6.7 (Final Tier 4, Interim Tier 4), QSC, QSC9, QSL9 (Final Tier 4, Interim Tier 4) Engines
Use With: PA31001 Secondary EnduraPanel
Replaces: Cummins 5261250; Fleetguard AF55015
Length: 11 23/32 (297.7)
Width: 10 31/32 (278.6)
Height: 14 1/16 (357.2)
A. Gskt: [1] Included



RS30328 Radial Seal Inner Air Element
Fits Inside: RS30327
Fits: Custom applications using Donaldson 15 inch ERB2 air housing
Replaces: Donaldson P785427, X770687; Wix WA10669
O.D.: 7 1/16 (179.3)
I.D.: 5 11/16 (144.8) One End
Height: 21 3/32 (535.7)



PA31001 Secondary EnduraPanel Air with Pull Tabs
Fits: Cummins QSB6.7 (Final Tier 4, Interim Tier 4), QSC, QSC9, QSL9 (Final Tier 4, Interim Tier 4) Engines
Use With: PA31000 Primary EnduraPanel
Replaces: Doosan 40050400030; Fleetguard AF55309
Length: 11 5/16 (287.3)
Width: 10 1/2 (266.7)
Height: 1 1/2 (38.1)
A. Gskt: [1] Included



PA30329 Cab Air Element
Fits: Komatsu Loaders
Replaces: Komatsu 4230752440
Length: 13 25/32 (350.0)
Width: 8 3/8 (212.6)
Height: 1 23/32 (43.9)

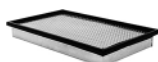

PA31002 Primary EnduraPanel Air
Notes: Can be used with PA31003
Fits: Cummins QSB6.7 (Tier 4 Interim & Final), QSL9 (Tier 4 Interim & Final), QSX11.9, QSX15 (Interim Tier 4) Engines
Replaces: Cummins 5261249; Fleetguard AF55014; Voegele 2216429; Wirtgen 2220358; Donaldson DBA5292
Length: 15 31/32 (405.6)
Width: 5 7/8 (149.2)
Height: 14 (355.6)
A. Gskt: [1] Included



PA30330 Cab Air Element
Fits: Mack LR613 with MP7 Engine (To 2017)
Replaces: Mack 82745222
Length: 13 15/16 (354.1)
Width: 6 1/8 (155.4)
Height: 31/32 (24.9)



PA31003 Secondary EnduraPanel Air with Pull Tabs
Fits: Cummins QSB6.7 (Tier 4 Interim & Final), QSL9 (Tier 4 Interim & Final), QSX11.9, QSX15 (Interim Tier 4) Engines
Use With: PA31002, PA31012
Replaces: Cummins 5261251; Doosan 40050400048; Fleetguard AF55308; JCB 333E3686; Wirtgen 2220366; Voegele 2216432; Donaldson P633483, X011872
Length: 15 1/4 (387.3)
Width: 5 1/4 (133.4)
Height: 1 15/32 (37.3)
A. Gskt: [1] Included



PA30331 Cab Air Element
Fits: Bobcat Excavators, Loaders
Replaces: Bobcat 7176099
Length: 9 1/4 (235.0)
Width: 2 23/32 (69.3)
Height: 31/32 (24.9)

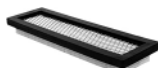

PA30332 Cab Air Element with Pull Tabs
Fits: Case Loaders
Replaces: Case 47880728; Denso 5W0222500; Micronair AK450290
Length: 15 1/32 (382.0)
Width: 5 3/16 (132.1)
Height: 1 3/16 (30)

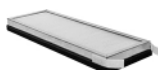

PA30333 Cab Air Element with Pull Tabs
Fits: Caterpillar Excavators
Replaces: Caterpillar 4886446
Length: 14 7/8 (378.0)
Width: 8 1/8 (206.2)
Height: 3 (75.9)
A. Gskt: [2] Included













PA31004 Primary EnduraPanel Air
Notes: Can be used with PA31007 & PA31005
Fits: Cummins QSF 3.8 (Final Tier 4), QSB4.5 (Final Tier 4), QSF2.8 Naturally Aspirated (Tier 4), QSF2.8 Turbo (Tier 3), QSF 2.8 (Final Tier 4) Engines
Replaces: Fleetguard AF55020; JLG Industries Inc. 70024177; Doosan 46595499
Length: 9 1/8 (231.8)
Width: 7 19/32 (192.9)
Height: 9 7/8 (250.8)
A. Gskt: [1] Included













Measurements Are Shown In Inches And (Millimeters)

WARNING: These products can expose you to chemicals, including Diisononyl Phthalate, Carbon black extracts, Nickel, 1,3 Butadiene, Ethylene Oxide, Epichlorohydrin, which are known to the State of California to cause cancer, and Bisphenol, Ethylene Glycol, Ethylene Oxide, 1,3 Butadiene, Epichlorohydrin, which are known to the State of California to cause birth defects or other reproductive harm. For more information go to www.P65Warnings.ca.gov.





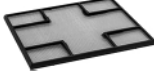

<p>PA31005</p> 	<p>Secondary EnduraPanel Air Contains: Foam Media Fits: Cummins QSF 3.8 (Final Tier 4), QSB4.5 (Final Tier 4), QSF2.8 Naturally Aspirated (Tier 4), QSF2.8 Turbo (Tier 3), QSF 2.8 (Final Tier 4) Engines Use With: PA31004 and PA31006 w/ MAF Sensor. Replaces: Agco 700738184; Fleetguard AF55312; JLG Industries Inc. 70024176 Length: 8 7/8 (225.4) Width: 6 31/32 (177.0) Height: 1 7/16 (36.5) A. Gskt: [1] Included</p>	<p>PA31010</p> 	<p>Primary EnduraPanel Air Fits: Bobcat Loaders Various Models, Telescopic Handlers with Doosan Engines Use With: PA31011 Replaces: Bobcat 7286652, 7010030 Length: 11 3/8 (288.9) Width: 10 7/16 (265.1) Height: 6 19/32 (167.5) A. Gskt: [1] Included</p>
<p>PA31006</p> 	<p>Primary EnduraPanel Air Notes: Can be used with PA31007 & PA31005 Fits: Cummins QSF 3.8 (Final Tier 4), QSB4.5 (Final Tier 4), QSF2.8 Naturally Aspirated (Tier 4), QSF2.8 Turbo (Tier 3), QSF 2.8 (Final Tier 4) Engines Replaces: Fleetguard AF55021; Cummins 5288553; JLG Industries Inc. 70024175 Length: 9 3/32 (231.0) Width: 7 19/32 (192.9) Height: 13 3/4 (349.3) A. Gskt: [1] Included</p>	<p>PA31011</p> 	<p>Secondary EnduraPanel Air Fits: Bobcat Loaders Various Models, Telescopic Handlers with Doosan Engines Use With: PA31010 Replaces: Bobcat 7010031 Length: 10 7/16 (265.1) Width: 5 15/32 (138.9) Height: 1 1/2 (38.1) A. Gskt: [1] Included</p>
<p>PA31007</p> 	<p>Secondary EnduraPanel Air Element with Pull Tabs Fits: Cummins QSF 3.8 (Final Tier 4), QSB4.5 (Final Tier 4), QSF2.8 Naturally Aspirated (Tier 4), QSF2.8 Turbo (Tier 3), QSF 2.8 (Final Tier 4) Engines Use With: PA31004 & PA31006 w/o MAF Sensor Replaces: Fleetguard AF55320; Cummins 5310325 Length: 9 (228.6) Width: 6 31/32 (177.0) Height: 1 7/16 (36.5) A. Gskt: [1] Included</p>	<p>PA31012</p> 	<p>Primary EnduraPanel Air Notes: Can be used with PA31003 Secondary Fits: Cummins QSB6.7 (Final Tier 4, Interim Tier 4, Tier 4), QSL9 Engines Replaces: Cummins 5261248; Fleetguard AF55005 Length: 16 1/8 (409.6) Width: 5 27/32 (148.4) Height: 10 1/32 (254.8) A. Gskt: [1] Included</p>
<p>PA31008</p> 	<p>Primary EnduraPanel Air Fits: Cummins QSM 12, QSX15 (Final Tier 4) Engines Use With: PA31009 Replaces: Fleetguard AF55024; Wirtgen 2392907 Length: 15 7/32 (386.3) Width: 6 5/32 (156.2) Height: 15 1/8 (384.6) A. Gskt: [1] Included</p>	<p>PA31013</p> 	<p>Primary EnduraPanel Air Element Fits: Bobcat Loaders Use With: PA31014 Replaces: Bobcat 7221933, 7286322 Length: 6 5/32 (156.5) Width: 5 27/32 (148.6) Height: 9 9/32 (236) A. Gskt: [1] Included</p>
<p>PA31009</p> 	<p>Secondary EnduraPanel Air with Pull Tabs Fits: Cummins Engines; John Deere Tractors Use With: PA31008, PA31015 Replaces: Fleetguard AF55318; John Deere R344420, RE580948, RE594852 Length: 15 1/8 (383.8) Width: 5 25/32 (146.6) Height: 1 31/32 (50.3) A. Gskt: [1] Included</p>	<p>PA31014</p> 	<p>Secondary EnduraPanel Air Element with Pull Tabs Fits: Bobcat Loaders Use With: PA31013 Replaces: Bobcat 7221934 Length: 5 11/16 (144.3) Width: 5 7/16 (138.4) Height: 1 7/16 (36.8) A. Gskt: [1] Included</p>
		<p>PA31015</p> 	<p>Primary EnduraPanel Air Element Fits: John Deere Tractors Use With: PA31009 Replaces: John Deere R553819, R344419, RE580948, RE594852 Length: 15 1/8 (384.5) Width: 6 5/32 (156.2) Height: 15 31/32 (405.9) A. Gskt: [1] Attached</p>

Measurements Are Shown In Inches And (Millimeters)

WARNING: These products can expose you to chemicals, including Diisononyl Phthalate, Carbon black extracts, Nickel, 1,3 Butadiene, Ethylene Oxide, Epichlorohydrin, which are known to the State of California to cause cancer, and Bisphenol, Ethylene Glycol, Ethylene Oxide, 1,3 Butadiene, Epichlorohydrin, which are known to the State of California to cause birth defects or other reproductive harm. For more information go to www.P65Warnings.ca.gov.

<p>PA32000 EnduraCube Air Element Fits: Kenworth Trucks T680, T800, T880, Peterbilt Trucks 567, 579 Replaces: Paccar P621725 Length: 19 1/32 (483.1) Width: 8 13/32 (213.4) Height: 12 3/16 (309.4) A. Gskt: [1] Included</p> 	<p>P40001 Lube Element Fits: 2014-15 Freightliner Sprinter, Mercedes-Benz E250, GLK250 Sprinter, all with 4-2143cc (2.1L) FI Turbo Diesel Engine Replaces: Mercedes-Benz 6511800109 O.D.: 2 9/16 (65.1) I.D.: 1 7/32 (31.0) Height: 4 17/32 (115.1) A. Gskt: [2] Attached O-Ring: [3] Included</p> 
<p>PA32001 Primary EnduraCube Air Element Notes: Can be used with PA32004 Secondary EnduraCube Fits: International 4300, 4300LP, 4400, 4400 DuraStar, TerraStar Trucks with Cummins ISB (6.7L), ISL (8.9L), L9; MaxxForte 7 (6.4L), 9 (9.3L), DT (7.6L) Engines Replaces: IHC 2517298C1, 2602212C1 Length: 10 13/16 (274.6) Width: 10 (254.0) Height: 8 3/32 (205.6) A. Gskt: [1] Included</p> 	<p>P40002 Lube Element Contains: By-Pass Valve Fits: Yamaha YZ250F, YZ450F, WR250R Motorcycles Replaces: Yamaha 5TA1344000 O.D.: 1 1/2 (38.1) I.D.: 17/32 (13.5) One End Height: 1 27/32 (46.8) End Seals: [2] Attached</p> 
<p>PA32002 EnduraCube Air Element Fits: Freightliner 122SD, Cascadia, Coronado, Coronado SD; Western Star 5700XE, 6900XD Trucks Replaces: Freightliner 336867002, 336867010; Donaldson P629641 Length: 26 7/32 (665.7) Width: 9 5/8 (244.3) Height: 10 1/2 (267) A. Gskt: [1] Included</p> 	<p>P40003 Lube Element Fits: Mercedes-Benz European Light-Duty Trucks Replaces: Mercedes-Benz 9361800009, 9361840225, A9361800009, A9361840225 O.D.: 3 1/2 (88.9) I.D.: 1/2 (12.7) & 1 5/8 (41.3) Height: 8 3/16 (208.0) O-Ring: [1] Included</p> 
<p>PA32003 EnduraCube Air Element Fits: Kenworth T680, T800; Peterbilt 579 Trucks Replaces: Paccar P621730; Donaldson P637454 Length: 19 1/32 (483.1) Width: 8 13/32 (213.4) Height: 7 9/32 (184.7) A. Gskt: [1] Included</p> 	<p>C40004 By-Pass Lube Sock Fits: Massey Ferguson Applications Replaces: Massey Ferguson 1013890M1 O.D.: 3 1/8 (79.4) I.D.: 27/32 (21.4) & 15/16 (23.8) Height: 9 5/8 (244.5) A. Gskt: [1] Included F. Gskt: [1] Included Related To: Related to BF825 (Can-Type Version)</p> 
<p>PA32004 Secondary EnduraCube Air Element Fits: International 4300, 4300LP, 4400, 4400 DuraStar, TerraStar Trucks with Cummins ISB (6.7L), ISL (8.9L), L9; MaxxForte 7 (6.4L), 9 (9.3L), DT (7.6L) Engines Use With: PA32001 Primary EnduraCube Replaces: IHC 2602211C1 Length: 8 21/32 (219.9) Width: 7 23/32 (196.1) Height: 11/32 (8.7)</p> 	<p>C40005 By-Pass Lube Sock Fits: Massey Ferguson Applications Replaces: Massey Ferguson 1501049M91 O.D.: 3 5/32 (80.2) I.D.: 5/8 (15.9) & 27/32 (21.4) Height: 6 7/8 (174.6) A. Gskt: [1] Included F. Gskt: [1] Included</p> 
<p>B40000 Lube Spin-on Fits: 2013-on Chevrolet Spark L4 with 1.2L Engine Replaces: General Motors 96985730 Thread: M18 x 1.5 O.D.: 2 25/32 (70.6) Height: 2 13/16 (71.4) I.Gskt: [1] Included</p> 	<p>B40006 Lube Spin-on Fits: Blaw Knox Paving Equipment Replaces: Blaw Knox 11241400 Thread: 3/4 -16 O.D.: 3 1/16 (77.8) Height: 3 1/2 (88.9) I.Gskt: [1] Included</p> 

Measurements Are Shown In Inches And (Millimeters)
WARNING: These products can expose you to chemicals, including Diisononyl Phthalate, Carbon black extracts, Nickel, 1,3 Butadiene, Ethylene Oxide, Epichlorohydrin, which are known to the State of California to cause cancer, and Bisphenol, Ethylene Glycol, Ethylene Oxide, 1,3 Butadiene, Epichlorohydrin, which are known to the State of California to cause birth defects or other reproductive harm. For more information go to www.P65Warnings.ca.gov.

<p>BC40007</p> 	<p>Centrifugal By-Pass Lube Element Fits: 10/07-on Ford Transit 3.2 TDCI European Light-Duty Vehicles Replaces: Ford 1372808 O.D.: 3 1/4 (82.6) I.D.: 1/4 (6.4) & 5/16 (7.9) Height: 2 11/16 (68.3) A. Gskt: [2] Copper Washers O-Ring: [1] Included</p>	<p>B40013</p> 	<p>Lube Spin-on Replaces: Alliance ABPN-10G-P550367 Thread: M36 x 1.5 O.D.: 5 11/32 (135.7) Height: 12 7/32 (310.4) I.Gskt: [1] Included</p>
<p>P40008</p> 	<p>Lube Element Contains: Offset By-Pass Pin Fits: 2013-on DAF Trucks with Paccar MX 11 Euro 6 Engine Replaces: DAF 1928868 O.D.: 4 1/4 (108.0) I.D.: 5/8 (15.9) & 1 11/16 (42.9) Height: 10 1/4 (260.3) O-Ring: [2] Included</p>	<p>P40014</p> 	<p>Lube Element Fits: Volkswagen Fox, Polo MK4, MK5 Automotive, Light-Duty Trucks Replaces: Volkswagen 3D198819A O.D.: 2 1/2 (63.5) I.D.: 1 3/8 (34.9) Height: 2 9/16 (65.1) O-Ring: [1] Included</p>
<p>BC40009</p> 	<p>Centrifugal Lube Element Fits: 2013-on DAF Trucks with Paccar MX11 Euro 6 Engine Replaces: DAF 1928869 O.D.: 3 7/8 (98.4) I.D.: 3/8 (9.5) & 1 1/4 (31.8) Height: 5 3/8 (136.5) O-Ring: [2] Included</p>	<p>BT40015</p> 	<p>Air Breather Spin-on Fits: Caterpillar Excavators, Loaders, Off-Highway Trucks Replaces: Caterpillar 9C4937 Thread: 3/8 -18 NPT O.D.: 3 (76.2) Height: 2 25/32 (70.6)</p>
<p>P40010</p> 	<p>Lube Element Fits: 2012-13 Audi A5, 2013 A4, 2015 A3, S3; 2014-15 Volkswagen Beetle, Jetta, Passat, 2015 Golf, GTI Replaces: Volkswagen 6K115562, 6L115562 O.D.: 2 1/16 (52.4) I.D.: 15/16 (23.8) Height: 4 13/32 (111.9) O-Ring: [1] Included</p>	<p>P40017</p> 	<p>Lube Element Fits: Mercedes-Benz European Trucks, Vans Replaces: Mercedes-Benz A9341800009, A9341840225, 9341800009 O.D.: 3 1/2 (88.9) I.D.: 1/2 (12.7) & 1 5/8 (41.3) Height: 6 1/32 (153.2) A. Gskt: [1] Attached O-Ring: [1] Included</p>
<p>P40011</p> 	<p>Lube Element Fits: Gehl, Schramm Compressors Replaces: Schramm COUB2295 O.D.: 3 9/32 (83.3) I.D.: 1 1/16 (27.0) Height: 4 1/16 (103.2) F. Gskt: [1] Included End Seals: [2] Attached</p>	<p>P40019</p> 	<p>Lube Element Fits: DAF, Kenworth, Peterbilt Trucks Replaces: DAF 1629393, 1643070; Coopers LEF5207; Donaldson P550812; Fleetguard LF16233 O.D.: 4 7/16 (112.7) I.D.: 2 (50.8) Height: 8 11/16 (220.7) A. Gskt: [2] Attached F. Gskt: [1] Included</p>
<p>P40012</p> 	<p>By-Pass Lube Element with Lift Tab Fits: Massey-Harris Tractors with Continental Engines Replaces: Massey Ferguson 760999M1 O.D.: 3 15/16 (100.0) I.D.: 7/8 (22.2) Height: 6 3/32 (154.8) A. Gskt: [2] Attached F. Gskt: [1] Included</p>	<p>P40020</p> 	<p>Lube Element Fits: Fendt Tractors Replaces: Deutz 4505597; Fendt F836200510010 O.D.: 3 9/32 (83.3) I.D.: 3/8 (9.5) & 1 3/8 (34.9) Height: 5 11/32 (135.7) O-Ring: [1] Included</p>

Measurements Are Shown In Inches And (Millimeters)

WARNING: These products can expose you to chemicals, including Diisononyl Phthalate, Carbon black extracts, Nickel, 1,3 Butadiene, Ethylene Oxide, Epichlorohydrin, which are known to the State of California to cause cancer, and Bisphenol, Ethylene Glycol, Ethylene Oxide, 1,3 Butadiene, Epichlorohydrin, which are known to the State of California to cause birth defects or other reproductive harm. For more information go to www.P65Warnings.ca.gov.

P40021 Lube Element
Fits: Isuzu Engines, Trucks
Replaces: Isuzu 8980188580
O.D.: 2 19/32 (65.9)
I.D.: 7/16 (11.1)
Height: 6 3/16 (157.2)
F. Gskt: [1] Included
O-Ring: [2] Included

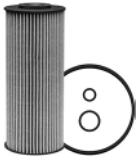

BD40027 Lube Spin-on
Fits: John Deere Dozers, Harvesters, Loaders, Tractors
Replaces: John Deere RE530107, RE557343, RE561823, RE572785; Hifi/Jura Filtration SO10014, SO10094; Mann & Hummel W11011
Thread: M52 x 1.5-6H
O.D.: 4 11/16 (119.1)
Height: 11 25/32 (299.2)
I.Gskt: [1] Included
A. Gskt: [1] Included



B40022-MPG Maximum Performance Glass Lube Spin-on
Contains: 20 PSID By-Pass Valve
Fits: John Deere Forestry Equipment, Loaders, Industrial Engines
Replaces: John Deere RE67764
Thread: 1 1/2 -16
O.D.: 3 3/4 (95.3)
Height: 8 1/4 (209.6)
F. Gskt: [1] Included



BT40028 Lube Spin-on
Contains: 14 PSID By-Pass Valve
Fits: Ingersoll-Rand Air Source Plus 185 Compressor with 41RX3T Engine
Replaces: Ingersoll-Rand 22496905
Thread: 3/4 -16
O.D.: 3 11/16 (93.7)
Height: 3 1/4 (82.6)
I.Gskt: G381-A



P40023 Lube Element
Fits: Mercedes-Benz Automotive
Replaces: Mercedes-Benz 2761800009
O.D.: 2 9/16 (65.1)
I.D.: 7/8 (22.2) & 31/32 (24.6)
Height: 6 9/16 (166.7)
O-Ring: [1] Attached, [1] Included



BT40029 Lube or Hydraulic Spin-on
Fits: Atlas Copco XAS750 JD7 & XATS1050 CD7 Compressors
Replaces: Atlas Copco 1626088200
Thread: M24 x 1.5-6H
O.D.: 3 23/32 (94.2)
Height: 8 3/16 (208.3)
A. Gskt: [1] Included



P40024 Lube Element
Fits: Volkswagen Passat with 4-1968cc (2.0L) FI Turbo Diesel Engine
Replaces: Volkswagen 3L115562
O.D.: 2 9/16 (65.1)
I.D.: 1 3/32 (27.8)
Height: 3 31/32 (100.8)
O-Ring: [2] Attached, [3] Included



P40030 Lube Element
Fits: M.T.U. Equipment
Replaces: M.T.U. X57518300024; Fleetguard LF17485
O.D.: 2 13/16 (71.4) & 3 (76.2)
I.D.: 1 1/8 (28.6)
Height: 7 7/8 (200.0)
O-Ring: [1] Attached, [1] Included



P40025 Lube Element
Fits: Jaguar; Land Rover LR4, Range Rover
Replaces: Land Rover LR011279
O.D.: 2 15/16 (74.6)
I.D.: 3/4 (19.0) & 1 (25.4)
Height: 5 13/16 (147.6)
A. Gskt: [1] Included
F. Gskt: [1] Included



P40031-MPG Maximum Performance Glass Lube Element
Fits: Case Harvesters, Loaders, Sprayers, Tractors; Iveco Trucks with Cursor 9, 11, 13 Engines.
Replaces: Case 2996570, 504179764, 84565867; Claas 11429540; Iveco 504179764; New Holland 2996570, 504179764, 84565867
O.D.: 4 13/32 (111.9)
I.D.: 1 1/8 (28.6) One End
Height: 8 13/16 (223.8)
O-Ring: [2] Attached, [1] Included



P40026 Lube Element
Fits: Mercedes-Benz Automotive
Replaces: Mercedes-Benz 2761800009
O.D.: 2 9/16 (65.1)
I.D.: 7/8 (22.2) & 31/32 (24.6)
Height: 6 9/16 (166.7)
O-Ring: [1] Attached, [1] Included



BT40032 Lube Spin-on
Contains: 40 PSID By-Pass Valve
Fits: Yanmar Engines
Replaces: Yanmar 12769535150
Thread: 1 -12
O.D.: 3 11/16 (93.7)
Height: 7 1/8 (181.0)
I.Gskt: G381-A



Measurements Are Shown In Inches And (Millimeters)

WARNING: These products can expose you to chemicals, including Diisononyl Phthalate, Carbon black extracts, Nickel, 1,3 Butadiene, Ethylene Oxide, Epichlorohydrin, which are known to the State of California to cause cancer, and Bisphenol, Ethylene Glycol, Ethylene Oxide, 1,3 Butadiene, Epichlorohydrin, which are known to the State of California to cause birth defects or other reproductive harm. For more information go to www.P65Warnings.ca.gov.

P40033

Lube Element



Fits: Ford, Lincoln Automotive, Light-Duty Trucks
Replaces: Motorcraft FL2062
O.D.: 1 15/16 (49.2)
I.D.: 27/32 (21.4)
Height: 5 13/32 (137.3)
A. Gskt: [2] Included
O-Ring: [3] Included

P40042

Lube Element



Fits: M.A.N. European Trucks
Replaces: M.A.N. 51055010009, 51055010013, 51055040115
O.D.: 4 23/32 (119.9)
I.D.: 2 3/32 (53.1)
Height: 6 31/32 (177)
O-Ring: [1] Attached, [1] Included

BT40034

Lube Spin-on



Contains: Anti-Drainback Valve
 14 PSID By-Pass Valve
Fits: NACCO Material Handling Equipment
Replaces: NACCO Materials Handling 8815414
Thread: M20 x 1.5
O.D.: 2 21/32 (67.5)
Height: 5 1/2 (139.7)
I.Gskt: [1] Included

B40050

Lube Spin-on



Fits: Cummins ISF3.8, QSF2.8 Naturally Aspirated (Tier 3), QSF2.8 Turbo (Tier 3), QSF2.8 (Tier 4 Final) Engines
Replaces: Cummins 5262313; Fleetguard LF16352
Thread: M27 x 2.0
O.D.: 4 (101.6)
Height: 6 7/8 (174.6)
A. Gskt: [1] Included

P40035

Lube Element



Fits: Porsche, Volkswagen Automotive
Replaces: Volkswagen 3H115562; Porsche 95810722210
O.D.: 3 3/16 (81.0)
I.D.: 5/8 (15.9) One End
Height: 4 11/16 (119.1)
O-Ring: [1] Attached, [1] Included

B40051

Lube Spin-on



Fits: Cummins QSF 2.8 Engines
Replaces: Cummins 5266016; Fleetguard LF17356; Donaldson P557356
Thread: M67 x 4.0
O.D.: 4 (101.6)
Height: 6 7/32 (157.7)
A. Gskt: [1] Included
O-Ring: [1] Attached

B40036

Lube Spin-on



Fits: Mazda 5, 6, Tribute
Replaces: Mazda LF0514302B
Thread: 3/4 -16
O.D.: 2 29/32 (73.8)
Height: 3 1/2 (88.9)
I.Gskt: [1] Included

PF40052

Fuel Element



Fits: Isuzu Trucks with 4HK1 (5.2L) Engine
Replaces: General Motors 98165375; Isuzu 8981653750
O.D.: 2 9/16 (65.1)
I.D.: 5/8 (15.9) One End
Height: 4 1/16 (103.2)
O-Ring: [1] Attached, [3] Included

P40037

Lube Element



Notes: [1] Bolt Furnished
Fits: Mitsubishi Fuso Canter FE125, FE130, FE160, FE180, FG4x4 Trucks with (3.0L) Engines
Replaces: Mitsubishi QC000001, QQC000001; Iveco 504385104; Nissan 15208-HJ00A; Donaldson P506077; Fleetguard LF16330
O.D.: 2 3/4 (70.1)
I.D.: 27/32 (21.1) One End
Height: 5 3/16 (131.8)
O-Ring: [1] Furnished

B40053

Lube Spin-on



Fits: International MaxxForce 9 and 10 Engines, DuraStar, TranStar, WorkStar Trucks
Replaces: Navistar 1885920C2, 1885920C1
Thread: 1 5/8 -12 UN
O.D.: 4 5/8 (117.5)
Height: 10 13/32 (264.3)
I.Gskt: [1] Included

BT40038

Lube Spin-on



Contains: Anti-Drain Back Valve
 11-17 PSID Bypass Valve
Fits: Case Loaders, Compaction Equipment; New Holland Skid Steer Loaders
Replaces: Case 84475542; New Holland 84475542; Donaldson P551132
Thread: 3/4 -16
O.D.: 3 (76.2)
Height: 3 9/32 (83.3)
I.Gskt: [1] Included

B40054

Lube Spin-on



Contains: Anti-Drain Back Valve
 14 PSID By-Pass Valve
Fits: Caterpillar, Mitsubishi Lift Trucks; Hyundai Excavators
Replaces: Caterpillar 32B4020100; Donaldson P502476; Fleetguard LF17507
Thread: 1 -12 UNS-2B
O.D.: 4 1/4 (108.0)
Height: 5 13/16 (147.6)
A. Gskt: [1] Included

Measurements Are Shown In Inches And (Millimeters)

WARNING: These products can expose you to chemicals, including Diisononyl Phthalate, Carbon black extracts, Nickel, 1,3 Butadiene, Ethylene Oxide, Epichlorohydrin, which are known to the State of California to cause cancer, and Bisphenol, Ethylene Glycol, Ethylene Oxide, 1,3 Butadiene, Epichlorohydrin, which are known to the State of California to cause birth defects or other reproductive harm. For more information go to www.P65Warnings.ca.gov.

B40056 Lube Spin-on
Contains: 25 PSID By-Pass Valve
Fits: Doosan Compressors
Replaces: Ingersoll-Rand 23279078; Fleetguard LF17495
Thread: M27 x 2.0
O.D.: 3 23/32 (94.5)
Height: 5 3/8 (136.5)
A. Gskt: [1] Included



P40058 Lube Element
Fits: Fiat Doblo I 1.3 Multijet 16V JTD (119/223) with 75 HP, 85 HP Engines (11/05-on) European Light-Duty Vehicles
Replaces: Fiat 55197218
O.D.: 2 5/8 (66.7)
I.D.: 1/2 (12.7) One End
Height: 3 15/16 (100.0)
O-Ring: [2] Attached, [1] Included



P40061 Lube Element
Fits: Volkswagen Beetle, Jetta, Passat, Golf
Replaces: Volkswagen 3N115562
O.D.: 2 9/16 (65.1)
I.D.: 1 1/16 (27.0) One End
Height: 4 3/32 (104.0)
O-Ring: [2] Included



P40062 Lube Element
Notes: Element in Housing is P7495
Fits: New Holland Combines, Forage Harvesters, Tractors
Replaces: Case 5801592277; New Holland 5801592277; Iveco 50054654, 5801592277; Donaldson P954658; Fleetguard LF17546
O.D.: 4 13/32 (111.9)
I.D.: 1 9/16 (39.7) One End
Height: 12 5/8 (320.7)
O-Ring: [1] Attached, [1] Included

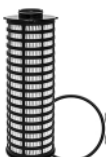

B40063 Lube Spin-on
Fits: Atlas Copco Compressors; John Deere Dozers, Excavators, Forestry Equipment, Generators, Harvesters, Industrial Engines, Loaders, Power Units, Sprayers, Tractors
Replaces: John Deere RE539279; Donaldson P551910; Fram PH10220; Luber-finer LFP9279
Thread: M92 x 2.5
O.D.: 4 (101.6)
Height: 5 7/8 (149.1)
O-Ring: [1] Attached
Grommets: [1] Attached



BT40065 Air Breather Spin-on
Fits: McNeilus refuse systems
Replaces: McNeilus 0604428, 604428
Thread: 3/4 NPT
O.D.: 3 11/16 (93.2)
Height: 3 7/32 (81.6)



BT40066-MPG Maximum Performance Glass Hydraulic Spin-on
Fits: Caterpillar Crawler Tractors, Off-Highway Trucks
Replaces: Caterpillar 4656506
Thread: 1 3/8 -12
O.D.: 4 23/32 (119.6)
Height: 10 (254)
A. Gskt: [1] Included



BT40067-MPG Maximum Performance Glass Lube Spin-on
Replaces: Donaldson DBB8665
Thread: 1 3/4 -12
O.D.: 4 23/32 (119.9)
Height: 14 1/8 (358.6)
O-Ring: [1] Attached



P40069 Lube Element
Fits: Kenworth, Peterbilt trucks w/Paccar MX-13 Engs.
Replaces: Paccar 2047411, 2047411PE, 2047542, 2047542PE, 2151728, 2151728PE, 2234788, 2234788PE; Fleetguard LF16368; Luber-finer LP7183; Mann+Hummel HU12009, HU12009z; Wix WL10341
O.D.: 4 11/16 (119.4)
I.D.: 1 23/32 (43.9)
Height: 9 3/16 (233.7)
O-Ring: [3] Attached, [1] Included



B40070 Lube Spin-on
Contains: Anti-Drainback Valve
20 PSID By-Pass Valve
Fits: Bobcat Excavators, Loaders, Telescopic Handlers, Utility Vehicles.
Replaces: Bobcat 7012303
Thread: 1 -12
O.D.: 3 11/16 (93.7)
Height: 3 31/32 (100.8)
A. Gskt: G401



S40071 Foam Fuel Element
Fits: Master Portable Heaters; Heating-Fuel Storage Tanks
Replaces: General 1A30; Kralinator F900; Fram C1250RO
O.D.: 2 1/2 (63.5)
Height: 3 25/32 (96.0)
F. Gskt: [3] Included



B40073 Lube Spin-on
Contains: Anti-Drainback Valve
20 PSID By-Pass Valve
Fits: Caterpillar Excavators, Loaders, Paving Equipment
Replaces: Caterpillar 3776969
Thread: 3/4 -16 UNF
O.D.: 3 11/16 (93.7)
Height: 3 7/8 (98.4)
A. Gskt: [1] Included
Grommets: [1] Attached



Measurements Are Shown In Inches And (Millimeters)

WARNING: These products can expose you to chemicals, including Diisononyl Phthalate, Carbon black extracts, Nickel, 1,3 Butadiene, Ethylene Oxide, Epichlorohydrin, which are known to the State of California to cause cancer, and Bisphenol, Ethylene Glycol, Ethylene Oxide, 1,3 Butadiene, Epichlorohydrin, which are known to the State of California to cause birth defects or other reproductive harm. For more information go to www.P65Warnings.ca.gov.

P40074 Lube Element
Fits: 2018-19 Chevrolet Colorado and GMC Canyon all with 2.8L Diesel Eng
Replaces: ACDelco PF2262G; General Motors Corp.12670806,12679114
O.D.: 2 21/32 (67.6)
I.D.: 21/32 (16.5) & 15/16 (23.6)
Height: 6 5/8 (168.7)
O-Ring: [3] Attached, [1] Included



P40083 Lube Element
Fits: 1992-95 BMW 320i, 1991-95 325i, 325iC, 525i, 525iT, 1991 325iS, 325iX, 1995-2006 M3, 1998-2000 Z3, 2001-02 Z3 M
Replaces: BMW (Bavarian Motor Works) 11421730389; Wix 51160
O.D.: 3 3/16 (81.0)
I.D.: 1 3/32 (27.8)
Height: 4 15/32 (113.5)
A. Gskt: [2] Attached
F. Gskt: [4] Included



P40076 Lube Element
Fits: BMW Automobiles
Replaces: BMW 11428583898
O.D.: 2 7/32 (56.4)
I.D.: 13/16 (20.6)
Height: 6 1/16 (153.9)
F. Gskt: [1] Copper Washer
O-Ring: [3] Attached, [1] Included



P40085 Lube Element
Fits: Yamaha Motorcycles
Replaces: Yamaha 1L913440-91; Wix 24934, 51218
O.D.: 3 (76.2)
I.D.: 25/32 (19.8)
Height: 1 19/32 (40.5)
O-Ring: [2] Included
Grommets: [2] Attached



OB40078 Replacement Filter Base
Notes: Spin-on conversion for Chevrolet V8 engines.
Contains: Threaded Stud: 13/16-16 [2] 1/4 In. Bolts [2] 5/16 In. Bolts
Use With: B6, B7
Replaces: ACDelco K157; GMC 6438357; Motorcraft FL774; WIX 24061
O.D.: 4 (101.6)
A. Gskt: [1] Attached
F. Gskt: [1] Included



P40086 Lube Element
Fits: Honda Motorcycles
Replaces: Honda 15412-413-005, 154A1-413-005; Wix 24938, 51217
O.D.: 2 5/8 (66.7)
I.D.: 25/32 (19.8)
Height: 1 25/32 (45.2)
F. Gskt: [1] Included
O-Ring: [1] Included
Grommets: [2] Attached



OB40079 Full-Flow Lube Filter Base for Remote Mount Filter
Contains: Single Inlet/Outlet with Female 1/2-14 In. NPT Thread
Use With: B34, B2, B253, B163, B132, B233, BT5, BT251, BT237, B1434, BT217, B74
Replaces: Wix 24762
Thread: 3/4 -16
O.D.: 4 (101.6)
Height: 2 1/2 (63.5)



P40089 Lube Element
Contains: 10 PSID By-Pass Valve
Fits: Yamaha ATVs, Motorcycles
Replaces: Yamaha 4X71344090; Wix 24935
O.D.: 2 3/16 (55.6)
I.D.: 21/32 (16.7) One End
Height: 2 3/8 (60.3)
O-Ring: [3] Included
Grommets: [2] Attached

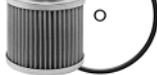

OB40080 Replacement Filter Base for Remote Mount
Notes: Cast Aluminum
Contains: Dual Inlet/Outlet with Female 1/2 In. NPT
Threaded Stud: 3/4-16
Replaces: Wix 24764, 524764



P40090 Lube Element
Fits: Kawasaki KL250, KLR250, KL600, KL650, KLR650, KLX650, KLX650R Motorcycles
Replaces: Kawasaki 16099004; Wix 24951
O.D.: 2 5/32 (54.8)
I.D.: 1/2 (12.7)
Height: 2 9/32 (57.9)
O-Ring: [2] Included
Grommets: [2] Attached



P40081 Lube Element
Fits: 1991-95 BMW Automotive
Replaces: BMW (Bavarian Motor Works) 11421727300; Wix 51185
O.D.: 3 3/16 (81.0)
I.D.: 1 31/32 (50.0)
Height: 3 17/32 (89.7)
A. Gskt: [2] Attached
F. Gskt: [2] Metal Washers
O-Ring: [2] Included



P40091 Lube Element
Fits: Yamaha SR250, TT250, XT270, XV250 Series, BW350 Big Wheel, TT500, XT500, XV500 Virago, XV535 Virago, XT550, XV550 Vision, SRX600, TT600, XT600, XT600E, XVS650 Series, TDM850, TDM850E Motorcycles
Replaces: Yamaha 4X71344090; Wix 24936
O.D.: 2 3/16 (55.6)
I.D.: 1/8 (3.2) One End
Height: 2 3/8 (60.3)
O-Ring: [2] Included
Grommets: [2] Attached



Measurements Are Shown In Inches And (Millimeters)

WARNING: These products can expose you to chemicals, including Diisononyl Phthalate, Carbon black extracts, Nickel, 1,3 Butadiene, Ethylene Oxide, Epichlorohydrin, which are known to the State of California to cause cancer, and Bisphenol, Ethylene Glycol, Ethylene Oxide, 1,3 Butadiene, Epichlorohydrin, which are known to the State of California to cause birth defects or other reproductive harm. For more information go to www.P65Warnings.ca.gov.

P40093 Lube Element
Fits: Honda Motorcycles
Replaces: Honda 15410-426001-0; Wix 24940
O.D.: 3 1/32 (77.0)
I.D.: 25/32 (19.8)
Height: 2 5/32 (54.8)
O-Ring: [2] Included
Grommets: [2] Attached



P40100 Lube Element
Fits: BMW, Rolls Royce Automotive
Replaces: BMW 11427542021; WIX 57175
O.D.: 2 7/8 (73.0)
I.D.: 17/32 (13.5) & 1 1/4 (31.8)
Height: 4 1/8 (104.8)
A. Gskt: [2] Attached
F. Gskt: [1] Metal Washer
O-Ring: [2] Included



P40094 Lube Element
Fits: 1999-on Porsche 911 Carrera, 2004-on 911 GT2, 2004-07 911 GT3, 911 Turbo S, 2000-05 911 Turbo, 1997-2009 Boxster, 2003-09 Cayenne, 2006-on Cayman S
Replaces: Porsche 99610722552; Wix 57211
O.D.: 2 9/16 (65.1)
I.D.: 15/16 (23.8)
Height: 4 1/2 (114.3)
O-Ring: [2] Attached, [1] Included



P40101 Lube Element
Fits: 2007-09 Smart Fortwo with 3-799cc (0.8L) Turbo Diesel Engine, 2010 with 3-999 (1.0L) Engine
Replaces: Mercedes-Benz 1601840225, 19727V001, A1601840225
O.D.: 2 1/16 (52.3)
I.D.: 27/32 (21.4)
Height: 2 5/32 (54.8)
O-Ring: [1] Included



P40095 Lube Element
Fits: 2005-07 Audi A6, 2006 A6 Avant, 2005 A6 Quattro, A8 Quattro, 2006-08 A8, A8 L, 2004-05 A8 L Quattro, 2004 Allroad Quattro, 2007 RS4, 2004-08 S4, S4 Avant, 2005-09 S4 Cabriolet; 2004-06 Volkswagen Phaeton
Replaces: Volkswagen 79115561B, 79198405; WIX 57329, 557329
O.D.: 2 7/8 (73.0)
I.D.: 3/8 (9.5) & 1 1/4 (31.8)
Height: 5 11/16 (144.5)
A. Gskt: [1] Attached
F. Gskt: [1] Washer
O-Ring: [1] Included



P40102 Lube Element
Fits: Hyundai Equus, Genesis; Kia Borrego, K900
Replaces: Hyundai 26320-3C30A, 26320-3C700; WIX 57042, 57029
O.D.: 2 19/32 (65.9)
I.D.: 3/4 (19.0)
Height: 4 (101.6)
A. Gskt: [2] Included
F. Gskt: [1] Metal Washer
O-Ring: [3] Included



P40096 Lube Element
Fits: 2004-07 Volkswagen Touareg with 4.2L Gas Engine, 2005 Touareg with 4.9L Diesel Engine
Replaces: Volkswagen 77115562; Wix 57563, 557563
O.D.: 3 9/32 (83.3)
I.D.: 13/16 (20.6) & 1 3/8 (34.9)
Height: 4 5/16 (109.5)
A. Gskt: [2] Attached
O-Ring: [2] Included



P40103 Lube Element
Fits: Audi Q7, R8; Volkswagen Touareg
Replaces: Audi 79198405B; Mann & Hummel HU7005X; WIX 57330
O.D.: 2 11/16 (68.3)
I.D.: 3/4 (19.0) & 1 1/16 (27.0)
Height: 5 1/16 (128.6)
A. Gskt: [1] Attached
O-Ring: [1] Included



P40098 Lube Element
Fits: 2003-on Maybach 57, 57S, 62; 2004-on Mercedes-Benz CL600, 2004-on S600, SL600, 2005-06 CL65 AMG, 2006 SL65 AMG all with V12 (5.5L), V12 (6.0L) Engines
Replaces: Mercedes-Benz 2751800009, A2751800009; Wix 57198
O.D.: 2 1/2 (63.5)
I.D.: 1 7/32 (31.0)
Height: 5 5/16 (134.9)
O-Ring: [4] Included



P40104 Lube Element
Fits: BMW, Rolls Royce Automotive
Replaces: BMW (Bavarian Motor Works) 11427583220; Wix 57189
O.D.: 2 31/32 (75.4)
I.D.: 1 1/8 (28.6) One End
Height: 4 11/32 (110.3)
F. Gskt: [1] Copper Washer
O-Ring: [2] Included











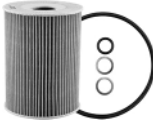

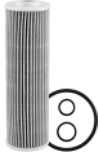
P40099 Lube Element
Fits: Mercedes-Benz Automotive
Replaces: Mercedes-Benz 2711800009, 2711800109, 2711840125, A2711800009; Wix 57009
O.D.: 1 13/16 (46.0)
I.D.: 7/8 (22.2)
Height: 6 5/32 (156.4)
O-Ring: [3] Included
Grommets: [2] Attached



Measurements Are Shown In Inches And (Millimeters)

WARNING: These products can expose you to chemicals, including Diisononyl Phthalate, Carbon black extracts, Nickel, 1,3 Butadiene, Ethylene Oxide, Epichlorohydrin, which are known to the State of California to cause cancer, and Bisphenol, Ethylene Glycol, Ethylene Oxide, 1,3 Butadiene, Epichlorohydrin, which are known to the State of California to cause birth defects or other reproductive harm. For more information go to www.P65Warnings.ca.gov.

<p>P40105 Lube Element Fits: 2008-11 BMW M6, 2008-10 M5; 2008-12 Porsche Cayenne, 2009-12 911 Carrera, 911 Carrera 4, 911 Carrera 4S, 911 Carrera S, 911 Targa 4, 911 Targa 4S, 2010-12 Panamera, 2011-12 911 Carrera GTS, 911 Turbo Replaces: BMW (Bavarian Motor Works) 11427840594, 11427834734; Porsche 94810722200; Wix 57694, 57594, WL10372, SL10372 O.D.: 3 9/32 (83.3) I.D.: 1 5/32 (29.4) Height: 4 1/4 (108) F. Gskt: [2] Copper Washers O-Ring: [2] Included</p> 	<p>P40111 Lube Element Contains: By-Pass Boss/Plug Fits: Audi A6 Quattro, A8 Quattro, Q5, Q7; Volkswagen Touareg Replaces: Volkswagen 059198405, 59198405; Wix WL10008 O.D.: 2 13/16 (71.4) I.D.: 1 1/8 (28.6) Height: 5 1/32 (127.8) O-Ring: [1] Attached, [1] Included</p> 
<p>P40106 Lube Element Fits: 2008-12 BMW M3 Replaces: BMW (Bavarian Motor Works) 11427837997; Wix 57997 O.D.: 3 9/32 (83.3) I.D.: 1 5/32 (29.4) Height: 4 1/4 (108) F. Gskt: [2] Copper Washers O-Ring: [2] Included</p> 	<p>P40112 Lube Element Fits: Mercedes-Benz C250, SLK250 Replaces: Mercedes-Benz 2711800409, 2711800509, A2711800409, A2711800509; Wix WL10059 O.D.: 1 13/16 (46.0) I.D.: 13/16 (20.6) Height: 6 5/32 (156.4) O-Ring: [3] Included</p> 
<p>P40107 Lube Element Fits: BMW 335d, X5 Replaces: BMW 11427788454, 11427788460, 11427788461; Wix 57560 O.D.: 2 9/16 (65.1) I.D.: 1 1/4 (31.8) Height: 6 1/16 (154) F. Gskt: [1] Metal Washer O-Ring: [1] Included Grommets: [2] Attached</p> 	<p>P40113 Lube Element Contains: [1] Plastic Plug Fits: BMW Automotive Replaces: BMW (Bavarian Motor Works) 11427640862 O.D.: 2 7/8 (73.0) I.D.: 1 5/8 (41.3) Height: 3 1/8 (79.4) O-Ring: [2] Included</p> 
<p>P40108 Lube Element Fits: Mercedes-Benz Automotive Replaces: Mercedes-Benz 1803009, A0001803009; Wix 57010 O.D.: 2 7/8 (73.0) I.D.: 3/8 (9.5) & 1 1/4 (31.8) Height: 5 1/32 (127.8) A. Gskt: [1] Attached F. Gskt: [1] Included</p> 	<p>P40114 Lube Element Fits: Chevrolet Cruze with 4-119 (2.0L) FI Turbo Diesel Engine Replaces: General Motors 55577033; WIX WL10021, SL10021 O.D.: 2 19/32 (65.9) I.D.: 5/8 (15.9) & 1 1/4 (31.8) Height: 4 1/8 (104.8) O-Ring: [2] Attached</p> 
<p>P40109 Lube Element Fits: Lexus IS-F, LX570; Toyota Sequoia, Land Cruiser, Tundra Replaces: Toyota 415251010; Wix 57310 O.D.: 2 3/4 (69.9) I.D.: 1 3/32 (27.8) Height: 4 9/16 (115.9) O-Ring: [1] Included Related To: P7406 (with Drain Plug)</p> 	<p>P40115 Lube Element Fits: Audi A8 Quattro; Bentley Continental; Volkswagen Phaeton, Touareg Replaces: Volkswagen 07C115562E, 7C115562E; WIX 57562 O.D.: 2 7/8 (73.0) I.D.: 1 (25.4) & 1 5/8 (41.3) Height: 5 1/4 (133.4) A. Gskt: [2] Included O-Ring: [1] Included</p> 
<p>P40110 Lube Element Fits: Audi Q5, Q7; Volkswagen Touareg Replaces: Volkswagen 57115561M; Mann & Hummel HU8001X O.D.: 3 (76.2) I.D.: 1 1/8 (28.6) Height: 7 7/8 (200) O-Ring: [1] Included</p> 	<p>P40116 Lube Element Contains: Plastic Drain Tube Fits: Scion iQ with 4-1329cc (1.3L) FI Engine Replaces: Toyota 415240060 O.D.: 2 7/16 (61.9) I.D.: 1 3/32 (27.8) Height: 3 15/32 (88.1) O-Ring: [2] Included</p> 

Measurements Are Shown In Inches And (Millimeters)

WARNING: These products can expose you to chemicals, including Diisononyl Phthalate, Carbon black extracts, Nickel, 1,3 Butadiene, Ethylene Oxide, Epichlorohydrin, which are known to the State of California to cause cancer, and Bisphenol, Ethylene Glycol, Ethylene Oxide, 1,3 Butadiene, Epichlorohydrin, which are known to the State of California to cause birth defects or other reproductive harm. For more information go to www.P65Warnings.ca.gov.

P40117 Lube Element
Fits: 2005-08 Volkswagen Touareg with V10-4921cc (5.0L) Turbo Diesel Engine
Replaces: Volkswagen 7Z15562; WIX 57162
O.D.: 3 19/32 (91.3)
I.D.: 1 1/4 (31.8) & 1 11/32 (34.1)
Height: 5 9/16 (141.3)
O-Ring: [1] Attached, [1] Included



P40118 Lube Element
Fits: Porsche Boxster, Cayman
Replaces: Porsche 9A1.107.224.00; WIX 57070, 557070
O.D.: 2 9/16 (65.1)
I.D.: 1 1/4 (31.8)
Height: 5 17/32 (140.5)
O-Ring: [1] Included



P40119 Lube Element
Fits: Mercedes-Benz Automotive
Replaces: Mercedes-Benz A2701800009, A2701800109, A2701840025, A2701840125, 2701800009, 2701800109, 2701840025, 2701840125; WIX WL7515
O.D.: 2 13/16 (71.4)
I.D.: 1 7/32 (31.0)
Height: 3 7/16 (87.3)
A. Gskt: [1] Included
O-Ring: [3] Included



B40120 Lube Spin-on
Contains: Anti-Drainback Valve
 20 PSID By-Pass Valve
Fits: 1980-94 Jaguar
Replaces: Jaguar C42797
Thread: 1 -12
O.D.: 3 11/16 (93.7)
Height: 5 13/32 (137.3)
I.Gskt: [1] Included



B40121 Full-Flow Lube Spin-on
Contains: Anti-Drainback Valve
 19 PSID By-Pass Valve
Fits: 1992-93 Dodge Ram 50, Plymouth Laser; 1992-94 Eagle Summit, Talon; 1987-89 Mazda B2600 Light-Duty Trucks
Replaces: Chrysler 4494477; Mazda AM15-14-302
Thread: M20 x 1.5
O.D.: 3 11/16 (93.7)
Height: 3 1/4 (82.6)
I.Gskt: [1] Included



B40124 Lube Spin-on
Fits: Chevrolet Astra, Volt
Replaces: ACDelco PF65; General Motors Corp. 55352643, 93178952; Wix 57143
Thread: M18 x 1.5
O.D.: 3 1/32 (77.0)
Height: 2 27/32 (72.2)
I.Gskt: [1] Included



B40125 Lube Spin-on
Contains: Front-End By-Pass Valve
Fits: 1978-95 Porsche 928, 1995-98 911
Replaces: Porsche 92810720103; WIX 51285
Thread: M20 x 1.5
O.D.: 3 5/32 (80.2)
Height: 6 3/4 (171.5)
I.Gskt: [1] Included



B40126 Lube Spin-on
Contains: Anti-Drainback Valve
 8 PSID By-Pass Valve
Fits: 1993 Eagle, 1990-93 Geo, 1981-93 Isuzu Automotive
Replaces: General Motors Corp. 25013451
Thread: M20 x 1.5
O.D.: 3 (76.2)
Height: 3 1/2 (88.9)
I.Gskt: [1] Included



B40127 Lube Spin-on
Contains: Anti-Drainback Valve
 36 PSID By-Pass Valve
Fits: 2000-04 Audi A6 Series, 2002-03 S6 Series, all with V-8 4.2L Engine
Replaces: Volkswagen 77115561G; WIX 57172
Thread: M24 x 2.0
O.D.: 2 31/32 (75.4)
Height: 7 15/32 (189.7)
I.Gskt: [1] Included



B40128 Lube Spin-on
Contains: Anti-Drainback Valve
 30 PSID By-Pass Valve
 Front End Check Valve
Fits: 2005-06 Jeep Liberty with 2.8L Turbo Diesel Engine
Replaces: Chrysler 5003558AA
Thread: 3/4 -16
O.D.: 2 29/32 (73.8)
Height: 4 27/32 (123)
I.Gskt: [1] Included



B40129 Lube Spin-on
Contains: 30 PSID By-Pass Valve
 Front End Check Valve
Fits: 1991-94 Porsche 911 Turbo, 1987-88 924, 1983-91 944, 1992-95 968
Replaces: Porsche 94410720108; Wix 51287
Thread: M20 x 1.5
O.D.: 2 29/32 (73.8)
Height: 4 27/32 (123)
I.Gskt: [1] Included



P40130 Lube Element
Contains: By-Pass Valve
Replaces: Yamaha 1UY1344002
O.D.: 1 1/2 (38.1)
I.D.: 1/2 (12.7)
Height: 1 13/16 (46.0)
A. Gskt: [2] Attached
O-Ring: [2] Included



Measurements Are Shown In Inches And (Millimeters)

WARNING: These products can expose you to chemicals, including Diisononyl Phthalate, Carbon black extracts, Nickel, 1,3 Butadiene, Ethylene Oxide, Epichlorohydrin, which are known to the State of California to cause cancer, and Bisphenol, Ethylene Glycol, Ethylene Oxide, 1,3 Butadiene, Epichlorohydrin, which are known to the State of California to cause birth defects or other reproductive harm. For more information go to www.P65Warnings.ca.gov.

P40131

Lube Element



Contains: By-Pass Valve
Fits: Yamaha Moto-4 200, Tri-Moto 200, Yamahauler 200, Moto-4 225, Tri-Moto 225; Pro Hauler 230, Bear Tracker 250, Moto-4 250, Timberwolf 250 ATVs, SRX, TW200 Series, XT200J, XT225, XT350 Series Motorcycles
Replaces: Yamaha 5H01344009; WIX 57934
O.D.: 1 1/2 (38.1)
I.D.: 1/2 (12.7) One End
Height: 1 7/8 (47.6)
O-Ring: [2] Included

P40132

Lube Element

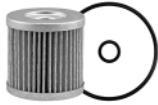

Fits: Suzuki, Kawasaki ATVs, Motorcycles
Replaces: Suzuki 1651029F00; WIX 57931
O.D.: 1 3/4 (44.4)
I.D.: 17/32 (13.5)
Height: 1 23/32 (43.7)
F. Gskt: [2] Included

B40133

Lube Spin-on



Fits: Perkins 1104D-E44TA (4.4L), 1206F-E70TTA (7.0L) Engines
Replaces: Perkins 4627133; Fleetguard LF16401
Thread: M24 x 1.5
O.D.: 3 11/16 (94.0)
Height: 8 1/8 (206.8)
A. Gskt: [1] Included

P40134

Lube Element

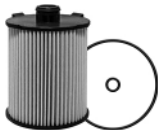

Fits: 2014-20 Volvo V60, 2015-16 S80, XC70, 2015-20 S60, XC60, 2016-20 XC90, 2017-19 V90Cross Country, 2017-20 S90, V60 Cross Country, 2019 V90, 2019-20 XC40
Replaces: Volvo 31372212; Fram CH11816; Luber-finer P1023; Mann+Hummel HU8014z; Wix WL10241
O.D.: 3 7/32 (82.0)
I.D.: 15/16 (23.9) & 9/16 (14.0)
Height: 4 1/8 (104.9)
O-Ring: [2] Attached, [2] Furnished

B40136

Lube Spin-on



Contains: Anti-Drainback Valve
20 PSID By-Pass Valve
Fits: Cummins QSB3.3 Engine, B3.3 Generator Engine
Replaces: Cummins 4982627; Fleetguard LF16097
Thread: 3/4 -16 UNF
O.D.: 3 1/32 (77.0)
Height: 3 1/2 (88.9)
A. Gskt: [1] Included

B40137

Lube Spin-on



Contains: 35 PSID By-Pass Valve
Fits: Isuzu FTR, NPR, NPR-HD, NPR-XD, NQR, NRR Trucks
Replaces: Isuzu 2906544040, 2946542000; Fleetguard LF17537
Thread: 1 1/2 -12
O.D.: 4 21/32 (188.3)
Height: 4 15/16 (125.4)
A. Gskt: [1] Included

B40138

Lube Spin-on



Contains: 20 PSID By-Pass Valve
Fits: Isuzu NPR, NQR Trucks
Replaces: Isuzu 2946541000, 2906542700; Fleetguard LF17538
Thread: 1 1/2 -12
O.D.: 4 21/32 (118.3)
Height: 4 15/16 (125.4)
A. Gskt: [1] Included

BD40139

Dual-Flow Lube Spin-on



Fits: Komatsu Dozers, Dump Trucks, Excavators, Tractors, Wheel Loaders
Replaces: Komatsu 6002111341
Thread: M95 x 2.5 -6H
O.D.: 4 23/32 (119.6)
Height: 11 25/32 (299.5)
A. Gskt: [1] Included

B40140

Lube Spin-on



Contains: Anti-Drainback Valve
30 PSID By-Pass Valve
Fits: Bobcat 3400, 3400 XL, 3600, 3650 Utility Vehicles
Replaces: Bobcat 7257441; Kohler 2175282
Thread: M20 x 1.5 -6H
O.D.: 3 1/32 (77.2)
Height: 3 1/2 (88.9)
A. Gskt: [1] Included

B40142

Lube Spin-on



Fits: Autocar, Dennis Eagle, Freightliner, International, Mack, Western Star Trucks; Blue Bird, IC Corporation, New Flyer, Thomas, Van Hool Buses
Replaces: Cummins 5444774; Fleetguard LF14009NN; Donaldson DBL7300
Thread: 2 1/4 -12
O.D.: 4 21/32 (118.3)
Height: 11 13/32 (289.7)
A. Gskt: [1] Included
Grommets: [1] Attached

P40143

Lube Element



Fits: 2017-18 Genesis G80; 2014-16 Hyundai Genesis; 2017 Genesis Coupe, 2020 Palisade; 2017-19 Kia Cadenza, 2019-20 Sedona, 2020 Telluride
Replaces: Hyundai 263203CKB0
O.D.: 2 9/16 (65.0)
I.D.: 1 (25.7)
Height: 3 9/32 (83.1)
A. Gskt: [1] Metal Washer Included
O-Ring: [1] Included
Grommets: [2] Attached

Measurements Are Shown In Inches And (Millimeters)

WARNING: These products can expose you to chemicals, including Diisononyl Phthalate, Carbon black extracts, Nickel, 1,3 Butadiene, Ethylene Oxide, Epichlorohydrin, which are known to the State of California to cause cancer, and Bisphenol, Ethylene Glycol, Ethylene Oxide, 1,3 Butadiene, Epichlorohydrin, which are known to the State of California to cause birth defects or other reproductive harm. For more information go to www.P65Warnings.ca.gov.

B40145 Lube Spin-on
Fits: Cummins X12, X15 Engines
Replaces: Cummins 5575298; Fleetguard LF14001NN
Thread: M95 x 2.5 -6H
O.D.: 4 11/16 (119.1)
Height: 11 25/32 (299.2)
A. Gskt: [1] Included
O-Ring: [1] Attached
Related To: BD50000 (Where appropriate use with 2020 Cummins X12, X15 Engines)



BF46001 In-Line Fuel Filter
Notes: This filter used with detachable fuel heater.
 Remove heater attachment from old filter and install on new filter.
Fits: Mercedes-Benz Automotive
Replaces: Mercedes-Benz 6420920201; Mann & Hummel WK820/2x
O.D.: 3 9/16 (90.5)
Inlet: 5/16
Outlet: 3/8
Length: 4 11/16 (119.1)
O-Ring: [1] Included



B40150 Lube Spin-on
Contains: Anti-Drainback Valve
 25 PSID By-Pass Valve
Fits: 2020-21 Chevrolet Silverado 2500 HD, Silverado 3500 HD, Silverado 4500 HD, Silverado 5500 HD, Silverado 6500 HD; GMC Sierra 2500 HD, Sierra 3500 HD.
Replaces: ACDelco PF26; GM General Motors 12684038, 89017527
Thread: M22 x 1.5
O.D.: 3 11/16 (93.7)
Height: 4 3/8 (111.3)
A. Gskt: G381-A



BF46002 High Efficiency Fuel Spin-on
Fits: Cummins Engines, Marine Engines; Euclid, Hitachi, John Deere, Kawasaki, Komatsu, Terex Equipment, all with Cummins Engines
Replaces: Cummins 2441458, 5417137
Thread: 2 1/4 -12
O.D.: 4 5/8 (117.5)
Height: 10 (254.0)
I.Gskt: [1] Included
Related To: BF7932 (Standard Version)



P40156 Lube Element
Fits: 2019-20 Ford Transit Connect
Replaces: Ford Motor JX6Z6731B; Motorcraft FL2082; WIX WL10397
O.D.: 1 29/32 (48.5)
I.D.: 15/16 (23.8)
Height: 3 21/32 (93)
O-Ring: [1] Included



PF46003 Fuel Element
Fits: Case, Case-International, New Holland Equipment
Replaces: Case 5801439820
O.D.: 4 1/4 (108.0)
I.D.: 31/32 (24.6)
Height: 6 11/32 (161.1)
O-Ring: [1] Included



BF45000 In-Line Fuel Strainer
Fits: Walker MD Series Mower
Replaces: Walker 7020
O.D.: 2 3/32 (53.2)
Inlet: 1/4
Outlet: 1/4
Length: 3 7/16 (87.3)



PF46004 Fuel Element
Fits: Ford Transit Vehicles
Replaces: Ford 1837319, CC1Z-9354-A, CC119176BB; Motorcraft FD4621
O.D.: 3 11/16 (93.7)
 Flange 4 29/32 (124.6)
I.D.: 5/8 (15.9) & 1 9/16 (39.7)
Height: 5 9/32 (134.1)
O-Ring: [2] Attached, [1] Included



BF46000 In-Line Fuel Filter
Contains: [1] Drain Screw
Fits: Freightliner, Mercedes-Benz Sprinter Vans
Replaces: Mercedes-Benz A6420920301
O.D.: 3 5/8 (92.1)
Inlet: 1/4
Outlet: 1/4
Length: 4 17/32 (115.1)
O-Ring: [4] Included



BF46005 In-Line Fuel Filter
Contains: Mounting Bracket
Fits: Caterpillar, Mitsubishi Lift Trucks
Replaces: Caterpillar 9126406100
O.D.: 1 13/16 (46.0)
Inlet: M14 x 1.5
Outlet: M14 x 1.5
Length: 3 7/16 (87.3)



BF46006 In-Line Diesel Fuel Filter
Fits: Freightliner Trucks
Replaces: Ford 4C4Z-9155-AA
O.D.: 1 7/8 (47.6)
Length: 4 31/32 (126.2)



Measurements Are Shown In Inches And (Millimeters)

WARNING: These products can expose you to chemicals, including Diisononyl Phthalate, Carbon black extracts, Nickel, 1,3 Butadiene, Ethylene Oxide, Epichlorohydrin, which are known to the State of California to cause cancer, and Bisphenol, Ethylene Glycol, Ethylene Oxide, 1,3 Butadiene, Epichlorohydrin, which are known to the State of California to cause birth defects or other reproductive harm. For more information go to www.P65Warnings.ca.gov.

BF46007 In-Line Fuel Strainer
Fits: 1992-2004 AM General, Chevrolet, GMC Trucks with V8-6.5L Engine
Replaces: General Motors 12339208
O.D.: 1 (25.4)
Inlet: 1/4
Outlet: 1/4
Length: 3 (76.2)



BF46008 In-Line Fuel Filter
Fits: Kohler Generators
Replaces: Kohler 267987
O.D.: 1 7/32 (31.0)
Inlet: 1/4-18 NPT
Outlet: 1/8-27 NPT
Length: 2 15/32 (62.7)



PF46009 Fuel Element
Fits: Kool-Gen Auxiliary Power Units
Replaces: Racor R11T
O.D.: 2 3/8 (60.3)
I.D.: 5/8 (15.9) & 11/16 (17.5)
Height: 2 5/8 (66.7)
F. Gskt: [1] Included
O-Ring: [1] Included



PF46010 KIT Set of 2 Fuel Elements
Notes: Larger filter is a coalescer smaller filter is a Fuel/Water Separator
Fits: Marine Engines
Replaces: Racor RK22610; Donaldson P551061, Carquest 96075; Fleetguard FS1107, Wix WF10075, HiFiJura YRK22610
Coalescer
O.D.: 4 (101.6)
I.D.: 13/16 (20.6) & 1 3/16 (30.2)
Height: 11 5/8 (295.3)
F. Gskt: [1] Included
O-Ring: [1] Included
Grommets: [2] Attached to Each Filter
Fuel/Water Separator
O.D.: 4
I.D.: 5/8 & 13/16
Height: 9 11/16



BF46012 Fuel/Water Separator Spin-on
Fits: Davco 210 Fuel Processor
Replaces: Donaldson P550783; Wix 33998
Thread: M16 x 1.5
O.D.: 3 3/16 (81.0)
Height: 6 15/16 (176.2)
I.Gskt: [1] Included
F. Gskt: [1] Included



BF46014 Primary Fuel Spin-on
Notes: CAUTION: Furnished O-Ring must be installed on post for seal.
Fits: Davco 210 Fuel Processor
Replaces: Donaldson P550782
Thread: M16 x 1.5
O.D.: 3 3/16 (81.0)
Height: 6 15/16 (176.2)
I.Gskt: [1] Included
F. Gskt: [1] Included



BF46015 Fuel/Water Separator Spin-on with Drain
Fits: Eagle Tow Tractors with Yanmar 4TNV98 Engine
Replaces: Fleetguard FS20000
Thread: 1 1/8 -16
O.D.: 3 11/16 (93.7)
Height: 9 13/16 (249.2)
I.Gskt: [1] Included
F. Gskt: [1] Included



BF46016-O Fuel/Water Separator Spin-on with Open End for Bowl
Contains: Bowl Thread: 3 3/4-10 Buttress Integral Post Seal
Fits: Freightliner Trucks; Racor Fuel Systems
Replaces: Freightliner ABPN122R50551
Thread: 1 -14
O.D.: 4 11/32 (110.3)
Height: 6 1/8 (155.6)
F. Gskt: [2] Included



BF46017-O Fuel/Water Separator Spin-on with Open End for Bowl
Contains: Bowl Thread: 3 1/8-10 UN 1B
Fits: Bobcat Compressors; Doosan G20 Portable Generators; Ingersoll-Rand Compressors
Replaces: Ingersoll-Rand 54525530
Thread: 1 -12
O.D.: 3 25/32 (96.0)
Height: 3 1/4 (82.6)
F. Gskt: [1] Included
O-Ring: [1] Included



BF46018-O Fuel/Water Separator Spin-on with Open End for Bowl
Contains: Bowl Thread: 3 3/4-10UNS-2B Integral Post Seal
Fits: International, Navistar Trucks with Maxxforce Engine
Replaces: International 2602549C1
Thread: 1 -14
O.D.: 4 1/4 (108.0)
Height: 8 17/32 (216.7)
F. Gskt: [2] Included
Related To: BF1281 (Drain Version)













BF46019-O Fuel/Water Separator Spin-on with Open End for Bowl
Contains: Bowl Thread: 3 1/8-10 UN 1B
Fits: Racor 215R Fuel Assembly
Replaces: Racor R15S
Thread: 1 -14
O.D.: 3 13/16 (96.8)
Height: 3 9/32 (83.3)
F. Gskt: [1] Included
O-Ring: [1] Included



Measurements Are Shown In Inches And (Millimeters)

WARNING: These products can expose you to chemicals, including Diisononyl Phthalate, Carbon black extracts, Nickel, 1,3 Butadiene, Ethylene Oxide, Epichlorohydrin, which are known to the State of California to cause cancer, and Bisphenol, Ethylene Glycol, Ethylene Oxide, 1,3 Butadiene, Epichlorohydrin, which are known to the State of California to cause birth defects or other reproductive harm. For more information go to www.P65Warnings.ca.gov.

<p>BF46020-O Fuel/Water Separator Spin-on with Open End for Bowl</p>  <p>Contains: Bowl Thread: 3 1/8-10 UN-1B Fits: Racor 215R Assemblies Replaces: Racor R15T Thread: 1 -14 O.D.: 3 13/16 (96.8) Height: 3 9/32 (83.3) F. Gskt: [1] Included O-Ring: [1] Included</p>	<p>BF46025-O Fuel/Water Separator Spin-on with Open End for Bowl</p>  <p>Contains: Bowl Thread: 3 1/8-10UN-1B Fits: Racor R245R Fuel Assembly Replaces: Racor R25T Thread: 1 -14 O.D.: 3 3/4 (95.3) Height: 5 17/32 (140.5) F. Gskt: [1] Included O-Ring: [1] Included</p>
<p>BF46021-O Fuel/Water Separator Spin-on with Open End for Bowl</p>  <p>Contains: Bowl Thread: 3 1/8-10 UN 1B Fits: Racor 230R Fuel Assembly Series Replaces: Racor R20S Thread: 1 -14 O.D.: 3 11/16 (93.7) Height: 4 1/16 (103.2) F. Gskt: [1] Included O-Ring: [1] Included Related To: BF9922-O, BF46022-O (Micron Difference)</p>	<p>BF46026-O Fuel/Water Separator Spin-on with Open End for Bowl</p>  <p>Contains: Bowl Thread: 1 1/4-10 Fits: Racor 225 Series Replaces: Racor R26T; Donaldson P550088; Fleetguard FS1234 Thread: 1 -14 O.D.: 3 3/4 (95.3) Height: 4 21/32 (118.3) F. Gskt: [1] Included O-Ring: [1] Included</p>
<p>BF46022-O Fuel/Water Separator Spin-on with Open End for Bowl</p>  <p>Contains: Bowl Thread: 3 1/8-10 UN-1B Fits: Racor 230R Assembly Replaces: Racor R20T Thread: 1 -14 O.D.: 3 11/16 (93.7) Height: 4 1/32 (102.4) F. Gskt: [1] Included O-Ring: [1] Included Related To: BF9922-O, BF46021-O (Micron Difference)</p>	<p>BF46027-O Fuel/Water Separator Spin-on with Open End for Bowl</p>  <p>Contains: Bowl Thread: 3 3/4-10 ANS Buttress Integral Post Seal Fits: Used in Racor 400, 600 Series Filter Assemblies Replaces: Racor R45S Thread: 1 -14 O.D.: 4 3/8 (111.1) Height: 3 1/2 (88.9) F. Gskt: [2] Included</p>
<p>BF46023-O Fuel/Water Separator Spin-on with Open End for Bowl</p>  <p>Contains: Bowl Thread: 1 1/4-10 Fits: Racor 220R Assemblies (Old Version) Replaces: Racor R24P Thread: 1 -14 O.D.: 3 3/4 (95.3) Height: 3 9/16 (90.5) F. Gskt: [1] Included O-Ring: [1] Included</p>	<p>BF46028-O Fuel/Water Separator Spin-on with Open End for Bowl</p>  <p>Contains: Bowl Thread: 3 1/8-10UN-1B Fits: Racor 320R-RAC-02 Mounting Base; Marine Engines Replaces: Racor S3227 Thread: 1 -14 O.D.: 4 (101.6) Height: 4 1/16 (103.2) F. Gskt: [1] Included O-Ring: [1] Included</p>
<p>BF46024-O Fuel/Water Separator Spin-on with Open End for Bowl</p>  <p>Contains: Bowl Thread: 1 1/4-10 Fits: Used in Model 220RMAM Filter Assembly Replaces: Racor R24T Thread: 1 -14 O.D.: 3 3/4 (95.3) Height: 3 9/16 (90.5) F. Gskt: [1] Included O-Ring: [1] Included</p>	<p>BF46029-O Fuel/Water Separator Spin-on with Open End for Bowl</p>  <p>Contains: Bowl Thread: 3 1/4-10 Fits: Racor Marine Applications Replaces: Racor S3228UL Thread: 1 -14 O.D.: 3 25/32 (96.0) Height: 4 1/32 (102.4) F. Gskt: [1] Included O-Ring: [1] Included</p>

Measurements Are Shown In Inches And (Millimeters)

WARNING: These products can expose you to chemicals, including Diisononyl Phthalate, Carbon black extracts, Nickel, 1,3 Butadiene, Ethylene Oxide, Epichlorohydrin, which are known to the State of California to cause cancer, and Bisphenol, Ethylene Glycol, Ethylene Oxide, 1,3 Butadiene, Epichlorohydrin, which are known to the State of California to cause birth defects or other reproductive harm. For more information go to www.P65Warnings.ca.gov.

BF46030-O Fuel/Water Separator Spin-on with Open End for Bowl
Contains: Bowl Thread: 3 3/4-10 UN-1B
Fits: Used in Racor 660R-RAC, 3120R-RAC Series Assemblies
Replaces: Racor S3232
Thread: 1 -14
O.D.: 3 25/32 (96.0)
Height: 5 1/2 (139.7)
F. Gskt: [2] Included
O-Ring: [1] Included
Related To: BF1350-SP (Sensor Port Version)



BF46036 KIT Set of 2 Fuel Filters
Notes: Filters not sold separately.
Contains: [1] Primary Spin-on with Open Port (Port Thread: M24x5.0 - SPCL)
 [1] Secondary Spin-on
Fits: Ag-Chem Fertilizer Applicators; Challenger Tractors; Fendt Combines; Gleaner Combines; Massey Ferguson Harvesters, Wheel Tractors; Valtra Tractors
Replaces: Agco 837079726, 837091128, 837079727, V837091129; Massey Ferguson V837079718, V837079555, V837079556
Primary Spin-on with Open Port
Thread: 3 21/32 -8 ACME
O.D.: 3 27/32 (97.8)
Height: 6 23/32 (170.2)
F. Gskt: [1] Included
O-Ring: [2] Attached
Secondary Spin-on
O.D.: 3 27/32
Height: 6 1/2
O-Ring: [2] Attached



BF46031 Fuel/Water Separator Spin-on with Open Port
Contains: Port Thread: M36 x 1.5
Fits: 2013 RAM Pickups with 6-408 (6.7L) FI Turbo Diesel Engine
Replaces: Chrysler 68197867AA
Thread: 1 -14
O.D.: 4 1/4 (108.0)
Height: 5 1/2 (139.7)
F. Gskt: [1] Included
O-Ring: [1] Included



BF46032 Fuel Spin-on
Replaces: Mann & Hummel WK962/7
Thread: M18 x 1.5
O.D.: 3 11/16 (93.7)
Height: 8 9/32 (210.3)
I.Gskt: [1] Included



BF46037 In-Line Fuel Filter with Plastic Connector
Fits: Mercedes-Benz Vito
Replaces: Mercedes-Benz A6510903152
O.D.: 3 17/32 (89.7)
Inlet: 3/8
Outlet: 5/16
Length: 4 27/32 (123.0)



PF46033 Fuel Element
Fits: Davco Fuel Systems
Replaces: Davco 230029
O.D.: 3 15/32 (88.1)
I.D.: 21/32 (16.7) One End
Height: 4 5/16 (109.5)
O-Ring: [2] Included
Grommets: [1] Attached



BF46038-D Primary Fuel/Water Separator Element with Drain
Fits: Linde Lift Trucks
Replaces: CEMS 42123; Linde 9839030
O.D.: 3 9/32 (83.3)
Height: 7 5/32 (181.8)
Grommets: [1] Attached



BF46034 Fuel Spin-on
Notes: DISCONTINUED. Replaced by BF46233.
Fits: Volvo Dump Trucks, Excavators, Loaders
Replaces: Volvo 15126069; 21879886
Thread: M32 x 1.5
O.D.: 4 1/4 (108.0)
Height: 10 15/32 (265.9)
I.Gskt: [1] Included



BF46039-D Primary Fuel/Water Separator Element with Drain
Fits: Caterpillar Loaders
Replaces: Caterpillar 3619554
O.D.: 3 15/32 (88.1)
I.D.: 3/4 (19.0) One End
Height: 7 3/4 (196.9)
Grommets: [1] Attached





BF46040-D Secondary Fuel/Water Separator Element with Drain
Fits: Ingersoll-Rand Air Source Plus 185 Compressor with IRX3T Engine
Replaces: Ingersoll-Rand 22532378; Stanadyne 40232
O.D.: 3 1/8 (79.4)
I.D.: 3/4 (19.0)
Height: 5 13/32 (137.3)
Grommets: [1] Attached





Measurements Are Shown In Inches And (Millimeters)

WARNING: These products can expose you to chemicals, including Diisononyl Phthalate, Carbon black extracts, Nickel, 1,3 Butadiene, Ethylene Oxide, Epichlorohydrin, which are known to the State of California to cause cancer, and Bisphenol, Ethylene Glycol, Ethylene Oxide, 1,3 Butadiene, Epichlorohydrin, which are known to the State of California to cause birth defects or other reproductive harm. For more information go to www.P65Warnings.ca.gov.

BF46041-D Primary Fuel/Water Separator Element with Drain

Fits: Allmand Brothers Generators, Equipment
Replaces: CEMS 45658; Allmand Brothers 45658P
O.D.: 3 15/32 (88.1)
I.D.: 7/8 (22.2) One End
Height: 7 13/16 (198.4)
Grommets: [1] Attached

PF46046 Fuel Element

Fits: Deutz Engines
Replaces: Deutz 2931748, 4291525; Fleetguard FF5769; Filtration SN70296
O.D.: 3 3/4 (95.3)
I.D.: 1 25/32 (45.2)
Height: 6 7/16 (163.5)
O-Ring: [1] Attached, [1] Included

BF46042-D Primary Fuel/Water Separator Element with Drain

Fits: Deutz-Fahr TTV7.260 Tractor with Deutz TCD (6.1L) Engine (Interim Tier 4)
Replaces: Deutz 90005119, 243193000; Donaldson P564430; Doosan 46492252
O.D.: 4 7/32 (107.2)
I.D.: 1 1/4 (31.8) One End
Height: 10 1/4 (260.3)
Grommets: [1] Attached

BF46048 Fuel/Water Separator Spin-on with Drain, Sensor Port and Reusable Sensor

Fits: Hyster H50FT Lift Trucks with Cummins QSB 3.3L, Ammann AV85-2 Rollers with Cummins 4BT 3.3-C85 Diesel Engines
Replaces: Cummins 4992119; Fleetguard FS19902
Thread: M24 x 1.5
O.D.: 3 11/16 (93.7)
Height: 6 7/8 (174.6)
A. Gskt: [1] Included

BF46043-D Primary Fuel/Water Separator Element with Drain

Fits: Volvo Industrial Engines
Replaces: Volvo 22116209; Stanadyne 43592
O.D.: 4 7/32 (107.2)
I.D.: 1 1/4 (31.8) One End
Height: 10 1/4 (260.3)
Grommets: [1] Attached

PF46049 Fuel/Water Separator Element

Fits: Caterpillar Excavators, Generators, Loaders
Replaces: Caterpillar 3635819
O.D.: 2 27/32 (72.2)
I.D.: 1 1/32 (26.2) One End
Height: 5 1/2 (139.7)
F. Gskt: [1] Included
O-Ring: [1] Attached, [1] Included

BF46044-D Primary Fuel/Water Separator Element with Drain

Fits: Deutz, Fahr, Same Tractors
Replaces: SDF 90020434
O.D.: 3 1/8 (79.4)
I.D.: 15/16 (23.8) One End
Height: 7 25/32 (197.6)
Grommets: [1] Attached

BF46050 Fuel Pre-Filter Spin-on with Sensor Port

Fits: Genie S-Boom, Scissors and Telehandlers
Replaces: Genie 236260; Bomag 8820065; Caterpillar 4664177; Claas 19951210; Deutz 4130241, 4130650; JLG Industries 70025153
Thread: M16 x 1.5
O.D.: 3 23/32 (94.5)
Height: 7 9/32 (184.9)
I.Gskt: G381-A

BF46045-D Primary Fuel/Water Separator Element with Drain

Fits: John Deere Tractors
Replaces: John Deere RE536195, RE546336, RE548534
O.D.: 3 1/8 (79.4)
I.D.: 7/8 (22.2) One End
Height: 6 1/8 (155.6)
Grommets: [1] Attached

BF46051 In-Line Fuel Filter

Contains: [2] Plastic Caps
 Plastic Drain
Fits: Fiat Doblo II, Fiorino, Qubo, Strada Light-Duty Vehicles
Replaces: Fiat 77363657; Hengst H340WK; Mahle KL567; Mann & Hummel WK853/21
O.D.: 3 1/2 (88.9)
Length: 8 1/16 (204.8)
F. Gskt: [1] Included

BF46052 In-Line Fuel Filter

Contains: [2] Plastic Caps
 Plastic Drain
Fits: Fiat, Ford Light-Duty Vehicles
Replaces: Fiat 77363804; Ford 1578143, 1542785, 9S518N169BA; Hengst H303WK; Mahle KL566; Mann & Hummel WK853/20
O.D.: 3 1/2 (88.9)
Length: 8 1/16 (204.8)
F. Gskt: [1] Included

Measurements Are Shown In Inches And (Millimeters)

WARNING: These products can expose you to chemicals, including Diisononyl Phthalate, Carbon black extracts, Nickel, 1,3 Butadiene, Ethylene Oxide, Epichlorohydrin, which are known to the State of California to cause cancer, and Bisphenol, Ethylene Glycol, Ethylene Oxide, 1,3 Butadiene, Epichlorohydrin, which are known to the State of California to cause birth defects or other reproductive harm. For more information go to www.P65Warnings.ca.gov.

PF46056

Fuel Element



Fits: Multiquip generators and other equipment with Isuzu 4LE2T, 4LE2X Engines
Replaces: Isuzu 8982402790; Wacker 5200017728
O.D.: 3 (76.2)
I.D.: 13/16 (20.6) One End
Height: 5 19/32 (142.1)
O-Ring: [2] Included
Grommets: [1] Attached

PF46057

Fuel Element



Fits: Multiquip generators and other equipment with Isuzu 4LE2T, 4LE2X Engines
Replaces: Isuzu 8982402800; Wacker 5200017727
O.D.: 3 (76.2)
I.D.: 13/16 (20.6) One End
Height: 4 5/16 (109.5)
O-Ring: [2] Included
Grommets: [1] Attached

PF46059

Fuel Element



Fits: Isuzu 4HK1 (5.2L), 4JJ1-TC- (3.0L) Engines Isuzu FTR, NPR, NPR-HD, NPR-XD, NQR, NRR Trucks
Replaces: General Motors Corp. 94561104, 98147525; Isuzu 2945611040, 8981475250, 97780197, FE0040A
O.D.: 2 5/8 (66.55)
I.D.: 11/16 (17.27)
Height: 4 17/32 (115.06)
F. Gskt: [1] Included
O-Ring: [3] Included

BF46061

Fuel Spin-on



Replaces: Donaldson DBB8666; Fleetguard FF5897
Thread: 1 3/4 -12 UN
O.D.: 4 23/32 (119.9)
Height: 14 1/8 (358.6)
O-Ring: [1] Attached

BF46062

Fuel/Water Separator Spin-on with Open Port



Contains: Port Thread: M36 x 1.5
Fits: 2012-16 Chevrolet Express Vans, GMC Savana Vans; 2001-16 Silverado Pickups, GMC Sierra Pickups; 2001-03 Chevrolet Suburban with V8 6.6L Turbo Diesel Engine
Replaces: ACDelco TP3018
Thread: 3 3/8 -8
O.D.: 4 1/32 (102.4)
Height: 6 3/8 (161.9)
O-Ring: [2] Included
Grommets: [1] Attached

BF46064-D

Fuel/Water Separator Element with Drain and Tab Keys



Fits: Mack Freedom MV with Renault E3 Engine
Replaces: Mack 705836525; Wix 33444
O.D.: 4 3/8 (111.3)
I.D.: 1 1/16 (26.7) One End
Height: 9 11/16 (246.1)
Grommets: [1] Attached

BF46065-SPS

Fuel/Water Separator Spin-on with Drain, Sensor Port and Reusable Sensor



Notes: CAUTION:Furnished Gasket must be installed on post for seal.
Contains: Sensor Port Thread M14 x 2 Integral Post Seal
Fits: Volvo Compactors, Paving Equipment; Ingersoll-Rand PF6110 Paver
Replaces: Volvo 43919935, 43802263; Fleetguard FS19732; Hifi/Jura Filtration SN909030; Napa Gold 3732; Wix 33732
Thread: 1 -14 UNS-B
O.D.: 3 21/32 (92.9)
Height: 8 3/8 (212.7)
I.Gskt: [1] Included
F. Gskt: [1] Included

BF46068

Fuel Spin-on with Open Port



Contains: Port Thread: M24 x 5.0
Fits: Case Loaders; New Holland Loaders, Telehandlers, Tranchers
Replaces: Case 84527831
Thread: M94 x 3.0 Buttress
O.D.: 3 27/32 (97.5)
Height: 6 23/32 (170.4)
F. Gskt: [2] Included
O-Ring: [2] Attached

BF46069

Fuel/Water Separator Spin-on with Drain



Notes: Not to be used for applications using WIF sensor.
Fits: Case-International, New Holland Tractors
Replaces: New Holland 84526251; Fleetguard FS19927; Mann & Hummel WK9048X
Thread: M16 x 1.5-6H
O.D.: 3 23/32 (94)
Height: 7 31/32 (202.2)
A. Gskt: [1] Included
F. Gskt: [1] Included

BF46071

Fuel/Water Separator with Bowl and Drain



Fits: Mercedes-Benz Trucks
Replaces: Mann & Hummel WK1060
Thread: 1 -12
O.D.: 4 1/32 (102.4)
Height: 11 (279.4)
I.Gskt: [1] Included

Measurements Are Shown In Inches And (Millimeters)

WARNING: These products can expose you to chemicals, including Diisononyl Phthalate, Carbon black extracts, Nickel, 1,3 Butadiene, Ethylene Oxide, Epichlorohydrin, which are known to the State of California to cause cancer, and Bisphenol, Ethylene Glycol, Ethylene Oxide, 1,3 Butadiene, Epichlorohydrin, which are known to the State of California to cause birth defects or other reproductive harm. For more information go to www.P65Warnings.ca.gov.

BF46072 Fuel/Water Separator with Bowl and Drain
Fits: Volvo Construction Equipment
Replaces: Mann & Hummel WK1060/1; Donaldson P502457, P551067, P551361
Thread: 1 -14
O.D.: 4 1/32 (102.4)
Height: 11 (279.4)
I.Gskt: [1] Included
Related To: BF46083-O (Open End Version)
 BF1339-SP (SP Thd. 1/2-20)
 BF1329-SP (SP Thd. 9/16-18)
 BF1329 (Drain Version)



PF46079 Stacked Fuel/Water Separator Element
Fits: Cummins QSK 19, QSK 23, QSK 38, QSK 50, QSK 60, QST30 Engines (Final Tier 4)
Replaces: Fleetguard FS53014; Davco 69001
O.D.: 5 27/32 (148.3)
I.D.: 1 5/32 (29.7)
Height: 16 5/16 (414.3)
O-Ring: [1] Attached, [2] Included
Grommets: [1] Attached



BF46073 Fuel Water Separator Spin-On with Sensor Port
Contains: Sensor Port Thread M12 x 1.5
Fits: Liebherr A309 Litronic, A311 Litronic Excavators with Deutz TCD2012 L04 Engine, Paus Universa 50-3, 50-4 Utility Vehicle with Deutz Engine
Replaces: Bomag 11110248; Deutz 02113831, 2113831, 02113837, 2113837, 02937814, 2937814; Liebherr 11110248
Thread: 1 -14
O.D.: 4 1/4 (108.0)
Height: 10 19/32 (269)



PF46080 Fuel/Water Separator Element
Fits: Terex TR60 Dump Truck with Cummins Engine
Replaces: Fleetguard FS53015; Davco 68001
O.D.: 5 27/32 (148.3)
I.D.: 1 5/32 (29.7)
Height: 7 15/32 (189.9)
O-Ring: [1] Attached, [2] Included



PF46076 Fuel Element
Fits: 2012-17 Mitsubishi Canter FE125, Canter FE130, Canter FE160, Canter FE180, Canter FG4x4 Trucks with 4P10 Engine
Replaces: Fiat 500054702; Iveco 5801354114, 500054702; Mitsubishi MK667920
O.D.: 2 21/32 (67.6)
I.D.: 7/16 (11.4) One End
Height: 6 13/32 (162.7)
O-Ring: [1] Included



PF46081 Fuel/Water Separator Element
Fits: Kenworth, Peterbilt Trucks
Replaces: Paccar K371011, K371029
O.D.: 4 1/8 (104.6)
I.D.: 13/16 (20.3) One End
Height: 7 3/16 (182.6)
O-Ring: [1] Included



PF46077 Fuel Element
Fits: Kubota Excavators, Tractors
Replaces: Kubota 1583143380; Fleetguard FF5468
O.D.: 1 3/8 (34.9)
I.D.: 7/16 (11.1) One End
Height: 2 25/32 (70.6)
O-Ring: [1] Attached



PF46082 Fuel/Water Separator Element
Fits: Kenworth, Peterbilt Trucks
Replaces: Paccar K371012
O.D.: 4 1/8 (104.6)
I.D.: 13/16 (20.3) One End
Height: 7 3/16 (182.6)
O-Ring: [1] Included



BF46078-D Primary Fuel Element with Drain and Tab Keys
Fits: Ingersoll-Rand Compressors
Replaces: Ingersoll-Rand 22926737
O.D.: 3 1/8 (79.4)
Height: 5 9/32 (134.1)
Grommets: [1] Attached



BF46083-O Fuel/Water Separator with Open End for Bowl
Contains: Bowl Thread: 3 3/4-10 Buttress Integral Post Seal
Fits: Scania Trucks; Doosan Dump Trucks; JCB (J.C. Bamford) Generators
Replaces: Scania 1393640
Thread: 1 -14
O.D.: 4 1/2 (114.3)
Height: 6 3/16 (157.2)
F. Gskt: [2] Included
Related To: BF46072 (Bowl Version)
 BF1329 (Drain Version)
 BF1339-SP (SP Thd. 1/2-20)
 BF1329-SP (SP Thd. 9/16-18)



BF46084 In-Line Fuel Filter
Fits: Caterpillar Equipment
Replaces: Caterpillar 3848512; Perkins T412017
O.D.: 2 5/32 (54.8)
Inlet: 1/2
Outlet: 3/8
Length: 5 5/8 (142.9)



Measurements Are Shown In Inches And (Millimeters)

WARNING: These products can expose you to chemicals, including Diisononyl Phthalate, Carbon black extracts, Nickel, 1,3 Butadiene, Ethylene Oxide, Epichlorohydrin, which are known to the State of California to cause cancer, and Bisphenol, Ethylene Glycol, Ethylene Oxide, 1,3 Butadiene, Epichlorohydrin, which are known to the State of California to cause birth defects or other reproductive harm. For more information go to www.P65Warnings.ca.gov.

BF46085

Fuel Spin-on



Fits: John Deere Dozers; Liebherr Equipment
Replaces: John Deere LW10429946; Liebherr 10044303; Yanmar 12065155020; Fleetguard FF5856
Thread: 1 -14
O.D.: 4 1/4 (108.0)
Height: 5 25/32 (146.8)
I.Gskt: [1] Included

BF46087

Box-Style Fuel Element with Handle



Fits: M.T.U. Engines
Replaces: M.T.U. 0000925105, 925105; Separ 4030; Fleetguard FS19803
Length: 7 7/32 (183.4)
Width: 7 1/4 (184.2)
Height: 2 5/32 (54.8)

PF46088

Fuel Element



Fits: Toyota, Isuzu Applications
Replaces: Toyota 1860400021, 2330087317, 233900L010, 233900L020, 233900L030, 233900L041; Isuzu 8981596930
O.D.: 3 5/16 (84.1)
I.D.: 1 1/32 (8.7)
Height: 3 1/32 (77.0)
A. Gskt: [1] Included
O-Ring: [1] Attached, [1] Included

PF46091

Fuel/Water Separator Element



Fits: International, Kenworth, Peterbilt, Volvo Trucks with Cummins ISX Engines
Replaces: Fleetguard FS19764G
O.D.: 4 7/32 (107.2)
I.D.: 2 1/32 (16.7) One End
Height: 7 1/32 (178.6)
O-Ring: [2] Included

PF46092

Fuel/Water Separator Element



Fits: International LoneStar Trucks
Replaces: Davco 382134; Fleetguard FS19905G
O.D.: 4 7/32 (107.2)
I.D.: 2 1/32 (16.7) One End
Height: 7 1/32 (178.6)
O-Ring: [2] Included

PF46094

Fuel/Water Separator



Fits: International 9900i Trucks; Kenworth T880 Trucks; Mack Pinnacle, CHU613, CXU613 Trucks; Peterbilt 389, 567, 587 Trucks
Replaces: Fleetguard FS19765G
O.D.: 4 7/32 (106.9)
I.D.: 1 1/16 (0.7) One End
Height: 7 1/8 (180.8)
O-Ring: [2] Included
Grommets: [1] Attached

BF46098-O

Fuel/Water Separator Spin-on with Open End for Bowl



Contains: Bowl Thread: 3 3/4-10 UNS B Integral Post Seal
Fits: Freightliner Century Class, Cargo FC80, Cascadia Trucks
Replaces: Alliance ABP/N122-R50419; ACDelco TP1348; Donaldson P551034, P551857; Fleetguard FS19798
Thread: 1 -14
O.D.: 4 1/4 (108.0)
Height: 6 9/32 (159.5)
F. Gskt: [2] Included
Grommets: [1] Attached
Related To: BF1373-SP (Sensor Port Version)

BF46099-O

Fuel/Water Separator Spin-on with Open End for Bowl



Contains: Bowl Thread: 3 3/4-10 UNS 2B Integral Post Seal
Fits: John Deere Equipment
Replaces: John Deere AT365869; Racor R51401; Donaldson P551858; Fleetguard FS19754; Wix 33986
Thread: 1 -14
O.D.: 4 1/4 (108.0)
Height: 8 19/32 (218.3)
F. Gskt: [2] Included
Grommets: [1] Attached

BF46100-O

Fuel/Water Separator with Open End for Bowl



Contains: Bowl Thread: 3 3/4-10 UNS B Integral Post Seal
Fits: John Deere Equipment
Replaces: John Deere AT365870; Racor R51402; Donaldson P551034; Fleetguard FS19538
Thread: 1 -14
O.D.: 4 1/4 (108.0)
Height: 6 7/32 (158.0)
F. Gskt: [2] Included

BF46101-O

Fuel/Water Separator Spin-on with Open End for Bowl



Contains: Bowl Thread: 3 3/4
Fits: Volvo-Penta Marine Diesel Engines
Replaces: Volvo 3817517; Racor R120S-HD; Fleetguard FS19896
Thread: 1 -12
O.D.: 4 1 1/32 (110.3)
Height: 8 1/2 (215.9)
F. Gskt: [2] Included

PF46103

Fuel Strainer



Fits: John Deere Harvesters, Tractors
Replaces: John Deere CQ29104; Hifi/Jura Filtration MO7013
O.D.: 2 3/16 (55.6)
I.D.: 1 25/32 (45.2) One End
Height: 7 13/16 (198.4)

Measurements Are Shown In Inches And (Millimeters)

WARNING: These products can expose you to chemicals, including Diisononyl Phthalate, Carbon black extracts, Nickel, 1,3 Butadiene, Ethylene Oxide, Epichlorohydrin, which are known to the State of California to cause cancer, and Bisphenol, Ethylene Glycol, Ethylene Oxide, 1,3 Butadiene, Epichlorohydrin, which are known to the State of California to cause birth defects or other reproductive harm. For more information go to www.P65Warnings.ca.gov.

BF46104 Fuel Spin-on
Fits: Case Dozers, Loaders; New Holland Loaders, Tractors
Replaces: New Holland 84534796
Thread: M20 x 1.5
O.D.: 3 23/32 (94.5)
Height: 7 3/16 (182.9)
A. Gskt: [1] Included



BF46111 Fuel Spin-on
Fits: Bobcat, Doosan Compressors; Case Loaders; Hino Buses; Yanmar Marine Engines
Replaces: Ingersoll-Rand 22226369; Donaldson P550127; Fleetguard FF253, FF5147
Thread: M20 x 1.5
O.D.: 3 11/16 (93.7)
Height: 3 1/4 (82.6)
A. Gskt: [1] Included



BF46105-O Fuel/Water Separator with Open End for Bowl
Contains: Bowl Thread: 3 3/4
Fits: Mercedes-Benz European, South American Trucks
Replaces: Mercedes-Benz A0004771702, 4771702; Racor R160P, R90DMER03; Fleetguard FS19737
Thread: 1 -14 UNS
O.D.: 4 11/32 (110.3)
Height: 8 1/2 (215.9)
F. Gskt: [2] Included



PF46112 Fuel Element
Fits: Nissan, Opel, Renault European Light-Duty Vehicles
Replaces: Opel 4412830; Nissan 1640500QAC; Renault 7701475229
O.D.: 2 3/4 (69.9)
I.D.: 13/16 (20.6)
Height: 3 3/8 (85.7)
F. Gskt: [2] Included



PF46106 Fuel/Water Separator Element
Fits: Kenworth, Peterbilt Trucks
Replaces: Paccar 1852006PE, 1852006, 2133096PE, 2133096
O.D.: 3 15/16 (100.0)
I.D.: 1 23/32 (43.7) One End
Height: 11 3/32 (281.7)
O-Ring: [1] Included
Grommets: [1] Attached



BF46113-D Fuel/Water Separator Element with Drain
Fits: Gehl Loaders
Replaces: Bobcat 103761801CC; Atlas Copco1310072275; Case CLC103761801; Club Car 103761801; Gehl 245005; Wix SF10147, WF10147
O.D.: 3 15/32 (88.1)
I.D.: 23/32 (18.3)
Height: 4 15/32 (113.5)



PF46108 Fuel/Water Separator Element with Bail Handle
Fits: Dodge 2500, 3500; RAM 2500, 3500 Light-Duty Trucks with 6.7L Turbo Diesel Engine, RAM 4500, 5500 Medium Duty Trucks with 6.7L Engine
Replaces: Chrysler 68157291AA; Cummins 5260529; Fleetguard FS53000; Mopar MO291
O.D.: 4 7/32 (107.2)
I.D.: 1 9/16 (39.7) One End
Height: 5 17/32 (140.5)
O-Ring: [1] Included



BF46116 KIT Set of 2 Fuel Filters
Notes: Filters not sold separately.
Contains: [1] Spin-on [1] Element
Fits: John Deere Combines, Crawler Dozers, Excavators, Feller Bunchers, Forestry Machines, Generators, Loaders, Motor Graders, Skidders, Sprayers, Tractors, Windrowers
Replaces: John Deere RE556406; Racor PFF51572
Spin-on
Thread: 1 -14
O.D.: 4 1/4 (108.0)
Height: 6 1/2 (165.4)
F. Gskt: [1] Included
Element
O.D. 3 3/4
I.D. 1 19/32
Height 6 1/4
O-Ring [1] Included



BF46109-O Fuel Water Separator Spin-on with Open End for Bowl
Contains: Male Bowl Thread: 3 3/4
Fits: Mercedes-Benz Latin America Buses, South America Trucks, Buses, & Vans
Replaces: Mercedes-Benz A3844777015, A9794770015, A9794770015AZ, 3844777015, 9794770015, 9794770015AZ; Racor R120MB, R12030MB
Thread: 1 -12
O.D.: 4 17/32 (115.3)
Height: 6 9/16 (166.9)
A. Gskt: [1] Included
O-Ring: [1] Included



BF46117 Fuel Spin-on
Fits: Mack, Volvo Trucks
Replaces: Mack 23856886; Racor RS250RCR01; Volvo 22094967, 22474709, 23846895
Thread: M32 x 1.5
O.D.: 4 11/32 (110.3)
Height: 8 7/8 (225.4)
A. Gskt: [1] Included



Measurements Are Shown In Inches And (Millimeters)

WARNING: These products can expose you to chemicals, including Diisononyl Phthalate, Carbon black extracts, Nickel, 1,3 Butadiene, Ethylene Oxide, Epichlorohydrin, which are known to the State of California to cause cancer, and Bisphenol, Ethylene Glycol, Ethylene Oxide, 1,3 Butadiene, Epichlorohydrin, which are known to the State of California to cause birth defects or other reproductive harm. For more information go to www.P65Warnings.ca.gov.

PF46118

Fuel Element



Contains: Front End Check Valve
Fits: Volkswagen European Crafters; 2009-11 Mexico Crafters
Replaces: Volkswagen 2E0127159, 2E0127177
O.D.: 2 13/16 (71)
Height: 5 3/16 (131.6)
O-Ring: [2] Included

PF46119

Fuel Strainer



Fits: John Deere Harvesters, Tractors
Replaces: John Deere AH165504
O.D.: 7/8 (22.2)
I.D.: 9/16 (14.3) One End
Height: 5 19/32 (142.1)

BF46122

Fuel/Water Separator with Drain



Fits: Various Excavators, Sprayers, Telehandlers and Tractors with Deutz Engines
Replaces: Deutz 4504438; Racor R60THB1; Fleetguard FS1095
Thread: 1 -14
O.D.: 4 13/32 (111.9)
Height: 7 1/4 (184.2)
A. Gskt: [1] Included

BF46123-O

Fuel/Water Separator with Open End for Bowl



Contains: Male Bowl Thread: 3 3/4
Fits: Mercedes-Benz Buses and Trucks
Replaces: Ford BH0X9N074AA, T22VA, 9C459C340AB; Mercedes-Benz A9584770115, 9584770115; Racor R12010MBAQII
Thread: 1 -12
O.D.: 4 17/32 (115.3)
Height: 7 5/32 (181.9)
A. Gskt: [1] Included
O-Ring: [1] Included

BF46125

Box-Style Fuel Element with Handle



Fits: Fendt Tractors
Replaces: Fendt F916200060010; Fleetguard FS19733
Length: 3 (76.2)
Width: 3 (76.2)
Height: 1 (25.4)

PF46126

Fuel Element



Fits: 2017-21 Chevrolet, GMC Light-Duty Trucks
Replaces: ACDelco TP1014, TP1015; General Motors Corp. 22937279, 23149526, 23304095, 23304096, 23456595, 23459023
O.D.: 3 7/16 (87.5)
 3 5/8 (91.6)
I.D.: 29/32 (23) & 7/16 (11.1)
Height: 4 3/16 (106.4)
O-Ring: [2] Attached, [2] Included

BF46127

Fuel Spin-on



Fits: Bomag Paving Equipment; Kramer Loaders, Telehandlers; JLG Industries Equipment with Deutz Engines
Replaces: Bomag 08820969, 8820969; Caterpillar 4406212; Deutz 214228, 4131531, 4131532, 4132775, 4132776; Genie 214228; JLG Industries 70025161; Wirtgen 2319002
Thread: M18 x 1.5
O.D.: 3 25/32 (96.0)
Height: 5 13/16 (147.6)
A. Gskt: [1] Included

BF46128-D

Primary Fuel/Water Separator Element with Drain



Notes: Reverse Flow
Fits: Doosan Engines
Replaces: WIX WF10169, SF10169
O.D.: 4 3/8 (111.3)
I.D.: 21/32 (16.8) One End
Height: 9 11/16 (246.1)
Grommets: [1] Attached

BF46129

Fuel Spin-on



Notes: Fill Plug pre-installed in filter. Remove after pre-filling filter with fuel prior to installation on application.
Fits: Freightliner; Kenworth; Peterbilt; Volvo Trucks with Cummins ISX11.9, ISX15.0, QSX11.9, X15 Engines
Replaces: Cummins 5365988; Fleetguard FF5825NN; Donaldson DBF6776
Thread: M90 x 2.0
O.D.: 4 23/32 (119.9)
Height: 8 27/32 (224.6)
A. Gskt: [1] Included
O-Ring: [1] Attached
Related To: BF9885 (Standard Version)

PF46130

Fuel Element



Fits: RAM 1500 Pickups with V6-182 (3.0L) FI Turbo Diesel Engines
Replaces: Chrysler 68235275AA
O.D.: 2 21/32 (67.5)
 2 29/32 (73.8)
I.D.: 21/32 (16.7)
Height: 5 11/32 (135.7)
O-Ring: [1] Included

BF46131

Fuel Spin-on



Fits: R.V.I. Trucks with Volvo DTI 11 Engines
Replaces: Racor RS175RCR01; Renault 7421764961; Volvo 22253547, 21764952, 21764961; Fleetguard FF5987
Thread: M32 x 1.5
O.D.: 4 11/32 (110.0)
Height: 6 9/16 (166.9)
F. Gskt: [1] Included

Measurements Are Shown In Inches And (Millimeters)

WARNING: These products can expose you to chemicals, including Diisononyl Phthalate, Carbon black extracts, Nickel, 1,3 Butadiene, Ethylene Oxide, Epichlorohydrin, which are known to the State of California to cause cancer, and Bisphenol, Ethylene Glycol, Ethylene Oxide, 1,3 Butadiene, Epichlorohydrin, which are known to the State of California to cause birth defects or other reproductive harm. For more information go to www.P65Warnings.ca.gov.

BF46134-O Fuel/Water Separator with Open End for Bowl
Contains: Bowl Thread 3 3/4-10 Buttress
Fits: Volvo European FH Series Trucks
Replaces: Racor R90P-D MAX; Volvo 21005832, 21380490, 20782330; Donaldson P954895; Fleetguard FS20053; Mann & Hummel WK11001X
Thread: 1 -14
O.D.: 4 1/4 (108.0)
Height: 7 5/8 (194.1)
A. Gskt: [1] Included
F. Gskt: [1] Included



PF46140 Fuel Element
Fits: 2016-19 Nissan Titan XD
Replaces: Cummins 4378483; Nissan 16403EZ41A
O.D.: 3 9/32 (83.6)
I.D.: 1 23/32 (43.4) One End
Height: 4 13/32 (111.9)
A. Gskt: [1] Included
O-Ring: [1] Included



PF46135 Fuel/Water Separator Element
Fits: Compatible with GreenMAX fuel filter water separator housings (4400, 6600); Tigercat Feller Bunchers, Loaders, Skidders
Replaces: Parker R61691T; Racor 6600R10; Tigercat 213473
O.D.: 4 5/32 (105.4)
I.D.: 1 23/32 (43.7)
Height: 7 7/32 (183.4)
O-Ring: [1] Included



BF46141 Fuel Spin-on
Fits: Used on fuel dispensing pumps that have a 1 3/8 inch thread adapter (gasoline, diesel, biodiesel blends up to B20, and Ultra Low Sulfur Diesel)
Replaces: Cim-tek 260AHS30, 70007, 70066; Petro Clear 40930WA
Thread: 1 3/8 -12
O.D.: 3 11/16 (93.7)
Height: 8 3/4 (222.0)
A. Gskt: G381-A



PF46137 Fuel Element
Notes: Element in Housing is PF46137 KIT
Fits: Bron Drainage Plow; Caterpillar Excavators; Prinoth Carrier Vehicles
Replaces: Caterpillar 3608958
O.D.: 2 15/16 (74.9)
I.D.: 3/4 (19.0) One End
Height: 6 7/32 (157.7)
F. Gskt: [1] Included
O-Ring: [1] Attached



PF46142 Nylon Fuel Strainer
Fits: Hitachi, John Deere Excavators; John Deere Loaders
Replaces: John Deere MIU801025
O.D.: 2 3/32 (53.1)
I.D.: 25/32 (20.1) One End
Height: 2 9/16 (65.1)



PF46137 KIT Fuel Element in Plastic Housing
Notes: Element only is PF46137
Fits: Bron Drainage Plow; Caterpillar Excavators; Prinoth Carrier Vehicles
Replaces: Caterpillar 3608958
PF46137
O.D.: 2 15/16 (74.9)
I.D.: 3/4 (19.0)
Height: 6 7/32 (157.7)
F. Gskt: [1] Included
O-Ring: [1] Attached
Housing
O.D. 3 5/8
Height 8 13/32
O-Ring [1] F. Gskt.



BF46143 Fuel/Water Separator Spin-on with Drain
Replaces: Cimtek 70804; Fleetguard FS1023; Donaldson P550828
Thread: 1 -14
O.D.: 3 11/16 (93.7)
Height: 7 31/32 (202.7)
A. Gskt: [1] Included
O-Ring: [1] Included



PF46138 Fuel Element
Fits: Kobelco SK230SR-3, SK260SR-3, New Holland E260C SR, E230CSR, E230CSR LC Excavators; Hino Trucks
Replaces: Case VH23304EV040, VH23304EV041; New Holland VH23304EV040, VH23304EV041; Hino 23304EV360; Kobelco VH23304EV040, VH23304EV041J1L
O.D.: 3 5/32 (80.3)
I.D.: 9/16 (13.9)
Height: 2 27/32 (72.2)
O-Ring: [4] Included
Grommets: [2] Attached



PF46145 Fuel/Water Separator Element
Fits: Freightliner 114SD, 112SD, Cascadia, Cascadia Evolution, Coronado, Coronado SD, M2 112; Western Star 4700, 4800, 4900EX, 4900FA, 4900SA, 5700XE, 6900XD
Replaces: Detroit Diesel A0000905051; Freightliner A485007; Fleetguard FS20083
O.D.: 6 (152.4)
I.D.: 2 15/32 (63.0) One End
Height: 7 17/32 (191.5)
O-Ring: [1] Attached, [2] Included
Grommets: [1] Attached



Measurements Are Shown In Inches And (Millimeters)

WARNING: These products can expose you to chemicals, including Diisononyl Phthalate, Carbon black extracts, Nickel, 1,3 Butadiene, Ethylene Oxide, Epichlorohydrin, which are known to the State of California to cause cancer, and Bisphenol, Ethylene Glycol, Ethylene Oxide, 1,3 Butadiene, Epichlorohydrin, which are known to the State of California to cause birth defects or other reproductive harm. For more information go to www.P65Warnings.ca.gov.

BF46147-O



Fuel/Water Separator with Open End for Bowl
Contains: Bowl Thread 3 3/4-10 ANS Buttress
Fits: Freightliner FS-65 Buses; Ingersoll-Rand Equipment
Replaces: Case 84211170; Racor R60P; Volvo 13224043, 13224043V; Ingersoll-Rand 13224043, 13224043IR
Thread: 1 -14 UNS-2B
O.D.: 4 1/4 (108.0)
Height: 5 3/32 (129.4)
F. Gskt: [2] Included
Related To: BF1329 (Drain Version)
 BF1329-SP (SP Thd. 9/16-18)
 BF1339-SP (SP Thd. 1/2-20)

BF46149-SP



Fuel/Water Separator Spin-on
Notes: Remove preinstalled drain bolt before installation.
Contains: Sensor Port
 Drain Thread: M8 x 1.25
Fits: Kubota Engines
Replaces: Kubota 1J43043060; Fleetguard FS1251; Mann+Hummel PL150
Thread: M16 x 1.5
O.D.: 3 1/32 (77.0)
Height: 5 29/32 (149.9)
A. Gskt: [1] Included

BF46150-O



Fuel/Water Separator with Open End for Bowl
Contains: Bowl Thread 3 3/4 - 10
Fits: Case-International, New Holland Harvesters, Tractors
Replaces: Case 84423586; Racor S3207P
Thread: 1 1/4 - 12
O.D.: 4 27/32 (122.9)
Height: 9 29/32 (251.5)
F. Gskt: [2] Included

PF46151



Fuel Element
Fits: John Deere Lawn & Garden Equipment, Loaders, Tractors; Gehl Loaders, Manitou Loaders, Mustang Loaders
Replaces: Gehl 50352550; John Deere MIU802421; Takeuchi Y129A0055730; Yanmar 129A0055730; Wix WF10369
O.D.: 3 3/8 (85.9)
I.D.: 3/4 (19.3) One End
Height: 4 17/32 (115.3)
Grommets: [1] Attached

PF46152



Fuel/Water Separator Element
Fits: RAM 2500, 3500, 2019 4500, 5500 Trucks; 2021 Jeep Wrangler
Replaces: Chrysler 68436631AA
O.D.: 4 1/32 (102.4)
I.D.: 1 3/16 (30.5) & 21/32 (16.8)
Height: 4 7/32 (107.2)
O-Ring: [2] Attached, [1] Furnished

BF46156



Fuel Spin-on with Open Port
Fits: John Deere Dozers, Excavators, Forestry Equipment, Generators, Harvesters, Industrial Engines, Loaders, Motor Graders, Sprayers, Tractors
Replaces: John Deere DZ115391, RE551507
Thread: M94 x 3.0 Buttress
O.D.: 3 27/32 (97.5)
Height: 6 23/32 (170.4)
F. Gskt: [2] Included
O-Ring: [1] Attached

BF46157



Fuel Spin-on
Fits: John Deere Dozers, Generators, Harvesters, Industrial Engines, Loaders, Motor Graders, Sprayers, Tractors
Replaces: John Deere DZ115390, RE551508
Thread: M94 x 3.0 Buttress
O.D.: 3 27/32 (97.5)
Height: 5 5/16 (134.9)
O-Ring: [1] Attached

BF46158



Fuel Spin-on
Fits: John Deere Dozers, Forestry Equipment, Harvesters, Loaders, Motor Graders, Sprayers, Tractors
Replaces: John Deere DZ115392, RE560681
Thread: M94 x 3.0 Buttress
O.D.: 3 27/32 (97.5)
Height: 6 1/2 (164.8)
O-Ring: [2] Attached

BF46159



Fuel Spin-on with Open Port
Contains: Port Thread: M24 x 5.0
Fits: John Deere Tractors
Replaces: John Deere DZ115389, RE560682
Thread: M94 x 3.0 Buttress
O.D.: 3 27/32 (97.5)
Height: 5 17/32 (140.7)
F. Gskt: [2] Included
O-Ring: [2] Attached

BF46161



Fuel Spin-on
Fits: Volvo Buses, European Trucks & Vans, North America Trucks, Dump Trucks, Excavators, Loaders, Motor Graders; Winpower Generators
Replaces: Volvo 22480372; Mann & Hummel WDK11102/28
Thread: M32 x 1.5 -6H
O.D.: 4 1/4 (108.0)
Height: 10 15/32 (265.9)
A. Gskt: [1] Included

BF46162-O



Fuel/Water Separator with Open End for Bowl
Contains: 3 1/8-10 UN1B SPL
Fits: Racor 215R Fuel Filter Assembly
Replaces: Northern Lights/Lugger 2450014; Racor R15P
Thread: 1 -14
O.D.: 3 5/16 (95.1)
Height: 3 15/16 (83.6)
F. Gskt: [1] Included
O-Ring: [1] Included

Measurements Are Shown In Inches And (Millimeters)

WARNING: These products can expose you to chemicals, including Diisononyl Phthalate, Carbon black extracts, Nickel, 1,3 Butadiene, Ethylene Oxide, Epichlorohydrin, which are known to the State of California to cause cancer, and Bisphenol, Ethylene Glycol, Ethylene Oxide, 1,3 Butadiene, Epichlorohydrin, which are known to the State of California to cause birth defects or other reproductive harm. For more information go to www.P65Warnings.ca.gov.

BF46163-O Fuel/Water Separator Spin-on with Open Port
Contains: Spin-on Drain and Hose Barb
Fits: Western Star 4900, 4900E, 4900EX, 4900FA, 4900SA Trucks with Cat C15 (14.6L) Engine
Replaces: Alliance ABPN122R50424; Donaldson P551856; Fleetguard FS20094
Thread: 1 -14 UNS
O.D.: 4 1/4 (108.0)
Height: 6 1/8 (155.6)



BF46164-O Fuel/Water Separator with Open End for Bowl
Notes: Bowl Thread: 2 3/8-10 Whitworth
Fits: Replacement element for Racor 120A and 120B assemblies
Replaces: Racor R13P
Thread: M18 x 1.5
O.D.: 3 (76.2)
Height: 3 31/32 (100.6)
F. Gskt: [1] Included
O-Ring: [1] Included



BF46169-O Fuel/Water Separator with Open End for Bowl
Contains: Bowl Thread 3 3/4-10 ANS Buttress
Fits: Blue Bird All American, Vision School Buses; International 4300, 4300LP, 4400, 7400, 7500, HV507, HV607 Trucks
Replaces: Blue Bird 10054676, R34000BB01; IHC (International Harvester) 4080114C1, 4080114C2
Thread: 1 -14
O.D.: 4 7/32 (107.4)
Height: 6 1/8 (155.3)
F. Gskt: [2] Included



BF46170 Fuel/Water Separator Spin-on with Drain
Contains: Hose Barb
Fits: Cummins S3.8-G7 Engines; C22 D5T, C44 D5, C55 D5, C66 D5 Power Generators
Replaces: Fleetguard FS19652
Thread: 13/16 -18
O.D.: 3 11/16 (93.7)
Height: 7 1/2 (190.2)
A. Gskt: [1] Included
F. Gskt: [1] Included



PF46171 Fuel/Water Separator Element
Fits: Autocar, Freightliner, Western Star Trucks
Replaces: Detroit Diesel A0000904851; Freightliner A245007; Fleetguard FS20081
O.D.: 3 31/32 (101.1)
I.D.: 1 5/16 (33.0) One End
Height: 7 7/8 (199.9)
O-Ring: [1] Attached, [2] Furnished



PF46172 KIT Fuel Filter Kit
Fits: 2017-19 Ford F650 & F750 w/V8-406 (6.7L) Turbo Diesel Eng.
Replaces: Ford HC4Z9N184A; Motorcraft FD4626
Primary In-Line Fuel
O.D.: 3 15/16 (100.1)
Inlet: 0.5 (12.7)
Outlet: 0.5 (12.7)
Height: 4 9/32 (108.7)
O-Ring: [1] Included
Secondary Fuel Element
O.D. 3 29/32
I.D. 2 19/32
Height 5 9/32



BF46173-O Fuel/Water Separator with Open End for Bowl
Contains: Bowl Thread: 3-3/4-10 UNS-2B SPECIAL
Fits: Volvo North America Trucks with Cummins ISX Engines
Replaces: Racor S3238T; Volvo 85121709
Thread: 1 1/4 -12
O.D.: 4 27/32 (122.7)
Height: 6 9/32 (159.7)
F. Gskt: [2] Included



BF46175 Fuel Spin-on
Fits: Takeuchi TL6R, TL8, TL10, TL10V2, TL12, TL12V2, TL12R2 Loaders
Replaces: Kubota AFK1J30143170, K1J30143170, 1J30143170; Takeuchi AFK1J30143170, K1J30143170, 1J30143170; Wix WF10456
Thread: 1 -14
O.D.: 3 23/32 (94.2)
Height: 5 23/32 (145.5)
A. Gskt: [1] Included



BF46176 Fuel Spin-on
Fits: AirDog I, AirDog II and AirDog II-4G Fuel Systems
Replaces: AirDog FF100-2, FF803
Thread: 7/8 -14
O.D.: 3 1/16 (78.0)
Height: 5 7/8 (149.1)
A. Gskt: [1] Included



BF46179 Fuel Spin-on
Notes: Fill Plug pre-installed in filter. Remove after pre-filling filter with fuel prior to installation on application.
Fits: International, Kenworth, Peterbilt, Volvo, Western Star Trucks
Replaces: Fleetguard FF5811
Thread: M90 x 2.0
O.D.: 4 23/32 (119.9)
Height: 11 9/16 (293.7)
I.Gskt: [1] Included
Related To: BF9860 (Standard Version)



Measurements Are Shown In Inches And (Millimeters)

WARNING: These products can expose you to chemicals, including Diisononyl Phthalate, Carbon black extracts, Nickel, 1,3 Butadiene, Ethylene Oxide, Epichlorohydrin, which are known to the State of California to cause cancer, and Bisphenol, Ethylene Glycol, Ethylene Oxide, 1,3 Butadiene, Epichlorohydrin, which are known to the State of California to cause birth defects or other reproductive harm. For more information go to www.P65Warnings.ca.gov.

BF46181-O Fuel/Water Separator with Open End for Bowl
Contains: Bowl Thread: 3 3/4 - 10
Fits: International, Mack Trucks
Replaces: IHC (International Harvester) 2514003C1; Racor R33838
Thread: 1 -14
O.D.: 4 1/4 (108.0)
Height: 5 21/32 (143.5)
F. Gskt: [2] Included



BF46182-O Fuel/Water Separator Spin-on with Open End for Bowl
Contains: Bowl Thread 3 1/8 - 10
Fits: Mack, Volvo North America Trucks
Replaces: Mack 22094987; Volvo 21764964
Thread: 1 -14
O.D.: 4 7/32 (106.9)
Height: 5 1/32 (127.5)
F. Gskt: [1] Included
O-Ring: [1] Included



FB46183 Fuel Storage Tank Filter Base
Notes: Cast Iron
Use With: BF955, BF956
Replaces: Wix GFB34
Thread: 1 -12
Inlet: 3/4-14
Outlet: 3/4-14
Height: 3 3/4 (95.3)



FB46184 Replacement Filter Base for Fuel/Water Separators
Contains: Inlet/Outlet with [2] 1/2-14 In. NPT Threaded Stud: 1-12
Use With: BF1213, BF5813
Replaces: Wix 24309
Thread: 1 -12
O.D.: 3 1/2 (88.9)
Height: 3 1/4 (82.6)



FB46185 Fuel Spin-on Replacement Base
Notes: Cast Aluminum
Contains: Dual Inlet/Outlet with [2] Female 1/2-14 In. NPT
Use With: BF1214, BF1218, BF1225, BF1240, BF1220, BF970, BF979, BF584, BF614, BF891, BF892, BF978, BF7529, BF7587, BF7546
Replaces: Wix 24770, 524770
Thread: 1 -14
O.D.: 4 (101.6)
Height: 2 7/8 (73)



PF46186 Fuel Element with Bail Handle
Fits: Audi Q7
Replaces: Bosch 1457070010; Volkswagen 7L6127434C; Wix 33434
O.D.: 4 (101.6)
I.D.: 1 5/8 (41.3)
Height: 3 5/16 (84.1)
F. Gskt: [2] Included, [1] Metal Washer
Grommets: [2] Attached



PF46187 Fuel Element
Fits: Volkswagen Passat with V6-3597cc (3.6L) FI Engine
Replaces: Volkswagen 7P6127177, 7P6127177A; Wix WF10120, SF10120
O.D.: 3 1/32 (77.0)
I.D.: 3 11/16 (93.7)
I.D.: 3/8 (9.5) One End
Height: 4 13/16 (122.2)



PF46188 Fuel Element
Fits: Audi, Volkswagen Automotive with (2.0L) Turbo Diesel Engine
Replaces: Audi 3C0127434; Wix 33256
O.D.: 3 1/8 (79.4)
I.D.: 7/16 (11.1) One End
Height: 5 3/8 (136.5)
F. Gskt: [1] Included



PF46189 Fuel Element
Fits: Volkswagen Passat with 4-1968cc (2.0L) FI Turbo Diesel Engine
Replaces: Volkswagen 7N0127177B; Wix WF10114
O.D.: 3 1/32 (77.0)
Flange: 3 11/16 (93.7)
I.D.: 3/8 (9.5) One End
Height: 5 5/16 (134.9)



BF46192 In-Line Fuel Filter
Fits: Volkswagen Automotive with (1.9L) Diesel Engine
Replaces: Volkswagen 1H0127401E; Wix 33896
O.D.: 3 9/16 (90.5)
Inlet: 8 MM
Outlet: 8 MM
Length: 7 7/8 (200.0)
O-Ring: [4] Included



BF46193 In-Line Fuel Filter
Fits: 1984 Chevrolet Corvette
Replaces: General Motors Corp. 25055066; Wix 33482
O.D.: 2 9/32 (57.9)
Inlet: 3/8
Outlet: 3/8
Length: 5 1/4 (133.4)





BF46194 In-Line Fuel Filter
Fits: 1975-79 Volkswagen Beetle, 1977-81 Transporter, 1980-86 Vanagon
Replaces: Volkswagen 133133511; Wix 33274
O.D.: 2 3/32 (53.2)
Inlet: 5/16
Outlet: 1/2
Length: 3 5/8 (92.1)





Measurements Are Shown In Inches And (Millimeters)

WARNING: These products can expose you to chemicals, including Diisononyl Phthalate, Carbon black extracts, Nickel, 1,3 Butadiene, Ethylene Oxide, Epichlorohydrin, which are known to the State of California to cause cancer, and Bisphenol, Ethylene Glycol, Ethylene Oxide, 1,3 Butadiene, Epichlorohydrin, which are known to the State of California to cause birth defects or other reproductive harm. For more information go to www.P65Warnings.ca.gov.

BF46195 In-Line Fuel Filter

Fits: 1984-98 Audi, 1981-2002 Ferrari, 1988-89 Merkur, 1982-87 Peugeot, 1985-2009 Saab, 1987-92 Volkswagen, 1981-98 Volvo Automotive
Replaces: Volkswagen 447133511; Volvo 1389450-6; Wix 33291, 33279
O.D.: 3 15/32 (88.1)
Inlet: M14 x 1.5
Outlet: M12 x 1.5
Length: 5 31/32 (151.6)
F. Gskt: [4] Washers Included

BF46201 In-Line Fuel Filter

Fits: 1990-93 Acura Integra
Replaces: Honda 16900-SK7-A30; Wix 33555, 33292
O.D.: 3 13/32 (86.5)
Inlet: M12 x 1.25
Outlet: M12 x 1.25
Length: 3 13/16 (96.8)
F. Gskt: [4] Copper Washers

BF46196 In-Line Fuel Filter

Fits: 1984-87 Honda Civic CRX
Replaces: Honda 16235-PE0-003; Wix 33206
O.D.: 1 9/32 (32.5)
Inlet: 1/4
Outlet: 1/4
Length: 3 5/16 (84.1)

BF46202 In-Line Fuel Filter

Fits: 1989-94 Mazda MPV Van, Light-Duty Trucks
Replaces: Mazda G602-20-490, G607-20-490-A, G607-20-490-B; Wix 33298
O.D.: 2 13/16 (71.4)
Inlet: 5/16
Outlet: 5/16
Length: 5 3/4 (146.0)

BF46197 In-Line Fuel Filter

Notes: OBSOLETE. Availability Limited to Dealer Stock.
Fits: 1980-84 Nissan Light-Duty Trucks
Replaces: Nissan 16400-06W00, 16400-Q0500; Wix 33214
O.D.: 3 (76.2)
Inlet: 11/32
Outlet: 11/32
Length: 2 17/32 (64.3)

BF46203 In-Line Fuel Filter

Fits: 1990-97 Mazda Miata, MX5
Replaces: Mazda B61P-20-490; Wix 33289
O.D.: 2 13/16 (71.4)
Inlet: 5/16
Outlet: 5/16
Length: 6 1/32 (153.2)

BF46198 In-Line Fuel Filter

Fits: 1990-93 Dodge Ram 50; 1990-96 Mitsubishi Light-Duty Trucks; 1986-92 Toyota Supra
Replaces: Mitsubishi MB504754; Toyota 23300-49155; Wix 33503, 33457, 533872, 33872
O.D.: 2 13/16 (71.4)
Inlet: M12 x 1.25
Outlet: M14 x 1.5
Length: 4 5/8 (117.5)
F. Gskt: [2] Metal Washers

BF46204 In-Line Fuel Filter

Fits: 1989-92 Geo, Toyota Automotive
Replaces: Toyota 23300-19145; Wix 33294
O.D.: 2 3/4 (69.9)
Inlet: M14 x 1.5
Outlet: M12 x 1.25
Length: 4 3/16 (106.4)
F. Gskt: [2] Copper Washers

BF46199 In-Line Fuel Filter with Drain

Fits: 1986-88 Volkswagen Automotive with 1.6L Diesel Engine
Replaces: Volkswagen 191127401; Wix 33467, 533467
O.D.: 3 7/16 (87.3)
Inlet: 11/32
Outlet: 11/32
Length: 6 3/32 (154.8)

BF46205 In-Line Fuel Filter

Contains: [1] Hose
[2] Clamps
Fits: 1966-66 Ford Automotive
Replaces: Ford C5AZ-9155-A, C5AZ-9155-B; Motorcraft FG15; Wix 33045
O.D.: 11/16 (17.5)
Inlet: 3/8
Outlet: 1/2-20
Length: 2 27/32 (72.2)
F. Gskt: [1] Included













BF46200 In-Line Fuel Filter

Fits: 1980-83 BMW, 1980-98 Porsche Automotive
Replaces: BMW 13311269244; Porsche 92811014202; WIX 33276
O.D.: 3 5/32 (80.2)
Inlet: M14 x 1.5
Outlet: M14 x 1.5
Length: 5 1/8 (130.2)
F. Gskt: [4] Washers

BF46206 In-Line Fuel Filter

Fits: 1993-97 Toyota Land Cruiser; 1996-97 Lexus LX450
Replaces: Toyota 23300-69045; Wix 33563, 533563
O.D.: 2 13/16 (71.4)
Inlet: M12 x 1.25
Outlet: M12 x 1.25
Length: 5 3/16 (131.8)
F. Gskt: [4] Washers

BF46207 In-Line Fuel Filter

Fits: 1997-2004 Mitsubishi Montero Sport
Replaces: Mitsubishi MR239580; Wix 33580, 533580, 33905
O.D.: 2 9/16 (65.1)
Inlet: 5/16
Outlet: M14 x 1.5
Length: 4 15/16 (125.4)
F. Gskt: [3] Washers

Measurements Are Shown In Inches And (Millimeters)

WARNING: These products can expose you to chemicals, including Diisononyl Phthalate, Carbon black extracts, Nickel, 1,3 Butadiene, Ethylene Oxide, Epichlorohydrin, which are known to the State of California to cause cancer, and Bisphenol, Ethylene Glycol, Ethylene Oxide, 1,3 Butadiene, Epichlorohydrin, which are known to the State of California to cause birth defects or other reproductive harm. For more information go to www.P65Warnings.ca.gov.

<p>BF46208 In-Line Fuel Filter Fits: 1998-2002 Kia Sportage; 1992-95 Mazda Automotive Replaces: Kia K08A-20-490A; Mazda K801-20-490; Wix 33453, 533884, 533631, 533453, 33884, 33631 O.D.: 2 3/4 (69.9) Inlet: 5/16 Outlet: 5/16 Length: 5 17/32 (140.5)</p> 	<p>BF46214 In-Line Fuel Filter Contains: 5/16 In. Return Line Pressure Regulator Clamp Fits: 2009 BMW 740i, 2002-05 745i, 745Li, 2006-09 750i, 2006-08 750Li Replaces: BMW (Bavarian Motor Works) 13327503413, 16126750475; Wix 33601, 533601 O.D.: 2 3/16 (55.6) Inlet: 5/16 Outlet: 5/16 Length: 12 13/32 (315.0)</p> 
<p>BF46209 In-Line Fuel Filter Fits: 1998-2007 Lexus LX470, Toyota Land Cruiser Replaces: Toyota 23300-50090; Wix 33526, 533875, 533526, 33875 O.D.: 2 23/32 (69.1) Inlet: M14 x 1.5 Outlet: 5/16 Length: 4 5/8 (117.5)</p> 	<p>BF46215 In-Line Fuel Filter Contains: Ground Plug Fits: 2001-04 Toyota Sequoia Replaces: Toyota 23030-50010; Wix 33410, 33924 O.D.: 2 9/16 (65.1) Inlet: 5/16 Outlet: M14 x 1.5 Length: 4 9/32 (108.7)</p> 
<p>BF46210 In-Line Fuel Filter Fits: 1999-2005 Mazda Miata, 1999-2001, 2005 MX5 Replaces: Mazda BP4W-13-480, BP4W-20-490B; Wix 33538, 533538 O.D.: 2 3/4 (69.9) Inlet: 5/16 Outlet: 5/16 Length: 6 1/32 (153.2)</p> 	<p>BF46216 In-Line Fuel Filter Fits: 2001-04 Toyota Avalon Replaces: Toyota 23300-20101; Wix 33923 O.D.: 2 9/16 (65.1) Inlet: M14 x 1.5 Outlet: 5/16 Length: 4 1/32 (102.4)</p> 
<p>BF46211 In-Line Fuel Filter Fits: 2004 Chevrolet Tracker; 1999-2005 Suzuki Vitara, Grand Vitara Replaces: Suzuki 15410-65D00; Wix 533882, 533597, 33882, 33597 O.D.: 2 23/32 (69.1) Inlet: 5/16 Outlet: 5/16 Length: 5 3/32 (129.4)</p> 	<p>BF46217 In-Line Fuel Filter with Vapor Diverter Contains: 3/8 In. Return Line 1/4 In. Vapor Diverter Fits: 2004-08 Chrysler Crossfire; 1996-on Mercedes-Benz Automotive, Light-Duty Trucks, Vans Replaces: Chrysler 5097052AA; Mercedes-Benz A0024773001; Wix 33643 O.D.: 2 15/16 (74.6) Inlet: 5/16 Outlet: 5/16 Length: 6 1/8 (155.6)</p> 
<p>BF46212 In-Line Fuel Filter Contains: Ground Connect Fits: 2001-06 Hyundai Accent Replaces: Hyundai 31911-25000; Wix 33235, 533235 O.D.: 2 9/16 (65.1) Inlet: 5/16 Outlet: 5/16 Length: 5 (127.0)</p> 	<p>BF46218 In-Line Fuel Filter Fits: 2004, 2006 Volvo C70, 2004 S40, V40, 2005-09 S60, S60 T5, 2003, 2005-07 XC70 Cross Country, 2004-on S60 R, 2006-on S80, 2003-04, 2007 V70, 2004, 2006 V70 R, 2003, 2005-08 XC90 Replaces: Volvo 30620512; Wix 33605 O.D.: 3 7/16 (87.3) Inlet: 7/16 Outlet: 7/16 Length: 6 1/2 (165.1)</p> 
<p>BF46213 In-Line Fuel Filter Contains: 5/16 In. Return Line Ground Wire Fits: 2002-04 Jeep Liberty Replaces: Chrysler 52100402AE O.D.: 2 1/16 (52.4) Inlet: 5/16 Outlet: 5/16 Length: 17 9/32 (438.9)</p> 	<p>BF46219 In-Line Fuel Filter Fits: 1999-2004 Volvo S80, 2000-04 S80 T6, 2001-on S60, 2001-03 S40, V40, 2003, 2007 S60R, 2003-07 V70, 2004, 2007 S60 T5, XC70, 2005 V70 T5 Replaces: Volvo 30817997; Wix 33603 O.D.: 3 15/32 (88.1) Inlet: 7/16 Outlet: 7/16 Length: 8 1/4 (209.6)</p> 

Measurements Are Shown In Inches And (Millimeters)

WARNING: These products can expose you to chemicals, including Diisononyl Phthalate, Carbon black extracts, Nickel, 1,3 Butadiene, Ethylene Oxide, Epichlorohydrin, which are known to the State of California to cause cancer, and Bisphenol, Ethylene Glycol, Ethylene Oxide, 1,3 Butadiene, Epichlorohydrin, which are known to the State of California to cause birth defects or other reproductive harm. For more information go to www.P65Warnings.ca.gov.

BF46220 In-Line Fuel Filter
Contains: [2] Plastic Clips
 Ground Prong
Fits: 2004-06 Suzuki Verona
Replaces: Suzuki 15410-86200; Wix 33850
O.D.: 2 5/16 (58.7)
Inlet: 1/4
Outlet: 1/4
Length: 6 9/16 (166.7)



BF46228 Fuel Spin-on
Fits: Kubota SVL75-2, SVL75-2C, SVL95-2S, SVL95-2SC Loaders
Replaces: Kubota HHV0051640, V063151640; Wix WF10475
Thread: 3/4 -16
O.D.: 3 1/32 (77.0)
Height: 4 3/32 (103.6)
A. Gskt: [1] Included



BF46221 In-Line Fuel Filter
Contains: 3/16 Inch Return Line
Fits: Audi, Volkswagen Automotive
Replaces: Volkswagen 1K0201051C; Wix 33814
O.D.: 2 13/32 (61.1)
Inlet: 3/16
Outlet: 3/16
Length: 6 15/32 (164.3)



BF46229 In-Line Fuel Filter
Fits: Thermo King Tripac Auxiliary Power Unit
Replaces: Thermo King 13864; Donaldson P553890; Fleetguard FF5864; Luber-finer G6635
O.D.: 2 (50.8)
Inlet: 1/8-27
Outlet: 1/8-27
Length: 3 (76.2)



BF46222 In-Line Fuel Filter
Fits: Fiat 500
Replaces: Chrysler 68086606AA; Wix 33176
O.D.: 1 31/32 (50.0)
 Bracket 3 7/16 (87.3)
Inlet: 3/8
Outlet: 3/8
Length: 6 7/8 (174.6)



BF46230 Fuel Spin-on
Fits: Volkswagen 26.260E Trucks
Replaces: VAG (Volkswagen/Audi Group) 2R0127177E; Volvo 20841523; Donaldson P551523; Fleetguard FF5935; Wix WF10252
Thread: 1 -12
O.D.: 2 13/16 (71.4)
Height: 8 7/32 (209.0)
A. Gskt: [1] Included



BF46223 In-Line Fuel Filter
Fits: 2010-on Cadillac SRX, 2011, 2014-on CTS
Replaces: General Motors 25993215; Wix 33315
O.D.: 2 5/32 (54.8)
Inlet: 3/8
Outlet: 3/8
Length: 6 5/32 (156.4)



BF46233 Fuel Spin-on
Fits: Volvo VAH200, VAH430, VAH630, VHD200, VNL300, VLN430, VNL630, VNL670, VNL730, VNL780, VNM200, VNX630 North America Trucks
Replaces: Renault 7423044513; Volvo 22988765, 23044511
Thread: M32x1.5 -6H
O.D.: 4 1/4 (108.2)
Height: 10 15/32 (265.9)
A. Gskt: [1] Included



BF46224 In-Line Fuel Filter
Fits: 2004-06 Suzuki XL-7
Replaces: Suzuki 1541052D20; Wix WF10009
O.D.: 2 29/32 (73.8)
Inlet: 5/16
Outlet: 5/16
Length: 5 5/16 (134.9)



BF46234 Fuel Spin-on
Contains: Drain Nut
Fits: John Deere Excavators; Multiquip Equipment
Replaces: Isuzu 8982394640, 8982394641, 8982394642, 8983129180
Thread: M82 x 1.5 -6H
O.D.: 4 1/4 (108.0)
Height: 7 7/8 (199.9)
A. Gskt: [1] Included



BF46225 In-Line Fuel Filter with Clamps and Hose
Contains: [1] Hose
 [2] Clamps
Fits: 1968-78 Ford, Mercury, 1975-78 Lincoln Automotive, Light-Duty Trucks
Replaces: Ford D32E-9155-A; Motorcraft FG19B, FG19C; Wix 33019
O.D.: 3/4 (19.0)
Inlet: 5/16
Outlet: 7/8-20
Length: 2 7/32 (56.4)
F. Gskt: [1] Included



PF46235 Fuel/Water Separator
Fits: Freightliner Trucks
Replaces: Detroit Diesel DDER61709; Racor R61709
O.D.: 4 7/32 (107.2)
Height: 7 7/32 (183.4)
O-Ring: [2] Included













BF46227 Fuel Spin-on with Open Port
Fits: Case Diesel Engines, Loaders; Case-International, New Holland, Steyer Tractors
Replaces: New Holland 84278636
Thread: M16 x 1.5-6H
O.D.: 3 23/32 (94.5)
Height: 7 5/32 (181.9)
A. Gskt: [1] Included
F. Gskt: [1] Included



Measurements Are Shown In Inches And (Millimeters)

WARNING: These products can expose you to chemicals, including Diisononyl Phthalate, Carbon black extracts, Nickel, 1,3 Butadiene, Ethylene Oxide, Epichlorohydrin, which are known to the State of California to cause cancer, and Bisphenol, Ethylene Glycol, Ethylene Oxide, 1,3 Butadiene, Epichlorohydrin, which are known to the State of California to cause birth defects or other reproductive harm. For more information go to www.P65Warnings.ca.gov.

<p>PF46236 Fuel/Water Separator Element Fits: Kenworth, Peterbilt Trucks with Cummins Engine Replaces: Paccar K371021; Racor R6176XL10 O.D.: 4 3/32 (104.1) I.D.: 13/16 (20.3) One End Height: 10 13/16 (274.3) O-Ring: [1] Included</p> 	<p>BF46248 Fuel Spin-on Fits: Cummins X15 Truck engines Replaces: Cummins 5575143; Fleetguard FF5971NN Thread: M90 x 2.0 -7H O.D.: 4 23/32 (120.1) Height: 11 9/16 (293.9) A. Gskt: [1] Included</p> 
<p>PF46237 Fuel/Water Separator Element Fits: Kenworth, Peterbilt Trucks with Paccar MX-13 Engine Replaces: Paccar K371022; Racor R61716XL30 O.D.: 4 3/32 (104.1) I.D.: 13/16 (20.3) One End Height: 10 13/16 (274.3) O-Ring: [1] Included</p> 	<p>PF46250 Fuel/Water Separator Element Fits: 2019 Chevrolet Silverado 4500 HD, Silverado 5500 HD, Silverado 6500 HD Replaces: IHC International Harvester 2515892C91; GMC 19405644; ACDelco TP2011 O.D.: 4 1/32 (102.4) Height: 3 31/32 (100.6) O-Ring: [2] Attached</p> 
<p>PF46238 Fuel Element Fits: Peterbilt 365, 520 Trucks Replaces: Paccar K371017, Racor R61716DCM O.D.: 4 1/32 (102.4) I.D.: 13/16 (20.4) & 7/32 (5.4) Height: 7 3/16 (182.6) O-Ring: [2] Included</p> 	<p>BF46251-SP Fuel/Water Separator Spin-on with Drain and Sensor Port Contains: Sensor Port Thread: 9/16-18 Fits: Caterpillar Crawler Tractors, Drilling Equipment, Generators, Gen Set Engines, Loaders, Locomotive Engines, Marine Engines, Off-Highway Trucks Replaces: Caterpillar 3169954, 4385385; Fleetguard FS20130 Thread: 1 1/4 -12 O.D.: 5 3/8 (136.4) Height: 12 29/32 (327.7) A. Gskt: [1] Included</p> 
<p>PF46241 Wire Mesh Fuel Element Fits: Kubota Loaders, Tractors; Multiquip Equipment; Shindaiwa Generators Replaces: Isuzu 8980714010 O.D.: 1 13/32 (35.8) I.D.: 1 (25.4) Height: 1 5/8 (40.9)</p> 	<p>BF46252-SP Fuel/Water Separator Spin-on with Drain and Sensor Port Contains: Sensor Port Thread: 9/16-18 Fits: Caterpillar Crawler Tractors, Excavators, Forestry Equipment, Generators, Gen Set Engines, Loaders, Motor Graders, Off-Highway Trucks, Pipelayers, Pumps, Scrapers, Wheel Tractors Replaces: Caterpillar 4385386; Donaldson P501108; Fleetguard FS20131 Thread: 1 1/4 -12 O.D.: 5 3/8 (136.4) Height: 12 29/32 (327.7) A. Gskt: [1] Included</p> 
<p>BF46242 In-Line Fuel Filter Fits: Onan RV Generators Replaces: Cummins 149234101; Onan 1492341; Wix WF10437 O.D.: 1 5/16 (33.5) Inlet: 0.30 Outlet: 1/8" PT Length: 2 23/32 (69.1)</p> 	<p>BF46256 Fuel Spin-on Fits: Cummins QSK23, QSK38, QSK50, QSK60 Off-Highway Engines Replaces: Cummins 3644985; Fleetguard FF256 Thread: M110 X 2.5 O.D.: 5 3/8 (136.7) Height: 12 3/32 (307) A. Gskt: [1] Attached</p> 

Measurements Are Shown In Inches And (Millimeters)

WARNING: These products can expose you to chemicals, including Diisononyl Phthalate, Carbon black extracts, Nickel, 1,3 Butadiene, Ethylene Oxide, Epichlorohydrin, which are known to the State of California to cause cancer, and Bisphenol, Ethylene Glycol, Ethylene Oxide, 1,3 Butadiene, Epichlorohydrin, which are known to the State of California to cause birth defects or other reproductive harm. For more information go to www.P65Warnings.ca.gov.

PF46258 Fuel Coalescer

Notes: Used on Natural Gas and Propane Applications
Fits: CNG, LNG, and LPG powered vehicles
Replaces: Detroit Diesel 23529393; Gillig 8241341000; Racor CLS4713301, RK4713301, RK47133; New Flyer 6639089
O.D.: 1 11/16 (43.2)
Height: 5 29/32 (149.9)
O-Ring: [3] Included

OAS98000 Oil/Air Separator Spin-on

Fits: DAF Trucks
Replaces: Cummins 4931691; DAF 1686587
Thread: M16 x 1.5
O.D.: 3 (76.2)
Height: 4 29/32 (124.6)
I.Gskt: [1] Included

PF46259 Fuel Element

Fits: 2021 Chevrolet Express 2500, Express 3500; 2021 GMC Savana 2500, Savana 3500
Replaces: ACDelco TP2016; GM General Motors, 84428486, 84428487, 84186990; Opel 23153963; UFI Filters 6726E2X31; Luber-finer L6016F; Wix WF10509
O.D.: 3 11/16 (93.7)
I.D.: 19/32 (14.7) & 11/16 (17.8)
Height: 4 11/32 (110.5)
O-Ring: [2] Attached, [2] Included

OAS98001 Oil/Air Separator Element

Fits: Ingersoll-Rand Compressors
Replaces: Ingersoll-Rand 36845303
O.D.: 5 3/4 (146.0)
 Flange 7 3/16 (182.6)
I.D.: 3 5/16 (84.1) One End
Height: 11 11/16 (296.9)

BD50000 High Efficiency Dual-Flow Lube Spin-on

Fits: Cummins QST30 Engine; Cummins ISX15 Engines
Replaces: Cummins 4367100; Donaldson P559000; Fleetguard LF14000NN
Thread: M95 x 2.5-6H
O.D.: 4 11/16 (119.1)
Height: 11 25/32 (299.2)
I.Gskt: [1] Included
Related To: BD7154 (Standard Version) B40145 (Extended Life version for use on 2020 Cummins X15 Engine)

OAS98002 Oil/Air Separator Element

Notes: OBSOLETE. Availability Limited to Dealer Stock.
CAUTION: Do not remove staples from gaskets. These staples provide electrical grounding continuity between defogger and tank.
Fits: Sullair LS10-25L,H,HH,XH, LS10-30L,H,HH,XH, LS10B-25ACAC Compressors
Replaces: Sullair 250034112, 250034143
O.D.: 6 23/32 (170.7)
 Flange 7 7/8 (200.0)
I.D.: 3 3/8 (85.7) One End
Height: 6 13/16 (173.0)
A. Gskt: [2] Attached

BF63000 Fuel Spin-on

Fits: Autocar, Dennis Eagle, Ford, Freightliner, International, Kenworth, Mack, Peterbilt, Western Star Trucks; Blue Bird Buses; Hyundai Excavators, Loaders; Skyjack Boom Lifts; Macdon Harvesters; Vogeles Paving Equipment (All with Cummins, Paccar Engines)
Replaces: Atlas Copco 3222341179; Cummins 5289121, 5303743, 5304214; Doosan 40050800070, 46587383, 46645085; Fleetguard FF63004, FF63008, FF63009; Hyster 4103452; Hyundai 11Q771010; JCB 333E0268; JLG Industries Inc. 70024315; Sennebogen 169951; Wirtgen 2391354
Thread: S102 x 4
O.D.: 4 (101.6)
I.D.: 1 3/32 (27.9)
Height: 7 13/16 (198.1)
A. Gskt: [2] Included

OAS98003 Oil/Air Separator Element

Notes: OBSOLETE. Availability Limited to Dealer Stock.
CAUTION: Do not remove staples from gaskets. These staples provide electrical grounding continuity between defogger and tank.
Fits: Sullair 260, DPQ260 with Cat C3.4 Engine
Replaces: Sullair 2250078031, 410333, 250034155, 2250078029, 250034153
O.D.: 6 23/32 (170.7)
 Flange 7 7/8 (200.0)
I.D.: 3 13/16 (96.8) One End
Height: 8 11/32 (211.9)
A. Gskt: [1] Attached

OAS98005 Oil/Air Separator Element

Fits: LeRoi Compressors
Replaces: LeRoi 431103, 438891, 431022
O.D.: 5 3/4 (146.0)
 Flange 7 15/32 (189.7)
I.D.: 3 5/16 (84.1) One End
Height: 8 1/8 (206.4)
A. Gskt: [2] Attached

Measurements Are Shown In Inches And (Millimeters)

WARNING: These products can expose you to chemicals, including Diisononyl Phthalate, Carbon black extracts, Nickel, 1,3 Butadiene, Ethylene Oxide, Epichlorohydrin, which are known to the State of California to cause cancer, and Bisphenol, Ethylene Glycol, Ethylene Oxide, 1,3 Butadiene, Epichlorohydrin, which are known to the State of California to cause birth defects or other reproductive harm. For more information go to www.P65Warnings.ca.gov.

OAS98006

Oil/Air Separator Spin-on



Fits: Gardner Denver Compressors
Replaces: Gardner Denver 2116717, 55B57, 2118414
Thread: 1 1/4 -11 BSP
O.D.: 5 17/32 (140.5)
Height: 10 7/8 (276.2)
I.Gskt: [1] Included

OAS98012

Oil/Air Separator Element with Bail Handle



Fits: Tamrock Applications
Replaces: Tamrock 3582228; Donaldson P782915
O.D.: 3 15/16 (100.0)
 Flange 4 1/32 (102.4)
I.D.: 1 15/16 (49.2) One End
Height: 6 1/8 (155.6)
O-Ring: [1] Attached, [1] Included

OAS98008

Oil/Air Separator Element



Notes: OBSOLETE. Availability Limited to Dealer Stock.
CAUTION: Do not remove staples from gaskets. These staples provide electrical grounding continuity between defogger and tank.
Fits: Ingersoll-Rand SSR EP15SU, SSR HP15U Compressors
Replaces: Ingersoll-Rand 39858683, 39760962, 42361196
O.D.: 4 27/32 (123.0)
I.D.: 2 15/32 (62.7) One End
Height: 9 1/16 (230.2)
A. Gskt: [2] Attached

OAS98013

Oil/Air Separator Element



Notes: OBSOLETE. Availability Limited to Dealer Stock.
CAUTION: Do not remove staples from gaskets. These staples provide electrical grounding continuity between defogger and tank.
Fits: Ingersoll-Rand SSR EP250, SSR HP250, SSR XF250, SSR XP250, SSR EP300, SSR HP300, SSR XF300, SSR XF450 Compressors
Replaces: Ingersoll-Rand 39760590, 39742861; Donaldson P530810
O.D.: 14 7/8 (377.8)
 Flange 17 1/4 (438.2)
I.D.: 11 13/32 (289.7) One End
Height: 17 5/16 (439.7)
A. Gskt: [2] Attached

OAS98009

Oil/Air Separator Element



Fits: Ingersoll-Rand SSR EP75, SSR EP100, SSR HP100, SSR XF100 Compressors
Replaces: Ingersoll-Rand 39863857, 39831904
O.D.: 8 5/16 (211.1)
 Flange 13 5/16 (338.1)
I.D.: 5 3/32 (129.4) One End
Height: 14 (355.6)
A. Gskt: [2] Attached

OAS98014

Oil/Air Separator Element



Notes: OBSOLETE. Availability Limited to Dealer Stock.
CAUTION: Do not remove staples from gaskets. These staples provide electrical grounding continuity between defogger and tank.
Fits: Ingersoll-Rand Compressors
Replaces: Ingersoll-Rand 39831888
O.D.: 6 23/32 (170.7)
 Flange 7 7/8 (200.0)
I.D.: 3 13/16 (96.8) One End
Height: 9 1/16 (230.2)
A. Gskt: [2] Attached

OAS98010

Oil/Air Separator Element



Notes: OBSOLETE. Availability Limited to Dealer Stock.
Fits: Sullair LS12-60, LS16E100, LS16-24KT-60, LS16-24KT-75, LS16-60,LS16-75,ACAC, LS16-75L,H,HH,XH, LS16B8-75WCAC, LS16SRF-60, LS16SRF-75, LS20-24KT-100, LS20S Compressors
Replaces: Sullair 250034116, 408167005; Fleetguard AS2356
O.D.: 8 3/8 (212.7)
 Flange 10 3/4 (273.1)
I.D.: 5 1/4 (133.4) One End
Height: 16 3/32 (408.8)
A. Gskt: [1] Attached

OAS98015

Oil/Air Separator Element



Notes: CAUTION: Do not remove staples from gaskets. These staples provide electrical grounding continuity between defogger and tank.
Fits: Ingersoll-Rand R90IU, R110IU, SSR EP125BR, SSR HP125BR,SSR XF125BR, SSR EP150BR, SSR HP150BR, SSR XF150BR, R160IU, SSR EP200BR, SSR HP200BR, SSR XF200BR Compressors
Replaces: Ingersoll-Rand 54509427
O.D.: 10 27/32 (275.4)
 Flange 14 3/4 (374.7)
I.D.: 8 7/32 (208.8) One End
Height: 9 1/16 (230.2)
A. Gskt: [2] Attached

OAS98011









Oil/Air Separator Element

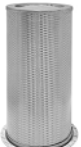

Notes: OBSOLETE. Availability Limited to Dealer Stock.
Fits: Atlas Copco GA11 III, GA11 IV, GA15 III, GA15 IV, GA18 III, GA18 IV, GA22 III, GA22 IV, GA30C III, GA30C IV Compressors
Replaces: Atlas Copco 2901077900; Fleetguard AS2502
O.D.: 5 3/16 (131.8)
 Flange 7 15/16 (201.6)
I.D.: 2 27/32 (72.2) One End
Height: 5 9/16 (141.3)
A. Gskt: [1] Attached
F. Gskt: [2] Included

Measurements Are Shown In Inches And (Millimeters)

WARNING: These products can expose you to chemicals, including Diisononyl Phthalate, Carbon black extracts, Nickel, 1,3 Butadiene, Ethylene Oxide, Epichlorohydrin, which are known to the State of California to cause cancer, and Bisphenol, Ethylene Glycol, Ethylene Oxide, 1,3 Butadiene, Epichlorohydrin, which are known to the State of California to cause birth defects or other reproductive harm. For more information go to www.P65Warnings.ca.gov.

<p>OAS98016 Oil/Air Separator Element  Fits: Ingersoll-Rand SSR EP30SE, SSR XF30S, SSR EP40SE, SSR EP40SE-B, SSR HP40SE-B, SSR HXP40SE-B, SSR EP50, SSR EP50SE, SSR EP50SE-B, SSR HP50SE, SSR HXP50SE, SSR XF50SE, SSR XF50SF Compressors Replaces: Ingersoll-Rand 54595442 O.D.: 6 21/32 (169.1) Flange: 7 7/8 (200.0) I.D.: 3 29/32 (99.2) One End Height: 9 1/16 (230.2) A. Gskt: [1] Attached</p>	<p>OAS98021 Oil/Air Separator Element  Notes: OBSOLETE. Availability Limited to Dealer Stock. Fits: Sullair TS20-100, TS20-125, TS20-150, LS20SE-175, LS20SE-200, TS20-200, TS20-250, TS32-200, TS32-250, TS32-200, LS25/16 TANDEM 100 HP, LS25/16 TANDEM 125 HP, LS25/16 TANDEM 150 HP Compressors Replaces: Sullair 250034122, 250034121 O.D.: 11 23/32 (297.7) Flange: 13 29/32 (353.2) I.D.: 8 11/32 (211.9) One End Height: 26 1/16 (662.0) A. Gskt: [2] Attached</p>
<p>OAS98017 Oil/Air Separator Element  Notes: CAUTION: Do not remove staples from gaskets. These staples provide electrical grounding continuity between defogger and tank. Fits: Sullair Compressors Replaces: Sullair 250034086 O.D.: 10 7/8 (276.2) Flange: 13 29/32 (353.2) I.D.: 7 15/32 (189.7) One End Height: 19 11/16 (500.1) A. Gskt: [2] Attached</p>	<p>OAS98022 Oil/Air Separator Element  Notes: CAUTION: Do not remove staples from gaskets. These staples provide electrical grounding continuity between defogger and tank. Contains: Threaded Stud Fits: Atlas Copco GA11 I GEN 110.001-110.999, GA15 I GEN 150.001-150.999, GA18 I GEN 180.001-180.999, GA22 I GEN 220.001-220.999 Compressors; Chicago Pneumatic S-8, S-8/15, S-8/20, S-8/30H,HH,L,M, 180-Q Com Replaces: Atlas Copco 16123869, 1310250233; M.A.N. 4900152106; Donaldson P525529; Fleetguard AS2392 O.D.: 5 9/32 (134.1) Flange: 8 11/16 (220.7) I.D.: 3 7/16 (87.3) One End Height: 10 7/8 (276.2) F. Gskt: [2] Included O-Ring: [2] Included</p>
<p>OAS98018 Oil/Air Separator Element  Notes: OBSOLETE. Availability Limited to Dealer Stock. Each gasket has 16 holes. Fits: Kaeser BS-44, BS-50, BS-51, BS-60, BS-61 Compressors Replaces: Kaeser 619600, 6.2012.0 O.D.: 6 9/16 (166.7) Flange: 7 7/8 (200.0) I.D.: 4 11/32 (110.3) One End Height: 17 1/2 (444.5) F. Gskt: [2] Included</p>	<p>OAS98023 Oil/Air Separator Element  Notes: OBSOLETE. Availability Limited to Dealer Stock. Contains: Bolt Hole in Flange Fits: Sullair Compressors Replaces: Sullair 250042862, 408167011; Fleetguard AS2388 O.D.: 3 13/16 (96.8) Flange: 10 3/4 (273.1) I.D.: 1 1/2 (38.1) One End Height: 14 1/16 (357.2) A. Gskt: [2] Attached</p>
<p>OAS98019 Oil/Air Separator Element  Fits: Gardner Denver Compressors Replaces: Gardner Denver 202ECH6013, 200ECH035 O.D.: 5 1/2 (139.7) I.D.: 2 5/8 (66.7) One End Height: 12 (304.8)</p>	<p>OAS98024 Oil/Air Separator Element  Notes: OBSOLETE. Availability Limited to Dealer Stock. Fits: Sullair LS20-125L,H,HH,XH,VSD, LS20E-125, LS20S-125, LS20-150L,H,HH,XH,VSD, LS20E-150, USA, LS20S-150, LS20-175L,H,HH,XH Compressors Replaces: Sullair 250034085 O.D.: 10 5/8 (269.9) Flange: 13 25/32 (350.0) I.D.: 7 7/16 (188.9) One End Height: 24 1/2 (622.3) A. Gskt: [2] Attached</p>
<p>OAS98020 Oil/Air Separator Element with Lift Bars  Fits: Gardner Denver Compressors Replaces: Gardner Denver 208EAP6013, 200ECM035 O.D.: 5 1/2 (139.7) I.D.: 2 13/32 (61.1) One End Height: 22 5/8 (574.7) O-Ring: [2] Attached</p>	

Measurements Are Shown In Inches And (Millimeters)
WARNING: These products can expose you to chemicals, including Diisononyl Phthalate, Carbon black extracts, Nickel, 1,3 Butadiene, Ethylene Oxide, Epichlorohydrin, which are known to the State of California to cause cancer, and Bisphenol, Ethylene Glycol, Ethylene Oxide, 1,3 Butadiene, Epichlorohydrin, which are known to the State of California to cause birth defects or other reproductive harm. For more information go to www.P65Warnings.ca.gov.

OAS98025

Oil/Air Separator Element



Notes: OBSOLETE. Availability Limited to Dealer Stock.
CAUTION: Do not remove staples from gaskets. These staples provide electrical grounding continuity between defogger and tank.
Fits: Ingersoll-Rand Compressors
Replaces: Ingersoll-Rand 39737473; Donaldson P782921; Fleetguard AS2418
O.D.: 8 21/32 (219.9)
Flange 11 3/8 (288.9)
I.D.: 5 25/32 (146.8) One End
Height: 9 27/32 (250.0)
A. Gskt: [2] Attached

OAS98026

Oil/Air Separator Element



Notes: OBSOLETE. Availability limited to Dealer Stock.
CAUTION: Do not remove staples from gaskets. These staples provide electrical grounding continuity between defogger and tank.
Fits: Ingersoll-Rand MHP825 Compressor
Replaces: Ingersoll-Rand 89285761
O.D.: 10 7/8 (276.2)
Flange 14 1/8 (358.8)
I.D.: 8 9/32 (210.3) One End
Height: 19 11/16 (500.1)
A. Gskt: [2] Attached

OAS98027

Oil/Air Separator Element



Notes: OBSOLETE. Availability Limited to Dealer Stock.
CAUTION: Do not remove staples from gaskets. These staples provide electrical grounding continuity between defogger and tank.
Contains: Bolt Hole in Flange
Fits: Sullair TS20-100, TS20-125, TS20-150, LS20SE-175, LS20SE-200, TS20-200, TS20-250, LS25/16 TANDEM 100 HP, LS25/16 TANDEM 150 HP Compressors
Replaces: Sullair 250034134
O.D.: 6 25/32 (172.2)
Flange 13 29/32 (353.2)
I.D.: 3 13/16 (96.8) One End
Height: 18 7/16 (468.3)
A. Gskt: [2] Attached

OAS98028

Oil/Air Separator Element



Fits: To 12/2009 Shultz SRP2100, SRP2150, SRP3100, SRP3100SS GD, GDSRP3150E GD, SRP3200 GD, SRP3200FLEX Compressors
Replaces: Tamrock 3340028; Fleetguard AS2458
O.D.: 3 15/16 (100.0)
I.D.: 2 5/32 (54.8) One End
Height: 16 11/32 (415.1)

OAS98029

Oil/Air Separator Element with Bail Handle



Fits: Tamrock Applications
Replaces: Tamrock 3498328; Gardner Denver 301EFC6013
O.D.: 3 29/32 (99.2)
I.D.: 2 7/32 (56.4) One End
Height: 7 5/8 (193.7)

OAS98031

Oil/Air Separator Element



Contains: Bolt Hole plus [8] Holes in Flange
Fits: Sullair LS12, LS12-60 Leak Free, LS16-24KT, LS16-24KT LEAK FREE-60, LS16-75, LS16SRF LEAK FREE-100, LS16SRF-60 LEAK FREE, LS16SRF-75 LEAK FREE, LS20T Compressors
Replaces: Sullair 2250100756, 2250100754
O.D.: 5 3/4 (146.0)
Flange 14 (355.6)
I.D.: 3 1/4 (82.6) One End
Height: 9 11/16 (246.1)
A. Gskt: [2] Attached

OAS98032

Oil/Air Separator Element



Notes: CAUTION: Do not remove staples from gaskets. These staples provide electrical grounding continuity between defogger and tank.
Fits: Sullair LS10-40L,H,HH,XH Compressors
Replaces: Sullair 2250137895
O.D.: 6 23/32 (170.7)
Flange 7 7/8 (200.0)
I.D.: 3 13/16 (96.8) One End
Height: 9 27/32 (250.0)
A. Gskt: [2] Attached

OAS98033

Oil/Air Separator Element



Notes: CAUTION: Do not remove staples from gaskets. These staples provide electrical grounding continuity between defogger and tank.
Contains: [8] Holes in Flange
Fits: Sullair LS12, LS12-60 Leak Free, LS16-24KT, LS16-24KT LEAK FREE-60, LS16-75, LS16SRF LEAK FREE-100, LS16SRF-60 LEAK FREE, LS16SRF-75 LEAK FREE, LS20T Compressors
Replaces: Sullair 2250100755
O.D.: 10 7/8 (276.2)
Flange 14 (355.6)
I.D.: 7 7/16 (188.9) One End
Height: 10 29/32 (277.0)
A. Gskt: [2] Attached

Measurements Are Shown In Inches And (Millimeters)

WARNING: These products can expose you to chemicals, including Diisononyl Phthalate, Carbon black extracts, Nickel, 1,3 Butadiene, Ethylene Oxide, Epichlorohydrin, which are known to the State of California to cause cancer, and Bisphenol, Ethylene Glycol, Ethylene Oxide, 1,3 Butadiene, Epichlorohydrin, which are known to the State of California to cause birth defects or other reproductive harm. For more information go to www.P65Warnings.ca.gov.

OAS98034

Oil/Air Separator Element with Lift Bars



Notes: OBSOLETE. Availability Limited to Dealer Stock.
CAUTION: Do not remove staples from gaskets. These staples provide electrical grounding continuity between defogger and tank.
Fits: Kaeser DSD-125AIR COOLED+SIGMA, DS-141, DSD-150AIR COOLED+SIGMA, DS-171, DSD-172, DSD-172T, DSD-1725, DSD-200AIR COOLED+SIGMA, DS201, DS-241, M260, M270 Compressors
Replaces: Kaeser 621320
O.D.: 15 5/8 (396.9)
 Flange 17 1/16 (433.4)
I.D.: 12 13/32 (315.1) One End
Height: 15 11/16 (398.5)
F. Gskt: [2] Included
O-Ring: [2] Included

OAS98038

Oil/Air Separator Element



Notes: CAUTION: Do not remove staples from gaskets. These staples provide electrical grounding continuity between defogger and tank.
Fits: Sullair Compressors
Replaces: Sullair 250005547; Curtis RN27518; Donaldson P530783; Fleetguard AS2368
O.D.: 8 3/8 (212.7)
 Flange 10 3/4 (273.1)
I.D.: 5 1/4 (133.4) One End
Height: 11 (279.4)
A. Gskt: [2] Attached

OAS98035

Oil/Air Separator Element



Notes: OBSOLETE. Availability Limited to Dealer Stock.
Contains: [6] Bolts
 [1] Mounting Plate
Fits: Quincy Compressors
Replaces: Quincy 127138002
O.D.: 5 3/8 (136.5)
I.D.: 2 1/4 (57.2) One End
Height: 6 3/8 (161.9)
A. Gskt: [1] Attached
F. Gskt: [1] Included
Spring: [1] Included

OAS98039

Oil/Air Separator Element



Notes: OBSOLETE. Availability Limited to Dealer Stock.
CAUTION: Do not remove staples from gaskets. These staples provide electrical grounding continuity between defogger and tank.
Contains: Bolt Hole in Flange
Fits: Sullair LS16-75L,H,HH,XHRA, LS16-100L,H,HH RA,HH USA, LS20-100L,H,HH,XHRA, LS20-125L,H,HH,XH, LS20-150L,H,HH,XH, LS20-175L,H,HH,XH, LS20-220L,H,HH,XH Compressors
Replaces: Sullair 250034128
O.D.: 8 3/8 (212.7)
 Flange 13 29/32 (353.2)
I.D.: 5 25/32 (146.8) One End
Height: 22 17/32 (572.3)
A. Gskt: [2] Attached

OAS98036

Oil/Air Separator Element



Notes: OBSOLETE. Availability Limited to Dealer Stock.
Fits: Atlas Copco Compressors
Replaces: Atlas Copco 2901000401; Fleetguard AS2471
O.D.: 2 9/32 (57.9)
 Flange 8 21/32 (219.9)
I.D.: 3 (76.2) One End
Height: 6 3/4 (171.5)
O-Ring: [2] Included

OAS98040

Oil/Air Separator Element



Notes: OBSOLETE. Availability Limited to Dealer Stock.
Fits: Ingersoll-Rand Compressors
Replaces: Ingersoll-Rand 39739578; Donaldson P525712; Fleetguard AS2263
O.D.: 11 7/8 (301.6)
 Flange 15 1/2 (393.7)
I.D.: 8 7/16 (214.3) One End
Height: 17 29/32 (454.8)
A. Gskt: [2] Attached

OAS98037

Oil/Air Separator Element



Notes: OBSOLETE. Availability Limited to Dealer Stock.
CAUTION: Do not remove staples from gaskets. These staples provide electrical grounding continuity between defogger and tank.
Fits: Sullair 32/25-200, 32/25-300, TS32-200, TS32-250, TS32-300, TS32-350 Compressors
Replaces: Sullair 250034124
O.D.: 18 13/16 (477.8)
 Flange 23 25/32 (604.0)
I.D.: 14 7/8 (377.8) One End
Height: 22 1/4 (565.2)
A. Gskt: [2] Attached

OAS98042

Oil/Air Separator Element with Lift Bars and Lift Tabs



Contains: Threaded Stud
 [2] Springs
 [1] Threaded Nut
 [12] Holes in Each Gasket
Fits: Sullair Elgi TS750, DS900/100, DS900/200, DS900/300, DS-900/350, DT900/350, DS1100-300 Compressors
Replaces: Sullair 2250044197
O.D.: 11 1/2 (292.1)
I.D.: 9 1/4 (235.0) One End
Height: 29 27/32 (758.0)
F. Gskt: [2] Included

Measurements Are Shown In Inches And (Millimeters)

WARNING: These products can expose you to chemicals, including Diisononyl Phthalate, Carbon black extracts, Nickel, 1,3 Butadiene, Ethylene Oxide, Epichlorohydrin, which are known to the State of California to cause cancer, and Bisphenol, Ethylene Glycol, Ethylene Oxide, 1,3 Butadiene, Epichlorohydrin, which are known to the State of California to cause birth defects or other reproductive harm. For more information go to www.P65Warnings.ca.gov.

OAS98043



Oil/Air Separator Element
Notes: OBSOLETE. Availability Limited to Dealer Stock.
Fits: Sullair ES11 Compressor
Replaces: Sullair 225016706
O.D.: 5 7/16 (138.1)
I.D.: 2 11/16 (68.3) One End
Height: 13 11/16 (347.7)
O-Ring: [1] Attached, [1] Included

OAS98044



Oil/Air Separator Element with Lift Tabs
Notes: OBSOLETE. Availability Limited to Dealer Stock.
Fits: Quincy Compressors
Replaces: Quincy 129893
O.D.: 5 3/4 (146.0)
I.D.: 2 5/16 (58.7) One End
Height: 11 7/16 (290.5)

OAS98045



Oil/Air Separator Element
Fits: Sullair ES8 Compressor
Replaces: Sullair 2250106791
O.D.: 3 7/32 (81.8)
I.D.: 1 5/16 (33.3) One End
Height: 11 25/32 (299.2)
A. Gskt: [1] Attached
F. Gskt: [1] Included
O-Ring: [1] Included

OAS98046



Oil/Air Separator Element with Lift Bars
Notes: OBSOLETE. Availability Limited to Dealer Stock.
CAUTION: Do not remove staples from gaskets. These staples provide electrical grounding continuity between defogger and tank.
Fits: Gardner Denver Compressors
Replaces: Gardner Denver 202EDP6013
O.D.: 8 (203.2)
I.D.: 5 21/32 (143.7) One End
Height: 24 21/32 (626.3)
F. Gskt: [1] Included

OAS98049



Oil/Air Separator Element
Notes: OBSOLETE. Availability Limited to Dealer Stock.
Contains: Bolt Hole in Flange
Fits: Sullair LS20 Compressor
Replaces: Sullair 225145897
O.D.: 5 3/4 (146.0)
 Flange 13 3/4 (349.3)
I.D.: 3 9/32 (83.3) One End
Height: 18 3/16 (462.0)
A. Gskt: [2] Attached

OAS98050



Oil/Air Separator Element
Notes: CAUTION: Do not remove staples from gaskets. These staples provide electrical grounding continuity between defogger and tank.
Fits: Ingersoll-Rand SSR EP250BR, SSR HP250BR, SSR XF250BR, SSR XP250BR, SSR EP300BR, SSR EPE300, SSR HP300BR, SSR HP300I, SSR HPE300, SSR XFE300 Compressors
Replaces: Ingersoll-Rand 54509500
O.D.: 13 25/32 (350.0)
 Flange 17 (431.8)
I.D.: 10 7/16 (265.1) One End
Height: 16 15/32 (418.3)
A. Gskt: [2] Attached

OAS98052



Oil/Air Separator Element
Notes: OBSOLETE. Availability Limited to Dealer Stock.
Contains: Bolt Holes in Flange
Fits: Compair 6180N084 Compressor
Replaces: LeRoi 431111
O.D.: 11 7/8 (301.6)
 Flange 13 25/32 (350.0)
I.D.: 8 21/32 (219.9) One End
Height: 19 13/16 (503.2)
A. Gskt: [2] Attached

OAS98053



Oil/Air Separator Element
Fits: Atlas Copco GA110 ELEKTRONIKON MK I, GA110 ELEKTRONIKON MK III To 314.999, GA110 ELETROPNEUMATICO, GA160 ELEKTRONIKON MK I, GA160 ELEKTRONIKON MK III 314.999, GA160 ELETROPNEUMATICO Compressors; Chica
Replaces: Atlas Copco 16146423
O.D.: 13 25/32 (350.0)
 Flange 19 11/16 (500.1)
I.D.: 10 3/8 (263.5) One End
Height: 17 9/16 (446.1)
O-Ring: [2] Included

OAS98054

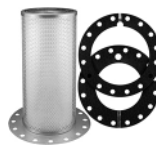

Oil/Air Separator Element
Notes: OBSOLETE. Availability Limited to Dealer Stock.
CAUTION: Do not remove staples from gaskets. These staples provide electrical grounding continuity between defogger and tank.
Fits: Chicago Pneumatic 900-QH with Cummins NTA855C Engine, 950-DPH w/Mercedes-Benz Engine, 950-DUH with Scania DS11 Engine, 950-Q Compressors
Replaces: Atlas Copco 16156038, 1615603801
O.D.: 10 11/32 (262.7)
 Flange 15 3/4 (400.0)
I.D.: 6 1/4 (158.8) One End
Height: 22 1/16 (560.4)
F. Gskt: [2] Included

Measurements Are Shown In Inches And (Millimeters)

WARNING: These products can expose you to chemicals, including Diisononyl Phthalate, Carbon black extracts, Nickel, 1,3 Butadiene, Ethylene Oxide, Epichlorohydrin, which are known to the State of California to cause cancer, and Bisphenol, Ethylene Glycol, Ethylene Oxide, 1,3 Butadiene, Epichlorohydrin, which are known to the State of California to cause birth defects or other reproductive harm. For more information go to www.P65Warnings.ca.gov.

OAS98056 Oil/Air Separator Element
Contains: [6] Holes in Flange
Fits: Atlas Copco GA15 II GEN 151.001-151.999, GA18 II GEN 181.001-181.999, GA22 II GEN 221.001-221.999, GA30 BRP S/N 62855-up, GA30 VSD BRP S/N62855-up Compressors; Chicago Pneumatic S-8/15H,HH,L,M, S-8/20
Replaces: Atlas Copco 16137502, 1613750200
O.D.: 5 9/32 (134.1)
Flange 9 5/8 (244.5)
I.D.: 3 (76.2) One End
Height: 6 7/8 (174.6)
F. Gskt: [2] Included



OAS99001 Oil/Air Separator Element with Foam Wrap
Replaces: Atlas Copco 2911-0068-00; Woodgate WGOS1142
O.D.: 4 15/16 (125.4)
 4 31/32 (126.2)
I.D.: 1 3/32 (27.8)
Height: 7 25/32 (197.6)
O-Ring: [1] Included
Grommets: [2] Attached



OAS98057 Oil/Air Separator Element
Notes: OBSOLETE. Availability Limited to Dealer Stock.
CAUTION: Do not remove staples from gaskets. These staples provide electrical grounding continuity between defogger and tank.
Fits: Sullair S-16 BR Compressor
Replaces: Sullair 250034118; Curtis RN27526; Fleetguard AS2357
O.D.: 8 3/8 (212.7)
Flange 10 3/4 (273.1)
I.D.: 5 1/4 (133.4) One End
Height: 24 3/32 (612.0)
A. Gskt: [2] Attached

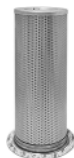

OAS99005 Oil/Air Separator Element
Replaces: Demag 10012674; Woodgate WGOS2101
O.D.: 3 11/16 (93.7)
Flange 5 9/32 (134.1)
I.D.: 2 31/32 (75.4) One End
Height: 6 5/16 (160.3)
F. Gskt: [2] Included



OAS98058 Oil/Air Separator Element
Notes: CAUTION: Do not remove staples from gaskets. These staples provide electrical grounding continuity between defogger and tank.
Contains: [8] Holes in Flange
Replaces: Palatek 8000019
O.D.: 5 3/4 (146.0)
Flange 8 1/2 (215.9)
I.D.: 5 19/32 (142.1) One End
Height: 10 3/32 (256.4)
A. Gskt: [2] Attached



OAS99006 Oil/Air Separator Element
Replaces: Atlas Copco 2989-0051-00; Fleetguard AS2201; Woodgate WGOS2836
O.D.: 6 5/8 (168.3)
Flange 11 13/16 (300.0)
I.D.: 4 13/16 (122.2) One End
Height: 19 9/16 (496.9)
F. Gskt: [2] Included



OAS98060 Oil/Air Separator Spin-on
Fits: Various Air Compressors
Replaces: Ingersoll-Rand 22388045, 24121212, 89259337; Doosan 89259337; Wix P26A734
Thread: M23 x 1.5
O.D.: 3 7/8 (98.4)
Height: 8 1/4 (209.6)
I.Gskt: [1] Included



OAS99008 Oil/Air Separator Element
Replaces: Atlas Copco 4933-5210; Woodgate WGOS4656
O.D.: 10 5/16 (261.9)
Flange 15 3/4 (400.0)
I.D.: 6 1/2 (165.1) One End
Height: 13 31/32 (354.8)
F. Gskt: [2] Included

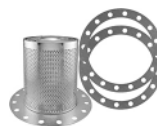

OAS98061 Oil/Air Separator Spin-on
Fits: Ingersoll-Rand Compressors
Replaces: Ingersoll-Rand 54749247; Hifi/Jura Filtration OV6077; Main Filter MF0534266; SF-Filter SPA50022/1; Wix P37A266
Thread: 1 1/2 -16
O.D.: 5 17/32 (140.5)
Height: 11 7/8 (301.6)
O-Ring: [1] Attached



OAS99014 Oil/Air Separator Element
Replaces: Quincy 227052; Fleetguard AS2424; Woodgate WGOS5321
O.D.: 10 3/4 (273.1)
Flange 12 3/4 (323.8)
I.D.: 8 5/8 (219.1) One End
Height: 18 1/16 (458.8)
F. Gskt: [2] Included



OAS99015 Oil/Air Separator Element
Notes: OBSOLETE. Availability Limited to Dealer Stock.
Replaces: Atlas Copco 1619-5498-00; Fleetguard AS2203; Woodgate WGOS5498
O.D.: 6 5/8 (168.3)
Flange 8 21/32 (219.9)
I.D.: 4 13/16 (122.2) One End
Height: 9 17/32 (242.1)
F. Gskt: [2] Included



OAS99017 Oil/Air Separator Element
Fits: Ingersoll-Rand Compressors
Replaces: Ingersoll-Rand 92077601; Fleetguard AS2437; Woodgate WGOS601
O.D.: 5 5/16 (134.9)
Flange 6 31/32 (177.0)
I.D.: 3 15/32 (88.1) One End
Height: 11 7/8 (301.6)
F. Gskt: [2] Included



Measurements Are Shown In Inches And (Millimeters)

WARNING: These products can expose you to chemicals, including Diisononyl Phthalate, Carbon black extracts, Nickel, 1,3 Butadiene, Ethylene Oxide, Epichlorohydrin, which are known to the State of California to cause cancer, and Bisphenol, Ethylene Glycol, Ethylene Oxide, 1,3 Butadiene, Epichlorohydrin, which are known to the State of California to cause birth defects or other reproductive harm. For more information go to www.P65Warnings.ca.gov.

OAS99018 Oil/Air Separator Element
Replaces: Atlas Copco 2252-6313; Fleetguard AS2202; Woodgate WGOS6313
O.D.: 10 27/32 (275.4)
Flange 15 3/4 (400.0)
I.D.: 8 1/2 (215.9) One End
Height: 32 9/32 (819.9)
F. Gskt: [2] Included



OAS99035 Oil/Air Separator Element
Replaces: Tamrock 3267728; Fleetguard AS2462; Woodgate WGOS7728
O.D.: 3 1/16 (77.8)
I.D.: 1 19/32 (40.5) One End
Height: 9 31/32 (253.2)
O-Ring: [1] Attached



OAS99020 Oil/Air Separator Element
Replaces: Ingersoll-Rand 92754688; Fleetguard AS2273; Woodgate WGOS688
O.D.: 6 17/32 (165.9)
Flange 7 11/16 (195.3)
I.D.: 4 9/32 (108.7) One End
Height: 9 1/32 (229.4)
F. Gskt: [2] Included



OAS99038 Oil/Air Separator Element
Replaces: Atlas Copco 2989-0045-00; Fleetguard AS2200; Woodgate WGOS2433
O.D.: 6 5/8 (168.3)
Flange 11 13/16 (300.0)
I.D.: 4 25/32 (121.4) One End
Height: 12 15/16 (328.6)
F. Gskt: [2] Included



OAS99025 Oil/Air Separator Element
Replaces: Atlas Copco 1202-8722; Fleetguard AS2391; Woodgate WGOS8722
O.D.: 5 9/32 (134.1)
Flange 8 21/32 (219.9)
I.D.: 3 (76.2) One End
Height: 6 23/32 (170.7)
F. Gskt: [2] Included



OAS99047 Oil/Air Separator Spin-on
Replaces: Rotorcomp R12101; Donaldson P782909; Fleetguard AS2454
Thread: M39 x 1.5
O.D.: 5 1/2 (139.7)
Height: 12 1/32 (305.6)
I.Gskt: [1] Included



OAS99028 Oil/Air Separator Spin-on
Contains: Integral Post Seal
Replaces: Mann & Hummel LB11102/2; Fleetguard AS2453; Woodgate WGOS1112
Thread: M32 x 1.5
O.D.: 4 11/32 (110.3)
Height: 10 3/8 (263.5)
I.Gskt: [1] Included



OAS99048 Oil/Air Separator Spin-on
Replaces: Rotorcomp R12476; Donaldson P783499; Fleetguard AS2451
Thread: M24 x 1.5
O.D.: 3 27/32 (97.6)
Height: 8 5/16 (211.1)
I.Gskt: [1] Included



OAS99029 Oil/Air Separator Spin-on
Contains: Integral Post Seal
Replaces: Ingersoll-Rand 93525657; Fleetguard AS2452; Woodgate WGOS1374
Thread: M39 x 1.5
O.D.: 5 1/2 (139.7)
Height: 7 3/32 (180.2)
I.Gskt: [1] Included

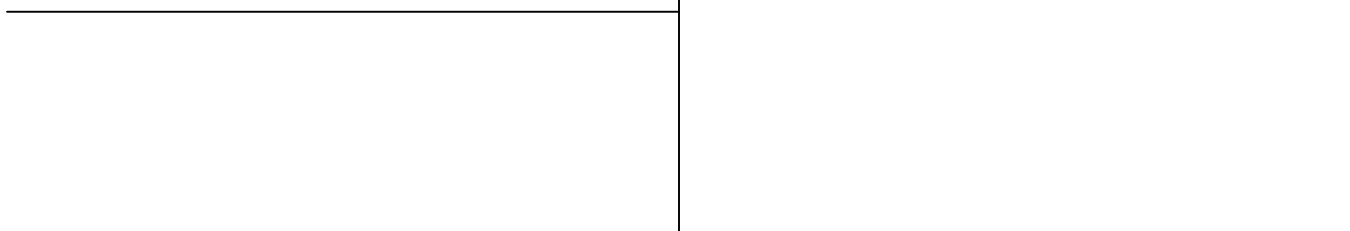

OAS99034 Oil/Air Separator Element
Replaces: Atlas Copco 2911-0015-00; Fleetguard AS2393; Woodgate WGOS4373
O.D.: 8 21/32 (219.9)
Flange 11 13/16 (300.0)
I.D.: 6 9/16 (166.7) One End
Height: 9 17/32 (242.1)
F. Gskt: [2] Included

Measurements Are Shown In Inches And (Millimeters)

WARNING: These products can expose you to chemicals, including Diisononyl Phthalate, Carbon black extracts, Nickel, 1,3 Butadiene, Ethylene Oxide, Epichlorohydrin, which are known to the State of California to cause cancer, and Bisphenol, Ethylene Glycol, Ethylene Oxide, 1,3 Butadiene, Epichlorohydrin, which are known to the State of California to cause birth defects or other reproductive harm. For more information go to www.P65Warnings.ca.gov.

STANADYNE FUEL ADDITIVES

Part Number	Label Language**	Name	Package Size		Quantity Treated		Case Qty. Bottles
			US Gallons	Liters	US Gallons	Liters	
38557	C, P, S	Gasoline Additive	8 oz.	237 ml	up to 18	68	24
38559	C, P	Lubricity Formula™	8 oz.	237 ml	up to 15	60	24
38560	C, P	Lubricity Formula™	16 oz. (Pint)	473 ml	125	470	12
38561	C, P	Lubricity Formula™	64 oz. (1/2 Gallon)	1.9 L	500	1,900	6
38562	C, P	Lubricity Formula™	5 Gallons	19 L	5,000	19,200	1
38563*	C, P	Lubricity Formula™	55 Gallons	208 L	55,000	208,000	1
38564	C, P, S	Performance Formula® All Season	8 oz.	237 ml	up to 30	120	24
38565	C, P, S	Performance Formula® All Season	16 oz. (Pint)	473 ml	60	227	12
38566	C, P, S	Performance Formula® All Season	64 oz. (1/2 Gallon)	1.9 L	240	909	6
38567	C, P, S	Performance Formula® All Season	5 Gallons	19 L	2,500	9,600	1
38568*	C, P, S	Performance Formula® All Season	55 Gallons	208 L	27,500	104,099	1
43562	C, P, S	Performance Formula® Injector Cleaner	8 oz.	237 ml	up to 25	95	24
43564	C, P, S	Performance Formula® Injector Cleaner	16 oz. (Pint)	473 ml	50	189	12
43566	C, P, S	Performance Formula® Injector Cleaner	32 oz. (Quart)	946 ml	100	379	12
43568	C, P, S	Performance Formula® Warm Weather Blend	8 oz.	237 ml	up to 30	114	24
43570	C, P, S	Performance Formula® Warm Weather Blend	16 oz. (Pint)	473 ml	60	227	12
43572	C, P, S	Performance Formula® Warm Weather Blend	64 oz. (1/2 Gallon)	1.9 L	240	909	6
43573*	C, P, S	Performance Formula® Warm Weather Blend	55 Gallons	208 L	27,000	104,099	1
43574	C, P, S	Performance Formula® Warm Weather Blend	5 Gallons	19 L	2,500	9,464	1
38574	C, P	Winter 1000®	16 oz. (Pint)	473 ml	125	470	12
38575	C, P	Winter 1000®	5 Gallons	19 L	5,000	19,200	1
38576*	C, P	Winter 1000®	55 Gallons	208 L	55,000	208,000	1

* 55-Gallon Drums will be special ordered and may be subject to special freight charges. Please call Baldwin Filters Customer Service Department for details.

**Label Language. Label printed in English (P), French (C) and Spanish (S).

Injector Cleaner, Lubricity Formula, Warm Weather Formula

 **WARNING:** This product can expose you to chemicals including Naphthalene and Ethylene Oxide, which are known to the State of California to cause cancer, and Ethylene Oxide, which is known to the State of California to cause birth defects or other reproductive harm. For more information go to www.P65Warnings.ca.gov.

Performance Formula, Winter 1000, Gasoline Additive+

 **WARNING:** This product can expose you to chemicals including Naphthalene, which is known to the State of California to cause cancer, and Toluene which is known to the State of California to cause birth defects or other reproductive harm. For more information go to www.P65Warnings.ca.gov.

<p>Gaskets</p> <p>Numbers with -AF Suffix (Normally on Air Filters)</p>	<p>G37-AF Sponge O-Ring</p> <p>O.D.: 12 (304.8) I.D.: 11 3/8 (288.9) Thick: 5/16 (7.9) Optional On: PA1625</p>	<p>G107 Neoprene Groove Gasket</p> <p>O.D.: 3 57/64 (98.8) I.D.: 3 23/32 (94.5) Thick: 1/8 (3.2) Furnished With: PT62 Optional On: PT70, PT71</p>	<p>G140-A Neoprene Groove Gasket</p> <p>O.D.: 5 15/16 (150.8) I.D.: 5 23/32 (145.3) Thick: 1/8 (3.2) Furnished With: V24-A2, V1645-C, Optional On: PT12</p>
<p>G15-AF Buna N Post Seal</p> <p>O.D.: 1 3/16 (30.2) I.D.: 27/64 (10.7) Thick: 1/8 (3.2) Furnished With: PA2607, PA2773</p>	<p>G39-AF Buna N Post Seal</p> <p>O.D.: 1 1/8 (28.6) I.D.: 3/8 (9.5) Thick: 1/8 (3.2) Furnished With: Various Air Filters</p>	<p>G115-A Buna N Gasket</p> <p>O.D.: 5 1/8 (130.2) I.D.: 4 3/8 (111.1) Thick: 3/32 (2.4) Furnished With: Various Filters Optional On: P40 (Massey Ferguson Applications), PT207 Series, PT951</p>	<p>G141-AF Sponge Boot Gasket</p> <p>O.D.: 18 1/4 (463.6) I.D.: 17 1/4 (438.2) Thick: 2 1/8 (54.0) Furnished With: PA2363, PA2453, PA2507</p>
<p>G21-AF Sponge Gasket with 8 Bolt Holes</p> <p>O.D.: 12 3/4 (323.9) I.D.: 10 1/2 (266.7) Thick: 1/4 (6.4) Furnished With: Various Air Filters</p>	<p>G102-A Buna N Gasket</p> <p>O.D.: 6 9/16 (166.7) I.D.: 6 1/16 (154.0) Thick: 5/64 (2.0) Furnished With: P116, PF116, PF949 Optional On: PT117, PT117-25</p>	<p>G115-MSB Buna N Groove Gasket</p> <p>O.D.: 5 1/64 (127.4) I.D.: 4 25/32 (121.4) Thick: 1/8 (3.2) Furnished With: Various Filters Optional On: PT61-HD, PT72, PT154, PT203-HD, PT203-HD10, PF225, PT670, PT670-E Replaces: Cat 5B5973; IHC 260839-R1</p>	<p>G143 Fiber Gasket</p> <p>O.D.: 5 1/8 (130.2) I.D.: 4 5/8 (117.5) Thick: 1/16 (1.6) Furnished With: PT137, PF846, OB1303 Optional On: P20-HD</p>
<p>ES24-B Buna N Post Seal</p> <p>O.D.: 1 3/16 (30.2) I.D.: 15/16 (23.8) Thick: 7/32 (5.6) Furnished With: BF582, BF591, BF597, BF862 Optional On: BF1102</p>	<p>G103 Buna N Groove Gasket</p> <p>O.D.: 2 59/64 (74.2) I.D.: 2 19/32 (65.9) Thick: 3/32 (2.4) Furnished With: PF847 Optional On: P42</p>	<p>G120-A Buna N Gasket</p> <p>O.D.: 4 3/16 (106.4) I.D.: 3 11/16 (93.7) Thick: 1/16 (1.6) Optional On: PA1963 Attached On: PT568</p>	<p>G144 Fiber Gasket</p> <p>O.D.: 6 3/64 (153.6) I.D.: 5 49/64 (146.5) Thick: 1/16 (1.6) Furnished With: V1656-O, V1656-T</p>
<p>ES24-D Buna N D-Ring Seal</p> <p>O.D.: 1 21/64 (33.7) I.D.: 61/64 (24.2) Thick: 11/64 (4.4) Furnished With: Various Spin-ons Optional On: BF5813</p>	<p>G103-N Steel and Rubber End Seal</p> <p>O.D.: 1 1/4 (31.8) I.D.: 9/16 (14.3) Thick: 1/8 (3.2) Furnished With: Various Air Filters</p>	<p>G123 Buna N Gasket</p> <p>O.D.: 4 5/32 (105.6) I.D.: 3 55/64 (98.0) Thick: 1/16 (1.6) Furnished With: P54, PT151</p>	<p>G145-AF Sponge Gasket with 12 Bolt Holes</p> <p>O.D.: 15 3/4 (400.1) I.D.: 13 3/4 (349.3) Thick: 7/32 (5.6) Furnished With: Various Air Filters</p>
<p>G25-AF Sponge Gasket with 12 Bolt Holes</p> <p>O.D.: 15 (381.0) I.D.: 12 3/4 (323.9) Thick: 1/4 (6.4) Furnished With: Various Air Filters Optional On: LL2438, PA2438, LL2439, PA2439</p>	<p>G104 Buna N Fiber Gasket</p> <p>O.D.: 4 47/64 (120.3) I.D.: 4 11/32 (110.3) Thick: 1/16 (1.6) Furnished With: P41, P42, PT46, PF809, PF821-S Optional On: F225-F, PF225</p>	<p>G127 Buna N Gasket</p> <p>O.D.: 4 17/32 (115.1) I.D.: 4 1/64 (102.0) Thick: 1/16 (1.6) Furnished With: JC405, V738-O, VT842-O Optional On: CU406</p>	<p>G147-A Buna N Groove Gasket</p> <p>O.D.: 3 5/32 (80.2) I.D.: 2 29/32 (73.8) Thick: 1/8 (3.2) Furnished With: Various Filters Optional On: P177</p>
<p>G31-AF Sponge O-Ring</p> <p>O.D.: 11 3/8 (288.9) I.D.: 10 3/4 (273.1) Thick: 5/16 (7.9) Furnished With: PA2658 Optional On: PA639</p>	<p>G105 Fiber Gasket</p> <p>O.D.: 4 3/16 (106.4) I.D.: 3 25/32 (96.0) Thick: 1/16 (1.6) Furnished With: P40, C59-C, S489, F813-F</p>	<p>G132 Buna N Gasket</p> <p>O.D.: 4 15/16 (125.4) I.D.: 4 13/32 (111.9) Thick: 1/16 (1.6) Furnished With: P80, P80-HD, P184</p>	<p>G148 Neoprene Fiber Gasket</p> <p>O.D.: 6 1/32 (153.2) I.D.: 5 17/32 (140.5) Thick: 3/32 (2.4) Furnished With: DF408</p>
<p>G34-AF Sponge O-Ring</p> <p>O.D.: 13 (330.2) I.D.: 12 3/8 (314.3) Thick: 5/16 (7.9) Optional On: PA645 Replaces: Cat 2M6449</p>	<p>G106 Buna N Fiber Gasket</p> <p>O.D.: 4 11/16 (119.1) I.D.: 4 (101.6) Thick: 1/16 (1.6) Furnished With: Various Filters</p>	<p>G133 Buna N Gasket</p> <p>O.D.: 4 1/16 (103.2) I.D.: 3 1/2 (88.9) Thick: 3/32 (2.4) Furnished With: Various Filters Optional On: PT265</p>	<p>G153 Buna N Groove Gasket</p> <p>O.D.: 4 (101.6) I.D.: 3 49/64 (95.6) Thick: 1/8 (3.2) Furnished With: Various Filters</p>



WARNING: These products can expose you to chemicals, including Diisononyl Phthalate, Carbon black extracts, Nickel, 1,3 Butadiene, Ethylene Oxide, Epichlorohydrin, which are known to the State of California to cause cancer, and Bisphenol-A, Ethylene Glycol, Ethylene Oxide, 1,3 Butadiene, Epichlorohydrin, which are known to the State of California to cause birth defects or other reproductive harm. For more information go to www.P65Warnings.ca.gov.

G155
Fiber Cover Gasket
with 12 Bolt Holes

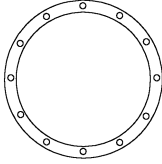

O.D.: 9 3/4 (247.7)
I.D.: 8 5/16 (211.1)
Thick: 1/32 (0.8)
Optional On: C704-L, C750-E, C750-L, C750-L SINGLE, F7040, P7040, F7500, P7500, P7500 SINGLE
Fits: Luber-finer 500-B, 750-B Housings

G157
Buna N O-Ring
(Uniform Dash Number 446)

O.D.: 9 (228.6)
I.D.: 8 15/32 (215.1)
Thick: 9/32 (7.1)
Optional On: C704-L, P706-M, PV706-M, C750-E, C750-L, C750-L SINGLE, P7040, F7500, P7500, P7500 SINGLE
Fits: B7040, B7500 Series Housings; Mack, WGB Dual-Flow Housing
Replaces: Cummins 256981; WGB GA38

G161
Buna N Groove Gasket

O.D.: 3 7/64 (79.0)
I.D.: 2 61/64 (75.0)
Thick: 3/32 (2.4)
Furnished With: PT29, P171, P177, PF816, PF820-S
Optional On: P174

G162
Buna N O-Ring
(Uniform Dash Number 240)

O.D.: 4 (101.6)
I.D.: 3 3/4 (95.3)
Thick: 9/64 (3.6)
Furnished With: P60, PT8359
Optional On: PT90, PT93, PT93-MPG
Replaces: Cat 1H8128

G164-A
Buna N Cover Gasket

O.D.: 5 63/64 (152.0)
I.D.: 5 25/64 (136.9)
Thick: 1/16 (1.6)
Furnished With: P47, PT431
Optional On: PT146, P996, P999, P999-HD, B1000-CD
Fits: Nugent Remote Mount Housings
Replaces: Cummins 69751

G165
Buna N Groove Gasket

O.D.: 3 5/64 (78.2)
I.D.: 2 59/64 (74.2)
Thick: 11/64 (4.4)
Furnished With: P172, P174

G168-B
Buna N Groove Gasket

O.D.: 4 11/32 (110.3)
I.D.: 4 3/32 (104.0)
Thick: 1/8 (3.2)
Furnished With: PT12, P15, P104, P190, P219

G169
Buna N Cover Gasket

O.D.: 5 3/4 (146.1)
I.D.: 5 1/4 (133.4)
Thick: 1/16 (1.6)
Optional On: PF155
Fits: Luber-finer F155 Housings Made Before 9/53 with Flat Head Gasket
Replaces: Luber-finer 1867

G171
Buna N Groove Gasket

O.D.: 4 1/2 (114.3)
I.D.: 4 19/64 (109.1)
Thick: 1/8 (3.2)
Furnished With: PT670, PT670-E
Optional On: PT61-HD, PT66-HD, P80, P80-HD
Replaces: Cat 5B5937

G172-A
Buna N Groove Gasket

O.D.: 3 1/8 (79.4)
I.D.: 2 57/64 (73.4)
Thick: 1/8 (3.2)
Furnished With: P172, P240, P271
Optional On: P176

G183
Cork Gasket

O.D.: 3 3/4 (95.3)
I.D.: 3 1/4 (82.6)
Thick: 1/8 (3.2)
Furnished With: S16-1
Optional On: P171

G184-A
Buna N Groove Gasket

O.D.: 5 9/64 (130.6)
I.D.: 4 51/64 (121.8)
Thick: 3/32 (2.4)
Furnished With: PT154, P203, P204
Optional On: P203-HD, P203-HD10, P204-HD, P204-HD10
Replaces: IHC 381627-R1

G193
Buna N Groove Gasket

O.D.: 7 53/64 (198.8)
I.D.: 7 29/64 (189.3)
Thick: 9/32 (7.1)
Furnished With: PT394-5, PT394-15
Optional On: P194, P194-HD, P194-HD10, PF194
Replaces: Koehring 9006388

G196-B
Buna N Groove Gasket

O.D.: 5 11/16 (144.5)
I.D.: 5 15/32 (138.9)
Thick: 1/8 (3.2)
Furnished With: PT88-HD
Optional On: PT90-10
Replaces: Cat 6F9163

G202
Buna N Groove Gasket

O.D.: 4 11/64 (106.0)
I.D.: 3 15/16 (100.0)
Thick: 3/32 (2.4)
Furnished With: PT213, P235
Optional On: P198

G203
Buna N O-Ring
(Uniform Dash Number 255)

O.D.: 5 7/8 (149.2)
I.D.: 5 39/64 (142.5)
Thick: 9/64 (3.6)
Optional On: PT85, PT90-10
Replaces: Cat 2D8009; Hyster 15895

G204-A
Buna N Groove Gasket

O.D.: 2 23/32 (69.1)
I.D.: 2 15/32 (62.7)
Thick: 5/32 (4.0)
Furnished With: PF827
Optional On: PF224

G206
Buna N O-Ring
(Uniform Dash Number 444)

O.D.: 8 9/32 (210.3)
I.D.: 7 23/32 (196.1)
Thick: 9/32 (7.1)
Furnished With: PT729
Optional On: V1874-T
Fits: Winslow 2075-CE Housings
Replaces: Winslow 296G

G207-AF
Sponge Gasket
with 8 Bolt Holes

O.D.: 11 (279.4)
I.D.: 9 (228.6)
Thick: 1/4 (6.4)
Optional On: LL2503, PA2503

G208-A
Neoprene Gasket

O.D.: 4 13/16 (122.2)
I.D.: 4 3/8 (111.1)
Thick: 1/16 (1.6)
Furnished With: P80, P80-HD
Optional On: P52

G210
Buna N Gasket

O.D.: 7 1/8 (181.0)
I.D.: 6 7/16 (163.5)
Thick: 5/64 (2.0)
Furnished With: PF949
Optional On: PT119, PT119-5, PT119-HD, PT119-HD5, PT119-HD5DL

G211
Buna N O-Ring
(Uniform Dash Number 429)

O.D.: 5 17/32 (140.5)
I.D.: 4 31/32 (126.2)
Thick: 9/32 (7.1)
Furnished With: PT385, PT8338
Optional On: P204, P204-HD, P204-HD10, PT275, PT275-10, PT376, PT385-E
Replaces: GMC 5577310; IHC 343912-R91

G214
Buna N Groove Gasket

O.D.: 4 49/64 (121.1)
I.D.: 4 39/64 (117.1)
Thick: 1/8 (3.2)
Furnished With: PT670
Optional On: PT670-E
Replaces: Cat 5M5999

G219
Buna N O-Ring
(Uniform Dash Number 345)

O.D.: 4 25/64 (111.5)
I.D.: 3 31/32 (100.8)
Thick: 13/64 (5.2)
Furnished With: PF823(6)
Optional On: P82, PT82-HD, PT82-HD10
Replaces: Cat 4F7387

G220
Buna N Groove Gasket

O.D.: 4 9/32 (108.7)
I.D.: 3 31/32 (100.8)
Thick: 1/8 (3.2)
Optional On: PT63-1
Replaces: John Deere A519R

G222-B
Buna N Groove Gasket

O.D.: 4 19/32 (116.7)
I.D.: 4 3/16 (106.4)
Thick: 5/32 (4.0)
Optional On: P82, PT82-HD, PT82-HD10

 **WARNING:** These products can expose you to chemicals, including Diisononyl Phthalate, Carbon black extracts, Nickel, 1,3 Butadiene, Ethylene Oxide, Epichlorohydrin, which are known to the State of California to cause cancer, and Bisphenol-A, Ethylene Glycol, Ethylene Oxide, 1,3 Butadiene, Epichlorohydrin, which are known to the State of California to cause birth defects or other reproductive harm. For more information go to www.P65Warnings.ca.gov.

G225-AF
Sponge Gasket
O.D.: 12 5/8 (320.7)
I.D.: 11 5/8 (295.3)
Thick: 2 1/8 (54.0)
Optional On: LL1886, PA1886

G229
Buna N O-Ring
(Uniform Dash Number 239)
O.D.: 3 57/64 (98.8)
I.D.: 3 39/64 (91.7)
Thick: 9/64 (3.6)
Furnished With: S16-1
Optional On: PF121, PT189,
PT189-MPG
Replaces: Cat 8H7521

G232
Buna N O-Ring
(Uniform Dash Number 338)
O.D.: 3 33/64 (89.3)
I.D.: 3 7/64 (79.0)
Thick: 13/64 (5.2)
Optional On: P106, P106-HD, P107

G233-A
Buna N Small
Head Groove Gasket
O.D.: 3 11/32 (84.9)
I.D.: 3 1/16 (77.8)
Thick: 1/8 (3.2)
Furnished With: P497, BF812,
BF825, BF874, BF884

G233-B
Buna N Groove Gasket
Identified with 2 Stripes
O.D.: 3 15/32 (88.1)
I.D.: 3 3/16 (81.0)
Thick: 1/8 (3.2)
Furnished With: BF812, BF825,
BF874, BF884
Optional On: PF834

G236-A
Buna N O-Ring
(Uniform Dash Number 348)
O.D.: 4 49/64 (121.0)
I.D.: 4 23/64 (110.7)
Thick: 13/64 (5.2)
Furnished With: PT373
Optional On: PT207, PT207-10,
PT207-HD, PT207-HD10, PT433,
PT554
Replaces: Massey Ferguson
515115-M1

G238
Buna N O-Ring
(Uniform Dash Number 445)
O.D.: 8 17/32 (216.7)
I.D.: 7 31/32 (202.4)
Thick: 9/32 (7.1)
Optional On: C704-L, C750-E,
C750-L, C750-L SINGLE,
P7040, F7500, P7500,
P7500 SINGLE
Fits: Early Model Cummins 500,
750 Housings
Replaces: Cummins 145641,
150004

G239
Buna N Groove Gasket
O.D.: 3 9/64 (79.8)
I.D.: 2 31/32 (75.4)
Thick: 5/32 (4.0)
Furnished With: P176
Optional On: P174

G240
Buna N Groove Gasket
O.D.: 5 (127.0)
I.D.: 4 23/32 (119.9)
Thick: 1/8 (3.2)
Furnished With: PF7890 Series
Optional On: PF225

G241
Buna N Groove Gasket
O.D.: 3 7/8 (98.4)
I.D.: 3 11/16 (93.7)
Thick: 1/8 (3.2)
Optional On: PF226

G243-A
Buna N Fiber Cover Gasket
O.D.: 4 5/16 (109.5)
I.D.: 3 15/16 (100.0)
Thick: 1/16 (1.6)
Furnished With: VT842-0

G247
Buna N O-Ring
(Uniform Dash Number 236)
O.D.: 3 33/64 (89.3)
I.D.: 3 15/64 (82.2)
Thick: 9/64 (3.6)
Furnished With: Various Filters
Optional On: PT83, PT83-MPG,
PT382, PF883

G251
Buna N Groove Gasket
O.D.: 4 23/32 (119.9)
I.D.: 4 7/16 (112.7)
Thick: 1/8 (3.2)
Optional On: PT63-1
Replaces: John Deere B3586R

G252
Buna N Square Cut
Cover Gasket
O.D.: 8 1/2 (215.9)
I.D.: 7 31/32 (202.4)
Thick: 17/64 (6.8)
Furnished With: BK6310
Optional On: PT475, P528,
C704-L, C750-E, C750-L,
C750-L SINGLE, P7040, F7500,
P7500, P7500 SINGLE
Fits: Late Model Cummins 500,
750 Housings; Some Fram 750
Housings
Replaces: Cummins 164159;
Fram 230820

G253-A
Fiber Gasket
O.D.: 5 1/4 (133.4)
I.D.: 3 1/2 (88.9)
Thick: 1/16 (1.6)
Furnished With: PT193 KIT
Optional On: PT191, PT191-5,
PT191-10

G255
Buna N Groove Gasket
O.D.: 3 1/2 (88.9)
I.D.: 3 7/32 (81.8)
Thick: 3/32 (2.4)
Furnished With: PT849,
PT849-10

G257
Neoprene Fiber
Cover Gasket
O.D.: 5 11/32 (135.7)
I.D.: 4 51/64 (121.8)
Thick: 1/16 (1.6)
Furnished With: PF899

G260
Buna N Groove Gasket
O.D.: 5 13/32 (137.3)
I.D.: 5 7/32 (132.6)
Thick: 3/32 (2.4)
Furnished With: PT550-10
Optional On: PT268
Replaces: IHC 382247-R1

G261
Pear-Shape Fiber
Cover Gasket

O.D.: 11 1/4 (285.8)
I.D.: 9 9/16 (242.9)
Thick: 1/32 (0.8)
Optional On: PT268
Replaces: IHC 382257-R1

G263
Buna N O-Ring
(Uniform Dash Number 433)
O.D.: 6 1/32 (153.2)
I.D.: 5 15/32 (138.9)
Thick: 9/64 (3.6)
Optional On: PT83, PT83-MPG,
PT90, PT90-10, PT383, P996,
P999, P999-HD, B1000-CD
Fits: Early Base-Mount Nugent &
Cummins Full-Flow Lube Housings
Replaces: Cat 5H6733;
Cummins 116024

G264-A
Buna N Groove Gasket
O.D.: 3 41/64 (92.5)
I.D.: 3 3/8 (85.7)
Thick: 5/32 (4.0)
Furnished With: B10-AL,
B10-AL BSP, PF10, PF10-CS,
PF967

G265
Buna N O-Ring
(Uniform Dash Number 257)
O.D.: 6 9/64 (156.0)
I.D.: 5 55/64 (148.8)
Thick: 1/8 (3.2)
Optional On: PT89,
PT90-10, PT90-MPG, PT94
Replaces: Cat 2K8257;
Murphy MD8274

G268
Buna N Fiber Gasket
O.D.: 3 49/64 (95.6)
I.D.: 3 13/32 (86.5)
Thick: 1/16 (1.6)
Furnished With: P184

G269
Fiber Cover Gasket
with 6 Bolt Holes

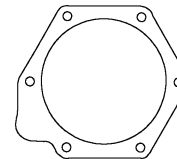

O.D.: 6 5/8 (168.3)
I.D.: 5 1/2 (139.7)
Thick: 1/32 (0.8)
Optional On: P996, P999,
P999-HD, B1000-CD
Fits: Some Nugent & Cummins
Upright Mount Full-Flow Lube
Housings
Replaces: Cummins 154443

G270
Buna N O-Ring
(Uniform Dash Number 233)
O.D.: 3 9/64 (79.8)
I.D.: 2 55/64 (72.6)
Thick: 9/64 (3.6)
Furnished With: PT265, PT273
Optional On: PT66-HD
Replaces: Cat 6H3977

G273
Buna N Groove Gasket
O.D.: 4 33/64 (114.7)
I.D.: 4 17/64 (108.4)
Thick: 3/32 (2.4)
Furnished With: PT185



WARNING: These products can expose you to chemicals, including Diisononyl Phthalate, Carbon black extracts, Nickel, 1,3 Butadiene, Ethylene Oxide, Epichlorohydrin, which are known to the State of California to cause cancer, and Bisphenol-A, Ethylene Glycol, Ethylene Oxide, 1,3 Butadiene, Epichlorohydrin, which are known to the State of California to cause birth defects or other reproductive harm. For more information go to www.P65Warnings.ca.gov.

G274
Cork Neoprene Cover Gasket
 O.D.: 3 1/2 (88.9)
 I.D.: 3 1/8 (79.4)
 Thick: 1/16 (1.6)
 Furnished With: PT210

G275
Fiber Spool Gasket

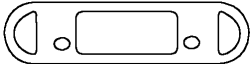

Size: 7 3/4 x 1 7/8 x 1/16
 (196.9 x 47.6 x 1.6)
 Fits: Later Model Nugent Spools using 2 Gaskets (Use G216 for Earlier Models)
 Replaces: Cummins 158019

G278
Buna N Cover Gasket
 O.D.: 5 5/8 (142.9)
 I.D.: 5 7/32 (132.6)
 Thick: 13/64 (5.2)
 Optional On: P999, P999-HD
 Fits: OB1368, Late Cummins Base-Mounted Full-Flow Lube Element-Type Housings
 Replaces: Cummins 153528, 254240

G280
Fiber Gasket
 O.D.: 5 1/64 (127.4)
 I.D.: 4 51/64 (121.8)
 Thick: 3/32 (2.4)
 Optional On: Various Filters

G281
Fiber Cover Gasket with 6 Bolt Holes

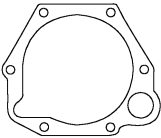

O.D.: 6 5/8 (168.3)
 I.D.: 5 1/2 (139.7)
 Thick: 1/32 (0.8)
 Optional On: P996
 Fits: Some Nugent & Cummins Upright Mount Full-Flow Lube Housings
 Replaces: Cummins 169797

G283
Buna N O-Ring (Uniform Dash Number 232)
 O.D.: 3 1/64 (76.6)
 I.D.: 2 47/64 (69.5)
 Thick: 9/64 (3.6)
 Furnished With: PT542, PT8352
 Optional On: PT66-HD
 Replaces: Cat 5H8848

G285-AF
Sponge Boot
 O.D.: 14 3/8 (365.1)
 I.D.: 13 3/8 (339.7)
 Thick: 2 3/16 (55.6)
 Furnished With: PA2749
 Optional On: PA1975, PA2573, PA2574

G286-C
Buna N Molded Gasket
 O.D.: 5 1/32 (127.8)
 I.D.: 4 1/2 (114.3)
 Thick: 13/32 (10.3)
 Furnished With: Various Filters
 Optional On: Various Filters

G288
Cork Neoprene Cover Gasket with 6 Bolt Holes
 O.D.: 7 (177.8)
 I.D.: 5 1/8 (130.2)
 Thick: 1/16 (1.6)
 Furnished With: PT193 KIT
 Optional On: PT193, PT193-3

G289
Cork Neoprene Cover Gasket with 6 Bolt Holes
 O.D.: 9 5/8 (244.5)
 I.D.: 7 3/4 (196.9)
 Thick: 1/16 (1.6)
 Furnished With: PT193 KIT
 Optional On: PT193, PT193-3

G291
Buna N Molded Gasket
 O.D.: 5 1/64 (127.4)
 I.D.: 4 35/64 (115.5)
 Thick: 3/32 (2.4)
 Furnished With: PT386, PT436, PT571

G293-B
Buna N Molded Gasket
 O.D.: 4 41/64 (117.9)
 I.D.: 3 61/64 (100.4)
 Thick: 19/32 (15.1)
 Integral On: BD103, BD103-SS, BD324, B333, BD7309, BD7310

G296
Buna N Gasket
 O.D.: 5 13/32 (137.3)
 I.D.: 4 3/4 (120.7)
 Thick: 1/16 (1.6)
 Furnished With: P446
 Optional On: P450

G298-AF
Sponge Gasket
 O.D.: 11 49/64 (298.8)
 I.D.: 11 (279.4)
 Thick: 1/2 (12.7)
 Furnished With: PA2703

G299
Buna N Gasket
 O.D.: 4 (101.6)
 I.D.: 3 5/16 (84.1)
 Thick: 3/32 (2.4)
 Furnished With: PF967

G302
Buna N Groove Gasket
 O.D.: 4 41/64 (117.9)
 I.D.: 4 13/32 (111.9)
 Thick: 1/8 (3.2)
 Optional On: PF225
 Replaces: IHC 279781-R1

G303
Cork Buna N Cover Gasket with 2 Bolt Holes



O.D.: 3 3/8 x 2 7/8 (85.7 x 73.0)
 I.D.: 1 13/16 (46.0)
 Thick: 1/16 (1.6)
 Optional On: PT88-HD
 Replaces: Hyster 119934

G304
Cork Buna N Cover Gasket with 8 Bolt Holes

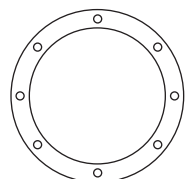

O.D.: 7 1/4 (184.2)
 I.D.: 5 11/16 (144.5)
 Thick: 61/64 (24.2)
 Optional On: Hyster Applications using PT88-HD
 Replaces: Hyster 75670

G305
Buna N Fiber Gasket

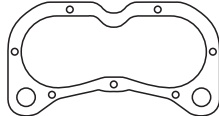

O.D.: 14 13/16 x 7 1/2 (376.2 x 190.5)
 I.D.: 12 15/16 (328.6)
 Thick: 1/32 (0.8)
 Optional On: PT380 KIT
 Notes: Used on Housings with Two Elements Side by Side

G306
Cork Neoprene Cover Gasket with 12 Bolt Holes

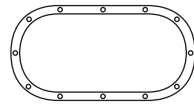

O.D.: 8 x 16 (203.2 x 406.4)
 I.D.: 6 1/2 (165.1)
 Thick: 3/32 (2.4)
 Optional On: PT88-HD
 Replaces: Hyster 88106

G307
Buna N Groove Gasket
 O.D.: 5 33/64 (140.1)
 I.D.: 5 7/32 (132.6)
 Thick: 1/8 (3.2)
 Optional On: PT87-S, PT268, PT288-HD, PT288-HD10, PT498, PT498-10
 Replaces: Allis Chalmers 666244-9; John Deere R39596

G309-B
Buna N Molded Cover Gasket
 O.D.: 8 31/32 (227.8)
 I.D.: 8 15/32 (215.1)
 Thick: 15/64 (6.0)
 Furnished With: BK6221
 Optional On: P415 Series, C704-L, C750-E, C750-L, C750-L SINGLE, F7040, P7040, F7500, P7500, P7500 SINGLE
 Fits: Luber-finer 500C, 750C, 750-2C, 750-3C, 970C, 1000 Housings
 Replaces: Cummins 101853; Luber-finer 2788

G310
Buna N O-Ring (Uniform Dash Number 245)
 O.D.: 4 41/64 (117.9)
 I.D.: 4 23/64 (110.7)
 Thick: 9/32 (7.1)
 Furnished With: PT437
 Optional On: PT189, PT189-MPG, PT569-10
 Replaces: Cat 4H9105

G314
Cork Neoprene Cover Gasket with 7 Bolt Holes

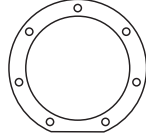

O.D.: 8 5/8 (219.1)
 I.D.: 6 5/8 (168.3)
 Thick: 1/16 (1.6)
 Optional On: PT191, PT191-5, PT191-10, PT208
 Replaces: Clark 746525

PRODUCT GUIDE

WARNING: These products can expose you to chemicals, including Diisononyl Phthalate, Carbon black extracts, Nickel, 1,3 Butadiene, Ethylene Oxide, Epichlorohydrin, which are known to the State of California to cause cancer, and Bisphenol-A, Ethylene Glycol, Ethylene Oxide, 1,3 Butadiene, Epichlorohydrin, which are known to the State of California to cause birth defects or other reproductive harm. For more information go to www.P65Warnings.ca.gov.

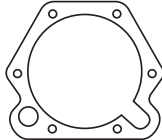
<p>G315 Buna N O-Ring (Uniform Dash Number 249) O.D.: 5 9/64 (130.6) I.D.: 4 55/64 (123.4) Thick: 9/64 (3.6) Optional On: PT189, PT189-MPG, PT293</p>	<p>G343-A Cork Neoprene Cover Gasket with 6 Bolt Holes</p>  <p>O.D.: 7 7/16 x 6 1/2 (188.9 x 165.1) I.D.: 5 1/2 (139.7) Thick: 1/16 (1.6) Optional On: P999, P999-HD Fits: Cummins Late Model Upright Mounted Full-Flow Lube Element-Type Housings Replaces: Cummins 175133, 194982, 216003</p>	<p>G359 Buna N O-Ring (Uniform Dash Number 260) O.D.: 6 49/64 (171.8) I.D.: 6 31/64 (164.7) Thick: 9/64 (3.6) Optional On: PT191, PT191-5, PT191-10</p>	<p>G369-B Buna N Groove Gasket (with Blue Stripe) O.D.: 5 3/32 (129.4) I.D.: 4 45/64 (119.5) Thick: 3/16 (4.8) Furnished With: BT389-10, BT9356 Optional On: Various Filters Integral On: BT287-3</p>
<p>G323 Buna N Groove Gasket O.D.: 3 1/4 (82.6) I.D.: 3 3/32 (78.6) Thick: 1/8 (3.2) Optional On: PT93, PT93-MPG, PF935 Fits: Cat 8H4681 Replaces: Cat 8H2778</p>	<p>G344 Buna N Groove Gasket O.D.: 3 9/16 (90.5) I.D.: 3 5/16 (84.1) Thick: 1/8 (3.2) Furnished With: PF936, PF942, PF943 Optional On: PF810, PF906 Fits: Fram FCS1133PL, FSC1136M Housings Replaces: Fram 101489</p>	<p>G360 Buna N O-Ring (Uniform Dash Number 259) O.D.: 6 31/64 (164.7) I.D.: 6 15/64 (158.4) Thick: 9/64 (3.6) Optional On: PT89, PT90-10, PT90-MPG, PT94, PT268 Replaces: Cat 2K4472; IHC 343943-R1</p>	<p>G369-V Viton Gasket O.D.: 5 3/32 (129.4) I.D.: 4 45/64 (119.5) Thick: 3/16 (4.8) Optional On: Various Filters</p>
<p>G332 Buna N Gasket O.D.: 3 63/64 (101.2) I.D.: 3 43/64 (93.3) Thick: 1/8 (3.2) Furnished With: PF950</p>	<p>G347 Buna N O-Ring (Uniform Dash Number 252) O.D.: 5 33/64 (140.1) I.D.: 5 15/64 (133.0) Thick: 9/64 (3.6) Optional On: PT90-10, PT90-MPG Replaces: Cat 2H9247</p>	<p>G362 Buna N O-Ring (Uniform Dash Number 251) O.D.: 5 25/64 (136.9) I.D.: 5 7/64 (129.8) Thick: 9/64 (3.6) Optional On: P204, P204-HD, P204-HD10, PT268 Replaces: IHC 138466-R1, 390610-R1</p>	<p>G372 Buna N Groove Gasket (with Yellow Stripe) O.D.: 5 5/32 (131.0) I.D.: 4 47/64 (120.3) Thick: 13/64 (5.2) Furnished With: BT287, BT389 Optional On: Various Filters Fits: Use ONLY on Case Applications</p>
<p>G333 Buna N O-Ring (Uniform Dash Number 244) O.D.: 4 33/64 (114.7) I.D.: 4 15/64 (107.6) Thick: 9/64 (3.6) Optional On: PT61-HD, PT189, PT189-MPG Replaces: Cat 2H3928</p>	<p>G348-AF Gasket O.D.: 11 1/16 (281.0) I.D.: 10 3/16 (258.8) Thick: 7/16 (11.1) Furnished With: PA2732</p>	<p>G363 Buna N Gasket O.D.: 5 7/8 (149.2) I.D.: 5 3/8 (136.5) Thick: 1/16 (1.6) Optional On: V24-A2, PF155 Fits: Luber-finer F170, F170-2 Housings Replaces: Luber-finer 4041</p>	<p>G376 Buna N O-Ring (Uniform Dash Number 242) O.D.: 4 17/64 (108.3) I.D.: 3 63/64 (101.2) Thick: 9/64 (3.6) Furnished With: PT138-10, PT138-25 Optional On: PT66-HD, PT189, PT189-MPG Replaces: Cat 1H6227</p>
<p>G336 Buna N Groove Gasket O.D.: 6 15/64 (158.4) I.D.: 5 53/64 (148.0) Thick: 13/64 (5.2) Optional On: P20-HD, P999, P999-HD Fits: OB1369; Base Mounted Full-Flow Lube Element-Type Housing Using Square-Cut Gasket Replaces: Cummins 173368</p>	<p>G354 Buna N O-Ring (Uniform Dash Number 253) O.D.: 5 41/64 (143.3) I.D.: 5 23/64 (136.1) Thick: 9/64 (3.6) Optional On: PT88-HD, PT90-10, P998 Replaces: Cat 2H3935; Cummins 193302</p>	<p>G366 Buna N O-Ring (Uniform Dash Number 238) O.D.: 3 3/4 (95.3) I.D.: 3 1/2 (88.9) Thick: 1/8 (3.2) Furnished With: PT543 KIT Optional On: PT480, PT480-10, PT480-MPG Integral On: PT520, PT520-10, PT572-10</p>	<p>G379 Fiber Gasket O.D.: 3 13/32 (86.5) I.D.: 2 51/64 (71.0) Thick: 1/16 (1.6) Optional On: PT135</p>
<p>G340 Copper Washer O.D.: 63/64 (25.0) I.D.: 51/64 (20.2) Thick: 3/64 (1.2) Optional On: P20-HD</p>	<p>G356 Buna N Gasket O.D.: 7 3/64 (179.0) I.D.: 6 27/64 (163.1) Thick: 5/64 (2.0) Optional On: PF116, P528 Fits: Fleetguard Housings with Stamped Cover and Mounting Brackets</p>	<p>G368 Buna N O-Ring (Uniform Dash Number 254) O.D.: 5 3/4 (146.1) I.D.: 5 15/32 (138.9) Thick: 9/64 (3.6) Furnished With: PT379 KIT, PT487 KIT Optional On: PT268 Replaces: IHC 285253-R1</p>	<p>G380 Buna N Groove Gasket O.D.: 5 41/64 (143.3) I.D.: 5 5/64 (129.0) Thick: 3/16 (4.8) Optional On: PT152</p>
<p>G342 Viton O-Ring (Uniform Dash Number 248) O.D.: 5 1/64 (127.4) I.D.: 4 47/64 (120.3) Thick: 9/64 (3.6) Optional On: PT189, PT189-MPG, PT207 Series, PT385, PT385-E, PT670, PT670-E Replaces: Cat 5F3144</p>	<p>G381-A Buna N Groove Gasket O.D.: 2 13/16 (71.4) I.D.: 2 15/32 (62.7) Thick: 13/64 (5.2) Integral On: Various Filters</p>	<p>G382 Buna N O-Ring (Uniform Dash Number 263) O.D.: 7 33/64 (191.0) I.D.: 7 15/64 (183.8) Thick: 9/64 (3.6) Optional On: PT491, PT491-10</p>	<p>G382 Buna N O-Ring (Uniform Dash Number 263) O.D.: 7 33/64 (191.0) I.D.: 7 15/64 (183.8) Thick: 9/64 (3.6) Optional On: PT491, PT491-10</p>

 **WARNING:** These products can expose you to chemicals, including Diisononyl Phthalate, Carbon black extracts, Nickel, 1,3 Butadiene, Ethylene Oxide, Epichlorohydrin, which are known to the State of California to cause cancer, and Bisphenol-A, Ethylene Glycol, Ethylene Oxide, 1,3 Butadiene, Epichlorohydrin, which are known to the State of California to cause birth defects or other reproductive harm. For more information go to www.P65Warnings.ca.gov.

<p>G382-V Viton O-Ring (Uniform Dash Number 263) O.D.: 7 33/64 (190.9) I.D.: 7 15/64 (183.8) Thick: 9/64 (3.6) Replaces: Cat 6V3907</p>	<p>G401 Buna N Groove Gasket O.D.: 2 13/16 (71.4) I.D.: 2 15/32 (62.7) Thick: 1/4 (6.4) Optional On: B378, B378-10 Integral On: Various Filters</p>	<p>G412 Buna N O-Ring (Uniform Dash Number 266) O.D.: 8 17/64 (209.9) I.D.: 7 63/64 (202.8) Thick: 9/64 (3.6) Optional On: PT98-10, PT98-MPG Replaces: Cat 1J2176</p>	<p>G434 Buna N Gasket O.D.: 4 1/16 (103.2) I.D.: 3 37/64 (90.9) Thick: 3/32 (2.4) Optional On: PT93, PT93-MPG Replaces: Cat 3J1991</p>
<p>G385 Buna N Groove Gasket O.D.: 4 49/64 (121.1) I.D.: 4 11/32 (110.3) Thick: 1/4 (6.4) Furnished With: PT467-MPG Optional On: PT207, PT207-10, PT207-HD, PT207-HD10, PT433 Fits: Gresen Line-Type Housings</p>	<p>G402 Buna N O-Ring (Uniform Dash Number 243) O.D.: 4 3/8 (111.1) I.D.: 4 1/8 (104.8) Thick: 1/8 (3.2) Furnished With: PT549 Optional On: P40, P176 Replaces: Cat 4M189</p>	<p>G416 Buna N O-Ring (Uniform Dash Number 438) O.D.: 6 25/64 (162.3) I.D.: 6 7/32 (158.0) Thick: 9/32 (7.1) Optional On: PT83, PT83-MPG, PT90-10, PT94 Replaces: Cat 5L5032</p>	<p>G435 Buna N Gasket O.D.: 4 1/8 (104.8) I.D.: 3 59/64 (99.6) Thick: 1/8 (3.2) Optional On: PT66-HD, PT670, PT670-E Replaces: Cat 5B5940</p>
<p>G386 Buna N Groove Gasket O.D.: 4 55/64 (123.4) I.D.: 4 29/64 (113.1) Thick: 13/64 (5.2) Optional On: PT207, PT207-10, PT207-HD, PT207-HD10, PT433 Fits: Gresen Line-Type Housings</p>	<p>G403 Buna N O-Ring (Uniform Dash Number 231) O.D.: 2 57/64 (73.4) I.D.: 2 39/64 (66.3) Thick: 9/64 (3.6) Furnished With: PT449 Optional On: PT189, PT189-MPG Replaces: Cat 8F8882</p>	<p>G417 Buna N O-Ring (Uniform Dash Number 427) O.D.: 5 9/32 (134.1) I.D.: 4 23/32 (119.9) Thick: 9/32 (7.1) Furnished With: PT573 Optional On: PT707-HD, PT707-HD3, PT707-HD10</p>	<p>G436 Buna N O-Ring O.D.: 3 11/16 (93.7) I.D.: 3 5/16 (84.1) Thick: 3/16 (4.8) Optional On: PT66-HD Replaces: Cat 6F8509</p>
<p>G392 Buna N Groove Gasket O.D.: 5 23/64 (136.1) I.D.: 4 61/64 (125.8) Thick: 13/64 (5.2) Furnished With: PT373 Optional On: PT207, PT207-10, PT207-HD, PT207-HD10, PT401-MPG, PT433 Fits: Massey Ferguson Hydraulic Filter Housings on 1100 Series Models Replaces: Massey Ferguson 366731X1; Dresser 932994-C2</p>	<p>G406 Buna N O-Ring (Uniform Dash Number 340) O.D.: 3 49/64 (95.6) I.D.: 3 11/32 (84.9) Thick: 13/64 (5.2) Optional On: PF814 Replaces: John Deere R41721</p>	<p>G422-AF Sponge Cover Gasket O.D.: 15 (381.0) I.D.: 13 (330.2) Thick: 1/4 (6.4) Optional On: LL2438, PA2438, LL2439, PA2439</p>	<p>G438 Buna N O-Ring (Uniform Dash Number 371) O.D.: 8 57/64 (225.8) I.D.: 8 15/32 (215.1) Thick: 13/64 (5.2) Optional On: PT98-10, PT98-MPG</p>
<p>G394 Buna N Groove Gasket O.D.: 5 27/32 (148.4) I.D.: 5 7/16 (138.1) Thick: 13/64 (5.2) Optional On: PT88-HD Replaces: Cat 8M4779</p>	<p>G409 Buna N Gasket O.D.: 6 11/32 (161.1) I.D.: 5 7/8 (149.2) Thick: 1/8 (3.2) Optional On: PT90-10, PT94 Replaces: Cat 4K1557</p>	<p>G431 Buna N Molded Gasket O.D.: 2 19/32 (65.9) I.D.: 2 5/16 (58.7) Thick: 19/64 (7.5) Optional On: P540, P540-S</p>	<p>G441 Buna N O-Ring (Uniform Dash Number 227) O.D.: 2 25/64 (60.3) I.D.: 2 7/64 (53.6) Thick: 9/64 (3.6) Optional On: PT88-HD Replaces: Cat 7F8268</p>
<p>G397 Buna N Groove Gasket O.D.: 5 31/64 (139.3) I.D.: 5 15/64 (133.0) Thick: 1/8 (3.2) Furnished With: PT426 Optional On: PT87-S, PT288-HD, PT288-HD10, PT390-MPG, PT391-MPG, PT498, PT498-10</p>	<p>G410 Buna N O-Ring (Uniform Dash Number 241) O.D.: 4 9/64 (105.2) I.D.: 3 55/64 (98.0) Thick: 9/64 (3.6) Optional On: PT12, PT66-HD Replaces: Cat 2H3934</p>	<p>G432 Buna N O-Ring (Uniform Dash Number 237) O.D.: 3 5/8 (92.1) I.D.: 3 11/32 (84.9) Thick: 1/8 (3.2) Optional On: PT66-HD, PT93, PT93-MPG</p>	<p>G442 Buna N O-Ring (Uniform Dash Number 235) O.D.: 3 25/64 (86.1) I.D.: 3 7/64 (79.0) Thick: 9/64 (3.6) Optional On: PT66-HD Replaces: Cat 2H6184</p>
<p>G400 Buna N Groove Gasket O.D.: 6 31/32 (177.0) I.D.: 6 15/32 (164.3) Thick: 17/64 (6.7) Optional On: PT561 Replaces: John Deere T26990</p>	<p>G411 Buna N Gasket O.D.: 6 17/32 (165.9) I.D.: 6 3/64 (153.6) Thick: 1/8 (3.2) Optional On: PT90-10, PT94 Replaces: Cat 5J3172</p>	<p>G433 Buna N O-Ring (Uniform Dash Number 358) O.D.: 6 1/64 (152.8) I.D.: 5 19/32 (142.1) Thick: 13/64 (5.2) Optional On: PT83, PT83-MPG, PT90-10, PT189, PT189-MPG Replaces: Cat 6D9157</p>	<p>G443 Buna N O-Ring (Uniform Dash Number 250) O.D.: 5 17/64 (133.7) I.D.: 4 63/64 (126.6) Thick: 9/64 (3.6) Optional On: PT90-10, PT189, PT268 Replaces: Cat 5F3106</p>



WARNING: These products can expose you to chemicals, including Diisononyl Phthalate, Carbon black extracts, Nickel, 1,3 Butadiene, Ethylene Oxide, Epichlorohydrin, which are known to the State of California to cause cancer, and Bisphenol-A, Ethylene Glycol, Ethylene Oxide, 1,3 Butadiene, Epichlorohydrin, which are known to the State of California to cause birth defects or other reproductive harm. For more information go to www.P65Warnings.ca.gov.

G444
Buna N O-Ring
(Uniform Dash Number 258)
O.D.: 6 17/64 (159.1)
I.D.: 5 63/64 (152.0)
Thick: 9/64 (3.6)
Optional On: PT88-HD, PT90-10
Replaces: Cat 8F8733

G445
Buna N O-Ring
(Uniform Dash Number 352)
O.D.: 5 17/64 (133.7)
I.D.: 4 27/32 (123.0)
Thick: 13/64 (5.2)
Furnished With: PF7680, PF7744
Optional On: PT189, PT189-MPG
Replaces: Cat 2S8439

G446
Buna N O-Ring
(Uniform Dash Number 432)
O.D.: 5 29/32 (150.0)
I.D.: 5 11/32 (135.7)
Thick: 9/32 (7.1)
Optional On: PT88-HD
Replaces: Cat 4F7507

G447
Buna N O-Ring
(Uniform Dash Number 246)
O.D.: 4 49/64 (121.0)
I.D.: 4 31/64 (113.9)
Thick: 9/64 (3.6)
Optional On: Various Filters
Replaces: Cat 5H6734

G449-B
Buna N Groove Gasket
O.D.: 2 51/64 (71.0)
I.D.: 2 15/32 (62.7)
Thick: 1/4 (6.4)
Integral On: Various Filters

G458
Buna N Groove Gasket
O.D.: 3 55/64 (98.0)
I.D.: 3 19/32 (91.3)
Thick: 9/64 (3.6)
Furnished With: PT377,
PT377-10, PF598, PF598-10,
PF598-30

G467
Buna N O-Ring
(Uniform Dash Number 140)
O.D.: 2 7/16 (61.9)
I.D.: 2 13/64 (56.0)
Thick: 7/64 (2.8)
Optional On: PF599, PF599-10,
PF599-30

G468
Buna N O-Ring
(Uniform Dash Number 156)
O.D.: 4 7/16 (112.7)
I.D.: 4 15/64 (107.6)
Thick: 7/64 (2.8)
Optional On: PF599, PF599-10,
PF599-30

G472-AF
Sponge Gasket
with 6 Bolt Holes
O.D.: 11 (279.4)
I.D.: 9 1/8 (231.8)
Thick: 1/4 (6.4)
Furnished With: PA2503
Optional On: LL2482, PA2482,
PA2531, PA2532
Fits: United Air Housing

G480
Buna N Groove Gasket
O.D.: 4 25/64 (111.5)
I.D.: 4 1/64 (102.0)
Thick: 3/16 (4.8)
Furnished With: PF312

G483
Buna N Groove Gasket
O.D.: 4 63/64 (126.6)
I.D.: 4 21/32 (118.3)
Thick: 3/16 (4.8)
Furnished With: BT345 KIT
Optional On: Various Filters

G494
Nitrile O-Ring
(Uniform Dash Number 351)
O.D.: 4 15/16 (125.4)
I.D.: 4 47/64 (120.3)
Thick: 7/32 (5.6)
Furnished With: PT777

G498-A
Buna N Groove Gasket
O.D.: 4 21/64 (109.9)
I.D.: 3 27/32 (97.6)
Thick: 3/8 (9.5)
Integral On: Various Spin-ons

G499-AF
Sponge Gasket
with 7 Bolt Holes
O.D.: 12 7/8 (327.0)
I.D.: 10 5/8 (269.9)
Thick: 3/8 (9.5)
Optional On: LL2312, PA2312,
PA2425, PA2430

G501-AF
Sponge Gasket
O.D.: 13 41/64 (346.5)
I.D.: 12 7/8 (327.0)
Thick: 1/2 (12.7)
Furnished With: PA2631, PA2632,
PA2729, RS3539

G523-AF
Closed Cell Sponge
Boot Gasket
O.D.: 13 11/32 (338.9)
I.D.: 13 3/16 (335.0)
Thick: 5/64 (2.0)
Attached To: LL2456, PA2456,
PA4566

G704
Buna N Gasket
O.D.: 4 63/64 (126.6)
I.D.: 4 3/8 (111.1)
Thick: 3/16 (4.8)
Optional On: Various Filters

G710
Buna N Gasket
O.D.: 5 3/64 (128.2)
I.D.: 4 45/64 (119.5)
Thick: 3/16 (4.8)
Optional On: Various Filters

G717
Buna N Gasket
O.D.: 5 9/16 (141.3)
I.D.: 5 7/32 (132.6)
Thick: 9/32 (7.1)
Optional On: PF7680 for use on
Webb Housings

G725
Buna N Gasket
O.D.: 4 15/16 (125.4)
I.D.: 4 19/32 (116.7)
Thick: 13/64 (5.2)
Optional On: BT389-10 When
Replacing Parker 927736

ES1001
Fiber Washer
O.D.: 7/8 (22.2)
I.D.: 9/16 (14.3)
Thick: 1/16 (1.6)
Furnished With: B4, F844-A,
BF938, BF939

ES1023
Buna N O-Ring
(Uniform Dash Number 037)
O.D.: 2 5/8 (66.7)
I.D.: 2 31/64 (63.5)
Thick: 1/16 (1.6)

ES1026
Steel Buna Dyna-Seal

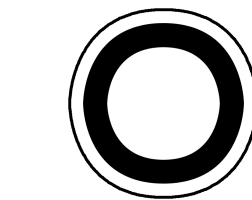

O.D.: 1 5/16 (33.3)
I.D.: 3/4 (19.1)
Thick: 3/32 (2.4)
Furnished With: PT386, PT436,
PT571, PT777
Optional On: P999, P999-HD
Fits: Outer Center Bolt on Cummins
Full-Flow Lube Housings
Replaces: Cummins 208371

ES1030
Steel Buna N Dyna-Seal
O.D.: 1 3/16 (30.2)
I.D.: 5/8 (15.9)
Thick: 5/64 (2.0)
Furnished With: PT265, PT273,
PF7592
Optional On: PF935
Replaces: Cat 2A1162

ES1031
Buna N Grommet
O.D.: 1 7/8 (47.6)
I.D.: 1 3/64 (26.6)
Thick: 27/64 (10.7)

ES1032
Fiber Washer
O.D.: 1 1/16 (27.0)
I.D.: 3/4 (19.1)
Thick: 3/64 (1.2)
Furnished With: P20-HD
Optional On: PF902, PF902-S,
PF916

ES1034
Fiber Washer
O.D.: 3/4 (19.1)
I.D.: 1/2 (12.7)
Thick: 3/64 (1.2)
Furnished With: F845-A, PF845,
F916-C, PF916
Optional On: PF846

ES1036
Buna N O-Ring
(Uniform Dash Number 112)
O.D.: 11/16 (17.5)
I.D.: 31/64 (12.3)
Thick: 7/64 (2.8)
Furnished With: PF311, PF316,
PT437, PF861
Optional On: P116, PF116
Replaces: Cat 8F9206

ES1039
Nitrile Grommet
O.D.: 2 1/2 (63.5)
I.D.: 1 39/64 (40.9)
Thick: 7/16 (11.1)
Attached To: PT8517-MPG

ES1049
Buna N O-Ring Post Seal
(Uniform Dash Number 113)
O.D.: 3/4 (19.1)
I.D.: 35/64 (16.4)
Thick: 7/64 (2.8)
Furnished With: Various Filters
Optional On: PT90-10, PT189,
PT189-MPG, PF589-30
Replaces: Cat 6F4855



WARNING: These products can expose you to chemicals, including Diisononyl Phthalate, Carbon black extracts, Nickel, 1,3 Butadiene, Ethylene Oxide, Epichlorohydrin, which are known to the State of California to cause cancer, and Bisphenol-A, Ethylene Glycol, Ethylene Oxide, 1,3 Butadiene, Epichlorohydrin, which are known to the State of California to cause birth defects or other reproductive harm. For more information go to www.P65Warnings.ca.gov.

			NOTES
<p>ES1066 Fiber Washer O.D.: 57/64 (22.6) I.D.: 41/64 (16.3) Thick: 3/32 (2.4) Furnished With: F908-A Optional On: PF155 Fits: Head Screw Seal on Luber-finer F155C Housings Replaces: Luber-finer 2183</p>	<p>ES1092 Buna N Post Seal O.D.: 2 3/32 (53.2) I.D.: 1 23/32 (43.7) Thick: 1/4 (6.4) Furnished With: Various Filters</p>	<p>ES3012 Buna N O-Ring (Uniform Dash Number 222) O.D.: 1 49/64 (44.8) I.D.: 1 31/64 (37.7) Thick: 9/64 (3.6) Furnished With: BC110, PF7680, PF7687, PF7744, DAHL 150 Series</p>	
<p>ES1067 Buna N O-Ring (Uniform Dash Number 212) O.D.: 1 9/64 (29.0) I.D.: 55/64 (21.8) Thick: 9/64 (3.6) Optional On: PT88-HD, P7040, F7500, P7500, P7500 SINGLE Fits: Caterpillar Housing Center Bolt; Cummins 500, 750 Model Housings T-Handle Replaces: Cat 3H107, 3H0107; Cummins 116029</p>	<p>ES1303-A Buna N Inner Adapter Seal O.D.: 3 5/32 (80.2) I.D.: 2 25/64 (60.7) Thick: 1/8 (3.2) Furnished With: OB1303</p>	<p>ES3028 Buna N O-Ring (Uniform Dash Number 214) O.D.: 1 17/64 (32.1) I.D.: 63/64 (25.0) Thick: 9/64 (3.6) Optional On: BT367, BT367-S</p>	
<p>ES1068 Buna N Post Seal O.D.: 1 1/32 (26.2) I.D.: 39/64 (15.5) Thick: 3/16 (4.8) Furnished With: F7500, P7500, Optional On: C704-L, C750 Series, F7040, P7040, P7500 SINGLE Fits: Baldwin & Luber-finer 500, 750 Model Housings T-Handle Replaces: Luber-finer 2145</p>	<p>ES1303-B Inner Adapter Seal O.D.: 3 5/32 (80.2) I.D.: 2 25/64 (60.7) Thick: 1/16 (1.6) Furnished With: OB1303</p>	<p>ES3029 Fiber Housing Flat Seal O.D.: 3 3/4 (95.3) I.D.: 1 13/16 (46.0) Thick: 1/16 (1.6) Optional On: PT207, PT207-10, PT207-HD, PT207-HD10, PT373 Replaces: Gresen 1575</p>	
<p>ES1071 Copper Washer O.D.: 1 1/16 (27.0) I.D.: 49/64 (19.4) Thick: 3/64 (1.2) Furnished With: PT385 Optional On: P52</p>	<p>ES1369-A Inner Seal O.D.: 2 7/32 (56.4) I.D.: 1 11/16 (42.9) Thick: 13/64 (5.2) Furnished With: OB1369</p>	<p>ES3063 Fiber Washer O.D.: 9/16 (14.3) I.D.: 21/64 (8.3) Thick: 3/64 (1.2) Furnished With: PF861 Optional On: BF825</p>	
<p>ES1074 Buna N O-Ring (Uniform Dash Number 110) O.D.: 9/16 (14.3) I.D.: 23/64 (9.1) Thick: 7/64 (2.8) Optional On: PF155, PT189, PT189-MPG, P7053 Fits: Head Screw on Luber-finer F170 Housings Replaces: Cat 6F5559; Luber-finer 4190</p>	<p>ES1376 Bleed Plug Washer O.D.: 7/8 (22.2) I.D.: 5/8 (15.9) Thick: 1/16 (1.6) Optional On: C704-L, C750-E, C750-L, C750-L SINGLE, P7040, F7500, P7500, P7500 SINGLE</p>	<p>ES3231 Buna N O-Ring O.D.: 7 29/32 (202.2) I.D.: 7 29/64 (189.3) Thick: 7/32 (5.6) Optional On: PT8366</p>	
<p>G1086-AF Buna N Seal O.D.: 5 1/8 (130.2) I.D.: 3 9/16 (90.5) Thick: 1/32 (0.8) Optional On: PA669 Replaces: Purolator 56979</p>	<p>ES1377 Bleed Plug Washer O.D.: 1 (25.4) I.D.: 11/16 (17.5) Thick: 1/16 (1.6) Optional On: C704-L, C750-E, C750-L, C750-L SINGLE, P7040, F7500, P7500, P7500 SINGLE</p>	<p>ES4007 Buna N Fiber End Seal O.D.: 3 15/16 (100.0) I.D.: 2 9/32 (57.9) Thick: 1/32 (0.8) Optional On: PT189, PT189-MPG Notes: Use with Stacked Elements</p>	
	<p>G1972 Fiber Transmission Pan Gasket with 21 Bolt Holes Size: 19 x 13 (482.6 x 330.2) Furnished With: 18236, 19739, 19992</p>	<p>ES4008 Buna N Fiber End Seal O.D.: 4 15/16 (125.4) I.D.: 3 15/16 (100.0) Thick: 1/32 (0.8) Optional On: PT83, PT83-MPG, PT88-HD, PT90-10, PT90-MPG, PT98-10, PT98-MPG Notes: Use with Stacked Elements</p>	
	<p>G1973 Fiber Transmission Pan Gasket Size: 12 5/8 x 8 5/8 (320.7 x 219.1) Optional On: 19739 Transmission Filters</p>		

PRODUCT GUIDE



WARNING: These products can expose you to chemicals, including Diisononyl Phthalate, Carbon black extracts, Nickel, 1,3 Butadiene, Ethylene Oxide, Epichlorohydrin, which are known to the State of California to cause cancer, and Bisphenol-A, Ethylene Glycol, Ethylene Oxide, 1,3 Butadiene, Epichlorohydrin, which are known to the State of California to cause birth defects or other reproductive harm. For more information go to www.P65Warnings.ca.gov.

Caterpillar Gaskets
Irregular Shaped Gaskets
for Cat Equipment

We use the Cat numbering system only for irregular-shaped gaskets which are used exclusively on Cat equipment.

1S-9133

**Buna N Fiber Cover Gasket
with 8 Bolt Holes**

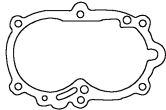

O.D.: 9 29/64 x 5 3/16
(240.1 x 131.8)
I.D.: 8 x 4 1/4 (203.2 x 108.0)
Thick: 1/32 (0.8)
Width: 29/64 (11.5)
Optional On: PF824

4L-8212-R

**Buna N Fiber Cover Gasket
with 4 Bolt Holes
(Cat Number has No -R Suffix)**

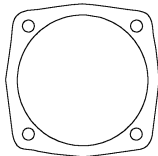

O.D.: 5 1/4 (133.4)
I.D.: 4 1/2 (114.3)
Thick: 1/16 (1.6)
Furnished With: PF823(6)

5H-5601

**Buna N Fiber Cover Gasket
with 6 Bolt Holes**

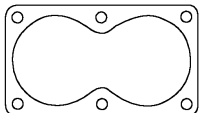

O.D.: 8 1/8 x 4 9/16
(206.4 x 115.9)
I.D.: 7 3/8 x 3 3/4
(187.3 x 95.3)
Thick: 1/32 (0.8)
Width: 13/32 (10.3)
Furnished With: PF823(2)

5M-954

**Buna N Fiber Cover Gasket
with 4 Bolt Holes**

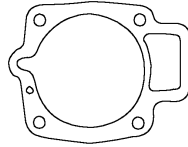

O.D.: 6 3/16 (157.2)
I.D.: 3 3/4 (95.3)
Thick: 1/16 (1.6)
Furnished With: PF824

6L-1540

**Buna N Fiber Cover Gasket
with 6 Bolt Holes**

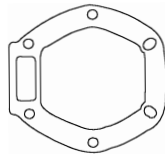

O.D.: 9 1/8 (231.8)
I.D.: 6 1/16 (154.0)
Thick: 1/32 (0.8)

7B-7635

**Buna N Fiber Cover Gasket
with 5 Bolt Holes**

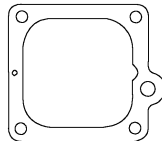

O.D.: 6 1/32 (153.2)
I.D.: 4 9/32 (108.7)
Thick: 1/32 (0.8)

8M-7830

**Buna N Fiber Cover Gasket
with 7 Bolt Holes**

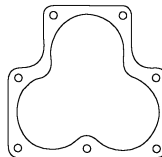

O.D.: 8 1/8 (206.4)
Thick: 1/32 (0.8)
Furnished With: PF823(3)

NOTES

NOTES



WARNING: These products can expose you to chemicals, including Diisononyl Phthalate, Carbon black extracts, Nickel, 1,3 Butadiene, Ethylene Oxide, Epichlorohydrin, which are known to the State of California to cause cancer, and Bisphenol-A, Ethylene Glycol, Ethylene Oxide, 1,3 Butadiene, Epichlorohydrin, which are known to the State of California to cause birth defects or other reproductive harm. For more information go to www.P65Warnings.ca.gov.

DAHL DIESEL FUEL FILTER/WATER SEPARATORS REMOVE DIESEL FUEL SYSTEM PROBLEMS ALONG WITH WATER

Water and solid contaminants displace the diesel fuel's lubricative coating on high precision injection components. The loss of this protection results in wear, erosion, surface pitting and eventual pressure loss.

Many existing fuel filters aren't designed to remove significant amounts of water. They are designed to do their job in a single step. This means they must be porous enough to allow sufficient flow volume which, in turn, limits filtering ability to between 10 and 30 microns. Any tighter media would plug too quickly and result in frequent element changes.

The DAHL system takes care of those shortcomings. DAHL's functional dual-chamber 3-stage diesel fuel filter/water separators provide efficient suction side water separation and contaminant filtration. The key is the unique DAHL patented depressurizer cone which spreads the flow of the fuel. With more area to flow over, greater separation of water and dirt from the fuel is achieved.

DAHL diesel fuel filter/water separators have less mechanical flow resistance than other separators, because the fuel changes direction only twice. The DAHL unit removes virtually 100% of the water and most of the contaminants from the diesel fuel.

Why DAHL Is Right For Your Diesel Equipment

1. The DAHL system eliminates water from fuel before reaching the fuel pump and injectors. This prevents the major cause of diesel fuel injection system failure.
 - a. It prolongs system life by eliminating pump and injector overhauls caused by water contaminated fuel. The cost of shop labor alone, just to repair the injection system on a 6-cylinder rig, exceeds the cost of the DAHL diesel fuel filter/water separator.
 - b. It reduces the need to repair the fuel pump and/or injectors that could easily tie up equipment for one or two days. The loss of income in just a few hours of equipment downtime again would pay for a DAHL diesel fuel filter/water separator.
2. The DAHL system separates solid contaminants from the fuel before reaching the fuel pump and injectors.
3. The DAHL system is easily installed.
 - a. Install it at any location before the fuel pump. (Complete installation instructions are included with each DAHL unit.)
 - b. This system can replace all other primary filters and water separators. It both filters and separates.
 - c. It takes minimal space to install. Clearance space for element removal is between 1 1/2 to 3 1/2 inches. Some models are installed with as few as two easily accessed bolts.
4. The DAHL system is easily serviced.
 - a. Models 150, 200 and 300 are serviced by loosening the T-Bolt handle. They also feature a self-ejecting element.
 - b. The transparent bowl (up to 24 ounce water capacity) makes constant draining unnecessary. The draincock is easy to use. An aluminum bowl is also available.
5. Most of the solid contaminants are separated by the patented depressurizer cone in the bowl BEFORE reaching the filter element. Another factor resulting in less frequent changes is the extra paper in the filter element. Under normal conditions, the element can last up to 40,000 miles.
6. The DAHL system includes a reverse flow valve. This holds the prime in the fuel system by not allowing flow back to the tank during shut-down. (Removable primer plug at top assists where complete priming is required.)
7. The DAHL system helps eliminate air entrapment because the inlet and outlet ports are at the top of the unit. The fuel changes directions only twice (see flow diagram), and so offers less mechanical resistance. Less resistance means longer pump and element life.

PROVEN PERFORMANCE in the laboratory and in millions of miles/hours of commercial and industrial operation. You can be sure that each DAHL unit is designed right, built right and does its job right.

CLEAN FUEL provided by a DAHL diesel fuel filter/water separator eliminates nearly all of the engine problems caused by water and solid contaminants in diesel fuel. In addition, you can expect:

- Longer Injection System Component Life
- Full Power Performance
- Lower Element Replacement Cost



WARNING: These products can expose you to chemicals, including Diisononyl Phthalate, Carbon black extracts, Nickel, 1,3 Butadiene, Ethylene Oxide, Epichlorohydrin, which are known to the State of California to cause cancer, and Bisphenol-A, Ethylene Glycol, Ethylene Oxide, 1,3 Butadiene, Epichlorohydrin, which are known to the State of California to cause birth defects or other reproductive harm. For more information go to www.P65Warnings.ca.gov.

Here's How The DAHL System Works

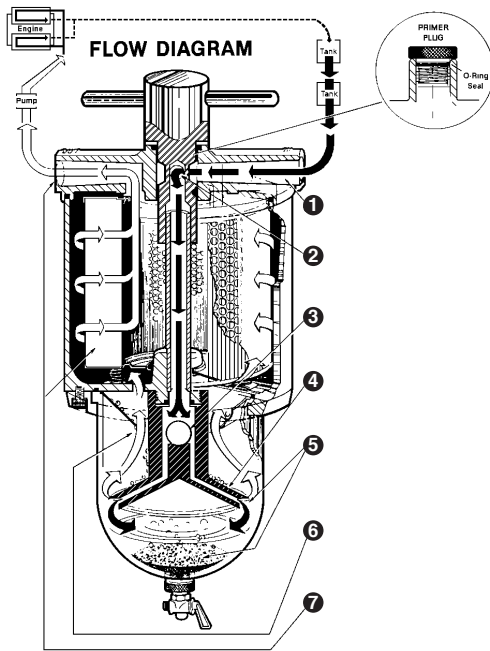

1. The contaminated fuel enters the inlet port.
2. The T-Bolt redirects the fuel downward through the centerpipe.
3. Fuel flows through the reverse flow valve.
4. Fuel flow is spread by the depressurizer cone.
5. As fuel is discharged from the depressurizer cone, 80% of contaminant separation takes place. Most of the solid particles and water settle into the quiet zone of the bowl.
6. As the fuel rises upward, any remaining minute water droplets coalesce on the cone, baffle and bowl surfaces. Droplet size and weight gradually increase, causing downward flow into the sump.
7. Fuel is filtered completely by the element, which contains HydroShield™ media. The clean fuel then continues upward through the outlet port and on to the pump and injection system.

How To Select The Right DAHL Filter

Choose the size which can accommodate the flow rate recommended in the chart. (Maximum flow rate listed is for convenience in comparing with other systems only.) For most efficient separation and filtration, select from the recommended column.

Flow Rates in Gallons Per Hour

The chart is for Fuel/Water Separators. Recyclers are limited by the pump. For example, a single 300 recycler unit has a flow rate limited to 180 GPH (U.S.), and a double 300 recycler unit has a flow rate limited to 360 GPH (U.S.).

Flow Rates

GPH (U.S.)

Model Series	Recommended	Maximum	Sump Capacity
65 & 75	20	30	4 oz.
100	40	65	8 oz.
100 Double	80	130	16 oz.
150	80	100	8 oz.
150 Double	160	200	16 oz.
200	120	200	24 oz.
200 Double	240	400	48 oz.
300	180	325	24 oz.
300 Double	360	650	48 oz.
300 Triple	540	975	72 oz.
500	1800	1920	11 Gallons
500 Double	3600	3840	22 Gallons
All Multiple Units	Multiply Flow Rate and Sump Capacity by Number of Units		

Superior Engineering

- Die cast aluminum
- Impact-resistant large transparent bowl
- Element service life is several times longer than conventional
- Easy to install, service and clean
- Positive air elimination
- Advanced spring design assures positive element seal
- Less mechanical resistance because of streamlined flow path
- Baffle system is designed to stop emulsification and disperse trapped air
- Ball check valve to stop reverse flow
- Six series specifically designed to fit diesel engines of various capacities



WARNING: These products can expose you to chemicals, including Diisononyl Phthalate, Carbon black extracts, Nickel, 1,3 Butadiene, Ethylene Oxide, Epichlorohydrin, which are known to the State of California to cause cancer, and Bisphenol-A, Ethylene Glycol, Ethylene Oxide, 1,3 Butadiene, Epichlorohydrin, which are known to the State of California to cause birth defects or other reproductive harm. For more information go to www.P65Warnings.ca.gov.

65 & 75 Series Compact Fuel Filter/Water Separators



MODEL 65
Diesel Fuel
Filter/Water Separator



MODEL 75
Gasoline or Diesel Fuel
Filter/Water Separator with Aluminum Bowl

Specifications

- **Flow Resistance:**.....0.75 In. Mercury
- **Maximum Working Pressure:**.....25 PSI (172 kPa)
- **Temperature Range:**-50° to +225°F (-45° to +107°C)
- **Port Thread:**9/16-18 w/O-Ring Boss
- **Height / 65:**.....6 3/8 In. (161.9 mm)
- **Height / 75:**.....6 1/8 In. (155.6 mm)
- **Width:**.....4 3/16 In. (106.4 mm)
- **Depth:**.....4 3/4 In. (120.6 mm)
- **Element Removal Clearance:**.....3 1/2 In. (88.9 mm)
- **Sump Capacity:**.....4 oz. (118 ml)

Flow Rates

- **Model 65 & 75 Series:**
Recommended:.....20 GPH (U.S.) (75.7 LPH)
Maximum:.....30 GPH (U.S.) (113.5 LPH)

Service Parts

- **Elements:**
 - 61.....(For Use on Model 60)
 - 61-W.....4 Micron Nominal (20 Absolute) Element (For Use on Model 60)
 - 66*.....5 Micron Nominal (25 Absolute) Element (For Use on Models 65 & 75)
 - 66-W.....4 Micron Nominal (20 Absolute) Element (For Use on Models 65 & 75)
 - 66-30.....5 Micron Nominal (25 Absolute) Element (For Use on Models 65, 65-W30 & 75, 75-W30)
 -9 Micron Nominal (40 Absolute) Element
- **Gaskets:**
 - 60-GK.....Complete Gasket Kit for 60, 65 & 75 (See Accessories Page)
- **Form 4060:**
Installation, Operation, Parts & Service Information

65 & 75 Series Single Units

- 65** Diesel Fuel Filter/Water Separator
- 65-W30** Diesel Fuel Filter/Water Separator — 9 Micron Nominal (40 Absolute) Element
- 75** Gasoline or Diesel Fuel Filter/Water Separator with Aluminum Bowl
- 75-W30** Gasoline or Diesel Fuel Filter/Water Separator with Aluminum Bowl — 9 Micron Nominal (40 Absolute) Element

Accessories

- **All Inlet & Outlet Fittings Require O-Ring Seals**
Fittings.....See DAHL Fittings Chart

Used On

- 65 & 75 — Small Diesel Engines Where Space is Limited
- 75 — Small Gasoline Engines & Marine Applications
- Cars & Light-Duty Trucks

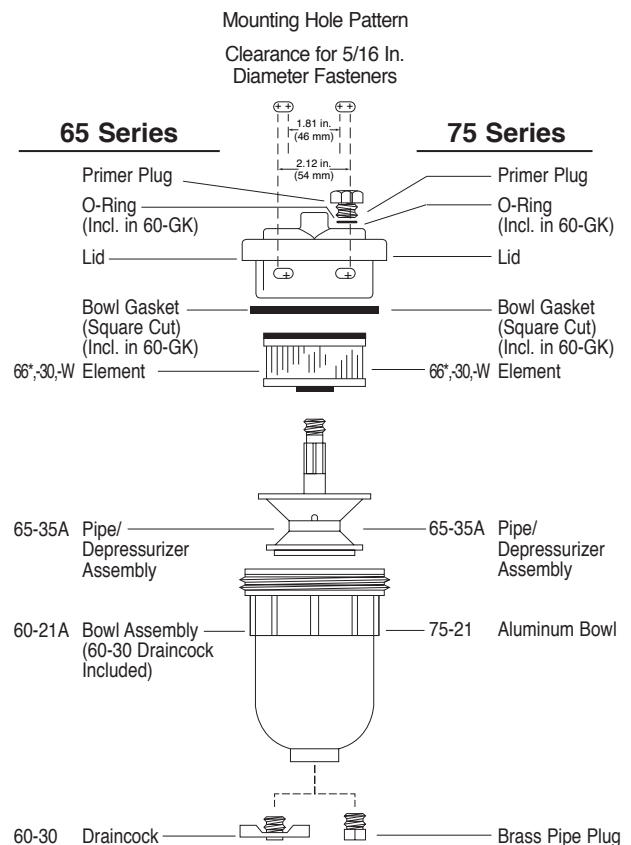

* Standard with Unit Unless Stated.



WARNING: These products can expose you to chemicals, including Diisononyl Phthalate, Carbon black extracts, Nickel, 1,3 Butadiene, Ethylene Oxide, Epichlorohydrin, which are known to the State of California to cause cancer, and Bisphenol-A, Ethylene Glycol, Ethylene Oxide, 1,3 Butadiene, Epichlorohydrin, which are known to the State of California to cause birth defects or other reproductive harm. For more information go to www.P65Warnings.ca.gov.

100 Series Diesel Fuel Filter/Water Separators



MODEL 100
Diesel Fuel Filter/Water Separator



MODEL 100-M
Marine Diesel Fuel Filter/Water Separator



MODEL 100-MFV
Double Manifold Diesel Fuel Filter/Water Separator
with Shut-Off Valves for Continuous Operation



MODEL 100-MMV
Double Marine Manifold Diesel Fuel Filter/Water Separator
with Shut-Off Valves for Continuous Operation

Specifications

- **Flow Resistance:**0.75 In. Mercury
- **Maximum Working Pressure:**.....25 PSI (172 kPa)
- **Temperature Range:**-50° to +225°F (-45° to +107°C)
- **Port Thread:**
Single Units:9/16-18 w/O-Ring Boss
Double Units:.....1/4-18 NPT
- **Height:**.....12 1/2 In. (317.5 mm)
- **Width:**.....5 1/2 In. (139.7 mm)
- **Depth:**.....6 1/2 In. (165.1 mm)
- **Element Removal Clearance:**.....1 1/2 In. (38.1 mm)
- **Sump Capacity:**8 oz. (236 ml)

Flow Rates

- **Single Model 100 Series:**
Recommended:.....40 GPH (U.S.) (151 LPH)
Maximum:65 GPH (U.S.) (246 LPH)
- **Double Model 100 Series:**
Recommended:.....80 GPH (U.S.) (302 LPH)
Maximum:130 GPH (U.S.) (492 LPH)

Service Parts

- **Elements:**
101*4 Micron Nominal (20 Absolute) Element
101-W.....5 Micron Nominal (25 Absolute) Element
101-309 Micron Nominal (40 Absolute) Element
- **Gaskets:**
100-GK.....Complete Gasket Kit (See Accessories Page)
- **Kits:**
100-DEPR KIT.....Depressurizer Kit (See Accessories Page)
100-MNTG KITMounting Bracket Kit
(See Accessories Page)
- **Form 4100:**
Installation, Operation, Parts & Service Information
- **Form 4123:**
Marine Installation, Operation, Parts & Service Information

Used On

- Small Diesel Engines Up to Approx. 200 HP (Except Cummins & Detroit Diesel Engines)
- Cars, Light-Duty Trucks & RV's
- Small Pleasure Crafts & Sailboats
- Caterpillar Engines Thru 3300 Series
- Small Generators & Farm Tractors
- Refrigeration Units
- 5.7L & 6.2L GMC Engines

* Standard with Unit Unless Stated.



WARNING: These products can expose you to chemicals, including Diisononyl Phthalate, Carbon black extracts, Nickel, 1,3 Butadiene, Ethylene Oxide, Epichlorohydrin, which are known to the State of California to cause cancer, and Bisphenol-A, Ethylene Glycol, Ethylene Oxide, 1,3 Butadiene, Epichlorohydrin, which are known to the State of California to cause birth defects or other reproductive harm. For more information go to www.P65Warnings.ca.gov.

100 Series Diesel Fuel Filter/Water Separators (Cont'd.)

Accessories

All Inlet & Outlet Fittings Require O-Ring Seals

Aluminum Bowl	100-21AL
Clear Bowl w/Water Sensor Probes	100-21BP
Clear Bowl w/Heater Probes	100-21H
Clear Bowl w/Marine Collar for Marine Units	100-21M
Fittings.....	See DAHL Fittings Chart
Heat Deflector Shield for Marine Units.....	185-DS
Heater Kit...See Accessories Page (Heater Kits & Heater Parts)	
Shock Pad Mounting Kit	186-SK
Water Sensor Warning Light Kit (Use with 100-21BP)	
24 Volt DC	24-WLK

100 Series Single Units

100	Diesel Fuel Filter/Water Separator
100-BP	Diesel Fuel Filter/Water Separator with Water Sensor Bowl Probes — Order Warning Light Kit separately.
100-H	Diesel Fuel Filter/Water Separator with In-Filter Heater — Dash-Mounted Toggle Switch included. Operates on either 12 or 24 Volt systems. — 5 Micron Nominal (25 Absolute) Element
100-M	Marine Diesel Fuel Filter/Water Separator
100-W	Diesel Fuel Filter/Water Separator — 5 Micron Nominal (25 Absolute) Element
100-W30	Diesel Fuel Filter/Water Separator — 9 Micron Nominal (40 Absolute) Element

100 Series Double Manifold Units

- 100-MFV** Two Diesel Fuel Filter/Water Separators Manifolded with Shut-Off Valves — Allows continuous operation while servicing.
- 100-MMV** Two Marine Diesel Fuel Filter/Water Separators Manifolded with Shut-Off Valves — Allows continuous operation while servicing.

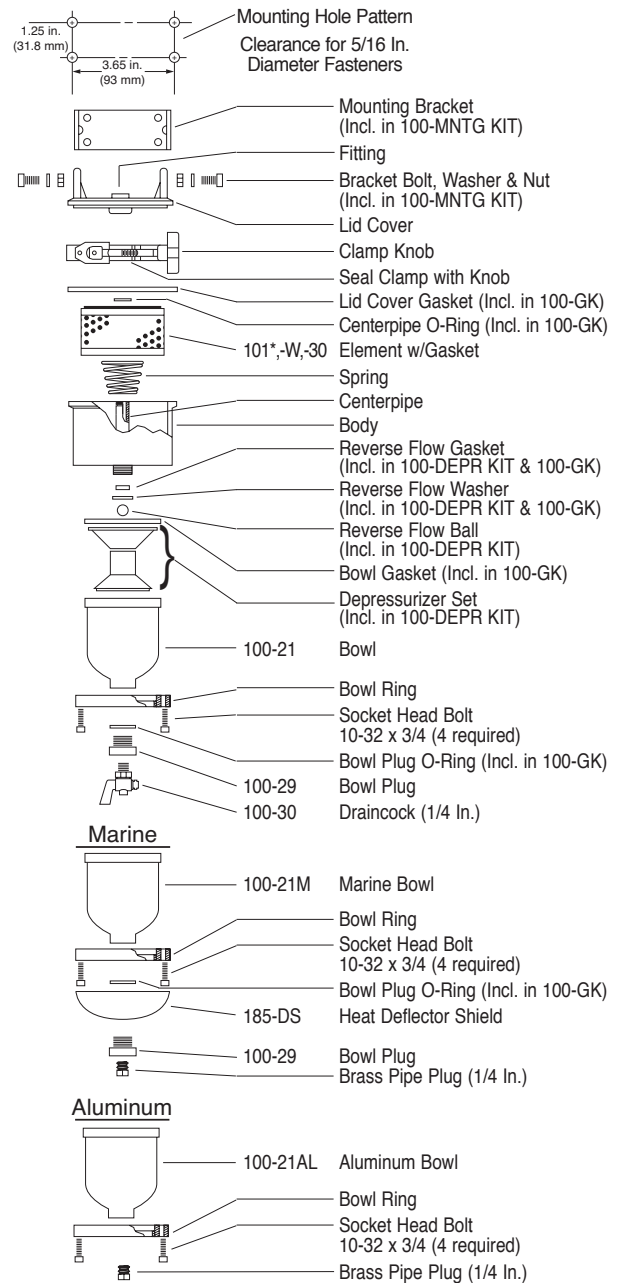

* Standard with Unit Unless Stated.



WARNING: These products can expose you to chemicals, including Diisononyl Phthalate, Carbon black extracts, Nickel, 1,3 Butadiene, Ethylene Oxide, Epichlorohydrin, which are known to the State of California to cause cancer, and Bisphenol-A, Ethylene Glycol, Ethylene Oxide, 1,3 Butadiene, Epichlorohydrin, which are known to the State of California to cause birth defects or other reproductive harm. For more information go to www.P65Warnings.ca.gov.

150 Series Diesel Fuel Filter/Water Separators



MODEL 150
Diesel Fuel Filter/Water Separator



MODEL 150-M
Marine Diesel Fuel Filter/Water Separator

Specifications

- **Flow Resistance:**0.75 In. Mercury
- **Maximum Working Pressure:**.....25 PSI (172 kPa)
- **Temperature Range:**-50° to +225°F (-45° to +107°C)
- **Port Thread:**
Single Units:7/8-14 w/O-Ring Boss
Double Units:.....3/4-14 NPT
- **Height:**.....14 1/4 In. (368.3 mm)
- **Width:**6 In. (152.4 mm)
- **Depth:**6 11/32 In. (161.1 mm)
- **Element Removal Clearance:**.....2 In. (50.8 mm)
- **Sump Capacity:**8 oz. (236 ml)

Flow Rates

- **Single Model 150 Series:**
Recommended:.....80 GPH (U.S.) (302 LPH)
Maximum:100 GPH (U.S.) (378 LPH)
- **Double Model 150 Series:**
Recommended:.....160 GPH (U.S.) (604 LPH)
Maximum:200 GPH (U.S.) (757 LPH)

Service Parts

- **Elements:**
151*4 Micron Nominal (20 Absolute) Element
151-W.....5 Micron Nominal (25 Absolute) Element
151-309 Micron Nominal (40 Absolute) Element
- **Gaskets:**
150-GK.....Complete Gasket Kit (See Accessories Page)
- **Kits:**
100-DEPR KIT.....Depressurizer Kit (See Accessories Page)
- **Form 4025:**..... Installation, Operation,
Parts & Service Information
- **Form 4123:**.....Marine Installation, Operation,
Parts & Service Information

* Standard with Unit Unless Stated.



WARNING: These products can expose you to chemicals, including Diisononyl Phthalate, Carbon black extracts, Nickel, 1,3 Butadiene, Ethylene Oxide, Epichlorohydrin, which are known to the State of California to cause cancer, and Bisphenol-A, Ethylene Glycol, Ethylene Oxide, 1,3 Butadiene, Epichlorohydrin, which are known to the State of California to cause birth defects or other reproductive harm. For more information go to www.P65Warnings.ca.gov.

150 Series Diesel Fuel Filter/Water Separators (Cont'd.)

Accessories

All Inlet & Outlet Fittings Require O-Ring Seals

Aluminum Bowl	100-21AL
Clear Bowl w/Water Sensor Probes	100-21BP
Clear Bowl w/Heater Probes	100-21H
Clear Bowl w/Marine Collar for Marine Units	100-21M
Fittings.....	See DAHL Fittings Chart
Heat Deflector Shield for Marine Units.....	185-DS
Heater Kit...See Accessories Page (Heater Kits & Heater Parts)	
Shock Pad Mounting Kit	286-SK
Water Sensor Warning Light Kit (Use with 100-21BP)	
24 Volt DC	24-WLK

150 Series Units

150	Diesel Fuel Filter/Water Separator
150-H	Diesel Fuel Filter/Water Separator with In-Filter Heater—Dash-Mounted Toggle Switch included. Operates on either 12 or 14 Volt systems. — 5 Micron Nominal (25 Absolute) Element
150-M	Marine Diesel Fuel Filter/Water Separator
150-W30	Diesel Fuel Filter/Water Separator — 9 Micron Nominal (40 Absolute) Element

Used On

- Small & Medium Size Heavy-Duty Diesel Engines (Up to Approx. 450 HP)
- Large Farm Tractors
- Detroit Diesel (53 & Small 71 Series)
- Some Cummins Six Cylinder Engines

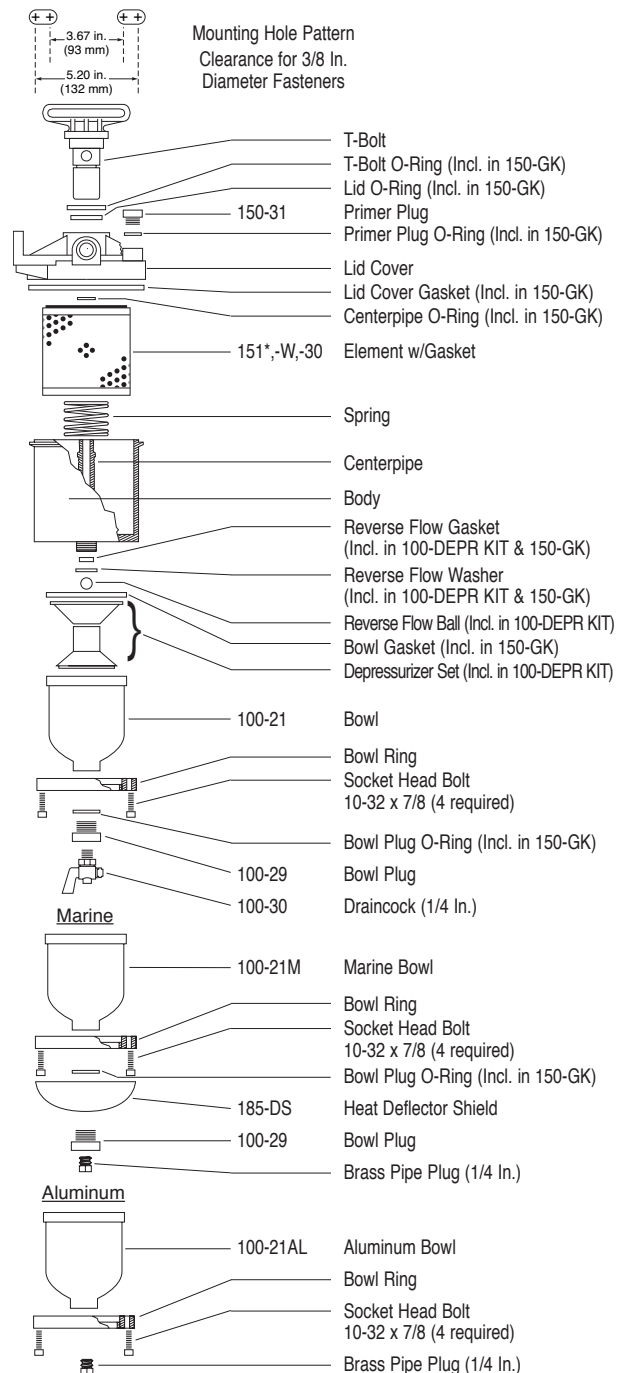

* Standard with Unit Unless Stated.



WARNING: These products can expose you to chemicals, including Diisononyl Phthalate, Carbon black extracts, Nickel, 1,3 Butadiene, Ethylene Oxide, Epichlorohydrin, which are known to the State of California to cause cancer, and Bisphenol-A, Ethylene Glycol, Ethylene Oxide, 1,3 Butadiene, Epichlorohydrin, which are known to the State of California to cause birth defects or other reproductive harm. For more information go to www.P65Warnings.ca.gov.

200 Series Diesel Fuel Filter/Water Separators



MODEL 200
Diesel Fuel Filter/Water Separator



MODEL 200-M
Marine Diesel Fuel Filter/Water Separator



MODEL 200-MFV
Double Manifold Diesel Fuel Filter/Water Separator
with Shut-Off Valves for Continuous Operation

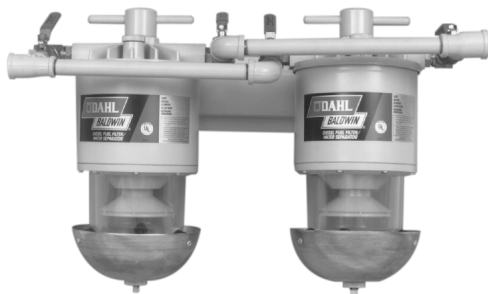

MODEL 200-MMV
Double Marine Manifold Diesel Fuel Filter/Water Separator
with Shut-Off Valves for Continuous Operation

Specifications

- **Flow Resistance:**1.0 In. Mercury
- **Maximum Working Pressure:**.....25 PSI (172 kPa)
- **Temperature Range:**-50° to +225°F (-45° to +107°C)
- **Port Thread:**
Single Units:7/8-14 w/O-Ring Boss
Double Units:.....3/4-14 NPT
- **Height:**.....16 3/4 In. (425.5 mm)
- **Width:**.....7 1/2 In. (190.5 mm)
- **Depth:**.....7 3/4 In. (196.9 mm)
- **Element Removal Clearance:**.....2 1/2 In. (63.5 mm)
- **Sump Capacity:**24 oz. (708 ml)
- **Top to Inlet Clearance:**2 5/8 In. (66.7 mm)
- **Top to Outlet Clearance:**2 5/8 In. (66.7 mm)

Flow Rates

- **Single Model 200 Series:**
Recommended:.....120 GPH (U.S.) (454 LPH)
Maximum:200 GPH (U.S.) (757 LPH)
- **Double Model 200 Series:**
Recommended:.....240 GPH (U.S.) (908 LPH)
Maximum:400 GPH (U.S.) (1,514 LPH)

Service Parts

- **Elements:**
201*4 Micron Nominal (20 Absolute) Element
201-W.....5 Micron Nominal (25 Absolute) Element
201-309 Micron Nominal (40 Absolute) Element
- **Gaskets:**
200-GK.....Complete Gasket Kit (See Accessories Page)
- **Kits:**
200-DEPR KIT.....Depressurizer Kit (See Accessories Page)
- **Form 4230:**
Installation, Operation, Parts & Service Information
- **Form 4123:**
Marine Installation, Operation, Parts & Service Information

* Standard with Unit Unless Stated.



WARNING: These products can expose you to chemicals, including Diisononyl Phthalate, Carbon black extracts, Nickel, 1,3 Butadiene, Ethylene Oxide, Epichlorohydrin, which are known to the State of California to cause cancer, and Bisphenol-A, Ethylene Glycol, Ethylene Oxide, 1,3 Butadiene, Epichlorohydrin, which are known to the State of California to cause birth defects or other reproductive harm. For more information go to www.P65Warnings.ca.gov.

200 Series Diesel Fuel Filter/Water Separators (Cont'd.)

Accessories

All Inlet & Outlet Fittings Require O-Ring Seals

Aluminum Bowl	200-21AL
Clear Bowl w/Water Sensor Probes	200-21BP
Clear Bowl w/Heater Probes	200-21H
Clear Bowl w/Water Sensor & Heater Probes	200-21HBP
Clear Bowl w/Marine Collar for Marine Units	200-21M
Fittings.....	See DAHL Fittings Chart
Heat Deflector Shield for Marine Units.....	285-DS
Heater Kit...See Accessories Page (Heater Kits & Heater Parts)	
Shock Pad Mounting Kit.....	286-SK
Water Sensor Warning Light Kit (Use with 200-21BP)	
24 Volt DC	24-WLK

200 Series Single Units

200	Diesel Fuel Filter/Water Separator
200-H	Diesel Fuel Filter/Water Separator with In-Filter Heater — Operates on either 12 or 24 Volt systems — 5 Micron Nominal (25 Absolute) Element
200-M	Marine Diesel Fuel Filter/Water Separator
200-W30	Diesel Fuel Filter/Water Separator — 9 Micron Nominal (40 Absolute) Element

200 Series Double Manifold Units

200-MFV	Two Diesel Fuel Filter/Water Separators Manifolded with Shut-Off Valves — Allows continuous operation while servicing.
200-MMV	Two Marine Diesel Fuel Filter/Water Separators Manifolded with Shut-Off Valves — Allows continuous operation while servicing.

Used On

- 8 Cylinder Cummins & Detroit Diesel Engines
- Caterpillar Engines up to Approximately 1,000 HP (Including 399)
- Most Other Medium Size Diesel Engines up to Approximately 1,000 HP
- Trucks & Buses
- Construction & Farm Equipment
- Medium Size Generators
- Smaller Commercial Boats

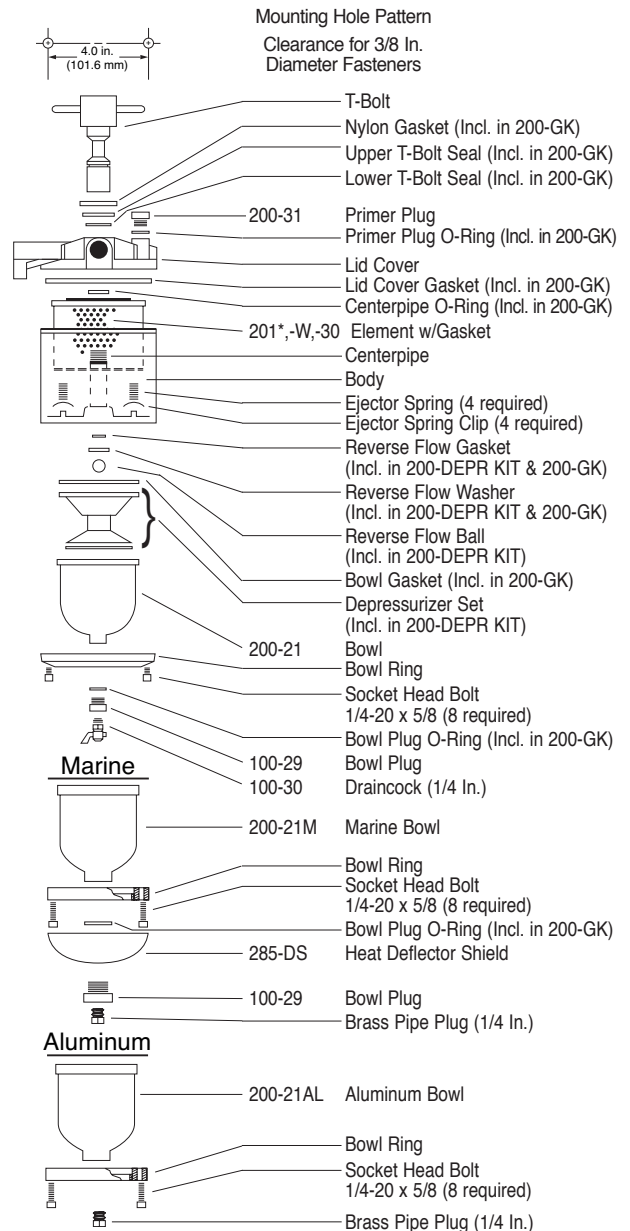

* Standard with Unit Unless Stated.



WARNING: These products can expose you to chemicals, including Diisononyl Phthalate, Carbon black extracts, Nickel, 1,3 Butadiene, Ethylene Oxide, Epichlorohydrin, which are known to the State of California to cause cancer, and Bisphenol-A, Ethylene Glycol, Ethylene Oxide, 1,3 Butadiene, Epichlorohydrin, which are known to the State of California to cause birth defects or other reproductive harm. For more information go to www.P65Warnings.ca.gov.

300 Series Diesel Fuel Filter/Water Separators



MODEL 300
Diesel Fuel
Filter/Water Separator



MODEL 300-M
Marine Diesel Fuel
Filter/Water Separator

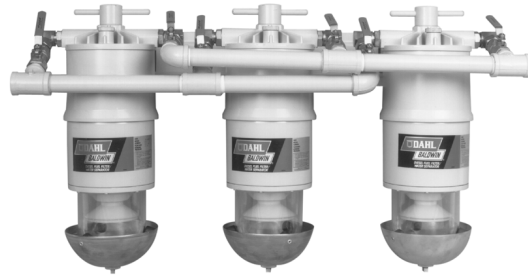

MODEL 300-MMV3
Triple Marine Manifold Diesel Fuel Filter/Water Separator
with Shut-Off Valves for Continuous Operation



MODEL 300-MFV
Double Manifold Diesel Fuel Filter/Water Separator
with Shut-Off Valves for Continuous Operation

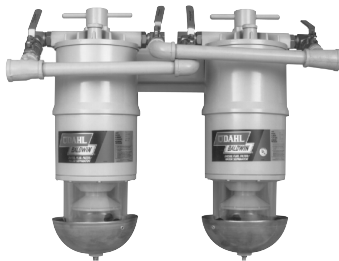

MODEL 300-MMV
Double Marine Manifold Diesel Fuel Filter/Water Separator
with Shut-Off Valves for Continuous Operation

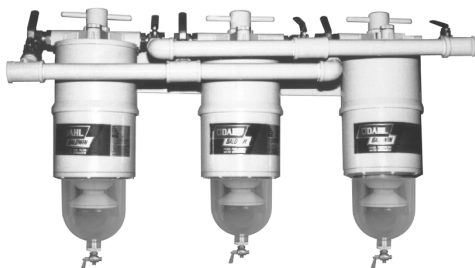

MODEL 300-MFV3
Triple Manifold Diesel Fuel Filter/Water Separator
with Shut-Off Valves for Continuous Operation

Specifications

- **Flow Resistance:**1.5 In. Mercury
- **Maximum Working Pressure:**.....25 PSI (172 kPa)
- **Temperature Range:**-50° to +225°F (-45° to +107°C)
- **Port Thread:**
Single Units:1 1/16-12 w/O-Ring Boss
Double Units:1-11 1/2 NPT
Triple Units:1-11 1/2 NPT
- **Height:**22 1/4 In. (565.2 mm)
- **Width:**7 1/2 In. (190.5 mm)
- **Depth:**7 3/4 In. (196.9 mm)
- **Element Removal Clearance:**2 1/2 In. (63.5 mm)
- **Sump Capacity:**24 oz. (708 ml)
- **Top to Inlet Clearance:**2 5/8 In. (66.7 mm)
- **Top to Outlet Clearance:**2 5/8 In. (66.7 mm)

Flow Rates

- **Single Model 300 Series:**
Recommended:180 GPH (U.S.) (681 LPH)
Maximum:325 GPH (U.S.) (1,230 LPH)
- **Double Model 300 Series:**
Recommended:360 GPH (U.S.) (1,363 LPH)
Maximum:650 GPH (U.S.) (2,460 LPH)
- **Triple Model 300 Series:**
Recommended:540 GPH (U.S.) (2,043 LPH)
Maximum:975 GPH (U.S.) (3,690 LPH)

Service Parts

- **Elements:**
301*4 Micron Absolute Element
301-W3 Micron Nominal (9 Absolute) Element
301-309 Micron Nominal (40 Absolute) Element
301-CSElement with Water Absorbing Media
(for use with Hydraulic Recycler)
301-MPG4 Micron Nominal (20 Absolute) Element
(for use with Hydraulic Recycler)
- **Gaskets:**
200-GKComplete Gasket Kit (See Accessories Page)
- **Kits:**
200-DEPR KITDepressurizer Kit (See Accessories Page)
- **Form 4230:**
Installation, Operation, Parts & Service Information
- **Form 4123:**
Marine Installation, Operation, Parts & Service Information

* Standard with Unit Unless Stated.



WARNING: These products can expose you to chemicals, including Diisononyl Phthalate, Carbon black extracts, Nickel, 1,3 Butadiene, Ethylene Oxide, Epichlorohydrin, which are known to the State of California to cause cancer, and Bisphenol-A, Ethylene Glycol, Ethylene Oxide, 1,3 Butadiene, Epichlorohydrin, which are known to the State of California to cause birth defects or other reproductive harm. For more information go to www.P65Warnings.ca.gov.

300 Series Diesel Fuel Filter/Water Separators (Cont'd.)

Accessories

All Inlet & Outlet Fittings Require O-Ring Seals

Aluminum Bowl	200-21AL
Clear Bowl w/Water Sensor Probes	200-21BP
Clear Bowl w/Heater Probes	200-21H
Clear Bowl w/Water Sensor & Heater Probes	200-21HBP
Clear Bowl w/Marine Collar for Marine Units	200-21M
Fittings.....	See DAHL Fittings Chart
Heat Deflector Shield for Marine Units.....	285-DS
Heater Kit...See Accessories Page (Heater Kits & Heater Parts)	
Shock Pad Mounting Kit	286-SK
Water Sensor Warning Light Kit (Use with 200-21BP)	
24 Volt DC	24-WLK

300 Series Single Units

300	Diesel Fuel Filter/Water Separator
300-H	Diesel Fuel Filter/Water Separator with In-Filter Heater — Operates on either 12 or 24 Volt systems — 5 Micron Absolute Element
300-M	Marine Diesel Fuel Filter/Water Separator
300-W30	Diesel Fuel Filter/Water Separator — 9 Micron Nominal (40 Absolute) Element

300 Series Double Manifold Units

300-MFV	Two Diesel Fuel Filter/Water Separators Manifolded with Shut-Off Valves — Allows continuous operation while servicing.
300-MMV	Two Marine Diesel Fuel Filter/Water Separators Manifolded with Shut-Off Valves — Allows continuous operation while servicing.

300 Series Triple Manifold Units

300-MFV3	Three Diesel Fuel Filter/Water Separators Manifolded with Shut-Off Valves — Allows continuous operation while servicing.
300-MMV3	Three Marine Diesel Fuel Filter/Water Separators Manifolded with Shut-Off Valves — Allows continuous operation while servicing.

Used On

- 12 & 16 Cylinder Cummins & Detroit Diesel Engines
- Caterpillar Engines (800 HP & Up)
- EMD & Alco Engines up to 2,000 HP
- Locomotives
- Large Stationary Engines
- Large Boats & Generators
- Applications Requiring a # 12 Fuel Hose

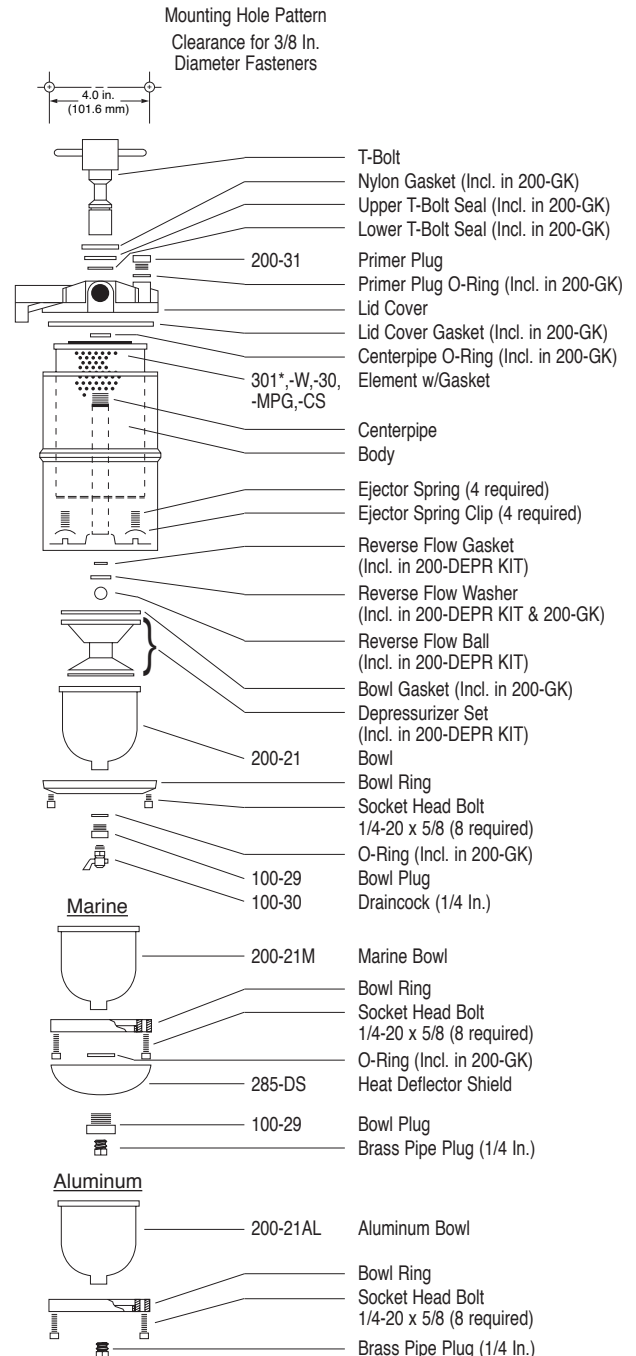

* Standard with Unit Unless Stated.



WARNING: These products can expose you to chemicals, including Diisononyl Phthalate, Carbon black extracts, Nickel, 1,3 Butadiene, Ethylene Oxide, Epichlorohydrin, which are known to the State of California to cause cancer, and Bisphenol-A, Ethylene Glycol, Ethylene Oxide, 1,3 Butadiene, Epichlorohydrin, which are known to the State of California to cause birth defects or other reproductive harm. For more information go to www.P65Warnings.ca.gov.

500 Series Tank Diesel Fuel Filter/Water Separator



MODEL 500-BP
Diesel Fuel Filter/Water Separator

Designed primarily for large marine engines, storage facilities, island fuel pumps and other permanent installations.

Nearly 17,000 square inches (11 square meters) of filtering surface is provided by seven giant DAHL 501-W (10 Micron) elements. Because of the effective separation of water and dirt, the elements will give long service.

Specifications

- **Flow Resistance:**1.0 In. Mercury
- **Maximum Working Pressure:**.....15 PSI (103 kPa)
- **Temperature Range:**-60° to +250°F (-50° to +121°C)
- **Port Thread:**2 In. NPT
- **Height:**47 In. (1,194 mm)
- **Width:**28 1/2 In. (724 mm)
- **Depth:**22 In. (559 mm)
- **Element Removal Clearance:**.....10 In. (254 mm)
- **Sump Capacity:**11 U.S. Gallons (41.6 Liters)

Flow Rates

- **Single Model 500 Series:**
Recommended:.....1,800 GPH (U.S.) (6,813 LPH)
Maximum:1,920 GPH (U.S.) (7,268 LPH)
- **Double Model 500 Series:**
Recommended:.....3,600 GPH (U.S.) (13,626 LPH)
Maximum:3,840 GPH (U.S.) (14,536 LPH)
- **Multiple Units:**
Multiply Flow Rate and Sump Capacity by Number of Units

Service Parts

- **Elements:**
5014 Micron Nominal (20 Absolute) Element
501-W*5 Micron Nominal (25 Absolute) Element
501-309 Micron Nominal (40 Absolute) Element
- **Gaskets:**See Illustration
- **Form 4500:**
Installation, Operation, Parts & Service Information

500 Series Single Units

- 500** Diesel Fuel Filter/Water Separator
- 500-BP** Diesel Fuel Filter/Water Separator with Water Sensor Warning Light Kit — Equipped with a 110 Volt Electrical Connector.
- 500-BP22** Diesel Fuel Filter/Water Separator with Water Sensor Warning Light Kit — Equipped with a 220 Volt Electrical Connector. (For Overseas Operation)

500 Series Double Manifold Units

- 500-MFVBP22** Double Manifold Diesel Fuel Filter/Water Separator with Shut-Off Valves — Allows for continuous operation and Water Sensor Warning Light Kit. — Equipped with a 220 Volt Electrical Connector. (For Overseas Operation)

Used On

- Large Marine Diesel Engines
- Storage Facilities
- Fuel Storage Tank Pumps
- Large Stationary Engines
- Large Capacity Requirements

Features of 500-BP Unit

- Easy draining with convenient bleed and drain valves.
- Easy to service - simply remove the 20 inch seal clamp to remove the top lid assembly for element replacement.
- Easy priming because primer plug is at the top.
- Easy to clean - handy four inch clean-out hole.
- Ruggedly built of high quality heavy-gauge steel.
- Hand welded and pressure tested.
- Minimum mechanical flow resistance because of the streamlined fuel flow through the seven large centertubes.
- Troubleshooting vacuum/pressure gauges monitor inlet and outlet ports.
- The water sensor kit on the 500-BP alerts the operator by a light when the unit should be drained.

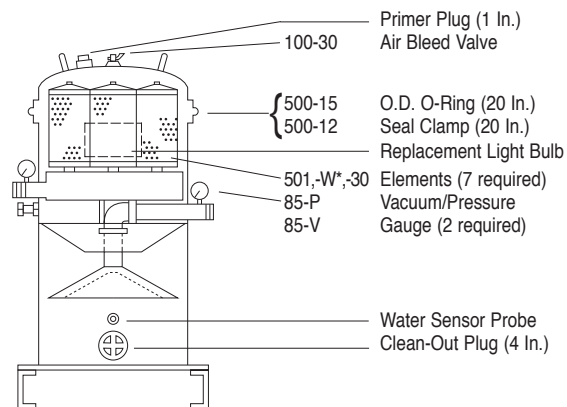

* Standard with Unit Unless Stated.



WARNING: These products can expose you to chemicals, including Diisononyl Phthalate, Carbon black extracts, Nickel, 1,3 Butadiene, Ethylene Oxide, Epichlorohydrin, which are known to the State of California to cause cancer, and Bisphenol-A, Ethylene Glycol, Ethylene Oxide, 1,3 Butadiene, Epichlorohydrin, which are known to the State of California to cause birth defects or other reproductive harm. For more information go to www.P65Warnings.ca.gov.

DAHL Hydraulic Recyclers

The DAHL Hydraulic Recyclers are specifically designed to remove emulsified water from hydraulic oils. Since water emulsified in hydraulic oil is not removed by the normal DAHL coalescing action, Hastings has designed a special filter element that absorbs water that has been emulsified in oil. The water remains in the filter element until the element is disposed. As the element absorbs water, the filtering media expands, increasing the restriction in the filter. By monitoring the pressure differential of the element, it is possible to determine when the element is saturated.

Two unique DAHL elements have been developed in conjunction with the hydraulic units. The first element is the 301-CS. The 301-CS contains a special polymer enhanced media that absorbs water regardless of emulsification. The element has the capacity to absorb over 1 1/2 quarts of water. (This is dependent upon oil viscosity, temperature and

other factors.) When the element becomes saturated, the water is disposed along with the element.

The second element is the 301-MPG. This has a synthetic grade media that is designed as a fine clean-up element. It has a Beta ratio of 2 at 3 micron and 100 at 12 micron, making this element an excellent choice for most hydraulic clean-up applications.

DAHL has designed two portable clean-up carts based on these hydraulic elements. The 300-DHRAP5 is designed for applications requiring larger quantities of water removal with less concern about contaminant removal. The 300-DHRAS5 is a two stage unit with one absorbing element and one clean-up element. To allow effective removal of emulsified water, these units are best used in multiple-pass applications.

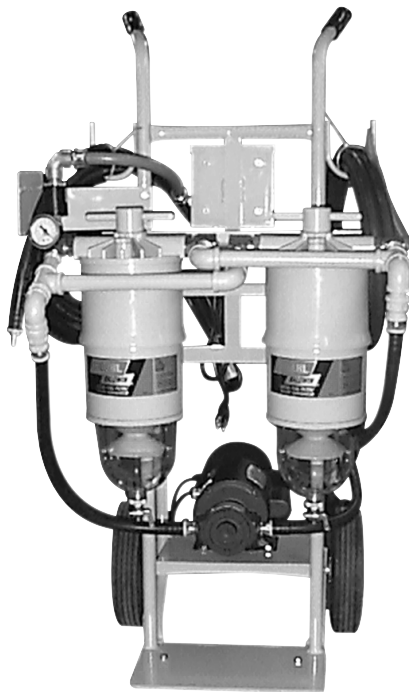

300-DHRAP5 Hydraulic Recycler
Portable Unit

DAHL 300-DHRAP5: Two DAHL 300 units mounted on a convenient dolly. The units are in a parallel arrangement using two of the special water absorbing elements (301-CS). A 5 GPM pump is furnished with the unit. The flow rate for this unit is dependent on the viscosity of the oil, but has been tested at about 200 gallons per hour initially with 20W SAE oil at room temperature. The flow rate will drop off as the element absorbs water. Included with the unit is a vacuum gauge that aids in monitoring the saturation of the filter. An automatic vacuum switch shuts the pump off at a predetermined vacuum setting to prevent pump and motor damage. Element water capacity is about 3 quarts.

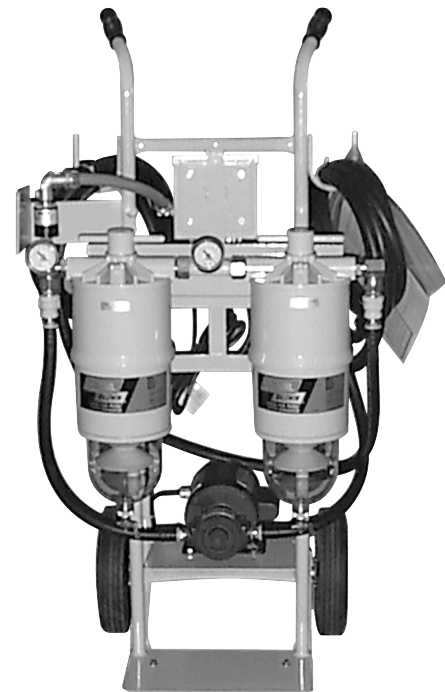

300-DHRAS5 Hydraulic Recycler
Portable Unit

DAHL 300-DHRAS5: Two DAHL 300 units mounted on a convenient dolly. The units are connected in a series flow arrangement. The hydraulic oil flows through the first unit where Hastings' special water absorbing element (301-CS) absorbs the emulsified water. The hydraulic oil next flows to a second DAHL unit where the 301-MPG synthetic media element filters contaminants out of the oil. This unit is furnished with a 3 GPM pump. Two vacuum gauges monitor the pressure drop across both filters. An automatic vacuum switch shuts the pump off at a predetermined vacuum setting. Element water capacity is about 1 1/2 quarts.



WARNING: These products can expose you to chemicals, including Diisononyl Phthalate, Carbon black extracts, Nickel, 1,3 Butadiene, Ethylene Oxide, Epichlorohydrin, which are known to the State of California to cause cancer, and Bisphenol-A, Ethylene Glycol, Ethylene Oxide, 1,3 Butadiene, Epichlorohydrin, which are known to the State of California to cause birth defects or other reproductive harm. For more information go to www.P65Warnings.ca.gov.

Accessories

Heater Kits & Heater Parts

In-Filter Heater Kits

Diesel fuel can become a problem in cold weather. Wax forms, plugging fuel lines and filters. DAHL has models 100-H and 150-H diesel fuel filter/water separators with the 55-EK Heater Kit included and models 200-H and 300-H with the 85-EK Heater Kit included. Or you can retrofit DAHL 100 and 150 series diesel fuel filter/water separators with the 55-EK Heater Kit. DAHL 200 and 300 series diesel fuel filter/water separators can be retrofitted with the 85-EK Heater Kit.

Both sizes feature an electric heating element between the body and the filter element. This simultaneously heats the filter element and the fuel around it.

An illuminated toggle switch conveniently located in the operator's area makes it easy to turn on and off. The unit is simple to install and operate. No seasonal adjustment or other maintenance is needed.

- Operates on 12 or 24 Volt Systems (Negative or Positive Ground)
- Low Amperage Requirements (Only 10 Amps at -40°F)
- Heats Fuel & Element



Use 55-EK for DAHL 100 or 150 Series and 85-EK (shown) for DAHL 200 or 300 Series

55-EK Numbers	Description & (Quantity)	85-EK Numbers
	Heater Element (1)	
100-21H	Heater Probes in Clear Bowl (1)	200-21H
	Bowl Gasket (1)	
	Toggle Switch & Connectors	
	Instructions	

55-EK has Replaced the 45-EK

Sensors

24-WLK Dash-Mounted Water Sensor
24 Volt Warning Light Kit

DAHL Literature

All printed materials are listed here as individual items.

Form 4005 DAHL Catalog
Form 4005-S DAHL Catalog (Spanish)
Form 4011 DAHL 55-EK and 85-EK In-Filter Heater Kit Installation Instructions
Form 4012 Recycler, Recycler/Blender & Fuel Transfer Models - Installation, Operation, Parts & Service Information
Form 4013 DAHL 140-50 Hand Primer Kit
Form 4025 Model 150 - Installation, Operation, Parts & Service Information

Form 4060 Model 65 & 75 - Installation, Operation, Parts & Service Information
Form 4100 Model 100 - Installation, Operation, Parts & Service Information
Form 4123 Marine - Installation, Operation, Parts & Service Information
Form 4230 Model 200 & 300 - Installation, Operation, Parts & Service Information
Form 4500 Model 500 - Installation, Operation, Parts & Service Information



WARNING: These products can expose you to chemicals, including Diisononyl Phthalate, Carbon black extracts, Nickel, 1,3 Butadiene, Ethylene Oxide, Epichlorohydrin, which are known to the State of California to cause cancer, and Bisphenol-A, Ethylene Glycol, Ethylene Oxide, 1,3 Butadiene, Epichlorohydrin, which are known to the State of California to cause birth defects or other reproductive harm. For more information go to www.P65Warnings.ca.gov.

Accessories (Cont'd.)

Vacuum Gauges

Vacuum gauges indicate the remaining life in filter elements. Replacement of the filter should be made when the gauge reading is 2-6 inches greater than the new element reading. (The exact reading depends on the characteristics of the fuel system, such as the engine, normal flow rate, component height, fuel line size, etc.)

To accurately determine when to replace the element, a reading of the gauge should be taken at the first noticeable power loss of the engine. Reduce this gauge reading by 1 inch of mercury for reference of future filter servicing.

The gauge is designed to be connected to the outlet side of the DAHL filter unit and can be mounted directly on the unit or dash-mounted.

85-V Vacuum Gauge

85-P Pressure Gauge

Draincocks

60-30 1/4 In. Draincock (See Model 65)

100-30 1/4 In. Draincock

200-30U 1/4 In. U.L. Approved Draincock

Depressurizer Kits

100-DEPR KIT Includes Depressurizer Set, Reverse Flow Gasket, Reverse Flow Washer and Reverse Flow Ball for 100 Series and 150 Series

200-DEPR KIT Includes Depressurizer Set, Reverse Flow Gasket, Reverse Flow Washer and Reverse Flow Ball for 200 Series and 300 Series

Mounting Bracket Kit

100-MNTG KIT Includes Mounting Bracket, [2] Bracket Bolts, [2] Washers and [2] Nuts for 100 Series

Gasket Kits

60-GK Gaskets for 60, 65 & 75 Models includes Bowl Gasket, Bowl O-Ring, Hub Assembly Gasket and Primer Plug O-Ring

100-GK Gaskets for 100 Series includes Bowl Gasket, [2] Bowl Plug Gaskets (older models), Centerpipe O-Ring, Lid Cover Gasket, Primer Plug O-Ring, Reverse Flow Gasket and Reverse Flow Washer

150-GK Gaskets for 150 Series includes Bowl Gasket, [2] Bowl Plug Gaskets (older models), [2] Bowl Plug O-Rings, Centerpipe O-Ring, Lid Cover Gasket, Lid O-Ring, Primer Plug O-Ring, Reverse Flow Gasket, Reverse Flow Washer and T-Bolt O-Ring

200-GK Gaskets for 200 & 300 Series includes Bowl Gasket, [2] Bowl Plug Gaskets (older models), Bowl Plug O-Ring, Centerpipe O-Ring, Lid Cover Gasket, Lower T-Bolt Seal, Nylon Gasket, [2] Primer Plug O-Rings, Reverse Flow Gasket, Reverse Flow Washer and T-Bolt O-Ring

Hand Primers For DAHL Models 65, 75 & 100

140-50 KIT 3/8 In. Fuel Hose

The DAHL primer is designed to make draining and/or element changing easy. Kits include primer bulb and 2 hose clamps.

Marine Shield & Shock Pad Kits

185-DS Aluminum Heat Deflector Shield for 100 & 150 Series

285-DS Aluminum Heat Deflector Shield for 200 & 300 Series



186-SK Mounting Bracket Shock Pad Kit for 100 Series

286-SK Mounting Bracket Shock Pad Kit for 150, 200 & 300 Series

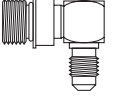
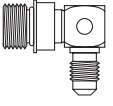
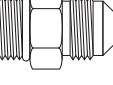

WARNING: These products can expose you to chemicals, including Diisononyl Phthalate, Carbon black extracts, Nickel, 1,3 Butadiene, Ethylene Oxide, Epichlorohydrin, which are known to the State of California to cause cancer, and Bisphenol-A, Ethylene Glycol, Ethylene Oxide, 1,3 Butadiene, Epichlorohydrin, which are known to the State of California to cause birth defects or other reproductive harm. For more information go to www.P65Warnings.ca.gov.

DAHL Fittings Chart

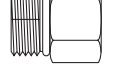
FITTING	FOR DAHL UNIT	THREAD 1	THREAD 2
90° Elbow Straight Thread with O-Ring/37° Male JIC 	65, 75 & 100 Series 65, 75 & 100 Series 150 & 200 Series 150 & 200 Series 300 Series 300 Series	9/16-18 UNF 9/16-18 UNF 7/8-14 UNF 7/8-14 UNF 1 1/16-12 UNF 1 1/16-12 UNF	7/16-20 9/16-18 3/4-16 7/8-14 7/8-14 1 1/16-12
90° Elbow Straight Thread with O-Ring/37° Male JIC Drilled & Tapped for #4 Vacuum Gauge Hose 	65, 75 & 100 Series 65, 75 & 100 Series 65, 75 & 100 Series 150 & 200 Series 150 & 200 Series 150 & 200 Series 150 & 200 Series 150 & 200 Series 300 Series 300 Series	9/16-18 UNF 9/16-18 UNF 9/16-18 UNF 7/8-14 UNF 7/8-14 UNF 7/8-14 UNF 7/8-14 UNF 7/8-14 UNF 1 1/16-12 UNF 1 1/16-12 UNF	7/16-20 9/16-18 9/16-18 3/4-16 3/4-16 3/4-16 3/4-16 7/8-14 7/8-14 1 1/16-12 1 1/16-12
37° Male JIC Straight Thread with O-Ring 	65, 75 & 100 Series 65, 75 & 100 Series 150 & 200 Series 150 & 200 Series 300 Series 300 Series	9/16-18 UNF 9/16-18 UNF 7/8-14 UNF 7/8-14 UNF 1 1/16-12 UNF 1 1/16-12 UNF	7/16-20 9/16-18 3/4-16 7/8-14 7/8-14 1 1/16-12
37° Female JIC Swivel-Push-On Hose Fitting 	65, 75 & 100 Series 150 & 200 Series 150, 200 & 300 Series 300 Series	7/16-20 3/4-16 7/8-14 1 1/16-12	1/4 Hose 1/2 Hose 5/8 Hose 3/4 Hose
Female Pipe Straight Thread with O-Ring 	65, 75 & 100 Series 65, 75 & 100 Series 150 & 200 Series 150 & 200 Series 150 & 200 Series 300 Series 300 Series 300 Series	9/16-18 UNF 9/16-18 UNF 7/8-14 UNF 7/8-14 UNF 7/8-14 UNF 1 1/16-12 UNF 1 1/16-12 UNF 1 1/16-12 UNF	1/4-18 NPT 3/8-18 NPT 3/8-18 NPT 1/2-14 NPT 3/4-14 NPT 1/2-14 NPT 3/4-14 NPT
90° Swivel Elbow Straight Thread with O-Ring/37° Female JIC	300 Series	1 1/16-12 UNF	3/4-14
90° Swivel Elbow Straight Thread with O-Ring/37° Female JIC Drilled & Tapped for #4 Vacuum Gauge Hose	150 & 200 Series	7/8-14 UNF	1/2-14



WARNING: These products can expose you to chemicals, including Diisononyl Phthalate, Carbon black extracts, Nickel, 1,3 Butadiene, Ethylene Oxide, Epichlorohydrin, which are known to the State of California to cause cancer, and Bisphenol-A, Ethylene Glycol, Ethylene Oxide, 1,3 Butadiene, Epichlorohydrin, which are known to the State of California to cause birth defects or other reproductive harm. For more information go to www.P65Warnings.ca.gov.

Replacement Parts

Filter Bowls



- 60-21A** Amber Bowl for 60 & 65 Series — Draincock included
- 75-21** Aluminum Bowl for 75 Series
- 100-21** Clear Replacement Bowl for 100 & 150 Series
- 100-21AL** Aluminum Replacement Bowl for 100 & 150 Series
- 100-21BP** Clear Bowl w/Water Sensor Probes for 100 & 150 Series
- 100-21H** Clear Bowl w/Heater Probes for 100 & 150 Series (Part of 55-EK Heater Kit)
- 100-21M** Clear Bowl w/Marine Collar for 100 & 150 Series Marine Units
- 200-21** Clear Replacement Bowl for 200 & 300 Series
- 200-21AL** Aluminum Replacement Bowl for 200 & 300 Series
- 200-21BP** Clear Bowl w/Water Sensor Probes for 200 & 300 Series
- 200-21H** Clear Bowl w/Heater Probes for 200 & 300 Series (Part of 85-EK Heater Kit)
- 200-21HBP** Clear Bowl w/Water Sensor and Heater Probes for 200 & 300 Series (Upper Holes for Heater, Lower Holes for Bowl Probes)
- 200-21M** Clear Bowl w/Marine Collar for 200 & 300 Series Marine Units

Filter Elements



As with all filter elements made by Hastings, you can be sure that DAHL filter elements are made just right. Not only do we make sure the paper conforms to our exacting requirements, but we also use more paper in a given size filter if this is needed to do the job. (The -W elements are designed for winter or severe conditions.)

- 61** 2 Micron Nominal (20 Absolute) Element for 60
- 61-W** 5 Micron Nominal (25 Absolute) Element for 60
- 66** 4 Micron Nominal (20 Absolute) Element for 65 & 75
- 66-W** 5 Micron Nominal (25 Absolute) Element for 65 & 75
- 66-30** 5 Micron Nominal (25 Absolute) Element for 65 & 75
- 101** 4 Micron Nominal (20 Absolute) Element for 100 Series
- 101-W** 5 Micron Nominal (25 Absolute) Element for 100 Series
- 101-30** 9 Micron Nominal (40 Absolute) Element for 100 Series
- 151** 4 Micron Nominal (20 Absolute) Element for 150 Series
- 151-W** 5 Micron Nominal (25 Absolute) Element for 150 Series
- 151-30** 9 Micron Nominal (40 Absolute) Element for 150 Series
- 201** 4 Micron Nominal (20 Absolute) Element for 200 Series
- 201-W** 5 Micron Nominal (25 Absolute) Element for 200 Series
- 201-30** 9 Micron Nominal (40 Absolute) Element for 200 Series
- 301** 5 Micron Absolute Element for 300 Series
- 301-W** 3 Micron Nominal (9 Absolute) Element for 300 Series
- 301-30** 9 Micron Nominal (40 Absolute) Element for 300 Series
- 301-CS** Water Absorbing Element for 300 Series
- 301-MPG** Maximum Performance Glass Element for 300 Series
- 501** 4 Micron Nominal (20 Absolute) Element for 500 Series
- 501-W** 5 Micron Nominal (25 Absolute) Element for 500 Series
- 501-30** 9 Micron Nominal (40 Absolute) Element for 500 Series

(See Product Guide for filter element specifications)

DAHL Equivalents For Racor® Assemblies

Racor Assembly	Racor Flow (Max.)	DAHL Flow (Max.)	DAHL Assembly
200FG	15	30	65
200FGM	15	30	75
500FG	60	65	100
500MA	60	65	100-M
900FG	90	100	150
900MA	90	100	150-M
1000FG	180	200	200
1000MA	180	200	200-M
73/1000FG	360	400	200-MFV*
73/1000MA	360	400	200-MMV*
75/1000FG	360	400	200-MFV*
75/1000M	360	400	200-MMV*
79/1000FG	540	650	300-MFV3*
79/1000MA	540	650	300-MMV*

* Unit includes shut-off valves.

Replacements For Racor® Elements

Racor Element	Racor Housing	Hastings Element
200 Series		
2000SM-OR		FF839
2000TM-OR		
2000PM-OR		
500FG Series		
2010SM-OR		FF848
2010TM-OR		FF1207
2010PM-OR		FF1208
900FG Series		
2040SM-OR		FF1232
2040TM-OR		FF1233
2040PM-OR		FF1234
1000FG Series		
2020SM-OR		FF1235
2020TM-OR		FF1236
2020PM-OR		FF1237



WARNING: These products can expose you to chemicals, including Diisononyl Phthalate, Carbon black extracts, Nickel, 1,3 Butadiene, Ethylene Oxide, Epichlorohydrin, which are known to the State of California to cause cancer, and Bisphenol-A, Ethylene Glycol, Ethylene Oxide, 1,3 Butadiene, Epichlorohydrin, which are known to the State of California to cause birth defects or other reproductive harm. For more information go to www.P65Warnings.ca.gov.

O-RING UNIFORM DASH NUMBERS

Uniform Dash Numbers represent specific sized O-Rings. The material used in the construction (or compound number) is added to the Dash Number to give a complete number, describing both size and material.

A filter will not filter if it does not seal, and it cannot seal without the right gasket. Order the gaskets you will need when you order your Baldwin filters.

O-RING UNIFORM DASH NUMBERS TO BALDWIN NUMBERS

DASH NUMBER	BALDWIN NUMBER	DASH NUMBER	BALDWIN NUMBER	DASH NUMBER	BALDWIN NUMBER	DASH NUMBER	BALDWIN NUMBER	DASH NUMBER	BALDWIN NUMBER
014	100-17	162	G437	239	G229	254	G368	352	G445
017	150-17	212	ES1067	240	G162	255	G203	358	G433
018	200-17	213	ES3007	241	G410	257	G265	365	ES3020
037	ES1023	214	ES3028	242	G376	258	G444	371	G438
042	ES3009	222	ES3012	243	G402	259	G360	425	G290
110	ES1074	227	G441	244	G333	260	G359	427	G417
111	150-32	229	G173-C	245	G310	263	G382	429	G211
112	ES1036	231	G403	246	G447	263	G382-V	432	G446
113	ES1049	232	G283	248	G342	266	G412	433	G263
115	200-32	233	G270	249	G315	338	G232	438	G416
133	G328	235	G442	250	G443	340	G406	444	G206
140	G467	236	G247	251	G362	345	G219	445	G238
153	G387	237	G432	252	G347	348	G236-A	446	G157
156	G468	238	G366	253	G354	350	G439	906	ES3079

BALDWIN NUMBERS TO O-RING UNIFORM DASH NUMBERS

BALDWIN NUMBER	DASH NUMBER	BALDWIN NUMBER	DASH NUMBER	BALDWIN NUMBER	DASH NUMBER	BALDWIN NUMBER	DASH NUMBER	BALDWIN NUMBER	DASH NUMBER
G157	446	G270	233	G368	254	G437	162	ES1049	113
G162	240	G283	232	G376	242	G438	371	ES1067	212
G173-C	229	G290	425	G382	263	G439	350	ES1074	110
G203	255	G310	245	G382-V	263	G441	227	ES3007	213
G206	444	G315	249	G387	153	G442	235	ES3009	042
G211	429	G328	133	G402	243	G443	250	ES3012	222
G219	345	G333	244	G403	231	G444	258	ES3020	365
G229	239	G342	248	G406	340	G445	352	ES3028	214
G232	338	G347	252	G410	241	G446	432	ES3079	906
G236-A	348	G354	253	G412	266	G447	246	100-17	014
G238	445	G359	260	G416	438	G467	140	150-17	017
G247	236	G360	259	G417	427	G468	156	150-32	111
G263	433	G362	251	G432	237	ES1023	037	200-17	018
G265	257	G366	238	G433	358	ES1036	112	200-32	115



WARNING: These products can expose you to chemicals, including Diisononyl Phthalate, Carbon black extracts, Nickel, 1,3 Butadiene, Ethylene Oxide, Epichlorohydrin, which are known to the State of California to cause cancer, and Bisphenol-A, Ethylene Glycol, Ethylene Oxide, 1,3 Butadiene, Epichlorohydrin, which are known to the State of California to cause birth defects or other reproductive harm. For more information go to www.P65Warnings.ca.gov.

ROUND GASKETS ARRANGED BY O.D.

O.D. Inches	O.D. (mm)	I.D. Inches	I.D. (mm)	THICK Inches	THICK (mm)	CARQUEST NUMBER	O.D. Inches	O.D. (mm)	I.D. Inches	I.D. (mm)	THICK Inches	THICK (mm)	CARQUEST NUMBER
35/64	13.9	9/32	7.1	5/64	2.0	ES1041	2 23/32	69.1	2 1/32	51.6	1/16	1.6	ES1028
9/16	14.3	21/64	8.3	3/64	1.2	ES3063	2 23/32	69.1	2 15/32	62.7	5/32	4.0	G204-A
9/16	14.3	23/64	9.1	7/64	2.8	ES1074	2 3/4	69.9	1 21/32	42.1	5/64	2.0	ES7
5/8	15.9	15/32	11.9	5/64	2.0	ES3079	2 51/64	71.0	2 15/32	62.7	1/4	6.4	G449-B
11/16	17.5	31/64	12.3	7/64	2.8	ES1036	2 13/16	71.4	2 11/32	59.5	1/32	0.8	G334
3/4	19.1	7/16	11.1	3/64	1.2	ES1035	2 13/16	71.4	2 15/32	62.7	13/64	5.2	G381-A
3/4	19.1	1/2	12.7	3/64	1.2	ES1034	2 13/16	71.4	2 15/32	62.7	1/4	6.4	G401
3/4	19.1	35/64	13.9	3/32	2.4	ES3080	2 13/16	71.4	2 21/32	67.5	1/8	3.2	G194-A
3/4	19.1	35/64	13.9	7/64	2.8	ES1049	2 7/8	73.0	2 1/16	52.4	1/64	0.4	G158
27/32	21.4	35/64	13.9	9/64	3.6	ES3037	2 7/8	73.0	2 9/16	65.1	3/64	1.2	G358
7/8	22.2	11/32	8.7	3/32	2.4	G20-AF	2 57/64	73.4	2 39/64	66.3	9/64	3.6	G403
7/8	22.2	29/64	11.5	1/32	0.8	ES102-W	2 59/64	74.2	2 19/32	65.9	3/32	2.4	G103
7/8	22.2	1/2	12.7	5/64	2.0	ES1064	3 1/64	76.6	2 47/64	69.5	9/64	3.6	G283
7/8	22.2	9/16	14.3	1/16	1.6	ES1001	3 1/32	77.0	2 21/32	67.5	3/16	4.8	G126-C
7/8	22.2	5/8	15.9	1/16	1.6	ES1376	3 5/64	78.2	2 59/64	74.2	11/64	4.4	G165
57/64	22.6	41/64	16.3	3/32	2.4	ES1066	3 7/64	79.0	2 61/64	75.0	3/32	2.4	G161
15/16	23.8	7/16	11.1	1/4	6.4	ES98-A	3 1/8	79.4	2 7/8	73.0	3/32	2.4	G301
63/64	25.0	51/64	20.2	3/64	1.2	G340	3 1/8	79.4	2 57/64	73.4	1/8	3.2	G172-A
1	25.4	11/16	17.5	1/16	1.6	ES1377	3 9/64	79.8	2 55/64	72.6	9/64	3.6	G270
1 1/32	26.2	39/64	15.5	3/16	4.8	ES1068	3 9/64	79.8	2 55/64	72.6	9/64	3.6	G466
1 1/16	27.0	3/4	19.1	3/64	1.2	ES1032	3 9/64	79.8	2 31/32	75.4	5/32	4.0	G239
1 1/16	27.0	49/64	19.5	3/64	1.2	ES1071	3 5/32	80.2	2 25/64	60.7	1/16	1.6	ES1303-B
1 1/8	28.6	3/8	9.5	1/8	3.2	G39-AF	3 5/32	80.2	2 25/64	60.7	1/8	3.2	ES1303-A
1 1/8	28.6	5/8	15.9	1/8	3.2	ES57	3 5/32	80.2	2 29/32	73.8	1/8	3.2	G147-A
1 9/64	29.0	55/64	21.8	9/64	3.6	ES1067	3 11/64	80.6	2 63/64	75.8	5/32	4.0	G170
1 11/64	29.8	49/64	19.5	1/16	1.6	ES61	3 3/16	81.0	2 25/32	70.6	3/32	2.4	G352
1 3/16	30.2	27/64	10.7	1/8	3.2	G15-AF	3 3/16	81.0	2 29/32	73.8	5/32	4.0	G172
1 3/16	30.2	5/8	15.9	5/64	2.0	ES1030	3 3/16	81.0	2 15/16	74.6	1/8	3.2	G242
1 3/16	30.2	15/16	23.8	7/32	5.6	ES24-B	3 3/16	81.0	2 11/16	68.3	5/32	4.0	G126-N
1 13/64	30.6	59/64	23.4	9/64	3.6	ES3007	3 1/4	82.6	2 11/16	68.3	1/8	3.2	G323
1 1/4	31.8	9/16	14.3	1/8	3.2	G103-N	3 1/4	82.6	3 3/32	78.6	9/64	3.6	G228
1 1/4	31.8	5/8	15.9	1/8	3.2	G40-AF	3 17/64	83.0	2 63/64	75.8	1/8	3.2	G129
1 1/4	31.8	63/64	25.0	1/4	6.4	ES3040	3 17/64	83.0	3 1/32	77.0	1/8	3.2	G233-A
1 17/64	32.1	63/64	25.0	9/64	3.6	ES3028	3 11/32	84.9	3 1/16	77.8	1/8	3.2	G233-A
1 5/16	33.3	3/4	19.1	3/32	2.4	ES1026	3 3/8	85.7	1 13/16	46.0	1/16	1.6	G303
1 5/16	33.3	3/4	19.1	3/16	4.8	ES65	3 3/8	85.7	3 3/16	81.0	3/32	2.4	G230
1 21/64	33.7	61/64	24.2	11/64	4.4	ES24-D	3 3/8	85.7	3 15/64	82.2	1/16	1.6	ES3009
1 1/2	38.1	23/32	16.5	3/32	2.4	G325-AF	3 25/64	86.1	3 7/64	79.0	9/64	3.6	G442
1 1/2	38.1	7/8	22.2	1/8	3.2	G110-AF	3 13/32	86.5	2 51/64	71.0	1/16	1.6	G379
1 5/8	41.3	63/64	25.0	3/32	2.4	ES1054	3 7/16	87.3	3	76.2	9/32	7.1	G279-C
1 49/64	44.8	1 31/64	37.7	9/64	3.6	ES3012	3 29/64	87.7	2 5/8	66.7	7/32	5.6	G188-B
1 7/8	47.6	1 3/64	26.6	27/64	10.7	ES1031	3 15/32	88.1	3 1/8	79.4	7/32	5.6	G383-B
1 31/32	50.0	1 1/32	26.2	3/32	2.4	G282	3 15/32	88.1	3 3/16	81.0	1/8	3.2	G233-B
2	50.8	1 51/64	46.0	7/64	2.8	G328	3 31/64	88.5	3	76.2	3/32	2.4	G488
2 1/32	51.6	31/32	24.6	1/16	1.6	G337	3 1/2	88.9	3 1/8	79.4	1/16	1.6	G274
2 3/32	53.2	1 23/32	43.7	1/4	6.4	ES1092	3 1/2	88.9	3 7/32	81.8	3/32	2.4	G255
2 7/32	56.4	1 11/16	42.9	13/64	5.2	ES1369-A	3 33/64	89.3	3 7/64	79.0	13/64	5.2	G232
2 9/32	57.9	1 13/16	46.0	1/32	0.8	ES4006	3 33/64	89.3	3 15/64	82.2	9/64	3.6	G247
2 25/64	60.7	2 7/64	53.6	9/64	3.6	G441	3 33/64	89.3	3 19/64	83.7	1/16	1.6	G178
2 7/16	61.9	2 13/64	56.0	7/64	2.8	G467	3 17/32	89.7	1 13/32	84.9	1/16	1.6	G237
2 31/64	63.1	2 1/4	57.2	1/8	3.2	G353	3 9/16	90.5	3 5/16	84.1	1/8	3.2	G344
2 1/2	63.5	1 39/64	40.9	7/16	11.1	ES1039	3 5/8	92.1	3 11/32	84.9	1/8	3.2	G432
2 9/16	65.1	2 13/64	56.0	3/32	2.4	G226	3 41/64	92.5	3 3/8	85.7	5/32	4.0	G264-A
2 19/32	65.9	2 15/64	56.8	13/64	5.2	G324-A	3 11/16	93.7	3 1/4	82.6	1/16	1.6	G338
2 19/32	65.9	2 5/16	58.7	19/64	7.5	G431	3 11/16	93.7	3 5/16	84.1	3/16	4.8	G436
2 5/8	66.7	2 31/64	63.5	1/16	1.6	ES1023	3 11/16	93.7	3 31/64	88.5	7/64	2.8	G387
							3 23/32	94.5	3 7/32	81.8	1/16	1.6	G167
							3 3/4	95.3	1 13/16	46.0	1/16	1.6	ES3029
							3 3/4	95.3	3 1/4	82.6	1/8	3.2	G183
							3 3/4	95.3	3 1/2	88.9	1/8	3.2	G366
							3 49/64	95.6	3 11/32	84.9	13/64	5.2	G406
							3 49/64	95.6	3 13/32	86.5	1/16	1.6	G268
							3 25/32	96.0	3 35/64	90.1	1/16	1.6	G121-B
							3 55/64	98.0	3 19/32	91.3	9/64	3.6	G458
							3 7/8	98.4	3 11/16	93.7	1/8	3.2	G241
							3 57/64	98.8	3 7/16	87.3	1/16	1.6	G100
							3 57/64	98.8	3 39/64	91.7	9/64	3.6	G229



WARNING: These products can expose you to chemicals, including Diisononyl Phthalate, Carbon black extracts, Nickel, 1,3 Butadiene, Ethylene Oxide, Epichlorohydrin, which are known to the State of California to cause cancer, and Bisphenol-A, Ethylene Glycol, Ethylene Oxide, 1,3 Butadiene, Epichlorohydrin, which are known to the State of California to cause birth defects or other reproductive harm. For more information go to www.P65Warnings.ca.gov.

ROUND GASKETS ARRANGED BY O.D.

O.D. Inches	O.D. (mm)	I.D. Inches	I.D. (mm)	THICK Inches	THICK (mm)	CARQUEST NUMBER	O.D. Inches	O.D. (mm)	I.D. Inches	I.D. (mm)	THICK Inches	THICK (mm)	CARQUEST NUMBER
3 57/64	98.8	3 23/32	94.5	1/8	3.2	G107	4 15/16	125.4	3 15/16	100.0	1/32	0.8	ES4008
3 15/16	100.0	2 9/32	57.9	1/32	0.8	ES4007	4 15/16	125.4	4 13/32	111.9	1/16	1.6	G132
3 15/16	100.0	3	76.2	1/16	1.6	G142	4 15/16	125.4	4 19/32	116.7	13/64	5.2	G725
3 31/32	100.8	3 19/32	91.3	1/4	6.4	G395	4 15/16	125.4	4 47/64	120.3	7/32	5.6	G494
3 63/64	101.2	3 43/64	93.3	1/8	3.2	G332	4 63/64	126.6	4 3/8	111.1	3/16	4.8	G704
							4 63/64	126.6	4 21/32	118.3	3/16	4.8	G483
4	101.6	3 5/16	84.1	3/32	2.4	G299	5	127.0	4 23/32	119.9	1/8	3.2	G240
4	101.6	3 13/32	86.5	1/16	1.6	G174-A	5 1/64	127.4	4 35/64	115.5	3/32	2.4	G291
4	101.6	3 3/4	95.3	9/64	3.6	G162	5 1/64	127.4	4 19/32	116.7	13/64	5.2	G439
4	101.6	3 49/64	95.6	1/8	3.2	G153	5 1/64	127.4	4 47/64	120.3	9/64	3.6	G342
4 1/64	102.0	3 53/64	97.2	7/64	2.8	G139	5 1/64	127.4	4 25/32	121.4	1/8	3.2	G115-MSB
4 1/16	103.2	3 1/2	88.9	3/32	2.4	G133	5 1/64	127.4	4 51/64	121.8	3/32	2.4	G280
4 1/16	103.2	3 37/64	90.9	3/32	2.4	G434	5 1/64	127.4	4 13/16	122.2	1/8	3.2	G375
4 5/64	103.6	3 13/16	96.8	1/16	1.6	G235	5 1/32	127.8	4 15/32	113.5	9/32	7.1	G290
4 1/8	104.8	3 1/2	88.9	5/64	2.0	G114	5 1/32	127.8	4 1/2	114.3	13/32	10.3	G286-C
4 1/8	104.8	3 59/64	99.6	1/8	3.2	G435	5 3/64	128.2	4 45/64	119.5	3/16	4.8	G710
4 9/64	105.2	3 55/64	98.0	9/64	3.6	G410	5 1/16	128.6	4 13/16	122.2	5/32	4.0	G331
4 5/32	105.6	3 55/64	98.0	1/16	1.6	G123	5 3/32	129.4	4 45/64	119.5	3/16	4.8	G369-B
4 11/64	106.0	3 15/16	100.0	3/32	2.4	G202	5 3/32	129.4	4 45/64	119.5	3/16	4.8	G369-V
4 3/16	106.4	3 11/16	93.7	1/16	1.6	G120-A	5 1/8	130.2	3 9/16	90.5	1/32	0.8	G1086-AF
4 3/16	106.4	3 25/32	96.0	1/16	1.6	G105	5 1/8	130.2	4 3/8	111.1	3/32	2.4	G115-A
4 1/4	108.0	3 47/64	94.9	3/32	2.4	G457-A	5 1/8	130.2	4 5/8	117.5	1/16	1.6	G143
4 1/4	108.0	4	101.6	1/16	1.6	G377	5 9/64	130.6	4 51/64	121.8	3/32	2.4	G184-A
4 1/4	108.0	4	101.6	5/32	4.0	G192	5 9/64	130.6	4 55/64	123.4	9/64	3.6	G315
4 17/64	108.3	3 63/64	101.2	9/64	3.6	G376	5 5/32	131.0	4 47/64	120.3	13/64	5.2	G372
4 9/32	108.7	3 31/32	100.8	1/8	3.2	G220	5 1/4	133.4	3 1/2	88.9	1/16	1.6	G253-A
4 5/16	109.5	3 15/16	100.0	1/16	1.6	G243-A	5 17/64	133.7	4 27/32	123.0	13/64	5.2	G445
4 5/16	109.5	4 1/8	104.8	7/64	2.8	G740	5 17/64	133.7	4 63/64	126.6	9/64	3.6	G443
4 21/64	109.9	3 27/32	97.6	3/8	9.5	G498-A	5 9/32	134.1	4 23/32	119.9	9/32	7.1	G417
4 11/32	110.3	3 27/32	97.6	7/64	2.8	G421	5 9/32	134.1	4 51/64	121.8	1/8	3.2	G365
4 11/32	110.3	4 3/32	104.0	1/8	3.2	G168-B	5 5/16	134.9	4 13/16	122.2	1/16	1.6	G135
4 3/8	111.1	4 1/8	104.8	1/8	3.2	G402	5 11/32	135.7	4 51/64	121.8	1/16	1.6	G257
4 25/64	111.5	3 31/32	100.8	13/64	5.2	G219	5 11/32	135.7	5 1/32	127.8	1/8	3.2	G151-B
4 25/64	111.5	4 1/64	102.0	3/16	4.8	G480	5 23/64	136.1	4 61/64	125.8	13/64	5.2	G392
4 13/32	111.9	3 5/8	92.1	1/16	1.6	G108	5 25/64	136.9	5 7/64	129.8	9/64	3.6	G362
4 13/32	111.9	4	101.6	1/16	1.6	G122-A	5 13/32	137.3	5 13/32	137.3	1/16	1.6	G296
4 13/32	111.9	4 3/32	104.0	5/32	4.0	G485	5 13/32	137.3	4 3/4	120.7	3/32	2.4	G260
4 7/16	112.7	3 15/16	100.0	1/16	1.6	G112	5 31/64	139.3	5 7/32	132.6	1/8	3.2	G397
4 7/16	112.7	4 15/64	107.6	7/64	2.8	G468	5 33/64	140.1	4 3/4	120.7	1/16	1.6	G131
4 1/2	114.3	4 19/64	109.1	1/8	3.2	G171	5 33/64	140.1	5 7/32	132.6	1/8	3.2	G307
4 33/64	114.7	4 11/64	106.0	1/16	1.6	G384	5 33/64	140.1	5 15/64	133.0	9/64	3.6	G347
4 33/64	114.7	4 15/64	107.6	9/64	3.6	G333	5 17/32	140.5	4 31/32	126.2	9/32	7.1	G211
4 33/64	114.7	4 17/64	108.3	3/32	2.4	G273	5 9/16	141.3	5 7/32	132.6	9/32	7.1	G717
4 17/32	115.1	4 1/64	102.0	1/16	1.6	G127	5 5/8	142.9	5 7/32	132.6	13/64	5.2	G278
4 9/16	115.9	4 11/64	106.0	1/4	6.4	G118	5 41/64	143.3	5 5/64	129.0	3/16	4.8	G380
4 19/32	116.7	4 3/16	106.4	5/32	4.0	G222-B	5 41/64	143.3	5 23/64	136.1	9/64	3.6	G354
4 5/8	117.5	4 3/16	106.4	1/8	3.2	G141	5 11/16	144.5	5 15/32	138.9	1/8	3.2	G196-B
4 41/64	117.9	3 61/64	100.4	19/32	15.1	G293-B	5 47/64	145.7	5 7/32	132.6	1/16	1.6	G137-B
4 41/64	117.9	4 23/64	110.7	9/32	7.1	G310	5 3/4	146.1	5 1/4	133.4	1/16	1.6	G169
4 41/64	117.9	4 13/32	111.9	1/8	3.2	G302	5 3/4	146.1	5 15/32	138.9	9/64	3.6	G368
4 21/32	118.3	4 1/16	103.2	1/16	1.6	G185	5 27/32	148.4	5 7/16	138.1	13/64	5.2	G394
4 21/32	118.3	4 1/8	104.8	3/32	2.4	G373	5 7/8	149.2	5 3/8	136.5	1/16	1.6	G363
4 21/32	118.3	4 9/32	108.7	13/64	5.2	G408	5 7/8	149.2	5 39/64	142.5	9/64	3.6	G203
4 11/16	119.1	4	101.6	1/16	1.6	G106	5 29/32	150.0	5 11/32	135.7	9/32	7.1	G446
4 11/16	119.1	4 1/4	108.0	1/16	1.6	G119	5 15/16	150.8	5 9/16	141.3	7/64	2.8	G159
4 45/64	119.5	4 9/32	108.7	5/32	4.0	G414	5 15/16	150.8	5 23/32	145.3	1/8	3.2	G140-A
4 23/32	119.9	4 7/16	112.7	1/8	3.2	G251	5 15/16	150.8	5 47/64	145.7	7/64	2.8	G437
4 47/64	120.3	4 11/32	110.3	1/16	1.6	G104	5 63/64	152.0	5 25/64	136.9	1/16	1.6	G164-A
4 49/64	121.0	4 11/32	110.3	1/4	6.4	G385	5 63/64	152.0	5 1/2	139.7	1/16	1.6	G180-A
4 49/64	121.0	4 23/64	110.7	13/64	5.2	G236-A	6	152.4	5 1/4	133.4	1/2	12.7	G224B-AF
4 49/64	121.0	4 31/64	113.9	9/64	3.6	G447	6 1/64	152.8	5 19/32	142.1	13/64	5.2	G433
4 49/64	121.0	4 39/64	117.1	1/8	3.2	G214	6 1/32	153.2	5 13/32	137.3	1/16	1.6	G429
4 51/64	121.8	4 5/32	105.6	1/16	1.6	G128-A	6 1/32	153.2	5 15/32	138.9	9/64	3.6	G263
4 13/16	122.2	4 3/8	111.1	1/16	1.6	G208-A	6 1/32	153.2	5 17/32	140.5	3/32	2.4	G148
4 27/32	123.0	4 39/64	117.1	1/8	3.2	G374	6 3/64	153.6	5 49/64	146.5	1/16	1.6	G144
4 27/32	123.0	4 39/64	117.1	1/8	3.2	G470							
4 55/64	123.4	4 29/64	113.1	13/64	5.2	G386							



WARNING: These products can expose you to chemicals, including Diisononyl Phthalate, Carbon black extracts, Nickel, 1,3 Butadiene, Ethylene Oxide, Epichlorohydrin, which are known to the State of California to cause cancer, and Bisphenol-A, Ethylene Glycol, Ethylene Oxide, 1,3 Butadiene, Epichlorohydrin, which are known to the State of California to cause birth defects or other reproductive harm. For more information go to www.P65Warnings.ca.gov.

ROUND GASKETS ARRANGED BY O.D.

O.D. Inches	O.D. (mm)	I.D. Inches	I.D. (mm)	THICK Inches	THICK (mm)	CARQUEST NUMBER	O.D. Inches	O.D. (mm)	I.D. Inches	I.D. (mm)	THICK Inches	THICK (mm)	CARQUEST NUMBER
6 1/16	154.0	5 13/16	147.6	3/32	2.4	G407	8 3/4	222.3	8	203.2	3/8	9.5	G109-AF
6 3/32	154.8	5 51/64	147.3	1/16	1.6	G138	8 49/64	222.6	8	203.2	1/2	12.7	G287-AF
6 1/8	155.6	5 15/32	138.9	3/32	2.4	G117	8 57/64	225.8	8 15/32	215.1	13/64	5.2	G438
6 1/8	155.6	5 1/2	139.7	3/32	2.4	G355	8 31/32	227.8	8 15/32	215.1	15/64	6.0	G309-B
6 9/64	156.0	5 55/64	148.8	1/8	3.2	G265	9	228.6	8 15/32	215.1	9/32	7.1	G157
6 15/64	158.4	5 53/64	148.0	13/64	5.2	G336	9 33/64	241.7	8 3/4	222.3	1/2	12.7	G297-AF
6 1/4	158.8	4 1/2	114.3	1/8	3.2	G163	9 5/8	244.5	7 3/4	196.9	1/16	1.6	G289
6 17/64	159.1	5 63/64	152.0	9/64	3.6	G444	9 11/16	246.1	8 11/16	220.7	2 1/8	54.0	G475-AF
6 9/32	159.5	4 3/8	111.1	1/16	1.6	G43-AF	9 3/4	247.7	8 1/16	204.8	1/32	0.8	G201
6 11/32	161.1	5 7/8	149.2	1/8	3.2	G409	9 3/4	247.7	8 5/16	211.1	1/32	0.8	G155
6 25/64	162.3	5 31/32	151.6	13/64	5.2	G426	10	254.0	7	177.8	1/16	1.6	G66-AF
6 25/64	162.3	6 7/32	158.0	9/32	7.1	G416	10	254.0	8 13/16	223.8	1/2	12.7	G54B-AF
6 31/64	164.7	6 15/64	158.4	9/64	3.6	G360	10 57/64	276.6	10 1/8	257.2	1/2	12.7	G182-AF
6 17/32	165.9	6 3/64	153.6	1/8	3.2	G411	11	279.4	9	228.6	1/4	6.4	G207-AF
6 9/16	166.7	6 1/16	154.0	5/64	2.0	G102-A	11	279.4	9 1/8	231.8	1/4	6.4	G472-AF
6 9/16	166.7	6 5/16	160.3	1/16	1.6	G317	11	279.4	10	254.0	2 1/8	54.0	G17-AF
6 5/8	168.3	5 1/2	139.7	1/32	0.8	G269	11	279.4	10 1/4	260.4	1/2	12.7	G85B-AF
6 5/8	168.3	5 1/2	139.7	1/32	0.8	G281	11 1/16	281.0	10 3/16	258.8	7/16	11.1	G348-AF
6 11/16	169.9	6 1/8	155.6	1/16	1.6	G415	11 1/8	282.6	9 1/8	231.8	1/32	0.8	G300
6 49/64	171.8	6 31/64	164.7	9/64	3.6	G359	11 1/4	285.8	9 9/16	242.9	1/32	0.8	G261
6 59/64	175.8	6 7/16	163.5	3/32	2.4	G262	11 3/8	288.9	10 3/4	273.1	5/16	7.9	G31-AF
6 31/32	177.0	6 15/32	164.3	17/64	6.7	G400	11 25/64	289.3	10 5/8	269.9	1/2	12.7	G53B-AF
7	177.8	5 1/8	130.2	1/16	1.6	G288	11 49/64	298.8	11	279.4	1/2	12.7	G298-AF
7	177.8	5 7/32	132.6	1/32	0.8	G399	12	304.8	11 3/8	288.9	5/16	7.9	G37-AF
7	177.8	6 1/4	158.8	1/2	12.7	G272-AF	12 17/64	311.5	11 1/2	292.1	1/2	12.7	G102B-AF
7 3/64	179.0	6 27/64	163.1	5/64	2.0	G356	12 5/8	320.7	11 5/8	295.3	2 1/8	54.0	G225-AF
7 1/16	179.4	5 5/8	142.9	1/16	1.6	G393	12 3/4	323.9	10 1/2	266.7	1/4	6.4	G21-AF
7 1/8	181.0	6 7/16	163.5	5/64	2.0	G210	12 7/8	327.0	10 5/8	269.9	3/8	9.5	G499-AF
7 1/4	184.2	5 11/16	144.5	61/64	24.2	G304	13	330.2	11 5/8	295.3	2 1/8	54.0	G41-AF
7 25/64	187.7	6 31/32	177.0	13/64	5.2	ES3020	13	330.2	12 3/8	314.3	5/16	7.9	G34-AF
7 7/16	188.9	5 1/2	139.7	1/16	1.6	G343-A	13 11/32	338.9	13 3/16	335.0	5/64	2.0	G523-AF
7 15/32	189.7	7	177.8	15/64	6.0	G223	13 5/8	346.1	12 5/8	320.7	1/2	12.7	G474-AF
7 33/64	190.9	7 15/64	183.8	9/64	3.6	G382	13 41/64	346.5	12 7/8	327.0	1/2	12.7	G501-AF
7 33/64	190.9	7 15/64	183.8	9/64	3.6	G382-V	14 3/8	365.1	13 3/8	339.7	2 3/16	55.6	G285-AF
7 53/64	198.8	7 29/64	189.3	9/32	7.1	G193	14 1/2	368.3	12 3/4	323.9	1/2	12.7	G93B-AF
7 29/32	202.2	7 29/64	189.3	7/32	5.6	ES3231	14 13/16	376.2	12 15/16	328.6	1/32	0.8	G305
8	203.2	7 1/4	184.2	3/8	9.5	G430-AF	15	381.0	12 3/4	323.9	1/4	6.4	G25-AF
8 1/16	204.8	7 3/8	187.3	1/4	6.4	G316	15	381.0	13	330.2	1/4	6.4	G422-AF
8 1/8	206.4	7 3/4	196.9	1/16	1.6	G209	15	381.0	14 11/16	373.1	2 1/8	54.0	G330-AF
8 1/4	209.6	5 1/2	139.7	1/16	1.6	G319	15 3/4	400.1	13 3/4	349.3	7/32	5.6	G145-AF
8 17/64	209.9	7 1/2	190.5	1/2	12.7	G103B-AF	16	406.4	6 1/2	165.1	3/32	2.4	G306
8 17/64	209.9	7 63/64	202.8	9/64	3.6	G412	18 1/4	463.6	17 1/4	438.2	2 1/8	54.0	G141-AF
8 9/32	210.3	7 23/32	196.1	9/32	7.1	G206							
8 5/16	211.1	6 3/4	171.5	1/32	0.8	G197							
8 1/2	215.9	7 31/32	202.4	17/64	6.7	G252							
8 17/32	216.7	7 31/32	202.4	9/32	7.1	G238							
8 5/8	219.1	6 5/8	168.3	1/16	1.6	G314							
8 11/16	220.7	7 11/16	195.3	1/16	1.6	G42-AF							
8 23/32	221.5	7 19/32	192.9	1/16	1.6	G26-AF							



WARNING: These products can expose you to chemicals, including Diisononyl Phthalate, Carbon black extracts, Nickel, 1,3 Butadiene, Ethylene Oxide, Epichlorohydrin, which are known to the State of California to cause cancer, and Bisphenol-A, Ethylene Glycol, Ethylene Oxide, 1,3 Butadiene, Epichlorohydrin, which are known to the State of California to cause birth defects or other reproductive harm. For more information go to www.P65Warnings.ca.gov.

SPIN-ON FILTERS BY TAP SIZE (U.S. THREAD)

	THREAD I.D.	PER Inch	O.D. Inches	O.D. (mm)	LENGTH Inches	LENGTH (mm)	GASKET	FEATURES	BALDWIN NUMBER
SPIN-ON FILTER FEATURES ARE CODED AS FOLLOWS	3/8	18 NPT	3	76.2	2 25/32	70.6			BT40015
	3/8	24	3	7/16	4 13/16	122.2	[3] Included	D	BF939
	7/16	20	3	7/16	4 13/16	122.2	ES1001,		B4
	7/16	20	3	7/16	4 13/16	122.2	[1] Included		
							[2] Included	D	BF938
	5/8	18	3	11/16	3 7/8	98.4	G381-A	MO	B296
	5/8	18	3	11/16	4 3/8	111.1	G381-A	MO	BT341
	5/8	18	3	11/16	5 3/8	136.5	G381-A	MO	B50
	5/8	18	3	11/16	5 3/8	136.5	G381-A	BP, MO	BT541
	5/8	11	3	11/16	5 3/8	136.5	G381-A		BF968
AD Anti-Drainback Valve	5/8	18	3	11/16	5 13/32	137.3	G381-A	AD, BP	BT248
ADP Anti-Drainback Pipe	5/8	18	3	11/16	6 5/8	168.3	G381-A	MO	B164
BP 8-10 PSID By-Pass Valve	5/8	18	4	1/4	3 3/16	81.0	[1] Included		B222
BPI By-Pass Included	5/8	18	4	1/4	3 3/16	81.0	[1] Included	MO	B494
BPS By-Pass Screen	5/8	18	4	1/4	5 7/8	149.2	G401		B7124
BTA PLUS Balanced Treatment Additive Plus	11/16	16	3	11/16	3 7/32	81.8	G381-A	BTE	BW5182
BTE Balanced Treatment for Ethylene Glycol Antifreeze	11/16	16	3	11/16	3 7/8	98.4	G381-A		BF791
	11/16	16	3	11/16	4 3/8	111.1	G381-A	BTA PLUS	BW5070
	11/16	16	3	11/16	4 3/8	111.1	G381-A	BTA PLUS	BW5071
	11/16	16	3	11/16	4 3/8	111.1	G381-A	BTA PLUS	BW5072
D Drain	11/16	16	3	11/16	4 3/8	111.1	G381-A		B5088
FECV Front-End Check Valve	11/16	16	3	11/16	4 3/8	111.1	G381-A		B5089
	11/16	16	3	11/16	4 3/8	111.1	G381-A	BTE	BW5136
FP Fill Port	11/16	16	3	11/16	4 13/32	111.9	G381-A	BTE	BW5137
HBP 18-25 PSID High Pressure By-Pass Valve	11/16	16	3	11/16	5 11/32	135.7	G381-A	BTE	BW5139
	11/16	16	3	11/16	5 3/8	136.5	G381-A	BTA PLUS	BW5073
ISO Inside-Out Flow Direction	11/16	16	3	11/16	5 3/8	136.5	G381-A	BTA PLUS	BW5074
	11/16	16	3	11/16	5 3/8	136.5	G381-A	BTA PLUS	BW5075
LBP 2-7 PSID Low Pressure By-Pass Valve	11/16	16	3	11/16	5 3/8	136.5	G381-A	BTA PLUS	BW5082
	11/16	16	3	11/16	5 3/8	136.5	G381-A		B5090
	11/16	16	3	11/16	5 3/8	136.5	G381-A	BTE	BW5138
MBP 11-17 PSID Medium Pressure By-Pass Valve	11/16	16	3	11/16	5 3/8	136.5	G381-A	BTE	BW5143
	11/16	16	3	11/16	5 13/32	137.3	G381-A		B5134
	11/16	16	3	11/16	5 13/32	137.3	G381-A	BTE, MO	BW5200
	11/16	16	3	11/16	5 13/32	137.3	G381-A	BTA PLUS, MO	BW5250
	11/16	16	3	11/16	7 5/32	181.8	G381-A	BTA PLUS	BW5076
	11/16	16	3	11/16	7 5/32	181.8	G381-A	BTE	BW5140
	11/16	16	3	25/32	4 1/32	102.4	[3] Included		BF791-O
	3/4	16	2	3/32	4 25/32	121.4	[1] O-Ring Attached;		BF7839
							[1] Included		
MO Metering Orifice	3/4	16	2	9/16	2 5/8	66.7	[1] Included	AD, BP	B7356
PS Integral Post Seal Gasket	3/4	16	2	9/16	3 1/2	88.9	[1] Included	AD, MBP	B37
	3/4	16	2	9/16	4 3/4	120.7	[1] Included	AD, MBP	B7238
	3/4	16	2	21/32	3 1/2	88.9	[1] Included	HBP	BT9388
PSR Post Seal Required; Must install loose O-Ring or D-Ring on Post for Seal	3/4	16	2	11/16	3	76.2	[1] Included	AD, MBP	B33
	3/4	16	2	11/16	3	76.2	[1] Included	AD, BPI	B7286
	3/4	16	2	11/16	3 1/2	88.9	[1] Included	AD	B1406
	3/4	16	2	25/32	2 5/8	66.7	[1] Included	AD, BPI	B7333
RC Reinforced Centertube	3/4	16	2	29/32	3 1/2	88.9	G449-B	AD, BP	BT223
	3/4	16	2	29/32	3 1/2	88.9	[1] Included		B40036
	3/4	16	2	29/32	4 27/32	123.0	[1] Included	AD, FECV, MBP	B1416
SHBP 30-45 PSID Super High Pressure By-Pass Valve	3/4	16	2	29/32	4 27/32	123.0	[1] Included	AD, FECV, SHBP	B40128
	3/4	16	2	15/16	4 27/32	123.0	G449-B	AD, SHBP	B178
	3/4	16	3		2 9/32	57.9	[1] Included	AD, SHBP	B7294
	3/4	16	3		2 27/32	72.2	[1] Included	AD	B7049
	3/4	16	3		2 7/8	73.0	G449-B	AD, BP	B1410
SP Sensor Port	3/4	16	3		3 1/8	79.4	[1] Included		B7295
XHBP 50+ PSID Extra High Pressure By-Pass Valve	3/4	16	3		3 1/2	88.9	G449-B	AD, SHBP	B228
	3/4	16	3		3 1/2	88.9	G449-B	BP	B1413
	3/4	16	3		3 17/32	89.7	G449-B	AD, MBP	B7361
	3/4	16	3		3 17/32	89.7	[1] Included	MBP	B7491
	3/4	16	3		3 17/32	89.7	[1] Included	AD, MBP	BT8409
	3/4	16	3		3 27/32	97.6	[1] Included	AD, BPI	B7275
	3/4	16	3		3 7/8	98.4	[1] Included	AD, MBP	B7290
	3/4	16	3		4 1/16	103.2	[1] Included	AD, BP	B159
	3/4	16	3		4 1/16	103.2	[1] Included	AD, HBP	B1430

Do NOT Interchange Filters with Different Features



WARNING: These products can expose you to chemicals, including Diisononyl Phthalate, Carbon black extracts, Nickel, 1,3 Butadiene, Ethylene Oxide, Epichlorohydrin, which are known to the State of California to cause cancer, and Bisphenol-A, Ethylene Glycol, Ethylene Oxide, 1,3 Butadiene, Epichlorohydrin, which are known to the State of California to cause birth defects or other reproductive harm. For more information go to www.P65Warnings.ca.gov.

SPIN-ON FILTERS BY TAP SIZE (U.S. THREAD)

THREAD I.D.	PER Inch	O.D. Inches	O.D. (mm)	LENGTH Inches	LENGTH (mm)	GASKET	FEATURES	BALDWIN NUMBER
3/4	16	3	76.2	4 3/32	104.0	[1] Included	AD, MBP	B7020
3/4	16	3	76.2	4 27/32	123.0	G449-B	AD, BP	B243
3/4	16	3	76.2	5 3/32	129.4	[1] Included	AD	B143
3/4	16	3	76.2	5 1/8	130.2	G449-B	AD, ADP, BP	BT215
3/4	16	3 1/32	77.0	2 5/16	58.7	G449-B	AD, BP	B7165
3/4	16	3 1/32	77.0	2 5/16	58.7	G449-B	SHBP	B7410
3/4	16	3 1/32	77.0	3 3/16	81.0	[1] Included		B7287
3/4	16	3 1/32	77.0	3 7/16	87.3	[1] Included	AD, BP	B131
3/4	16	3 1/32	77.0	3 1/2	88.9	G449-B	AD, HBP	B1405
3/4	16	3 1/32	77.0	3 1/2	88.9	G449-B	AD	B1407
3/4	16	3 1/32	77.0	3 1/2	88.9	[1] Included		BF7648
3/4	16	3 1/32	77.0	3 1/2	88.9	[1] Included	HBP	BT8323
3/4	16 UNF	3 1/32	77.0	3 1/2	88.9	[1] Included	AD, HBP	B40136
3/4	16	3 1/32	77.0	4 1/16	103.2	[1] Included	AD	B113
3/4	16	3 1/32	77.0	4 3/32	104.0	[1] Included	AD, SHBP	B7139
3/4	16	3 1/32	77.0	4 3/32	104.0	[1] Included	AD, HBP	B7172
3/4	16	3 1/32	77.0	4 3/32	104.0	G449-B		BF7892
3/4	16	3 1/32	77.0	4 3/32	104.0	[1] Included		BT8908
3/4	16	3 1/32	77.0	4 3/32	104.0			BF46228
3/4	16	3 1/32	77.0	4 13/16	122.2	[1] Included		BF13
3/4	16	3 1/32	77.0	4 13/16	122.2	[1] Included	HBP	B7458
3/4	16	3 1/32	77.0	5 1/2	139.7	[1] Included	XHBP	BT8384
3/4	16	3 1/32	77.0	5 11/16	144.5	G449-B	D, PS	BF1275
3/4	16	3 1/32	77.0	5 13/16	147.6	[1] Included		BF941
3/4	16	3 1/32	77.0	5 13/16	147.6	[1] Included	AD, HBP	B7091
3/4	16	3 1/32	77.0	5 27/32	148.4	[1] Included	AD	B295
3/4	16	3 1/32	77.0	5 27/32	148.4	[1] Included	AD, HBP	BT353
3/4	16	3 1/32	77.0	5 7/8	149.2	G449-B		BF330
3/4	16	3 1/16	77.8	2 11/32	59.5	G449-B	AD, HBP	B7222
3/4	16	3 1/16	77.8	3 7/16	87.3	[1] Included		BF954
3/4	16	3 1/16	77.8	3 1/2	88.9			B40006
3/4	16	3 3/32	78.6	3 31/32	100.8	[1] Included		BF7967
3/4	16	3 1/8	79.4	3	76.2	[1] Included		BF7840
3/4	16	3 1/8	79.4	3 21/32	92.9	[1] Included	MBP	B7434
3/4	16	3 1/8	79.4	3 7/8	98.4	[1] Included		BF7841
3/4	16	3 1/8	79.4	4 1/32	102.4	[1] Included	AD, MBP	B7433
3/4	16	3 1/4	82.6	3 5/32	80.2	[1] Included	AD, MBP	B7119
3/4	16	3 5/16	84.1	4 5/8	117.5	[1] Included	SP	BF7598
3/4	16	3 9/16	90.5	5 7/16	138.1	[1] Included,		
3/4	16	3 9/16	90.5	5 7/16	138.1	G381-A	D, ISO, SP	BF7532
3/4	16	3 9/16	90.5	5 7/16	138.1	[1] Included,	D, ISO, SP	BF7535
3/4	16	3 11/16	93.7	2 9/16	65.1	G381-A		
3/4	16	3 11/16	93.7	2 29/32	73.8	G381-A	AD, BP	B7221
3/4	16	3 11/16	93.7	3 1/4	82.6	G401	AD, MBP	BT8493
3/4	16	3 11/16	93.7	3 1/4	82.6	G381-A	AD, BP	B132
3/4	16	3 11/16	93.7	3 1/4	82.6	G381-A	AD, HBP	B1434
3/4	16	3 11/16	93.7	3 1/4	82.6	G381-A	AD, HBP	B7152
3/4	16	3 11/16	93.7	3 1/4	82.6	G401	AD, MBP	B7240
3/4	16	3 11/16	93.7	3 1/4	82.6	[1] Included	AD, MBP	B7511
3/4	16	3 11/16	93.7	3 1/4	82.6	G324-A		BF7541
3/4	16	3 11/16	93.7	3 1/4	82.6	G324-A		BF7666
3/4	16	3 11/16	93.7	3 1/4	82.6	G381-A		BT40028
3/4	16	3 11/16	93.7	3 7/8	98.4	G381-A	AD, BP	B34
3/4	16	3 11/16	93.7	3 7/8	98.4	G381-A	AD	B120
3/4	16	3 11/16	93.7	3 7/8	98.4	G381-A	AD, BP	B163
3/4	16 UNF	3 11/16	93.7	3 7/8	98.4	[1] Included		B40073
3/4	16	3 11/16	93.7	4 1/16	103.2	[1] Included		BT8916
3/4	16	3 11/16	93.7	4 11/32	110.3	G381-A		BF9877
3/4	16	3 11/16	93.7	4 3/8	111.1	G381-A	AD, HBP	B229
3/4	16	3 11/16	93.7	4 3/8	111.1	G381-A	AD, BP	B233
3/4	16	3 11/16	93.7	4 3/8	111.1	G324-A		BF719
3/4	16	3 11/16	93.7	4 3/8	111.1	G381-A	AD, HBP	B7403
3/4	16	3 11/16	93.7	4 3/8	111.1	G381-A		BF7559
3/4	16	3 11/16	93.7	4 3/8	111.1	G324-A	PS	BF7602
3/4	16	3 11/16	93.7	4 7/16	112.7	G401	AD, SHBP	B1429
3/4	16	3 11/16	93.7	4 7/16	112.7	G401	SHBP	B7099
3/4	16	3 11/16	93.7	4 7/16	112.7	G401	AD, XHBP	B7128
3/4	16	3 11/16	93.7	4 15/32	113.5	G401	AD, BP	BT420
3/4	16	3 11/16	93.7	4 1/2	114.3	[1] Included	AD, ADP, BP	B7271
3/4	16	3 11/16	93.7	5 3/8	136.5	G381-A	HBP	BT111

CAUTION!!!
Read These Instructions Before Using Size Charts

The filter size charts on this and following pages are for filter experts. Careless use could lead to errors. When you have exhausted all other ways to determine a filter number, locate a suspect here, then check the Product Guide for confirmation.

Size alone does not assure you of the right filtering media, gasket or other features. What is being filtered, filter efficiency, flow rate and direction of flow all have to be considered.

Spin-on filters are listed by tap size rather than length. All other filters are listed on an overall basis. Check your Product Guide for other dimensions. Progression is from the smallest to the largest in each category.

Do NOT Interchange Filters with Different Features

Be Sure to Check Product Guide, Cross-References and Applications

We Cannot be Responsible for Misapplications



WARNING: These products can expose you to chemicals, including Diisononyl Phthalate, Carbon black extracts, Nickel, 1,3 Butadiene, Ethylene Oxide, Epichlorohydrin, which are known to the State of California to cause cancer, and Bisphenol-A, Ethylene Glycol, Ethylene Oxide, 1,3 Butadiene, Epichlorohydrin, which are known to the State of California to cause birth defects or other reproductive harm. For more information go to www.P65Warnings.ca.gov.

SPIN-ON FILTERS BY TAP SIZE (U.S. THREAD)

A TYPICAL SPIN-ON

Spin-ons vary in size, media, fittings and other features. Let's look at the usual components.

Spin-on Can



No housing to clean; faster to change.

Baseplate and Seaming Cover Assembly



Size of mounting hole and gasket location determine if filter will seal. The baseplate is attached to the seaming cover and the seaming cover is attached to the can. (The gasket fits in the seaming cover.)

Compression Spring



Holds element in place to maintain seal.

Element End Caps



Closed End

Open End

End caps are bonded to the media.

Filtering Media

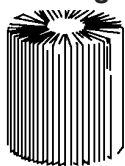

Microlite® pleated paper comes in more than 60 types for exact filtering requirements.

Centertube



Media is wrapped around the spiral perforated/louvered steel tube.

THREAD I.D.	PER Inch	O.D. Inches	O.D. (mm)	LENGTH Inches	LENGTH (mm)	GASKET	FEATURES	BALDWIN NUMBER
3/4	16	3 11/16	93.7	5 3/8	136.5	G381-A	AD	B118
3/4	16	3 11/16	93.7	5 3/8	136.5	G381-A	AD, ADP, BP	BT216
3/4	16	3 11/16	93.7	5 3/8	136.5	G324-A	AD, HBP	B244
3/4	16	3 11/16	93.7	5 3/8	136.5	G381-A	AD, ADP, MBP	B336
3/4	16	3 11/16	93.7	5 3/8	136.5	G381-A		BF797
3/4	16	3 11/16	93.7	5 3/8	136.5	G381-A	AD, SHBP	B7156
3/4	16	3 11/16	93.7	5 3/8	136.5	G381-A	AD, ADP, BP	B7467
3/4	16	3 11/16	93.7	5 3/8	136.5	[2] Included	ISO	BF7614
3/4	16	3 11/16	93.7	5 13/32	137.3	G381-A	AD, BP, FECV	B2
3/4	16	3 11/16	93.7	5 13/32	137.3	G381-A	AD, BP, FECV	B2-HPG
3/4	16	3 11/16	93.7	5 15/32	138.9	G401	AD, HBP	B252
3/4	16	3 11/16	93.7	5 15/32	138.9	G401	AD, ADP, HBP	B253
3/4	16	3 11/16	93.7	5 15/32	138.9	G401	AD, BP	BT8328
3/4	16	3 11/16	93.7	6 5/8	168.3	G381-A	XHBP	B481
3/4	16	3 11/16	93.7	7 1/8	181.0	G381-A	AD, ADP, BP	BT217
3/4	16	3 11/16	93.7	7 1/8	181.0	G381-A	AD, ADP, BP	BT237
3/4	16	3 11/16	93.7	7 1/8	181.0	G381-A	AD, BP	BT251
3/4	16	3 11/16	93.7	7 1/8	181.0	G381-A		BT7231
3/4	16	3 11/16	93.7	7 1/8	181.0	G381-A	AD, BP	B7311-MPG
3/4	16	3 23/32	94.5	3 7/8	98.4	G324-A		BT8905
3/4	16	3 23/32	94.5	3 31/32	100.8	[1] Included	AD, BPI	BT298
3/4	16	3 23/32	94.5	4 15/32	113.5	G401	AD	B7047
3/4	16	3 3/4	95.3	3 13/16	96.8	[1] Included	AD, MBP	B7431
3/4	16	3 3/4	95.3	3 31/32	100.8	G381-A	AD, HBP	B74
3/4	16	3 3/4	95.3	3 31/32	100.8	G381-A		BT8301
3/4	16	3 3/4	95.3	3 31/32	100.8	G381-A		BT8486
3/4	16	3 3/4	95.3	5 9/32	134.1	G381-A	AD, SHBP	B114
3/4	16	3 3/4	95.3	5 9/32	134.1	G381-A	AD	B246
3/4	16	3 3/4	95.3	5 25/32	146.8	[1] Included	SHBP	BT8922
3/4	16	3 3/4	95.3	6 9/32	159.5	[1] Included	D	BF9904
3/4	16	3 25/32	96.0	5 9/32	134.1	G381-A	AD	B7022
3/4	16	3 13/16	96.8	5 29/32	150.0	[1] Included	SHBP	BT7486
3/4	16	4 1/4	108.0	3 15/16	100.0	G381-A	AD, BP	BT5
3/4	16	4 1/4	108.0	3 15/16	100.0	G381-A	PS	BF7593
3/4	16	4 1/4	108.0	4 3/8	111.1	G381-A	AD, FECV, SHBP	BT7219
3/4	16	4 1/4	108.0	5 11/16	144.5	[1] Included	ADP, SHBP	BD232
3/4	16	4 1/4	108.0	5 13/16	147.6	G381-A	AD, HBP	BT267
3/4	16	4 1/4	108.0	5 13/16	147.6	G381-A	AD, ADP, SHBP	BT348
3/4	16	4 1/4	108.0	5 13/16	147.6	G381-A	AD, ADP, SHBP	BT7316
3/4	16	4 1/4	108.0	5 7/8	149.2	G401		B7018
3/4	16	4 1/4	108.0	7 11/32	186.5	G381-A	AD, HBP	BT238
3/4	16	4 1/4	108.0	7 11/32	186.5	G381-A	AD, ADP, SHBP	BT347
3/4	16	4 1/4	108.0	7 11/32	186.5	G381-A		BF783
3/4	20	2 7/8	73.0	3	76.2	[1] Included	BP	BT8460
3/4	20	3 1/32	77.0	3 1/2	88.9	[1] Included		BT8413
3/4	20	3 11/16	93.7	4 3/8	111.1	G381-A		B369
3/4	20	3 11/16	93.7	5 3/8	136.5	G381-A		B5176
3/4	20	3 11/16	93.7	5 3/8	136.5	G381-A	BTE	BW5178
3/4	20	3 11/16	93.7	5 3/8	136.5	G381-A	BTE, MO	BW5201
3/4	20	3 11/16	93.7	5 3/8	136.5	G381-A		B7025
3/4	20	4 1/4	108.0	7 3/8	187.3	G401		B128
13/16	12	3 11/16	93.7	6 5/8	168.3	[1] Included	PS	BF7640
13/16	12	3 11/16	93.7	7 3/32	180.2	[1] Included	PS	BF5810
13/16	12	3 11/16	93.7	7 3/32	180.2	[1] Included	PS	BF5815
13/16	12	3 11/16	93.7	7 3/32	180.2	[1] Included	PS	BF5816
13/16	12	3 23/32	94.5	4 13/32	111.9	[1] Included	PS	BF593
13/16	12	4 1/4	108.0	7 5/8	193.7	G381-A	PS	BF7612
13/16	12	4 1/4	108.0	10 7/16	265.1	G381-A	PS	BF7613
13/16	16	3	76.2	3 1/2	88.9	G449-B	AD	B31
13/16	16	3	76.2	4 3/32	104.0	G449-B	AD	B1432
13/16	16	3	76.2	4 3/32	104.0	[1] Included		B7010
13/16	16	3	76.2	5 1/8	130.2	G449-B		B30
13/16	16	3 1/32	77.0	4 1/8	104.8	G449-B	MBP	B1447
13/16	16	3 1/32	77.0	4 13/16	122.2	G449-B	SHBP	BT8417
13/16	16	3 1/32	77.0	5 1/2	139.7	[1] Included	XHBP	BT9402
13/16	16	3 5/8	92.1	3 7/8	98.4	[1] Included	AD, MBP	B7291
13/16	16	3 11/16	93.7	2 29/32	73.8	G401		BT779
13/16	16	3 11/16	93.7	3 3/16	81.0	[1] Included	AD	B1438
13/16	16	3 11/16	93.7	4 3/8	111.1	G381-A	AD	B39



WARNING: These products can expose you to chemicals, including Diisononyl Phthalate, Carbon black extracts, Nickel, 1,3 Butadiene, Ethylene Oxide, Epichlorohydrin, which are known to the State of California to cause cancer, and Bisphenol-A, Ethylene Glycol, Ethylene Oxide, 1,3 Butadiene, Epichlorohydrin, which are known to the State of California to cause birth defects or other reproductive harm. For more information go to www.P65Warnings.ca.gov.

SPIN-ON FILTERS BY TAP SIZE (U.S. THREAD)

THREAD I.D.	PER Inch	O.D. Inches	O.D. (mm)	LENGTH Inches	LENGTH (mm)	GASKET	FEATURES	BALDWIN NUMBER
13/16	16	3 11/16	93.7	4 3/8	111.1	G381-A	LBP	B358
13/16	16	3 11/16	93.7	5 5/16	134.9	[1] Included	AD, MBP	B1441
13/16	16	3 11/16	93.7	5 11/32	135.7	[1] Included		B6
13/16	16	3 11/16	93.7	5 11/32	135.7	[1] Included		B6-HPG
13/16	16	3 11/16	93.7	5 11/32	135.7	[1] Included	AD, HBP	B279
13/16	16	3 11/16	93.7	5 11/32	135.7	[1] Included	AD	B1428
13/16	16	3 11/16	93.7	5 3/8	136.5	[1] Included	AD	B9
13/16	16	3 11/16	93.7	5 3/8	136.5	G381-A	BP	BT112
13/16	16	3 11/16	93.7	5 13/32	137.3	G401	HBP	BT259
13/16	16	3 11/16	93.7	7 7/16	188.9	G381-A	D	BF974-D
13/16	16	3 11/16	93.7	8 11/16	220.7	[1] Included		B7
13/16	16	3 11/16	93.7	8 23/32	221.5	G381-A	AD	BT525
13/16	16	3 23/32	94.5	4 15/32	113.5	G401	HBP	BT344-S
13/16	16	3 23/32	94.5	5 15/32	138.9	G401		BT438
13/16	16	3 23/32	94.5	5 15/32	138.9	G401	HBP	B7359
13/16	16	3 3/4	95.3	6 1/32	153.2	[1] Included		BT8439-MPG
13/16	16	3 13/16	96.8	4 3/8	111.1	[1] Included		B27
13/16	16	3 13/16	96.8	4 3/8	111.1	[1] Included	AD, BP	BT241
13/16	16	3 13/16	96.8	4 3/8	111.1	[1] Included	AD	B360
13/16	16	4 1/4	108.0	7 11/32	186.5	G381-A		BT350
13/16	18	3	76.2	3 15/32	88.1	G449-B	PS	BF7969
13/16	18	3 11/16	93.7	4 11/16	119.1	G401		BF863
13/16	18	3 11/16	93.7	5 5/16	134.9	G401, [2] Included	SP	BF7985
13/16	18	3 11/16	93.7	5 13/32	137.3	G401, [1] O-Ring		BF7879
13/16	18	3 11/16	93.7	5 21/32	143.7	G401	D	BF896
13/16	18	3 11/16	93.7	6 1/8	155.6	G401, [2] Included	PSR, SP	BF7981
13/16	18	3 11/16	93.7	6 1/4	158.8	G401, [1] Included	D, PSR	BF1280
13/16	18	3 11/16	93.7	7 1/2	190.2	[2] Included	D	BF46170
13/16	18	4 1/4	108.0	7 11/32	186.5	G381-A	PS	BF877
13/16	18	4 1/4	108.0	8 1/8	206.4	G381-A	D, PS	BF1219
7/8	14	3	76.2	5 7/8	149.2	G449-B	PS	BF7531
7/8	14	3	76.2	7 1/8	181.0	[1] Included		BF7634
7/8	14	3 1/16	78.0	5 7/8	149.1			BF46176
7/8	14	3 11/16	93.7	4 3/8	111.1	G381-A	AD, BP	BT264
7/8	14	3 11/16	93.7	5 3/8	136.5	G381-A	BP	BT361
7/8	14	3 11/16	93.7	5 3/8	136.5	G381-A	HBP	BT395
7/8	14	3 11/16	93.7	5 3/8	136.5	[1] Included	PS	BF992
7/8	14	3 11/16	93.7	7 1/8	181.0	G381-A	AD, BP	BT126
7/8	14	3 11/16	93.7	7 1/8	181.0	G381-A	PS	BF7632
7/8	14	3 11/16	93.7	7 1/8	181.0	G381-A,		
7/8	14	3 11/16	93.7	8 11/16	220.7	[1] O-Ring Included	PS, PSR	BF7917
7/8	14	3 11/16	93.7	10 1/2	266.7	G381-A	PS	BF888
7/8	14	3 23/32	94.5	7 5/32	181.8	G381-A	PS	BF7631
7/8	14	3 23/32	94.5	7 5/32	181.8	G381-A,		BF7815
7/8	14	3 23/32	94.5	7 5/32	181.8	[1] Included		
7/8	14	3 23/32	94.5	7 5/32	181.8	G381-A,	PS, PSR	BF7924
7/8	14	3 3/4	95.3	6 1/32	153.2	[1] Included		
7/8	14	4 1/4	108.0	4 11/16	119.1	[1] Included	BPS, XHBP	BT8843-MPG
7/8	14	4 1/4	108.0	6 11/16	169.9	G381-A	PS	BF786
7/8	14	4 1/4	108.0	7	177.8	[1] Included	D, PS	BF7853
7/8	14	4 1/4	108.0	7 11/32	186.5	G401	PS	BF7629
7/8	14	4 1/4	108.0	7 11/32	186.5	G381-A	PS	BF588
7/8	14	4 1/4	108.0	8 17/32	216.7	G401	D, PS	BF7584
7/8	14	4 3/8	111.1	8 11/16	220.7	[2] Included	PS	BF9866-O
7/8	14	4 13/32	111.9	5 29/32	150.0	[1] Included		BF7717
7/8	16	4 1/4	108.0	7 11/32	186.5	G381-A	AD, HBP	BT124
7/8	16	4 1/4	108.0	7 3/8	187.3	G401	AD	B326
7/8	16	4 1/4	108.0	7 11/32	186.5	G381-A	AD	BT521
7/8	16	4 1/4	108.0	7 11/32	186.5	G381-A	PS	BF876
7/8	16	4 1/4	108.0	7 11/32	186.5	G381-A	PS	BF7911
15/16	16	3 11/16	93.7	4 23/32	119.9	ES24-B, G401	PSR	BF862
15/16	16	3 11/16	93.7	5 3/8	136.5	G381-A	PS	BF583
15/16	16	3 11/16	93.7	5 3/8	136.5	G381-A,	PSR	BF962
15/16	16	3 11/16	93.7	5 13/32	137.3	[1] Included		
15/16	16	3 11/16	93.7	5 13/32	137.3	ES24-B, G401	PSR	BF582
15/16	16	3 11/16	93.7	7 3/16	182.6	ES24-B, G401	PS, PSR	BF591
15/16	16	3 11/16	93.7	7 17/32	191.3	ES24-B, G401	D, PSR	BF597
15/16	16	4 1/4	108.0	8 17/32	216.7	G401	D, ISO	BF1211

SPIN-ON FEATURES

Some spin-ons have no additional features while others have several. Here are some of the more important spin-on features:

Anti-Drainback Valve



As the name implies, this valve keeps the oil from draining from a filter when the engine is shut off. (Some filters include an anti-drainback standpipe for the same function). The mounting direction determines the need for this feature.

By-Pass Valve



Full-flow oil systems require a by-pass (relief) valve either in the system or in the filter. This valve opens at a predetermined setting to assure oil flow to the bearings at all times.

Integral Post Seal



Seals threaded stud to prevent tiny particles from spiraling in via the threads.

We Cannot be Responsible for Misapplications



WARNING: These products can expose you to chemicals, including Diisononyl Phthalate, Carbon black extracts, Nickel, 1,3 Butadiene, Ethylene Oxide, Epichlorohydrin, which are known to the State of California to cause cancer, and Bisphenol-A, Ethylene Glycol, Ethylene Oxide, 1,3 Butadiene, Epichlorohydrin, which are known to the State of California to cause birth defects or other reproductive harm. For more information go to www.P65Warnings.ca.gov.

SPIN-ON FILTERS BY TAP SIZE (U.S. THREAD)

	THREAD I.D.	PER Inch	O.D. Inches	O.D. (mm)	LENGTH Inches	LENGTH (mm)	GASKET	FEATURES	BALDWIN NUMBER	
SPIN-ON FILTER FEATURES ARE CODED AS FOLLOWS	15/16	16	4 1/4	108.0	11 11/32	288.1	G401	D, ISO	BF1210	
	31/32	20	3 21/32	92.9	5 3/8	136.5	G381-A		B7395	
	31/32	20	3 21/32	92.9	5 5/8	142.9	G381-A		BT606-MPG	
	31/32	20	3 21/32	92.9	5 5/8	142.9	[1] Included	HBP	BT8440-MPG	
AD	Anti-Drainback Valve	1	12	2 13/16	71.4	8 7/32	209.0	[1] Included	BF46230	
		1	12	3	76.2	4 27/32	123.0	[1] Included	AD, HBP	B1435
ADP	Anti-Drainback Pipe	1	12	3 19/32	91.3	5 1/8	130.2	[1] Included	AD, SHBP	B7370
BP	8-10 PSID	1	12	3 19/32	91.3	5 5/8	142.9	[1] Included	AD, HBP	B7457
	By-Pass Valve	1	12	3 19/32	91.3	6 5/8	168.3	[1] Included	AD, HBP	B7387
		1	12	3 19/32	91.3	6 5/8	168.3	[1] Included	SHBP	B7461
BPI	By-Pass Included	1	12	3 19/32	91.3	8 1/8	206.4	[1] Included	AD, SHBP	B7367
BPS	By-Pass Screen	1	12	3 21/32	92.9	4 1/4	108.0	[1] Included		BT8918
		1	12	3 21/32	92.9	6 25/32	172.2	[1] Included	XHBP	BT8926
BTA PLUS		1	12	3 11/16	93.7	3 1/4	82.6	G381-A	BP	BT346
	Balanced Treatment	1	12	3 11/16	93.7	3 1/4	82.6	G381-A	LBP	BT357
	Additive Plus	1	12	3 11/16	93.7	3 1/4	82.6	G381-A	AD, SHBP	BT7220
		1	12	3 11/16	93.7	3 31/32	100.8		AD, HBP	B40070
BTE	Balanced Treatment for Ethylene Glycol Antifreeze	1	12	3 11/16	93.7	4 1/8	104.8	[3] Included	PS	BF1278-O
		1	12	3 11/16	93.7	4 11/32	110.3	[1] Included		BF592
		1	12	3 11/16	93.7	4 3/8	111.1	G381-A	SHBP	BT536
		1	12	3 11/16	93.7	4 3/8	111.1	[1] Included	ADP, BPI	B7274
D	Drain	1	12	3 11/16	93.7	4 3/8	111.1	G381-A		BF7968
		1	12	3 11/16	93.7	4 7/16	112.7	G401	AD, HBP	BT7424
FECV	Front-End Check Valve	1	12	3 11/16	93.7	5 11/32	135.7	[1] Included		BF7774
		1	12	3 11/16	93.7	5 3/8	136.5	G381-A	BP	BT274
		1	12	3 11/16	93.7	5 3/8	136.5	G381-A	AD, SHBP	BT292
FP	Fill Port	1	12	3 11/16	93.7	5 3/8	136.5	G381-A	HBP	BT364
HBP	18-25 PSID High Pressure By-Pass Valve	1	12	3 11/16	93.7	5 3/8	136.5	G381-A		BF955
		1	12	3 11/16	93.7	5 3/8	136.5	G381-A		BF956
		1	12	3 11/16	93.7	5 3/8	136.5	G381-A	AD, SHBP	BT7320
		1	12	3 11/16	93.7	5 3/8	136.5	G381-A		BT8445
ISO	Inside-Out Flow Direction	1	12	3 11/16	93.7	5 13/32	137.3	G401	HBP	BT452
		1	12	3 11/16	93.7	5 13/32	137.3	G401		BT839
LBP	2-7 PSID Low Pressure By-Pass Valve	1	12	3 11/16	93.7	5 13/32	137.3	G401		BT839-10
		1	12	3 11/16	93.7	5 13/32	137.3	G401		BT8420
		1	12	3 11/16	93.7	5 13/32	137.3	G401		BT8501-MPG
		1	12	3 11/16	93.7	5 13/32	137.3	G401		BT8502
MBP	11-17 PSID Medium Pressure By-Pass Valve	1	12	3 11/16	93.7	5 15/32	138.9	[1] Included	AD, HBP	B40120
		1	12	3 11/16	93.7	5 15/32	138.9	G401		B255
		1	12	3 11/16	93.7	5 15/32	138.9	G401		BT8428-MPG
		1	12	3 11/16	93.7	5 15/32	138.9	[1] Included		BT9465
		1	12	3 11/16	93.7	5 15/32	138.9	[1] Included	AD, XHBP	BT23611
MO	Metering Orifice	1	12	3 11/16	93.7	5 5/8	142.9	G381-A		BF7750
PS	Integral Post Seal Gasket	1	12	3 11/16	93.7	6 1/16	154.0	G401	SHBP	BT8415
		1	12	3 11/16	93.7	6 1/8	155.6	[1] Included	D	BF781
		1	12	3 11/16	93.7	6 5/32	156.4	ES24-D,	D, PSR	BF1266
PSR	Post Seal Required; Must install loose O-Ring or D-Ring on Post for Seal	1	12	3 11/16	93.7	6 7/32	158.0	[1] Included	D	BF1278
		1	12	3 11/16	93.7	6 5/8	168.3	G381-A	HBP	BT342
		1	12	3 11/16	93.7	6 5/8	168.3	G381-A	AD, SHBP	B7031
		1	12	3 11/16	93.7	6 5/8	168.3	G381-A	SHBP	B7089
		1	12	3 11/16	93.7	6 5/8	168.3	G381-A	HBP	B7215
RC	Reinforced Centertube	1	12	3 11/16	93.7	7 1/8	181.0	G381-A	AD, BP	B167
SHBP	30-45 PSID Super High Pressure By-Pass Valve	1	12	3 11/16	93.7	7 1/8	181.0	G381-A	AD, ADP	BT261
		1	12	3 11/16	93.7	7 1/8	181.0	G381-A		BF971
		1	12	3 11/16	93.7	7 1/8	181.0	G381-A	AD, BP	B975
		1	12	3 11/16	93.7	7 1/8	181.0	[1] Included	SHBP	BT40032
SP	Sensor Port	1	12	3 11/16	93.7	7 5/32	181.8	G401	AD, ADP	B299
XHBP	50+ PSID Extra High Pressure By-Pass Valve	1	12	3 11/16	93.7	7 3/16	182.6	G401		BT365
		1	12	3 11/16	93.7	7 3/16	182.6	G401		BT365-10
		1	12	3 11/16	93.7	7 3/16	182.6	G401		BF7606
		1	12	3 11/16	93.7	7 13/32	188.1	G401		BT8900
		1	12	3 11/16	93.7	7 13/32	188.1	[1] Included	D	BF1213
		1	12	3 11/16	93.7	7 7/16	188.9	[1] Included	D	BF7759
		1	12	3 11/16	93.7	8	203.2	G381-A	D	BF915
		1	12	3 11/16	93.7	8	203.2	[1] Included		BF5800
		1	12	3 11/16	93.7	8 1/8	206.4	G381-A	AD, SHBP	B236
		1	12	3 11/16	93.7	8 1/8	206.4	G381-A	AD, XHBP	B403

Do NOT Interchange Filters with Different Features



WARNING: These products can expose you to chemicals, including Diisononyl Phthalate, Carbon black extracts, Nickel, 1,3 Butadiene, Ethylene Oxide, Epichlorohydrin, which are known to the State of California to cause cancer, and Bisphenol-A, Ethylene Glycol, Ethylene Oxide, 1,3 Butadiene, Epichlorohydrin, which are known to the State of California to cause birth defects or other reproductive harm. For more information go to www.P65Warnings.ca.gov.

SPIN-ON FILTERS BY TAP SIZE (U.S. THREAD)

THREAD I.D.	PER Inch	O.D. Inches	O.D. (mm)	LENGTH Inches	LENGTH (mm)	GASKET	FEATURES	BALDWIN NUMBER
1	12	3 11/16	93.7	8 1/8	206.4	G381-A	XHBP	BT7143
1	12	3 11/16	93.7	8 1/8	206.4	G381-A	AD, FECV, XHBP	BT1770
1	12	3 11/16	93.7	8 23/32	221.5	G381-A	SHBP	B262
1	12	3 11/16	93.7	8 23/32	221.5	G381-A	FECV, SHBP	BT778
1	12	3 11/16	93.7	8 23/32	221.5	[1] Included		BF9913
1	12	3 11/16	93.7	8 25/32	223.0	G381-A		BT8903
1	12	3 11/16	93.7	8 13/16	223.8	[1] Included	D	BF5813
1	12	3 23/32	94.5	3 5/16	84.1	G401	AD, SHBP	BT9456
1	12	3 23/32	94.5	5 21/32	143.7	G401	PS	BF7987
1	12	3 23/32	94.5	5 21/32	143.7	G401	PS	BF7988
1	12	3 23/32	94.5	6 23/32	170.7	G401	AD	BT7044
1	12	3 23/32	94.5	6 23/32	170.7	G401	SHBP	BT8512
1	12	3 23/32	94.5	7 7/32	183.4	G401		BT8347
1	12	3 23/32	94.5	8 1/8	206.4	[1] Included		BT8497-MPG
1	12	3 23/32	94.5	8 3/16	208.0	G401		BT8443
1	12	3 23/32	94.5	8 3/16	208.0	[1] Included		BT8444
1	12	3 23/32	94.5	8 7/32	208.8	G401	SHBP	BT735
1	12	3 23/32	94.5	8 9/32	210.3		SHBP	B9601
1	12	3 23/32	94.5	8 7/8	225.4	G401	SHBP	BT739
1	12	3 25/32	96.0	3 1/4	82.6	[2] Included		BF46017-O
1	12	3 25/32	96.0	4 1/32	102.4	[3] Included		BF7968-O
1	12	3 25/32	96.0	4 27/32	123.0	[1] Included	AD, SHBP	BT9553
1	12	3 13/16	96.8	3 13/16	96.8	[1] Included	AD, HBP	BT9561
1	12	4 1/32	102.4	11	279.4	[1] Included	D	BF46071
1	12	4 7/32	107.2	5 1/8	130.2	[1] Included	AD, ADP, PS	BD142
1	12	4 1/4	108.0	4 1/32	102.4	[1] Included	AD, SHBP	BT131
1	12	4 1/4	108.0	4 13/32	111.9	[1] Included	HBP	BT7385
1	12	4 1/4	108.0	4 13/32	111.9	[1] Included	HBP	BT7386
1	12	4 1/4	108.0	4 11/16	119.1	G381-A	AD, HBP	B447
1	12	4 1/4	108.0	4 3/4	120.7	[1] Included	AD, SHBP	BT7373
1	12	4 1/4	108.0	5 13/16	147.6	[1] Included	MBP	BT130
1	12	4 1/4	108.0	5 27/32	148.4	[1] Included	AD, MBP	BT7144
1	12	4 1/4	108.0	5 7/8	149.2	G401	HBP	BT355
1	12	4 1/4	108.0	5 7/8	149.2	G401	BP	BT7009
1	12	4 1/4	108.0	7 3/8	187.3	G401		BT129
1	12	4 1/4	108.0	7 3/8	187.3	G401	HBP	BT157
1	12	4 1/4	108.0	7 3/8	187.3	G401		B309
1	12	4 1/4	108.0	9 1/8	231.8	G401		B263
1	12	4 1/4	108.0	9 1/8	231.8	G401	AD, HBP	BT349
1	12	4 1/4	108.0	9 1/8	231.8	G401	SHBP	BT7151
1	12	4 1/4	108.0	9 3/16	233.4	G401	AD, ADP, SHBP	BT8302
1	12	4 1/4	108.0	11 11/16	296.9	[1] Included	D, PS, SP	BF1353-SPS
1	12	4 9/32	108.7	11 7/32	285.0	[1] Included	D, PS, SP	BF1285-SP
						[1] O-Ring		
1	12	4 11/32	110.3	8 1/2	215.9	[2] Included		BF46101-O
1	12	4 17/32	115.3	6 9/16	166.9			BF46109-O
1	12	4 17/32	115.3	7 5/32	181.9			BF46123-O
1	12	3 3/4	95.3	7 13/32	188.1	[3] Included		BF5813-O
		UNF-2B						
1	12	4 1/4	108.0	5 13/16	147.6	[1] Attached	AD, MBP	B40054
		UNS-2B						
1	14	3 1/32	77.0	7 1/8	181.0	G449-B		BF7637
1	14	3 19/32	91.3	7 7/8	200.0	[1] Included	D, PS	BF9831
1	14	3 5/8	92.2	7 13/32	188.2	[3] Included		BF7798-O
1	14	3 21/32	92.7	4 1/32	102.4	[1] Included		BF7806-O
						[1] O-Ring		
1	14	3 21/32	92.9	4 1/8	104.8	[1] Included	PS	BF9922-O
						[1] I. Gasket		
1	14	3 21/32	92.9	4 19/32	116.7	[3] Included		BF1282-O
1	14	3 21/32	92.9	5 5/8	142.9	[2] Included	PS	BF1366-O
1	14	3 21/32	92.9	5 5/8	142.9	[2] Included	ISO, PS	BF1398-O
1	14	3 21/32	92.9	6 5/8	168.3	[3] Included	PS	BF1249-O
1	14	3 21/32	92.9	8 3/8	212.7	[2] Included	SP, D, PSR	BF46065-SPS
		UNS-B						
1	14	3 11/16	93.7	3 13/16	96.8	G381-A		BT8499
1	14	3 11/16	93.7	4 1/32	102.4	[2] Included		BF46022-O
1	14	3 11/16	93.7	4 1/16	103.2	[2] Included		BF46021-O
1	14	3 11/16	93.7	4 3/8	111.1	ES24-D, G381-A	PSR	BF948
1	14	3 11/16	93.7	4 11/16	119.1	G381-A	D, PSR	BF948-JD
1	14	3 11/16	93.7	5 7/32	132.6	[1] Included	D, ISO	BF1253

CAUTION!!!
Read These Instructions Before Using Size Charts

The filter size charts on this and following pages are for filter experts. Careless use could lead to errors. When you have exhausted all other ways to determine a filter number, locate a suspect here, then check the Product Guide for confirmation.

Size alone does not assure you of the right filtering media, gasket or other features. What is being filtered, filter efficiency, flow rate and direction of flow all have to be considered.

Spin-on filters are listed by tap size rather than length. All other filters are listed on an overall basis. Check your Product Guide for other dimensions. Progression is from the smallest to the largest in each category.

Do NOT Interchange Filters with Different Features

Be Sure to Check Product Guide, Cross-References and Applications

We Cannot be Responsible for Misapplications



WARNING: These products can expose you to chemicals, including Diisononyl Phthalate, Carbon black extracts, Nickel, 1,3 Butadiene, Ethylene Oxide, Epichlorohydrin, which are known to the State of California to cause cancer, and Bisphenol-A, Ethylene Glycol, Ethylene Oxide, 1,3 Butadiene, Epichlorohydrin, which are known to the State of California to cause birth defects or other reproductive harm. For more information go to www.P65Warnings.ca.gov.

SPIN-ON FILTERS BY TAP SIZE (U.S. THREAD)

A TYPICAL SPIN-ON

Spin-ons vary in size, media, fittings and other features. Let's look at the usual components.

Spin-on Can



No housing to clean; faster to change.

Baseplate and Seaming Cover Assembly



Size of mounting hole and gasket location determine if filter will seal. The baseplate is attached to the seaming cover and the seaming cover is attached to the can. (The gasket fits in the seaming cover.)

Compression Spring



Holds element in place to maintain seal.

Element End Caps



Closed End

Open End

End caps are bonded to the media.

Filtering Media



Micro-lite® pleated paper comes in more than 60 types for exact filtering requirements.

Centertube



Media is wrapped around the spiral perforated/louvered steel tube.

THREAD I.D.	PER Inch	O.D. Inches	O.D. (mm)	LENGTH Inches	LENGTH (mm)	GASKET	FEATURES	BALDWIN NUMBER
1	14	3 11/16	93.7	5 5/16	134.9	G381-A	PS	BF984
1	14	3 11/16	93.7	5 11/32	135.7	[1] Included		BF585
1	14	3 11/16	93.7	5 7/16	138.1	ES24-D, G381-A	PSR	BF957
1	14	3 11/16	93.7	5 7/16	138.1	ES24-D, G381-A	D, PSR	BF957-D
1	14	3 11/16	93.7	5 5/8	142.9	ES3028, G381-A	D, PS, PSR	BF1248
1	14	3 11/16	93.7	5 11/16	144.5	G381-A	D, PS	BF891
1	14	3 11/16	93.7	5 11/16	144.5	G401, [1] Included		BF7760
1	14	3 11/16	93.7	6 1/16	154.0	[1] Included	D, ISO, PS	BF1204
1	14	3 11/16	93.7	6 1/16	154.0	[2] Included	D, ISO, PS, SP	BF1204-SP
1	14	3 11/16	93.7	6 1/16	154.0	[1] Included	D, ISO, PS	BF1205
1	14	3 11/16	93.7	6 1/16	154.0	[2] Included	D, ISO, PS, SP	BF1205-SP
1	14	3 11/16	93.7	6 1/16	154.0	[1] Included,	D, PSR, SP	BF1270-SP
						[1] O-Ring		
1	14	3 11/16	93.7	6 5/32	156.4	ES24-D, G381-A	D, PSR	BF1282
1	14	3 11/16	93.7	6 3/16	157.2	ES24-D, G381-A	D, PS, PSR	BF1220
1	14	3 11/16	93.7	6 7/32	158.0	[1] Included	D, FECV	BF7806
1	14	3 11/16	93.7	6 11/16	169.9	G401	PS	BF7529
1	14	3 11/16	93.7	6 11/16	169.9	G401	PS	BF7923
1	14	3 11/16	93.7	6 31/32	177.0	ES24-D, G401	D, PS, PSR	BF7546
1	14	3 11/16	93.7	7 1/8	181.0	G381-A	PS	BF970
1	14	3 11/16	93.7	7 1/8	181.0	G381-A	PS	BF991
1	14	3 11/16	93.7	7 3/8	187.3	G381-A	D, PS	BF1225
1	14	3 11/16	93.7	7 3/8	187.3	G381-A	D, PS	BF1268
1	14	3 11/16	93.7	7 3/8	187.3	G381-A	D, SP	BF1385-SPS
						[1] Included		
1	14	3 11/16	93.7	7 1/8	181.0	ES24-D, G381-A	PSR	BF7557
1	14	3 11/16	93.7	7 1/8	181.0	G381-A	PS	BF7633
1	14	3 11/16	93.7	7 13/32	188.1	G381-A	D, PS	BF1214
1	14	3 11/16	93.7	7 13/32	188.1	ES24-D, G381-A	D, PSR	BF1252
1	14	3 11/16	93.7	7 13/32	188.1	G381-A	D	BF1376
						[1] O-Ring		
1	14	3 11/16	93.7	7 7/16	188.9	ES24-D, G381-A	D, PSR	BF1212
1	14	3 11/16	93.7	7 7/16	188.9	ES24-D, G381-A	D, PSR	BF1258
1	14	3 11/16	93.7	7 13/16	198.4	[1] Included,		
						[1] O-Ring	D, PSR, SP	BF1350-SP
1	14	3 11/16	93.7	7 13/16	198.4	[1] Included,		
						[1] O-Ring	D, PSR, SP	BF1384-SP
1	14	3 11/16	93.7	7 31/32	202.7			BF46143
1	14	3 11/16	93.7	8 1/32	204.0	ES24-D, G381-A	PSR	BF5801
1	14	3 11/16	93.7	8 23/32	221.5	G381-A	PS	BF978
1	14	3 11/16	93.7	8 23/32	221.5	G381-A	PS	BF979
1	14	3 11/16	93.7	8 23/32	221.5	ES24-D, G381-A	PSR	BF7558
1	14	3 11/16	93.7	8 25/32	223.0	G401	PS	BF577
1	14	3 11/16	93.7	8 13/16	223.8	G381-A	D, PS, PSR, SP	BF1393-SP
						[2] Included		
1	14	3 11/16	93.7	8 27/32	224.6	ES24-D, G381-A	D, PSR	BF5812
1	14	3 11/16	93.7	8 7/8	225.4	G401	D, SP	BF1394-SP
1	14	3 11/16	93.7	8 29/32	226.2	ES24-D, G381-A	D, PSR	BF1249
1	14	3 11/16	93.7	8 29/32	226.2	ES24-D, G381-A	D, PSR, SP	BF1249-SP
1	14	3 11/16	93.7	9 1/32	229.4	G381-A	D, PS	BF892
1	14	3 11/16	93.7	9 15/32	240.5	ES24-D, G381-A	D, PSR, SP	BF1272-SPS
1	14	3 11/16	93.7	9 17/32	242.1	ES24-D, G381-A	D, PSR	BF1259
1	14	3 11/16	93.7	9 17/32	242.1	G401,	PSR, SP	BF7798-SP
						[1] Included,		
						[1] O-Ring		
1	14	3 11/16	93.7	10 1/32	254.8	G381-A	ADP, D, SP, SPR	BF1293-SPS
1	14	3 11/16	93.7	10 1/2	266.7	G381-A	PS	BF614
1	14	3 11/16	93.7	10 1/2	266.7	G381-A		BF7587
1	14	3 11/16	93.7	10 1/2	266.7	[1] Included		BF7753
1	14	3 23/32	94.2	5 23/32	145.5			BF46175
1	14	3 23/32	94.5	7 15/16	201.6	G381-A	D	BF1279
						[1] O-Ring		
1	14	3 23/32	94.5	8 1/8	206.4	G401	SHBP	B7357
1	14	3 23/32	94.5	8 7/32	208.8	G401		BF9927
1	14	3 23/32	94.5	10 1/32	254.8	G381-A, ES24-D	D, PSR, SP	BF1378-SPS
1	14	3 5/16	95.1	3 15/16	83.6			BF46162-O
1	14	3 3/4	95.3	3 9/16	90.5	[2] Included		BF46023-O
1	14	3 3/4	95.3	3 9/16	90.5	[2] Included		BF46024-O
1	14	3 3/4	95.3	4 21/32	118.3	[2] Included		BF46026-O
1	14	3 3/4	95.3	4 11/16	119.1	[2] Included	PS	BF1204-O



WARNING: These products can expose you to chemicals, including Diisononyl Phthalate, Carbon black extracts, Nickel, 1,3 Butadiene, Ethylene Oxide, Epichlorohydrin, which are known to the State of California to cause cancer, and Bisphenol-A, Ethylene Glycol, Ethylene Oxide, 1,3 Butadiene, Epichlorohydrin, which are known to the State of California to cause birth defects or other reproductive harm. For more information go to www.P65Warnings.ca.gov.

SPIN-ON FILTERS BY TAP SIZE (U.S. THREAD)

THREAD I.D.	PER Inch	O.D. Inches	O.D. (mm)	LENGTH Inches	LENGTH (mm)	GASKET	FEATURES	BALDWIN NUMBER
1	14	3 3/4	95.3	5 17/32	140.5	[2] Included		BF46025-O
1	14	3 25/32	96.0	4 1/32	102.4	[2] Included	PS	BF46029-O
1	14	3 25/32	96.0	5 1/2	139.7	[3] Included		BF46030-O
1	14	3 13/16	96.8	3 9/32	83.3	[2] Included		BF46019-O
1	14	3 13/16	96.8	3 9/32	83.3	[1] Included,		
						[1] O-Ring		BF46020-O
1	14	4	101.6	4 1/16	103.2	[2] Included		BF46028-O
1	14	4 1/32	102.4	11	279.4	[1] Included	D	BF46072
1	14	4 5/32	105.6	6 5/16	160.3	[2] Included	PS	BF1292-O
1	14	4 7/32	106.9	5 1/32	127.5	[2] Included		BF46182-O
1	14	4 7/32	107.4	6 1/8	155.3	[2] Included		BF46169-O
1	14	4 1/4	108.0	3 15/32	88.1	[2] Included	PS	BF9912-O
1	14	4 1/4	108.0	3 17/32	89.7	[2] Included	PS	BF1389-O
1	14	4 1/4	108.0	4 1/8	104.8	[1] Included	PS	BF1222-O
1	14	4 1/4	108.0	5 3/32	129.4	[2] Included		BF46147-O
		UNS-2B						
1	14	4 1/4	108.0	5 1/8	130.2	[2] Included	PS	BF1388-O
1	14	4 1/4	108.0	5 3/16	131.8	[3] Included	PS	BF1348-O
1	14	4 1/4	108.0	5 3/16	131.8	[1] Included,	PS	BF1386-O
						[1] I. Gasket		
1	14	4 1/4	108.0	5 7/32	132.6	[2] Included	PS	BF1223-O
1	14	4 1/4	108.0	5 9/32	134.1	[1] Included,	PS	BF1345-O
						[1] O-Ring		
1	14	4 1/4	108.0	5 1/2	139.7	[2] Included		BF46031
1	14	4 1/4	108.0	5 21/32	143.5	[2] Included		BF46181-O
1	14	4 1/4	108.0	5 11/16	144.5	[1] Included	PS	BF9816
1	14	4 1/4	108.0	5 25/32	146.8	[1] Included		BF46085
1	14	4 1/4	108.0	5 29/32	150.0	[1] Included	PS	BF1224
1	14	4 1/4	108.0	6 1/8	155.6			BF46163-O
		UNS						
1	14	4 1/4	108.0	6 5/32	156.4	[2] Included	PS	BF1298-O
1	14	4 1/4	108.0	6 7/32	158.0	[2] Included	PS	BF46100-O
1	14	4 1/4	108.0	6 9/32	159.5	[2] Included	PS	BF46098-O
1	14	4 1/4	108.0	6 5/16	160.3	[2] Included	PS	BF1346-O
1	14	4 1/4	108.0	6 5/16	160.3	[2] Included	PS	BF1387-O
1	14	4 1/4	108.0	6 5/16	160.3	[2] Included	PS	BF9898-O
1	14	4 1/4	108.0	6 5/16	160.3	[2] Included		BF9925-O
1	14	4 1/4	108.0	6 13/32	162.7	[2] Included		BF1296-O
1	14	4 1/4	108.0	6 9/16	166.7	G401, [1] O-Ring	D, PS, PSR, SP	BF1273-SP
1	14	4 1/4	108.0	6 9/16	166.7	[1] Included	D, PS, SP	BF1345
1	14	4 1/4	108.0	6 9/16	166.7	[2] Included	D, PS, SP	BF1345-SP
1	14	4 1/4	108.0	6 25/32	172.2	[1] Included	D, PS	BF1223
1	14	4 1/4	108.0	6 25/32	172.2	[2] Included	D, PS, SP	BF1223-SP
1	14	4 1/4	108.0	6 25/32	172.2	G401	D, PS	BF1240
1	14	4 1/4	108.0	6 13/16	173.0	[1] Included	D	BF1362
1	14	4 1/4	108.0	7 5/32	181.8	[2] Included	PS	BF1294-O
1	14	4 1/4	108.0	7 15/32	189.7	[1] Included,	ADP, D, PSR, SP	BF9811-SP
						[1] O-Ring		
1	14	4 1/4	108.0	7 5/8	193.7	[3] Included	ADP, PSR, SP	BF1399-SP
1	14	4 1/4	108.0	7 5/8	194.1			BF46134-O
1	14	4 1/4	108.0	7 13/16	198.4	[2] Included	PS	BF1299-O
1	14	4 1/4	108.0	7 29/32	200.8	[1] Included	FP, PS	BF880-FP
1	14	4 1/4	108.0	8 9/32	210.3	[1] Included	D, PS	BF1346
1	14	4 1/4	108.0	8 9/32	210.3	[1] Included,	D, PSR, SP	BF1346-SP
						[1] O-Ring		
1	14	4 1/4	108.0	8 9/32	210.3	[1] Included	D, PS	BF1347
1	14	4 1/4	108.0	8 17/32	216.7	[2] Included		BF46018-O
1	14	4 1/4	108.0	8 19/32	218.3	[2] Included	PS	BF46099-O
1	14	4 1/4	108.0	8 21/32	219.9	[1] Included	PS	BF1391-O
1	14	4 1/4	108.0	8 21/32	219.9	[2] Included,	PS	BF9921-O
						[1] I. Gasket		
1	14	4 1/4	108.0	9 7/32	234.2	[1] Included,	D, SP	BF1374-SP
						[1] O-Ring		
1	14	4 1/4	108.0	9 7/32	234.2	[3] Included	ADP, D, SP	BF9903-SP
1	14	4 1/4	108.0	9 11/32	237.3	[1] Included	ADP, PSR, SP	BF1397-SP
1	14	4 1/4	108.0	9 3/8	238.1	[1] Included,	D, PSR, SP	BF1382-SP
						[1] O-Ring		
1	14	4 1/4	108.0	9 31/32	253.2	[1] Included	D	BF1377
1	14	4 1/4	108.0	10 7/16	265.1	G381-A	PS	BF584
1	14	4 1/4	108.0	10 7/16	265.1	G381-A	PS	BF584-B

SPIN-ON FEATURES

Some spin-ons have no additional features while others have several. Here are some of the more important spin-on features:

Anti-Drainback Valve



As the name implies, this valve keeps the oil from draining from a filter when the engine is shut off. (Some filters include an anti-drainback standpipe for the same function). The mounting direction determines the need for this feature.

By-Pass Valve



Full-flow oil systems require a by-pass (relief) valve either in the system or in the filter. This valve opens at a predetermined setting to assure oil flow to the bearings at all times.

Integral Post Seal



Seals threaded stud to prevent tiny particles from spiraling in via the threads.

We Cannot be Responsible for Misapplications



WARNING: These products can expose you to chemicals, including Diisononyl Phthalate, Carbon black extracts, Nickel, 1,3 Butadiene, Ethylene Oxide, Epichlorohydrin, which are known to the State of California to cause cancer, and Bisphenol-A, Ethylene Glycol, Ethylene Oxide, 1,3 Butadiene, Epichlorohydrin, which are known to the State of California to cause birth defects or other reproductive harm. For more information go to www.P65Warnings.ca.gov.

SPIN-ON FILTERS BY TAP SIZE (U.S. THREAD)

	THREAD I.D.	PER Inch	O.D. Inches	O.D. (mm)	LENGTH Inches	LENGTH (mm)	GASKET	FEATURES	BALDWIN NUMBER
SPIN-ON FILTER FEATURES ARE CODED AS FOLLOWS	1	14	4 1/4	108.0	10 19/32	269.0			BF46073
	1	14	4 1/4	108.0	11 1/8	282.6		[1] Included,	
	1	14	4 1/4	108.0	11 7/32	285.0		[1] O-RingD, PS, SP	BF1359-SP
	1	14	4 1/4	108.0	11 5/16	287.3		[1] IncludedD	BF1363
	1	14	4 1/4	108.0	11 11/16	296.9	G401D, PS	BF1218
	1	14	4 9/32	108.7	5 1/4	133.4		[1] IncludedD, PS, SP	BF1354-SPS
	1	14	4 9/32	108.7	5 1/4	133.4		[1] IncludedD, PS	BF1222
	1	14	4 9/32	108.7	5 21/32	143.7		[2] IncludedD, PS, SP	BF1222-SP
	1	14	4 9/32	108.7	7 1/8	181.0		[2] IncludedD	BF1360-O
	1	14	4 9/32	108.7	8 1/32	204.0		[1] IncludedD	BF9869
AD Anti-Drainback Valve	1	14	4 9/32	108.7	8 1/8	206.4		[1] IncludedD, PS	BF1329
ADP Anti-Drainback Pipe	1	14	4 9/32	108.7	8 1/8	206.4		[2] IncludedD, PS, SP	BF1329-SP
BP 8-10 PSID By-Pass Valve	1	14	4 9/32	108.7	8 1/8	206.4		[1] Included,D, PS, PSR, SP	BF1330-SP
BPI By-Pass Included	1	14	4 9/32	108.7	8 1/8	206.4		[1] O-Ring	
BPS By-Pass Screen	1	14	4 9/32	108.7	8 1/8	206.4		[1] Included,D, PS, PSR, SP	BF1339-SP
BTA PLUS	1	14	4 9/32	108.7	8 1/8	206.4		[1] O-Ring	
Balanced Treatment Additive Plus	1	14	4 9/32	108.7	8 1/8	206.4		[2] IncludedD, PS, PSR, SP	BF1360-SP
BTE Balanced Treatment for Ethylene Glycol Antifreeze	1	14	4 9/32	108.7	8 1/8	206.4		[1] Included;D, PS, SP	BF1373-SP
D Drain	1	14	4 9/32	108.7	8 7/32	208.8		[1] O-Ring	
FECV Front-End Check Valve	1	14	4 9/32	108.7	8 7/32	208.8		[1] IncludedD, PS	BF1349
FP Fill Port	1	14	4 9/32	108.7	9 3/32	231.0		[1] IncludedD, PS	BF1360
HBP 18-25 PSID High Pressure By-Pass Valve	1	14	4 9/32	108.7	9 3/32	231.0		[2] IncludedPS	BF1297-O
ISO Inside-Out Flow Direction	1	14	4 9/32	108.7	9 31/32	253.2		[2] IncludedD, PS	BF1383-O
LBP 2-7 PSID Low Pressure By-Pass Valve	1	14	4 9/32	108.7	10 25/32	273.8		[1] IncludedD, PS	BF1375
MBP 11-17 PSID Medium Pressure By-Pass Valve	1	14	4 9/32	108.7	11	279.4		[1] IncludedD	BF9818
MO Metering Orifice	1	14	4 9/32	108.7	11 7/32	285.0		[1] Included,D, PS, SP	BF1358-SP
PS Integral Post Seal Gasket	1	14	4 9/32	108.7	11 7/32	285.0		[1] O-Ring	
PSR Post Seal Required; Must install loose O-Ring or D-Ring on Post for Seal	1	14	4 9/32	108.7	11 7/32	285.0		[1] IncludedD, PS	BF1283
RC Reinforced Centertube	1	14	4 9/32	108.7	11 7/32	285.0	G579,D, PS, PSR, SP	BF1395-SP
SHBP 30-45 PSID Super High Pressure By-Pass Valve	1	14	4 9/32	108.7	11 5/16	287.3		[1] Included	
SP Sensor Port	1	14	4 9/32	108.7	11 5/16	287.3		[1] IncludedD, PS	BF1265
XHBP 50+ PSID Extra High Pressure By-Pass Valve	1	14	4 9/32	108.7	11 5/16	287.3		[1] IncludedD, PS	BF1281
	1	14	4 9/32	108.7	11 5/16	287.3		[1] Included,D, PS, PSR, SP	BF1283-SP
	1	14	4 5/16	109.5	5 29/32	150.0		[1] O-Ring	
	1	14	4 5/16	109.5	6 5/16	160.3		[1] IncludedPS	BF7628
	1	14	4 5/16	109.5	6 25/32	172.2		[2] IncludedPS	BF9871-O
	1	14	4 5/16	109.5	6 25/32	172.2		[1] IncludedD, PS	BF1231
	1	14	4 5/16	109.5	6 25/32	172.2		[1] IncludedD, PS	BF1348
	1	14	4 5/16	109.5	6 25/32	172.2		[2] IncludedD, PS, SP	BF1348-SP
	1	14	4 5/16	109.5	6 25/32	172.2		[1] IncludedD, PS	BF1370
	1	14	4 11/32	110.3	6 1/8	155.6		[2] IncludedPS	BF46016-O
	1	14	4 11/32	110.3	6 3/16	157.2		[2] IncludedPS	BF1390-O
	1	14	4 11/32	110.3	8 1/2	215.9		[2] IncludedPS	BF46105-O
	1	14	4 11/32	110.3	9 1/4	235.0		[1] IncludedPS	BF9917
	1	14	4 11/32	110.3	9 11/16	246.1		[2] IncludedPS	BF9880
	1	14	4 3/8	111.1	3 1/2	88.9		[2] IncludedPS	BF46027-O
	1	14	4 3/8	111.1	6 7/32	158.0		[2] IncludedPS	BF1347-O
	1	14	4 13/32	111.9	7 1/4	184.2		[1] IncludedD	BF46122
	1	14	4 13/32	111.9	8 19/32	218.3		[1] Included,PS	BF1281-O
	1	14	4 13/32	111.9	8 19/32	218.3		[2] 1. Gaskets	
	1	14	4 13/32	111.9	8 19/32	218.3		[1] Included,PS	BF1283-O
	1	14	4 13/32	111.9	8 19/32	218.3		[2] 1. Gaskets	
	1	14	4 13/32	111.9	8 19/32	218.3		[2] IncludedPS	BF1358-O
	1	14	4 13/32	111.9	8 19/32	218.3		[3] IncludedPS	BF1395-O
	1	14	4 13/32	111.9	8 21/32	219.9		[2] IncludedPS	BF9867-O
	1	14	4 1/2	114.3	6 3/16	157.2		[2] IncludedPS	BF46083-O
	1	16	3 11/16	93.7	5 3/8	136.5	G381-AAD, MBP	B7014
	1	16	3 11/16	93.7	5 3/8	136.5	G381-AAD	B7117
	1	16	3 11/16	93.7	5 3/8	136.5	G381-AAD	B7351-MPG
	1	16	3 11/16	93.7	5 3/8	136.5	G381-AAD	B7420
	1	16	3 11/16	93.7	5 3/8	136.5	G381-AAD	B7440
	1	16	3 11/16	93.7	5 3/8	136.5		[1] Included	BT427
	1	16	3 11/16	93.7	6 7/16	163.5	G381-AAD, HBP	B7379
	1	16	3 11/16	93.7	6 9/16	166.7	G381-ASHBP	B7362
	1	16	3 11/16	93.7	7 1/8	181.0	G381-AAD	B7181
	1	16	3 11/16	93.7	7 1/8	181.0		[1] IncludedVenturi-Type Cone	BD7317
	1	16	3 11/16	93.7	7 1/8	181.0	G381-AAD	BT339

Do NOT Interchange Filters with Different Features



WARNING: These products can expose you to chemicals, including Diisononyl Phthalate, Carbon black extracts, Nickel, 1,3 Butadiene, Ethylene Oxide, Epichlorohydrin, which are known to the State of California to cause cancer, and Bisphenol-A, Ethylene Glycol, Ethylene Oxide, 1,3 Butadiene, Epichlorohydrin, which are known to the State of California to cause birth defects or other reproductive harm. For more information go to www.P65Warnings.ca.gov.

SPIN-ON FILTERS BY TAP SIZE (U.S. THREAD)

THREAD I.D.	PER Inch	O.D. Inches	O.D. (mm)	LENGTH Inches	LENGTH (mm)	GASKET	FEATURES	BALDWIN NUMBER
1	16	3 11/16	93.7	7 1/8	181.0	G381-A		BT7349
1	16	3 11/16	93.7	7 5/32	181.8	G381-A	AD	B7372
1	16	4 1/4	108.0	5 13/16	147.6	G381-A		BT564
1	16	4 1/4	108.0	5 13/16	147.6	[1] Included		B5177
1	16	4 1/4	108.0	5 13/16	147.6	[1] Included	BTE	BW5179
1	16	4 1/4	108.0	7 11/32	186.5	G381-A		BT440
1	16	4 9/32	108.7	8 3/4	222.3	[1] Included	HBP	B7506
1 1/16	16	4 1/4	108.0	10 7/16	265.1	[1] Included	PS	BF976
1 1/16	16	4 21/32	118.3	9 1/2	241.3	[1] Included	PS	BF785
1 1/16	16	4 21/32	118.3	9 1/2	241.3	[1] Included	PS	BF7697
1 1/8	12	3 11/16	93.7	7 1/8	181.0	[1] Included		B7375
1 1/8	16	3 23/32	94.2	5 3/8	136.4			BT23617
1 1/8	16	3 5/8	92.1	7 1/8	181.0	[1] Included		B7497
1 1/8	16	3 11/16	93.7	3 7/32	81.8			BT367-S
1 1/8	16	3 11/16	93.7	4 5/16	109.5		PS	B7024
1 1/8	16	3 11/16	93.7	4 11/32	110.3			BT367
1 1/8	16	3 11/16	93.7	5 3/8	136.5	G381-A		BT230
1 1/8	16	3 11/16	93.7	5 3/8	136.5	G381-A		BT260
1 1/8	16	3 11/16	93.7	5 3/8	136.5	G381-A		BT260-10
1 1/8	16	3 11/16	93.7	5 3/8	136.5	G381-A		BT334
1 1/8	16	3 11/16	93.7	5 3/8	136.5	G381-A	BP	BT354
1 1/8	16	3 11/16	93.7	5 3/8	136.5	G381-A		BT9442-MPG
1 1/8	16	3 11/16	93.7	5 5/8	142.9	G381-A		BT8314
1 1/8	16	3 11/16	93.7	5 21/32	143.7	G401		BT8391
1 1/8	16	3 11/16	93.7	5 21/32	143.7	G381-A		BT8505
1 1/8	16	3 11/16	93.7	5 21/32	143.7	G381-A		BT8898
1 1/8	16	3 11/16	93.7	5 7/8	149.2	G381-A		BT9382
1 1/8	16	3 11/16	93.7	6 5/8	168.3	G381-A	HBP	BT8357
1 1/8	16	3 11/16	93.7	6 5/8	168.3	G381-A	BP	BT8504
1 1/8	16	3 11/16	93.7	7 1/8	181.0	G381-A		BT305
1 1/8	16	3 11/16	93.7	7 3/16	182.6	G401		BT595
1 1/8	16	3 11/16	93.7	7 3/16	182.6	G401		BT177
1 1/8	16	3 11/16	93.7	8 3/16	208.0	G401	MBP	BT8393
1 1/8	16	3 11/16	93.7	9 13/16	249.2	[2] Included	D	BF46015
1 1/8	16	3 23/32	94.5	6 13/16	173.0	[1] Included		BT9321
1 1/8	16	3 23/32	94.5	7 1/32	178.6	[1] Included		BT8488
1 1/8	16	3 25/32	96.0	6 15/32	164.3	[1] Included	RC	BT9358
1 1/8	16	4 1/4	108.0	5 27/32	148.4	[1] Included		B75
1 1/8	16	4 1/4	108.0	5 27/32	148.4	[1] Included		B605
1 1/8	16	4 1/4	108.0	5 27/32	148.4	[1] Included	AD, ADP, SHBP	B7051
1 1/8	16	4 1/4	108.0	5 27/32	148.4	[1] Included	SHBP	B7223
1 1/8	16	4 1/4	108.0	7 11/32	186.5	[1] Included	AD, SHBP	B7113
1 1/8	16	4 1/4	108.0	7 3/8	187.3	[1] Included		BT470
1 1/8	16	4 1/4	108.0	7 3/8	187.3	[1] Included		B7227
1 1/8	16	4 1/4	108.0	7 3/8	187.3	[1] Included		B7397
1 1/8	16	4 1/4	108.0	9 1/8	231.8	[1] Included		BT398
1 1/8	16	4 1/4	108.0	9 1/8	231.8	[1] Included	SHBP	BT402
1 1/8	16	4 1/4	108.0	10 1/16	255.6	[1] Included		B76
1 1/8	16	4 1/4	108.0	10 1/16	255.6	[1] Included		B76-MPG
1 1/8	16	4 1/4	108.0	10 1/16	255.6	[1] Included		B76-SS
1 1/8	16	4 1/4	108.0	10 1/16	255.6	[1] Included	SHBP	B7501
1 1/8	16	4 1/4	108.0	10 1/16	255.6	[1] Included		B7700
1 1/8	16	4 1/4	108.0	10 7/16	265.1	[1] Included	AD, SHBP	B218
1 1/8	16	4 1/4	108.0	10 7/16	265.1	[1] Included		BT340
1 1/8	16	4 1/4	108.0	10 7/16	265.1	[1] Included		BT556-10
1 1/8	16	4 1/4	108.0	10 7/16	265.1	[1] Included	AD, ADP, SHBP	B7191
1 1/8	16	4 1/4	108.0	10 7/16	265.1	[1] Included		B7225
1 1/8	16	4 1/4	108.0	10 15/32	265.9	[1] Included		B9604
1 1/8	16	4 9/32	108.7	6 7/32	158.0	[1] Included	SHBP	B7483
1 1/8	16	4 9/32	108.7	8 1/32	204.0	[1] Included		BT234
1 1/8	16	4 5/16	109.5	9 5/32	232.6	[1] Included		B45
1 1/8	16	4 11/32	110.3	10 1/4	260.3	[1] Included	SHBP	B7459
1 1/8	16	4 3/8	111.1	8 11/32	211.9	[1] Included	BPI	B7468
1 1/8	16	4 1/2	114.3	7 5/16	185.7	[1] Included		B9606
UN-2B								
1 1/8	16	5 3/8	136.5	6 1/32	153.2	[1] Included	AD, HBP	BT343
1 1/4	12	4 27/32	122.9	9 29/32	251.5	[2] Included		BF46150-0

CAUTION!!! Read These Instructions Before Using Size Charts

The filter size charts on this and following pages are for filter experts. Careless use could lead to errors. When you have exhausted all other ways to determine a filter number, locate a suspect here, then check the Product Guide for confirmation.

Size alone does not assure you of the right filtering media, gasket or other features. What is being filtered, filter efficiency, flow rate and direction of flow all have to be considered.

Spin-on filters are listed by tap size rather than length. All other filters are listed on an overall basis. Check your Product Guide for other dimensions. Progression is from the smallest to the largest in each category.

Do NOT Interchange Filters with Different Features

Be Sure to Check Product Guide, Cross-References and Applications

We Cannot be Responsible for Misapplications



WARNING: These products can expose you to chemicals, including Diisononyl Phthalate, Carbon black extracts, Nickel, 1,3 Butadiene, Ethylene Oxide, Epichlorohydrin, which are known to the State of California to cause cancer, and Bisphenol-A, Ethylene Glycol, Ethylene Oxide, 1,3 Butadiene, Epichlorohydrin, which are known to the State of California to cause birth defects or other reproductive harm. For more information go to www.P65Warnings.ca.gov.

SPIN-ON FILTERS BY TAP SIZE (U.S. THREAD)

A TYPICAL SPIN-ON

Spin-ons vary in size, media, fittings and other features. Let's look at the usual components.

Spin-on Can



No housing to clean; faster to change.

Baseplate and Seaming Cover Assembly



Size of mounting hole and gasket location determine if filter will seal. The baseplate is attached to the seaming cover and the seaming cover is attached to the can. (The gasket fits in the seaming cover.)

Compression Spring



Holds element in place to maintain seal.

Element End Caps



Closed End

Open End

End caps are bonded to the media.

Filtering Media



Microlite® pleated paper comes in more than 60 types for exact filtering requirements.

Centertube



Media is wrapped around the spiral perforated/louvered steel tube.

THREAD I.D.	PER Inch	O.D. Inches	O.D. (mm)	LENGTH Inches	LENGTH (mm)	GASKET	FEATURES	BALDWIN NUMBER
1 1/4	12	3 11/16	93.7	5 3/8	136.5	G381-A		BT526
1 1/4	12	3 11/16	93.7	5 3/8	136.5	G381-A		BT526-10
1 1/4	12	3 11/16	93.7	5 3/8	136.5	G381-A	MBP	B7023
1 1/4	12	3 11/16	93.7	8 23/32	221.5	G381-A		B378
1 1/4	12	3 11/16	93.7	8 23/32	221.5	G381-A		B378-10
1 1/4	12	3 11/16	93.7	8 23/32	221.5	G381-A		BF9834
1 1/4	12	3 27/32	97.6	9 23/32	246.9	[2] Attached		BT23540
1 1/4	12	4 21/32	118.3	8 3/32	205.6	[1] Included	PS	BT443
1 1/4	12	4 21/32	118.3	9 1/2	241.3	[1] Included	PS	BF784
1 1/4	12	4 21/32	118.3	11 7/32	285.0	G498-A	PS	BF596
1 1/4	12	4 21/32	118.3	11 7/32	285.0	[1] Included	PS	BF7913
1 1/4	12	4 21/32	118.3	12 1/16	306.4	[1] Included	D, PS	BF1262
1 1/4	12	4 11/16	119.1	8 7/8	225.4	[1] Included	D, PS, PSR, SP	BF1355-SP
						[1] O-Ring		
1 1/4	12	4 11/16	119.1	8 29/32	226.2	[1] Included	D, PS	BF1355
1 1/4	12	4 11/16	119.1	12 3/32	307.2	[1] Included	D, PS	BF1216
1 1/4	12	4 11/16	119.1	12 3/32	307.2	[1] Included	D, PS	BF1357
1 1/4	12	4 27/32	122.7	6 9/32	159.7			BF46173-O
1 1/4	12	4 7/8	123.8	6 5/16	160.3	[2] Included	PS	BF1355-O
1 1/4	12	4 7/8	123.8	9 29/32	251.6	[3] Included	PS	BF1287-O
1 1/4	12	4 7/8	123.8	9 29/32	251.6	[2] Included	PS	BF1288-O
1 1/4	12	5 3/8	136.4	12 29/32	327.7			BF46251-SP
1 1/4	12	5 3/8	136.4	12 29/32	327.7			BF46252-SP
1 1/4	17	7 9/32	184.9	7 17/32	191.3	[2] Included		BA5373
1 5/16	12	3 7/8	98.4	5 25/32	146.8	[1] Included, G247		BT8449
1 5/16	12	3 7/8	98.4	5 25/32	146.8	[1] Included, G247		BT8449-10
1 5/16	12	4 5/8	117.5	10 9/32	261.1	[1] Included		BT359
1 3/8	12	3 11/16	93.7	7 7/16	188.9	[1] Included	D	BF958
1 3/8	12	3 11/16	93.7	8 3/4	222.0			BF46141
1 3/8	12	3 11/16	93.7	9 19/32	243.7	[1] Viton Included		BT9366-MPG
1 3/8	12	3 3/4	95.3	4 17/32	115.1	[1] Included		BT8416
1 3/8	12	3 3/4	95.3	4 25/32	121.4	[1] Included		BT9398-MPG
1 3/8	12	3 3/4	95.3	6 3/32	154.8	[1] Included		BT8841-MPG
1 3/8	12	3 3/4	95.3	6 3/32	154.8	[1] Included		BT8849-MPG
1 3/8	12	3 3/4	95.3	6 1/8	155.6	[1] Included		BT732
1 3/8	12	3 3/4	95.3	6 1/8	155.6	[1] Included		BT8463-MPG
1 3/8	12	3 3/4	95.3	6 1/8	155.6	[1] Included		BT8464
1 3/8	12	3 3/4	95.3	6 1/8	155.6	[1] Included		BT8840-MPG
1 3/8	12	3 3/4	95.3	6 1/8	155.6	[1] Included		BT8842-MPG
1 3/8	12	3 3/4	95.3	6 1/8	155.6	[1] Included		BT8844
1 3/8	12	3 3/4	95.3	6 1/8	155.6	[1] Included		BT8845
1 3/8	12	3 3/4	95.3	6 1/8	155.6	[1] Included		BT8846
1 3/8	12	3 3/4	95.3	6 1/8	155.6	[1] Included		BT8847
1 3/8	12	3 3/4	95.3	6 1/8	155.6	[1] Included	XHBP	BT9364
1 3/8	12	3 3/4	95.3	6 1/8	155.6	[1] Included		BT9436-MPG
1 3/8	12	3 3/4	95.3	6 11/32	161.1	[1] Included		BT8904-MPG
1 3/8	12	3 3/4	95.3	8 1/32	204.0	[1] Included		BT8848-MPG
1 3/8	12	3 3/4	95.3	8 1/32	204.0			BT23619-MPG
1 3/8	12	3 3/4	95.3	9 17/32	242.1	[1] Included		BT8850-MPG
1 3/8	12	3 3/4	95.3	9 17/32	242.1	[1] Included		BT8853-MPG
1 3/8	12	3 3/4	95.3	9 17/32	242.1	[1] O-Ring		BT9433
1 3/8	12	3 3/4	95.3	9 17/32	242.1	[1] Included		BT9466-MPG
1 3/8	12	3 3/4	95.3	9 19/32	243.7	[1] Included		BT8312
1 3/8	12	3 3/4	95.3	9 19/32	243.7	[1] Included		BT8465
1 3/8	12	3 3/4	95.3	9 19/32	243.7	[1] Included		BT8851-MPG
1 3/8	12	3 3/4	95.3	9 19/32	243.7	[1] Included		BT8852-MPG
1 3/8	12	3 3/4	95.3	9 19/32	243.7	[1] Included		BT8855-MPG
1 3/8	12	3 3/4	95.3	9 19/32	243.7	[1] Included		BT8856-MPG
1 3/8	12	3 3/4	95.3	9 19/32	243.7	[1] Included		BT8861
1 3/8	12	3 3/4	95.3	9 19/32	243.7	[1] Included		BT8862
1 3/8	12	3 3/4	95.3	9 19/32	243.7	[1] Included		BT8863
1 3/8	12	3 3/4	95.3	9 19/32	243.7	[1] Included		BT9363-MPG
1 3/8	12	3 3/4	95.3	9 27/32	250.0	[1] Included		BT9370-MPG
1 3/8	12	3 13/16	96.8	9 7/16	239.7	[1] Included		BT8834-MPG
1 3/8	16	4 11/32	110.3	7 5/16	185.7	[1] Included		B9607
								UN-2B
1 3/8	12	4 23/32	119.9	10	254.0			BT40066-MPG
1 3/8	12	4 23/32	119.9	11 17/32	292.9	[1] Included		BT8320



WARNING: These products can expose you to chemicals, including Diisononyl Phthalate, Carbon black extracts, Nickel, 1,3 Butadiene, Ethylene Oxide, Epichlorohydrin, which are known to the State of California to cause cancer, and Bisphenol-A, Ethylene Glycol, Ethylene Oxide, 1,3 Butadiene, Epichlorohydrin, which are known to the State of California to cause birth defects or other reproductive harm. For more information go to www.P65Warnings.ca.gov.

SPIN-ON FILTERS BY TAP SIZE (U.S. THREAD)

THREAD I.D.	PER Inch	O.D. Inches	O.D. (mm)	LENGTH Inches	LENGTH (mm)	GASKET	FEATURES	BALDWIN NUMBER
1 3/8	12	4 23/32	119.9	11 17/32	292.9	[1] Included		BT8432-MPG
1 3/8	12	4 23/32	119.9	11 17/32	292.9	[1] Included		BT9362-MPG
1 3/8	12	4 23/32	119.9	11 17/32	292.9	[1] Included		BT9391-MPG
1 3/8	12	4 23/32	119.9	11 17/32	292.9			BT9421-MPG
1 3/8	16	4 1/4	108.0	10 1/16	255.6	[1] Included		B7409
1 3/8	16	4 1/4	108.0	10 1/16	255.6	[1] Included		B7685
1 3/8	16	4 21/32	118.3	9 7/8	250.8			B220
1 3/8	16	4 21/32	118.3	9 29/32	251.6	[1] Included	PS	B7019
1 3/8	16	4 11/16	119.1	9 15/16	252.4			B7577
1 3/8	16	4 29/32	124.6	10 1/16	255.6	[1] Included		B7246
1 3/8	16	5 3/8	136.5	10 9/16	268.3	[1] Included	D, PS	BF7635
1 3/8	16	5 3/8	136.5	12 3/32	307.2	[1] Included	PS	BF799
1 3/8	16	5 3/8	136.5	12 3/32	307.2	[1] Included	PS	BF7639
1 3/8	16	5 3/8	136.5	12 7/16	315.9	[1] Included	D, PS	BF7639-D
1 1/2	12	4 21/32	118.3	4 15/16	125.4	[1] Included	SHBP	BD7159
1 1/2	12	4 21/32	118.3	4 15/16	125.4	[1] Included	HBP	BD7169
1 1/2	12	4 21/32	118.3	4 15/16	125.4	[1] Included	HBP	B40138
1 1/2	12	4 21/32	118.3	6 1/4	158.8			G498-A B404
1 1/2	12	4 21/32	118.3	6 9/32	159.5	[1] Included		B105
1 1/2	12	4 21/32	118.3	8 1/16	204.8	[1] Included	MBP	BD7166
1 1/2	12	4 21/32	118.3	8 3/32	205.6	[1] Included	PS	B205
1 1/2	12	4 21/32	118.3	8 3/32	205.6	[1] Included		B7004
1 1/2	12	4 21/32	118.3	8 3/32	205.6	[1] Included		B7005
1 1/2	12	4 21/32	118.3	8 3/32	205.6	[1] Included		BD7141
1 1/2	12	4 21/32	118.3	8 3/32	205.6	[1] Included	HBP	B7217
1 1/2	12	4 21/32	118.3	8 3/32	205.6	[1] Included	AD, PS	B7239
1 1/2	12	4 21/32	118.3	8 3/32	205.6	[1] Included	MBP	B7324
1 1/2	12	4 21/32	118.3	8 3/32	205.6			G498-D B7416
1 1/2	12	4 21/32	118.3	9 15/16	252.4	[1] Included	PS	B95
1 1/2	12	4 21/32	118.3	9 15/16	252.4	[1] Included	PS	B95-MPG
1 1/2	12	4 21/32	118.3	9 15/16	252.4	[1] Included	PS	B95-SS
1 1/2	12	4 21/32	118.3	9 15/16	252.4	[1] Included	PS	B196
1 1/2	12	4 21/32	118.3	9 15/16	252.4	[1] Included	AD	B7241
1 1/2	12	4 21/32	118.3	9 15/16	252.4			BF9888
1 1/2	12	4 21/32	118.3	11 5/16	287.3	[1] Included	PS	BF9864
1 1/2	12	4 11/16	119.1	11 9/32	286.5	[1] Included	PS	B96
1 1/2	12	4 11/16	119.1	11 9/32	286.5	[1] Included	PS	B96-MPG
1 1/2	12	4 11/16	119.1	11 9/32	286.5	[1] Included	PS	B96-SS
1 1/2	12	4 11/16	119.1	11 9/32	286.5	[1] Included	PS	B7396
1 1/2	12	4 15/16	125.4	4 15/16	125.4	[1] Included	SHBP	B40137
1 1/2	12	5 1/16	128.6	6 31/32	177.0	[1] Included		BT486
1 1/2	16	3 11/16	93.7	5 9/16	141.3	[1] Included		BF7586
1 1/2	16	3 11/16	93.7	5 9/16	141.3	[1] Included		BT8316-MPG
1 1/2	16	3 11/16	93.7	5 9/16	141.3	[1] Included	MBP	BT9346-MPG
1 1/2	16	3 11/16	93.7	5 3/4	146.0	[1] Included	HBP	B7125
1 1/2	16	3 11/16	93.7	7 3/16	182.6	[1] Included	D	BF7695
1 1/2	16	3 11/16	93.7	8 1/16	204.8	[1] Included		BT372-10
1 1/2	16	3 11/16	93.7	8 1/16	204.8	[1] Included		BT372-MPG
1 1/2	16	3 11/16	93.7	8 1/16	204.8	[1] Included		BT8509-MPG
1 1/2	16	3 3/4	95.3	5 9/16	141.3	[1] Included		BF7645
1 1/2	16	3 3/4	95.3	5 9/16	141.3	[1] Included		BF7995
1 1/2	16	3 3/4	95.3	5 9/16	141.3			BT23525-MPG
1 1/2	16	3 3/4	95.3	5 3/4	146.0	[1] Included	HBP	B7516
1 1/2	16	3 3/4	95.3	8 1/4	209.6	[1] Included	HBP	B40022-MPG
1 1/2	16	3 25/32	96.0	5 23/32	145.3	[1] Included		BT371-5
1 1/2	16	3 13/16	96.8	5 13/32	137.3	[1] Included		BT371-10
1 1/2	16	3 13/16	96.8	5 13/32	137.3	[1] Included		BT371-MPG
1 1/2	16	3 15/16	100.0	9 1/2	241.3	[1] Included		BT8397-MPG
1 1/2	16	4 1/4	108.0	5 7/8	149.2	[1] Included		B134
1 1/2	16	4 1/4	108.0	7 3/8	187.3	[1] Included		B7039
1 1/2	16	4 7/16	112.7	8 11/32	211.9	[1] Included	ADP, D	BD7105
1 1/2	16	4 21/32	118.3	6 9/32	159.5	[1] Included		BT8890-MPG
1 1/2	16	4 21/32	118.3	6 9/32	159.5	[1] Attached		BT23603-MPG
1 1/2	16	4 21/32	118.3	8 3/32	205.6	[1] Included		B7513
1 1/2	16	4 21/32	118.3	8 1/8	206.4	[1] Included		B7155
1 1/2	16	4 21/32	118.3	8 1/8	206.4	[1] Included		BD7325
1 1/2	16	4 21/32	118.3	9 29/32	251.6			G498-A B97
1 1/2	16	4 21/32	118.3	11 1/4	298.5			G498-A B49

SPIN-ON FEATURES

Some spin-ons have no additional features while others have several. Here are some of the more important spin-on features:

Anti-Drainback Valve



As the name implies, this valve keeps the oil from draining from a filter when the engine is shut off. (Some filters include an anti-drainback standpipe for the same function). The mounting direction determines the need for this feature.

By-Pass Valve



Full-flow oil systems require a by-pass (relief) valve either in the system or in the filter. This valve opens at a predetermined setting to assure oil flow to the bearings at all times.

Integral Post Seal



Seals threaded stud to prevent tiny particles from spiraling in via the threads.

We Cannot be Responsible for Misapplications



WARNING: These products can expose you to chemicals, including Diisononyl Phthalate, Carbon black extracts, Nickel, 1,3 Butadiene, Ethylene Oxide, Epichlorohydrin, which are known to the State of California to cause cancer, and Bisphenol-A, Ethylene Glycol, Ethylene Oxide, 1,3 Butadiene, Epichlorohydrin, which are known to the State of California to cause birth defects or other reproductive harm. For more information go to www.P65Warnings.ca.gov.

SPIN-ON FILTERS BY TAP SIZE (U.S. THREAD)

	THREAD I.D.	PER Inch	O.D. Inches	O.D. (mm)	LENGTH Inches	LENGTH (mm)	GASKET	FEATURES	BALDWIN NUMBER
SPIN-ON FILTER FEATURES ARE CODED AS FOLLOWS	1 1/2	16	4 21/32	118.3	11 3/4	298.5	[1] Included		BT8381
	1 1/2	16	4 13/16	122.2	7 15/32	189.7	[1] Included		BT8801-MPG
	1 1/2	16	4 13/16	122.2	7 15/32	189.7	[1] Included		BT8802-MPG
	1 1/2	16	4 13/16	122.2	7 15/32	189.7	[1] Included		BT8812-MPG
	1 1/2	16	4 13/16	122.2	7 15/32	189.7	[1] Included		BT9343-MPG
	1 1/2	16	4 13/16	122.2	11 15/32	291.3	[1] Included		BT8805-MPG
	1 1/2	16	4 13/16	122.2	11 9/16	293.7	[1] Included		BT8800-MPG
	1 1/2	16	4 13/16	122.2	11 9/16	293.7	[1] Included		BT8803-MPG
	1 1/2	16	4 13/16	122.2	11 9/16	293.7	[1] Included		BT8813-MPG
	1 1/2	16	4 13/16	122.2	11 29/32	302.4	[1] Included		BT8457-MPG
AD Anti-Drainback Valve	1 1/2	16	5 1/32	127.8	6 31/32	177.0	G369-B	BP, BPS	BT424
ADP Anti-Drainback Pipe	1 1/2	16	5 1/32	127.8	6 31/32	177.0	G369-B, G372, G447		BT8901-MPG
BP 8-10 PSID By-Pass Valve	1 1/2	16	5 1/32	127.8	7	177.8	G369-B (Blue), G372 (Yellow)		BT287
BPI By-Pass Included	1 1/2	16	5 1/32	127.8	7	177.8	G369-B		BT287-10
BPS By-Pass Screen	1 1/2	16	5 1/32	127.8	7	177.8	G286-C		BT387
BTA PLUS Balanced Treatment Additive Plus	1 1/2	16	5 1/32	127.8	7	177.8	G286-C		BT387-10
BTE Balanced Treatment for Ethylene Glycol Antifreeze	1 1/2	16	5 1/32	127.8	10 11/16	271.5	[3] Included		BT23539
D Drain	1 1/2	16	5 1/32	127.8	10 3/4	273.1	G286-C		BT388
FECV Front-End Check Valve	1 1/2	16	5 1/16	128.6	10 3/4	273.1	G286-C		BT388-10
FP Fill Port	1 1/2	16	5 1/16	128.6	6 31/32	177.0	G369-B		BT8307-MPG
HBP 18-25 PSID High Pressure By-Pass Valve	1 1/2	16	5 1/16	128.6	6 31/32	177.0	G369-B, G447		BT8309-MPG
ISO Inside-Out Flow Direction	1 1/2	16	5 1/16	128.6	6 31/32	177.0	G369-B		BT8421-MPG
LBP 2-7 PSID Low Pressure By-Pass Valve	1 1/2	16	5 1/16	128.6	6 31/32	177.0	G369-B		BT8423
MBP 11-17 PSID Medium Pressure By-Pass Valve	1 1/2	16	5 1/16	128.6	6 31/32	177.0	G369-B		BT9356
MO Metering Orifice	1 1/2	16	5 1/16	128.6	7	177.8	G447		BT9371-MPG
PS Integral Post Seal Gasket	1 1/2	16	5 1/16	128.6	7	177.8	G369-B		BT287-3
PSR Post Seal Required; Must install loose O-Ring or D-Ring on Post for Seal	1 1/2	16	5 1/16	128.6	8 15/16	227.0	[1] Included	BP, BPS	BT425
RC Reinforced Centertube	1 1/2	16	5 1/16	128.6	10 3/4	273.1	G372		BT389
SHBP 30-45 PSID Super High Pressure By-Pass Valve	1 1/2	16	5 1/16	128.6	10 3/4	273.1	G369-B		BT389-10
SP Sensor Port	1 1/2	16	5 1/16	128.6	10 3/4	273.1	G369-B		BF1239
XHBP 50+ PSID Extra High Pressure By-Pass Valve	1 1/2	16	5 1/16	128.6	10 3/4	273.1	G369-B		B7011
Do NOT Interchange Filters with Different Features	1 1/2	16	5 1/16	128.6	10 3/4	273.1	G369-B		BF7571
	1 1/2	16	5 1/16	128.6	10 3/4	273.1	G369-B		BF7623
	1 1/2	16	5 1/16	128.6	10 3/4	273.1	G369-B, G447		BT8308-MPG
	1 1/2	16	5 1/16	128.6	10 3/4	273.1	G369-B, G447		BT8308-MPG KIT
	1 1/2	16	5 1/16	128.6	10 3/4	273.1	G369-B		BT8310-MPG
	1 1/2	16	5 1/16	128.6	10 3/4	273.1	G369-B		BT8368
	1 1/2	16	5 1/16	128.6	10 3/4	273.1	G369-B		BT8422-MPG
	1 1/2	16	5 1/16	128.6	10 3/4	273.1	[1] Included		BT8471-MPG
	1 1/2	16	5 1/16	128.6	10 3/4	273.1	[1] Included		BT8510-MPG
	1 1/2	16	5 1/16	128.6	10 3/4	273.1	G369-B		BT9345
1 1/2	16	5 1/16	128.6	10 25/32	273.8	[2] G483	HBP	(One Per Filter)	BT345 KIT
1 1/2	16	5 3/32	129.4	6 21/32	169.1				BT23140-MPG
1 1/2	16	5 3/8	136.5	7	177.8	[1] Included	BPS, XHBP		B7363
1 1/2	16	5 3/8	136.5	8 19/32	218.3	[1] Included			B7402
1 1/2	16	5 3/8	136.5	8 7/8	225.4	[1] Included	SHBP		B7182
1 1/2	16	5 3/8	136.5	12 3/32	307.2	[1] Included			B99
1 1/2	16	5 3/8	136.5	12 3/32	307.2	[1] Included			B99-B
1 1/2	16	5 3/8	136.5	12 3/32	307.2	[1] Included			B99-MPG
1 1/2	16	5 3/8	136.5	12 3/32	307.2	[1] Included			B99-SS
1 1/2	16	5 3/8	136.5	12 3/32	307.2	[1] Included	SHBP		B239
1 1/2	16	5 3/8	136.5	12 3/32	307.2	[1] Included	AD, SHBP		B7157
1 1/2	16	5 3/8	136.5	12 3/32	307.2	[1] Included	SHBP		B7180
1 1/2	16	5 3/8	136.5	12 3/32	307.2	[1] Included			B7245
1 1/2	16	5 3/8	136.5	12 3/32	307.2	[1] Included			B7249-MPG
1 1/2	16	5 3/8	136.5	12 3/32	307.2	[1] Included			B7299
1 1/2	16	5 3/8	136.5	12 3/32	307.2	[4] Included			B7507
1 1/2	16	5 3/8	136.5	12 3/8	314.3	[1] Included	SHBP		B7187
1 1/2	16	5 1/2	139.7	7	177.8	[1] Included	HBP		BT8437
1 5/8	12	UN 4 5/8	117.5	10 13/32	264.3	[1] Included			B40053
1 5/8	12	4 21/32	118.3	9 15/16	252.4	[1] Included			B495
1 5/8	12	4 21/32	118.3	9 15/16	252.4	[1] Included			B495-MPG
1 5/8	12	4 21/32	118.3	9 15/16	252.4	[1] Included			B495-SS
1 5/8	12	4 11/16	119.1	11 9/32	286.5	[1] Included	PS		BF7948
1 5/8	12	5 1/16	128.6	6 31/32	177.0	G369-B, G447			B7335-MPG



WARNING: These products can expose you to chemicals, including Diisononyl Phthalate, Carbon black extracts, Nickel, 1,3 Butadiene, Ethylene Oxide, Epichlorohydrin, which are known to the State of California to cause cancer, and Bisphenol-A, Ethylene Glycol, Ethylene Oxide, 1,3 Butadiene, Epichlorohydrin, which are known to the State of California to cause birth defects or other reproductive harm. For more information go to www.P65Warnings.ca.gov.

SPIN-ON FILTERS BY TAP SIZE (U.S. THREAD)

THREAD I.D.	PER Inch	O.D. Inches	O.D. (mm)	LENGTH Inches	LENGTH (mm)	GASKET	FEATURES	BALDWIN NUMBER
1 3/4	12	4	9/16	11 13/32	289.7			BT7503
1 3/4	12	4	23/32	7 3/4	196.9	[1] Included		BT8875-MPG
1 3/4	12	4	23/32	7 3/4	196.9	[1] Included		BT8880-MPG
1 3/4	12	4	23/32	11 1/2	292.1	[1] Included		BT9365-MPG
1 3/4	12	4	23/32	11 17/32	292.9	[1] Included		BT8401-MPG
1 3/4	12	4	23/32	11 17/32	292.9	[1] Included		BT8874-MPG
1 3/4	12	4	23/32	11 17/32	292.9	[1] Included		BT8877-MPG
1 3/4	12	4	23/32	11 17/32	292.9	[1] Included		BT8878-MPG
1 3/4	12	4	23/32	11 17/32	292.9	[1] Included		BT8879-MPG
1 3/4	12	4	23/32	11 17/32	292.9	[1] Included		BT8892-MPG
1 3/4	12	4	23/32	11 17/32	292.9	[1] Included		BT8910-MPG
1 3/4	12	4	23/32	11 17/32	292.9	[1] Included		BT8911-MPG
1 3/4	12	4	23/32	11 17/32	292.9	[1] Included		BT9353-MPG
1 3/4	12	4	23/32	14 3/32	358.0	[1] Included		BT9560-MPG
1 3/4	12	4	23/32	14 1/8	358.6			BT40067-MPG
1 3/4	12 UN	4	23/32	14 1/8	358.6			BF46061
1 3/4	12 UN	4	23/32	14 1/8	358.6			BF46244
1 3/4	12	4	23/32	14 1/8	358.8	[1] Included		BT8870-MPG
1 3/4	12	4	3/4	11 17/32	292.9	[1] Included		BT8873
1 3/4	12	4	3/4	11 19/32	294.5	[1] Included		BT8876-MPG
1 3/4	12 UN	4	3/4	14 1/4	362.0	[1] Attached		BT23609-MPG
1 3/4	12	4	25/32	14 1/4	362.0			BT23542-MPG
1 3/4	16	4	21/32	9 15/16	252.4	[1] Included	MBP	BT9439
1 3/4	16	5	3/8	7	177.8	[1] Included	BPS, MBP	BT8899
1 3/4	16 UN	5	3/8	7	177.8	[1] Included	MBP	BT23555-MPG
1 3/4	16	5	3/8	9 5/8	244.5	[1] Included	MBP	BT8382
1 3/4	16 UN	5	3/8	9 5/8	244.5	[1] Included	MBP	BT23605-MPG
1 7/8	12	5	7/32	6 7/8	174.6	[1] Included		BT8927
2	12	3	1/8	5 17/32	140.5		PS	BT8333
2	12	3	1/8	5 17/32	140.5			BT9349-MPG
2	12	3	1/8	5 17/32	140.5	[1] Included		BT9393-MPG
2	12	3	1/8	9 17/32	242.1	[1] Included		BT8418
2	12	3	1/8	9 17/32	242.1			BT8886-MPG
2	12	3	1/8	9 17/32	242.1	[2] Included		BT9392-MPG
2	16	3	11/16	5 21/32	143.7	G401	HBP	BT8830
2	16	3	11/16	7 7/32	183.4	G401		BT8831
2	16	3	11/16	7 7/32	183.4	G401	HBP	BT8832
2	16	3	11/16	7 7/32	183.4	G401	SHBP	BT8833
2	16	3	3/4	6 3/32	154.8	[1] Included	XHBP	BT8426-MPG
2	16	3	3/4	7 7/32	183.4	[2] O-Rings	BPS, XHBP	BT9400-MPG
2 1/4	12	4	5/8	10	254.0			BF46002
2 1/4	12	4	21/32	9 5/8	244.5	G293-B		BD324
2 1/4	12	4	21/32	10 5/16	261.9	[1] Included		BF7932
2 1/4	12	4	21/32	11 13/32	289.7	G293-B		BD103
2 1/4	12	4	21/32	11 13/32	289.7	G293-B		BD103-MPG
2 1/4	12	4	21/32	11 13/32	289.7	G293-B		BD103-SS
2 1/4	12	4	21/32	11 13/32	289.7	G293-B		B333
2 1/4	12	4	21/32	11 13/32	289.7	[1] Included		BD7309
2 1/4	12	4	21/32	11 13/32	289.7			BD7504
2 1/4	12	4	21/32	11 13/32	289.7			B40142
2 1/2	12	5	7/32	6 5/8	168.3	[1] Included		BA5371
3	8	5		8 13/16	223.8			BT775
3	8	5		12 1/4	311.2			BT774
3 3/8	8	4	1/32	6 3/8	161.9	[2] O-Rings		BF46062

CAUTION!!! Read These Instructions Before Using Size Charts

The filter size charts on this and following pages are for filter experts. Careless use could lead to errors. When you have exhausted all other ways to determine a filter number, locate a suspect here, then check the Product Guide for confirmation.

Size alone does not assure you of the right filtering media, gasket or other features. What is being filtered, filter efficiency, flow rate and direction of flow all have to be considered.

Spin-on filters are listed by tap size rather than length. All other filters are listed on an overall basis. Check your Product Guide for other dimensions. Progression is from the smallest to the largest in each category.

Do NOT Interchange Filters with Different Features

Be Sure to Check Product Guide, Cross-References and Applications

We Cannot be Responsible for Misapplications



WARNING: These products can expose you to chemicals, including Diisononyl Phthalate, Carbon black extracts, Nickel, 1,3 Butadiene, Ethylene Oxide, Epichlorohydrin, which are known to the State of California to cause cancer, and Bisphenol-A, Ethylene Glycol, Ethylene Oxide, 1,3 Butadiene, Epichlorohydrin, which are known to the State of California to cause birth defects or other reproductive harm. For more information go to www.P65Warnings.ca.gov.

SPIN-ON FILTERS BY TAP SIZE (BRITISH STANDARD PIPE THREAD)

CAUTION!!!
Read These Instructions Before Using Size Charts

The filter size charts on this and following pages are for filter experts. Careless use could lead to errors. When you have exhausted all other ways to determine a filter number, locate a suspect here, then check the Product Guide for confirmation.

Size alone does not assure you of the right filtering media, gasket or other features. What is being filtered, filter efficiency, flow rate and direction of flow all have to be considered.

Spin-on filters are listed by tap size rather than length. All other filters are listed on an overall basis. Check your Product Guide for other dimensions. Progression is from the smallest to the largest in each category.

Do NOT Interchange Filters with Different Features

Be Sure to Check Product Guide, Cross-References and Applications

We Cannot be Responsible for Misapplications

THREAD I.D.	PER Inch	O.D. Inches	O.D. (mm)	LENGTH Inches	LENGTH (mm)	GASKET	FEATURES	BALDWIN NUMBER
3/4	14	BSP-PL	3 11/1693.7	3 7/32.....81.8				BT368
3/4	14	BSP-PL	3 11/1693.7	5 3/8.....136.5		G381-A.....		BT8472
3/4	14	BSP-PL	3 11/1693.7	5 13/32.....137.3		G401.....		BT366-10
3/4	14	BSP-PL	3 11/1693.7	8 5/32.....207.2		G381-A.....		BT8473
3/4	14	BSP-PL	3 11/1693.7	8 5/32.....207.2		G381-A.....		BT8474
3/4	14	BSP-PL	3 3/495.3	2 5/16.....58.7		[1] Included.....		BT9326
3/4	14	BSP-PL	3 3/495.3	5 23/32.....145.3				BT8913-MPG
3/4	14	BSP-PL	3 3/495.3	5 3/4146.0				BT8928
3/4	14	BSP-PL	3 3/495.3	5 3/4146.0		[1] Included.....	HBP.....	BT8935
3/4	14	BSP-PL	3 25/32.....96.0	5 23/32.....145.3		[1] Included.....		BT366-MPG
3/4	14	BSP-PL	3 25/32.....96.0	7 19/32.....192.9		[1] Included.....		BT9316-MPG
1 1/4	11	BSP-PL	4 5/8117.5	6 9/32.....159.5		G498-A.....	PS.....	BT611-MPG
1 1/4	11	BSP-PL	4 5/8117.5	11 9/32.....286.5		G498-A.....	PS.....	BT610-MPG
1 1/4	11	BSP-PL	4 21/32118.3	8 3/32.....205.6		G498-A.....	PS.....	BT9558-MPG
1 1/4	11	BSP-PL	5127.0	7177.8		[1] Included.....		BT351-MPG
1 1/4	11	BSP-PL	5127.0	7 3/32.....180.2		[1] Included.....		BT351
1 1/4	11	BSP-PL	5127.0	7 3/32.....180.2		[1] Included.....	AD, MBP.....	BT8450
1 1/4	11	BSP-PL	5127.0	7 3/32.....180.2		[1] Included.....		BT8475
1 1/4	11	BSP-PL	5 1/32127.8	7 7/32.....180.2		[1] Included.....		BT9324
1 1/4	11	BSP-PL	5 1/32127.8	8 15/16.....227.0				BT8477-MPG
1 1/4	11	BSP-PL	5 1/16128.6	7 1/16179.4				BT8475-MPG
1 1/4	11	BSP-PL	5 1/16128.6	7 3/32.....180.2		[1] Included.....		BT8930
1 1/4	11	BSP-PL	5 1/16128.6	9.....228.6				BT8931
1 1/4	11	BSP-PL	5 1/8130.2	8 11/16220.7		[1] Included.....		BT8476
1 1/4	11	BSP-PL	5 1/8130.2	8 11/16220.7		[1] Included.....		BT8476-MPG
1 1/4	11	BSP-PL	5 1/8130.2	8 11/16220.7		[1] Included.....		BT8477
1 1/4	11	BSP-PL	5 1/8130.2	8 29/32.....226.2		[1] Included.....		BT8915
1 1/4	11	BSP-PL	5 11/32135.7	7177.8		[1] Included.....		BA5378
						[1] O-Ring		
1 1/4	11	BSP-PL	5 1/2139.7	6 31/32.....177.0		[1] Included.....		BA5375
						[1] O-Ring		
1 1/2	11	BSP-PL	4 15/16125.4	7 17/32.....191.3		[1] Included.....	MBP.....	BT9320
1 1/2	11	BSP-PL	5 1/32127.8	7 19/32.....192.9				BT8937



WARNING: These products can expose you to chemicals, including Diisononyl Phthalate, Carbon black extracts, Nickel, 1,3 Butadiene, Ethylene Oxide, Epichlorohydrin, which are known to the State of California to cause cancer, and Bisphenol-A, Ethylene Glycol, Ethylene Oxide, 1,3 Butadiene, Epichlorohydrin, which are known to the State of California to cause birth defects or other reproductive harm. For more information go to www.P65Warnings.ca.gov.

SPIN-ON FILTERS BY TAP SIZE (METRIC THREAD)

THREAD I.D.	O.D. Inches	O.D. (mm)	LENGTH Inches	LENGTH (mm)	GASKET	FEATURES	BALDWIN NUMBER
M12 x 1.5	3 1/16.....	77.8	5 1/2.....	139.7	[2] Included	PS	BF7990
M12 x 1.5	3 3/8.....	85.7	3 13/16.....	96.8	[2] Included	PS	BF7619
M14 x 1.5	3 1/32.....	77.0	3 15/32.....	88.1	G449-B		BF1056
M14 x 1.5	3 1/4.....	82.6	6 21/32.....	169.1	[1] Included		BF9876
M14 x 1.5	3 11/16.....	93.7	4 11/16.....	119.1	G381-A	D	BF1361
M14 x 1.5	3 11/16.....	93.7	7 11/32.....	186.5	[1] Included	D	BF1217
M16 x 1.5	2 31/32.....	75.4	2 31/32.....	75.4	[1] Included		BF7880
M16 x 1.5	3.....	76.2	2 31/32.....	75.4	[1] Included	MBP	B7292
M16 x 1.5	3.....	76.2	3 17/32.....	89.7	G449-B	BP	B474
M16 x 1.5	3.....	76.2	4 7/32.....	107.2	G449-B	D, PS	BF1257
M16 x 1.5	3.....	76.2	4 7/32.....	107.2	[1] Included,	D	BF1261
M16 x 1.5	3.....	76.2	4 27/32.....	123.0	G449-B	PS	BF782
M16 x 1.5	3 1/32.....	77.0	2 5/16.....	58.7	G449-B		BT9408
M16 x 1.5	3 1/32.....	77.0	2 27/32.....	72.2	G449-B		BF7909
M16 x 1.5	3 1/32.....	77.0	2 27/32.....	72.2	G449-B		BF7915
M16 x 1.5	3 1/32.....	77.0	3 1/8.....	79.4	[1] Included	D	BF1267
M16 x 1.5	3 1/32.....	77.0	3 15/32.....	88.1	G449-B		BF790
M16 x 1.5	3 1/32.....	77.0	4 3/32.....	104.0	[1] Included	PSR	BF7608
M16 x 1.5	3 1/32.....	77.0	4 11/16.....	119.1	[2] O-Rings	PS, SP	BF1232
M16 x 1.5	3 1/32.....	77.0	4 13/16.....	122.2	Included, G449-B		BF9841
M16 x 1.5	3 1/32.....	77.0	4 27/32.....	123.0	[1] Included	ADP, PSR	BF788
M16 x 1.5	3 1/32.....	77.0	4 27/32.....	123.0	[1] O-Ring		BF988
M16 x 1.5	3 1/32.....	77.0	4 27/32.....	123.0	G449-B		BF7931
M16 x 1.5	3 1/32.....	77.0	5 7/32.....	132.6	[1] Included	D	BF1269
M16 x 1.5	3 1/32.....	77.0	5 11/16.....	144.5	G449-B, [1] O-Ring	ADP, D, PSR	BF1226
M16 x 1.5	3 1/32.....	77.0	5 11/16.....	144.5	G449-B		BF7921
M16 x 1.5	3 1/32.....	77.0	5 27/32.....	148.4	G449-B		BF586
M16 x 1.5	3 1/32.....	77.0	5 27/32.....	148.4	G449-B	D	BF586-D
M16 x 1.5	3 1/32.....	77.0	5 27/32.....	148.4	G449-B		BF7663
M16 x 1.5	3 1/32.....	77.0	5 29/32.....	150.0	[1] Included	D, PS	BF1372
M16 x 1.5	3 1/32.....	77.0	5 29/32.....	150.0	[1] Included	D	BF1396
M16 x 1.5	3 1/32.....	77.0	5 29/32.....	150.0	[1] Included		BF46149-SP
M16 x 1.5	3 1/32.....	77.0	6 1/8.....	155.6	G449-B		BF587
M16 x 1.5	3 1/32.....	77.0	6 1/8.....	155.6	G449-B	D	BF587-D
M16 x 1.5	3 1/32.....	77.0	6 1/8.....	155.6	G449-B	D	BF7591-D
M16 x 1.5	3 1/32.....	77.0	6 1/2.....	165.1	G449-B	PS, PSR, SP	BF7998
M16 x 1.5	3 1/32.....	77.0	6 21/32.....	169.1	G449-B	ADP, D	BF1221
M16 x 1.5	3 1/32.....	77.0	6 21/32.....	169.1	[1] Included,	D, PSR	BF1276
M16 x 1.5	3 1/32.....	77.0	6 21/32.....	169.1	G449-B	D	BF1367
M16 x 1.5	3 1/32.....	77.0	6 21/32.....	169.1	G449-B,	D	BF7772
M16 x 1.5	3 1/16.....	77.8	5 25/32.....	146.8	[1] Included	D	BF9842
M16 x 1.5	3 3/32.....	78.6	2 1/2.....	63.5	[1] Included	AD, BPI	B7293
M16 x 1.5	3 5/32.....	80.2	7 5/16.....	185.7	[1] Included	D, PS	BF9812
M16 x 1.5	3 3/16.....	81.0	6 15/16.....	176.2	[1] Included,		BF46012
M16 x 1.5	3 3/16.....	81.0	6 15/16.....	176.2	[1] O-Ring		BF46014
M16 x 1.5	3 9/32.....	83.3	6 3/16.....	157.2	[2] Included		BF46014
M16 x 1.5	3 9/32.....	83.3	7 15/32.....	189.7	[1] Included;		BF7976
M16 x 1.5	3 9/32.....	83.3	7 15/32.....	189.7	[1] Grommet		BF9813
M16 x 1.5	3 9/32.....	83.3	7 15/32.....	189.7		D, PS	BF9813
M16 x 1.5	3 9/32.....	83.3	7 15/32.....	189.7	[1] Included	D, PS	BF9883
M16 x 1.5	3 3/8.....	85.7	6 23/32.....	170.7	[1] Included		BF7970
M16 x 1.5	3 7/16.....	87.3	6 13/32.....	162.7	[1] Included	D	BF5587-D
M16 x 1.5	3 11/16.....	93.7	4 3/8.....	111.1	G381-A		BF7883
M16 x 1.5	3 11/16.....	93.7	4 7/16.....	112.7	G401		B5145
M16 x 1.5	3 11/16.....	93.7	4 7/16.....	112.7	G401	BTE	BW5183
M16 x 1.5	3 11/16.....	93.7	5 1/4.....	133.4	G381-A,		BF7919
M16 x 1.5	3 11/16.....	93.7	5 3/8.....	136.5	[1] Included		BF900
M16 x 1.5	3 11/16.....	93.7	5 3/8.....	136.5	G381-A		BF7664
M16 x 1.5	3 11/16.....	93.7	5 13/32.....	137.3	G401		B5091
M16 x 1.5	3 11/16.....	93.7	5 13/32.....	137.3	G401	BTE	BW5141
M16 x 1.5	3 11/16.....	93.7	5 13/32.....	137.3	G401	BTE	BW5142

CAUTION!!! Read These Instructions Before Using Size Charts

The filter size charts on this and following pages are for filter experts. Careless use could lead to errors. When you have exhausted all other ways to determine a filter number, locate a suspect here, then check the Product Guide for confirmation.

Size alone does not assure you of the right filtering media, gasket or other features. What is being filtered, filter efficiency, flow rate and direction of flow all have to be considered.

Spin-on filters are listed by tap size rather than length. All other filters are listed on an overall basis. Check your Product Guide for other dimensions. Progression is from the smallest to the largest in each category.

Do NOT Interchange Filters with Different Features

Be Sure to Check Product Guide, Cross-References and Applications

We Cannot be Responsible for Misapplications



WARNING: These products can expose you to chemicals, including Diisononyl Phthalate, Carbon black extracts, Nickel, 1,3 Butadiene, Ethylene Oxide, Epichlorohydrin, which are known to the State of California to cause cancer, and Bisphenol-A, Ethylene Glycol, Ethylene Oxide, 1,3 Butadiene, Epichlorohydrin, which are known to the State of California to cause birth defects or other reproductive harm. For more information go to www.P65Warnings.ca.gov.

SPIN-ON FILTERS BY TAP SIZE (METRIC THREAD)

A TYPICAL SPIN-ON

Spin-ons vary in size, media, fittings and other features. Let's look at the usual components.

Spin-on Can



No housing to clean; faster to change.

Baseplate and Seaming Cover Assembly



Size of mounting hole and gasket location determine if filter will seal. The baseplate is attached to the seaming cover and the seaming cover is attached to the can. (The gasket fits in the seaming cover.)

Compression Spring



Holds element in place to maintain seal.

Element End Caps



Closed End

Open End

End caps are bonded to the media.

Filtering Media



Microlite® pleated paper comes in more than 60 types for exact filtering requirements.

Centertube



Media is wrapped around the spiral perforated/louvered steel tube.

THREAD I.D.	O.D. Inches	O.D. (mm)	LENGTH Inches	LENGTH (mm)	GASKET	FEATURES	BALDWIN NUMBER
M16 x 1.5	3 11/16	93.7	5 13/32	137.3	G401		BF7888
M16 x 1.5	3 11/16	93.7	5 7/16	138.1	G401		B5144
M16 x 1.5	3 11/16	93.7	5 7/16	138.1	[1] Included		BW21000
M16 x 1.5	3 11/16	93.7	7 13/32	188.1	G381-A	D	BF1365
M16 x 1.5	3 11/16	93.7	7 31/32	202.4	G401, [1] O-Ring	D, PSR, SP	BF1371
M16 x 1.5	3 11/16	93.7	8 1/8	206.4	G381-A		BF980
M16 x 1.5	3 11/16	93.7	8 1/8	206.4	G381-A		BF7696
M16 x 1.5	3 23/32	94.5	5 3/8	136.5	G381-A, [1] Included		BF7955
M16 x 1.5-6H	3 23/32	94.5	7 5/32	181.9			BF46227
M16 x 1.5	3 23/32	94.5	7 9/32	184.9			BF46050
M16 x 1.5-6H	3 23/32	94.5	7 31/32	202.2			BF46069
M16 x 1.5	4 1/4	108.0	7	177.8	G401		BF7927
M18 x 1.5	2 25/32	70.6	2 13/16	71.4	[1] Included	AD, BP	B40000
M18 x 1.5	2 29/32	73.8	3 1/2	88.9	G449-B	AD	B43-S
M18 x 1.5	2 29/32	73.8	3 1/2	88.9	G449-B		B7446
M18 x 1.5	3	75.9	2 7/16	62.3	[1] Included	ISO	BF1380-O
M18 x 1.5	3	76.2	3 31/32	100.6			BF46164-O
M18 x 1.5	3	76.2	4 27/32	123.0	G449-B	AD	B35-S
M18 x 1.5	3 1/32	77.0	2 3/8	60.2	[2] Included	ISO	BF1379-O
M18 x 1.5	3 1/32	77.0	2 27/32	72.2	[1] Included		B40124
M18 x 1.5	3 1/32	77.0	4 19/32	116.7	[1] Included	ISO, PS, SP	BF1379
M18 x 1.5	3 1/32	77.0	4 19/32	116.7	[1] Included	D, ISO, PS, SP	BF1380
M18 x 1.5	3 1/32	77.0	4 19/32	116.7	[1] Included	D, ISO, PS, SP	BF1381
M18 x 1.5	3 3/32	78.6	2 15/32	62.7	[1] Included, [1] O-Ring		BF1381-O
M18 x 1.5	3 1/8	79.4	3 1/2	88.9	[1] Included	AD	B195
M18 x 1.5	3 11/16	93.7	3 7/8	98.4	G324-A	PS	BT338
M18 x 1.5	3 11/16	93.7	5 5/8	142.9	[2] Included		BF7886
M18 x 1.5	3 11/16	93.7	5 25/32	146.8	[1] Included		BF9820
M18 x 1.5	3 11/16	93.7	8 1/8	206.4	G381-A	PS	BF7644
M18 x 1.5	3 11/16	93.7	8 1/8	206.4	G381-A	PS	BF7653
M18 x 1.5	3 11/16	93.7	8 9/32	210.3	[1] Included		BF46032
M18 x 1.5	3 23/32	94.5	8 5/32	207.2	[1] Included		BF7997
M18 x 1.5	3 25/32	96.0	5 13/16	147.6			BF46127
M20 x 1.0	2 21/32	67.5	2 5/8	66.7	[1] Included	AD, HBP	B7419
M20 x 1.5	2 9/16	65.1	2 5/8	66.7	[1] Included	AD, HBP	B7285
M20 x 1.5	2 9/16	65.1	3 1/2	88.9	[1] Included	AD, MBP	B1402
M20 x 1.5	2 9/16	65.1	3 1/2	88.9	[1] Included	AD, HBP	B7318
M20 x 1.5	2 21/32	67.5	2 5/8	66.7	[1] Included	AD, MBP	B1400
M20 x 1.5	2 21/32	67.5	4	101.6	[1] Included	AD, MBP	B1431
M20 x 1.5	2 21/32	67.5	5 1/2	139.7	[1] Included	AD, MBP	BT40034
M20 x 1.5	2 23/32	69.1	3 13/32	86.5	[1] Included	AD, MBP	B7441
M20 x 1.5	2 25/32	70.6	2 5/8	66.7	[1] Included	AD, BPS	BT23631
M20 x 1.5	2 29/32	73.8	4 27/32	123.0	[1] Included	FeCV, SHBP	B40129
M20 x 1.5	3	76.2	2 5/16	58.7	[1] Included	AD, MBP	B7276
M20 x 1.5	3	76.2	2 27/32	72.2	[1] Included	AD, BP	B179
M20 x 1.5	3	76.2	2 27/32	72.2	[1] Included	AD, HBP	B227
M20 x 1.5	3	76.2	2 27/32	72.2	[1] Included	BP	B301
M20 x 1.5	3	76.2	2 27/32	72.2	[1] Included	AD, MBP	B421
M20 x 1.5	3	76.2	2 27/32	72.2	[1] Included		BF940
M20 x 1.5	3	76.2	2 27/32	72.2	[1] Included	BP	B1444
M20 x 1.5	3	76.2	2 27/32	72.2	[1] Included	AD, SHBP	B7216
M20 x 1.5	3	76.2	2 7/8	73.0	G449-B	AD, BP	B307
M20 x 1.5	3	76.2	3 11/32	84.9	[1] Included	AD, BPI	B7289
M20 x 1.5	3	76.2	3 1/2	88.9	G449-B		BF7683
M20 x 1.5	3	76.2	3 1/2	88.9	[1] Included	AD, BP	B40126
M20 x 1.5	3	76.2	3 17/32	89.7	G449-B	AD, LBP	BT310
M20 x 1.5	3	76.2	4 13/16	122.2	[1] Included	AD, BP	B247
M20 x 1.5	3	76.2	4 13/16	122.2	[1] Included		BT8902
M20 x 1.5	3	76.2	5 3/32	129.4	[1] Included	AD, BP	B168
M20 x 1.5	3	76.2	5 1/8	130.2	G449-B	AD, BP	B199
M20 x 1.5	3 1/32	77.0	2 25/32	70.6	[1] Included	AD, HBP	B7407
M20 x 1.5	3 1/32	77.0	3 13/32	86.5	[1] Included		BT23630
M20 x 1.5	3 1/32	77.0	3 7/16	87.3	[1] Included	AD, MBP	B1421
M20 x 1.5	3 1/32	77.0	3 7/16	87.3	[1] Included	AD, HBP	B1425
M20 x 1.5	3 1/32	77.0	3 7/16	87.3	[1] Included	AD, HBP	B7243
M20 x 1.5	3 1/32	77.0	3 7/16	87.3	[1] Included	AD, MBP	B7334



WARNING: These products can expose you to chemicals, including Diisononyl Phthalate, Carbon black extracts, Nickel, 1,3 Butadiene, Ethylene Oxide, Epichlorohydrin, which are known to the State of California to cause cancer, and Bisphenol-A, Ethylene Glycol, Ethylene Oxide, 1,3 Butadiene, Epichlorohydrin, which are known to the State of California to cause birth defects or other reproductive harm. For more information go to www.P65Warnings.ca.gov.

SPIN-ON FILTERS BY TAP SIZE (METRIC THREAD)

THREAD I.D.	O.D. Inches	O.D. (mm)	LENGTH Inches	LENGTH (mm)	GASKET	FEATURES	BALDWIN NUMBER
M20 x 1.5	3 1/32	77.0	3 7/16	87.3	[1] Included	AD, HBP	B7487
M20 x 1.5	3 1/32	77.0	3 1/2	88.9	G449-B	AD, HBP	B7167
M20 x 1.5	3 1/32	77.0	4 1/16	103.2	[1] Included	AD, HBP	B161-S
M20 x 1.5	3 1/32	77.0	4 3/32	104.0	[1] Included	PS	BF1110
M20 x 1.5	3 1/32	77.0	4 3/32	104.0	[1] Included		BF7544
M20 x 1.5	3 1/32	77.0	6 1/16	154.0	[1] Included	D	BF9821
M20 x 1.5	3 1/32	77.2	3 1/2	88.9	[1] Included	AD, SHBP	B40140
M20 x 1.5	3 3/32	78.6	2 21/32	67.5	[1] Included		BF7837
M20 x 1.5	3 3/32	78.6	3 27/32	97.6	[1] Included	BPI	B7277
M20 x 1.5	3 3/32	78.6	4 27/32	123.0	[1] Included	AD, HBP	B7390
M20 x 1.5	3 1/8	79.4	3	76.2	[1] Included		BT8917
M20 x 1.5	3 1/8	79.4	3 17/32	89.7	[1] Included	AD, MBP	B7352
M20 x 1.5	3 1/8	79.4	3 17/32	89.7	[1] Included	AD, HBP	B7428
M20 x 1.5	3 1/8	79.4	3 5/8	92.1	[1] Included	AD, MBP	B7445
M20 x 1.5	3 1/8	79.4	4 1/32	102.4	[1] Included	AD, MBP	B7430
M20 x 1.5	3 5/32	80.2	6 3/4	171.5	[1] Included	FECV	B40125
M20 x 1.5	3 7/32	81.8	3 7/8	98.4	[1] Included	AD, MBP	B7281
M20 x 1.5	3 7/32	81.8	4 25/32	121.4	[1] Included		BF7838
M20 x 1.5	3 1/2	88.9	2 11/32	59.5	[1] O-Ring		
M20 x 1.5	3 9/16	90.5	3 15/32	88.1	[1] Included	AD, BPI	B7283
M20 x 1.5	3 9/16	90.5	5 7/16	138.1	[1] Included	AD, HBP	B7432
M20 x 1.5	3 9/16	90.5	5 7/16	138.1	[2] Included	D, ISO, SP	BF7534
M20 x 1.5	3 9/16	90.5	7	177.8	G381-A		
M20 x 1.5	3 19/32	91.3	4 13/16	122.2	[1] Included		BF9850
M20 x 1.5	3 19/32	91.3	5 1/8	130.2	[1] Included	HBP	B7384
M20 x 1.5	3 19/32	91.3	7 1/8	181.0	[1] Included	AD, HBP	B7469
M20 x 1.5	3 19/32	91.3	7 7/8	200.0	[1] Included		BF9815
M20 x 1.5	3 5/8	92.1	5 1/16	128.6	[1] Included	D	BF9852
M20 x 1.5	3 5/8	92.1	6 11/16	169.9	[1] Included	AD, BPI	B7273
M20 x 1.5	3 11/16	93.7	2 27/32	72.2	[2] Included		BF9878
M20 x 1.5	3 11/16	93.7	3 1/4	82.6	[1] Included	PS	BF7552
M20 x 1.5	3 11/16	93.7	3 1/4	82.6	G381-A	AD, HBP	B173-S
M20 x 1.5	3 11/16	93.7	3 1/4	82.6	G324-A	AD, HBP	B488
M20 x 1.5	3 11/16	93.7	3 1/4	82.6	[1] Included	PS	BF9887
M20 x 1.5	3 11/16	93.7	3 1/4	82.6	[1] I. Gasket		B40121
M20 x 1.5	3 11/16	93.7	3 1/4	82.6	[1] Attached		BF46111
M20 x 1.5	3 11/16	93.7	3 3/8	85.7	[1] Included	HBP, PS	B7453
M20 x 1.5	3 11/16	93.7	3 27/32	97.6	[1] Included	AD, MBP	B7197
M20 x 1.5	3 11/16	93.7	3 7/8	98.4	G381-A	AD, HBP	B141
M20 x 1.5	3 11/16	93.7	3 7/8	98.4	G381-A		BF789
M20 x 1.5	3 11/16	93.7	4 3/8	111.1	G324-A	PS	BF720
M20 x 1.5	3 11/16	93.7	4 3/8	111.1	[2] Included	G401	SP
M20 x 1.5	3 11/16	93.7	4 3/8	111.1	G324-A	PS	BF7538
M20 x 1.5	3 11/16	93.7	4 11/16	119.1	G324-A	D	BF7528
M20 x 1.5	3 11/16	93.7	5 3/32	129.4	[1] Included	AD, BP	B7082
M20 x 1.5	3 11/16	93.7	5 3/8	136.5	G381-A	AD, HBP	B202
M20 x 1.5	3 11/16	93.7	5 3/8	136.5	G401, [1] O-Ring	PS, SP	BF1271
M20 x 1.5	3 11/16	93.7	5 3/8	136.5	G381-A	AD, MBP	B7042
M20 x 1.5	3 11/16	93.7	5 5/8	142.9	G324-A	PS	BF7907
M20 x 1.5	3 11/16	93.7	6 23/32	170.7	G401, [1] Included	PS	BF7957
M20 x 1.5	3 11/16	93.7	7 1/8	181.0	G381-A		BF7813
M20 x 1.5	3 11/16	93.7	7 7/32	183.4	G401, [1] Included	PSR	BF7922
M20 x 1.5	3 11/16	93.7	7 7/32	183.4	G401, [1] Included	PS, PSR	BF7940
M20 x 1.5	3 11/16	93.7	7 7/32	183.4	G381-A		BF7966
M20 x 1.5	3 11/16	93.7	7 3/8	187.3	[1] Included		
M20 x 1.5	3 11/16	93.7	7 13/32	188.1	[1] Included	D, PSR, SP	BF1352-SPS
M20 x 1.5	3 23/32	94.5	3 27/32	97.6	G381-A	D	BF1356
M20 x 1.5	3 23/32	94.5	3 7/8	98.4	[1] Included		
M20 x 1.5	3 23/32	94.5	7 3/16	182.9	[1] Included	HBP	B1446
M20 x 1.5	3 23/32	94.5	7 9/32	184.9	[3] O-Rings		
M20 x 1.5	3 23/32	94.5	7 5/16	185.7	Included		
M20 x 1.5	3 23/32	94.5	7 31/32	202.4	G324-A	PS	BF792
M20 x 1.5	3 23/32	94.5	8 3/32	205.6			BF46104
M20 x 1.5	3 3/4	95.3	5 5/16	134.9	G381-A	PS, SP	BF7941
M20 x 1.5	3 25/32	96.0	3 1/4	82.6	G381-A	PS, SP	BF7942
					G401		BF7979
					[1] Included	SHBP	B7163
					[1] Included	AD, HBP	B109
					[1] Included	AD, HBP	B166

SPIN-ON FEATURES

Some spin-ons have no additional features while others have several. Here are some of the more important spin-on features:

Anti-Drainback Valve



As the name implies, this valve keeps the oil from draining from a filter when the engine is shut off. (Some filters include an anti-drainback standpipe for the same function). The mounting direction determines the need for this feature.

By-Pass Valve



Full-flow oil systems require a by-pass (relief) valve either in the system or in the filter. This valve opens at a predetermined setting to assure oil flow to the bearings at all times.

Integral Post Seal



Seals threaded stud to prevent tiny particles from spiraling in via the threads.

We Cannot be Responsible for Misapplications



WARNING: These products can expose you to chemicals, including Diisononyl Phthalate, Carbon black extracts, Nickel, 1,3 Butadiene, Ethylene Oxide, Epichlorohydrin, which are known to the State of California to cause cancer, and Bisphenol-A, Ethylene Glycol, Ethylene Oxide, 1,3 Butadiene, Epichlorohydrin, which are known to the State of California to cause birth defects or other reproductive harm. For more information go to www.P65Warnings.ca.gov.

SPIN-ON FILTERS BY TAP SIZE (METRIC THREAD)

	THREAD I.D.	O.D. Inches	O.D. (mm)	LENGTH Inches	LENGTH (mm)	GASKET	FEATURES	BALDWIN NUMBER
SPIN-ON FILTER FEATURES ARE CODED AS FOLLOWS	M20 x 1.5	3 25/32	96.0	4 11/32	110.3	[1] Included		B7034
	M20 x 1.5	3 27/32	97.6	5 19/32	142.1	[1] O-Ring Attached, [1] Included		BF7842
	M20 x 1.5	4 1/4	108.0	3 3/16	81.0	[1] Included		B201-S
	M20 x 1.5	4 1/4	108.0	4 3/4	120.7	[1] Included	AD, HBP	B7189
	M20 x 1.5	4 1/4	108.0	5 27/32	148.4	[1] Included	HBP	B211
	M20 x 1.5	4 1/4	108.0	5 27/32	148.4	[1] Included		B337
	M20 x 1.5	4 1/4	108.0	5 27/32	148.4	[2] Included, [1] Included	AD, MBP	B7585
	M20 x 1.5	4 1/4	108.0	7 5/8	193.7	[1] Included		B7164
	M20 x 1.5	4 9/32	108.7	4	101.6	[1] Included		B7280
	AD Anti-Drainback Valve	M22 x 1.5	3	76.2	3 1/2	88.9	G449-B	AD, HBP
ADP Anti-Drainback Pipe	M22 x 1.5	3	76.2	3 1/2	88.9	G449-B	AD, HBP	B7422
BP 8-10 PSID By-Pass Valve	M22 x 1.5	3	76.2	3 1/2	88.9	G449-B	AD, BP	B7443
BPI By-Pass Included	M22 x 1.5	3	76.2	4 3/32	104.0	G449-B	AD, HBP	B7449
BPS By-Pass Screen	M22 x 1.5	3	76.2	4 27/32	123.0	G449-B	HBP	B56
BTA PLUS Balanced Treatment Additive Plus	M22 x 1.5	3	76.2	4 27/32	123.0	G449-B	AD, BP	B7444
BTE Balanced Treatment for Ethylene Glycol Antifreeze	M22 x 1.5	3 1/32	77.0	2 25/32	70.6	[1] Included	AD, MBP	B7401
D Drain	M22 x 1.5	3 1/32	77.0	3 1/2	88.9	G449-B	AD, HBP	B1422
FECV Front-End Check Valve	M22 x 1.5	3 1/32	77.0	4 1/16	103.2	[1] Included	AD, MBP	B7033
FP Fill Port	M22 x 1.5	3 3/32	78.6	5 1/2	139.7	[1] Included	PS	BF9910
HBP 18-25 PSID High Pressure By-Pass Valve	M22 x 1.5	3 21/32	93.0	6 7/8	175.0			CV15016
ISO Inside-Out Flow Direction	M22 x 1.5	3 11/16	93.7	2 13/16	71.4	G381-A	AD, SHBP	B7496
LBP 2-7 PSID Low Pressure By-Pass Valve	M22 x 1.5	3 11/16	93.7	3 1/4	82.6	G324-A	AD, HBP	B1156
MBP 11-17 PSID Medium Pressure By-Pass Valve	M22 x 1.5	3 11/16	93.7	3 3/4	95.3	[1] Included	AD, MBP	B7001
MO Metering Orifice	M22 x 1.5	3 11/16	93.7	3 7/8	98.4	G381-A	AD, HBP	B329
PS Integral Post Seal Gasket	M22 x 1.5	3 11/16	93.7	4 3/8	111.1	G381-A	D	BF9893
PSR Post Seal Required; Must install loose O-Ring or D-Ring on Post for Seal	M22 x 1.5	3 11/16	93.7	4 3/8	111.1	G381-A	D	BF9894
RC Reinforced Centertube	M22 x 1.5	3 11/16	93.7	4 3/8	111.1	G381-A	AD, HBP	B40150
SHBP 30-45 PSID Super High Pressure By-Pass Valve	M22 x 1.5	3 11/16	93.7	5 3/8	136.5	G381-A	AD, HBP	B281
SP Sensor Port	M22 x 1.5	3 11/16	93.7	5 3/8	136.5	G381-A	AD, SHBP	B7377
XHBP 50+ PSID Extra High Pressure By-Pass Valve	M22 x 1.5	3 11/16	93.7	5 3/8	136.5	G381-A	AD, ADP, SHBP	B7388
Do NOT Interchange Filters with Different Features	M22 x 1.5	3 11/16	93.7	5 5/8	142.9	G381-A		BF7747
	M22 x 1.5	3 11/16	93.7	6 5/8	168.3	G381-A	AD, ADP, SHBP	B7376
	M22 x 1.5	3 11/16	93.7	7 15/16	201.6	[1] Included, [1] O-Ring	D, SP	BF1289-SP
	M22 x 1.5	3 25/32	96.0	6 11/16	169.9	[1] Included	AD, FECV, SHBP	B7350
	M22 x 1.5	3 7/8	98.4	5 7/32	132.6	[1] Included		BT8919
	M22 x 1.5	4 1/4	108.0	7 19/32	192.9	[1] Included	PS	BF7656
	M22 x 1.5	4 1/4	108.0	9 15/16	252.4	[1] Included	D, PS	BF1256
	M23 x 1.5	3 13/16	96.8	4 5/16	109.5	[1] Included	AD, HBP	BT9318
	M24 x 1.5	3 11/16	93.7	5 13/32	137.3	G401	SHBP	B7306
	M24 x 1.5	3 11/16	93.7	5 9/16	141.3	G401		BF7624
	M24 x 1.5	3 11/16	93.7	5 21/32	143.7	[1] Included		BF7908
	M24 x 1.5	3 11/16	93.7	5 11/16	144.5	G401	AD, SHBP	B7360
	M24 x 1.5	3 11/16	93.7	6 9/16	166.7	[1] Included	PS	BF798
	M24 x 1.5	3 11/16	93.7	6 9/16	166.7	[1] Included	PS	BF7993
	M24 x 1.5	3 11/16	93.7	6 7/8	174.6		D, SP	BF46048
	M24 x 1.5	3 11/16	93.7	7 3/16	182.6	G401	AD, ADP	BF1102
	M24 x 1.5	3 11/16	93.7	8 1/8	206.4	G381-A	AD, HBP	B7378
	M24 x 1.5	3 11/16	93.7	8 1/8	206.4			B40133
	M24 x 1.5	3 23/32	94.5	4 3/16	106.4	[1] Included	SHBP	BT9471
	M24 x 1.5-6H	3 23/32	94.5	8 3/16	208.3			BT40029
	M24 x 1.5	3 3/4	95.3	5 1/4	133.4	[2] Included		BF9923-O
	M24 x 1.5	3 31/32	100.8	4 27/32	123.0	[1] Included	AD, BP	BD7029
	M24 x 2.0	4 1/4	108.0	5 27/32	148.4	G401	AD, HBP	B7179
	M24 x 2.0	2 31/32	75.4	7 15/32	189.7	[1] Included		B40127
	M24 x 2.0	3 21/32	92.9	5 1/8	130.2	[1] Included	HBP, PS	B7451
	M24 x 2.0	3 21/32	92.9	5 5/8	142.9	G381-A		B7026-MPG
	M24 x 2.0	3 11/16	93.7	6 5/32	156.4	G381-A	D	BF7925
	M24 x 2.0	4 1/4	108.0	5 9/32	134.1	[1] Included	HBP	B7477
	M26 x 1.5	3 17/32	89.7	4 15/16	125.4	[1] Included;	MBP	BD7160
	M26 x 1.5	3 11/16	93.7	5 3/8	136.5	[3] O-Rings		
						G381-A	AD, HBP	BD28



WARNING: These products can expose you to chemicals, including Diisononyl Phthalate, Carbon black extracts, Nickel, 1,3 Butadiene, Ethylene Oxide, Epichlorohydrin, which are known to the State of California to cause cancer, and Bisphenol-A, Ethylene Glycol, Ethylene Oxide, 1,3 Butadiene, Epichlorohydrin, which are known to the State of California to cause birth defects or other reproductive harm. For more information go to www.P65Warnings.ca.gov.

SPIN-ON FILTERS BY TAP SIZE (METRIC THREAD)

THREAD I.D.	O.D. Inches	O.D. (mm)	LENGTH Inches	LENGTH (mm)	GASKET	FEATURES	BALDWIN NUMBER
M26 x 1.5	3 11/16	93.7	7 1/8	181.0	G381-A	AD	BD7095
M26 x 1.5	4 1/4	108.0	5 27/32	148.4	G401	HBP	BD7028
M26 x 1.5	4 1/4	108.0	5 27/32	148.4	G401	MBP	B7045
M26 x 1.5	4 1/4	108.0	7 11/32	186.5	[1] Included	ADP, MBP	B7121
M27 x 2.0	3 11/16	93.7	3 7/8	98.4	G381-A	AD, ADP, SHBP	B7499
M27 x 2.0	3 11/16	93.7	6 5/8	168.3	[1] Included		BT7237
M27 x 2.0	3 11/16	93.7	6 5/8	168.3	G381-A	AD	B7327
M27 x 2.0	3 23/32	94.5	3 7/8	98.4	G381-A		B7328
M27 x 2.0	3 23/32	94.5	5 3/8	136.5	[1] Included	HBP	B40056
M27 x 2.0	4	101.6	6 7/8	174.6	[1] Included		B40050
M30 x 1.5	4 1/4	108.0	5 5/8	142.9	[1] Included	SHBP	BT221
M30 x 1.5	4 1/4	108.0	7 9/16	192.1	[1] Included	HBP	B7142
M30 x 1.5	4 1/4	108.0	7 19/32	192.9	[1] Included	PS	BF7773
M30 x 1.5	4 1/4	108.0	8 11/32	211.9	[1] Included	D, PS	BF1286
M30 x 1.5	4 1/4	108.0	10 7/16	265.1	[1] Included	PS	BF7657
M30 x 1.5	4 9/32	108.7	6 1/4	158.8	[1] Included	AD, HBP	B7393
M30 x 2.0	4 1/4	108.0	7 13/32	188.1	[1] Included	SHBP	B7116
M30 x 2.0	4 1/4	108.0	7 11/16	195.3	[1] Included	SHBP	B7383
M30 x 2.0	4 1/4	108.0	8 7/16	214.3	[1] Included	SHBP	BD325
M30 x 2.0	4 1/4	108.0	9 1/8	231.8	[1] Included	AD, HBP	BT472
M30 x 2.0	4 1/4	108.0	9 1/8	231.8	[1] Included	AD, FECV, SHBP	B7171
M30 x 2.0	4 1/4	108.0	9 1/8	231.8	[1] Included		B7174-MPG
M30 x 2.0	4 5/16	109.5	10 3/8	263.5	[2] Included	AD, HBP	BD7168
M32 x 1.5	4 1/4	108.0	8 25/32	223.0	[1] Included	HBP, PS	BD7158
M32 x 1.5	4 1/4	108.0	10 15/32	265.9	[1] Included		BF7814
M32 x 1.5	4 1/4	108.0	10 15/32	265.9	[1] Included		BF7943
M32 x 1.5	4 1/4	108.0	10 15/32	265.9	[1] Included	PS	BF9800
M32 x 1.5	4 1/4	108.0	10 15/32	265.9	[1] Included		BF9802
M32 x 1.5	4 1/4	108.0	10 15/32	265.9	[1] Included		BF46034
M32 x 1.5	4 1/4	108.0	10 15/32	265.9	[1] Included		BF46161
M32 x 1.5	4 9/32	108.7	10 11/32	262.7	[1] Included		BF9817
M32 x 1.5	4 11/32	110.0	6 9/16	166.9			BF46131
M32 x 1.5	4 11/32	110.3	8 7/8	225.4	[1] Attached,		
					[1] Included		BF46117
							BF46233
M32 x 1.5	4 1/4	108.2	10 15/32	265.9			
M36 x 1.5	5 1/8	130.2	8 21/32	219.9	[1] Included	PS	BD1403
M36 x 1.5	5 11/32	135.7	12 7/32	310.4	[1] Included	SHBP	B40013
M36 x 1.5	5 3/8	136.5	12 3/32	307.2	[1] Included	SHBP	B7030
M36 x 1.5	5 3/8	136.5	12 3/32	307.2	[1] I. Gskt	BPS, SHBP	B7229
M36 x 2.0	3 3/4	95.3	5 13/32	137.3	[1] Included	BTA PLUS	BW5086
M36 x 2.0	3 3/4	95.3	5 15/32	138.9	[1] Included		B5087
M38 x 2.0	3 11/16	93.7	5 9/16	141.3	[1] Included		BT8304
M39 x 1.5	5 3/8	136.5	6 9/16	166.7	[1] Included;		BA5379
					[1] O-Ring		
M39 x 1.5 LH	5 3/8	136.5	6 9/16	166.7	[1] Included;		BA5566
					[1] O-Ring		
M39 x 1.5	5 3/8	136.5	12 1/8	308.0	[1] Included	PS	BF7996
M39 x 1.5	5 1/2	139.7	6 9/16	166.7	[1] Included;		BA5374
					[1] O-Ring		
M39 x 1.5	5 1/2	139.7	6 9/16	166.7	[1] Included;		BA5592
					[1] O-Ring		
M40 x 2.0	4 3/16	106.4	7 1/16	179.4	[1] Included		BT8920
M41 x 1.5	5 7/16	138.1	6 9/16	166.7	[2] Included		BA5284
M41 x 1.5	5 1/2	139.7	5 15/32	138.9	[1] I. Gasket,		BA5376
					[1] O-Ring Included		
M42 x 2.0	5 3/8	136.5	8 5/8	219.1	[1] Included	BP, BPS	BT9387
M42 x 2.0	5 3/8	136.5	8 7/8	225.4	[1] Included	SHBP	B7161
M42 x 2.0	5 3/8	136.5	12 3/8	314.3	[1] Included	SHBP	B7162
M42 x 2.0	5 3/8	136.5	12 3/8	314.3	[1] Included	SHBP	B7224
M42 x 2.0	5 13/32	137.3	7 1/8	181.0	[1] Included		BT9164
M42 x 2.0-6G	5 7/16	138.1	3 15/16	100.0	[1] Included		BT23537

CAUTION!!! Read These Instructions Before Using Size Charts

The filter size charts on this and following pages are for filter experts. Careless use could lead to errors. When you have exhausted all other ways to determine a filter number, locate a suspect here, then check the Product Guide for confirmation.

Size alone does not assure you of the right filtering media, gasket or other features. What is being filtered, filter efficiency, flow rate and direction of flow all have to be considered.

Spin-on filters are listed by tap size rather than length. All other filters are listed on an overall basis. Check your Product Guide for other dimensions. Progression is from the smallest to the largest in each category.

Do NOT Interchange Filters with Different Features

Be Sure to Check Product Guide, Cross-References and Applications

We Cannot be Responsible for Misapplications



WARNING: These products can expose you to chemicals, including Diisononyl Phthalate, Carbon black extracts, Nickel, 1,3 Butadiene, Ethylene Oxide, Epichlorohydrin, which are known to the State of California to cause cancer, and Bisphenol-A, Ethylene Glycol, Ethylene Oxide, 1,3 Butadiene, Epichlorohydrin, which are known to the State of California to cause birth defects or other reproductive harm. For more information go to www.P65Warnings.ca.gov.

SPIN-ON FILTERS BY TAP SIZE (METRIC THREAD)

THREAD I.D.	O.D. Inches	O.D. (mm)	LENGTH Inches	LENGTH (mm)	GASKET	FEATURES	BALDWIN NUMBER
M45 x 1.5	3 9/32	83.1	6 1/8	155.4			BT23604
M45 x 1.5	5 3/8	136.5	9 5/8	244.5	[1] Included	SHBP	B7314
M45 x 1.5	5 3/8	136.5	12 3/32	307.2	[1] Included		B7135
M45 x 1.5	5 3/8	136.5	12 3/32	307.2	[1] Included		B7175
M45 x 2.0	3 7/16	87.3	6 1/16	154.0	[2] Included		BT9464
M45 x 2.0-6H	3 7/16	87.3	6 17/32	165.9			BT23607-MPG
M45 x 2.0	5 7/16	138.1	6 15/16	176.2			BT9533
M48 x 2.0	5 9/32	134.1	6 27/32	173.8	[1] Included	Retainer Ring	BT8906
M48 x 2.0	5 9/32	134.1	11 15/32	291.3	[2] Included		BT9377
M52 x 1.5	4 21/32	118.3	11 13/32	289.7	G293-B		BD7310
M52 x 1.5-6H	4 11/16	119.1	11 25/32	299.2	[2] Attached		BD40027
M60 x 1.5	3 31/32	100.8	7 1/4	184.2	[1] Included		BT8914
M60 x 2.0	4 5/32	105.6	10 3/8	263.5	[1] Included		BT9454
M60 x 3.0	5 15/32	138.9	6 3/4	171.5	[1] Included	MBP	B7097
M67 x 4.0	4	101.6	6 7/32	157.7			B40051
M68 x 2.0	3 7/16	87.3	6 13/32	162.7			BT9440
M72 x 2.0	3 23/32	94.5	9 5/32	232.6	[1] Included		BF7766
M72 x 2.0	3 7/8	98.4	9 3/16	233.4	[2] Included		BT9368-MPG
M82 x 1.5	4 1/4	108.0	7 7/8	199.9			BF46234
M85 x 2.0	4 21/32	118.3	11 5/8	295.3	[2] Included	D, PSR, SP	BF1274-SP
M85 x 2.0	4 21/32	118.3	11 5/8	295.3	[1] Included	D, PSR, SP	BF1274-SPS
M85 x 2.0	4 21/32	118.3	11 5/8	295.3	[2] Included	D, PSR, SP	BF1277-SP
M85 x 2.0	4 21/32	118.3	11 5/8	295.3	[1] Included	D, PSR, SP	BF1277-SPS
M85 x 2.0	4 11/16	119.1	11 1/8	282.6	[1] Included		BF9920
M90 x 2.0	4 23/32	119.9	7 11/16	195.3	[1] Included		BT8503-MPG
M90 x 2.0	4 23/32	119.9	8 27/32	224.6	[1] Included		BF9885
M90 x 2.0	4 23/32	119.9	8 27/32	224.6	[2] Attached		BF46129
M90 x 2.0	4 23/32	119.9	8 29/32	226.2	[1] Included		BT9369-MPG
M90 x 2.0	4 23/32	119.9	11 9/16	293.7	[1] Included		BF9860
M90 x 2.0	4 23/32	119.9	11 9/16	293.7			BF46179
M90 x 2.0	4 23/32	119.9	11 5/8	295.3	[1] Included		BD7176
M90 x 2.0	4 23/32	119.9	11 23/32	297.7	[1] Included		BT9347-MPG
M90 x 2.0	4 23/32	119.9	11 29/32	302.4	[1] Included		BT9367-MPG
M90 x 2.0-7H	4 23/32	119.9	11 9/16	293.7	[2] Included		BT23543-MPG
M90 x 2.0	4 23/32	119.9	11 9/16	293.7			BF46248
M92 x 2.0	4 21/32	118.3	10 11/32	262.7	[1] Included;		
M92 x 2.5	3 29/32	99.2	5 15/16	150.8	[2] O-Rings		BD7252
M92 x 2.5	4	101.6	5 7/8	149.1	[1] Included		B7322
M94 x 3.0	3 27/32	97.5	5 5/16	134.9			B40063
M94 x 3.0 Butress	3 27/32	97.5	5 17/32	140.7			BF46157
M94 x 3.0 Butress	3 27/32	97.5	5 17/32	140.7			BF46159
M94 x 3.0 Butress	3 27/32	97.5	6 1/2	164.8			BF46158
M94 x 3.0 Butress	3 27/32	97.5	6 23/32	170.4			BF46068
M94 x 3.0 Butress	3 27/32	97.5	6 23/32	170.4			BF46156
M95 x 2.0	4 21/32	118.3	14 7/32	361.2	[1] Included;		
M95 x 2.5	4 21/32	118.3	11 25/32	299.2	[2] Viton O-Rings		BD7250
M95 x 2.5	4 21/32	118.3	14 7/32	361.2	[1] Included	Venturi-Type Cone	BD7154
M95 x 2.5	4 11/16	119.1	11 25/32	299.2	[1] Included	Venturi-Type Cone	BD7153
M95 x 2.5	4 11/16	119.1	11 25/32	299.2	[1] Vamac	Venturi-Type Cone	BD7509
M95 x 2.5	4 11/16	119.1	11 25/32	299.2	Included		BD7509
M95 x 2.5	4 11/16	119.1	11 25/32	299.2			B40145



WARNING: These products can expose you to chemicals, including Diisononyl Phthalate, Carbon black extracts, Nickel, 1,3 Butadiene, Ethylene Oxide, Epichlorohydrin, which are known to the State of California to cause cancer, and Bisphenol-A, Ethylene Glycol, Ethylene Oxide, 1,3 Butadiene, Epichlorohydrin, which are known to the State of California to cause birth defects or other reproductive harm. For more information go to www.P65Warnings.ca.gov.

SPIN-ON FILTERS BY TAP SIZE (METRIC THREAD)

THREAD I.D.	O.D. Inches	O.D. (mm)	LENGTH Inches	LENGTH (mm)	GASKET	FEATURES	BALDWIN NUMBER
M95 x 2.5-6H	4 11/16.....	119.1	11 25/32.....	299.2	[1] Included.....		BD50000
M95 x 2.5	4 23/32.....	119.6	11 25/32.....	299.5			BD40139
M110 X 2.5	5 3/8.....	136.7	12 3/32.....	307.0			BF46256
M120 x 2.0	5 3/32.....	129.4	11.....	279.4	[1] Attached; [1] O-Ring		BT9360



WARNING: These products can expose you to chemicals, including Diisononyl Phthalate, Carbon black extracts, Nickel, 1,3 Butadiene, Ethylene Oxide, Epichlorohydrin, which are known to the State of California to cause cancer, and Bisphenol-A, Ethylene Glycol, Ethylene Oxide, 1,3 Butadiene, Epichlorohydrin, which are known to the State of California to cause birth defects or other reproductive harm. For more information go to www.P65Warnings.ca.gov.

LIQUID ELEMENTS BY LENGTH

All Measurements in Inches and (Millimeters)

NOTE: All liquid element filters have been sorted by length and then outside diameter.
The larger outside and inside diameters have been listed.

LENGTH Inches	LENGTH (mm)	O.D. Inches	O.D. (mm)	I.D. Inches	I.D. (mm)	BALDWIN NUMBER	LENGTH Inches	LENGTH (mm)	O.D. Inches	O.D. (mm)	I.D. Inches	I.D. (mm)	BALDWIN NUMBER
25/32	19.8	5/8	15.9	7/32	5.6	SF898	2 7/32	56.4	1 1/8	28.6	5/8	15.9	PF7818
15/16	23.8	1 7/32	31.0	1 1/16	27.0	PF7882	2 7/32	56.4	2 15/16	74.6	5/8	15.9	PF861
							2 7/32	56.4	3 1/32	77.0	1 19/32	40.5	BT8386
1 1/32	26.2	11/16	17.5	9/32	7.1	PF893	2 1/4	57.2	2 3/8	60.3	1 3/32	27.8	P7454
1 1/32	26.2	11/16	17.5	9/32	7.1	PF893-RV	2 1/4	57.2	3 1/32	77.0	7/8	22.2	P148
1 1/16	27.0	1 3/4	44.4	15/32	11.9	PF857	2 9/32	57.9	1 1/8	28.6	17/32	13.5	PF7545
1 1/4	31.8	1 7/32	31.0	17/32	13.5	PT23145	2 9/32	57.9	2 5/32	54.8	1/2	12.7	P40090
1 1/4	31.8	2	50.8	1 5/8	41.3	S423	2 5/16	58.7	4 7/32	107.2	1 11/16	42.9	101
1 1/4	31.8	2 3/4	69.9	1 25/32	45.2	PT23574-MPG	2 5/16	58.7	4 7/32	107.2	1 11/16	42.9	101-30
1 5/16	33.3	1 3/8	34.9	15/32	11.9	PF864	2 5/16	58.7	4 7/32	107.2	1 11/16	42.9	101-W
1 3/8	34.9	1 1/2	38.1	1 1/8	28.6	S455	2 11/32	59.5	2 19/32	65.9	3/4	19.0	PF7817
1 3/8	34.9	2 7/16	61.9	1 3/16	30.2	PT9481-MPG	2 3/8	60.3	2 3/16	55.6	1/8	3.2	P40091
1 3/8	34.9	3 15/16	100.0	1 1/16	27.0	PT548	2 3/8	60.3	2 3/16	55.6	21/32	16.7	P40089
1 13/32	35.7	1 19/32	40.5	31/32	24.6	PF7824	2 7/16	61.9	3 9/16	90.5	1 11/32	34.1	PF255
1 7/16	36.5	1 9/16	39.7	15/32	11.9	P9603	2 15/32	62.7	1 7/8	47.6	23/32	18.3	PF224
1 7/16	36.5	1 31/32	50.0	15/32	11.9	P7132	2 15/32	62.7	2 5/32	54.8	29/32	23.8	PF7836
1 15/32	37.3	2 1/4	57.2	27/32	21.4	PF847	2 1/2	63.5	3 17/32	89.7	1 1/8	28.6	P186
1 1/2	38.1	2 3/4	69.9	9/16	14.3	PF314	2 17/32	64.3	1 7/32	31.0	15/32	11.9	P7260
1 17/32	38.9	2 7/8	73.0	1 1/16	27.0	PT214(2)	2 17/32	64.3	1 17/32	38.9	15/32	11.9	P7303
1 9/16	39.7	2 15/32	62.7	1 1/16	27.0	P450	2 17/32	64.3	1 21/32	42.1	1/2	12.7	P7259
1 9/16	39.7	3 3/16	81.0	1 1/16	27.0	P183	2 17/32	64.3	2 15/32	62.7	13/32	10.3	PF7550
1 19/32	40.5	3	76.2	25/32	19.8	P40085	2 17/32	64.3	4 5/8	117.5	2 7/8	73.0	PT558
1 5/8	40.9	1 13/32	35.8	1	25.4	PF46241	2 9/16	65.1	2 3/32	53.1	25/32	20.1	PF46142
1 5/8	41.3	1 31/32	50.0	1 19/32	40.5	PF7939	2 9/16	65.1	2 1/2	63.5	1 3/8	34.9	P40014
1 5/8	41.3	1 31/32	50.0	1 19/32	40.5	PF7974	2 9/16	65.1	2 3/4	69.9	9/16	14.3	PF506
1 23/32	43.7	1 3/4	44.4	17/32	13.5	P40132	2 9/16	65.1	2 7/8	73.0	21/32	16.7	PF945
1 23/32	43.7	2 29/32	73.8	23/32	18.3	61	2 9/16	65.1	3 3/16	81.0	1 1/16	27.0	P144
1 23/32	43.7	2 29/32	73.8	23/32	18.3	61-W	2 9/16	65.1	5	127.0	2 29/32	73.8	PT534
1 3/4	44.4	1 3/8	34.9	15/32	11.9	PF7822	2 19/32	65.9	1 7/8	47.6	13/16	20.6	PF9862
1 3/4	44.4	1 3/8	34.9	1/2	12.7	PF7873	2 5/8	66.7	2 1/8	54.0	25/32	19.8	PT23031-MPG
1 3/4	44.4	5	127.0	3 9/32	83.3	PF7627	2 5/8	66.7	2 1/8	54.0	7/8	22.2	PT23528-MPG
1 25/32	45.2	1 11/16	42.9	15/32	11.9	PF7549	2 5/8	66.7	2 3/8	60.3	11/16	17.5	PF46009
1 25/32	45.2	2 5/8	66.7	25/32	19.8	P40086	2 5/8	66.7	2 9/16	65.1	1/2	12.7	PF986
1 13/16	46.0	7/8	22.2	3/8	9.5	PF7819	2 5/8	66.7	2 3/4	69.9	1 3/32	27.8	PF7398
1 13/16	46.0	1 1/2	38.1	1/2	12.7	P40130	2 21/32	67.5	2 1/32	51.6	1/2	12.7	PF7833
1 13/16	46.0	2 1/4	57.2	1 7/8	47.6	S451	2 11/16	68.3	3 1/4	82.6	5/16	7.9	BC40007
1 13/16	46.0	2 15/16	74.6	1/2	12.7	66	2 23/32	69.1	1 3/8	34.9	1/2	12.7	PF937
1 13/16	46.0	2 15/16	74.6	1/2	12.7	66-30	2 23/32	69.1	2 1/8	54.0	1 1/8	28.6	PT23032-MPG
1 13/16	46.0	2 15/16	74.6	1/2	12.7	66-W	2 23/32	69.1	2 5/32	54.8	11/16	17.5	PT8998-MPG
1 27/32	46.8	1 1/2	38.1	17/32	13.5	P40002	2 23/32	69.1	2 3/16	55.6	1 1/8	28.6	PT8975-MPG
1 27/32	46.8	2 11/16	68.3	13/16	20.6	P9602	2 23/32	69.1	2 9/16	65.1	2 9/32	27.8	P7450
1 7/8	47.6	1 3/8	34.9	9/16	14.3	PF859	2 23/32	69.1	3 3/8	85.7	1 1/8	28.6	PT9354-MPG
1 7/8	47.6	1 1/2	38.1	1/2	12.7	P40131	2 23/32	69.1	3 3/8	85.7	2	50.8	PT9449
1 15/16	49.2	1 3/8	34.9	7/16	11.1	PF7975	2 3/4	69.9	1 3/8	34.9	15/32	11.9	PF7830
1 15/16	49.2	1 7/16	36.5	15/32	11.9	PF9873	2 3/4	69.9	2 1/8	54.0	29/32	23.8	PT23088-MPG
							2 3/4	69.9	2 29/32	73.8	11/16	17.5	P140
2 1/32	51.6	11/16	17.5	9/32	7.1	PF894	2 3/4	69.9	3 7/32	81.8	5/8	15.9	PF598
2 1/32	51.6	11/16	17.5	9/32	7.1	PF894-RV	2 3/4	69.9	3 7/32	81.8	5/8	15.9	PF598-10
2 1/32	51.6	1 3/8	34.9	15/32	11.9	PF7869	2 3/4	69.9	3 7/32	81.8	5/8	15.9	PF598-30
2 1/32	51.6	2 1/32	51.6	1 15/32	37.3	PT9426	2 3/4	69.9	3 5/16	84.1	13/16	20.6	PF838
2 1/16	52.4	1 5/8	41.3	9/16	14.3	PF7874	2 25/32	70.6	1 3/8	34.9	7/16	11.1	PF46077
2 1/16	52.4	1 21/32	42.1	27/32	21.4	PT9424	2 25/32	70.6	2 1/32	51.6	29/32	23.0	P7256
2 1/16	52.4	1 31/32	50.0	9/16	14.3	PF7875	2 25/32	70.6	3 15/32	88.1	1 15/32	37.3	PT903
2 1/16	52.4	2 3/32	53.2	23/32	18.3	PT459	2 25/32	70.6	3 15/32	88.1	1 15/32	37.3	PT951
2 3/32	53.2	2 9/16	65.1	9/16	14.3	PF7596	2 13/16	71.4	2 1/4	57.2	29/32	23.8	PT23087-MPG
2 1/8	54.0	1 13/16	46.0	1/32	0.8	PF9911	2 13/16	71.4	2 5/16	58.9	23/32	18.0	PT23629
2 1/8	54.0	1 31/32	50.0	29/32	23.0	P540	2 13/16	71.4	2 3/8	60.3	29/32	23.8	PT23193-MPG
2 1/8	54.0	2 7/8	73.0	17/32	13.5	PF860	2 27/32	72.2	1 11/16	42.9	1 13/32	35.7	PF7994
2 5/32	54.8	2 1/16	52.3	27/32	21.4	P40101	2 27/32	72.2	1 3/4	44.4	15/32	11.9	PF599
2 5/32	54.8	2 27/32	72.2	11/32	8.7	PT23314	2 27/32	72.2	1 3/4	44.4	15/32	11.9	PF599-10
2 5/32	54.8	3 1/32	77.0	25/32	19.8	P40093	2 27/32	72.2	3 5/32	80.3	9/16	13.9	PF46138
2 3/16	55.6	1 23/32	43.7	17/32	13.5	P7490	2 27/32	72.2	5 9/32	134.1	3 19/32	91.3	PT23587
2 3/16	55.6	2 27/32	72.2	1 25/32	45.2	PT9228	2 7/8	73.0	29/32	23.0	13/32	10.3	P7263



WARNING: These products can expose you to chemicals, including Diisononyl Phthalate, Carbon black extracts, Nickel, 1,3 Butadiene, Ethylene Oxide, Epichlorohydrin, which are known to the State of California to cause cancer, and Bisphenol-A, Ethylene Glycol, Ethylene Oxide, 1,3 Butadiene, Epichlorohydrin, which are known to the State of California to cause birth defects or other reproductive harm. For more information go to www.P65Warnings.ca.gov.

LIQUID ELEMENTS BY LENGTH

LENGTH Inches	LENGTH (mm)	O.D. Inches	O.D. (mm)	I.D. Inches	I.D. (mm)	BALDWIN NUMBER	LENGTH Inches	LENGTH (mm)	O.D. Inches	O.D. (mm)	I.D. Inches	I.D. (mm)	BALDWIN NUMBER
2 7/8	73.0	2 1/16	52.4	31/32	24.6	PT9142	3 1/2	88.9	1 3/8	34.9	1/2	12.7	PF981
2 7/8	73.0	2 9/16	65.1	31/32	24.6	P7313	3 1/2	88.9	1 3/8	34.9	1 1/4	31.8	PT23036-MPG
2 7/8	73.0	3 3/4	95.3	1 5/16	33.3	P190	3 1/2	88.9	1 1/2	38.1	1 1/8	28.6	S485
2 31/32	75.4	2 1/16	52.4	29/32	23.0	PT9240	3 1/2	88.9	1 21/32	42.1	5/8	15.9	PT23573-MPG
2 31/32	75.4	2 9/16	65.1	11/16	17.5	PF866	3 1/2	88.9	1 21/32	42.1	27/32	21.4	PT9462
3	76.2	1 1/8	28.6	3/16	4.8	PF7820	3 1/2	88.9	1 21/32	42.1	7/8	22.2	PT257
3	76.2	1 31/32	50.0	15/16	23.8	PT9179	3 1/2	88.9	1 31/32	50.0	25/32	19.8	PF717
3	76.2	2	50.8	15/16	23.8	PT23097-MPG	3 1/2	88.9	2 1/2	63.5	1 11/16	42.9	PT9516
3	76.2	2 1/4	57.2	13/32	10.3	PF935	3 1/2	88.9	2 25/32	70.6	1 3/32	27.8	PT9289-MPG
3	76.2	2 17/32	64.3	1/2	12.7	PF9823	3 17/32	89.7	1 5/8	41.3	27/32	21.4	PT9208
3	76.2	2 23/32	69.1	31/32	24.6	PE5270	3 17/32	89.7	3 3/16	81.0	1 31/32	50.0	P40081
3	76.2	2 3/4	69.9	7/16	11.1	P7178	3 9/16	90.5	2 15/32	62.7	1 1/16	27.0	P454
3	76.2	2 7/8	73.0	1 1/16	27.0	P187	3 9/16	90.5	2 15/32	62.7	1 3/32	27.8	P446
3	76.2	5	127.0	2 13/16	71.4	PT565	3 9/16	90.5	2 15/32	62.7	1 3/32	27.8	P7134
3	76.2	5	127.0	2 15/16	74.6	PT379 KIT	3 9/16	90.5	2 7/8	73.0	15/32	11.9	P7103
3	76.2	5 3/32	129.4	2 9/16	65.1	PT8907-MPG	3 9/16	90.5	3 27/32	97.6	9/16	14.3	PF7698
3 1/32	77.0	3 5/16	84.1	11/32	8.7	PF46088	3 9/16	90.5	6 7/32	158.0	2 17/32	64.3	PT23526
3 1/16	77.8	2 7/8	73.0	15/16	23.8	PF816-S	3 19/32	91.3	1 5/8	41.3	29/32	23.0	PT9209
3 3/32	78.6	1 31/32	50.0	27/32	21.4	PT8341	3 19/32	91.3	2 5/32	54.8	29/32	23.0	PF997
3 3/32	78.6	2 7/16	61.9	1 7/32	31.0	P1440	3 19/32	91.3	2 3/4	69.9	1 3/32	27.8	PT9239
3 1/8	79.4	23/32	18.3	5/8	15.9	PF9907	3 5/8	92.1	1 1/4	31.8	3/8	9.5	PT23086-MPG
3 1/8	79.4	1 5/8	41.3	5/8	15.9	PT23055-MPG	3 5/8	92.1	1 21/32	42.1	29/32	23.0	PT23319
3 1/8	79.4	1 13/16	46.0	15/16	23.8	PT23096-MPG	3 5/8	92.1	2 7/16	61.9	1 3/8	34.9	P7442
3 1/8	79.4	1 31/32	50.0	25/32	19.8	PF7832	3 5/8	92.1	2 3/4	69.9	1 3/32	27.8	PT9180
3 1/8	79.4	2 7/8	73.0	1 5/8	41.3	P7438	3 5/8	92.1	2 7/8	73.0	1 1/8	28.6	PT728-MPG
3 1/8	79.4	2 7/8	73.0	1 5/8	41.3	P40113	3 5/8	92.1	3	76.2	1 1/16	27.0	PF906
3 1/8	79.4	2 15/16	74.6	1 1/4	31.8	PF816	3 21/32	92.9	1 3/8	34.9	15/32	11.9	PT23367-MPG
3 1/8	79.4	3 3/4	95.3	1 1/2	38.1	PF7852 KIT	3 21/32	92.9	1 3/8	34.9	1/2	12.7	PT8960-MPG
3 5/32	80.2	1 1/16	27.0	5/8	15.9	PT283	3 21/32	92.9	1 29/32	48.5	1/2	12.7	PT23377-MPG
3 5/32	80.2	1 3/32	27.8	11/32	8.7	PT23571-MPG	3 21/32	92.9	1 3/8	34.9	15/16	23.8	P40156
3 5/32	80.2	1 11/16	42.7	19/32	15.2	PE17002 KIT	3 11/16	93.7	1 3/8	34.9	1/2	12.7	PT9337-MPG
3 5/32	80.2	2 3/4	69.9	1 5/32	29.4	PT23017	3 11/16	93.7	1 27/32	46.8	1	25.4	PT8952-MPG
3 5/32	80.2	2 7/8	73.0	27/32	21.4	P240	3 11/16	93.7	1 27/32	46.8	1	25.4	PT23387-MPG
3 5/32	80.2	2 7/8	73.0	1 1/32	26.2	P7338	3 11/16	93.7	1 27/32	46.8	1 1/32	26.2	PT9255
3 3/16	81.0	2 13/16	71.4	1 3/32	27.8	P7408	3 11/16	93.7	3 19/32	91.3	1 15/32	37.3	PT7455
3 7/32	81.8	2 3/4	69.9	1 3/32	27.8	P7418	3 11/16	93.7	3 23/32	94.5	1 1/32	26.2	PF9803
3 7/32	81.8	4 5/8	117.6	2 7/8	72.9	PT23633	3 23/32	94.5	1 3/4	44.3	13/16	20.3	PE17000
3 9/32	83.1	2 9/16	65.0	1	25.7	P40143	3 23/32	94.5	1 27/32	46.8	1	25.4	PT23058-MPG
3 9/32	83.3	2 9/16	65.1	31/32	24.6	P9605	3 3/4	95.3	1 7/8	47.6	1	25.4	PT23384-MPG
3 9/32	83.3	3	76.2			BT40038	3 3/4	95.3	2 7/16	61.9	1 1/2	38.1	PT23337
3 5/16	84.1	1 27/32	46.8	7/8	22.2	PT8894-MPG	3 3/4	95.3	2 3/4	69.9			PT9193
3 5/16	84.1	1 27/32	46.8	7/8	22.2	PT8962-MPG	3 3/4	95.3	2 13/16	71.4	1 7/32	31.0	P7413
3 5/16	84.1	1 27/32	46.8	7/8	22.2	PT23037-MPG	3 25/32	95.8	4 17/32	115.1	2 1/4	57.2	P206
3 5/16	84.1	1 27/32	46.8	7/8	22.2	PT23374-MPG	3 25/32	96.0	7 7/8	199.9	3 27/32	97.8	PT23625
3 5/16	84.1	1 27/32	46.8	7/8	22.2	PT23379-MPG	3 25/32	96.0	1 31/32	50.0	13/32	10.3	PF7823
3 5/16	84.1	1 27/32	46.8	7/8	22.2	PT23494-MPG	3 25/32	96.0	2 1/2	63.5			S40071
3 5/16	84.1	2 7/8	73.0	9/16	14.3	PF313	3 13/16	96.8	1 3/4	44.4	3/4	19.0	PT23107-MPG
3 5/16	84.1	2 7/8	73.0	1 5/16	33.3	PF820-S	3 13/16	96.8	2 1/8	54.0	23/32	18.3	P1433
3 5/16	84.1	4	101.6	1 5/8	41.3	PF46186	3 13/16	96.8	3 3/32	78.6	9/16	14.3	PF936
3 11/32	84.9	1 25/32	45.2	1 1/32	26.2	PT8995-MPG	3 13/16	96.8	3 3/4	95.3	1 5/16	33.3	P15
3 11/32	84.9	2 3/32	53.2	1 3/32	27.8	PT9478-MPG	3 7/8	98.4	2 7/8	73.0	1 7/16	36.5	PF7916
3 11/32	84.9	2 3/4	69.9	1 5/32	29.4	PT23478	3 7/8	98.4	3 21/32	92.9	1 23/32	43.7	PF1587
3 11/32	84.9	2 3/4	69.9	1 5/32	29.4	PT23500-MPG	3 7/8	98.4	3 3/4	95.3	1 1/16	27.0	PF9890
3 3/8	85.7	1 11/16	42.9	1 1/32	26.2	PE5272	3 7/8	98.4	3 3/4	95.3	1 3/32	27.8	PF9897
3 3/8	85.7	1 13/16	46.0	3/8	9.5	PF7247	3 29/32	99.2	2 27/32	72.2	1 11/32	34.1	P1566
3 3/8	85.7	2 3/4	69.9	13/16	20.6	PF46112	3 29/32	99.2	2 29/32	73.8	1 1/4	31.8	PT23489-MPG
3 13/32	86.5	1 3/16	30.2	5/8	15.9	PF7877	3 29/32	99.2	3 21/32	92.9	1 23/32	43.7	P1575
3 13/32	86.5	1 25/32	45.2	15/16	23.8	PT9310-MPG	3 29/32	99.2	3 11/16	93.7	1 29/32	48.4	PT23197-MPG
3 7/16	87.3	1 1/8	28.6	1/2	12.7	PF872	3 29/32	99.2	3 11/16	93.7	1 29/32	48.4	PT23490-MPG
3 7/16	87.3	1 21/32	42.1	27/32	21.4	PT8392	3 29/32	99.2	4 5/16	109.5	13/16	20.6	PF7889
3 7/16	87.3	1 21/32	42.1	27/32	21.4	PT9537-MPG	3 29/32	99.2	4 5/16	109.5	13/16	20.6	PF7889-10
3 7/16	87.3	2 13/16	71.4	1 7/32	31.0	P40119	3 29/32	99.2	4 5/16	109.5	13/16	20.6	PF7889-30
3 15/32	88.1	1 21/32	42.1	29/32	23.0	PT8372	3 29/32	99.2	4 5/16	109.5	21/32	16.7	PT23073-MPG
3 15/32	88.1	2 1/16	52.4	7/16	11.1	PF827	3 15/16	100.0	1 3/8	34.9	1	25.4	PT9477
3 15/32	88.1	2 7/16	61.9	1 3/32	27.8	P40116	3 15/16	100.0	1 3/4	44.4	7/16	11.1	PE5271
3 15/32	88.1	2 7/8	73.0	1 5/16	33.3	P176	3 15/16	100.0	2 5/8	66.7	1/2	12.7	P40058
							3 31/32	100.8	2 1/4	57.2	1 1/16	27.0	PF818



WARNING: These products can expose you to chemicals, including Diisononyl Phthalate, Carbon black extracts, Nickel, 1,3 Butadiene, Ethylene Oxide, Epichlorohydrin, which are known to the State of California to cause cancer, and Bisphenol-A, Ethylene Glycol, Ethylene Oxide, 1,3 Butadiene, Epichlorohydrin, which are known to the State of California to cause birth defects or other reproductive harm. For more information go to www.P65Warnings.ca.gov.

LIQUID ELEMENTS BY LENGTH

LENGTH Inches	LENGTH (mm)	O.D. Inches	O.D. (mm)	I.D. Inches	I.D. (mm)	BALDWIN NUMBER	LENGTH Inches	LENGTH (mm)	O.D. Inches	O.D. (mm)	I.D. Inches	I.D. (mm)	BALDWIN NUMBER
3 31/32	100.8	2 5/16	58.7	11/16	17.5	P106	4 3/16	106.4	3 15/32	88.1	13/16	20.6	P73
3 31/32	100.8	2 5/16	58.7	11/16	17.5	P106-HD	4 3/16	106.4	4 3/4	120.7	1 9/16	39.7	P528
3 31/32	100.8	2 9/16	65.1	1 3/32	27.8	P40024	4 3/16	106.4	6	152.4	3 1/2	88.9	PT208
3 31/32	100.8	2 3/4	69.9	1 5/8	41.3	PT9178	4 7/32	107.2	2 9/16	65.1	1 1/16	27.0	P7364
3 31/32	100.8	2 7/8	73.0	13/16	20.6	PT48	4 7/32	107.2	2 7/8	73.0	19/32	15.1	PF7551
3 31/32	100.8	4 1/32	102.4	—	—	PF46250	4 7/32	107.2	2 7/8	73.0	1	25.4	PF802
3 31/32	100.8	4 3/8	111.1	2 7/16	61.9	PT9420-MPG	4 7/32	107.2	3 5/32	80.2	1 1/8	28.6	PT23219-MPG
4	101.6	1 15/16	49.2	13/16	20.6	PT23105-MPG	4 7/32	107.2	3 15/16	100.0	21/32	16.7	PF7572
4	101.6	2 1/16	52.4	23/32	18.3	P7411	4 7/32	107.2	4 1/32	102.4	21/32	16.8	PF46152
4	101.6	2 19/32	65.9	3/4	19.0	P40102	4 1/4	108.0	2 1/2	63.5	27/32	21.4	PF913
4	101.6	2 7/8	73.0	1/2	12.7	PF947	4 1/4	108.0	2 7/8	73.0	9/16	14.3	P960
4	101.6	3 1/32	77.0	23/32	18.3	PF807	4 1/4	108.0	2 7/8	73.0	1 5/16	33.3	PT171
4 1/32	102.4	1 3/8	34.9	7/8	22.2	PT284	4 1/4	108.0	3 9/32	83.3	1 5/32	29.4	P40105
4 1/32	102.4	2 5/16	58.7	5/8	15.9	PT9423	4 1/4	108.0	3 9/32	83.3	1 5/32	29.4	P40106
4 1/32	102.4	2 17/32	64.3	31/32	24.6	P7426	4 9/32	108.7	2 1/2	63.5	1 31/32	50.0	PT23333
4 1/32	102.4	3 9/32	83.3	1 11/16	42.9	P7488	4 9/32	108.7	2 9/16	65.1	1/2	12.7	PF834
4 1/16	103.2	1 25/32	45.2	3/4	19.0	PT9134	4 9/32	108.7	4 7/32	107.2	1 11/16	42.9	151
4 1/16	103.2	1 13/16	46.0	13/16	20.6	PT23338-MPG	4 9/32	108.7	4 7/32	107.2	1 11/16	42.9	151-W
4 1/16	103.2	2 5/16	58.7	1 5/16	33.3	PT23320	4 5/16	109.5	2 17/32	64.3	—	—	PT9223
4 1/16	103.2	2 9/16	65.1	5/8	15.9	PF40052	4 5/16	109.5	3	76.2	13/16	20.6	PF46057
4 1/16	103.2	2 23/32	69.1	1 3/8	34.9	PT8385	4 5/16	109.5	3 9/32	83.3	1 3/8	34.9	P40096
4 1/16	103.2	2 13/16	71.4	1 1/2	38.1	PT23190	4 5/16	109.5	3 15/32	88.1	21/32	16.7	PF46033
4 1/16	103.2	2 7/8	73.0	13/16	20.6	PF946	4 5/16	109.5	3 19/32	91.3	1 1/8	28.6	PF7751
4 1/16	103.2	3 1/32	77.0	7/8	22.2	P7365	4 11/32	110.3	2 7/8	73.0	9/16	14.3	PF311
4 1/16	103.2	3 9/32	83.3	1 1/16	27.0	P40011	4 11/32	110.3	2 7/8	73.0	9/16	14.3	PF7588
4 1/16	103.2	3 5/16	84.1	15/16	23.8	P81	4 11/32	110.3	2 31/32	75.4	1 1/8	28.6	P40104
4 1/16	103.2	3 5/16	84.1	15/16	23.8	P84-2	4 11/32	110.3	3 1/8	79.4	1 7/8	47.6	PT23269-MPG
4 1/16	103.2	3 5/8	92.1	1 3/32	27.8	PF7735	4 11/32	110.3	3 1/4	82.6	1 9/16	39.7	PT136
4 1/16	103.2	3 11/16	93.7	1 15/16	49.2	PT23351-MPG	4 11/32	110.3	3 5/8	92.1	19/32	15.1	PF7758
4 1/16	103.2	5	127.0	1 7/16	36.5	PT9386-MPG	4 11/32	110.3	3 11/16	93.7	11/16	17.8	PF46259
4 3/32	104.0	1 25/32	45.2	13/16	20.6	PT8972-MPG	4 3/8	111.1	1 11/16	42.9	15/16	23.8	PT23294-MPG
4 3/32	104.0	1 25/32	45.2	13/16	20.6	PT9195	4 3/8	111.1	1 3/4	44.4	15/16	23.8	PT23260-MPG
4 3/32	104.0	1 25/32	45.2	13/16	20.6	PT23309	4 3/8	111.1	2 7/8	73.0	21/32	16.7	P496
4 3/32	104.0	2 9/16	65.1	1 1/16	27.0	P40061	4 3/8	111.1	2 7/8	73.0	1 3/16	30.2	PT849
4 3/32	104.0	2 7/8	73.0	1 1/4	31.8	P7427	4 3/8	111.1	2 7/8	73.0	1 3/16	30.2	PT849-10
4 3/32	104.0	2 7/8	73.0	1 11/32	34.1	PT23329	4 3/8	111.1	2 7/8	73.0	1 5/16	33.3	PT382
4 3/32	104.0	3 3/8	85.7	13/16	20.6	PF7777	4 13/32	111.9	2 1/16	52.4	29/32	23.8	P40010
4 3/32	104.0	3 3/8	85.7	13/16	20.6	PF7977	4 13/32	111.9	2 5/16	58.7	1/2	12.7	PF7910
4 1/8	104.8	1 11/16	42.9	3/4	19.0	PT23100-MPG	4 13/32	111.9	3 9/32	83.6	1 23/32	43.4	PF46140
4 1/8	104.8	2 7/32	56.4	29/32	23.8	PT9308-MPG	4 13/32	111.9	3 5/16	84.1	1 19/32	40.5	PF7934 KIT
4 1/8	104.8	2 3/8	60.3	29/32	23.8	PT9482-MPG	4 13/32	111.9	3 23/32	94.5	9/16	14.3	PT151
4 1/8	104.8	2 19/32	65.9	1 1/4	31.8	P40114	4 7/16	112.7	1 25/32	45.2	1	25.4	PT9510
4 1/8	104.8	2 7/8	73.0	1 1/4	31.8	P40100	4 7/16	112.7	2 29/32	73.8	1 5/16	33.3	P172
4 1/8	104.8	2 29/32	73.8	1 1/4	31.8	PT8984-MPG	4 7/16	112.7	3 23/32	94.5	1/2	12.7	P40
4 1/8	104.8	3 7/32	82.0	9/16	14.0	P40134	4 15/32	113.5	1 3/4	44.4	1	25.4	PT23322
4 1/8	104.8	3 1/4	82.6	1 9/16	39.7	P7138	4 15/32	113.5	1 3/4	44.4	1 1/32	26.2	H9042
4 1/8	104.8	3 5/16	84.1	1 1/8	28.6	PT62	4 15/32	113.5	1 3/4	44.4	1 1/32	26.2	H9043
4 1/8	104.8	3 3/8	85.7	13/16	20.6	PT9394-MPG	4 15/32	113.5	1 3/4	44.4	1 1/32	26.2	H9044
4 1/8	104.8	3 3/4	95.3	1 29/32	48.4	PT23346-MPG	4 15/32	113.5	1 25/32	45.2	15/16	23.8	PT9137
4 5/32	105.6	1 13/16	46.0	—	—	PT9222	4 15/32	113.5	1 25/32	45.2	1	25.4	PT23018
4 5/32	105.6	2 27/32	72.2	1 25/32	45.2	PT9185	4 15/32	113.5	1 25/32	45.2	1	25.4	PT23463
4 5/32	105.6	4 1/32	102.4	2 7/16	61.9	PT8407	4 15/32	113.5	1 25/32	45.2	1	25.4	PT23492-MPG
4 5/32	105.6	5	127.0	7/8	22.2	P8448	4 15/32	113.5	1 25/32	45.2	1	25.4	PT23510-MPG
4 3/16	106.4	1 11/16	42.9	1 1/32	26.2	PT461	4 15/32	113.5	2 3/32	53.2	29/32	23.0	PT9435-MPG
4 3/16	106.4	1 13/16	46.0	13/16	20.6	PT23164	4 15/32	113.5	3 3/16	81.0	1 3/32	27.8	P40083
4 3/16	106.4	2 1/4	57.2	13/16	20.6	P7489	4 15/32	113.5	3 9/32	83.3	21/32	16.7	BF7675-D
4 3/16	106.4	2 17/32	72.2	2	50.8	PT8987-MPG	4 15/32	113.5	3 9/32	83.3	21/32	16.7	BF7745-D
4 3/16	106.4	2 7/8	73.0	27/32	21.4	P271	4 15/32	113.5	3 15/32	88.1	23/32	18.3	BF46113-D
4 3/16	106.4	2 29/32	73.8	5/8	15.9	PF9825	4 1/2	114.3	1 5/8	41.3	15/16	23.8	PT23218-MPG
4 3/16	106.4	2 15/16	74.6	1 1/4	31.8	PT23350-MPG	4 1/2	114.3	1 3/4	44.4	15/16	23.8	PT23258-MPG
4 3/16	106.4	3 7/32	81.8	1 17/32	38.9	PT9416-MPG KIT	4 1/2	114.3	1 3/4	44.4	15/16	23.8	PT23270-MPG
4 3/16	106.4	3 7/32	81.8	1 17/32	38.9	PT23127-MPG	4 1/2	114.3	1 3/4	44.4	1	25.4	H9049
4 3/16	106.4	3 5/16	84.1	1 19/32	40.5	PF7812 KIT	4 1/2	114.3	1 3/4	44.4	1	25.4	H9050
4 3/16	106.4	3 7/16	87.3	23/32	18.3	PF814	4 1/2	114.3	1 3/4	44.4	1	25.4	H9054
4 3/16	106.4	3 7/16	87.3	23/32	18.3	PT9374	4 1/2	114.3	1 3/4	44.4	1 1/8	28.6	PT23074-MPG
4 3/16	106.4	3 7/16	87.5	7/16	11.1	PF46126	4 1/2	114.3	1 25/32	45.2	1	25.4	PT258



WARNING: These products can expose you to chemicals, including Diisononyl Phthalate, Carbon black extracts, Nickel, 1,3 Butadiene, Ethylene Oxide, Epichlorohydrin, which are known to the State of California to cause cancer, and Bisphenol-A, Ethylene Glycol, Ethylene Oxide, 1,3 Butadiene, Epichlorohydrin, which are known to the State of California to cause birth defects or other reproductive harm. For more information go to www.P65Warnings.ca.gov.

LIQUID ELEMENTS BY LENGTH

LENGTH Inches	LENGTH (mm)	O.D. Inches	O.D. (mm)	I.D. Inches	I.D. (mm)	BALDWIN NUMBER	LENGTH Inches	LENGTH (mm)	O.D. Inches	O.D. (mm)	I.D. Inches	I.D. (mm)	BALDWIN NUMBER
4 1/2	114.3	1 25/32	45.2	1	25.4	PT23126-MPG	4 11/16	119.1	2 1/8	54.0	29/32	23.8	PT23292-MPG
4 1/2	114.3	1 25/32	45.2	1 1/32	26.2	H9041	4 11/16	119.1	3	76.2	1 1/16	27.0	PT8468
4 1/2	114.3	1 25/32	45.2	1 1/32	26.2	H9043-V	4 11/16	119.1	3 3/16	81.0	5/8	15.9	P40035
4 1/2	114.3	1 31/32	50.0	7/8	22.2	PT23280-MPG	4 11/16	119.1	3 1/4	82.6	3/4	19.0	S489
4 1/2	114.3	2	50.8	7/8	22.2	PT23263-MPG	4 11/16	119.1	3 3/4	95.3	1 5/16	33.3	PT12
4 1/2	114.3	2	50.8	15/16	23.8	H9107	4 11/16	119.1	4 7/32	107.2	17/32	13.5	P26
4 1/2	114.3	2	50.8	15/16	23.8	H9108	4 23/32	119.9	2 25/32	70.6	25/32	19.8	PF9801
4 1/2	114.3	2	50.8	15/16	23.8	H9110	4 23/32	119.9	3 5/16	84.1	9/16	14.3	PT9214
4 1/2	114.3	2	50.8	15/16	23.8	PT9484-MPG	4 23/32	119.9	3 7/16	87.3	21/32	16.7	PF7687
4 1/2	114.3	2	50.8	15/16	23.8	PT23205-MPG	4 23/32	119.9	3 15/32	88.1	1 11/32	34.1	PT374
4 1/2	114.3	2	50.8	15/16	23.8	PT23286-MPG	4 3/4	120.7	2 5/8	66.7	1 7/32	31.0	PT23536
4 1/2	114.3	2	50.8	15/16	23.8	PT23418-MPG	4 3/4	120.7	2 3/4	69.9	1 7/32	25.4	PT23203-MPG
4 1/2	114.3	2 1/32	51.6	29/32	23.8	PT23400-MPG	4 3/4	120.7	3 1/4	82.6	1 13/32	35.7	P125
4 1/2	114.3	2 9/16	65.1	29/32	23.8	P40094	4 3/4	120.7	3 23/32	94.5	13/32	10.3	PF7594
4 1/2	114.3	2 11/16	68.3	29/32	23.0	F834-F	4 25/32	121.4	2 19/32	65.9	1 3/32	27.8	PT7515
4 1/2	114.3	2 3/4	69.9	1 3/4	44.4	PT23357-MPG	4 25/32	121.4	2 7/8	73.0	1 11/32	34.1	PT8352
4 1/2	114.3	2 29/32	73.8	27/32	21.4	PT108	4 13/16	122.2	2 1/8	54.0	3/4	19.0	PT23290-MPG
4 1/2	114.3	2 29/32	73.8	27/32	21.4	PT108-HD	4 13/16	122.2	2 5/16	58.7	1 1/16	27.0	PT23195-MPG
4 1/2	114.3	3 3/16	81.0	1 1/16	27.0	PF828	4 13/16	122.2	2 11/32	59.5	1 1/2	38.1	PT9140
4 1/2	114.3	3 27/32	97.6	1/2	12.7	BC7173	4 13/16	122.2	2 5/8	66.7	1 7/32	31.0	PT434
4 1/2	114.3	3 27/32	97.6	5/8	15.9	BC110	4 13/16	122.2	2 5/8	66.7	1 7/32	31.0	PT434-10
4 1/2	114.3	3 27/32	97.6	—	—	BC7194	4 13/16	122.2	2 5/8	66.7	1 7/32	31.0	PT477
4 1/2	114.3	3 15/16	100.0	1 5/8	41.3	PF987	4 13/16	122.2	2 7/8	73.0	1 1/16	27.0	PF943
4 17/32	115.1	2 5/8	66.6	11/16	17.3	PF46059	4 13/16	122.2	3 1/32	77.0	3/8	9.5	PF46187
4 17/32	115.1	2 9/16	65.1	1 7/32	31.0	P7493	4 13/16	122.2	3 15/16	100.0	23/32	18.3	P80
4 17/32	115.1	2 9/16	65.1	1 7/32	31.0	P40001	4 13/16	122.2	3 15/16	100.0	23/32	18.3	P80-HD
4 17/32	115.1	2 23/32	69.1	1 11/32	34.1	PT8955-MPG	4 13/16	122.2	3 15/16	100.0	23/32	18.3	PF821-S
4 17/32	115.1	2 23/32	69.1	1 11/32	34.1	PT23376-MPG	4 13/16	122.2	5	127.0	2 13/16	71.4	PT578
4 17/32	115.1	2 3/4	69.9	7/16	11.1	F953-F	4 27/32	123.0	3 5/16	84.1	15/16	23.8	P184
4 17/32	115.1	3 7/32	81.8	1/2	12.7	BF9836-D	4 27/32	123.0	3 17/32	89.7	—	—	T300-M
4 17/32	115.1	3 17/32	89.7	9/16	14.3	PF7678	4 27/32	123.0	3 17/32	89.7	—	—	T308-M
4 17/32	115.1	3 3/8	85.9	3/4	19.3	PF46151	4 7/8	123.8	2 1/16	52.4	13/32	10.3	PF7595
4 9/16	115.9	2 3/32	53.2	7/8	22.2	PT8895-MPG	4 7/8	123.8	2 19/32	65.9	3/4	19.0	P7517
4 9/16	115.9	2 17/32	64.3	1 1/4	31.8	P1443	4 7/8	123.8	3	76.2	—	—	PF10
4 9/16	115.9	2 11/16	68.3	1 1/4	31.8	PT23206-MPG	4 7/8	123.8	3	76.2	—	—	PF10-CS
4 9/16	115.9	2 23/32	69.1	1 9/32	32.5	PT9149	4 7/8	123.8	3	76.2	1	25.4	PT727-HD
4 9/16	115.9	2 23/32	69.1	1 5/16	33.3	PT8957-MPG	4 7/8	123.8	3	76.2	1	25.4	PT727-HD10
4 9/16	115.9	2 3/4	69.9	1 3/32	27.8	P40109	4 7/8	123.8	4 7/32	107.2	1/2	12.7	P41
4 9/16	115.9	3 9/32	83.3	17/32	13.5	PT691	4 7/8	123.8	4 7/32	107.2	1/2	12.7	PF809
4 9/16	115.9	3 9/32	83.3	3/4	19.0	PF9861	4 29/32	124.6	2 5/32	54.8	23/32	18.3	PT8991-MPG
4 9/16	115.9	3 25/32	96.0	15/32	11.9	PF9919	4 29/32	124.6	2 3/4	69.9	1 5/8	41.3	PT9396
4 19/32	116.7	2 5/16	58.7	1/2	12.7	PT9131	4 15/16	125.4	2 1/2	63.5	1 7/32	31.0	P7399
4 19/32	116.7	3 3/32	78.6	1 11/16	42.9	H9072-V	4 15/16	125.4	2 1/2	63.5	1 7/32	31.0	PT417
4 5/8	117.5	1 1/4	31.8	1/4	6.4	PF7816	4 15/16	125.4	2 7/8	73.0	1 1/16	27.0	PT273
4 5/8	117.5	2 1/8	54.0	29/32	23.8	PT23090-MPG	4 15/16	125.4	2 15/16	74.6	1	25.4	PT23142
4 5/8	117.5	2 9/16	65.1	17/32	13.5	PT135	4 15/16	125.4	4 1/2	114.3	13/16	20.6	P47
4 5/8	117.5	2 11/16	68.3	1 1/8	28.6	P7406	4 31/32	126.2	3 15/32	88.1	5/8	15.9	PT23136
4 5/8	117.5	2 3/4	69.9	1 7/16	36.5	PT23207-MPG	5	127.0	2	50.8	1 5/8	41.3	S456
4 5/8	117.5	3 1/8	79.4	1 11/16	42.9	H9069	5	127.0	2 5/8	66.7	1 7/32	31.0	PT492
4 5/8	117.5	3 1/8	79.4	1 11/16	42.9	H9070	5	127.0	2 3/4	69.9	1 5/16	33.3	PT9414-MPG
4 5/8	117.5	3 1/8	79.4	1 11/16	42.9	H9071	5	127.0	2 3/4	69.9	1 3/8	34.9	PT23212-MPG
4 5/8	117.5	3 1/8	79.4	1 11/16	42.9	H9072	5	127.0	3 1/2	88.9	1 5/32	29.4	BF7956-D
4 5/8	117.5	3 5/16	84.1	15/16	23.8	PT269	5	127.0	3 3/4	95.3	1 1/8	28.6	PT468-MPG
4 5/8	117.5	6 1/16	154.0	3 9/32	83.3	201	5	127.0	4 7/32	107.2	1/2	12.7	P53
4 5/8	117.5	6 1/16	154.0	3 9/32	83.3	201-30	5	127.0	4 3/8	111.1	2 13/32	61.1	PT764
4 5/8	117.5	6 1/16	154.0	3 9/32	83.3	201-W	5	127.0	4 3/8	111.1	2 13/32	61.1	PT765
4 21/32	118.3	2 7/32	56.4	1	25.4	PT23575-MPG	5	127.0	4 3/8	111.1	2 7/16	61.9	PT8462-MPG
4 21/32	118.3	2 7/8	73.0	1 1/16	27.0	PT9508	5 1/32	127.8	2 15/32	62.7	1 3/32	27.8	PT9419-MPG
4 21/32	118.3	3 1/16	77.8	1 11/16	42.9	PT23408-MPG	5 1/32	127.8	2 13/16	71.4	1 1/8	28.6	P40111
4 21/32	118.3	3 1/16	77.8	1 11/16	42.9	PT23436-MPG	5 1/32	127.8	2 7/8	73.0	1 1/4	31.8	P40108
4 21/32	118.3	3 3/32	78.6	1 11/16	42.9	PT23484-MPG	5 1/32	127.8	3 31/32	100.8	1 5/8	41.3	P127
4 21/32	118.3	3 5/16	84.1	17/32	13.5	BF7866	5 1/16	128.6	2 11/16	68.3	1 1/16	27.0	P40103
4 11/16	119.1	1 5/32	29.4	5/8	15.9	PT256	5 1/16	128.6	2 7/8	73.0	21/32	16.7	P497
4 11/16	119.1	1 3/4	44.4	1	25.4	PT23447-MPG	5 1/16	128.6	3 15/16	100.0	2 1/4	57.2	PT437
4 11/16	119.1	2 3/32	53.2	1	25.4	PT9311-MPG	5 1/16	128.6	4 17/32	115.1	2 9/32	57.9	P203
4 11/16	119.1	2 3/32	53.2	1 3/32	27.8	PT8996-MPG	5 1/16	128.6	4 17/32	115.1	2 9/32	57.9	P203-HD



WARNING: These products can expose you to chemicals, including Diisononyl Phthalate, Carbon black extracts, Nickel, 1,3 Butadiene, Ethylene Oxide, Epichlorohydrin, which are known to the State of California to cause cancer, and Bisphenol-A, Ethylene Glycol, Ethylene Oxide, 1,3 Butadiene, Epichlorohydrin, which are known to the State of California to cause birth defects or other reproductive harm. For more information go to www.P65Warnings.ca.gov.

LIQUID ELEMENTS BY LENGTH

LENGTH Inches	LENGTH (mm)	O.D. Inches	O.D. (mm)	I.D. Inches	I.D. (mm)	BALDWIN NUMBER	LENGTH Inches	LENGTH (mm)	O.D. Inches	O.D. (mm)	I.D. Inches	I.D. (mm)	BALDWIN NUMBER
5 1/16	128.6	4 17/32	115.1	2 9/32	57.9	P203-HD10	5 3/8	136.5	2 13/16	71.4	1 5/16	33.3	PT23102-MPG
5 3/32	129.4	2 7/8	73.0	1 3/8	34.9	P7400	5 3/8	136.5	3 1/8	79.4	7/16	11.1	PF46188
5 3/32	129.4	3 3/16	81.0	1 3/32	27.8	P7114	5 3/8	136.5	3 9/32	83.3	13/16	20.6	P7017
5 3/32	129.4	6 1/2	165.1			P7102	5 3/8	136.5	3 17/32	89.7	3/4	19.0	PF9899
5 1/8	130.2	1 9/16	39.7	11/32	8.7	PF7826	5 3/8	136.5	3 19/32	91.3	9/16	14.3	PF7592
5 1/8	130.2	2 3/4	69.9	1 1/8	28.6	PT9242	5 3/8	136.5	3 7/8	98.4	1 1/4	31.8	BC40009
5 1/8	130.2	2 3/4	69.9	1 5/32	29.4	PT23501-MPG	5 13/32	137.3	1 15/16	49.2	27/32	21.4	P40033
5 1/8	130.2	2 3/4	69.9	1 3/8	34.9	PT23470	5 13/32	137.3	2	50.8	1 15/32	37.3	PF7825
5 1/8	130.2	3 9/32	83.3	1 1/4	31.8	PF121	5 13/32	137.3	2 1/16	52.4	7/8	22.2	P7492
5 1/8	130.2	3 15/16	100.0	1 1/8	28.6	P545	5 13/32	137.3	2 13/16	71.4	1 5/16	33.3	P170
5 1/8	130.2	4 5/8	117.5	1 5/16	33.3	PT85	5 13/32	137.3	3 1/8	79.4	3/4	19.0	BF46040-D
5 5/32	131.0	2 27/32	72.2	27/32	21.4	PF7787	5 7/16	138.1	2 17/32	64.3			PT9225
5 5/32	131.0	3 29/32	99.2			PT9139	5 7/16	138.1	3 3/32	78.6	1 5/8	41.3	P7083
5 3/16	131.6	2 13/16	71.0			PF46118	5 7/16	138.1	3 9/32	83.3	1/2	12.7	PF7978
5 3/16	131.8	2 3/4	70.1	27/32	21.1	P40037	5 15/32	138.9	2 9/16	65.1	3/4	19.0	BF1201
5 3/16	131.8	2 27/32	72.2	13/16	20.6	PF7788	5 15/32	138.9	2 7/8	73.0	1 5/16	33.3	P280
5 3/16	131.8	3 7/32	81.8	7/8	22.2	P7269	5 15/32	138.9	2 7/8	73.0	1 11/32	34.1	PT8355
5 7/32	132.6	2 7/32	56.4	1 3/32	27.8	PT23233-MPG	5 15/32	138.9	3 3/8	85.7			PT9278
5 7/32	132.6	2 3/4	69.9	1 3/32	27.8	PT8989-MPG	5 15/32	138.9	3 13/32	86.5	2 9/16	65.1	PT23328
5 7/32	132.6	2 3/4	69.9	1 1/8	28.6	PT9237	5 15/32	138.9	3 13/32	86.5	2 9/16	65.1	PT23334
5 7/32	132.6	2 25/32	70.6	1 7/32	31.0	PT9256-MPG	5 15/32	138.9	3 5/8	92.1	23/32	18.3	P7081
5 7/32	132.6	3 9/32	83.3	21/32	16.7	BF7673-D	5 15/32	138.9	3 23/32	94.5	1 1/32	26.2	PF7982
5 7/32	132.6	3 9/32	83.3	21/32	16.7	BF7681-D	5 15/32	138.9	4 9/16	115.9	2 7/32	56.4	PT508-MPG
5 7/32	132.6	3 9/32	83.3	21/32	16.7	BF7699-D	5 15/32	138.9	4 9/16	115.9	2 7/32	56.4	PT8318-MPG
5 7/32	132.6	3 9/32	83.3	21/32	16.7	BF7783-D	5 15/32	138.9	7 7/8	200.0	4 15/32	113.5	PT9401
5 7/32	132.6	4	101.6	1 15/32	37.3	PT8487	5 1/2	139.7	2 3/4	69.9	1	25.4	PT9329
5 7/32	132.6	4	101.6	1 15/32	37.3	PT9344	5 1/2	139.7	2 27/32	72.2	1 1/32	26.2	PF46049
5 1/4	133.4	2 7/8	73.0	1 5/8	41.3	P40115	5 1/2	139.7	2 7/8	73.0	1 5/16	33.3	PF831
5 1/4	133.4	3 23/32	94.5	21/32	16.7	P67	5 1/2	139.7	3 1/16	77.8	1 19/32	40.5	PT9486-MPG
5 1/4	133.4	4	101.6	1 5/16	33.3	JC405	5 1/2	139.7	3 1/4	82.6			PT23016
5 1/4	133.4	4	101.6	1 3/8	34.9	BF9895 KIT	5 1/2	139.7	3 19/32	91.3	9/16	14.3	PF332
5 1/4	133.4	5 23/32	145.3	3 13/16	96.8	PT9476-MPG	5 1/2	139.7	4 1/8	104.8	1 13/16	46.0	CU406
5 9/32	134.1	1 25/32	45.2	23/32	18.3	PT8485	5 1/2	139.7	4 3/16	106.4	2 13/16	71.4	PT23344-MPG
5 9/32	134.1	2 3/8	60.3	1 7/16	36.5	PT9293-MPG	5 1/2	139.7	4 3/8	111.1	1	25.4	PF7553
5 9/32	134.1	2 3/4	69.9	1 31/32	50.0	PT9135	5 1/2	139.7	4 9/16	115.9	2 1/4	57.2	PT87-S
5 9/32	134.1	3 1/8	79.4			BF46078-D	5 17/32	140.5	2 9/16	65.1	1 1/4	31.8	P40118
5 9/32	134.1	3 3/16	81.0	5/8	15.9	BF9835-D	5 17/32	140.5	2 13/16	71.4	1 5/16	33.3	PT29
5 9/32	134.1	3 7/32	81.8	1/2	12.7	BF9822-D	5 17/32	140.5	3	76.2	1 13/16	46.0	PT9260
5 9/32	134.1	3 7/32	81.8	1/2	12.7	BF9828-D	5 17/32	140.5	4 7/32	107.2	1 9/16	39.7	PF9870
5 9/32	134.1	3 7/32	81.8	7/8	22.2	BF9830-D	5 17/32	140.5	4 7/32	107.2	1 9/16	39.7	PF46108
5 9/32	134.1	3 9/16	90.5	1 15/32	37.3	BF7821	5 9/16	141.3	1 31/32	50.0	29/32	23.0	PT4116
5 9/32	134.1	3 21/32	92.9	1 5/8	41.3	P5092	5 9/16	141.3	2 25/32	70.6	5/8	15.9	P7415
5 9/32	134.1	3 11/16	93.7	1 9/16	39.7	PF46004	5 9/16	141.3	2 7/8	73.0	7/16	11.1	PF950
5 5/16	134.9	1 15/32	37.3	1	25.4	PT9203	5 9/16	141.3	2 7/8	73.0	1 5/16	33.3	P174
5 5/16	134.9	1 13/16	46.0	13/16	20.6	PT23143	5 9/16	141.3	3 5/32	80.2	1 15/32	37.3	PT23289-MPG
5 5/16	134.9	2 11/32	59.5	1 13/32	35.7	PT23332	5 9/16	141.3	3 1/4	82.6	1 7/8	47.6	PT23002
5 5/16	134.9	2 3/8	60.3	1	25.4	PT8887	5 9/16	141.3	3 5/16	84.1	2	50.8	PT23204-MPG
5 5/16	134.9	2 3/8	60.3	1 1/32	26.2	PT9309-MPG	5 9/16	141.3	3 19/32	91.3	1 11/32	34.1	P40117
5 5/16	134.9	2 3/8	60.3	1 13/32	35.7	PT23512-MPG	5 9/16	141.3	3 15/16	100.0	1 19/32	40.5	PT185
5 5/16	134.9	2 3/8	60.3	1 13/32	35.7	PT23513-MPG	5 19/32	142.1	7/8	22.2	9/16	14.3	PF46119
5 5/16	134.9	2 1/2	63.5	1 7/32	31.0	P40098	5 19/32	142.1	2 7/8	73.0	1 3/16	30.2	PT546
5 5/16	134.9	3 1/32	77.0	3/8	9.5	PF46189	5 19/32	142.1	3	76.2	13/16	20.6	PF46056
5 5/16	134.9	3 5/32	80.2	15/16	23.8	BF9874-DM	5 19/32	142.1	3 1/4	82.6	1 1/2	38.1	PF9872
5 5/16	134.9	3 5/32	80.2	15/16	23.8	BF9875-DM	5 19/32	142.1	3 19/32	91.3	9/16	14.3	PF7554
5 5/16	134.9	5 29/32	150.0	3 13/32	86.5	PT9352	5 5/8	142.9	2 9/16	65.1	1 3/32	27.8	PT396
5 11/32	135.4	7 7/8	199.9	4 1/2	114.0	PT23624	5 5/8	142.9	2 7/8	73.0	1 1/16	27.0	PT8350
5 11/32	135.7	1 17/32	38.9	9/16	14.3	PF7872	5 5/8	142.9	3	76.2	1 1/16	27.0	PF916
5 11/32	135.7	2 3/8	60.3	1 13/32	35.7	PT8974-MPG	5 5/8	142.9	3	76.2	1 1/16	27.0	PF967
5 11/32	135.7	2 21/32	67.5	21/32	16.7	PF46130	5 5/8	142.9	3 3/16	81.0	1/2	12.7	F950-F WO
5 11/32	135.7	2 3/4	69.9	1 3/32	27.8	PT9167	5 5/8	142.9	3 3/16	81.0	1 7/8	47.6	PT23040-MPG
5 11/32	135.7	2 3/4	69.9	1 3/32	27.8	PT9174	5 5/8	142.9	3 1/4	82.6	17/32	13.5	F950-F
5 11/32	135.7	2 3/4	69.9			PT9315 KIT	5 5/8	142.9	3 1/4	82.6	1 7/8	47.6	PT23160
5 11/32	135.7	3 9/32	83.3	1 3/8	34.9	P40020	5 5/8	142.9	3 7/16	87.3	19/32	15.1	PF963
5 11/32	135.7	3 15/32	88.1	31/32	24.6	PT71	5 5/8	142.9	5 23/32	145.3	2 7/16	61.9	P7380
5 11/32	135.7	5 1/2	139.7	2 1/16	52.4	PT23147	5 21/32	143.7	2 7/8	73.0	1 13/32	35.7	PT8956-MPG
5 3/8	136.5	1 3/4	44.4	3/4	19.0	PT23202-MPG	5 21/32	143.7	3	76.2	1 1/16	27.0	PT480
5 3/8	136.5	2 1/4	57.2	1 1/16	27.0	PT9136	5 21/32	143.7	3	76.2	1 1/16	27.0	PT480-10
							5 21/32	143.7	3	76.2	1 1/16	27.0	PT480-MPG



WARNING: These products can expose you to chemicals, including Diisononyl Phthalate, Carbon black extracts, Nickel, 1,3 Butadiene, Ethylene Oxide, Epichlorohydrin, which are known to the State of California to cause cancer, and Bisphenol-A, Ethylene Glycol, Ethylene Oxide, 1,3 Butadiene, Epichlorohydrin, which are known to the State of California to cause birth defects or other reproductive harm. For more information go to www.P65Warnings.ca.gov.

LIQUID ELEMENTS BY LENGTH

LENGTH Inches	LENGTH (mm)	O.D. Inches	O.D. (mm)	I.D. Inches	I.D. (mm)	BALDWIN NUMBER	LENGTH Inches	LENGTH (mm)	O.D. Inches	O.D. (mm)	I.D. Inches	I.D. (mm)	BALDWIN NUMBER
5 21/32	143.7	3 17/32	89.7	1 5/16	33.3	P18	6	152.4	6	152.4	3 1/2	88.9	PT462
5 21/32	143.7	3 17/32	89.7	1 5/16	33.3	P18-HD	6 1/32	153.2	1 27/32	46.8	13/16	20.6	PT8954-MPG
5 11/16	144.5	2 7/8	73.0	1 1/4	31.8	P40095	6 1/32	153.2	1 27/32	46.8	7/8	22.2	PT23128-MPG
5 11/16	144.5	3 9/32	83.3	1 5/8	41.3	P266	6 1/32	153.2	1 27/32	46.8	7/8	22.2	PT23132-MPG
5 11/16	144.5	3 7/16	87.3	1 3/16	30.2	PT549	6 1/32	153.2	1 27/32	46.8	7/8	22.2	PT23369-MPG
5 11/16	144.5	3 3/4	95.3	13/16	20.6	PF7779	6 1/32	153.2	1 27/32	46.8	7/8	22.2	PT23371-MPG
5 23/32	145.3	3 7/16	87.3	1/2	12.7	PF804	6 1/32	153.2	1 7/8	47.6	13/16	20.6	PT9330-MPG
5 23/32	145.3	3 15/16	100.0	1 15/32	37.3	P104	6 1/32	153.2	2 17/32	64.3	21/32	16.7	PT308
5 23/32	145.3	5 1/8	130.2	2 17/32	64.3	PT23469	6 1/32	153.2	2 25/32	70.6	27/32	21.4	P1418
5 3/4	146.0	2 7/8	73.0	1	25.4	F916-C	6 1/32	153.2	3 3/8	85.7	11/16	17.5	BF7904-D
5 3/4	146.0	3 1/2	88.9	1 5/32	29.4	BF7954-D	6 1/32	153.2	3 1/2	88.9	1 5/8	41.3	P40017
5 3/4	146.0	4 7/16	112.7	1 17/32	38.9	PT11	6 1/16	153.9	2 7/32	56.4	13/16	20.6	P40076
5 3/4	146.0	4 7/16	112.7	1 17/32	38.9	PT11-HD	6 1/16	154.0	2 9/16	65.1	1 1/4	31.8	P40107
5 25/32	146.8	3 9/32	83.3	1 5/8	41.3	P7050	6 1/16	154.0	3 3/16	81.0	1/2	12.7	BF9808-D
5 25/32	146.8	4 3/4	120.7	2 1/16	52.4	P7233	6 1/16	154.0	3 3/16	81.0	1/2	12.7	BF9847-D
5 13/16	147.6	2 1/2	63.5	1 3/8	34.9	PT23175	6 1/16	154.0	3 3/16	81.0	9/16	14.3	BF9892-D
5 13/16	147.6	2 17/32	64.3	1 1/16	27.0	PT9165	6 1/16	154.0	3 7/32	81.8	7/8	22.2	BF9833-D
5 13/16	147.6	2 15/16	74.6	1	25.4	P40025	6 1/16	154.0	3 25/32	96.0	1 23/32	43.7	P7104
5 13/16	147.6	3 11/16	93.7	1/4	6.4	BC7485	6 1/16	154.0	3 15/16	100.0	1 1/16	27.0	PT138-10
5 13/16	147.6	3 11/16	93.7	—	—	BC7326	6 1/16	154.0	3 15/16	100.0	1 1/16	27.0	PT138-25
5 27/32	148.4	2 7/8	73.0	9/16	14.3	PF231	6 1/16	154.0	5 7/8	149.2	2 15/16	74.6	PT9245
5 27/32	148.4	2 7/8	73.0	—	—	PT23474	6 3/32	154.8	2 3/32	53.2	1 3/32	27.8	PT9378-MPG
5 27/32	148.4	3 3/16	81.0	1/2	12.7	PF9865	6 3/32	154.8	2 9/16	65.1	1 1/4	31.8	P7414
5 27/32	148.4	4 3/4	120.7	2 7/32	56.4	P7190	6 3/32	154.8	3 15/16	100.0	7/8	22.2	P40012
5 7/8	149.2	13/16	20.6	1 13/16	46.0	PT23038-MPG	6 3/32	154.8	4 1/32	102.4	2 11/32	59.5	PT23330
5 7/8	149.2	2 3/32	53.2	1/16	1.6	PT23311	6 1/8	155.6	3 1/8	79.4	7/8	22.2	BF46045-D
5 7/8	149.2	2 17/32	64.3	1 7/32	31.0	PT9417	6 1/8	155.6	3 3/4	95.3	1 5/16	33.3	PT8345
5 7/8	149.2	2 13/16	71.4	1 13/16	46.0	PT23196-MPG	6 1/8	155.6	5	127.0	2 13/16	71.4	PT268
5 7/8	149.2	2 27/32	72.2	1 3/4	44.4	PT9186	6 1/8	155.6	5	127.0	2 13/16	71.4	PT392
5 7/8	149.2	3	76.2	1	25.4	PT23071-MPG	6 1/8	155.6	5	127.0	2 13/16	71.4	PT514
5 7/8	149.2	3 23/32	94.5	25/32	19.8	P68	6 5/32	156.4	1 9/16	39.7	5/8	15.9	PF7876
5 7/8	149.2	4 11/32	110.3	2 1/4	57.2	P7232	6 5/32	156.4	1 13/16	46.0	13/16	20.6	P40112
5 7/8	149.2	5 1/16	128.6	2 11/32	59.5	P7092	6 5/32	156.4	1 13/16	46.0	7/8	22.2	P40099
5 29/32	149.9	1 11/16	43.2	—	—	PF46258	6 5/32	156.4	1 31/32	50.0	7/8	22.2	P9600
5 29/32	150.0	1 1/2	38.1	—	—	PT23464	6 5/32	156.4	2 13/16	71.4	1 5/16	33.3	P1565
5 29/32	150.0	1 31/32	50.0	27/32	21.4	PT8319	6 3/16	157.2	2 19/32	65.9	7/16	11.1	P40021
5 29/32	150.0	2 27/32	72.2	1 25/32	45.2	PT8986-MPG	6 3/16	157.2	3 1/16	77.8	1 19/32	40.5	PT23110-MPG
5 29/32	150.0	2 27/32	72.2	1 25/32	45.2	PT9145	6 3/16	157.2	5	127.0	2 13/16	71.4	PT383
5 29/32	150.0	2 27/32	72.2	1 25/32	45.2	PT9514	6 7/32	157.7	2 15/16	74.9	3/4	19.0	PF46137
5 29/32	150.0	3 1/2	88.9	1 15/32	37.3	PT61-HD	6 7/32	157.7	2 15/16	74.9	3/4	19.0	PF46137 KIT
5 29/32	150.0	3 27/32	97.6	1 3/16	30.2	PF1392	6 7/32	158.0	2 7/8	73.0	1 13/32	35.7	PT9215
5 29/32	150.0	3 15/16	100.0	19/32	15.1	P7013	6 7/32	158.0	3 15/16	100.0	7/8	22.2	PF819
5 15/16	150.8	3 7/32	81.8	1 17/32	38.9	PT9415-MPG KIT	6 7/32	158.0	3 15/16	100.0	7/8	22.2	PF899
5 15/16	150.8	3 9/32	83.3	1 9/16	39.7	P7199	6 1/4	158.8	2 1/8	54.0	1 1/8	28.6	PT23115-MPG
5 15/16	150.8	3 5/16	84.1	1 9/16	39.7	P7423	6 1/4	158.8	3 1/2	88.9	1 1/4	31.8	P19
5 15/16	150.8	3 15/16	100.0	1 1/16	27.0	P82	6 1/4	158.8	3 1/2	88.9	1 15/16	49.2	PT23046-MPG
5 15/16	150.8	3 15/16	100.0	1 1/16	27.0	PT82-HD	6 1/4	158.8	3 29/32	99.2	2 1/16	52.4	PT23316
5 15/16	150.8	3 15/16	100.0	1 1/16	27.0	PT82-HD10	6 1/4	158.8	3 15/16	100.0	1 1/16	27.0	P25
5 15/16	150.8	5 29/32	150.0	—	—	PT9277	6 1/4	158.8	3 15/16	100.0	1 1/16	27.0	PF826
5 31/32	151.6	3 7/32	81.8	1 1/16	27.0	P7607	6 1/4	158.8	3 15/16	100.0	2	50.8	PT23118-MPG
5 31/32	151.6	3 9/32	83.3	21/32	16.7	BF7672-D	6 1/4	158.8	4 1/32	102.4	2 29/32	73.8	PT23336
5 31/32	151.6	3 9/32	83.3	21/32	16.7	BF7674-D	6 1/4	158.8	4 17/32	115.1	7/8	22.2	PT152
5 31/32	151.6	3 9/32	83.3	21/32	16.7	BF7679-D	6 9/32	159.5	2 1/32	51.6	15/16	23.8	PT23375-MPG
5 31/32	151.6	3 9/32	83.3	21/32	16.7	BF7784-D	6 9/32	159.5	2 7/16	61.9	27/32	21.4	P1419
5 31/32	151.6	3 9/32	83.3	21/32	16.7	BF7905-D	6 9/32	159.5	2 7/8	73.0	1 11/32	34.1	PT8354
5 31/32	151.6	3 9/32	83.3	21/32	16.7	BF7906-D	6 5/16	160.3	2	50.8	15/16	23.8	H9327
5 31/32	151.6	3 15/16	100.0	1 1/16	27.0	PF822	6 5/16	160.3	2 9/32	57.9	1 9/32	32.5	PT23008
6	152.4	1 13/16	46.0	13/16	20.6	PT23043-MPG	6 5/16	160.3	3 1/2	88.9	1 15/16	49.2	PT23045-MPG
6	152.4	1 31/32	50.0	29/32	23.0	PT8451-MPG	6 5/16	160.3	3 17/32	89.7	—	—	PT9448
6	152.4	2 5/16	58.7	1 11/32	34.1	PT435	6 11/32	161.1	3 1/2	88.9	5/8	15.9	BF7522
6	152.4	2 7/8	73.0	1 5/16	33.3	P177	6 11/32	161.1	3 27/32	97.6	2 17/32	64.3	PT23399-MPG
6	152.4	3 1/32	77.0	23/32	18.3	PF883	6 11/32	161.1	4 1/4	108.0	31/32	24.6	PF46003
6	152.4	3 1/2	88.9	5/8	15.9	BF7952-D	6 3/8	161.9	2	50.8	13/16	20.6	PT23039-MPG
6	152.4	3 21/32	92.9	1 11/32	34.1	P356	6 3/8	161.9	3 1/4	82.6	1 9/16	39.7	PT137
6	152.4	5 1/8	130.2	2	50.8	PT23003	6 3/8	161.9	3 17/32	89.7	1 29/32	48.4	PT23372-MPG
6	152.4	5 1/8	130.2	3 3/8	85.7	PT89	6 3/8	161.9	3 9/16	90.5	1 29/32	48.4	PT9492-MPG
6	152.4	5 3/16	131.8	2	50.8	PT23188	6 3/8	161.9	3 9/16	90.5	1 29/32	48.4	PT23363-MPG
							6 3/8	161.9	3 9/16	90.5	1 29/32	48.4	PT23370-MPG



WARNING: These products can expose you to chemicals, including Diisononyl Phthalate, Carbon black extracts, Nickel, 1,3 Butadiene, Ethylene Oxide, Epichlorohydrin, which are known to the State of California to cause cancer, and Bisphenol-A, Ethylene Glycol, Ethylene Oxide, 1,3 Butadiene, Epichlorohydrin, which are known to the State of California to cause birth defects or other reproductive harm. For more information go to www.P65Warnings.ca.gov.

LIQUID ELEMENTS BY LENGTH

LENGTH Inches	LENGTH (mm)	O.D. Inches	O.D. (mm)	I.D. Inches	I.D. (mm)	BALDWIN NUMBER	LENGTH Inches	LENGTH (mm)	O.D. Inches	O.D. (mm)	I.D. Inches	I.D. (mm)	BALDWIN NUMBER
6 3/8	161.9	3 23/32	94.5	1 7/8	47.6	PF7938	6 13/16	173.0	2 23/32	69.1	1 11/32	34.1	PT23365-MPG
6 3/8	161.9	3 7/8	98.4	—	—	PT302	6 13/16	173.0	2 23/32	69.1	1 11/32	34.1	PT23430-MPG
6 3/8	161.9	3 15/16	100.0	1 5/8	41.3	PT153	6 13/16	173.0	2 3/4	69.9	1 5/32	29.4	PT23465
6 13/32	162.7	2 21/32	87.6	7/16	11.4	PF46076	6 13/16	173.0	2 3/4	69.9	1 11/32	34.1	PT23129-MPG
6 13/32	162.7	3 5/16	84.1	1 1/2	38.1	PT23560	6 13/16	173.0	2 7/8	73.0	27/32	21.4	PF882
6 13/32	162.7	3 23/32	94.5	1 1/32	26.2	PF7983	6 13/16	173.0	3 7/32	81.8	7/8	22.2	BF9827-D
6 13/32	162.7	3 23/32	94.5	1 1/32	26.2	PF9868	6 27/32	173.8	2 3/16	55.6	1 1/16	27.0	PT9282-MPG
6 13/32	162.7	3 7/8	98.4	—	—	T303-M	6 27/32	173.8	2 23/32	69.1	1 9/32	32.5	PT8959-MPG
6 13/32	162.7	4 21/32	118.3	2 11/32	59.5	PT8947-MPG	6 27/32	173.8	3 23/32	94.5	1 3/4	44.4	PF7986
6 7/16	163.5	3 3/4	95.3	1 25/32	45.2	PF46046	6 27/32	173.8	3 3/4	95.3	1 13/16	46.0	PF7935
6 7/16	163.5	4 11/32	110.3	21/32	16.7	PF7733	6 7/8	174.6	3 5/32	80.2	27/32	21.4	C40005
6 7/16	163.5	5 29/32	150.0	3 1/2	88.9	PT23455	6 7/8	174.6	5 29/32	150.0	2 13/16	71.4	P1563
6 15/32	164.3	3 1/32	77.0	1 1/4	31.8	PT377	6 29/32	175.4	2 23/32	69.1	1 5/32	29.4	PT8940-MPG
6 15/32	164.3	3 1/32	77.0	1 1/4	31.8	PT377-10	6 29/32	175.4	2 23/32	69.1	1 3/16	30.2	PT23499-MPG
6 15/32	164.3	4 23/32	119.9	21/32	16.7	PF7749	6 29/32	175.4	3 3/4	95.3	21/32	16.7	PF7744
6 15/32	164.3	5 1/32	127.8	2 15/32	62.7	P7059	6 29/32	175.4	3 29/32	99.2	1 19/32	40.5	PT23468
6 1/2	165.1	3 9/32	83.3	1 19/32	40.5	PT63-1	6 29/32	175.4	3 29/32	99.2	1 19/32	40.5	PT23480
6 1/2	165.1	3 5/16	84.1	1 1/16	27.0	PF823	6 15/16	176.2	3 1/2	88.9	2	50.8	P198
6 1/2	165.1	3 5/16	84.1	1 1/16	27.0	PF823-E	6 15/16	176.2	4	101.6	2 15/16	74.6	PT23183
6 1/2	165.1	3 5/16	84.1	1 1/16	27.0	PF824	6 15/16	176.2	4	101.6	2 15/16	74.6	PT23184
6 1/2	165.1	3 5/16	84.1	1 1/16	27.0	PF829(2)	6 15/16	176.2	4 3/16	106.4	21/32	16.7	PF7930
6 1/2	165.1	3 15/16	100.0	2 1/4	57.2	P723	6 31/32	177.0	3 1/4	82.6	1 7/16	36.5	PT196
6 1/2	165.1	4 11/32	110.3	21/32	16.7	PF7718	6 31/32	177.0	4 1/2	114.3	1 7/8	47.6	PT207
6 1/2	165.1	4 11/32	110.3	21/32	16.7	PF7734	6 31/32	177.0	4 1/2	114.3	1 7/8	47.6	PT207-10
6 17/32	165.9	3 9/16	90.5	—	—	PT8419	6 31/32	177.0	4 1/2	114.3	1 7/8	47.6	PT207-HD
6 9/16	166.7	1 25/32	45.2	29/32	23.0	PT23570-MPG	6 31/32	177.0	4 1/2	114.3	1 7/8	47.6	PT467-MPG
6 9/16	166.7	2 9/16	65.1	31/32	24.6	P40023	6 31/32	177.0	4 1/2	114.3	1 7/8	47.6	PT207-HD10
6 9/16	166.7	3 3/16	81.0	—	—	PT23123	6 31/32	177.0	4 23/32	119.9	2 3/32	53.1	P40042
6 9/16	166.7	3 17/32	89.7	—	—	PT9196	6 31/32	177.0	5 1/8	130.2	3 3/8	85.7	PT9380-MPG
6 9/16	166.7	3 17/32	89.7	—	—	PT23586	7	177.8	1 3/8	34.9	13/16	20.6	PT23064-MPG
6 9/16	166.7	3 5/8	92.1	1 11/16	42.9	PF9914 KIT	7	177.8	1 5/8	41.3	13/16	20.6	PT23077-MPG
6 9/16	166.7	4 21/32	118.3	2 11/32	59.5	PT8939-MPG	7	177.8	2 7/16	61.9	1 3/8	34.9	PT23326
6 5/8	168.3	2 7/8	73.0	9/16	14.3	P150	7	177.8	3 27/32	97.6	1/2	12.7	BC7242
6 5/8	168.3	3 19/32	91.3	9/16	14.3	PF7556	7	177.8	3 27/32	97.6	1/2	12.7	BC7394
6 5/8	168.3	3 19/32	91.3	21/32	16.7	PT8356	7	177.8	3 27/32	97.6	5/8	15.9	BC7228
6 5/8	168.3	3 15/16	100.0	23/32	18.3	PF594	7	177.8	4 7/16	112.7	1 1/2	38.1	PT137
6 5/8	168.3	4 1/2	114.3	1 1/16	27.0	P276	7	177.8	4 1/2	114.3	1 29/32	48.4	PT373
6 5/8	168.7	2 21/32	67.6	15/16	23.6	P40074	7	177.8	5 1/8	130.2	3 3/8	85.7	PT91
6 21/32	169.1	1 3/4	44.4	13/16	20.6	PT23568-MPG	7	177.8	5 1/8	130.2	3 3/8	85.7	PT9430-MPG
6 21/32	169.1	2 7/32	56.4	29/32	23.8	PT9304-MPG	7 1/32	178.6	1 21/32	42.1	7/8	22.2	PT23524-MPG
6 21/32	169.1	4 5/8	117.5	2 5/16	58.7	PT7616	7 1/32	178.6	3 3/4	95.3	21/32	16.7	PF680
6 11/16	169.9	1 21/32	42.1	1 1/32	26.2	PT23460	7 1/32	178.6	3 3/4	95.3	21/32	16.7	PF7748
6 11/16	169.9	2 7/32	56.4	1	25.4	PT9493-MPG	7 1/32	178.6	3 3/4	95.3	21/32	16.7	PF7755
6 11/16	169.9	2 7/32	56.4	1	25.4	PT23358-MPG	7 1/32	178.6	3 13/16	96.8	21/32	16.7	PF7894
6 11/16	169.9	3 1/16	77.8	1 9/16	39.7	PT9307-MPG	7 1/32	178.6	3 13/16	96.8	21/32	16.7	PF7895
6 11/16	169.9	3 9/32	83.3	1 9/16	39.7	P7235	7 1/32	178.6	3 27/32	97.6	21/32	16.7	PF7782
6 11/16	169.9	3 9/16	90.5	31/32	24.6	P7615	7 1/32	178.6	4 3/16	106.4	21/32	16.7	PF7928
6 23/32	170.7	1 23/32	43.7	27/32	21.4	PT9143	7 1/32	178.6	4 3/16	106.4	21/32	16.7	PF9814
6 23/32	170.7	3 3/16	81.0	3/4	19.0	BF9839-D	7 1/32	178.6	4 7/32	107.2	21/32	16.7	PF46091
6 23/32	170.7	3 23/32	94.5	1/2	12.7	P54	7 1/32	178.6	4 7/32	107.2	21/32	16.7	PF46092
6 23/32	170.7	3 25/32	96.0	2 11/16	68.3	PT8883	7 1/32	178.6	2 1/32	51.6	1 7/32	31.0	PT463
6 23/32	170.7	4 5/32	105.6	3/4	19.0	F594-F	7 1/16	179.4	4 1/4	108.0	1 15/16	49.2	P7084
6 23/32	170.7	5 1/16	128.6	19/32	15.1	P7093	7 1/16	179.4	4 17/32	115.1	1 25/32	45.2	PT154
6 3/4	171.5	1 3/4	44.4	13/16	20.6	PT23095-MPG	7 1/16	179.4	4 17/32	115.1	2 9/32	57.9	P204
6 3/4	171.5	1 27/32	46.8	1	25.4	PT9267	7 1/16	179.4	4 17/32	115.1	2 9/32	57.9	P204-HD
6 3/4	171.5	1 27/32	46.8	1	25.4	PT9296-MPG	7 1/16	179.4	4 17/32	115.1	2 9/32	57.9	P204-HD10
6 3/4	171.5	3 5/16	84.1	1 1/4	31.8	P60	7 1/16	179.4	4 17/32	115.1	2 9/32	57.9	PT560 KIT
6 3/4	171.5	3 15/32	88.1	1	25.4	PF226	7 1/16	179.4	2 9/32	57.9	1 9/32	32.5	PT23321
6 3/4	171.5	4 5/32	105.6	1 7/8	47.6	P7106	7 3/32	180.2	2 9/32	57.9	1 9/32	32.5	PT23388-MPG
6 3/4	171.5	4 7/32	107.2	1	25.4	PF225	7 3/32	180.2	2 9/32	57.9	1 1/4	31.8	PT9535-MPG
6 25/32	172.2	1 27/32	46.8	1	25.4	PT9266	7 3/32	180.2	2 15/16	74.6	1 29/32	48.4	PT23493-MPG
6 25/32	172.2	3 9/32	83.3	21/32	16.7	BF7964-D	7 3/32	180.2	7 5/8	193.7	4 21/32	118.3	P7007
6 25/32	172.2	3 9/32	83.3	21/32	16.7	BF7989-D	7 1/8	180.8	4 7/32	106.9	11/16	0.7	PF46094
6 25/32	172.2	3 9/32	83.3	21/32	16.7	BF9837-D	7 1/8	181.0	4 3/8	111.1	31/32	24.6	PF9826
6 13/16	173.0	2 11/16	68.3	1 5/16	33.3	PT23028-MPG	7 1/8	181.0	4 1/2	114.3	1 25/32	45.2	PT433
6 13/16	173.0	2 23/32	69.1	1 11/32	34.1	PT9491-MPG	7 1/8	181.0	4 1/2	114.3	2 9/32	57.9	PT380 KIT
6 13/16	173.0	2 23/32	69.1	1 11/32	34.1	PT9490-MPG	7 5/32	181.8	3 9/32	83.3	—	—	BF46038-D
6 13/16	173.0	2 23/32	69.1	1 11/32	34.1	PT23361-MPG							



WARNING: These products can expose you to chemicals, including Diisononyl Phthalate, Carbon black extracts, Nickel, 1,3 Butadiene, Ethylene Oxide, Epichlorohydrin, which are known to the State of California to cause cancer, and Bisphenol-A, Ethylene Glycol, Ethylene Oxide, 1,3 Butadiene, Epichlorohydrin, which are known to the State of California to cause birth defects or other reproductive harm. For more information go to www.P65Warnings.ca.gov.

LIQUID ELEMENTS BY LENGTH

LENGTH Inches	LENGTH (mm)	O.D. Inches	O.D. (mm)	I.D. Inches	I.D. (mm)	BALDWIN NUMBER	LENGTH Inches	LENGTH (mm)	O.D. Inches	O.D. (mm)	I.D. Inches	I.D. (mm)	BALDWIN NUMBER
7 5/32	181.8	4 1/2	114.3	2 1/4	57.2	PT509-MPG KIT	7 5/8	193.7	3 23/32	94.5	1 27/32	46.8	PT9268
7 3/16	182.6	3 5/8	92.1	1 1/16	27.0	V738-O	7 5/8	193.7	3 3/4	95.3	1 1/16	27.0	PF9889
7 3/16	182.6	4 1/32	102.4	7/32	5.4	PF46238	7 5/8	193.7	3 7/8	98.4	-	-	PT304
7 3/16	182.6	4 1/8	104.6	13/16	20.3	PF46081	7 5/8	193.7	4 11/32	110.3	3/4	19.0	P249
7 3/16	182.6	4 1/8	104.6	13/16	20.3	PF46082	7 5/8	193.7	4 23/32	119.9	2 3/32	53.2	PT494
7 3/16	182.6	4 1/2	114.3	2 9/32	57.9	PT8339	7 5/8	193.7	6 1/32	153.2	1 23/32	43.7	P194
7 7/32	183.4	3 5/16	84.1	1 3/8	34.9	PF7896	7 5/8	193.7	6 1/32	153.2	1 23/32	43.7	P194-HD
7 7/32	183.4	3 13/32	86.5	1 1/2	38.1	PF7936	7 5/8	193.7	6 1/32	153.2	1 23/32	43.7	P194-HD10
7 7/32	183.4	4 5/32	105.4	1 23/32	43.7	PF46135	7 5/8	193.7	6 1/32	153.2	1 23/32	43.7	PF194
7 7/32	183.4	4 3/16	106.4			PT23124	7 5/8	193.7	6 1/32	153.2	1 23/32	43.7	PT394-5
7 7/32	183.4	4 7/32	107.2			PF46235	7 5/8	193.7	6 1/32	153.2	1 23/32	43.7	PT394-15
7 1/4	184.2	3 15/16	100.0	27/32	21.4	PT72	7 21/32	194.5	3 1/2	88.9	1 5/32	29.4	BF7949-D
7 1/4	184.2	4 1/2	114.3	2 1/4	57.2	PT426	7 21/32	194.5	3 1/2	88.9	1 5/32	29.4	BF7950-D
7 1/4	184.2	4 1/2	114.3	2 1/4	57.2	PT498	7 11/16	195.3	2 3/4	69.9	1 5/8	41.3	PT23060-MPG
7 1/4	184.2	4 1/2	114.3	2 1/4	57.2	PT498-10	7 11/16	195.3	3 3/16	81.0	9/16	14.3	BF9891-D
7 9/32	184.9	3 1/16	77.8	1 11/16	42.9	C740-S	7 11/16	195.3	3 1/4	82.6	1 1/2	38.1	PT7436
7 9/32	184.9	3 15/16	100.0	1 15/16	49.2	P7053	7 11/16	195.3	4 1/32	102.4	-	-	PT23481
7 5/16	185.7	2 5/8	66.7	1 1/4	31.8	PT289	7 11/16	195.3	4 1/32	102.4	-	-	PT23482
7 5/16	185.7	2 5/8	66.7	1 1/4	31.8	PT289-10	7 11/16	195.3	4 1/2	114.3	2 1/4	57.2	P721
7 5/16	185.7	2 5/8	66.7	1 1/4	31.8	PT290	7 23/32	196.1	3	76.2	1 1/16	27.0	PT265
7 11/32	186.5	3 5/16	84.1	1 5/32	29.4	BF7949-DM	7 23/32	196.1	3	76.2	1 1/16	27.0	PF907
7 11/32	186.5	3 5/16	84.1	1 5/32	29.4	BF7971-DM	7 23/32	196.1	5 29/32	150.0	3 7/16	87.3	PT23592
7 11/32	186.5	3 1/2	88.9	15/16	23.8	PT70	7 3/4	196.9	1 3/4	44.4	3/4	19.0	PT23083-MPG
7 3/8	187.3	1 13/16	46.0	13/16	20.6	PT23066-MPG	7 3/4	196.9	3 1/8	79.4	1 1/16	27.0	VT842-O
7 3/8	187.3	1 13/16	46.0	1 1/8	28.6	PT23067-MPG	7 3/4	196.9	3 3/8	85.7	2 1/8	54.0	PT23034-MPG
7 3/8	187.3	2 11/32	59.5	1 3/16	30.2	PT9434	7 3/4	196.9	3 15/32	88.1	3/4	19.0	BF46039-D
7 3/8	187.3	3 1/2	88.9	1 5/32	29.4	BF7951-D	7 3/4	196.9	3 19/32	91.3	1 29/32	48.4	PT9450-MPG
7 3/8	187.3	4 3/16	106.4	2	50.8	P7510	7 3/4	196.9	3 15/16	100.0	1 19/32	40.5	P7035
7 3/8	187.3	4 1/2	114.3	2 1/4	57.2	PT298-10	7 3/4	196.9	4 7/32	107.2	1/2	12.7	P42
7 13/32	188.1	4 25/32	121.4	2 5/32	54.8	P242	7 3/4	196.9	6 1/2	165.1	-	-	PT8334
7 7/16	188.9	2 29/32	73.8	1	25.4	PT513	7 25/32	197.6	2 15/32	62.7	1 1/16	27.0	PT210
7 7/16	188.9	3 3/8	85.7	1 7/8	47.6	PT562-10	7 25/32	197.6	3 1/8	79.4	15/16	23.8	BF46044-D
7 7/16	188.9	4 5/32	105.6	2 27/32	72.2	PT8982-MPG	7 25/32	197.6	3 3/16	81.0	13/16	20.6	BF9809-D
7 7/16	188.9	4 1/2	114.3	2 7/32	56.4	PT288-HD	7 25/32	197.6	3 3/16	81.0	13/16	20.6	BF9810-D
7 7/16	188.9	4 1/2	114.3	2 7/32	56.4	PT288-HD10	7 25/32	197.6	3 1/4	82.6	1 19/32	40.5	PT9284-MPG
7 15/32	189.7	4 5/32	105.6	2 13/16	71.4	PT9410-MPG	7 25/32	197.6	3 9/32	83.3	1 9/16	39.7	PT9152
7 15/32	189.9	5 27/32	148.3	1 5/32	29.7	PF46080	7 25/32	197.6	3 29/32	99.2	2 9/16	65.1	PT23472
7 1/2	190.5	2 11/16	68.3	1 5/16	33.3	PT23532-MPG	7 25/32	197.6	4 23/32	119.9	3 1/32	77.0	PT23473
7 1/2	190.5	2 7/8	73.0	1 1/8	28.6	PT445-MPG	7 25/32	197.6	6 1/2	165.1	1 19/32	40.5	PF529
7 1/2	190.5	3 5/16	84.1	1 11/16	42.9	PT23149	7 13/16	198.4	1 9/16	39.7	5/8	15.9	PF7828
7 1/2	190.5	3 15/16	100.0	2	50.8	PT277	7 13/16	198.4	1 3/4	44.4	3/4	19.0	PT23082-MPG
7 1/2	190.5	4 1/8	104.8	-	-	PF9928	7 13/16	198.4	1 25/32	45.2	25/32	45.2	PT9287-MPG
7 1/2	190.5	4 1/8	104.8	-	-	PF9929	7 13/16	198.4	2 3/16	55.6	1 25/32	45.2	PF46103
7 1/2	190.5	4 3/4	120.7	1 9/16	39.7	P998	7 13/16	198.4	3	76.2	1 1/16	27.0	PF810
7 1/2	190.5	6 1/2	165.1	3 15/32	88.1	PT520	7 13/16	198.4	3	76.2	1 1/16	27.0	PF902
7 17/32	191.3	15/16	23.8	25/32	19.8	PE17001	7 13/16	198.4	3	76.2	1 1/16	27.0	PF902-S
7 17/32	191.3	3 3/32	78.6	-	-	PT9447	7 13/16	198.4	3	76.2	1 1/16	27.0	PF910
7 17/32	191.3	3 1/4	82.6	1 1/2	38.1	P7437	7 13/16	198.4	3 1/4	82.6	1 1/2	38.1	PT23146
7 17/32	191.3	3 23/32	94.5	1 1/32	26.2	PF312	7 13/16	198.4	3 15/32	88.1	7/8	22.2	BF46041-D
7 17/32	191.5	6	152.4	2 15/32	63.0	PF46145	7 13/16	198.4	3 17/32	89.7	1 5/16	33.3	P235
7 9/16	192.1	3 15/16	100.0	1 23/32	43.7	P7107	7 13/16	198.4	3 3/4	95.3	1 31/32	50.0	PT567
7 9/16	192.1	4 5/32	105.6	2 27/32	72.2	PT9188	7 13/16	198.4	3 3/4	95.3	1 31/32	50.0	PT567-10
7 9/16	192.1	4 5/16	109.5	3	76.2	PT23215-MPG	7 27/32	199.2	1 25/32	45.2	3/4	19.0	PT9210
7 19/32	192.9	1 27/32	46.8	7/8	22.2	PT23373-MPG	7 27/32	199.2	1 13/16	46.0	3/4	19.0	PT8946-MPG
7 19/32	192.9	1 27/32	46.8	7/8	22.2	PT23378-MPG	7 27/32	199.2	2 5/16	58.7	1 1/16	27.0	PT9153
7 19/32	192.9	2 7/8	73.0	1 1/16	27.0	PF942	7 27/32	199.2	2 3/4	69.9	1 3/32	26.2	PT23308
7 19/32	192.9	3 9/32	83.3	15/16	23.8	P7305	7 27/32	199.2	2 3/4	69.9	1 1/4	31.8	PT9157
7 19/32	192.9	5 27/32	148.4	1 1/32	26.2	PF9804	7 27/32	199.2	3 9/32	83.3	13/16	20.6	P7016
7 5/8	193.7	3 9/32	83.3	21/32	16.7	BF7677-D	7 27/32	199.2	3 5/16	84.1	29/32	23.0	P7015
7 5/8	193.7	3 9/32	83.3	21/32	16.7	BF7682-D	7 27/32	199.2	3 19/32	91.3	1 29/32	48.4	PT8884-MPG
7 5/8	193.7	3 9/32	83.3	21/32	16.7	BF7746-D	7 27/32	199.2	3 11/16	93.7	1 7/8	47.6	PT676
7 5/8	193.7	3 9/32	83.3	21/32	16.7	BF7785-D	7 27/32	199.2	3 11/16	93.7	1 29/32	48.4	PT8992-MPG
7 5/8	193.7	3 9/32	83.3	21/32	16.7	BF7786-D	7 27/32	199.2	3 11/16	93.7	1 29/32	48.4	PT23216-MPG
7 5/8	193.7	3 9/32	83.3	21/32	16.7	BF7898-D	7 27/32	199.2	3 15/16	100.0	1 1/8	28.6	P7021
7 5/8	193.7	3 5/16	84.1	1 5/32	29.4	BF7971-D	7 27/32	199.2	4 3/8	111.1	2 13/32	61.1	PT9413-MPG
7 5/8	193.7	3 15/32	88.1	31/32	24.6	P102	7 7/8	199.9	3 31/32	101.1	1 5/16	33.0	PF46171
7 5/8	193.7	3 23/32	94.5	1 13/16	46.0	PT9390-MPG	7 7/8	200.0	1 3/4	44.4	7/16	11.1	F919-C



WARNING: These products can expose you to chemicals, including Diisononyl Phthalate, Carbon black extracts, Nickel, 1,3 Butadiene, Ethylene Oxide, Epichlorohydrin, which are known to the State of California to cause cancer, and Bisphenol-A, Ethylene Glycol, Ethylene Oxide, 1,3 Butadiene, Epichlorohydrin, which are known to the State of California to cause birth defects or other reproductive harm. For more information go to www.P65Warnings.ca.gov.

LIQUID ELEMENTS BY LENGTH

LENGTH Inches	LENGTH (mm)	O.D. Inches	O.D. (mm)	I.D. Inches	I.D. (mm)	BALDWIN NUMBER	LENGTH Inches	LENGTH (mm)	O.D. Inches	O.D. (mm)	I.D. Inches	I.D. (mm)	BALDWIN NUMBER
7 7/8	200.0	1 13/16	46.0	13/16	20.6	PT23006	8 1/16	204.8	4 3/8	111.1	2 7/16	61.9	PT761
7 7/8	200.0	1 13/16	46.0	13/16	20.6	PT23007	8 1/16	204.8	4 3/8	111.1	2 7/16	61.9	PT776-MPG
7 7/8	200.0	2 5/16	58.7	1 1/32	26.2	PT9197	8 1/16	204.8	4 1/2	114.3	2 1/4	57.2	PT561
7 7/8	200.0	2 5/16	58.7	1 1/32	26.2	PT9286-MPG	8 3/32	205.6	3 13/32	86.5	1 3/8	34.9	PT23561-MPG
7 7/8	200.0	2 3/8	60.3	1 1/2	38.1	PT23533	8 3/32	205.6	3 17/32	89.7	2 1/2	63.5	PT23445-MPG
7 7/8	200.0	2 13/16	71.4	1 1/8	28.6	P40030	8 3/32	205.6	3 25/32	96.0	2 7/32	56.4	PT23380-MPG
7 7/8	200.0	2 13/16	71.4	1 3/4	44.4	PT23327	8 3/32	205.6	3 25/32	96.0	2 7/32	56.4	PT23412-MPG
7 7/8	200.0	2 27/32	72.2	2 1/16	52.4	PT9187	8 3/32	205.6	3 25/32	96.0	2 7/32	56.4	PT23433-MPG
7 7/8	200.0	2 7/8	73.0	1 15/16	49.2	PT23201-MPG	8 3/32	205.6	4 17/32	115.1	2 1/4	57.2	PT442-MPG
7 7/8	200.0	3	76.2	1 1/8	28.6	P40110	8 3/32	205.6	4 3/4	120.7	2	50.8	P7508
7 7/8	200.0	3 5/16	84.1	-	-	PT9224	8 1/8	206.4	2 1/16	52.4	1	25.4	PT23266-MPG
7 7/8	200.0	3 3/8	85.7	-	-	PT9279	8 1/8	206.4	2 1/8	54.0	29/32	23.8	PT23091-MPG
7 7/8	200.0	3 3/8	85.7	1 7/8	47.6	PT23061-MPG	8 1/8	206.4	2 1/8	54.0	29/32	23.8	PT23092-MPG
7 7/8	200.0	3 1/2	88.9	2 1/4	57.2	PT23230-MPG	8 1/8	206.4	2 5/8	66.7	1 3/8	34.9	PT23035-MPG
7 7/8	200.0	3 9/16	90.5	-	-	PT9238	8 1/8	206.4	3 3/32	78.6	1 5/8	41.3	PT9144
7 7/8	200.0	3 9/16	90.5	1 7/8	47.6	PT23079-MPG	8 1/8	206.4	3 7/32	81.8	1 7/16	36.5	PT8330-MPG
7 7/8	200.0	3 21/32	92.9	1 23/32	43.7	PT8344	8 1/8	206.4	4 3/8	111.1	2 7/16	61.9	PT9405
7 7/8	200.0	4 7/16	112.7	1 17/32	38.9	PT115	8 5/32	207.2	1 25/32	45.2	1 1/32	26.2	H9056
7 7/8	200.0	4 3/4	120.7	2 1/16	52.4	PT7329	8 5/32	207.2	3 25/32	96.0	2 1/8	54.0	PT9425-MPG
7 7/8	200.0	4 13/16	122.2	-	-	PT716	8 5/32	207.2	3 13/16	96.8	1 11/16	42.9	PT9498-MPG
7 7/8	200.0	5 1/8	130.2	2 1/16	52.4	PT9507	8 5/32	207.2	6	152.4	4 5/32	105.6	PT23403-MPG
7 7/8	200.0	5 1/8	130.2	2 9/16	65.1	PT9217	8 5/32	207.2	6	152.4	4 5/32	105.6	PT23404-MPG
7 7/8	200.0	5 1/8	130.2	2 9/16	65.1	PT9272	8 3/16	208.0	1 3/4	44.4	15/16	23.8	PT23285-MPG
7 7/8	200.0	5 1/8	130.2	2 9/16	65.1	PT23048-MPG	8 3/16	208.0	1 25/32	45.2	1	25.4	PT9406-MPG
7 7/8	200.0	5 11/32	135.7	2 9/16	65.1	PT9183	8 3/16	208.0	2	50.8	15/16	23.8	PT23389-MPG
7 7/8	200.0	5 1/2	139.7	2 5/8	66.7	PT457-MPG	8 3/16	208.0	3	76.2	1 1/16	27.0	PT535
7 7/8	200.0	5 15/16	150.8	3 19/32	91.3	PT9351-MPG	8 3/16	208.0	3 3/32	78.6	1 21/32	42.1	H9076-V
7 7/8	200.0	5 15/16	150.8	3 19/32	91.3	PT9411-MPG	8 3/16	208.0	3 3/32	78.6	1 11/16	42.9	PT685-MPG
7 7/8	200.0	7	177.8	4 5/16	109.5	PT9518-MPG	8 3/16	208.0	3 5/32	80.2	1 11/16	42.9	H9103
7 7/8	200.0	7 3/32	180.2	4 5/32	105.6	PT23454	8 3/16	208.0	3 1/2	88.9	1 5/8	41.3	P40003
7 29/32	200.8	2 3/4	69.9	1	25.4	PT9395-MPG	8 3/16	208.0	3 29/32	99.2	2 1/16	52.4	PT23012
7 29/32	200.8	2 27/32	72.2	1 25/32	45.2	PT8999-MPG	8 3/16	208.0	4 1/2	114.3	7/8	22.2	PF155
7 15/16	201.6	2 3/4	69.9	1 21/32	42.1	PT9248	8 3/16	208.0	4 1/2	114.3	7/8	22.2	PF7597
7 15/16	201.6	2 13/16	71.4	1 5/8	41.3	PT23567-MPG	8 3/16	208.0	5 1/8	130.2	1 15/16	42.9	PT9168
7 15/16	201.6	2 7/8	73.0	1 11/32	34.1	PT8351	8 3/16	208.0	5 31/32	151.6	4 1/8	104.8	H9001
7 15/16	201.6	2 7/8	73.0	1 7/8	47.6	PT23391-MPG	8 7/32	208.8	1 3/4	44.4	1	25.4	H9051
7 15/16	201.6	3 11/16	93.7	1 13/16	46.0	PT23080-MPG	8 7/32	208.8	1 3/4	44.4	1	25.4	H9055
7 15/16	201.6	3 23/32	94.5	1 1/32	26.2	PF7984	8 7/32	208.8	1 3/4	44.4	1 1/32	26.2	H9045
7 31/32	202.4	4 9/16	115.9	2 7/32	56.4	PT390-MPG	8 7/32	208.8	1 3/4	44.4	1 1/32	26.2	H9046
7 31/32	202.4	4 9/16	115.9	2 7/32	56.4	PT391-MPG	8 7/32	208.8	1 3/4	44.4	1 1/32	26.2	H9047
8	203.2	1 5/32	29.4	2	50.8	PT23217-MPG	8 7/32	208.8	1 3/4	44.4	1 1/32	26.2	H9048
8	203.2	1 21/32	42.1	1 1/32	26.2	PT23495-MPG	8 7/32	208.8	1 25/32	45.2	15/16	23.8	H9231
8	203.2	2 29/32	73.8	1 13/32	35.7	PT9300-MPG	8 7/32	208.8	1 25/32	45.2	1	25.4	H9052
8	203.2	3 1/8	79.4	1 15/16	49.2	PT23407-MPG	8 7/32	208.8	2	50.8	15/16	23.8	H9111
8	203.2	3 7/32	81.8	1 25/32	45.2	PT9505-MPG	8 7/32	208.8	2	50.8	29/32	23.8	H9112
8	203.2	3 9/32	83.3	1 5/8	41.3	PT23310	8 7/32	208.8	2	50.8	29/32	23.8	H9113
8	203.2	3 23/32	94.5	1 25/32	45.2	PF7761	8 7/32	208.8	2	50.8	29/32	23.8	H9114
8	203.2	3 3/4	95.3	2 9/16	65.1	PT522	8 7/32	208.8	2	50.8	31/32	24.6	PT8425
8	203.2	3 31/32	100.8	1 3/4	44.4	PF7767	8 1/4	209.6	3 9/16	90.5	1 5/8	41.3	P7264
8	203.2	4 1/8	104.8	1 1/16	27.0	V852-O	8 1/4	209.6	1 25/32	45.2	1	25.4	PT23491-MPG
8	203.2	4 7/32	107.2	1/2	12.7	P52	8 1/4	209.6	1 31/32	50.0	31/32	24.6	PT23498-MPG
8	203.2	4 3/8	111.1	23/32	18.3	PT777	8 1/4	209.6	2	50.8	29/32	23.8	PT23437-MPG
8	203.2	4 3/8	111.1	2 1/32	51.6	PT8375-MPG	8 1/4	209.6	2 3/4	69.9	1 5/16	33.3	PT23076-MPG
8	203.2	4 3/8	111.1	2 7/16	61.9	PT760-10	8 1/4	209.6	2 3/4	69.9	1 5/16	33.3	PT23419-MPG
8	203.2	4 3/8	111.1	2 7/16	61.9	PT760-25	8 1/4	209.6	3 1/16	77.8	1 11/16	42.9	PT23396-MPG
8	203.2	6	152.4	3 17/32	89.7	PT191	8 1/4	209.6	3 1/16	77.8	1 11/16	42.9	PT23398-MPG
8	203.2	6	152.4	3 17/32	89.7	PT191-5	8 1/4	209.6	3 1/16	77.8	1 23/32	43.7	PT23395-MPG
8	203.2	6	152.4	3 17/32	89.7	PT191-10	8 1/4	209.6	3 1/16	77.8	1 23/32	43.7	PT23414-MPG
8 1/32	204.0	5 1/8	130.2	2 1/32	51.6	PT23496-MPG	8 1/4	209.6	3 3/32	78.6	1 23/32	43.7	PT23509-MPG
8 1/16	204.8	2 3/4	69.9	1 5/8	41.3	PT8948-MPG	8 1/4	209.6	3 1/8	79.4	1 11/16	42.9	H9073
8 1/16	204.8	3 5/16	84.1	-	-	PT23178	8 1/4	209.6	3 1/8	79.4	1 11/16	42.9	H9074
8 1/16	204.8	3 1/2	88.9	2 3/16	55.6	PT23161	8 1/4	209.6	3 1/8	79.4	1 11/16	42.9	H9075
8 1/16	204.8	3 1/2	88.9	2 3/16	55.6	PT23166	8 1/4	209.6	3 1/8	79.4	1 11/16	42.9	H9075-V
8 1/16	204.8	3 3/4	95.3	2 1/8	54.0	PT23283-MPG	8 1/4	209.6	3 1/8	79.4	1 11/16	42.9	H9076
8 1/16	204.8	3 29/32	99.2	1 5/8	41.3	PT23013	8 1/4	209.6	3 5/32	80.2	1 11/16	42.9	H9092
8 1/16	204.8	3 29/32	99.2	1 5/8	41.3	PT23015	8 1/4	209.6	3 11/16	93.7	1 19/32	40.5	PT9342-MPG
8 1/16	204.8	3 29/32	99.2	1 5/8	41.3	PT23015	8 1/4	209.6	3 29/32	99.2	2 1/32	51.6	PT23456



WARNING: These products can expose you to chemicals, including Diisononyl Phthalate, Carbon black extracts, Nickel, 1,3 Butadiene, Ethylene Oxide, Epichlorohydrin, which are known to the State of California to cause cancer, and Bisphenol-A, Ethylene Glycol, Ethylene Oxide, 1,3 Butadiene, Epichlorohydrin, which are known to the State of California to cause birth defects or other reproductive harm. For more information go to www.P65Warnings.ca.gov.

LIQUID ELEMENTS BY LENGTH

LENGTH Inches	LENGTH (mm)	O.D. Inches	O.D. (mm)	I.D. Inches	I.D. (mm)	BALDWIN NUMBER	LENGTH Inches	LENGTH (mm)	O.D. Inches	O.D. (mm)	I.D. Inches	I.D. (mm)	BALDWIN NUMBER
8 1/4.....	209.6	4 17/32.....	115.1	11/16.....	17.5	PF846	8 7/8.....	225.4	3 29/32.....	99.2	1 9/16.....	39.7	PT9227
8 1/4.....	209.6	4 31/32.....	126.2	3 5/8.....	92.1	PT23488-MPG	8 7/8.....	225.4	4 27/32.....	123.0	21/32.....	16.7	P7127
8 1/4.....	209.6	6.....	152.4	4 1/2.....	114.3	PT23405-MPG	8 29/32.....	226.2	3 29/32.....	99.2	1 9/16.....	39.7	PT8997-MPG
8 9/32.....	210.3	2 7/32.....	56.4	1 1/32.....	26.2	PT23576-MPG	8 29/32.....	226.2	4 5/16.....	109.5	13/16.....	20.6	PF7890
8 9/32.....	210.3	3 1/16.....	77.8	1 11/16.....	42.9	PT23131-MPG	8 29/32.....	226.2	4 5/16.....	109.5	13/16.....	20.6	PF7890-10
8 9/32.....	210.3	3 15/16.....	100.0	1 29/32.....	48.4	PT9501-MPG	8 29/32.....	226.2	4 5/16.....	109.5	13/16.....	20.6	PF7890-30
8 9/32.....	210.3	4 11/32.....	110.3	2 1/32.....	51.6	PF7618	8 15/16.....	227.0	2 15/16.....	74.6	1 1/2.....	38.1	PT23312
8 9/32.....	210.3	4 31/32.....	126.2	3 5/8.....	92.1	PT682	8 15/16.....	227.0	3 9/32.....	83.3	1 31/32.....	50.0	PT8459
8 9/32.....	210.3	5 5/32.....	131.0	2 15/32.....	62.7	PT9176	8 15/16.....	227.0	3 5/16.....	84.1	1 1/2.....	38.1	PF9829 KIT
8 5/16.....	211.1	2 7/8.....	73.0	1 3/16.....	30.2	PF845	8 15/16.....	227.0	4 1/2.....	114.3	1 23/32.....	43.7	PT475
8 5/16.....	211.1	3.....	76.2	1 13/16.....	46.0	PT23397-MPG	8 15/16.....	227.0	4 1/2.....	114.3	1 23/32.....	43.7	PT510
8 5/16.....	211.1	3 29/32.....	99.2	2 1/16.....	52.4	PT9291-MPG	8 15/16.....	227.0	4 1/2.....	114.3	1 25/32.....	45.2	PT86-HD
8 5/16.....	211.1	3 15/16.....	100.0	2 11/32.....	59.5	PT516	8 15/16.....	227.0	4 23/32.....	119.9	2 15/16.....	74.6	PT9258
8 5/16.....	211.1	3 15/16.....	100.0	2 11/32.....	59.5	PT8507-MPG	8 15/16.....	227.0	5 1/8.....	130.2	3 5/16.....	84.1	PT9483-MPG
8 5/16.....	211.1	5 5/16.....	134.9	2 1/2.....	63.5	PT23229-MPG	8 15/16.....	227.0	5 1/8.....	130.2	3 3/8.....	85.7	PT88-HD
8 5/16.....	211.1	5 29/32.....	150.0	—.....	—.....	PT9509	8 31/32.....	227.8	2 9/16.....	65.1	1 9/32.....	32.5	PT8484
8 11/32.....	211.9	4 11/32.....	110.3	1 27/32.....	46.8	PT7058	8 31/32.....	227.8	3 1/8.....	79.4	1 7/8.....	47.6	PT93
8 3/8.....	212.7	2 7/16.....	61.9	1 11/16.....	27.0	PT23267-MPG	8 31/32.....	227.8	3 1/8.....	79.4	1 7/8.....	47.6	PT93-MPG
8 3/8.....	212.7	3 1/8.....	79.4	1 23/32.....	43.7	H9096	8 31/32.....	227.8	3 21/32.....	92.9	1 23/32.....	43.7	PT577
8 3/8.....	212.7	3 1/8.....	79.4	1 23/32.....	43.7	H9097	8 31/32.....	227.8	3 21/32.....	92.9	2 5/32.....	54.8	PF1585
8 3/8.....	212.7	3 9/32.....	83.3	1 9/16.....	39.7	P7188	8 31/32.....	227.8	4 1/32.....	102.4	—.....	—.....	PT23475
8 3/8.....	212.7	3 13/32.....	86.5	2 1/8.....	54.0	PT23024	8 31/32.....	227.8	4 3/4.....	120.7	2 1/4.....	57.2	P507
8 3/8.....	212.7	3 1/2.....	88.9	1 9/16.....	39.7	PT23246-MPG	9.....	228.6	2 1/4.....	57.2	1 5/16.....	33.3	PT23103-MPG
8 3/8.....	212.7	3 29/32.....	99.2	2 1/16.....	52.4	PT23044-MPG	9.....	228.6	2 3/8.....	60.3	25/32.....	19.8	PT9372
8 3/8.....	212.7	4 5/8.....	117.5	7/8.....	22.2	PF7770	9.....	228.6	2 3/8.....	60.3	1 5/16.....	33.3	PT23093-MPG
8 13/32.....	213.5	1 31/32.....	50.0	31/32.....	24.6	PT23442-MPG	9.....	228.6	2 3/8.....	60.3	1 13/32.....	35.7	PT8958-MPG
8 13/32.....	213.5	1 31/32.....	50.0	31/32.....	24.6	PT23443-MPG	9.....	228.6	2 1/2.....	63.5	1 3/16.....	30.2	PT23162
8 13/32.....	213.5	3 9/32.....	83.3	1 5/8.....	41.3	P7145	9.....	228.6	2 3/4.....	69.9	1 13/16.....	46.0	PT23172
8 7/16.....	214.3	1 13/16.....	46.0	15/16.....	23.8	PT23448-MPG	9.....	228.6	2 7/8.....	73.0	1 13/32.....	35.7	PT66-HD
8 7/16.....	214.3	2 3/4.....	69.9	1 19/32.....	40.5	PT9264	9.....	228.6	3 7/8.....	98.4	2 5/16.....	58.7	PT23138
8 7/16.....	214.3	2 7/8.....	73.0	1 3/16.....	30.2	S16-1	9.....	228.6	4.....	101.6	1 1/2.....	38.1	F844-A
8 7/16.....	214.3	2 7/8.....	73.0	1 1/4.....	31.8	F845-A	9.....	228.6	4 1/2.....	114.3	2 1/4.....	57.2	PT381
8 7/16.....	214.3	3 1/2.....	88.9	1 5/16.....	33.3	P476	9.....	228.6	4 1/2.....	114.3	2 1/4.....	57.2	PT8331-MPG
8 1/2.....	215.9	2 11/16.....	68.3	1 9/16.....	39.7	PT23005	9.....	228.6	4 9/16.....	115.9	1 11/16.....	42.9	PT79
8 1/2.....	215.9	3 1/2.....	88.9	1 15/16.....	49.2	PT23274-MPG	9.....	228.6	4 27/32.....	123.0	2 7/8.....	73.0	PT538
8 1/2.....	215.9	3 15/16.....	100.0	2 1/2.....	63.5	PT23317	9.....	228.6	5.....	127.0	2 13/16.....	71.4	PT563
8 1/2.....	215.9	4.....	101.6	1 7/16.....	36.5	PT23041-MPG	9.....	228.6	5.....	127.0	2 13/16.....	71.4	PT566
8 1/2.....	215.9	5 15/16.....	150.8	3.....	76.2	PT23180	9.....	228.6	5.....	127.0	2 15/16.....	74.6	PT393
8 17/32.....	216.7	4 7/16.....	112.7	2 19/32.....	65.9	PT7330	9.....	228.6	5 1/8.....	130.2	3 3/8.....	85.7	PT90-10
8 17/32.....	216.7	6.....	152.4	3 17/32.....	89.7	PT193	9.....	228.6	5 1/8.....	130.2	3 3/8.....	85.7	PT90-MPG
8 17/32.....	216.7	6.....	152.4	3 17/32.....	89.7	PT193-3	9.....	228.6	5 1/8.....	130.2	3 3/8.....	85.7	PT8912
8 17/32.....	216.7	6.....	152.4	3 17/32.....	89.7	PT193 KIT	9.....	228.6	5 1/8.....	130.2	3 3/8.....	85.7	PT9418
8 9/16.....	217.5	2.....	50.8	1.....	25.4	PT23240-MPG	9.....	228.6	6.....	152.4	2 5/8.....	66.7	PT499-5
8 9/16.....	217.5	3 3/16.....	81.0	7/16.....	11.1	P352	9.....	228.6	6 25/32.....	172.2	3 15/16.....	100.0	PT98-10
8 9/16.....	217.5	3 7/32.....	81.8	—.....	—.....	PT23122	9.....	228.6	6 25/32.....	172.2	3 15/16.....	100.0	PT98-MPG
8 5/8.....	219.1	2 3/4.....	69.9	1 1/4.....	31.8	PT439	9.....	228.6	6 25/32.....	172.2	4 1/4.....	108.0	PT9427-MPG
8 5/8.....	219.1	3 29/32.....	99.2	1 9/16.....	39.7	PT9175	9 1/32.....	229.4	4 7/32.....	107.2	1 13/16.....	46.0	PT8338
8 5/8.....	219.1	3 29/32.....	99.2	1 25/32.....	45.2	PT9181	9 1/16.....	230.2	2 3/32.....	53.2	1 1/32.....	26.2	PT8978-MPG
8 5/8.....	219.1	5 1/2.....	139.7	4.....	101.6	PT9517	9 1/16.....	230.2	2 3/32.....	53.2	1 3/32.....	27.8	PT23503-MPG
8 21/32.....	219.9	2 3/32.....	53.2	1 1/4.....	31.8	PT23572-MPG	9 1/16.....	230.2	3 23/32.....	94.5	1 23/32.....	43.7	PT8378-MPG
8 21/32.....	219.9	2 3/4.....	69.9	1 11/16.....	42.9	PT23476	9 1/16.....	230.2	3 23/32.....	94.5	1 23/32.....	43.7	PT8456-MPG
8 21/32.....	219.9	4 25/32.....	121.4	5/8.....	15.9	P7512	9 1/16.....	230.2	4 7/16.....	112.7	1 1/2.....	38.1	P20-HD
8 21/32.....	219.9	4 13/16.....	122.2	21/32.....	16.7	P7267	9 1/16.....	230.2	4 7/16.....	112.7	1 1/2.....	38.1	PT385
8 11/16.....	220.7	2 5/8.....	66.7	1 7/32.....	31.0	P162	9 1/16.....	230.2	4 7/16.....	112.7	1 1/2.....	38.1	PT385-E
8 11/16.....	220.7	4 5/16.....	109.5	2 3/4.....	69.9	PT9170	9 1/16.....	230.2	4 1/2.....	114.3	1 25/32.....	45.2	PT436
8 11/16.....	220.7	4 7/16.....	112.7	2.....	50.8	P40019	9 1/16.....	230.2	4 17/32.....	115.1	2 9/32.....	57.9	PT275
8 11/16.....	220.7	5 1/32.....	127.8	1 1/2.....	38.1	PT7368	9 1/16.....	230.2	4 17/32.....	115.1	2 9/32.....	57.9	PT275-10
8 3/4.....	222.3	5 27/32.....	148.4	31/32.....	24.6	PF316	9 1/16.....	230.2	4 31/32.....	126.2	1 9/16.....	39.7	PT431
8 13/16.....	223.8	2 7/8.....	73.0	1 9/16.....	39.7	PT23025	9 1/16.....	230.2	5 1/8.....	130.2	3 3/8.....	85.7	PT8496-MPG
8 13/16.....	223.8	4 13/32.....	111.9	1 1/8.....	28.6	P40031-MPG	9 1/16.....	230.2	6 25/32.....	172.2	3 15/16.....	100.0	PT9441-MPG
8 13/16.....	223.8	4 13/32.....	111.9	2 3/4.....	69.9	PT9169	9 1/16.....	230.2	6 25/32.....	172.2	3 15/16.....	100.0	PT9444-MPG
8 27/32.....	224.6	2 3/4.....	69.9	1 5/8.....	41.3	PT8481	9 3/32.....	231.0	2 1/2.....	63.5	1 1/16.....	27.0	PT9158
8 7/8.....	225.4	2 3/4.....	69.9	1 5/8.....	41.3	PT9384-MPG	9 3/32.....	231.0	3.....	76.2	1 1/32.....	26.2	PF7878
8 7/8.....	225.4	2 13/16.....	71.4	1 9/16.....	39.7	PT23176	9 3/32.....	231.0	3 1/16.....	77.8	1 19/32.....	40.5	PT23340-MPG
8 7/8.....	225.4	3 1/4.....	82.6	1 7/8.....	47.6	PT9536-MPG	9 3/32.....	231.0	3 29/32.....	99.2	1 13/16.....	46.0	PT8370-MPG
8 7/8.....	225.4	3 5/16.....	84.1	1 1/8.....	28.6	PT181 KIT	9 3/32.....	231.0	5 1/8.....	130.2	3 3/8.....	85.7	PT568
8 7/8.....	225.4	3 5/8.....	92.1	2 1/2.....	63.5	PT23144							



WARNING: These products can expose you to chemicals, including Diisononyl Phthalate, Carbon black extracts, Nickel, 1,3 Butadiene, Ethylene Oxide, Epichlorohydrin, which are known to the State of California to cause cancer, and Bisphenol-A, Ethylene Glycol, Ethylene Oxide, 1,3 Butadiene, Epichlorohydrin, which are known to the State of California to cause birth defects or other reproductive harm. For more information go to www.P65Warnings.ca.gov.

LIQUID ELEMENTS BY LENGTH

LENGTH Inches	LENGTH (mm)	O.D. Inches	O.D. (mm)	I.D. Inches	I.D. (mm)	BALDWIN NUMBER	LENGTH Inches	LENGTH (mm)	O.D. Inches	O.D. (mm)	I.D. Inches	I.D. (mm)	BALDWIN NUMBER
9 1/8	231.8	2 1/8	54.0	1 1/8	28.6	PT23047-MPG	9 1/2	241.3	3	76.2	1 7/16	36.5	PT23261-MPG
9 1/8	231.8	2 1/8	54.0	1 1/8	28.6	PT23084-MPG	9 1/2	241.3	3 3/32	78.6	1 9/32	32.5	PT23544-MPG
9 1/8	231.8	3	76.2	1 9/16	39.7	PT23056-MPG	9 17/32	242.1	2 7/8	73.0	1 15/32	37.3	PT9389-MPG
9 1/8	231.8	3 11/16	93.7	2	50.8	PT23213-MPG	9 9/16	242.9	2 3/8	60.3	1 7/16	36.5	PT23516-MPG
9 1/8	231.8	3 29/32	99.2	1 5/8	41.3	PT8885-MPG	9 9/16	242.9	2 7/8	73.0	1 1/2	38.1	PT23556-MPG
9 1/8	231.8	4 1/2	114.3	1 25/32	45.2	PT401-MPG	9 9/16	242.9	3	76.2	1 9/16	39.7	PT23112-MPG
9 5/32	232.4	3 3/4	95.5	1 31/32	50.3	PT23597-MPG	9 9/16	242.9	3 7/8	98.4	1 9/32	32.5	PT23281-MPG
9 5/32	232.6	3 1/16	77.8	1 9/16	39.7	PT23339-MPG	9 9/16	242.9	4 3/8	111.1	3 5/8	92.1	PT471
9 5/32	232.6	3 17/32	89.7	1 9/16	39.7	PT8945-MPG	9 19/32	243.7	2 11/32	59.5	1 13/32	35.7	PT23444-MPG
9 5/32	232.6	3 15/16	100.0	1 9/16	39.7	PT8363	9 19/32	243.7	4 5/8	117.5	13/16	20.6	PF7973
9 3/16	233.4	3 1/16	77.8	1 1/2	38.1	PT23085-MPG	9 5/8	244.5	2 3/8	60.3	1	25.4	PT8498
9 3/16	233.4	3 15/32	88.1	1 11/32	34.1	PT375	9 5/8	244.5	2 5/8	66.7	1 1/8	28.6	PT23059-MPG
9 3/16	233.4	3 23/32	94.5	1 15/16	49.2	PT8404-MPG	9 5/8	244.5	2 5/8	66.7	1 1/8	28.6	PT23078-MPG
9 3/16	233.4	3 15/16	100.0	1 7/8	47.6	PT23209-MPG	9 5/8	244.5	2 11/16	68.3	1 1/8	28.6	PT23295-MPG
9 3/16	233.4	3 15/16	100.0	2 9/32	57.9	PT189	9 5/8	244.5	2 7/8	73.0	1	25.4	PT8329
9 3/16	233.4	3 15/16	100.0	2 9/32	57.9	PT189-MPG	9 5/8	244.5	2 7/8	73.0	1	25.4	PT8888
9 3/16	233.4	4 15/32	113.5	3/4	19.0	BF1392-SPS KIT	9 5/8	244.5	2 7/8	73.0	1 1/16	27.0	PT543 KIT
9 3/16	233.4	4 1/2	114.3	2 1/4	57.2	PT376	9 5/8	244.5	3 1/8	79.4	15/16	23.8	C40004
9 3/16	233.4	4 17/32	115.1	1 3/32	27.8	PF1291	9 5/8	244.5	3 1/4	82.6	7/8	22.2	PT9504-MPG
9 3/16	233.7	4 11/16	119.4	1 23/32	43.9	PA0069	9 5/8	244.5	3 15/16	100.0	19/32	15.1	P7052
9 7/32	234.2	3 15/16	100.0	1 5/8	41.3	PF7655	9 21/32	245.3	2 3/8	60.3	1	25.4	PT8458-MPG
9 1/4	235.0	2	50.8	1 1/4	31.8	PT23075-MPG	9 11/16	246.1	1 27/32	46.8	1	25.4	PT23382-MPG
9 1/4	235.0	2 1/2	63.5	1 3/16	30.2	PT23198-MPG	9 11/16	246.1	2 3/16	55.6	1 1/32	26.2	PT23284-MPG
9 1/4	235.0	3 1/16	77.8	1 1/2	38.1	PT23029-MPG	9 11/16	246.1	4 3/8	111.3	21/32	16.8	BF46128-D
9 1/4	235.0	3 1/16	77.8	1 17/32	38.9	PT8980-MPG	9 11/16	246.1	4 3/8	111.3	1 1/16	26.7	BF46064-D
9 1/4	235.0	3 1/2	88.9	1 5/8	41.3	PT9511	9 11/16	246.1	4 1/2	114.3	2 1/4	57.2	PT725-MPG
9 1/4	235.0	3 17/32	89.7	1 5/8	41.3	PT737	9 11/16	246.1	4 31/32	126.2	1 9/16	39.7	P999-HD
9 1/4	235.0	3 17/32	89.7	1 5/8	41.3	PT737-10	9 11/16	246.1	6 1/16	154.0	3 1/4	82.6	301
9 1/4	235.0	3 29/32	99.2	1 5/8	41.3	PT9297-MPG	9 11/16	246.1	6 1/16	154.0	3 1/4	82.6	301-30
9 1/4	235.0	3 29/32	99.2	1 21/32	42.1	PT23477	9 11/16	246.1	6 1/16	154.0	3 1/4	82.6	301-CS
9 1/4	235.0	3 29/32	99.2	1 21/32	42.1	PT23514-MPG	9 11/16	246.1	6 1/16	154.0	3 1/4	82.6	301-MPG
9 1/4	235.0	3 15/16	100.0	1 5/8	41.3	PT487	9 11/16	246.1	6 1/16	154.0	3 1/4	82.6	301-W
9 1/4	235.0	3 15/16	100.0	1 5/8	41.3	PT708-HD	9 23/32	246.9	2 3/8	60.3	31/32	24.6	PT23135-MPG
9 1/4	235.0	3 15/16	100.0	1 15/16	49.2	PT8306-10	9 23/32	246.9	4 1/4	108.0	3 1/8	79.4	PT579
9 1/4	235.0	3 15/16	100.0	1 15/16	49.2	PT8306-25	9 23/32	246.9	6 1/16	154.0	1 15/32	37.3	501
9 1/4	235.0	3 15/16	100.0	2 9/32	57.9	PT9555	9 23/32	246.9	6 1/16	154.0	1 15/32	37.3	501-30
9 1/4	235.0	4 7/32	107.2	-	-	PT23306	9 23/32	246.9	6 1/16	154.0	1 15/32	37.3	501-W
9 1/4	235.0	5 1/8	130.2	3 3/8	85.7	P555	9 23/32	246.9	6 15/32	164.3	1 27/32	46.8	PT515
9 9/32	235.7	3 1/16	77.8	1 9/16	39.7	PT9313-MPG	9 3/4	247.7	1 3/4	44.4	13/16	20.6	PT23108-MPG
9 9/32	235.7	3 1/2	88.9	1 9/16	39.7	PT8452	9 3/4	247.7	1 3/4	44.4	13/16	20.6	PT23109-MPG
9 9/32	235.7	3 1/2	88.9	1 9/16	39.7	PT8470	9 3/4	247.7	2 1/4	57.2	1 3/16	30.2	PT23009
9 9/32	235.7	3 29/32	99.2	1 5/8	41.3	PT9397-MPG	9 3/4	247.7	2 5/16	58.7	1 1/16	27.0	PT23200-MPG
9 9/32	235.7	3 15/16	100.0	1 19/32	40.5	PT670	9 3/4	247.7	2 9/16	65.1	1 1/16	27.0	PF926
9 9/32	235.7	3 15/16	100.0	1 19/32	40.5	PT670-E	9 3/4	247.7	3 1/16	77.8	1 9/16	39.7	PT23111-MPG
9 9/32	235.7	3 15/16	100.0	1 19/32	40.5	PT707-HD	9 3/4	247.7	3 9/16	90.5	1 7/8	47.6	PF7946
9 9/32	235.7	3 15/16	100.0	1 19/32	40.5	PT707-HD3	9 3/4	247.7	4 1/8	104.8	1 1/4	31.8	V1044-O
9 9/32	235.7	3 15/16	100.0	1 19/32	40.5	PT707-HD10	9 3/4	247.7	4 1/4	108.0	3 1/8	79.4	PT9513
9 9/32	235.7	3 15/16	100.0	1 19/32	40.5	PT7332	9 3/4	247.7	4 1/2	114.3	2 1/4	57.2	PT139-10
9 9/32	235.7	4	101.6	2 5/16	58.7	PT9532	9 3/4	247.7	4 25/32	121.4	29/32	23.0	PT7185
9 9/32	235.7	4 19/32	116.7	2 5/32	54.8	PF7899	9 3/4	247.7	5 1/16	128.6	2 3/4	63.9	PT23119-MPG
9 5/16	236.5	3 1/8	79.4	1 13/32	35.7	PT23275-MPG	9 25/32	248.4	2 11/32	59.5	1 1/16	27.0	PT23347-MPG
9 5/16	236.5	3 3/16	81.0	1 19/32	40.5	PT23125-MPG	9 13/16	249.2	2 1/4	57.2	1 1/8	28.6	PT23117-MPG
9 5/16	236.5	3 5/8	92.1	1 3/4	44.4	PT23150	9 13/16	249.2	3	76.2	1	25.4	PT727-DL
9 5/16	236.5	3 15/16	100.0	1 11/16	42.9	PT23297	9 13/16	249.2	3 9/16	90.5	1 3/4	44.4	PF7947
9 5/16	236.5	3 15/16	100.0	2 9/32	57.9	PT8403-MPG	9 13/16	249.2	4 1/4	108.0	3 1/16	77.8	PT23323
9 5/16	236.5	3 15/16	100.0	2 7/16	61.9	PT23342-MPG	9 13/16	249.2	5 1/8	130.2	2 29/32	73.8	PT8951-MPG
9 5/16	236.5	4 19/32	116.7	1 3/32	27.8	PF7914	9 13/16	249.2	5 5/16	134.9	3	76.2	PT23185
9 5/16	236.5	5	127.0	2 3/16	55.6	PT146	9 13/16	249.2	5 27/32	148.4	31/32	24.6	PT116
9 11/32	237.3	2 29/32	73.8	1 1/4	31.8	PT8985-MPG	9 13/16	249.2	5 27/32	148.4	31/32	24.6	PF116
9 3/8	238.1	3 13/16	96.8	2	50.8	PT23181	9 27/32	250.0	3 29/32	99.2	1 5/8	41.3	PT23063-MPG
9 3/8	238.1	3 13/16	96.8	2	50.8	PT23182	9 27/32	250.0	4 31/32	126.2	3 5/8	92.1	PT23313
9 3/8	238.1	5 1/16	128.6	19/32	15.1	PT8335	9 27/32	250.0	4 31/32	126.2	3 5/8	92.1	PT23579-MPG
9 13/32	238.9	6 29/32	175.4	3 5/8	92.1	PT8411	9 27/32	250.0	5 1/8	130.2	3	76.2	PT23457
9 7/16	239.7	3 3/4	95.3	2 1/4	57.2	PT23257-MPG	9 27/32	250.0	5 1/8	130.2	3	76.2	PT23458
9 7/16	239.7	6 13/32	162.7	9/16	14.3	PT9472	9 27/32	250.0	5 1/8	130.2	3	76.2	PT23471
9 1/2	241.3	2 7/8	73.0	1 3/32	27.8	PT23518-MPG	9 27/32	250.0	5 1/8	130.2	3	76.2	PT23502-MPG
9 1/2	241.3	2 7/8	73.0	1 17/32	38.9	PT23580-MPG	9 7/8	250.8	5 27/32	148.4	1 3/8	34.9	PF7980



WARNING: These products can expose you to chemicals, including Diisononyl Phthalate, Carbon black extracts, Nickel, 1,3 Butadiene, Ethylene Oxide, Epichlorohydrin, which are known to the State of California to cause cancer, and Bisphenol-A, Ethylene Glycol, Ethylene Oxide, 1,3 Butadiene, Epichlorohydrin, which are known to the State of California to cause birth defects or other reproductive harm. For more information go to www.P65Warnings.ca.gov.

LIQUID ELEMENTS BY LENGTH

LENGTH Inches	LENGTH (mm)	O.D. Inches	O.D. (mm)	I.D. Inches	I.D. (mm)	BALDWIN NUMBER	LENGTH Inches	LENGTH (mm)	O.D. Inches	O.D. (mm)	I.D. Inches	I.D. (mm)	BALDWIN NUMBER
9 7/8.....	250.8	5 31/32.....	151.6	3 5/8.....	92.1	PT9515	11.....	279.4	4 1/2.....	114.3	1 25/32.....	45.2	PT386
9 15/16.....	252.4	4 1/4.....	108.0	1 15/16.....	49.2	PT466	11.....	279.4	5 1/16.....	128.6	3 11/32.....	84.9	PT83
9 31/32.....	253.2	5.....	127.0	31/32.....	24.6	PF811	11.....	279.4	5 1/16.....	128.6	3 11/32.....	84.9	PT83-MPG
10.....	254.0	2 7/8.....	73.0	1 13/32.....	35.7	PF924	11.....	279.4	5 1/8.....	130.2	—.....	—	PT9251
10.....	254.0	3 5/16.....	84.1	1 7/8.....	47.6	PT23386-MPG	11.....	279.4	9 1/8.....	231.8	4 1/4.....	108.0	PT23027
10.....	254.0	3 1/2.....	88.9	1 7/8.....	47.6	PT23089-MPG	11 1/32.....	280.2	3 15/16.....	100.0	1 9/16.....	39.7	PT23585
10.....	254.0	3 17/32.....	89.7	2 1/32.....	51.6	PT213	11 1/16.....	281.0	3 1/16.....	77.8	1 19/32.....	40.5	PT23325
10.....	254.0	4 1/32.....	102.4	1 25/32.....	45.2	P7319	11 1/16.....	281.0	3 1/16.....	77.8	1 19/32.....	40.5	PT23590
10.....	254.0	4 19/32.....	116.7	1 9/16.....	39.7	PF9908 KIT	11 1/16.....	281.0	3 15/16.....	100.0	2 11/32.....	59.5	PT517
10.....	254.0	5 1/2.....	139.7	2 15/32.....	62.7	F908-A	11 1/16.....	281.0	5.....	127.0	2 13/16.....	71.4	PT285
10.....	254.0	5 3/4.....	146.0	1 9/16.....	39.7	DF408	11 1/16.....	281.0	5 1/8.....	130.2	3 11/32.....	84.9	PT8461
10.....	254.0	7 11/16.....	195.3	7/8.....	22.2	C704-L	11 3/32.....	281.7	3 15/16.....	100.0	1 23/32.....	43.7	PF46106
10 1/32.....	254.8	2 3/8.....	60.3	1 11/32.....	34.1	PT9502-MPG	11 1/8.....	282.6	3 9/16.....	90.5	1 3/4.....	44.4	P7502
10 1/32.....	254.8	3 3/16.....	81.0	1 7/8.....	47.6	PT23020	11 1/8.....	282.6	3 9/16.....	90.5	2 5/16.....	58.7	PT23165
10 1/32.....	254.8	3 1/4.....	82.6	1 27/32.....	46.8	PT23385-MPG	11 1/8.....	282.6	4 11/32.....	110.3	2 3/16.....	55.6	PT9341
10 1/32.....	254.8	3 9/32.....	83.3	1 27/32.....	46.8	PT23383-MPG	11 1/32.....	282.6	6 1/32.....	153.2	2.....	50.8	PT7193
10 1/32.....	254.8	3 9/32.....	83.3	1 7/8.....	47.6	PT9494-MPG	11 7/16.....	290.5	3 3/8.....	85.7	1 7/8.....	47.6	PT8359
10 1/16.....	255.6	3 3/16.....	81.0	1 7/8.....	47.6	PT23014	11 7/16.....	290.5	3 17/32.....	89.7	1 29/32.....	48.4	PT8479
10 1/16.....	255.6	3 3/16.....	81.0	1 7/8.....	47.6	PT23022	11 7/16.....	290.5	4 31/32.....	126.2	3 5/8.....	92.1	PT722
10 3/32.....	256.4	4 3/8.....	111.1	1 7/8.....	47.6	PT8427	11 7/16.....	290.5	4 31/32.....	126.2	3 5/8.....	92.1	PT7312
10 1/8.....	257.2	4 1/4.....	108.0	3.....	76.2	PT23187	11 7/16.....	290.5	4 31/32.....	126.2	3 5/8.....	92.1	PT8414-MPG
10 3/16.....	258.8	4 3/16.....	106.4	2 27/32.....	72.2	PT2868	11 7/16.....	290.5	4 31/32.....	126.2	3 5/8.....	92.1	PT8969-MPG
10 3/16.....	258.8	4 1/2.....	114.3	1 29/32.....	48.4	PT554	11 7/16.....	290.5	4 31/32.....	126.2	3 5/8.....	92.1	PT9254
10 3/16.....	258.8	5 1/8.....	130.2	2 1/2.....	63.5	PT23000	11 7/16.....	290.5	4 31/32.....	126.2	3 5/8.....	92.1	PT23390-MPG
10 3/16.....	258.8	5 1/8.....	130.2	2 17/32.....	64.3	PT9261-MPG	11 17/32.....	292.9	5 1/8.....	130.2	3 3/8.....	85.7	PT8506-MPG
10 3/16.....	258.8	5 1/8.....	130.2	2 9/16.....	65.1	PT23001	11 9/16.....	293.7	2 9/16.....	65.1	1 5/16.....	33.3	PT9503-MPG
10 7/32.....	259.6	2 27/32.....	72.2	1 3/4.....	44.4	PT9150	11 9/16.....	293.7	4 13/32.....	111.9	2 3/4.....	69.9	PT400
10 7/32.....	259.6	3 5/16.....	84.1	—.....	—	PT9331	11 9/16.....	293.7	4 13/32.....	111.9	2 3/4.....	69.9	PT8893
10 1/4.....	260.3	3 3/32.....	78.6	1 21/32.....	42.1	PT9409-MPG	11 9/16.....	293.7	5 1/8.....	130.2	3 3/8.....	85.7	PT539
10 1/4.....	260.3	3 29/32.....	99.2	1 19/32.....	40.5	PT23462	11 5/8.....	295.3	2 5/8.....	66.7	1 1/4.....	31.8	PT9526-MPG
10 1/4.....	260.3	3 29/32.....	99.2	1 19/32.....	40.5	PT23479	11 5/8.....	295.3	4.....	101.6	1 3/16.....	30.2	PF46010 KIT
10 1/4.....	260.3	3 29/32.....	99.2	1 19/32.....	40.5	PT23523-MPG	11 11/16.....	296.9	3 17/32.....	89.7	—.....	—	PT9446
10 1/4.....	260.3	4 1/8.....	104.8	2 13/16.....	71.4	PT23214-MPG	11 3/4.....	298.5	4 13/32.....	111.9	2 3/4.....	69.9	PT23598-MPG
10 1/4.....	260.3	4 5/32.....	105.6	2 3/4.....	69.9	PT8353	11 13/16.....	300.0	2 13/16.....	71.4	1 3/4.....	44.4	PT23163
10 1/4.....	260.3	4 3/16.....	106.4	2 27/32.....	72.2	PT23461	11 13/16.....	300.0	2 13/16.....	71.4	1 3/4.....	44.4	PT23459
10 1/4.....	260.3	4 7/32.....	107.2	1 1/4.....	31.8	BF46042-D	11 13/16.....	300.0	2 27/32.....	72.2	1 25/32.....	45.2	PT8400-MPG
10 1/4.....	260.3	4 7/32.....	107.2	1 1/4.....	31.8	BF46043-D	11 13/16.....	300.0	2 27/32.....	72.2	1 25/32.....	45.2	PT9479-MPG
10 1/4.....	260.3	4 1/4.....	108.0	1 11/16.....	42.9	PA0008	11 13/16.....	300.0	2 27/32.....	72.2	1 25/32.....	45.2	PT23504-MPG
10 1/4.....	260.3	5 1/8.....	130.2	2 15/32.....	62.7	PT9290-MPG	11 13/16.....	300.0	3 9/16.....	90.5	1 5/8.....	41.3	PT9148
10 9/32.....	261.1	2 23/32.....	69.1	1 29/32.....	48.4	PT23366-MPG	11 13/16.....	300.0	5 29/32.....	150.0	3 5/16.....	84.1	PT9375
10 9/32.....	261.1	4 3/16.....	106.4	2 27/32.....	72.2	PT8967-MPG	11 13/16.....	300.0	5 29/32.....	150.0	4 11/32.....	110.3	PT397
10 9/32.....	261.1	7 3/8.....	187.3	2 27/32.....	72.2	P7003	11 13/16.....	300.0	5 29/32.....	150.0	4 11/32.....	110.3	PT8889
10 5/16.....	261.9	3 1/2.....	88.9	2 1/2.....	63.5	PT23179	11 27/32.....	300.8	2 27/32.....	72.2	2 1/32.....	51.6	PT9132
10 5/16.....	261.9	4 29/32.....	124.6	2 1/16.....	52.4	PF7900	11 7/8.....	301.6	5.....	127.0	2 1/2.....	63.5	PT469
10 3/8.....	263.5	5 1/16.....	128.6	2 1/2.....	63.5	PT23019	11 7/8.....	301.6	5 1/16.....	128.6	11/16.....	17.5	PF7715
10 13/32.....	264.3	4 25/32.....	121.4	2 5/32.....	54.8	P294	11 29/32.....	302.4	5 5/8.....	142.9	4.....	101.6	PT23511-MPG
10 7/16.....	265.1	4 3/4.....	120.7	2.....	50.8	P7505	11 15/16.....	303.2	6 1/2.....	165.1	—.....	—	P7126
10 7/16.....	265.1	5 1/16.....	128.6	2 3/32.....	53.2	PF7799	11 31/32.....	304.0	2 3/4.....	69.9	1 5/8.....	41.3	PT23569-MPG
10 15/32.....	265.9	3 9/32.....	83.3	1/2.....	12.7	PF9879	12.....	304.8	4 1/8.....	104.8	1 1/16.....	27.0	V1240-C
10 15/32.....	265.9	4 3/4.....	120.7	2 1/16.....	52.4	P7230	12 1/8.....	308.0	2 5/8.....	66.7	15/16.....	23.8	PT23094-MPG
10 15/32.....	265.9	4 29/32.....	124.6	2.....	50.8	PT9429-MPG	12 1/8.....	308.0	5 9/16.....	141.3	4.....	101.6	PT23170
10 15/32.....	265.9	4 29/32.....	124.6	2 1/16.....	52.4	PT9407-MPG	12 1/8.....	308.0	5 9/16.....	141.3	4.....	101.6	PT23251-MPG
10 1/2.....	267.0	3 17/32.....	89.9	1 27/32.....	47.0	PT23637-MPG	12 1/8.....	308.0	5 11/16.....	144.5	4 3/32.....	104.0	PT8376-MPG
10 21/32.....	270.7	4 29/32.....	124.6	1 11/16.....	42.9	P7321	12 1/8.....	308.0	5 13/16.....	147.6	4 1/16.....	103.2	PT23173
10 11/16.....	271.5	5 13/16.....	147.6	3 1/2.....	88.9	PT23011	12 5/32.....	308.8	5 1/16.....	128.6	1 1/4.....	31.8	P996
10 23/32.....	272.3	5 29/32.....	150.0	4 5/16.....	109.5	PT23335	12 3/16.....	309.6	2 1/2.....	63.5	1 1/8.....	28.6	PT9499-MPG
10 13/16.....	274.3	4 3/32.....	104.1	13/16.....	20.3	PF46236	12 3/16.....	309.6	3 3/8.....	85.7	—.....	—	PT23530
10 13/16.....	274.3	4 3/32.....	104.1	13/16.....	20.3	PF46237	12 3/16.....	309.6	5 1/2.....	139.7	4 3/16.....	106.4	PT23331
10 13/16.....	274.6	3 11/16.....	93.7	1 7/8.....	47.6	PT23243-MPG	12 3/16.....	309.6	5 5/8.....	142.9	4.....	101.6	PT23156
10 7/8.....	276.2	3 5/8.....	92.1	1 13/16.....	46.0	PT9525-MPG	12 3/16.....	309.6	6 1/2.....	165.1	5 1/2.....	139.7	PT503
10 7/8.....	276.2	3 23/32.....	94.5	1 29/32.....	48.4	PT9359-MPG	12 1/4.....	311.2	3 15/16.....	100.0	1 21/32.....	42.1	PF869
10 7/8.....	276.2	4.....	101.6	2 3/8.....	60.3	PT23072-MPG	12 1/4.....	311.2	4 1/2.....	114.3	1 29/32.....	48.4	PT573
10 29/32.....	277.0	2 9/16.....	65.1	1 3/32.....	27.8	PT441	12 1/4.....	311.2	4 21/32.....	118.3	2 1/8.....	54.0	PT192
10 15/16.....	277.8	5 5/32.....	131.0	—.....	—	PT23186	12 1/4.....	311.2	6.....	152.4	2 25/32.....	70.6	PT567
10 31/32.....	278.6	3 29/32.....	99.2	3/4.....	19.0	PT9129	12 5/16.....	312.7	3 1/16.....	77.8	1 23/32.....	43.7	PT9381-MPG
11.....	279.4	3 3/4.....	95.3	1 15/16.....	49.2	PT23359-MPG	12 5/16.....	312.7	3 9/32.....	83.3	1 3/4.....	44.4	PT9373-MPG
							12 5/16.....	312.7	4 1/8.....	104.8	2 13/32.....	61.1	PT8490-MPG



WARNING: These products can expose you to chemicals, including Diisononyl Phthalate, Carbon black extracts, Nickel, 1,3 Butadiene, Ethylene Oxide, Epichlorohydrin, which are known to the State of California to cause cancer, and Bisphenol-A, Ethylene Glycol, Ethylene Oxide, 1,3 Butadiene, Epichlorohydrin, which are known to the State of California to cause birth defects or other reproductive harm. For more information go to www.P65Warnings.ca.gov.

LIQUID ELEMENTS BY LENGTH

LENGTH Inches	LENGTH (mm)	O.D. Inches	O.D. (mm)	I.D. Inches	I.D. (mm)	BALDWIN NUMBER	LENGTH Inches	LENGTH (mm)	O.D. Inches	O.D. (mm)	I.D. Inches	I.D. (mm)	BALDWIN NUMBER
12 3/8.....	314.3	4 1/2.....	114.3	2 23/32.....	69.1	PT23364-MPG	13 1/8.....	333.4	7.....	177.8	4 3/8.....	111.1	PT9528
12 15/32.....	316.7	3 21/32.....	92.9	1 7/8.....	47.6	PT683	13 3/16.....	335.0	3 25/32.....	96.0	2 3/16.....	55.6	H9058
12 1/2.....	317.5	2 7/8.....	73.0	1 5/16.....	33.3	PT9519-MPG	13 3/16.....	335.0	3 25/32.....	96.0	2 3/16.....	55.6	H9060
12 9/16.....	319.1	3 11/16.....	93.7	1 3/4.....	44.4	PT23081-MPG	13 3/16.....	335.0	4.....	101.6	2 7/16.....	61.9	PT9212
12 9/16.....	319.1	5 1/16.....	128.6	2 13/16.....	71.4	PT23315	13 7/32.....	335.8	8 13/16.....	223.8	4 1/16.....	103.2	P1568
12 19/32.....	319.9	3 11/16.....	93.7	1 29/32.....	48.4	PT23348-MPG	13 1/2.....	342.9	3 1/4.....	82.6	1 5/8.....	41.3	PT9529
12 5/8.....	320.7	3 11/16.....	93.7	1 7/8.....	47.6	PT23273-MPG	13 1/2.....	342.9	6.....	152.4	3 11/32.....	84.9	PT23497-MPG
12 5/8.....	320.7	3 3/4.....	95.3	1 7/8.....	47.6	PT23221-MPG	13 19/32.....	345.3	7 5/16.....	185.7	3 13/32.....	86.5	P7012
12 5/8.....	320.7	4 13/32.....	111.9	1 9/16.....	39.7	P40062	13 21/32.....	346.9	7 13/32.....	188.1	3 13/32.....	86.5	P7514
12 21/32.....	321.5	4 3/32.....	104.0	1 9/16.....	39.7	PT7495	13 3/4.....	349.3	2 13/16.....	71.4	1 13/16.....	46.0	PT23042-MPG
12 11/16.....	322.3	3 1/32.....	81.0	2.....	50.8	PT23441-MPG	13 13/16.....	350.8	4 31/32.....	126.2	3 5/8.....	92.1	PT23158
12 11/16.....	322.3	4 1/32.....	102.4	1/4.....	6.4	PT23159	13 7/8.....	352.4	3 1/2.....	88.9	1 27/32.....	46.8	PT8453
12 3/4.....	323.8	3 11/16.....	93.7	1 15/16.....	49.2	PT23247-MPG	14.....	355.6	2 3/8.....	60.3	1 1/32.....	26.2	PT23265-MPG
12 3/4.....	323.8	4 7/16.....	112.7	1 3/4.....	44.4	PT571	14.....	355.6	2 3/4.....	69.9	1 5/16.....	33.3	PT23356-MPG
12 27/32.....	326.2	3 13/16.....	96.8	1 11/16.....	42.9	H9036	14.....	355.6	2 3/4.....	69.9	1 3/8.....	34.9	PT23220-MPG
12 7/8.....	327.0	3 3/32.....	78.6	1 11/16.....	42.9	PT317-MPG	14.....	355.6	2 3/4.....	69.9	1 3/8.....	34.9	PT23272-MPG
12 7/8.....	327.0	3 3/32.....	78.6	1 11/16.....	42.9	PT318-MPG	14.....	355.6	2 3/4.....	69.9	1 3/8.....	34.9	PT23287-MPG
12 7/8.....	327.0	3 7/16.....	87.3	2.....	50.8	PT23238-MPG	14.....	355.6	2 3/4.....	69.9	1 3/8.....	34.9	PT23287-MPG
12 7/8.....	327.0	3 9/16.....	90.5	1 13/16.....	46.0	PT23244-MPG	14 3/32.....	358.0	5 3/8.....	136.5	3 5/32.....	80.2	PT8994-MPG
12 7/8.....	327.0	3 3/4.....	95.3	2 1/8.....	54.0	PT23224-MPG	14 1/8.....	358.8	3 17/32.....	89.7	1 27/32.....	46.8	PT9172
12 7/8.....	327.0	3 3/4.....	95.3	2 1/8.....	54.0	PT23228-MPG	14 3/16.....	360.4	3 1/2.....	88.9	1 7/8.....	47.6	PT9376
12 7/8.....	327.0	3 3/4.....	95.3	2 1/8.....	54.0	PT23231-MPG	14 3/16.....	360.4	6 7/8.....	174.6	3 5/8.....	92.1	PT8410
12 7/8.....	327.0	3 3/4.....	95.3	2 1/8.....	54.0	PT23241-MPG	14 7/32.....	361.2	5 31/32.....	151.6	3 15/16.....	100.0	PT23591-MPG
12 7/8.....	327.0	3 3/4.....	95.3	2 1/4.....	57.2	PT23223-MPG	14 9/32.....	362.7	5 21/32.....	143.7	3 3/4.....	95.3	PT9500-MPG
12 7/8.....	327.0	3 3/4.....	95.3	2 5/16.....	58.7	PT23291-MPG	14 1/2.....	368.3	6.....	152.4	1 1/8.....	28.6	PT117
12 7/8.....	327.0	3 13/16.....	96.8	1 11/16.....	42.9	PT23506-MPG	14 1/2.....	368.3	6.....	152.4	1 1/8.....	28.6	PT117-25
12 29/32.....	327.8	3 5/32.....	80.2	1 11/16.....	42.9	H9093	14 1/2.....	368.3	6.....	152.4	3 1/2.....	88.9	PT119
12 29/32.....	327.8	3 13/32.....	86.5	1 31/32.....	50.0	PT23440-MPG	14 1/2.....	368.3	6.....	152.4	3 1/2.....	88.9	PT119-5
12 29/32.....	327.8	3 15/32.....	88.1	1 19/32.....	40.5	PT23264-MPG	14 1/2.....	368.3	6.....	152.4	3 1/2.....	88.9	PT119-HD
12 29/32.....	327.8	3 1/2.....	88.9	1 31/32.....	50.0	PT9199	14 1/2.....	368.3	6.....	152.4	3 1/2.....	88.9	PT119-HD5
12 29/32.....	327.8	3 25/32.....	96.0	2 7/32.....	56.4	PT23401-MPG	14 1/2.....	368.3	1.....	153.2	1.....	25.4	PF949
12 15/16.....	328.6	3 5/32.....	80.2	1 9/16.....	39.7	PT9559-MPG	14 9/16.....	369.9	3 1/4.....	82.6	1 7/8.....	47.6	PT23049-MPG
12 15/16.....	328.6	3 5/32.....	80.2	1 23/32.....	43.7	H9078-V	14 5/8.....	371.5	3 1/4.....	82.6	1 7/8.....	47.6	PT23023
12 15/16.....	328.6	3 1/2.....	88.9	1 9/16.....	39.7	PT23010	14 21/32.....	372.3	5 13/32.....	137.3	3 15/16.....	100.0	PT23427-MPG
12 15/16.....	328.6	3 9/16.....	90.5	1 9/16.....	39.7	PT23276-MPG	14 11/16.....	373.1	3 1/4.....	82.6	1 13/16.....	46.0	PT23254-MPG
12 15/16.....	328.6	3 9/16.....	90.5	1 23/32.....	43.7	PT9303-MPG	14 11/16.....	373.1	3 9/32.....	83.3	1 27/32.....	46.8	PT23381-MPG
12 15/16.....	328.6	3 25/32.....	96.0	2 1/8.....	54.0	PT9432-MPG	14 11/16.....	373.1	3 9/32.....	83.3	1 7/8.....	47.6	PT9495-MPG
12 31/32.....	329.4	1 31/32.....	50.0	31/32.....	24.6	PT23410-MPG	14 11/16.....	373.1	3 5/16.....	84.1	2.....	50.8	PT23155
12 31/32.....	329.4	3 1/16.....	77.8	1 23/32.....	43.7	PT23438-MPG	14 3/4.....	374.7	2 7/8.....	73.0	1 9/16.....	39.7	PT23054-MPG
12 31/32.....	329.4	3 1/16.....	77.8	1 23/32.....	43.7	PT23507-MPG	14 3/4.....	374.7	3.....	76.2	1 9/16.....	39.7	PT23057-MPG
12 31/32.....	329.4	3 1/8.....	79.4	1 11/16.....	42.9	H9077	14 3/4.....	374.7	3 1/16.....	77.8	1 19/32.....	40.5	PT23353-MPG
12 31/32.....	329.4	3 1/8.....	79.4	1 11/16.....	42.9	H9078	14 3/4.....	374.7	3 1/16.....	77.8	1 19/32.....	40.5	PT23354-MPG
12 31/32.....	329.4	3 1/8.....	79.4	1 11/16.....	42.9	H9079	14 3/4.....	374.7	3 1/16.....	77.8	1 9/16.....	39.7	PT23050-MPG
12 31/32.....	329.4	3 1/8.....	79.4	1 11/16.....	42.9	H9080	14 7/8.....	377.8	3 13/16.....	96.8	2 1/2.....	63.5	PT23406-MPG
12 31/32.....	329.4	3 1/8.....	79.4	1 11/16.....	42.9	H9081	14 7/8.....	377.8	4.....	101.6	1 9/16.....	39.7	PT751
12 31/32.....	329.4	3 1/8.....	79.4	1 11/16.....	42.9	H9082	14 7/8.....	377.8	4 15/32.....	113.5	2 27/32.....	72.2	PT9162
12 31/32.....	329.4	3 25/32.....	96.0	2 7/32.....	56.4	PT9489-MPG	14 15/16.....	379.4	7 1/2.....	190.5	23/32.....	18.3	PT06-M
13.....	330.2	2 1/32.....	51.6	29/32.....	23.0	PT23432-MPG	15.....	381.0	3 1/16.....	77.8	1 19/32.....	40.5	PT23341-MPG
13.....	330.2	2 13/16.....	71.4	1 15/16.....	49.2	PT23278-MPG	15.....	381.0	3 1/8.....	79.4	1 1/2.....	38.1	PT23053-MPG
13.....	330.2	3.....	76.2	1 1/2.....	38.1	PT23393-MPG	15.....	381.0	3 17/32.....	89.7	2 1/16.....	52.4	PT23565-MPG
13.....	330.2	3.....	76.2	1 1/2.....	38.1	PT23416-MPG	15.....	381.0	3 3/4.....	95.3	1 1/16.....	27.0	V1544-T
13.....	330.2	3 1/16.....	77.8	1 11/16.....	42.9	PT23429-MPG	15.....	381.0	4 1/2.....	114.3	2 1/4.....	57.2	PT550-10
13.....	330.2	3 3/8.....	85.7	1 7/8.....	47.6	PT23052-MPG	15.....	381.0	6 5/16.....	160.3	7/8.....	22.2	PT7195
13.....	330.2	3 13/16.....	96.8	2 1/4.....	57.2	PT23277-MPG	15.....	381.0	6 1/2.....	165.1	5 1/2.....	139.7	PT418
13.....	330.2	4 3/8.....	111.1	2 9/16.....	65.1	PT23259-MPG	15 3/32.....	383.4	7 11/16.....	195.3	7/8.....	22.2	F7500
13.....	330.2	6.....	152.4	3 17/32.....	89.7	P537	15 3/32.....	383.4	7 11/16.....	195.3	7/8.....	22.2	F7500
13.....	330.2	7 31/32.....	202.4	6 3/16.....	157.2	PT23453	15 3/32.....	383.4	7 23/32.....	196.1	29/32.....	23.0	C750-E
13 1/32.....	331.0	4 3/8.....	111.1	2 13/32.....	61.1	PT766	15 3/32.....	383.4	7 23/32.....	196.1	29/32.....	23.0	C750-L
13 1/32.....	331.0	4 3/8.....	111.1	2 13/32.....	61.1	PT772	15 3/32.....	383.4	7 23/32.....	196.1	29/32.....	23.0	C750-L SINGLE
13 1/32.....	331.0	4 3/8.....	111.1	2 7/16.....	61.9	PT23137	15 5/32.....	385.0	2 7/8.....	73.0	1 11/32.....	34.1	PT8897-MPG
13 1/16.....	331.8	3 15/16.....	100.0	2 3/8.....	60.3	PT23154	15 1/4.....	387.4	6 1/2.....	165.1	3 15/32.....	88.1	PT8361
13 1/16.....	331.8	4 1/32.....	102.4	2 7/16.....	61.9	PT23582-MPG	15 9/32.....	388.1	3 27/32.....	97.6	2 9/16.....	65.1	PT23521-MPG
13 3/32.....	332.6	3 17/32.....	89.7	1 17/32.....	38.9	PT9161	15 5/16.....	388.9	6 25/32.....	172.2	4 7/32.....	107.2	PT370
13 1/8.....	333.4	4 3/8.....	111.1	1 7/8.....	47.6	PT8441	15 11/32.....	389.7	4 31/32.....	126.2	3 5/8.....	92.1	PT8433-MPG
13 1/8.....	333.4	4 1/2.....	114.3	2 11/16.....	68.3	PT8981-MPG	15 11/32.....	389.7	4 31/32.....	126.2	3 5/8.....	92.1	PT8970-MPG
13 1/8.....	333.4	4 1/2.....	114.3	2 11/16.....	68.3	PT23106-MPG	15 3/8.....	390.5	3 1/4.....	82.6	1 3/8.....	34.9	PT9530



WARNING: These products can expose you to chemicals, including Diisononyl Phthalate, Carbon black extracts, Nickel, 1,3 Butadiene, Ethylene Oxide, Epichlorohydrin, which are known to the State of California to cause cancer, and Bisphenol-A, Ethylene Glycol, Ethylene Oxide, 1,3 Butadiene, Epichlorohydrin, which are known to the State of California to cause birth defects or other reproductive harm. For more information go to www.P65Warnings.ca.gov.

LIQUID ELEMENTS BY LENGTH

LENGTH Inches	LENGTH (mm)	O.D. Inches	O.D. (mm)	I.D. Inches	I.D. (mm)	BALDWIN NUMBER	LENGTH Inches	LENGTH (mm)	O.D. Inches	O.D. (mm)	I.D. Inches	I.D. (mm)	BALDWIN NUMBER
15 3/8	390.5	3 9/16	90.5	4 1/4	108.0	PT23004	16 7/8	428.6	3 1/8	79.4	1 11/16	42.9	H9083
15 1/2	393.7	3 3/4	95.3	—	—	V1542-C	16 7/8	428.6	3 1/8	79.4	1 11/16	42.9	H9084
15 1/2	393.7	4 1/2	114.3	2 23/32	69.1	PT23362-MPG	16 7/8	428.6	3 1/8	79.4	1 11/16	42.9	H9085
15 1/2	393.7	6 3/16	157.2	2 7/32	56.4	V414-B	16 7/8	428.6	3 1/8	79.4	1 11/16	42.9	H9086
15 1/2	393.7	6 3/16	157.2	2 7/32	56.4	V414-FF	16 7/8	428.6	3 1/8	79.4	1 11/16	42.9	H9087
15 11/16	398.5	3 1/16	77.8	1 1/2	38.1	PT23113-MPG	16 7/8	428.6	3 3/8	85.7	1 15/16	49.2	PT23030-MPG
15 11/16	398.5	3 1/8	79.4	1 1/2	38.1	PT23114-MPG	16 7/8	428.6	3 25/32	96.0	2 7/32	56.4	PT8447-MPG
15 11/16	398.5	3 1/8	79.4	1 5/8	41.3	PT23068-MPG	16 7/8	428.6	6	152.4	3 1/4	82.6	H9020
15 11/16	398.5	3 17/32	89.7	1 19/32	40.5	PT23583-MPG	16 7/8	428.6	6	152.4	3 1/4	82.6	H9021
15 11/16	398.5	6	152.4	3 1/2	88.9	PT23116-MPG	16 7/8	428.6	6	152.4	4 1/32	102.4	PT23249-MPG
15 23/32	399.3	4 1/2	114.3	2 23/32	69.1	PT23033-MPG	16 29/32	429.4	3 25/32	96.0	2 7/32	56.4	PT23409-MPG
15 3/4	400.0	1 27/32	46.8	1	25.4	PT23578-MPG	16 31/32	431.0	6 1/8	155.6	4 13/16	122.2	PT9557
15 3/4	400.0	4 1/8	104.8	2 13/16	71.4	PT23101-MPG	17	431.8	3 1/16	77.8	1 13/16	46.0	PT23423-MPG
15 3/4	400.0	5 1/8	130.2	2 11/16	68.3	PT23120-MPG	17	431.8	6 1/2	165.1	2 3/4	69.9	V1874-T
15 3/4	400.0	5 15/16	150.8	3 19/32	91.3	PT9399-MPG	17 1/32	432.6	5 29/32	150.0	4 1/16	103.2	PT23546-MPG
15 27/32	402.4	3 23/32	94.5	1 29/32	48.4	PT23577-MPG	17 1/32	432.6	7	177.8	4 5/16	109.5	PT23545-MPG
15 29/32	404.0	5 1/8	130.2	2 17/32	64.3	PT23467	17 3/32	434.2	3 23/32	94.5	1 29/32	48.4	PT23352-MPG
15 29/32	404.0	5 1/8	130.2	2 9/16	65.1	PT23505-MPG	17 3/32	434.2	6 5/8	168.3	3 13/32	86.5	P1561
16	406.4	4 1/4	108.0	1 1/16	27.0	F1645-DS	17 1/8	435.0	3 7/8	98.4	1 1/2	38.1	PT23098-MPG
16	406.4	4 1/4	108.0	1 1/16	27.0	V1645-C	17 5/32	435.8	6	152.4	2 5/32	54.8	PT729
16	406.4	4 3/8	111.1	2 7/16	61.9	PT694	17 1/4	438.2	6 1/16	154.0	3 3/4	95.3	PT9452
16	406.4	4 3/8	111.1	2 7/16	61.9	PT8371-MPG	17 5/16	439.7	7 31/32	202.4	6 3/16	157.2	PT23483-MPG
16	406.4	4 1/2	114.3	1 1/16	27.0	V1656-O	17 1/2	444.5	3 11/16	93.7	1 13/16	46.0	PT23252-MPG
16	406.4	4 1/2	114.3	1 1/16	27.0	V1656-T	17 17/32	445.3	3 17/32	89.7	2 1/16	52.4	PT23566-MPG
16	406.4	5 5/16	134.9	2 1/2	63.5	PT23152	17 11/16	449.3	4 13/32	111.9	2 3/4	69.9	PT8387
16	406.4	6	152.4	2 5/8	66.7	PT718-5	17 23/32	450.1	5 29/32	150.0	4 11/32	110.3	PT483
16	406.4	7 21/32	194.5	4 21/32	118.3	P7337	17 23/32	450.1	5 29/32	150.0	4 11/32	110.3	PT8366
16 1/32	407.2	4 3/8	111.1	2 7/16	61.9	PT8442	17 23/32	450.1	5 29/32	150.0	4 11/32	110.3	PT8896
16 1/32	407.2	4 3/8	111.1	2 7/16	61.9	PT9340-MPG	17 23/32	450.1	5 29/32	150.0	4 11/32	110.3	PT9338-MPG
16 1/16	408.0	4 3/8	111.1	2 13/32	61.1	PT752	17 23/32	450.1	5 29/32	150.0	4 11/32	110.3	PT9357
16 1/16	408.0	4 3/8	111.1	2 13/32	61.1	PT8494	17 3/4	450.9	6	152.4	2 5/8	66.7	P415-5AN
16 1/16	408.0	4 3/8	111.1	2 13/32	61.1	PT9385-MPG	17 3/4	450.9	7	177.8	4 5/16	109.5	PT8478
16 1/16	408.0	4 3/8	111.1	2 7/16	61.9	PT763	17 3/4	450.9	7	177.8	4 5/16	109.5	PT8492
16 1/16	408.0	4 3/8	111.1	2 7/16	61.9	PT767	17 3/4	450.9	7	177.8	4 5/16	109.5	PT9379
16 1/16	408.0	4 3/8	111.1	2 7/16	61.9	PT773-MPG	17 13/16	452.4	6	152.4	2 5/8	66.7	PT23133-MPG
16 1/16	408.0	4 13/32	111.9	2 7/16	61.9	PT768	17 13/16	452.4	6 1/16	154.0	2 5/8	66.7	PT23451
16 1/8	409.6	3 5/16	84.1	1 1/2	38.1	PT9523-MPG	17 27/32	453.2	6 3/32	154.8	2 5/8	66.7	PT23485-MPG
16 5/32	410.4	5 1/8	130.2	2 17/32	64.3	PT9250	17 27/32	453.2	6 3/32	154.8	2 5/8	66.7	PT23508-MPG
16 3/16	411.2	4 1/2	114.3	2 3/4	69.9	PT9403-MPG	17 7/8	454.0	5 29/32	150.0	4 11/32	110.3	PT8380
16 7/32	412.0	4 1/2	114.3	2 1/2	63.5	PT9383-MPG	17 29/32	454.8	5 29/32	150.0	4 11/32	110.3	PT8383
16 7/32	412.0	4 1/2	114.3	2 19/32	65.9	PT23581-MPG	17 29/32	454.8	5 29/32	150.0	4 11/32	110.3	PT8909
16 7/32	412.0	5 1/8	130.2	2 15/32	62.7	PT8950-MPG	17 15/16	455.6	3 15/16	100.0	2 9/32	57.9	PT8305
16 1/4	412.8	3 1/2	88.9	1 1/2	38.1	PT23174	17 15/16	455.6	5 15/16	150.8	3 5/16	84.1	PT23600
16 5/16	414.3	5 27/32	148.3	1 5/32	29.7	PF46079	18	457.2	4 13/32	111.9	2 19/32	65.9	PT8408
16 11/32	415.1	3 27/32	97.6	2 17/32	64.3	PT23235-MPG	18	457.2	4 3/4	120.7	3	76.2	PT23245-MPG
16 11/32	415.1	3 27/32	97.6	2 17/32	64.3	PT23236-MPG	18	457.2	4 15/16	125.4	1 17/32	38.9	PT490
16 15/32	418.3	3	76.2	1 11/32	34.1	PT23271-MPG	18	457.2	5	127.0	3 1/2	88.9	PT23151
16 15/32	418.3	3 1/8	79.4	1 11/32	34.1	PT23279-MPG	18	457.2	6	152.4	2 1/8	54.0	P415-5
16 17/32	419.9	3 1/8	79.4	1 15/16	49.2	PT8495-MPG	18	457.2	6	152.4	2 1/8	54.0	P415-10
16 9/16	420.7	3 3/32	78.6	2 1/32	51.6	PT23417-MPG	18	457.2	6	152.4	2 1/8	54.0	P415-25
16 9/16	420.7	3 1/8	79.4	2	50.8	PT23226-MPG	18	457.2	6	152.4	2 5/8	66.7	P415-5A
16 11/16	423.9	5 19/32	142.1	3 7/8	98.4	PT9556-MPG	18	457.2	6	152.4	2 5/8	66.7	P415-10A
16 23/32	424.7	5 19/32	142.1	3 27/32	97.6	PT8436	18	457.2	6	152.4	2 5/8	66.7	P415-5A
16 13/16	427.0	3 3/32	78.6	1 5/8	41.3	PT23522-MPG	18	457.2	6	152.4	2 5/8	66.7	P415-25A
16 13/16	427.0	3 3/8	85.7	1 15/16	49.2	PT23237-MPG	18	457.2	6	152.4	2 23/32	69.1	PT491
16 13/16	427.0	3 3/8	85.7	1 15/16	49.2	PT23242-MPG	18	457.2	6	152.4	2 23/32	69.1	PT491-10
16 13/16	427.0	3 13/32	86.5	1 31/32	50.0	PT23402-MPG	18	457.2	6	152.4	3 1/2	88.9	PT122-5
16 13/16	427.0	3 13/32	86.5	1 31/32	50.0	PT23415-MPG	18	457.2	6	152.4	3 1/2	88.9	PT122-5
16 13/16	427.0	3 25/32	96.0	2 3/16	55.6	PT319-MPG	18	457.2	6 3/16	157.2	2 13/32	61.1	F415-B
16 13/16	427.0	3 25/32	96.0	2 3/16	55.6	PT320-MPG	18	457.2	6 3/16	157.2	2 13/32	61.1	V415-B
16 13/16	427.0	3 25/32	96.0	2 7/32	56.4	PT23394-MPG	18	457.2	6 3/16	157.2	2 13/32	61.1	V415-FF
16 13/16	427.0	5 29/32	150.0	4 5/32	105.6	PT23349-MPG	18	457.2	6 17/32	165.9	2 17/32	64.3	P415-GM
16 13/16	427.0	5 31/32	151.6	3 1/4	82.6	PT23355-MPG	18 1/32	458.0	4 13/32	111.9	2 9/16	65.1	PT8388
16 27/32	427.8	3 13/32	86.5	1 15/16	49.2	H9123	18 1/32	458.0	6	152.4	3 17/32	89.7	PT8491
16 27/32	427.8	5 31/32	151.6	4 1/8	104.8	H9007	18 1/16	458.8	6	152.4	2 5/8	66.7	PT212-5
16 7/8	428.6	3 3/32	78.6	1 1/2	38.1	PT8519-MPG	18 1/16	458.8	7 7/16	188.9	4 13/16	122.2	PT8395
							18 1/8	460.4	4 1/2	114.3	1 25/32	45.2	PT430-FF



WARNING: These products can expose you to chemicals, including Diisononyl Phthalate, Carbon black extracts, Nickel, 1,3 Butadiene, Ethylene Oxide, Epichlorohydrin, which are known to the State of California to cause cancer, and Bisphenol-A, Ethylene Glycol, Ethylene Oxide, 1,3 Butadiene, Epichlorohydrin, which are known to the State of California to cause birth defects or other reproductive harm. For more information go to www.P65Warnings.ca.gov.

LIQUID ELEMENTS BY LENGTH

LENGTH Inches	LENGTH (mm)	O.D. Inches	O.D. (mm)	I.D. Inches	I.D. (mm)	BALDWIN NUMBER	LENGTH Inches	LENGTH (mm)	O.D. Inches	O.D. (mm)	I.D. Inches	I.D. (mm)	BALDWIN NUMBER
18 5/32	461.2	6 1/8	155.6	3 15/16	100.0	PT9348-MPG	22	558.8	7 7/16	188.9	4 3/4	120.7	PT518-10
18 5/32	461.2	7 7/16	188.9	4 13/16	122.2	PT8396	22 1/32	559.6	7 7/16	188.9	4 27/32	123.0	PT23486-MPG
18 5/32	461.2	8 25/32	223.0	4 3/32	104.0	PF1584	22 13/16	579.4	4 15/16	125.4	3 1/4	82.6	PT9520-MPG
18 7/32	462.8	8 13/16	223.8	4 1/16	103.2	P1562	22 27/32	580.2	4 31/32	126.2	3 5/8	92.1	PT23517-MPG
18 1/4	463.6	4 1/8	104.8	2 3/4	69.9	PT23232-MPG	23 5/8	600.1	4 21/32	118.3	2 11/32	59.5	PT9283-MPG
18 9/32	464.3	3 15/16	100.0	2 17/32	64.3	PT9288-MPG	24 3/32	612.0	3 23/32	94.5	1 29/32	48.4	PT23450-MPG
18 9/32	464.3	4 5/32	105.6	2 27/32	72.2	PT9189	24 1/2	622.3	5 31/32	151.6	3 1/2	88.9	PT9247
18 5/16	465.1	4 5/32	105.6	2 27/32	72.2	PT8455-MPG	24 13/16	630.2	6 1/8	155.6	3 29/32	99.2	PT9451-MPG
18 5/16	465.1	4 3/16	106.4	2 13/16	71.4	PT23392-MPG	25 1/2	647.7	6	152.4	3 15/16	100.0	PT9350-MPG
18 5/16	465.1	4 3/16	106.4	2 13/16	71.4	PT23487-MPG	25 5/8	650.9	6	152.4	3 1/4	82.6	H9024
18 5/16	465.1	4 31/32	126.2	3 5/16	84.1	PT23520-MPG	25 21/32	651.7	3 3/8	85.7	2	50.8	PT9496-MPG
18 5/16	465.1	5	127.0	3 1/4	82.6	PT551-10	25 21/32	651.7	3 3/8	85.7	2	50.8	PT9497-MPG
18 5/16	465.1	5	127.0	3 1/4	82.6	PT9554-MPG	25 11/16	652.5	3 7/16	87.3	1 7/8	47.6	PT23250-MPG
18 7/16	468.3	3 11/16	93.7	1 15/16	49.2	PT23446-MPG	25 11/16	652.5	3 13/16	96.8	2 3/8	60.3	PT23435-MPG
18 7/16	468.3	5 7/32	132.6	3 3/8	85.7	PT9361	25 13/16	655.6	3 13/16	96.8	2 3/16	55.6	PT23422-MPG
18 1/2	469.9	3 21/32	92.9	1 3/4	44.4	PT8394-MPG	25 27/32	656.4	3 25/32	96.0	2 7/32	56.4	PT23420-MPG
18 1/2	469.9	3 21/32	92.9	1 3/4	44.4	PT23324	25 7/8	657.2	3 3/4	95.3	2 5/16	58.7	PT23413-MPG
18 1/2	469.9	3 7/8	98.4	1 5/8	41.3	PT23211-MPG	25 15/16	658.8	3 25/32	96.0	2 3/16	55.6	H9062
18 1/2	469.9	3 7/8	98.4	2 1/4	57.2	PT8446-MPG	26	660.4	7 7/8	200.0	6 5/8	168.3	PT23051-MPG
18 1/2	469.9	3 7/8	98.4	2 1/4	57.2	PT23616-MPG	27 11/16	703.3	4	101.6	1 3/4	44.4	PT23282-MPG
18 1/2	469.9	3 29/32	99.2	1 5/8	41.3	PT9487-MPG	27 11/16	703.3	4	101.6	1 15/16	49.2	PT23227-MPG
18 1/2	469.9	3 29/32	99.2	1 5/8	41.3	PT9488-MPG	28	711.2	3 15/16	100.0	1 11/16	42.9	PT23449-MPG
18 1/2	469.9	3 29/32	99.2	1 21/32	42.1	PT23515-MPG	29 1/4	742.9	6 3/16	157.2	2 1/2	63.5	V429-B
18 1/2	469.9	3 29/32	99.2	1 21/32	42.1	PT23519-MPG	29 1/4	742.9	6 3/16	157.2	2 1/2	63.5	V429-FF
18 1/2	469.9	3 29/32	99.2	1 27/32	46.8	PT8517-MPG	29 3/8	746.1	6 1/2	165.1	1 15/32	37.3	P1510
18 1/2	469.9	3 29/32	99.2	2 1/4	57.2	PT23595-MPG	30 3/32	764.4	6 13/32	162.7	1 15/32	37.3	P7183
18 1/2	469.9	3 15/16	100.0	1 19/32	40.5	PT757	30 1/2	774.7	6 3/16	157.2	1 23/32	43.7	V1520-R
18 1/2	469.9	3 15/16	100.0	1 19/32	40.5	PT757-10	31	787.4	4 3/8	111.1	1 5/8	41.3	C133-OW
18 9/16	471.5	3 1/2	88.9	1 9/16	39.7	PT8489	31	787.4	4 3/8	111.1	1 5/8	41.3	C133-W
18 9/16	471.5	3 1/2	88.9	1 9/16	39.7	PT8511	31 1/4	793.8	4 3/8	111.1	1 5/32	29.4	V7129-C
18 5/8	473.1	4 31/32	126.2	1 3/16	30.2	PT493	32	812.8	6 1/2	165.1	3 3/4	95.3	V1560
18 5/8	473.1	6 1/2	165.1	2 31/32	75.4	PT527	32 11/16	830.3	5 31/32	151.6	3 7/16	87.3	PT9328-MPG
18 13/16	477.8	4 15/16	125.4	3 5/8	92.1	PT9191	33 7/8	860.4	6 13/32	162.7	1 15/32	37.3	P1511
18 7/8	479.4	3 5/8	92.1	2 1/8	54.0	PT23070-MPG	36 1/2	927.1	5 13/32	137.3	3 15/16	100.0	PT23424-MPG
18 7/8	479.4	5	127.0	3 9/16	90.5	PT23234-MPG	36 1/2	927.1	5 13/32	137.3	3 15/16	100.0	PT23425-MPG
18 7/8	479.4	5 5/8	142.9	3 3/4	95.3	PT23253-MPG	36 1/2	927.1	5 13/32	137.3	3 15/16	100.0	PT23428-MPG
18 29/32	480.2	4	101.6	1 9/16	39.7	PT7617	36 1/2	927.1	6	152.4	3 15/16	100.0	PT23411-MPG
18 29/32	480.2	4 31/32	126.2	3 5/8	92.1	PT8971-MPG	36 1/2	927.1	6	152.4	3 15/16	100.0	PT23426-MPG
18 29/32	480.2	4 31/32	126.2	3 5/8	92.1	PT9306-MPG	36 1/2	927.1	6	152.4	3 15/16	100.0	PT23431-MPG
18 29/32	480.2	4 31/32	126.2	3 5/8	92.1	PT9445-MPG	36 1/2	927.1	6	152.4	3 15/16	100.0	PT23439-MPG
18 15/16	481.0	3 11/16	93.7	1 9/16	39.7	PT8891-MPG	36 11/16	931.9	5 1/2	139.7	3 3/4	95.3	PT23065-MPG
19	482.6	3 31/32	100.8	2 13/32	61.1	PT23588	36 11/16	931.9	5 1/2	139.7	3 13/16	96.8	PT23104-MPG
19	482.6	4	101.6	2 1/2	63.5	PT23318	36 3/4	933.5	2 3/8	60.3	-	-	F501-MD
19 1/32	483.4	5 21/32	143.7	3 25/32	96.0	PT23360-MPG	37 3/8	949.3	6 1/8	155.6	3 29/32	99.2	PT9459-MPG
19 7/16	493.7	4 5/32	105.6	2 27/32	72.2	PT8941-MPG	38 1/2	977.9	6	152.4	4 1/2	114.3	PT23248-MPG
19 7/16	493.7	5 5/16	134.9	3 3/4	95.3	PT23062-MPG	38 5/8	981.1	6	152.4	4 1/32	102.4	PT23255-MPG
19 1/2	495.3	2 7/8	73.0	1 1/16	27.0	PF952	38 11/16	982.7	5 31/32	151.6	4 1/8	104.8	H9013
19 1/2	495.3	3	76.2	1 11/16	42.9	TC413-CPE5	38 11/16	982.7	5 31/32	151.6	4 5/32	105.6	H9014
19 7/8	504.8	4 7/8	123.8	2 3/4	69.9	PT23139-MPG	38 13/16	985.8	3 25/32	96.0	2 7/32	56.4	PT23421-MPG
20	508.0	4 1/2	114.3	1 23/32	43.7	PT512	38 13/16	985.8	3 25/32	96.0	2 7/32	56.4	PT23434-MPG
20 9/32	515.1	5 7/8	149.2	4 1/2	114.3	PT23239-MPG	42 29/32	1089.8	7 31/32	202.4	6 3/16	157.2	PT23343-MPG
20 5/16	515.9	6	152.4	3 15/16	100.0	PT23589							
20 1/2	520.7	4 5/32	105.6	2 27/32	72.2	PT9244							
20 1/2	520.7	6 1/8	155.6	3 15/16	100.0	PT9355-MPG							
20 11/16	525.5	4 13/32	111.9	2 1/8	54.0	PT9443							
20 15/16	531.8	5 1/16	128.6	11/16	17.5	PF7716							
21	533.4	6 5/32	156.0			PT23613-MPG							
21 15/32	545.3	7 31/32	202.4	6 3/16	157.2	PT8990-MPG							
21 1/2	546.1	8	203.2	6 3/16	157.2	PT753							
21 1/2	546.1	9	228.6	7 3/32	180.2	PT8943-MPG							
21 9/16	547.7	8 15/16	227.0	7 1/16	179.4	PT9524-MPG							
21 23/32	551.7	3 11/16	93.7	1 7/8	47.6	PT23531-MPG							
22	558.8	7 7/16	188.9	4 3/4	120.7	PT518							



WARNING: These products can expose you to chemicals, including Diisononyl Phthalate, Carbon black extracts, Nickel, 1,3 Butadiene, Ethylene Oxide, Epichlorohydrin, which are known to the State of California to cause cancer, and Bisphenol-A, Ethylene Glycol, Ethylene Oxide, 1,3 Butadiene, Epichlorohydrin, which are known to the State of California to cause birth defects or other reproductive harm. For more information go to www.P65Warnings.ca.gov.

ROUND AIR FILTERS BY LENGTH

All Measurements in Inches and (Millimeters)

NOTE: All round air filters have been sorted by length and then outside diameter.
The larger outside and inside diameters have been listed.

LENGTH Inches	LENGTH (mm)	O.D. Inches	O.D. (mm)	I.D. Inches	I.D. (mm)	BALDWIN NUMBER	LENGTH Inches	LENGTH (mm)	O.D. Inches	O.D. (mm)	I.D. Inches	I.D. (mm)	BALDWIN NUMBER
19/32.....	15.1	1 31/32.....	50.0	1 13/32.....	35.7	PA30157	2 3/8.....	60.3	6 11/16.....	169.9	4 15/16.....	125.4	PA2036
15/16.....	23.8	2 7/16.....	61.9	1 31/32.....	50.0	S9475	2 3/8.....	60.3	10 1/16.....	255.6	7 21/32.....	194.5	PA1735
1.....	25.4	2 13/16.....	71.4	1 5/16.....	33.3	PA1909	2 3/8.....	60.3	10 1/8.....	257.2	7 15/16.....	201.6	PA1657
1 9/32.....	32.5	2 5/32.....	54.8	1 1/32.....	26.2	PA5276	2 3/8.....	60.3	11 3/16.....	284.2	9 3/32.....	231.0	PA10357
1 5/16.....	33.3	5.....	127.0	2 5/8.....	66.7	PA1627	2 7/16.....	61.9	8 1/2.....	215.9	6 15/16.....	176.2	PA2109
1 3/8.....	34.9	3.....	76.2	1 5/8.....	41.3	PA1704	2 7/16.....	61.9	10 1/4.....	260.4	8.....	203.2	PA2117
1 3/8.....	34.9	4.....	101.6	1 11/32.....	34.1	PA2256	2 15/32.....	62.7	5 19/32.....	142.1	4.....	101.6	PA2096
1 13/32.....	35.7	5 5/32.....	131.0	3 3/8.....	85.7	PA2070	2 15/32.....	62.7	7.....	177.8	5 9/16.....	141.3	PA2069
1 1/2.....	38.1	2 5/32.....	54.8	1 7/32.....	31.0	PA5316	2 15/32.....	62.7	7 27/32.....	199.2	5 9/16.....	141.3	PA30189
1 1/2.....	38.1	4 1/4.....	108.0	3.....	76.2	PA677	2 15/32.....	62.7	9.....	228.6	7 1/2.....	190.5	PA691
1 19/32.....	40.5	2 9/32.....	57.9	23/32.....	18.3	PA4978	2 1/2.....	63.5	10 1/32.....	254.8	8 17/32.....	216.7	PA2113
1 19/32.....	40.5	11 17/32.....	292.9	8 3/4.....	222.3	PA2124	2 1/2.....	63.5	10 3/8.....	266.6	7 7/16.....	188.9	PA10352
1 5/8.....	41.3	3 7/8.....	98.4	2 1/2.....	63.5	PA633(2)	2 1/2.....	63.5	11 13/16.....	300.0	9 13/16.....	249.2	PA2006
1 21/32.....	42.1	2 29/32.....	73.8	1 19/32.....	40.5	PA4778	2 1/2.....	63.5	13.....	330.2	11 9/32.....	286.5	PA2024
1 23/32.....	43.7	10 3/8.....	263.5	7 13/16.....	198.4	PA2147	2 17/32.....	64.3	4 9/32.....	108.7	2.....	50.8	PA30019
1 25/32.....	45.2	4 1/8.....	104.8	2 1/8.....	54.0	PA4824	2 9/16.....	65.1	2 15/16.....	74.6	1 7/8.....	47.6	PA1603
1 25/32.....	45.2	7.....	177.8	5 9/16.....	141.3	PA2068	2 9/16.....	65.1	5 3/4.....	146.1	3 1/2.....	88.9	PA696
1 25/32.....	45.2	11 7/32.....	285.0	9 3/8.....	238.1	PA2074	2 9/16.....	65.1	10 3/4.....	273.1	8 5/8.....	219.1	PA2007
1 13/16.....	46.0	1 31/32.....	50.0	1 1/8.....	28.6	PA2933	2 19/32.....	65.9	4 3/8.....	111.1	1 31/32.....	50.0	PA2477
1 13/16.....	46.0	2 7/32.....	56.4	1 13/32.....	35.7	SA10127	2 19/32.....	65.9	5 3/16.....	131.8	1 1/2.....	38.1	PA2347
1 13/16.....	46.0	10 7/32.....	259.6	7 7/32.....	183.4	PA3697	2 5/8.....	66.7	4 13/16.....	122.2	2 5/16.....	58.7	PA4910
1 7/8.....	47.6	9 11/16.....	246.1	8 3/16.....	208.0	PA658	2 5/8.....	66.7	12 5/16.....	312.7	10 13/16.....	274.6	PA2009
1 7/8.....	47.6	13 9/16.....	344.5	11 11/32.....	288.1	PA10356	2 5/8.....	66.7	13 7/8.....	352.4	11 5/8.....	295.3	PA2110
1 15/16.....	49.2	5 5/32.....	131.0	3 3/8.....	85.7	PA2071	2 21/32.....	67.5	13.....	330.2	9 1/8.....	231.8	PA2188
1 15/16.....	49.2	6 1/16.....	154.0	4 5/8.....	117.5	PA678	2 11/16.....	68.3	2 7/8.....	73.0	1 3/8.....	34.9	PA643
1 15/16.....	49.2	9.....	228.6	6 7/8.....	174.6	PA2031	2 11/16.....	68.3	4 13/16.....	122.2	2 5/16.....	58.7	PA4694
1 31/32.....	50.0	4 23/32.....	119.9	1 31/32.....	50.0	PA3959	2 11/16.....	68.3	11 31/16.....	284.2	9 1/16.....	230.2	PA2051
1 31/32.....	50.0	7.....	177.8	6 3/4.....	171.5	PA4187	2 23/32.....	69.1	2 17/32.....	64.3	1 1/2.....	38.1	PA4705
2.....	50.8	3 17/32.....	89.7	2.....	50.8	PA1834	2 23/32.....	69.1	2 17/32.....	64.3	1 1/2.....	38.1	PA4891
2.....	50.8	6 7/8.....	174.6	5 1/8.....	130.2	PA1814	2 23/32.....	69.1	4 31/32.....	126.2	2 5/16.....	58.7	PA4737
2.....	50.8	12 7/16.....	315.9	9 3/8.....	238.1	PA2065	2 3/4.....	69.9	2 3/4.....	69.9	1 1/4.....	31.8	PA2225
2 1/32.....	51.6	4.....	101.6	2 3/4.....	69.9	PA1661(3)	2 3/4.....	69.9	3 7/8.....	98.4	2 11/32.....	59.5	PA697
2 1/16.....	52.4	3 1/4.....	82.6	1 15/16.....	49.2	PA30035	2 3/4.....	69.9	3 7/8.....	98.4	2 3/8.....	60.3	PA2862
2 1/16.....	52.4	3 7/16.....	87.3	2 3/8.....	60.3	PA1757	2 3/4.....	69.9	6 23/32.....	170.7	5 1/2.....	139.7	PA3628
2 1/16.....	52.4	6 5/8.....	168.3	5.....	127.0	PA2050	2 3/4.....	69.9	7 7/16.....	188.9	4 9/32.....	108.7	PA2037
2 3/32.....	53.2	3 15/16.....	100.0	2 23/32.....	69.0	PA4830	2 3/4.....	69.9	10 1/16.....	255.6	7 21/32.....	194.5	PA615
2 3/32.....	53.2	9 11/16.....	246.1	7 15/16.....	201.6	PA2114	2 3/4.....	69.9	12 3/4.....	323.9	11.....	279.4	PA2010
2 1/8.....	54.0	3 3/4.....	95.3	2 1/32.....	51.6	PA1666	2 25/32.....	70.6	2 3/4.....	69.9	1 1/4.....	31.8	PA4556
2 1/8.....	54.0	7 29/32.....	200.8	6 1/2.....	165.1	PA2063	2 25/32.....	70.6	5 31/32.....	151.6	3 15/32.....	88.1	PA2072
2 1/8.....	54.0	11 13/16.....	300.0	9 13/16.....	249.2	PA1802	2 25/32.....	70.6	13 9/32.....	337.3	11 9/32.....	286.5	PA2002
2 5/32.....	54.8	3 25/32.....	96.0	2 1/32.....	51.6	PA4873	2 13/16.....	71.4	3 5/16.....	84.1	2 3/8.....	60.3	PA4872
2 5/32.....	54.8	5 3/4.....	146.1	3 1/2.....	88.9	PA2053	2 13/16.....	71.4	3 15/32.....	88.1	1 9/16.....	39.7	PA3412
2 3/16.....	55.6	2 15/16.....	74.6	1 15/16.....	49.2	PA1915	2 13/16.....	71.4	9 11/16.....	246.1	8 3/16.....	208.0	PA2106
2 3/16.....	55.6	10 7/8.....	276.2	9.....	228.6	PA2005	2 27/32.....	72.2	3 5/8.....	92.1	1 31/32.....	50.0	PA2476
2 3/16.....	55.6	11 3/32.....	281.8	8 1/2.....	215.9	PA2075	2 7/8.....	73.0	1 25/32.....	45.2	13/16.....	20.6	PA30302
2 3/16.....	55.6	18 5/16.....	465.1	14 15/16.....	379.4	PA631	2 7/8.....	73.0	3 13/16.....	96.8	1 5/16.....	33.3	PA2224
2 7/32.....	56.4	3 1/32.....	77.0	1 15/32.....	37.3	BT8429	2 7/8.....	73.0	4 5/32.....	105.6	2 15/32.....	62.7	PA5311
2 7/32.....	56.4	5 5/16.....	134.9	4.....	101.6	PA10399	2 29/32.....	73.8	5 7/8.....	149.2	3 7/16.....	87.3	PA3419
2 7/32.....	56.4	13 9/32.....	337.3	11 9/32.....	286.5	PA1828	2 29/32.....	73.8	3 7/8.....	98.4	2 3/8.....	60.3	PA4708
2 1/4.....	57.2	6 29/32.....	175.4	5 9/16.....	141.3	PA2226	2 29/32.....	73.8	12 15/16.....	328.6	9 9/16.....	242.9	PA5689
2 1/4.....	57.2	8 11/16.....	220.7	5 29/32.....	150.0	PA4893	2 15/16.....	74.6	4 11/32.....	110.3	2 7/16.....	61.9	PA4733
2 1/4.....	57.2	9 11/16.....	246.1	7 15/16.....	201.6	PA642	2 15/16.....	74.6	6 15/16.....	176.2	5 9/16.....	141.3	PA5737 KIT
2 1/4.....	57.2	9 23/32.....	246.9	6 7/8.....	174.6	PA2125	2 15/16.....	74.6	9 11/16.....	246.1	7 1/2.....	190.5	PA2154
2 1/4.....	57.2	10 1/32.....	254.8	8 17/32.....	216.7	PA2077	3.....	76.2	3.....	76.2	1 5/8.....	41.3	PA1985
2 5/16.....	58.7	2 7/32.....	56.4	1 1/32.....	26.2	PA1763	3.....	76.2	6 5/8.....	168.3	5.....	127.0	PA634
2 5/16.....	58.7	5 1/2.....	139.7	3 1/4.....	82.6	PA1832	3.....	76.2	6 21/32.....	169.1	4 3/32.....	104.0	PA1648
2 3/8.....	60.3	3 17/32.....	89.7	2 7/16.....	61.9	PA4727	3.....	76.2	6 31/32.....	177.0	5 19/32.....	142.1	PA3901
2 3/8.....	60.3	4 1/4.....	108.0	2 1/4.....	57.2	PA4829	3.....	76.2	7 7/8.....	200.0	4 1/8.....	104.8	PA1889
2 3/8.....	60.3	4 13/32.....	111.9	2 15/16.....	74.6	PA1712	3.....	76.2	8 1/4.....	209.6	6 1/2.....	165.1	PA650
							3.....	76.2	9 3/4.....	247.7	7 15/16.....	201.6	PA648



WARNING: These products can expose you to chemicals, including Diisononyl Phthalate, Carbon black extracts, Nickel, 1,3 Butadiene, Ethylene Oxide, Epichlorohydrin, which are known to the State of California to cause cancer, and Bisphenol-A, Ethylene Glycol, Ethylene Oxide, 1,3 Butadiene, Epichlorohydrin, which are known to the State of California to cause birth defects or other reproductive harm. For more information go to www.P65Warnings.ca.gov.

ROUND AIR FILTERS BY LENGTH

LENGTH Inches	LENGTH (mm)	O.D. Inches	O.D. (mm)	I.D. Inches	I.D. (mm)	BALDWIN NUMBER	LENGTH Inches	LENGTH (mm)	O.D. Inches	O.D. (mm)	I.D. Inches	I.D. (mm)	BALDWIN NUMBER
3	76.2	10 1/32	254.8	8 17/32	216.7	PA621	4	101.6	8 1/16	204.8	5 3/4	146.1	PA1698
3	76.2	12 15/16	328.6	10 7/16	265.1	PA1786	4	101.6	8 7/32	208.8	5 15/16	150.8	PA4871
3	76.2	13 7/8	352.4	11 5/8	295.3	PA1758	4	101.6	9 3/4	247.7	7 1/4	184.2	PA2095
3 1/32	77.0	2 27/32	71.9	1 1/16	26.9	CV15011	4	101.6	10 7/32	259.6	5 1/2	139.7	PA1618
3 1/32	77.0	6 7/32	158.0	4 27/32	123.0	PA2023	4	101.6	13 7/8	352.4	11 5/8	295.3	PA2073
3 1/32	77.0	6 11/32	161.1	4 5/32	105.6	PA1805	4	101.6	13 7/8	352.4	11 5/8	295.3	PA2079
3 1/16	77.8	6 13/16	173.0	5 1/16	128.6	PA699	4 1/32	102.4	4 5/32	105.6	1 1/4	31.8	PA3983-FN
3 1/16	77.8	11 5/16	287.3	8 9/16	217.5	PA625	4 1/32	102.4	7 13/32	188.1	4 11/32	110.3	PA10020
3 3/32	78.6	4 15/32	113.5	2 3/4	50.8	PA4902	4 1/16	103.2	6	152.4	4 5/8	117.5	PA2064
3 1/8	79.4	3 3/32	78.6	2 9/32	57.9	PA4883	4 1/16	103.2	7 3/16	182.6	3 15/16	100.0	PA3773
3 1/8	79.4	3 31/32	100.8	2 21/32	67.5	PA4758	4 1/16	103.2	9 23/32	246.9	7 5/16	185.7	PA44743
3 1/8	79.4	5 3/8	136.5	3 13/16	96.8	PA649	4 3/32	104.0	3 7/8	98.4	2 3/8	60.3	PA4900
3 1/8	79.4	5 23/32	143.3	3 1/4	77.8	PA1973	4 1/8	104.8	3 11/16	93.7	2 3/16	55.6	PA1748
3 1/8	79.4	6	152.4	4 5/8	117.5	PA2067	4 1/8	104.8	4 3/16	106.4	1 15/16	49.2	PA1858
3 1/8	79.4	10 1/8	257.2	7 1/2	190.5	PA1841	4 1/8	104.8	5 3/4	146.1	4 1/4	108.0	PA1857
3 5/32	80.2	2 23/32	69.1	1 5/16	33.3	PA4895	4 1/8	104.8	6 13/32	162.7	3 1/32	77.0	PA2182
3 5/32	80.2	4	101.6	2 3/4	69.9	PA4557	4 5/32	105.6	4 7/32	107.2	2 1/32	51.6	PA4764
3 3/16	81.0	6 21/32	169.1	5 3/32	129.4	PA30011	4 3/16	106.4	3 9/16	90.5	2 1/8	54.0	PA1859
3 7/32	81.8	4 5/32	105.6	2 13/16	71.4	PA4823	4 3/16	106.4	3 13/16	96.8	1 31/32	50.0	PA4732
3 1/4	82.6	5 11/16	144.5	2	50.8	PA1951	4 3/16	106.4	7 7/8	200.0	4 5/8	117.5	PA30028
3 1/4	82.6	8 13/32	213.5	6 19/32	167.5	PA657	4 3/16	106.4	7 15/16	201.6	6 9/32	159.5	PA1860
3 1/4	82.6	9	228.6	6 1/2	165.1	PA2107	4 3/16	106.4	8 1/32	204.0	5 5/16	134.9	PA2100
3 1/4	82.6	10 1/4	260.4	7 5/8	193.7	PA607	4 3/16	106.4	13 23/32	348.5	11 5/8	295.3	PA4711
3 9/32	83.3	4 21/32	118.3	2 3/4	69.9	PA4763	4 7/32	107.2	11 29/32	302.4	8 19/32	218.3	PA10112
3 9/32	83.3	5 1/2	139.7	3 1/4	82.6	PA4166	4 9/32	108.7	6 1/2	165.1	3 1/2	88.9	PA1852
3 9/32	83.3	7 27/32	199.2	4 27/32	123.0	PA5563	4 5/16	109.5	4 1/2	114.3	3 1/16	77.8	PA30020
3 5/16	84.1	4 1/4	108.0	3	76.2	PA675	4 5/16	109.5	12 5/8	320.7	8 17/32	216.7	PA2878
3 5/16	84.1	5 3/4	146.1	3 5/16	84.1	CV15006	4 11/32	110.3	11 7/8	301.6	7 1/2	190.5	PA2337
3 5/16	84.1	7 3/8	187.3	5 3/16	131.8	PA30025	4 3/8	111.1	8 1/2	215.9	3	76.2	PA2817
3 5/16	84.1	8 17/32	216.7	4 3/8	111.1	PA2479	4 13/32	111.9	7 9/32	184.9	4 21/32	118.3	PA2215
3 11/32	84.9	5 1/16	128.6	3 7/16	87.3	PA4810	4 13/32	111.9	12	304.8	8 19/32	218.3	PA4005
3 3/8	85.7	11 5/16	287.3	8 9/16	217.5	PA2081	4 7/16	112.7	5 1/32	127.8	2 27/32	72.2	PA4930
3 15/32	88.1	3 15/32	88.1	3 1/32	24.6	PA2798	4 7/16	112.7	7	177.8	4 7/8	123.8	PA680
3 15/32	88.1	9 1/2	241.3	6 11/32	161.1	PA4707	4 1/2	114.3	3 17/32	89.7	1 17/32	38.9	PA4158
3 15/32	88.1	11 13/16	300.0	9 13/16	249.2	PA2008	4 1/2	114.3	4 7/16	112.7	2 13/16	71.4	PA30301
3 1/2	88.9	3 7/16	87.3	2 3/8	60.3	PA1875	4 1/2	114.3	5 1/16	128.6	3 1/16	77.8	PA2044
3 1/2	88.9	7 3/8	187.3	4 5/16	109.5	PA2167	4 1/2	114.3	5 1/2	139.7	3 1/4	82.6	PA1718
3 1/2	88.9	8	203.2	5 3/4	146.1	PA612	4 19/32	116.3	3	76.2	1 21/32	42.1	PA4878
3 1/2	88.9	12 3/4	323.9	11	279.4	PA693	4 5/8	117.5	7	177.8	4 7/8	123.8	PA1891
7 3/8	89.7	3 11/32	161.1	3 17/32	89.7	PA10111	4 5/8	117.5	9 3/8	238.1	7 9/16	192.1	PA30013
3 17/32	89.7	10 7/8	276.2	9	228.6	PA2052	4 23/32	119.9	5 1/2	139.7	3 1/4	82.6	PA2001
3 9/16	90.5	9 21/32	245.3	8 1/4	209.6	PA1680	4 3/4	120.7	4 1/4	108.0	1 5/8	41.3	PA1633
3 5/8	92.1	3 1/16	77.8	1 9/16	39.7	PA644	4 3/4	120.7	4 13/32	111.9	2 15/16	74.6	PA2335
3 5/8	92.1	5 29/32	150.0	3 13/32	86.5	PA4741	4 3/4	120.7	8 1/16	204.8	5 25/32	146.8	PA30027
3 5/8	92.1	9 1/16	230.2	6 3/4	171.5	PA602	4 3/4	120.7	9 15/32	240.5	4 11/32	110.3	PA4641
3 21/32	92.9	3 1/4	82.6	1 31/32	50.0	PA30034	4 25/32	121.4	4 13/32	111.9	3 1/32	77.0	PA2038
3 21/32	92.9	6 1/2	165.1	3 15/32	88.1	PA3941	4 25/32	121.4	6 5/16	160.3	4 1/2	114.3	PA4713
3 21/32	92.9	6 1/2	165.1	3 1/2	88.9	PA3970	4 13/16	122.2	2 1/4	57.2	1 3/4	44.5	CV15001
3 11/16	93.7	4 5/16	109.5	2 7/8	73.0	PA1697	4 13/16	122.2	6 5/32	156.4	3 3/32	78.6	PA10117
3 11/16	93.7	5	127.0	3 9/16	90.5	PA1696	4 13/16	122.2	8 5/8	219.1	4 5/16	109.5	PA4649
3 11/16	93.7	9 3/4	247.7	6 1/16	154.0	PA1861	4 27/32	123.0	5 1/2	139.7	3 1/8	79.4	PA2978
3 3/4	95.3	3 1/8	79.4	1 1/2	38.1	PA1679	4 27/32	123.0	5 11/16	144.5	3 9/16	90.5	PA3457
3 3/4	95.3	4 1/4	108.0	2	50.8	PA2223	4 27/32	123.0	6 5/8	168.3	4 23/32	119.9	PA4389
3 3/4	95.3	9 9/16	242.9	7 1/4	184.2	PA2984	4 27/32	123.0	7 7/8	200.0	4 1/8	104.8	PA4072
3 13/16	96.8	7 15/16	201.6	4 31/32	126.2	PA4781	4 15/16	125.4	5	127.0	2 17/32	64.3	PA4706
3 13/16	96.8	8 1/4	209.6	6 13/32	162.7	PA3967	4 15/16	125.4	5 3/8	136.5	3 13/16	96.8	PA2162
3 7/8	98.4	6	152.4	4 5/8	117.5	PA652	4 15/16	125.4	5 3/4	146.1	3 1/2	88.9	PA2134
3 7/8	98.4	9 1/16	230.2	6 3/4	171.5	PA604	4 31/32	126.2	5 29/32	150.0	3 15/32	88.1	PA4715
3 15/16	100.0	3 1/4	82.6	2	50.8	PA1688							
3 15/16	100.0	7 31/32	202.4	3 27/32	97.6	PA5664	5	127.0	4 13/32	111.9	2 15/16	74.6	PA1639
3 15/16	100.0	8 1/4	209.6	5 7/8	149.2	PA1719	5	127.0	6 5/16	160.3	3 11/16	93.7	PA1963
3 31/32	100.8	5 3/4	146.1	3 1/2	88.9	PA2153	5	127.0	7	177.8	3 21/32	92.9	PA2858
							5	127.0	10 7/32	259.6	5 1/2	139.7	PA1619
4	101.6	5 15/16	150.8	3 1/4	82.6	PA669	5	127.0	11 7/16	290.5	8 5/8	219.1	PA2092
4	101.6	7 7/8	200.0	4 1/8	104.8	PA1949	5	127.0	11 7/16	290.5	8 5/8	219.1	PA2115
4	101.6	8 1/16	204.8	5 3/4	146.1	PA662	5	127.0	12 5/8	320.7	9 3/4	247.7	PA2061



WARNING: These products can expose you to chemicals, including Diisononyl Phthalate, Carbon black extracts, Nickel, 1,3 Butadiene, Ethylene Oxide, Epichlorohydrin, which are known to the State of California to cause cancer, and Bisphenol-A, Ethylene Glycol, Ethylene Oxide, 1,3 Butadiene, Epichlorohydrin, which are known to the State of California to cause birth defects or other reproductive harm. For more information go to www.P65Warnings.ca.gov.

ROUND AIR FILTERS BY LENGTH

LENGTH Inches	LENGTH (mm)	O.D. Inches	O.D. (mm)	I.D. Inches	I.D. (mm)	BALDWIN NUMBER	LENGTH Inches	LENGTH (mm)	O.D. Inches	O.D. (mm)	I.D. Inches	I.D. (mm)	BALDWIN NUMBER
5 1/32	127.8	10 27/32	275.4	6 1/2	165.1	PA2699	6 1/4	158.8	3 1/8	79.4	1 17/32	38.9	PA3565
5 1/8	130.2	6 11/16	169.9	2 5/8	66.7	PA2576	6 1/4	158.8	5 1/32	127.8	3 5/32	80.2	RS4130
5 1/8	130.2	9 3/8	238.1	4 21/32	118.3	PA3919	6 9/32	159.5	4 3/32	104.0	2 1/4	57.2	PA30021
5 3/16	131.8	3 7/16	87.3	31/32	24.6	PA3679	6 5/16	160.3	6 5/8	168.3	2 5/16	58.7	PA5326
5 3/16	131.8	4 3/32	104.0	1 13/32	35.7	PA4819	6 5/16	160.3	8 9/16	217.5	3 1/4	82.6	PA2827
5 3/16	131.8	5 21/32	143.7	3 1/2	88.9	PA4814	6 3/8	161.9	6 1/16	154.0	4	101.6	PA2884
5 3/16	131.8	7 13/16	198.4	3 5/8	92.1	PA3797	6 3/8	161.9	8 19/32	218.3	2 1/2	63.5	PA2828
5 3/16	131.8	7 7/8	200.0	6 1/8	155.6	PA1873	6 7/16	163.5	1 21/32	42.1	1 7/32	31.0	PA4633
5 3/16	131.8	12 1/4	311.2	9 7/16	239.7	PA654	6 15/32	164.3	8 1/16	204.8	5 23/32	145.3	PA4877
5 7/32	132.6	5 1/8	130.2	3 3/8	85.7	PA2139	6 1/2	165.1	7 5/16	185.7	5 5/16	134.9	PA1689
5 7/32	132.6	6 1/2	165.4	1 31/32	50.0	PA30284	6 9/16	166.7	9 5/8	244.5	5	127.0	PA1866
5 1/4	133.4	2 31/32	75.4	1 21/32	42.1	PA4939	6 19/32	167.5	5 5/8	142.9	2 13/32	61.1	PA4118
5 1/4	133.4	6 7/8	174.6	4 3/16	106.4	PA2404	6 19/32	167.5	7 11/32	186.5	4	101.6	PA10109
5 5/16	134.9	4 5/8	117.5	2 5/8	66.7	PA30015	6 5/8	168.3	1 11/16	42.9	1 3/16	30.2	RS3930
5 5/16	134.9	5	127.0	3 9/16	90.5	PA2140	6 5/8	168.3	8 5/32	207.2	4 3/16	106.4	RS3528
5 5/16	134.9	8 9/16	217.5	2 1/2	63.5	PA2825	6 5/8	168.3	9 1/8	231.8	6 7/8	174.6	PA638
5 11/32	135.7	6 5/8	168.3	2	50.8	PA2823	6 21/32	169.1	4 1/4	108.0	2 3/4	69.9	RS3537
5 3/8	136.5	5 1/2	139.7	1 3/4	44.5	PA4619	6 11/16	169.9	4 31/32	126.2	3 11/32	84.9	PA2099
5 13/32	137.3	6 11/16	169.9	2 11/32	59.5	PA2730	6 11/16	169.9	6 15/32	164.3	2 15/32	62.7	PA5444-FN
5 13/32	137.3	9 3/4	247.7	6 1/16	154.0	PA1916	6 23/32	170.7	2 1/8	53.6	1 5/8	41.4	RS30274
5 7/16	138.1	6 5/8	168.3	4 1/4	108.0	PA2725	6 23/32	170.7	5 1/4	133.4	2 27/32	72.2	PA2536
5 7/16	138.1	11 13/16	300.0	9 13/16	249.2	PA2091	6 3/4	171.5	8 1/2	215.9	4 5/8	117.5	RS10035
5 7/16	138.1	11 13/16	300.0	9 13/16	249.2	PA2148	6 25/32	172.2	3 11/16	93.7	1 11/16	42.9	PA3757
5 15/32	138.9	6 29/32	175.8	3 23/32	94.5	PA10123	6 25/32	172.2	5 3/16	131.8	2 5/8	66.7	PA2912
5 1/2	139.7	6 15/32	164.3	3	76.2	PA4897	6 13/16	173.0	5	127.0	3 9/16	90.5	PA2193
5 1/2	139.7	7 7/16	188.9	4 9/32	108.7	PA2156	6 27/32	173.8	5 7/16	138.1	3 5/32	80.2	RS4189
5 1/2	139.7	12 19/32	319.9	8 9/32	210.3	PA2483	6 7/8	174.6	5 3/8	136.5	3 15/16	100.0	PA3654
5 1/2	139.7	12 5/8	320.7	9 3/4	247.7	PA2472	6 29/32	175.4	13 7/8	352.4	7 7/16	188.9	PA2343
5 9/16	141.3	11 5/16	287.3	8 9/16	217.5	PA1798	6 15/16	176.2	3 17/32	89.7	1 25/32	45.2	PA4632
5 9/16	141.3	12	304.8	8 9/16	217.5	PA1800	6 15/16	176.2	3 3/4	95.3	1 21/32	42.1	RS4804
5 19/32	142.1	6 3/16	157.2	4 13/16	122.2	PA4813	6 15/16	176.2	5 11/32	135.7	3 5/32	80.2	RS10005
5 5/8	142.9	7 1/32	178.6	5 7/16	138.1	PA4848	6 31/32	177.0	2 3/4	69.9	1 31/32	50.0	PA3812
5 11/16	144.5	7 17/32	191.3	3 5/16	84.1	PA3863	6 31/32	177.0	3 17/32	89.7	2 13/32	61.1	PA3819
5 11/16	144.5	8 5/8	219.1	4 9/32	108.7	PA4648	6 31/32	177.0	6 5/16	160.3	3 29/32	99.2	PA3836
5 3/4	146.1	4 3/16	106.4	1 15/16	49.2	PA1946	7	177.8	3 17/32	89.7	1 17/32	38.9	RS5273
5 3/4	146.1	4 13/32	111.9	2 15/16	74.6	PA2083	7	177.8	3 17/32	89.7	1 3/4	44.5	RS3715
5 3/4	146.1	7 3/4	196.9	3 1/4	82.6	PA4647	7	177.8	6 7/8	174.6	5 1/8	130.2	PA1653
5 23/32	146.8	8 29/32	226.2	4 9/32	108.7	PA2042	7	177.8	8 7/16	214.3	6 1/2	165.1	PA30075
5 13/16	147.6	4 1/8	104.8	1 7/32	31.0	PA3880	7	177.8	8 19/32	218.3	7 19/32	192.9	PA3958
5 13/16	147.6	6 7/8	174.6	5 1/8	130.2	PA2102	7	177.8	11 7/16	290.5	8 5/8	219.1	PA2116
5 27/32	148.4	4 1/4	108.0	2 3/4	69.9	RS3529	7	177.8	11 11/16	296.9	7 25/32	197.6	PA2328
5 27/32	148.4	8 3/8	212.7	4	101.6	LL2575	7 1/32	178.6	3 7/8	98.4	3 3/16	81.0	PA3909
5 27/32	148.4	8 3/8	212.7	4	101.6	PA2575	7 1/32	178.6	4 13/32	111.9	2 15/16	74.6	PA640
5 7/8	149.2	4 1/2	114.3	1 1/2	38.1	PA2832	7 1/16	179.4	3 5/8	92.1	2 5/16	58.7	PA30101
5 7/8	149.2	4 19/32	116.7	1 5/8	41.3	PA3643	7 1/8	181.0	8 1/8	206.4	3 25/32	96.0	PA2763
5 29/32	150.0	6 23/32	170.7	3 1/32	77.0	PA4089	7 1/8	181.0	13	330.2	7 11/16	195.3	PA2403
5 31/32	151.6	3 25/32	96.0	7/8	22.2	CV15003	7 5/32	181.8	4 1/4	108.0	2 1/8	54.0	PA4665-FN
5 31/32	151.6	5 3/4	146.1	4 1/8	104.8	PA1721	7 5/32	181.8	4 13/32	111.9	2 23/32	69.1	RS10348
5 31/32	151.6	8 3/4	222.3	4 3/32	104.0	PA3890	7 5/32	181.9	3 17/32	89.4	2 9/32	57.7	RS30282
6	152.4	5 3/4	146.1	3 5/8	92.1	PA2136	7 3/16	182.6	2 1/8	54.0	1 11/16	42.9	PA30100
6	152.4	7	177.8	4 3/8	111.1	PA1888	7 3/16	182.6	4 1/2	114.3	2	50.8	PA3632
6	152.4	9 23/32	246.9	7 9/32	184.9	PA5665	7 7/32	183.4	9 1/8	231.8	6 7/8	174.6	PA651
6	152.4	10 7/32	259.6	5 1/2	139.7	PA671	7 1/4	184.2	4 7/32	107.2	1 11/16	42.9	PA5324-FN
6	152.4	10 1/4	260.4	7 3/8	187.3	PA671-1	7 1/4	184.2	4 1/4	108.0	1 27/32	46.8	PA1865-FN
6 1/32	153.2	5 1/8	130.2	2 15/32	62.7	PA4834-FN	7 1/4	184.2	4 1/4	108.0	1 27/32	46.8	PA3895-FN
6 1/32	153.2	5 9/32	134.1	1 15/32	37.3	PA30068	7 1/4	184.2	5	127.0	1 27/32	46.8	PA3664-FN
6 1/16	154.0	6 7/8	174.6	5 9/16	141.3	PA2340	7 1/4	184.2	5 31/32	151.6	3 13/32	86.5	PA10119
6 3/32	154.8	5	127.0	2 17/32	64.3	PA4716	7 1/4	184.2	6 27/32	173.8	3 3/4	95.3	RS5670
6 3/32	154.8	5 31/32	151.6	3 13/32	86.5	PA10126	7 1/4	184.2	15 1/16	382.6	7 7/16	188.9	PA1995
6 3/32	154.8	7 13/16	198.4	3 15/32	88.1	PA2589-FN	7 9/32	184.9	6 3/32	154.8	3 15/32	88.1	PA2613
6 1/8	155.6	4 3/16	106.4	1 15/16	49.2	PA1969	7 5/16	185.7	4 3/32	104.0	2 15/32	62.7	PA1921
6 1/8	155.6	6 3/32	154.8	3 15/32	88.1	PA2885	7 5/16	185.7	10 9/16	268.3	4 1/4	108.0	PA2830
6 3/16	157.2	6 7/8	174.6	4 3/16	106.4	PA1996	7 5/16	185.7	12 3/8	314.3	7 3/16	182.6	PA2339
6 7/32	158.0	6 1/8	155.6	3 3/8	85.7	PA4041	7 11/32	186.5	5	127.0	1 3/4	44.5	PA30063
6 1/4	158.8	2 5/32	54.8	1 17/32	38.9	PA4666	7 3/8	187.3	4 1/2	114.3	1 1/2	38.1	PA30036



WARNING: These products can expose you to chemicals, including Diisononyl Phthalate, Carbon black extracts, Nickel, 1,3 Butadiene, Ethylene Oxide, Epichlorohydrin, which are known to the State of California to cause cancer, and Bisphenol-A, Ethylene Glycol, Ethylene Oxide, 1,3 Butadiene, Epichlorohydrin, which are known to the State of California to cause birth defects or other reproductive harm. For more information go to www.P65Warnings.ca.gov.

ROUND AIR FILTERS BY LENGTH

LENGTH Inches	LENGTH (mm)	O.D. Inches	O.D. (mm)	I.D. Inches	I.D. (mm)	BALDWIN NUMBER	LENGTH Inches	LENGTH (mm)	O.D. Inches	O.D. (mm)	I.D. Inches	I.D. (mm)	BALDWIN NUMBER
7 3/8.....	187.3	5 1/32.....	127.8	1 13/16.....	46.0	PA4833-FN	8 1/2.....	215.9	6 7/8.....	174.6	2 25/32.....	70.6	PA4614
7 3/8.....	187.3	9 31/32.....	253.2	4 31/32.....	126.2	PA3660-FN	8 1/2.....	215.9	12 1/32.....	305.6	7 11/16.....	195.3	PA2473
7 7/16.....	188.9	3 11/32.....	84.9	1 13/16.....	46.0	PA4934	8 1/2.....	215.9	13 3/4.....	349.3	6 23/32.....	170.7	PA1892-FN
7 15/32.....	189.7	6 13/32.....	162.7	3 3/16.....	81.0	PA4071	8 9/16.....	217.5	6.....	152.4	4 5/8.....	117.5	PA653
7 15/32.....	189.7	6 13/16.....	173.0	3 3/32.....	78.6	PA4088	8 19/32.....	218.3	4 1/2.....	114.3	2 5/8.....	66.7	PA4388
7 15/32.....	189.7	6 29/32.....	175.4	3 3/32.....	78.6	PA2240	8 5/8.....	219.1	5 27/32.....	148.4	3 5/8.....	92.1	PA4173
7 1/2.....	190.5	3 1/4.....	82.6	2 1/8.....	54.0	PA3472	8 5/8.....	219.1	6.....	152.4	3 1/2.....	88.9	PA1901
7 1/2.....	190.5	4 1/4.....	108.0	2 1/8.....	54.0	PA3472-FN	8 5/8.....	219.1	6 25/32.....	172.2	2 13/16.....	71.4	PA3818-FN
7 1/2.....	190.5	8 5/32.....	207.2	4 3/16.....	106.4	RS3536	8 5/8.....	219.1	12 5/8.....	320.7	8 13/32.....	213.5	PA2552
7 1/2.....	190.5	8 27/32.....	224.6	5 15/32.....	138.9	PA2558	8 21/32.....	219.7	5 1/2.....	139.4	2 11/32.....	59.4	RS30227
7 1/2.....	190.5	10 7/32.....	259.6	7 7/8.....	200.0	PA1606	8 11/16.....	220.7	5 13/32.....	137.3	2 5/8.....	66.8	PA10113
7 1/2.....	190.5	10 27/32.....	275.4	6 1/2.....	165.1	PA2610	8 11/16.....	220.7	9 29/32.....	251.6	4 1/16.....	103.2	PA3807
7 1/2.....	190.5	13 27/32.....	351.6	11 1/8.....	282.6	PA1641	8 25/32.....	223.0	10 1/4.....	260.4	6.....	152.4	PA1817
7 1/2.....	190.5	13 7/8.....	352.4	7 7/16.....	188.9	PA2789	8 13/16.....	223.8	3 7/8.....	98.4	3 7/32.....	81.8	PA3973
7 1/2.....	190.5	16 1/8.....	409.6	7 7/16.....	188.9	PA2406	8 27/32.....	224.6	6 5/8.....	168.3	2.....	50.8	PA2824
7 17/32.....	191.3	3 11/32.....	84.9	2 27/32.....	72.2	PA3684	8 27/32.....	224.6	9 21/32.....	245.3	5 7/32.....	132.6	PA4610 KIT
7 9/16.....	192.1	8 1/8.....	206.4	4 7/32.....	107.2	PA4075	8 7/8.....	225.4	2 3/8.....	60.3	2.....	50.8	PA5437
7 19/32.....	193.0	3 15/16.....	100.1	2 1/8.....	54.1	RS30273	8 7/8.....	225.4	6 3/32.....	154.8	2 31/32.....	75.4	PA1787
7 5/8.....	193.7	8 11/16.....	204.8	5 3/4.....	146.1	PA655	8 7/8.....	225.4	13 13/16.....	350.8	9 1/2.....	241.3	PA1896
7 21/32.....	194.5	4 5/32.....	105.6	2 29/32.....	73.8	PA3911	8 15/16.....	227.0	5 3/8.....	136.5	1 31/32.....	50.0	PA3758
7 11/16.....	195.3	6 1/8.....	155.6	3 3/8.....	85.7	PA5554	8 31/32.....	227.8	4 3/8.....	111.1	1 15/16.....	49.2	PA3612
7 11/16.....	195.3	10 1/16.....	255.6	7 9/16.....	192.1	PA3755	9.....	228.6	6 5/8.....	168.3	4 1/4.....	108.0	LL1608
7 23/32.....	196.1	5 1/8.....	130.2	2 15/32.....	62.7	PA2778-FN	9.....	228.6	6 5/8.....	168.3	4 1/4.....	108.0	PA1608
7 3/4.....	196.9	6.....	152.4	4.....	101.6	PA3908	9.....	228.6	6 27/32.....	173.8	4 3/16.....	106.4	PA2932
7 3/4.....	196.9	6 3/32.....	154.8	3 15/32.....	88.1	PA4328	9.....	228.6	7 1/2.....	190.5	5 1/4.....	133.4	PA1957
7 25/32.....	197.6	4 3/32.....	104.0	2 15/32.....	62.7	PA3795	9.....	228.6	8 1/4.....	209.6	5 3/4.....	146.1	PA1613
7 13/16.....	198.4	8 9/16.....	217.5	2 1/2.....	63.5	PA2826	9.....	228.6	8 1/4.....	209.6	5 3/4.....	146.1	PA1613-S
7 27/32.....	199.2	2 1/8.....	54.0	1 5/16.....	33.3	PA4896	9.....	228.6	10 7/32.....	259.6	6 1/16.....	154.0	LL1621-2
7 27/32.....	199.2	2 17/32.....	64.3	1 1/2.....	38.1	PA4720	9.....	228.6	10 7/32.....	259.6	6 1/16.....	154.0	PA1621-2
7 27/32.....	199.2	3 5/32.....	80.2	2 13/32.....	61.1	PA3682	9.....	228.6	10 7/32.....	259.6	7 7/8.....	200.0	PA1621
7 27/32.....	199.2	10 7/32.....	259.6	6 1/16.....	154.0	PA1620-S	9.....	228.6	10 7/32.....	259.6	7 7/8.....	200.0	PA1621-S
7 7/8.....	200.0	6 3/32.....	154.8	3 15/32.....	88.1	PA2904	9.....	228.6	12 3/4.....	323.9	8 11/32.....	211.9	PA2438
7 7/8.....	200.0	6 5/8.....	168.3	4 1/4.....	108.0	PA641	9 1/32.....	229.4	2 3/4.....	69.9	2.....	50.8	PA4740
7 7/8.....	200.0	6 5/8.....	168.3	4 1/4.....	108.0	PA1602	9 1/32.....	229.4	3 5/32.....	80.2	2 5/32.....	54.8	PA4548
7 7/8.....	200.0	7 13/16.....	198.4	3 15/32.....	88.1	PA3406-FN	9 1/32.....	229.4	3 25/32.....	96.0	2 7/8.....	73.0	PA3950
8.....	203.2	2 23/32.....	69.1	1 31/32.....	50.0	PA2889	9 1/32.....	229.4	5 29/32.....	150.0	2 13/16.....	71.4	PA3753
8.....	203.2	5 1/4.....	133.4	2 5/8.....	66.7	PA1635	9 1/32.....	229.4	6 1/16.....	154.0	3 1/2.....	88.9	PA2906
8.....	203.2	5 31/32.....	151.6	3 7/32.....	81.8	RS4161	9 1/32.....	229.4	9 5/16.....	236.5	4 27/32.....	123.0	PA2585
8.....	203.2	12 1/32.....	305.6	6 23/32.....	170.7	PA2599	9 1/32.....	229.4	13 5/32.....	334.2	5 1/4.....	133.4	PA4942
8.....	203.2	12 3/32.....	307.2	8 11/16.....	220.7	PA2596	9 1/16.....	230.2	4 5/32.....	105.6	2 7/8.....	73.0	PA2622
8 1/32.....	204.0	7 7/8.....	200.0	6 1/8.....	155.6	PA1934	9 1/16.....	230.2	7 17/32.....	191.3	5 3/8.....	136.5	RS10350
8 1/32.....	204.0	8 5/16.....	211.1	6 1/32.....	153.2	PA2958	9 3/32.....	231.0	3 5/16.....	84.1	2 3/8.....	60.3	RS30078
8 1/32.....	204.0	17 5/8.....	447.7	11 1/32.....	280.2	PA2399	9 3/32.....	231.0	3 17/32.....	89.7	2 7/16.....	61.9	PA3817
8 1/16.....	204.8	5 1/16.....	128.6	1 1/4.....	31.8	CV15005	9 3/32.....	231.0	3 5/8.....	92.1	2 13/32.....	61.1	PA2717
8 1/16.....	204.8	8 3/4.....	222.3	6 1/16.....	154.0	PA3653	9 3/32.....	231.0	6 3/32.....	154.8	2 5/16.....	58.7	PA3833
8 1/16.....	204.8	9 5/8.....	244.5	5.....	127.0	PA1867	9 1/8.....	231.8	2 7/16.....	61.9	1 15/16.....	49.2	PA2861
8 1/16.....	204.8	12.....	304.8	4 15/16.....	125.4	PA2548	9 1/8.....	231.8	5 7/8.....	149.2	3 7/32.....	81.8	PA5567
8 1/8.....	206.4	2 29/32.....	73.8	2 3/8.....	60.3	PA2748	9 1/8.....	231.8	5 31/32.....	151.6	2 7/32.....	56.4	PA3651-FN
8 3/16.....	208.0	10 7/32.....	259.6	5 1/2.....	139.7	PA1620	9 3/16.....	233.4	5 3/32.....	129.4	2 3/4.....	69.9	RS5748
8 1/4.....	209.6	2 15/16.....	74.6	1 7/8.....	47.6	PA2702	9 1/4.....	235.0	4 3/32.....	104.0	3.....	76.2	PA3601
8 1/4.....	209.6	6 15/32.....	164.3	3 11/32.....	84.9	PA2422	9 1/4.....	235.0	4 15/16.....	125.4	2 3/4.....	69.9	PA4903
8 9/32.....	210.3	7 7/8.....	200.0	3 15/32.....	88.1	PA3411-FN	9 1/4.....	235.0	7.....	177.8	4 3/8.....	111.1	PA1769
8 5/16.....	211.1	6 3/16.....	157.2	2 3/4.....	69.9	RS4450	9 9/32.....	235.7	6 5/8.....	168.3	4 1/4.....	108.0	PA2592
8 5/16.....	211.1	9 7/32.....	234.2	4 27/32.....	123.0	PA1922	9 5/16.....	236.5	5 1/8.....	130.2	2 15/32.....	62.7	PA1907-FN
8 5/16.....	211.1	11 5/8.....	295.3	4 27/32.....	123.0	PA1922-FN	9 5/16.....	236.5	8 3/8.....	212.7	3 15/32.....	88.1	PA3910-FN
8 11/32.....	211.9	2 19/32.....	65.9	1 21/32.....	42.1	PA4867	9 5/16.....	236.5	9 1/16.....	230.2	4 15/16.....	125.4	PA1987
8 3/8.....	212.7	5 1/8.....	130.2	2 15/32.....	62.7	PA3557-FN	9 11/32.....	237.3	4 19/32.....	116.7	2 15/32.....	62.7	PA2890
8 3/8.....	212.7	5 1/2.....	139.7	1 3/4.....	44.5	PA2807	9 11/32.....	237.3	5 3/4.....	146.1	3 1/32.....	77.0	PA2701
8 3/8.....	212.7	5 1/2.....	139.7	1 3/4.....	44.5	PA2822	9 11/32.....	237.3	6 3/8.....	161.9	3 11/16.....	93.7	PA4693
8 3/8.....	212.7	6 7/8.....	174.6	4 3/16.....	106.4	PA2446	9 3/8.....	238.1	4 3/32.....	104.0	2 15/32.....	62.7	PA1821
8 3/8.....	212.7	10 19/32.....	269.1	6.....	152.4	PA5491	9 3/8.....	238.1	6 3/8.....	161.9	2 5/8.....	66.7	PA1752-FN
8 13/32.....	213.5	5 21/32.....	143.7	2 15/32.....	62.7	PA3811-FN	9 3/8.....	238.1	6 15/32.....	164.3	3 11/32.....	84.9	PA2772
8 15/32.....	215.1	4 1/2.....	114.3	2.....	50.8	PA2535	9 3/8.....	238.1	10 1/16.....	255.6	3 9/16.....	90.5	PA1919-FN
8 15/32.....	215.1	6 3/8.....	161.9	2 5/8.....	66.7	PA2860-FN	9 3/8.....	238.1	13 3/4.....	349.3	6 3/4.....	171.5	PA1956-FN
8 15/32.....	215.1	7 15/16.....	201.6	4 31/32.....	126.2	PA2895	9 13/32.....	238.9	2 1/4.....	57.2	1 5/8.....	41.3	RS3991



WARNING: These products can expose you to chemicals, including Diisononyl Phthalate, Carbon black extracts, Nickel, 1,3 Butadiene, Ethylene Oxide, Epichlorohydrin, which are known to the State of California to cause cancer, and Bisphenol-A, Ethylene Glycol, Ethylene Oxide, 1,3 Butadiene, Epichlorohydrin, which are known to the State of California to cause birth defects or other reproductive harm. For more information go to www.P65Warnings.ca.gov.

ROUND AIR FILTERS BY LENGTH

LENGTH Inches	LENGTH (mm)	O.D. Inches	O.D. (mm)	I.D. Inches	I.D. (mm)	BALDWIN NUMBER	LENGTH Inches	LENGTH (mm)	O.D. Inches	O.D. (mm)	I.D. Inches	I.D. (mm)	BALDWIN NUMBER
9 13/32	238.9	5	127.0	2 11/16	68.3	PA4866	10 1/4	260.4	10 1/16	255.6	3 9/16	90.5	LL1636-FN
9 7/16	239.7	12	304.8	4 15/16	125.4	PA2379	10 1/4	260.4	10 1/16	255.6	3 9/16	90.5	PA1636-FN
9 7/16	239.7	12	304.8	4 15/16	125.4	PA2379-K	10 5/16	261.9	5 1/8	130.2	2 15/32	62.7	PA2944-FN
9 1/2	241.3	4 1/2	114.3	3 9/16	90.5	RS5550	10 5/16	261.9	5 13/16	147.6	2 1/2	63.5	PA3476
9 1/2	241.3	6 1/8	155.6	3 15/32	88.1	PA5752	10 5/16	261.9	9 1/16	230.2	4 15/16	125.4	PA1986
9 1/2	241.3	6 3/8	161.9	2 27/32	72.2	PA2949-FN	10 5/16	261.9	12 19/32	319.9	5	127.0	PA30125
9 1/2	241.3	6 7/8	174.6	4 3/16	106.4	PA2740	10 5/16	261.9	15 5/8	396.9	10 9/32	261.1	PA2848
9 1/2	241.3	10 3/8	263.5	6 1/32	153.2	LL2557	10 5/16	261.9	16 13/16	427.0	10	254.0	PA3838
9 1/2	241.3	10 3/8	263.5	6 1/32	153.2	PA2557	10 11/32	262.7	5 1/8	130.2	2 15/32	62.7	LL1690-FN
9 1/2	241.3	13 7/8	352.4	7 7/16	188.9	PA2445	10 11/32	262.7	5 1/8	130.2	2 15/32	62.7	PA1690-FN
9 17/32	242.1	3 1/4	82.6	2 1/8	54.0	PA3674	10 11/32	262.7	6 5/8	168.3	2	50.8	PA2803
9 9/16	242.9	5 3/16	131.8	3 31/32	100.8	PA3783	10 11/32	262.7	8 17/32	216.7	6 1/32	153.2	PA2869
9 9/16	242.9	7 15/16	201.6	4 5/8	117.5	PA2183	10 11/32	262.7	8 25/32	223.0	7 7/16	188.9	PA30070
9 19/32	243.7	4 7/32	107.2	2 5/32	54.8	RS4803	10 11/32	262.7	19 9/32	489.7	12 7/8	327.0	PA2653
9 19/32	243.7	6 3/32	154.8	3 15/32	88.1	PA2913	10 3/8	263.5	3 3/16	81.0	2 17/32	64.3	PA3672
9 5/8	244.5	5 15/16	150.8	4 27/32	123.0	PA2586	10 3/8	263.5	5 1/16	128.6	2 15/32	62.7	PA4604-FN
9 5/8	244.5	6 3/32	154.8	4 3/32	104.0	PA3972	10 3/8	263.5	5 1/8	130.2	2 1/2	63.5	PA5410-FN
9 5/8	244.5	8 1/4	209.6	4 9/16	115.9	PA30067	10 3/8	263.5	5 5/16	134.9	3 1/16	77.8	PA3969
9 21/32	245.3	8 15/32	215.1	6 3/16	157.2	PA30026	10 3/8	263.5	5 11/16	144.5	2 1/2	63.5	PA5436
9 11/16	246.1	8 11/32	211.9	3 7/8	98.4	PA1700	10 3/8	263.5	5 3/4	146.1	2 1/2	63.5	PA4651
9 23/32	246.9	5 1/32	127.8	3 5/32	80.2	RS30077	10 3/8	263.5	5 7/8	149.2	2 15/32	62.7	PA7495
9 13/16	249.2	6 5/8	168.3	4 1/4	108.0	PA1664	10 3/8	263.5	5 31/32	151.6	4 27/32	123.0	PA2372
9 13/16	249.2	14 17/32	369.1	8 11/32	211.9	PA1816	10 3/8	263.5	6 3/32	154.8	3 15/32	88.1	PA2716
9 7/8	250.8	2 11/32	59.5	1 7/8	47.6	PA1809	10 3/8	263.5	6 3/32	154.8	4	101.6	RS10349
9 7/8	250.8	4 9/16	115.9	2 5/8	66.7	RS3990	10 3/8	263.5	6 1/2	165.1	2 1/4	57.2	PA4918
9 7/8	250.8	5 1/4	133.4	2 25/32	70.6	RS10347	10 3/8	263.5	7 5/16	185.7	3 1/2	88.9	PA1851
9 29/32	251.6	5	127.0	2	50.8	RS5387 KIT	10 3/8	263.5	9 13/16	249.2	3 9/16	90.5	PA2954-FN
9 15/16	252.4	2 15/16	74.6	2 13/32	61.1	PA2514	10 3/8	263.5	10 3/8	263.5	5 1/2	139.7	PA1789
9 15/16	252.4	4 3/32	104.0	2 1/2	63.5	PA3792	10 3/8	263.5	11 5/8	295.3	4 27/32	123.0	PA1750-FN
9 31/32	253.2	2 15/16	74.6	1 7/8	47.6	PA2678	10 3/8	263.5	12 1/32	305.6	7 11/16	195.3	PA1705-2
9 31/32	253.2	4 9/16	116.1	23/32	18.3	CV15007	10 3/8	263.5	12 3/8	314.3	4 15/16	125.4	PA1986-K
10	254.0	3 11/16	93.7	2 9/16	65.1	PA2711	10 3/8	263.5	13 3/4	349.3	6 3/4	171.5	PA1977-FN
10	254.0	5 3/4	146.1	4 7/8	123.8	RS30120	10 3/8	263.5	15 3/4	400.1	7 11/16	195.3	PA1980-FN
10	254.0	5 13/16	147.6	3 7/16	87.3	PA3416	10 3/8	263.5	15 25/32	400.8	7 7/16	188.9	PA2349-FN
10	254.0	7 3/8	187.3	3 1/2	88.9	PA30023	10 13/32	264.3	2 13/32	61.1	1 3/4	44.5	RS3705
10	254.0	8 5/32	207.2	4 3/16	106.4	RS3550	10 13/32	264.3	7 13/16	198.4	3 15/32	88.1	PA1753-FN
10	254.0	8 7/8	225.4	4 11/32	110.3	PA656	10 7/16	265.1	9 5/16	236.5	4 27/32	123.0	PA2412
10	254.0	9	228.6	6 5/8	168.3	PA617	10 7/16	265.1	12 1/16	306.4	7 13/16	198.4	PA1663
10	254.0	12 1/8	308.0	7 11/16	195.3	LL1626-2	10 15/32	265.9	3 5/32	80.2	2 7/16	61.9	RS4962
10	254.0	12 1/32	305.6	9 1/4	235.0	PA1626	10 1/2	266.7	5 29/32	150.0	2 1/2	63.5	PA3785-FN
10	254.0	12 1/8	308.0	7 11/16	195.3	PA1626-2	10 1/2	266.7	6 7/16	163.5	4 1/16	103.2	PA1868
10	254.0	13 5/16	338.1	5 1/4	133.4	PA2812	10 1/2	266.7	7 15/16	201.6	3 9/16	90.5	PA3627
10 1/32	254.8	7 13/16	198.4	4 1/16	103.2	PA3681	10 1/2	266.7	7 15/16	201.6	5 3/8	136.5	PA2712
10 1/16	255.6	6 1/4	158.8	3 9/16	90.5	RS5747	10 1/2	266.7	8 1/4	209.6	5 3/4	146.1	PA2909
10 1/16	255.6	6 11/16	169.9	2 5/8	66.7	PA3471	10 1/2	266.7	8 3/8	212.7	4	101.6	PA1673
10 1/16	255.6	12 3/4	323.9	6 5/16	160.3	PA2942	10 1/2	266.7	8 13/16	223.8	4 5/32	105.6	PA1794-FN
10 1/16	255.6	15 1/4	387.4	6 9/16	166.7	PA2838	10 1/2	266.7	9 7/32	234.2	4 27/32	123.0	PA1646
10 3/32	256.4	3 21/32	92.9	2 3/8	60.3	PA2700	10 1/2	266.7	10 3/8	263.5	6 1/32	153.2	PA2465
10 3/32	256.4	4 5/32	105.6	2 29/32	73.8	PA2689	10 1/2	266.7	10 3/8	263.5	6 1/32	153.2	PA2656
10 3/32	256.4	6 11/16	169.9	2 5/8	66.7	PA1674	10 1/2	266.7	10 3/8	263.5	6 1/32	153.2	PA2843
10 3/32	256.4	6 25/32	172.2	2 27/32	72.2	PA3816	10 1/2	266.7	10 1/2	266.7	7 3/4	196.9	PA639
10 3/32	256.4	9 7/32	234.2	4 27/32	123.0	PA1840	10 1/2	266.7	11 5/8	295.3	4 27/32	123.0	LL1646-FN
10 1/8	257.2	3 3/32	78.6	2 5/32	54.8	PA2489	10 1/2	266.7	11 5/8	295.3	4 27/32	123.0	PA1646-FN
10 1/8	257.2	4 3/16	106.4	2	50.8	RS30209	10 1/2	266.7	11 21/32	296.1	8 31/32	227.8	PA1625
10 1/8	257.2	5 31/32	151.6	3 1/32	77.0	RS4445	10 1/2	266.7	13 7/8	352.4	7 7/16	188.9	LL2642
10 1/8	257.2	8 7/8	225.4	5	127.0	PA1788	10 1/2	266.7	13 7/8	352.4	7 7/16	188.9	PA2642
10 1/8	257.2	9 11/32	237.3	6 1/4	158.8	PA2598	10 17/32	267.5	4 3/4	120.7	2 1/4	57.2	PA5584
10 5/32	258.0	4 15/32	113.5	2 21/32	67.5	PA4802	10 9/16	268.3	5 29/32	150.0	2 17/32	64.3	PA3820-FN
10 5/32	258.0	9 5/8	244.5	5	127.0	PA2566	10 9/16	268.3	8	203.2	4	101.6	PA30042
10 1/4	260.4	2 5/8	66.7	1 3/4	44.5	PA30163	10 9/16	268.3	8 1/8	206.4	6 1/8	155.6	RS4577
10 1/4	260.4	2 29/32	73.8	2 7/32	56.4	PA4881	10 11/16	271.5	5 11/32	135.7	2 7/32	56.4	PA2496
10 1/4	260.4	3 3/8	85.7	2 1/4	57.2	PA2413	10 23/32	272.3	4 5/32	105.6	3	76.2	RS5325
10 1/4	260.4	4 3/32	104.0	2 15/32	62.7	PA4766	10 3/4	273.1	4 1/8	104.8	2 7/16	61.9	RS5449
10 1/4	260.4	6 5/16	160.3	3 7/32	81.8	PA3650	10 3/4	273.1	4 1/2	114.3	2 1/4	57.2	PA1683
10 1/4	260.4	6 3/8	161.9	2 5/8	66.7	PA1830-FN	10 3/4	273.1	4 19/32	116.7	3 11/32	84.9	PA2896
							10 3/4	273.1	4 7/8	123.8	2 1/4	57.2	PA2331



WARNING: These products can expose you to chemicals, including Diisononyl Phthalate, Carbon black extracts, Nickel, 1,3 Butadiene, Ethylene Oxide, Epichlorohydrin, which are known to the State of California to cause cancer, and Bisphenol-A, Ethylene Glycol, Ethylene Oxide, 1,3 Butadiene, Epichlorohydrin, which are known to the State of California to cause birth defects or other reproductive harm. For more information go to www.P65Warnings.ca.gov.

ROUND AIR FILTERS BY LENGTH

LENGTH Inches	LENGTH (mm)	O.D. Inches	O.D. (mm)	I.D. Inches	I.D. (mm)	BALDWIN NUMBER	LENGTH Inches	LENGTH (mm)	O.D. Inches	O.D. (mm)	I.D. Inches	I.D. (mm)	BALDWIN NUMBER
10 3/4	273.1	5 1/8	130.2	2 1/2	63.5	PA4645-FN	11 15/32	291.3	10 7/32	259.6	7 7/8	200.0	PA1607
10 3/4	273.1	6 3/32	154.8	3 25/32	96.0	PA2710	11 1/2	292.1	4 3/4	120.7	3 5/8	92.1	PA2736
10 25/32	273.8	4 1/4	108.0	2 3/4	69.9	RS3883	11 1/2	292.1	5 5/32	131.0	4 1/32	102.4	PA2646
10 25/32	273.8	5 9/16	141.3	4 7/32	107.2	PA2665	11 1/2	292.1	5 3/16	131.8	3 7/32	81.8	PA2662
10 13/16	274.6	4 1/8	104.8	2 5/16	58.7	RS3704	11 1/2	292.1	5 3/4	146.1	3 1/16	77.8	PA2513
10 13/16	274.6	4 1/8	104.8	2 5/16	58.7	RS3716	11 1/2	292.1	6 11/32	161.1	3 5/16	84.1	PA3801-FN
10 13/16	274.6	5 1/4	133.4	2 1/4	57.2	PA1945	11 1/2	292.1	6 3/8	161.9	2 5/8	66.7	LL1667-FN
10 13/16	274.6	8 9/16	217.5	2 1/2	63.5	PA2829	11 1/2	292.1	6 3/8	161.9	2 5/8	66.7	PA1667-FN
10 13/16	274.6	8 9/16	217.5	2 31/32	75.4	PA2805	11 1/2	292.1	6 3/8	161.9	2 5/8	66.7	PA3791-FN
10 7/8	276.2	6 3/8	161.9	2 27/32	72.2	PA2383	11 1/2	292.1	7	177.8	2 27/32	72.2	PA3979
10 7/8	276.2	6 7/8	174.6	5 5/16	134.9	RS4623	11 1/2	292.1	7 1/8	181.0	2 5/8	66.7	PA3875-FN
10 29/32	277.0	4 3/32	104.0	3 17/32	89.7	PA5468	11 1/2	292.1	7 13/16	198.4	3 15/32	88.1	PA2684-FN
10 29/32	277.0	6 1/4	158.8	2 3/4	69.9	RS5285	11 1/2	292.1	7 13/16	198.4	3 15/32	88.1	PA3466-FN
10 15/16	277.8	5 3/32	129.4	2 11/16	68.3	RS5742	11 1/2	292.1	7 29/32	200.8	4 3/32	104.0	PA3894
10 15/16	277.8	8 1/32	204.0	5 5/16	134.9	PA3956	11 1/2	292.1	8 9/32	210.3	4 7/16	112.7	PA1848
10 15/16	277.8	9 15/16	252.4	5 1/4	133.4	PA3479	11 1/2	292.1	8 3/8	212.7	3 15/32	88.1	PA2968-FN
11	279.4	3 9/16	90.5	2 1/32	51.6	PA1644	11 1/2	292.1	8 3/8	212.7	3 15/32	88.1	PA3924-FN
11	279.4	4 3/16	106.4	2 19/32	65.9	PA3985	11 1/2	292.1	8 5/8	219.1	7 1/16	179.4	PA2735
11	279.4	4 17/32	115.1	2 1/4	57.2	PA2636	11 1/2	292.1	9 7/32	234.2	4 27/32	123.0	PA1932
11	279.4	8 1/4	209.6	5 3/4	146.1	LL1614	11 1/2	292.1	9 7/32	234.2	4 27/32	123.0	PA3645
11	279.4	8 1/4	209.6	5 3/4	146.1	PA1614	11 23/32	292.7	6 13/16	173.0	2 27/32	72.2	PA5338-FN
11 1/32	280.2	5 3/16	131.8	2 17/32	64.3	PA4608	11 17/32	292.9	5	127.0	2 9/16	65.1	PA2792
11 1/32	280.2	5 13/32	137.3	3 3/16	81.0	RS3940	11 17/32	292.9	6 7/32	158.0	2 17/32	64.3	PA2905
11 1/32	280.2	6 1/2	165.1	3 9/16	90.5	RS3707	11 17/32	292.9	7 13/16	198.4	3 5/16	84.1	PA4674-FN
11 1/32	280.2	7 9/32	184.9	3 9/16	90.5	RS3735	11 17/32	292.9	12 13/16	325.4	8 11/32	211.9	PA645
11 1/32	280.2	8 5/16	211.1	3 7/16	87.3	PA5406-FN	11 9/16	293.7	2 15/16	74.6	1 7/8	47.6	PA2728
11 1/32	280.2	8 13/32	213.5	3 7/16	87.3	PA3790	11 9/16	293.7	4 1/8	104.8	3	76.2	PA2652
11 1/16	281.0	3 25/32	96.0	2 7/8	73.0	PA2321	11 9/16	293.7	6 7/16	163.5	3 5/8	92.1	PA5423-FN
11 1/16	281.0	4 1/8	104.8	2 29/32	73.8	PA4919	11 9/16	293.7	8 3/8	212.7	3 7/16	87.3	PA2970
11 1/16	281.0	5 5/32	131.0	2 29/32	73.8	PA4919	11 9/16	293.7	13 7/16	341.3	7 29/32	200.8	RS4576
11 1/16	281.0	6 3/8	161.9	3 15/16	100.0	PA30244	11 19/32	294.5	3 7/8	98.4	3 3/16	81.0	PA4603
11 1/16	281.0	8 5/16	211.1	2 5/8	66.7	PA3435-FN	11 19/32	294.5	6 1/2	165.1	3 9/16	90.5	RS4597
11 3/32	281.8	4 5/32	105.6	3 7/16	87.3	PA3853-FN	11 19/32	294.5	9 9/16	242.9	5 1/8	130.2	PA1701
11 3/32	281.8	7 11/32	186.5	2 29/32	73.8	PA2570	11 19/32	294.5	9 9/16	242.9	5 1/8	130.2	PA1701 ELE
11 3/32	281.8	3 21/32	92.9	3 19/32	91.3	RS3706	11 19/32	294.5	9 9/16	242.9	5 1/8	130.2	PA2627
11 3/16	282.6	2 3/4	69.9	2 7/16	61.9	PA2381	11 5/8	295.3	8 5/32	207.2	4 3/16	106.4	RS3882XP
11 7/32	285.0	4 3/16	106.4	2 1/16	52.4	PA3687	11 5/8	295.3	8 5/32	207.2	4 1/4	108.0	RS3882
11 7/32	285.0	9 1/8	231.8	2 15/16	74.6	PA4827	11 5/8	295.3	8 15/16	227.0	4 19/32	116.7	PA2891
11 1/4	285.8	2 15/16	74.6	4 23/32	119.9	RS4806	11 21/32	296.1	4 1/8	104.8	2 5/16	58.7	RS30147
11 1/4	285.8	4 9/16	115.9	2 15/32	62.7	PA30033	11 21/32	296.1	6 15/32	164.3	3 5/8	92.1	RS5761
11 1/4	285.8	4 3/4	120.7	3 7/16	87.3	PA1967	11 11/16	296.9	10 5/32	258.0	4 3/32	104.0	PA2865
11 1/4	285.8	5 1/4	133.4	2 1/8	54.0	PA3821	11 11/16	296.9	12 31/32	329.4	6 13/16	173.0	RS4622
11 1/4	285.8	6 3/32	154.8	4 1/8	104.8	PA1982	11 23/32	297.7	7 5/32	181.8	5 27/32	148.4	RS5355
11 1/4	285.8	6 3/32	154.8	3 15/32	88.1	PA1710	11 23/32	297.7	9 9/16	242.9	5 3/16	131.8	PA3597
11 1/4	285.8	6 3/8	161.9	2 5/8	66.7	PA2488-FN	11 3/4	298.5	6 3/8	161.9	3 23/32	94.5	RS30106
11 9/32	286.6	6 11/32	161.1	3 5/16	84.1	PA3671-FN	11 3/4	298.5	8 5/16	211.1	6 1/32	153.2	RS3513
11 9/32	286.6	6 3/8	161.9	2 5/8	66.7	PA3761-FN	11 25/32	299.2	4 23/32	119.9	3 3/16	81.0	RS3503
11 9/32	286.6	6 3/8	161.9	2 3/4	69.9	PA2657-FN	11 25/32	299.2	5 1/4	133.4	4 1/8	104.8	PA3417
11 5/16	287.3	5 1/4	133.4	4 1/8	104.8	PA2794	11 13/16	300.0	10 9/16	268.3	4 1/4	108.0	PA2806
11 5/16	287.3	6 3/8	161.9	2 5/8	66.7	PA3667-FN	11 27/32	300.8	4 1/8	104.8	2 5/16	58.7	RS3954
11 5/16	287.3	9 9/32	235.7	4 11/16	119.1	PA3415	11 27/32	300.8	6 1/2	165.1	3 9/16	90.5	RS5305
11 11/32	288.0	3 3/4	95.2	8 1/2	53.6	RS30221	11 27/32	300.8	7 1/16	179.4	2 27/32	72.2	PA3879-FN
11 11/32	288.1	6 5/8	168.3	1 13/32	35.7	PA2804	11 7/8	301.6	3 3/4	95.3	3 3/4	95.3	PA5572
11 11/32	288.1	6 11/16	169.9	3 3/4	95.3	PA2754	11 7/8	301.6	5 1/4	133.4	3 1/4	82.6	PA30032
11 11/32	288.1	9 5/8	244.5	4 7/8	123.8	RS5424	11 7/8	301.6	6 3/8	161.9	2 27/32	72.2	PA2391
11 3/8	288.9	5 15/16	150.8	4 27/32	123.0	PA2687	11 7/8	301.6	9	228.6	4 7/8	123.8	RS5536
11 3/8	288.9	6 3/8	161.9	3 1/4	82.6	PA2846-FN	11 7/8	301.6	9 31/32	253.2	3 13/16	96.8	PA2961-FN
11 3/8	288.9	6 3/8	161.9	3 5/16	84.1	PA4583-FN	11 7/8	301.6	10 1/2	266.7	4	101.6	PA2820
11 3/8	288.9	9 1/32	229.4	4 5/8	117.5	RS4807	11 15/16	303.2	6 5/8	168.3	3 13/16	96.8	PA4472
11 3/8	288.9	9 9/32	235.7	5 5/32	131.0	RS5434	11 15/16	303.2	9 7/32	234.2	5 5/16	134.9	PA3874
11 3/8	288.9	11 1/2	292.1	4 13/16	122.2	RS5458	11 31/32	304.0	3 5/16	84.1	2 15/32	62.7	RS3703
11 13/32	289.7	7 1/2	190.5	4 1/8	104.8	PA2948	11 31/32	304.0	5 1/4	133.4	4 1/8	104.8	PA30211
11 7/16	290.5	2 13/32	61.1	1 3/4	44.5	RS3547	12	304.8	4 5/32	105.6	2 5/16	58.7	PA4692
11 7/16	290.5	3 13/16	96.8	2 3/8	60.3	PA4594	12	304.8	5 23/32	145.3	3 7/16	87.3	PA3657
11 7/16	290.5	7 27/32	199.2	2 5/8	66.7	PA3608-FN	12	304.8	5 29/32	150.0	2 25/32	70.6	PA2888
11 15/32	291.3	4 7/16	112.7	3	76.2	PA3492							



WARNING: These products can expose you to chemicals, including Diisononyl Phthalate, Carbon black extracts, Nickel, 1,3 Butadiene, Ethylene Oxide, Epichlorohydrin, which are known to the State of California to cause cancer, and Bisphenol-A, Ethylene Glycol, Ethylene Oxide, 1,3 Butadiene, Epichlorohydrin, which are known to the State of California to cause birth defects or other reproductive harm. For more information go to www.P65Warnings.ca.gov.

ROUND AIR FILTERS BY LENGTH

LENGTH Inches	LENGTH (mm)	O.D. Inches	O.D. (mm)	I.D. Inches	I.D. (mm)	BALDWIN NUMBER	LENGTH Inches	LENGTH (mm)	O.D. Inches	O.D. (mm)	I.D. Inches	I.D. (mm)	BALDWIN NUMBER
12	304.8	6 25/32	172.2	2 3/4	69.9	PA2976-FN	12 3/8	314.3	8 13/32	213.5	5 25/32	146.8	PA2897
12	304.8	7 1/8	181.0	2 27/32	72.2	PA3447	12 3/8	314.3	8 1/2	215.9	3	76.2	PA2815
12	304.8	7 5/16	185.7	3 5/8	92.1	PA1647	12 3/8	314.3	8 1/2	215.9	4	101.6	PA2818
12	304.8	8 1/32	204.0	6 1/16	154.0	PA2938	12 3/8	314.3	8 1/2	215.9	4	101.6	PA3867
12	304.8	8 3/4	222.3	7 1/2	190.5	PA30076	12 3/8	314.3	8 17/32	216.7	3	76.2	PA3868
12	304.8	8 29/32	226.2	4 21/32	118.3	RS5438	12 3/8	314.3	9 7/32	234.2	4 27/32	123.0	PA3474
12	304.8	9 1/8	231.8	6 7/8	174.6	PA1795	12 3/8	314.3	10	254.0	4 27/32	123.0	PA3902
12	304.8	9 15/16	252.4	5 1/2	139.7	PA1703	12 3/8	314.3	10 3/8	263.5	6 1/32	153.2	PA2520
12	304.8	10 7/32	259.6	5 1/2	139.7	PA618	12 13/32	315.1	6 7/8	174.6	3 1/2	88.9	PA2666
12	304.8	10 7/32	259.6	6 1/16	154.0	PA618-S	12 13/32	315.1	6 7/8	174.6	3 1/2	88.9	PA4644
12	304.8	10 7/32	259.6	7 7/8	200.0	PA616	12 7/16	315.9	5 1/32	127.8	3 5/32	80.2	RS4595
12	304.8	10 3/8	263.5	7 13/16	198.4	PA1913	12 7/16	315.9	13 3/4	349.3	5 11/16	144.5	PA2417-FN
12	304.8	10 13/32	264.3	6 15/16	176.2	PA32555	12 15/32	316.7	6 3/32	154.8	3 15/32	88.1	PA1882
12	304.8	11 3/8	288.9	6 31/32	177.0	PA2647	12 15/32	316.7	6 3/8	161.9	3 1/4	82.6	PA2380-FN
12	304.8	12 3/32	307.2	7 11/16	195.3	PA3598	12 1/2	317.5	5 5/32	131.3	3 19/32	90.0	RS30220
12 1/32	305.6	3 5/16	84.1	2 15/32	62.7	RS3747	12 1/2	317.5	5 1/4	133.4	3 1/4	82.6	PA3778
12 1/32	305.6	3 21/32	92.9	2 3/8	60.3	PA2791	12 1/2	317.5	5 9/16	141.3	4 1/2	114.3	PA2607
12 1/32	305.6	5 1/4	133.4	3 23/32	94.5	RS3501	12 1/2	317.5	5 15/16	150.8	4 27/32	123.0	PA1906
12 1/32	305.6	7 5/16	185.7	3 5/8	92.1	PA2719	12 1/2	317.5	7 5/8	193.7	6 1/16	154.0	PA2738
12 1/16	306.4	2 3/4	69.9	2 11/16	68.3	RS3943	12 1/2	317.5	7 13/16	198.4	3 7/8	98.4	PA3607-FN
12 1/16	306.4	3 25/32	96.0	2 7/8	73.0	PA2670	12 1/2	317.5	8 21/32	219.9	3 15/32	88.1	PA4640-FN
12 1/16	306.4	3 7/8	98.4	2 1/2	63.5	PA2512	12 1/2	317.5	9 5/32	232.6	4 5/8	117.5	RS3502
12 1/16	306.4	6 1/8	155.6	3 9/16	90.5	RS5741	12 1/2	317.5	9 7/32	234.2	4 27/32	123.0	PA2421
12 1/16	306.4	7 27/32	199.2	3 15/32	88.1	PA3848-FN	12 1/2	317.5	9 1/4	235.0	4 27/32	123.0	LL1615
12 3/32	307.2	3 21/32	92.9	2 7/8	73.0	RS4995	12 1/2	317.5	9 1/4	235.0	4 27/32	123.0	PA1615
12 3/32	307.2	5 3/4	146.1	4 7/32	107.2	PA2260	12 1/2	317.5	9 1/4	235.0	4 27/32	123.0	PA1615XP
12 3/32	307.2	6 27/32	173.8	2 13/16	71.4	PA4870-FN	12 1/2	317.5	9 29/32	251.6	5 3/8	136.5	PA2304-FN
12 3/32	307.2	7 25/32	197.6	4 11/32	110.3	PA5467	12 1/2	317.5	10 3/8	263.5	6 1/32	153.2	PA2371
12 3/32	307.2	11 7/8	301.6	7 1/4	184.2	PA2549	12 1/2	317.5	12 1/32	305.6	7 11/16	195.3	PA1877
12 1/8	308.0	7 13/16	198.4	3 15/32	88.1	PA3989-FN	12 1/2	317.5	13 3/4	349.3	6 23/32	170.7	LL1637-FN
12 1/8	308.0	13 13/16	350.8	9 1/2	241.3	PA1629-S	12 1/2	317.5	13 3/4	349.3	6 23/32	170.7	PA1637-FN
12 5/32	308.8	8	203.2	6 1/8	155.6	PA3966	12 1/2	317.5	15 3/4	400.1	7 7/16	188.9	PA2389-FN
12 3/16	309.6	9 5/8	244.5	5 3/8	136.5	PA1810	12 17/32	318.3	4 31/32	126.2	2 31/32	75.4	RS3942
12 7/32	310.4	3 5/16	84.1	2 15/32	62.7	RS5544	12 17/32	318.3	6 1/2	165.1	3 9/16	90.5	RS3746
12 7/32	310.4	11 7/32	285.0	4 21/32	118.2	PA3918	12 17/32	318.3	6 1/2	165.1	3 9/16	90.5	RS4994
12 1/4	311.2	4 1/8	104.8	3 1/16	77.8	PA1899	12 17/32	318.3	16 17/32	419.9	10	254.0	PA3844
12 1/4	311.2	4 9/16	115.9	3 17/32	89.7	PA3851	12 9/16	319.1	3 5/16	84.1	2 15/32	62.7	RS3543
12 1/4	311.2	5 1/8	130.2	3 9/16	90.5	PA4890	12 9/16	319.1	3 15/32	88.1	2 1/2	63.5	RS30242
12 1/4	311.2	5 1/4	133.4	4 1/8	104.8	PA2402	12 9/16	319.1	5 7/8	149.2	2 31/32	75.4	PA2727
12 1/4	311.2	5 29/32	150.0	3 31/32	100.8	PA3903	12 19/32	319.9	5 13/32	137.3	3 3/16	81.0	RS5543
12 1/4	311.2	7 15/16	201.6	3 17/32	89.7	PA5281	12 5/8	320.7	4 1/2	114.3	2 1/4	57.2	PA1684
12 1/4	311.2	9 9/32	235.7	3 19/32	91.3	PA3796	12 5/8	320.7	5 23/32	145.3	3	76.2	RS4680
12 1/4	311.2	10 1/16	255.6	3 9/16	90.5	PA1749-FN	12 5/8	320.7	5 7/8	149.2	4 1/8	104.8	RS3505
12 1/4	311.2	10 7/8	276.2	5 3/4	146.1	RS30121	12 5/8	320.7	7	177.8	4 13/32	111.9	PA1849
12 5/16	312.7	3 5/16	84.1	2 27/32	72.2	PA3685	12 5/8	320.7	7 25/32	197.6	6 15/16	176.2	PA2773
12 5/16	312.7	4 5/8	117.5	3 1/16	77.8	RS10351	12 5/8	320.7	7 13/16	198.4	6 17/32	165.9	PA2775
12 5/16	312.7	5 1/32	127.8	3 5/32	80.2	RS3549	12 5/8	320.7	8 3/8	212.7	4	101.6	PA2553
12 5/16	312.7	5 1/32	127.8	3 5/32	80.2	RS3988	12 5/8	320.7	9 1/8	231.8	5 1/4	133.4	PA2645
12 5/16	312.7	11 1/16	281.0	7 11/32	186.5	RS5693	12 21/32	321.5	13 13/16	350.8	9 1/2	241.3	PA4605
12 5/16	312.7	12 9/16	319.1	5	127.0	PA2831	12 21/32	321.8	6 7/8	174.6	3 31/32	100.8	RS30212
12 3/8	314.3	5 5/32	131.1	3 9/32	83.3	PA4101	12 11/16	322.3	12 3/32	307.2	7 13/16	198.4	RS5354
12 3/8	314.3	5 11/16	144.5	4 19/32	116.7	PA2545	12 11/16	322.3	15 7/8	403.2	8 23/32	221.5	RS30065
12 3/8	314.3	6 3/32	154.8	4 3/32	104.0	PA3636	12 23/32	323.1	5 1/4	133.4	3 23/32	94.5	RS3737
12 3/8	314.3	6 1/4	158.8	4 5/8	117.5	PA2737	12 3/4	323.9	7 3/16	182.6	5 27/32	148.4	RS30226
12 3/8	314.3	6 3/8	161.9	5 9/32	134.1	PA3915	12 3/4	323.9	8 1/2	215.9	5 3/8	136.5	PA2793
12 3/8	314.3	6 17/32	165.9	4 1/2	114.3	RS10021	12 3/4	323.9	9 9/32	235.7	5 5/32	131.0	RS2863
12 3/8	314.3	6 27/32	173.8	3 15/32	88.1	PA3698	12 3/4	323.9	9 9/32	235.7	5 5/32	131.0	RS2863XP
12 3/8	314.3	6 7/8	174.6	3 1/2	88.9	PA1926	12 3/4	324.1	9 9/32	235.7	5 5/32	131.0	RS30222XP
12 3/8	314.3	6 7/8	174.6	4 3/16	106.4	PA2498	12 25/32	324.6	3 7/8	98.4	2 3/8	60.3	PA30208
12 3/8	314.3	7 1/16	179.4	3 15/16	100.0	PA4593	12 25/32	324.6	3 7/8	98.4	3 5/8	92.1	PA5635
12 3/8	314.3	7 5/8	193.7	3 15/32	88.1	PA3670	12 25/32	324.6	4 23/32	119.9	3 1/4	82.6	RS5443
12 3/8	314.3	7 5/8	193.7	6 1/16	154.0	PA2415	12 13/16	325.4	3 17/32	89.7	2 3/4	69.9	PA3683
12 3/8	314.3	7 13/16	198.4	3 15/32	88.1	LL1681-FN	12 27/32	326.2	3 5/32	80.2	21/32	16.7	PA3686
12 3/8	314.3	7 13/16	198.4	3 15/32	88.1	PA1681-FN	12 7/8	327.0	5 9/16	141.3	2 13/16	71.4	PA5583
12 3/8	314.3	7 13/16	198.4	3 15/32	88.1	PA2877-FN	12 7/8	327.0	6 7/8	174.6	4 1/4	108.0	PA1900
12 3/8	314.3	7 31/32	202.4	5 3/8	136.5	PA2351	12 7/8	327.0	7 7/8	200.0	4 3/32	104.0	PA4602



WARNING: These products can expose you to chemicals, including Diisononyl Phthalate, Carbon black extracts, Nickel, 1,3 Butadiene, Ethylene Oxide, Epichlorohydrin, which are known to the State of California to cause cancer, and Bisphenol-A, Ethylene Glycol, Ethylene Oxide, 1,3 Butadiene, Epichlorohydrin, which are known to the State of California to cause birth defects or other reproductive harm. For more information go to www.P65Warnings.ca.gov.

ROUND AIR FILTERS BY LENGTH

LENGTH Inches	LENGTH (mm)	O.D. Inches	O.D. (mm)	I.D. Inches	I.D. (mm)	BALDWIN NUMBER	LENGTH Inches	LENGTH (mm)	O.D. Inches	O.D. (mm)	I.D. Inches	I.D. (mm)	BALDWIN NUMBER
12 7/8.....	327.0	8 1/2.....	215.9	5 3/8.....	136.5	PA2880	13 13/32.....	340.5	8 21/32.....	219.9	3 27/32.....	97.6	PA4683
12 29/32.....	327.8	5 9/16.....	141.3	4 7/16.....	112.7	PA4625	13 7/16.....	341.3	3 5/8.....	92.1	2 27/32.....	72.2	PA2837
12 15/16.....	328.6	4 3/32.....	104.0	3 1/8.....	79.4	PA2342	13 7/16.....	341.3	4 3/32.....	104.0	2 15/32.....	62.7	PA2303
12 15/16.....	328.6	7 3/4.....	196.9	4.....	101.6	PA3483	13 7/16.....	341.3	6 1/2.....	165.1	3 9/16.....	90.5	RS4678
12 15/16.....	328.6	8 1/4.....	209.6	4 3/16.....	106.4	PA2651	13 7/16.....	341.3	6 7/8.....	174.6	3 1/2.....	88.9	PA2527
12 31/32.....	329.4	5 13/32.....	137.3	3 3/16.....	81.0	RS3542	13 7/16.....	341.3	9 5/32.....	232.6	4 5/8.....	117.5	RS5442
12 31/32.....	329.4	5 13/32.....	137.3	3 3/16.....	81.0	RS4578	13 7/16.....	341.3	10 1/32.....	254.8	5 5/16.....	134.9	PA2859-FN
12 31/32.....	329.4	8 1/8.....	206.4	6.....	152.4	RS5456	13 15/32.....	342.1	9 7/32.....	234.2	4 27/32.....	123.0	PA2950
							13 15/32.....	342.1	10 1/4.....	260.4	6.....	152.4	PA1819
13.....	330.2	4 1/2.....	114.3	3 3/32.....	78.6	PA5786	13 1/2.....	342.9	3 21/32.....	92.9	2 7/8.....	73.0	RS3545
13.....	330.2	5 3/4.....	146.1	3 7/16.....	87.3	PA1911	13 1/2.....	342.9	5 15/16.....	150.8	4 27/32.....	123.0	PA3774
13.....	330.2	5 15/16.....	150.8	3 1/4.....	82.6	PA5634	13 1/2.....	342.9	7 3/32.....	180.2	3 7/8.....	98.4	PA5519
13.....	330.2	7 1/2.....	190.5	5 1/4.....	133.4	PA2871	13 1/2.....	342.9	7 13/16.....	198.4	3 15/32.....	88.1	PA2320-FN
13.....	330.2	12 1/32.....	305.6	7 11/16.....	195.3	LL1642-2	13 1/2.....	342.9	7 13/16.....	198.4	3 15/32.....	88.1	PA2669-FN
13.....	330.2	12 1/32.....	305.6	7 11/16.....	195.3	PA1642-2	13 1/2.....	342.9	8 3/8.....	212.7	3 15/32.....	88.1	PA5388
13 1/16.....	331.8	3 25/32.....	96.0	2 7/8.....	73.0	PA2644	13 1/2.....	342.9	8 27/32.....	224.6	5 13/16.....	147.6	PA2504
13 1/16.....	331.8	9 21/32.....	245.3	5 7/16.....	138.1	RS4968	13 1/2.....	342.9	9 1/8.....	231.8	5 13/16.....	147.6	LL2779
13 1/16.....	331.8	9 3/4.....	247.7	5 5/8.....	142.9	PA2664	13 1/2.....	342.9	9 1/8.....	231.8	5 13/16.....	147.6	PA2779
13 1/16.....	331.8	11 27/32.....	300.8	6 9/16.....	166.7	RS5483	13 1/2.....	342.9	9 7/32.....	234.2	4 27/32.....	123.0	LL1884
13 3/32.....	332.6	4 27/32.....	123.0	3 5/8.....	92.1	PA2634	13 1/2.....	342.9	9 7/32.....	234.2	4 27/32.....	123.0	PA1884
13 3/32.....	332.6	5 3/32.....	129.4	2 7/8.....	73.0	RS5746	13 1/2.....	342.9	9 7/32.....	234.2	4 27/32.....	123.0	PA1884XP
13 3/32.....	332.6	6 15/32.....	164.3	3 11/32.....	84.9	PA2423	13 1/2.....	342.9	9 9/32.....	235.7	4 11/16.....	119.1	PA3448
13 3/32.....	332.6	9 1/16.....	230.2	4 5/8.....	117.5	PA1675	13 1/2.....	342.9	9 9/32.....	235.7	5 5/32.....	131.0	RS3736
13 3/32.....	332.6	9 1/16.....	230.2	4 5/8.....	117.5	PA2310	13 1/2.....	342.9	10 1/4.....	260.4	6.....	152.4	PA2359
13 1/8.....	333.4	3 21/32.....	92.9	2 7/8.....	73.0	RS4679	13 1/2.....	342.9	10 3/8.....	263.5	5 11/32.....	135.7	PA2761
13 1/8.....	333.5	4 11/32.....	110.2	3 5/8.....	91.7	RS30239	13 1/2.....	342.9	11 1/8.....	282.6	6 23/32.....	170.7	LL1634
13 5/32.....	334.2	5 13/32.....	137.3	3 3/16.....	81.0	RS4131	13 1/2.....	342.9	11 1/8.....	282.6	6 23/32.....	170.7	PA1634
13 3/16.....	335.0	3 7/8.....	98.4	3 3/16.....	81.0	PA2370	13 1/2.....	342.9	11 1/8.....	282.6	6 23/32.....	170.7	PA1634XP
13 3/16.....	335.0	6 3/16.....	157.2	3 5/32.....	80.2	PA5582	13 1/2.....	342.9	11 15/32.....	291.3	7 1/8.....	181.0	RS3508
13 3/16.....	335.0	6 3/16.....	157.2	3 5/32.....	80.2	PA30206	13 1/2.....	342.9	11 15/32.....	291.3	7 1/8.....	181.0	RS3508XP
13 3/16.....	335.0	6 3/16.....	157.2	3 5/32.....	80.2	PA30207	13 1/2.....	342.9	11 1/2.....	292.1	8 1/16.....	204.8	LL2358
13 3/16.....	335.0	7.....	177.8	2 13/16.....	71.4	PA3759	13 1/2.....	342.9	11 1/2.....	292.1	8 1/16.....	204.8	PA2358
13 3/16.....	335.0	7 1/4.....	184.2	5 9/32.....	134.1	RS3509	13 1/2.....	342.9	11 5/8.....	295.3	4 27/32.....	123.0	PA1941-FN
13 3/16.....	335.0	8 1/8.....	206.4	3 3/4.....	95.3	PA3491	13 1/2.....	342.9	12 1/32.....	305.6	7 11/16.....	195.3	PA2414
13 7/32.....	335.8	4 1/8.....	104.8	3 3/8.....	85.7	RS30213	13 1/2.....	342.9	13 13/16.....	350.8	6 23/32.....	170.7	PA2870-FN
13 1/4.....	336.6	3 3/8.....	85.7	2 1/4.....	57.2	PA2305	13 1/2.....	342.9	13 7/8.....	352.4	7 7/16.....	188.9	PA3486
13 1/4.....	336.6	4 1/4.....	108.0	3 9/16.....	90.5	RS30169	13 1/2.....	342.9	13 7/8.....	352.4	9 1/2.....	241.3	PA4660
13 1/4.....	336.6	4 1/2.....	114.3	2.....	50.8	PA2602	13 1/2.....	342.9	13 7/8.....	352.4	3 5/32.....	80.2	PA3961
13 1/4.....	336.6	5 7/8.....	149.2	2 13/16.....	71.4	PA2767	13 1/2.....	342.9	13 17/32.....	343.7	4 3/4.....	120.6	RS30238
13 1/4.....	336.6	10 1/16.....	255.6	5 3/8.....	136.5	PA1989-FN	13 1/2.....	342.9	13 17/32.....	343.7	7 7/16.....	188.9	PA2517
13 1/4.....	336.6	11 29/32.....	302.4	7 17/32.....	191.3	PA3766	13 9/16.....	344.5	14 17/32.....	115.1	3 7/16.....	87.3	PA2308
13 9/32.....	337.3	4 5/8.....	117.5	3 1/32.....	77.0	PA4961	13 9/16.....	344.5	10.....	254.0	5 11/16.....	144.5	PA2606
13 9/32.....	337.3	7 13/16.....	198.4	3 15/32.....	88.1	PA3779-FN	13 19/32.....	345.3	3 3/32.....	78.6	2 15/16.....	74.6	RS3921
13 9/32.....	337.3	9 3/32.....	231.0	5 7/32.....	132.6	PA4145	13 19/32.....	345.3	4 27/32.....	123.0	3 5/8.....	92.1	PA4628
13 5/16.....	338.1	6 3/32.....	154.8	3 15/32.....	88.1	PA2392	13 19/32.....	345.3	5 1/16.....	128.6	3 13/16.....	96.8	PA2668
13 5/16.....	338.1	20 15/32.....	519.9	8 23/32.....	221.5	RS30065 KIT	13 19/32.....	345.3	11.....	279.4	4 27/32.....	123.0	PA3864
13 11/32.....	338.9	12 19/32.....	319.9	6.....	152.4	PA5762	13 19/32.....	345.3	11 13/32.....	289.7	4 29/32.....	124.6	PA4977-FN
13 3/8.....	339.7	2 15/16.....	74.6	2 13/32.....	61.1	PA2588	13 5/8.....	346.1	9 13/16.....	249.2	3 9/16.....	90.5	PA30233-FN
13 3/8.....	339.7	5 1/4.....	133.4	4 1/8.....	104.8	PA1836	13 21/32.....	346.9	3 5/16.....	84.1	2 1/4.....	57.2	PA2323
13 3/8.....	339.7	6 3/8.....	161.9	2 5/8.....	66.7	PA1883-FN	13 21/32.....	346.9	6 1/8.....	155.6	2 1/2.....	63.5	RS5591XP
13 3/8.....	339.7	7 11/32.....	186.5	3 1/32.....	100.8	PA2709	13 21/32.....	346.9	6 13/32.....	162.7	3 17/32.....	89.7	RS5641
13 3/8.....	339.7	7 15/16.....	201.6	3 9/16.....	90.5	PA2581	13 11/16.....	347.7	4 31/32.....	126.2	4 3/16.....	106.4	RS5783
13 3/8.....	339.7	7 31/32.....	202.4	3 5/16.....	84.1	PA2481	13 11/16.....	347.7	12 1/16.....	306.4	7 3/4.....	196.9	RS30225
13 3/8.....	339.7	8 1/4.....	209.6	7 3/32.....	180.2	PA4627	13 23/32.....	348.5	9 9/32.....	235.7	5 5/32.....	131.0	RS3733
13 3/8.....	339.7	8 13/32.....	213.5	4 29/32.....	124.6	RS5431	13 3/4.....	349.3	6 15/32.....	164.3	3 5/8.....	92.1	PA2845
13 3/8.....	339.7	8 7/8.....	225.4	4 1/8.....	104.8	PA3446	13 3/4.....	349.3	12 1/8.....	308.0	8 1/2.....	215.9	RS5455
13 3/8.....	339.7	9.....	228.6	5 3/8.....	136.5	PA2401	13 25/32.....	350.0	7 11/16.....	195.3	4 21/32.....	118.3	PA5787
13 3/8.....	339.7	10 1/16.....	255.6	3 9/16.....	90.5	PA1755-FN	13 25/32.....	350.0	13 15/32.....	342.1	5 1/32.....	127.8	RS5342
13 3/8.....	339.7	10 3/8.....	263.5	6 1/32.....	153.2	PA2616	13 27/32.....	351.6	5 1/4.....	133.4	3 23/32.....	94.5	RS3535
13 3/8.....	339.7	10 3/8.....	263.5	6 1/32.....	153.2	PA2616XP	13 27/32.....	351.6	7 13/16.....	198.4	3 3/8.....	85.7	PA3752
13 3/8.....	339.7	10 27/32.....	275.4	4 13/16.....	122.2	PA3850	13 27/32.....	351.6	19 9/32.....	489.7	12 7/8.....	327.0	PA3904
13 3/8.....	339.7	10 31/32.....	278.6	5 13/16.....	147.6	RS3504	13 7/8.....	352.4	3 5/8.....	92.1	2 15/16.....	74.6	PA2432
13 3/8.....	339.7	10 31/32.....	278.6	5 13/16.....	147.6	RS3504XP	13 7/8.....	352.4	5 15/16.....	150.8	4 27/32.....	123.0	PA2522
13 3/8.....	339.7	11 1/8.....	282.6	6 23/32.....	170.7	PA1881	13 7/8.....	352.4	7 11/32.....	186.5	5 3/8.....	136.5	PA3475
13 3/8.....	339.7	11 7/8.....	301.6	7 1/8.....	181.0	PA1790	13 7/8.....	352.4	7 11/16.....	195.3	4 21/32.....	118.3	PA5785
13 3/8.....	339.7	12 1/32.....	305.6	7 11/16.....	195.3	PA1920	13 29/32.....	353.2	7 1/8.....	181.0	2 27/32.....	72.2	PA3984



WARNING: These products can expose you to chemicals, including Diisononyl Phthalate, Carbon black extracts, Nickel, 1,3 Butadiene, Ethylene Oxide, Epichlorohydrin, which are known to the State of California to cause cancer, and Bisphenol-A, Ethylene Glycol, Ethylene Oxide, 1,3 Butadiene, Epichlorohydrin, which are known to the State of California to cause birth defects or other reproductive harm. For more information go to www.P65Warnings.ca.gov.

ROUND AIR FILTERS BY LENGTH

LENGTH Inches	LENGTH (mm)	O.D. Inches	O.D. (mm)	I.D. Inches	I.D. (mm)	BALDWIN NUMBER	LENGTH Inches	LENGTH (mm)	O.D. Inches	O.D. (mm)	I.D. Inches	I.D. (mm)	BALDWIN NUMBER
13 29/32	353.2	9 3/4	247.7	5 1/4	133.4	PA1845	14 3/8	365.1	15 25/32	400.8	9 1/2	241.3	LL2447-FN
13 15/16	354.0	4 15/16	125.4	3 31/32	100.8	RS3541	14 3/8	365.1	15 25/32	400.8	9 1/2	241.3	PA2447-FN
13 15/16	354.0	5 5/16	134.9	4 1/4	108.0	RS5547	14 13/32	365.9	6 7/8	174.6	5 5/32	131.0	RS3519
13 15/16	354.0	7 1/16	179.4	2 13/16	71.4	PA3859	14 7/16	366.7	7	177.8	4 19/32	116.7	PA2307
13 15/16	354.0	8 13/32	213.5	3 15/32	88.1	PA3852-FN	14 7/16	366.7	7 23/32	196.1	5 3/32	129.4	PA2759
13 31/32	354.8	3 17/32	89.7	2 13/32	61.1	PA4753	14 7/16	366.7	11 3/32	281.8	6 3/4	171.5	PA4889
13 31/32	354.8	6 3/32	154.8	2 7/16	61.9	RS5685	14 15/32	367.5	6 1/4	158.8	4 7/8	123.8	PA5529
14	355.6	3 17/32	89.7	2 3/8	60.3	PA2306	14 15/32	367.5	7 13/16	198.4	3 15/32	88.1	PA1699-FN
14	355.6	4 15/32	113.5	3 7/16	87.3	PA2319	14 1/2	368.3	5 15/16	150.8	4 27/32	123.0	PA2539
14	355.6	6 1/2	165.1	3 3/4	95.3	RS5784	14 1/2	368.3	6 1/4	158.8	4 5/8	117.5	PA2739
14	355.6	7 23/32	196.1	4 11/16	119.1	RS5782	14 1/2	368.3	6 5/8	168.3	4 1/4	108.0	PA1726
14	355.6	8 7/8	225.4	4 15/16	125.4	RS30168	14 1/2	368.3	8 5/8	219.1	7 1/16	179.4	PA2625
14	355.6	13 13/16	350.8	9 1/2	241.3	LL1630-2	14 1/2	368.3	8 13/16	223.8	4 3/16	106.4	PA2633-FN
14	355.6	13 13/16	350.8	9 1/2	241.3	PA1630-2	14 1/2	368.3	10	254.0	4 5/8	117.5	PA2433
14	355.6	13 27/32	351.6	11 1/8	282.6	PA1630	14 1/2	368.3	10 7/32	259.6	6 1/16	154.0	LL1895
14	355.6	13 27/32	351.6	11 1/8	282.6	PA1643	14 1/2	368.3	10 7/32	259.6	6 1/16	154.0	PA1895
14	355.6	13 27/32	351.6	11 1/8	282.6	PA3604	14 1/2	368.3	10 27/32	275.4	6 1/2	165.1	PA3914
14 1/32	356.4	3 29/32	99.2	3 1/16	77.8	RS4599	14 1/2	368.3	12 1/32	305.6	7 11/16	195.3	PA1863
14 1/32	356.4	6 1/2	165.1	3 9/16	90.5	RS3544	14 1/2	368.3	12 1/32	305.6	7 7/8	200.0	PA2707
14 1/32	356.4	6 1/2	165.1	3 9/16	90.5	RS5517	14 1/2	368.3	13 25/32	350.0	9 7/16	239.7	PA1706
14 1/32	356.4	6 7/8	174.6	6 1/2	165.1	RS3711	14 1/2	368.3	13 25/32	350.0	9 7/16	239.7	PA1706XP
14 1/32	356.4	7 11/32	186.5	6 1/2	165.1	RS5422	14 1/2	368.3	13 13/16	350.8	8 9/32	210.3	PA2774
14 1/32	356.4	15 1/4	387.4	6 9/16	166.7	PA2955	14 1/2	368.3	14 17/32	369.1	8 3/8	212.7	PA1818
14 1/16	357.2	3 25/32	96.0	2 7/8	73.0	PA2332	14 1/2	368.3	15 3/4	400.1	7 11/16	195.3	LL1676-FN
14 1/16	357.2	6 1/4	158.8	3 9/16	90.5	RS5745	14 1/2	368.3	15 3/4	400.1	7 11/16	195.3	PA1676-FN
14 1/16	357.2	6 1/2	165.1	2 27/32	72.2	PA2790-FN	14 17/32	369.1	8 3/8	212.7	4 27/32	123.0	RS4864
14 1/16	357.2	8 1/2	215.9	4 1/16	103.2	PA2528	14 17/32	369.1	8 13/32	213.5	6 3/16	157.2	PA2834
14 1/16	357.2	9 1/2	241.3	3 9/16	90.5	PA4960-FN	14 9/16	369.9	4 7/32	107.2	4 1/16	103.2	PA5531
14 3/32	358.0	3 5/8	92.1	2 7/16	61.9	PA2487	14 19/32	370.7	4 21/32	118.3	3 15/16	100.0	PA2547
14 3/32	358.0	4 1/8	104.8	3 29/32	99.2	RS5684	14 19/32	370.7	8 5/32	207.2	4 27/32	123.0	RS3540
14 3/32	358.0	4 5/32	105.6	2 29/32	73.8	PA2419	14 19/32	370.7	9 9/32	235.7	5 5/32	131.0	RS3538
14 1/8	358.8	5 7/8	149.2	2 15/16	74.6	RS5750	14 5/8	371.5	4 1/8	104.8	3	76.2	PA1897
14 1/8	358.8	5 31/32	151.6	3 3/8	85.7	RS3920	14 5/8	371.5	4 13/32	111.9	3 5/16	84.1	PA2835
14 3/16	360.4	5 5/16	134.9	3 13/32	86.5	PA2322	14 5/8	371.5	6 1/2	165.1	3 11/16	93.7	RS4598
14 3/16	360.4	6	152.4	3 5/8	92.1	PA1609	14 5/8	371.5	7 7/16	188.9	4 3/16	106.4	PA2341
14 3/16	360.4	6 3/8	161.9	5 9/32	134.1	PA3689	14 5/8	371.5	8 3/8	212.7	3 15/32	88.1	PA2635-FN
14 3/16	360.4	7 1/8	181.0	3	76.2	PA3554	14 5/8	371.5	9 11/16	246.1	4 7/8	123.8	RS5301
14 7/32	361.2	3 17/32	88.7	3 13/32	86.5	RS3923	14 5/8	371.5	9 11/16	246.1	4 7/8	123.8	RS30236
14 7/32	361.2	5 1/4	133.4	3 23/32	94.5	RS3521	14 21/32	372.3	3 9/16	90.5	2 13/16	71.4	RS30061
14 1/4	362.0	4 1/8	104.8	3	76.2	PA3430	14 21/32	372.3	5 3/4	146.1	3 1/16	77.8	PA2587
14 1/4	362.0	5 1/2	139.7	3 1/8	79.4	PA1682	14 11/16	373.1	15 25/32	400.8	9 1/2	241.3	PA2867-FN
14 1/4	362.0	6 3/8	161.9	2 5/8	66.7	PA1707-FN	14 23/32	373.9	4 13/16	122.2	3 5/8	92.1	PA2469
14 1/4	362.0	9 7/32	234.2	5 3/16	131.8	PA30243	14 23/32	373.9	5 23/32	145.3	3 7/16	87.3	PA2452
14 1/4	362.0	12 1/16	306.4	6 3/32	154.8	PA2316	14 23/32	373.9	5 3/4	146.1	3 7/16	87.3	PA5486
14 1/4	362.0	15 5/8	396.9	10 9/32	261.1	PA3905	14 23/32	373.9	8 9/32	210.3	5 5/32	131.0	PA5503
14 9/32	362.7	7 21/32	194.5	6 31/32	177.0	RS5731	14 23/32	373.9	10 29/32	277.0	6 25/32	172.2	RS3710
14 5/16	363.5	5 1/8	130.2	2 15/32	62.7	LL2344-FN	14 3/4	374.6	3 1/2	88.9	2 13/16	71.4	PA5764
14 5/16	363.5	5 1/8	130.2	2 15/32	62.7	PA2344-FN	14 3/4	374.7	5 9/32	134.1	3 7/16	87.3	PA5557
14 5/16	363.5	5 1/8	130.2	2 15/32	62.7	PA3805-FN	14 3/4	374.7	6 3/8	161.9	3 3/4	95.3	RS3922
14 5/16	363.5	5 3/4	146.1	4 13/16	122.2	PA2301	14 3/4	374.7	7 11/32	186.5	4	101.6	PA2511
14 5/16	363.5	6 5/8	168.3	4 11/32	110.3	PA2637	14 3/4	374.7	7 13/16	198.4	4 3/32	104.0	PA2405
14 5/16	363.5	8 3/4	222.3	4 3/16	106.4	PA2302-FN	14 3/4	374.7	9 7/32	234.2	5 27/32	148.4	PA4624
14 5/16	363.5	10 1/16	255.6	5 3/8	136.5	PA1837-FN	14 25/32	375.4	6 1/4	158.8	5 11/16	144.5	PA4809
14 11/32	364.3	4 7/8	123.8	3 3/8	85.7	PA5504	14 25/32	375.4	7 25/32	197.6	3 15/16	100.0	PA5473
14 11/32	364.3	7 7/8	200.0	3 7/8	98.4	PA3405	14 13/16	376.2	7 1/2	190.5	5 11/16	144.5	RS5749
14 3/8	365.1	4 1/16	103.2	3 5/16	84.1	RS5490	14 13/16	376.2	9 3/4	247.7	4 1/16	103.2	PA2866
14 3/8	365.1	5 5/16	134.9	3 13/32	86.5	PA2486	14 27/32	377.0	4 5/8	117.5	3 11/16	93.7	PA1998
14 3/8	365.1	6 1/8	155.6	4 15/16	125.4	PA2460	14 27/32	377.0	5 1/4	133.4	3 23/32	94.5	RS3533
14 3/8	365.1	6 3/8	161.9	5 9/32	134.1	PA2578	14 27/32	377.0	9 17/32	242.1	5 3/16	131.8	PA3760
14 3/8	365.1	6 7/8	174.6	3 1/2	88.9	PA1940	14 7/8	377.8	3 5/16	84.1	2 15/32	62.7	RS3709
14 3/8	365.1	6 7/8	174.6	3 1/2	88.9	PA1972	14 7/8	377.8	7 1/2	190.5	5 1/4	133.4	PA3566
14 3/8	365.1	6 7/8	174.6	5 9/16	141.3	PA2605	14 7/8	377.8	11 29/32	302.4	7 17/32	191.3	PA2813
14 3/8	365.1	7 3/16	182.6	5 11/16	144.5	PA2579	14 29/32	378.6	10 31/32	278.6	7	101.6	PA5735
14 3/8	365.1	8 1/4	209.6	7 1/8	181.0	PA2960	14 15/16	379.4	4 25/32	121.4	3 11/16	93.7	PA2836
14 3/8	365.1	13 3/4	349.3	6 3/4	171.5	PA1978-FN	15	381.0	4 1/4	108.0	2 3/4	69.9	RS3935



WARNING: These products can expose you to chemicals, including Diisononyl Phthalate, Carbon black extracts, Nickel, 1,3 Butadiene, Ethylene Oxide, Epichlorohydrin, which are known to the State of California to cause cancer, and Bisphenol-A, Ethylene Glycol, Ethylene Oxide, 1,3 Butadiene, Epichlorohydrin, which are known to the State of California to cause birth defects or other reproductive harm. For more information go to www.P65Warnings.ca.gov.

ROUND AIR FILTERS BY LENGTH

LENGTH Inches	LENGTH (mm)	O.D. Inches	O.D. (mm)	I.D. Inches	I.D. (mm)	BALDWIN NUMBER	LENGTH Inches	LENGTH (mm)	O.D. Inches	O.D. (mm)	I.D. Inches	I.D. (mm)	BALDWIN NUMBER
15	381.0	4 1/4	108.0	3 3/8	85.7	RS5335	15 3/8	390.5	8 3/4	222.3	3 1/2	88.9	PA2524-FN
15	381.0	5 1/8	130.2	4 3/8	111.1	RS5345	15 3/8	390.5	9 7/32	234.2	4 27/32	123.0	PA2953
15	381.0	5 9/32	134.1	3 13/32	86.5	RS30060-FN	15 13/32	391.3	7 5/8	193.7	6 1/16	154.0	PA1904
15	381.0	5 11/16	144.5	4 13/32	111.9	PA3470	15 13/32	391.3	8 3/8	212.7	3 1/8	79.4	RS5395-FN
15	381.0	5 29/32	150.0	4 13/32	111.9	RS3722	15 13/32	391.3	9 15/16	252.4	6 15/16	176.2	RS4863
15	381.0	5 15/16	150.8	4 27/32	123.0	PA3847	15 7/16	392.1	6 7/8	174.6	4 1/4	108.0	PA1898
15	381.0	5 15/16	150.8	4 29/32	124.6	PA3656	15 7/16	392.1	7 5/16	185.7	6 19/32	167.5	RS5539
15	381.0	6 5/16	160.3	2 13/16	71.4	PA4865-FN	15 7/16	392.1	8 13/32	213.5	3 15/32	88.1	PA3690
15	381.0	6 1/2	165.1	3 3/8	85.7	PA5763	15 15/32	392.9	5 13/32	137.3	3 3/16	81.0	RS3708
15	381.0	7	177.8	3 3/8	85.7	PA1826	15 15/32	392.9	6 3/8	161.9	3 5/8	92.1	PA2541-FN
15	381.0	7 1/4	184.2	5 7/16	138.1	RS5292	15 15/32	392.9	9 5/32	232.6	4 7/8	123.8	PA2971
15	381.0	7 1/2	190.5	5 1/4	133.4	PA2455	15 15/32	392.9	12 3/32	307.2	6 3/32	154.8	PA3978
15	381.0	8 27/32	224.6	5 15/32	138.9	PA2550	15 1/2	393.7	5 1/4	133.4	4 1/8	104.8	PA2568
15	381.0	8 15/16	227.0	4 19/32	116.7	PA2474	15 1/2	393.7	5 3/4	146.1	4 7/8	123.8	RS5347
15	381.0	8 15/16	227.0	4 19/32	116.7	PA3605	15 1/2	393.7	6 1/16	154.0	3 15/32	88.1	PA1831
15	381.0	9 9/32	235.7	5 5/32	131.0	RS3520	15 1/2	393.7	7	177.8	3 5/8	92.1	PA2756
15	381.0	9 21/32	245.3	4 23/32	119.9	RS4775	15 1/2	393.7	7 5/16	185.7	6 5/32	156.4	PA3832
15	381.0	10 3/8	263.5	6 1/32	153.2	PA2556	15 1/2	393.7	7 15/16	201.6	4 5/8	117.5	PA4656
15	381.0	10 1/2	266.7	5	127.0	PA30158	15 1/2	393.7	8 3/8	212.7	3 15/32	88.1	PA2977-FN
15	381.0	12 1/16	306.4	7 11/16	195.3	PA666	15 1/2	393.7	8 3/8	212.7	3 15/32	88.1	PA3669-FN
15	381.0	12 1/4	311.2	10 1/8	257.2	PA30069	15 1/2	393.7	9 7/32	234.2	4 27/32	123.0	PA2451
15	381.0	12 3/4	323.9	8 11/32	211.9	LL2439	15 1/2	393.7	9 9/32	235.7	4 11/16	119.1	PA2788
15	381.0	12 3/4	323.9	8 11/32	211.9	PA2439	15 1/2	393.7	9 9/32	235.7	4 11/16	119.1	PA3629
15	381.0	12 3/4	323.9	8 11/32	211.9	PA2494	15 1/2	393.7	9 7/16	239.7	4 17/32	115.1	LL2318
15 1/16	382.6	8 5/32	207.2	4 9/32	108.7	RS4972	15 1/2	393.7	9 7/16	239.7	4 17/32	115.1	PA2318
15 1/16	382.6	9 5/8	244.5	4 3/32	104.0	PA2374	15 1/2	393.7	9 5/8	244.5	5 7/32	132.6	LL2667
15 1/16	382.6	8 31/32	277.8	4 7/16	112.7	PA5530	15 1/2	393.7	9 5/8	244.5	5 7/32	132.6	PA2667
15 3/32	383.4	4 25/32	121.4	3 5/8	92.1	PA2427	15 1/2	393.7	9 29/32	251.6	5 3/8	136.5	PA2887-FN
15 3/32	383.4	7 17/32	191.3	3 7/16	87.3	PA4697-FN	15 1/2	393.7	10	254.0	5 3/8	136.5	PA2338-FN
15 3/32	383.4	10 15/16	277.8	4 9/16	115.9	PA2847	15 1/2	393.7	10 27/32	275.4	6 1/2	165.1	PA2577
15 5/32	385.0	4 1/4	108.0	3 3/8	85.7	RS5304	15 1/2	393.7	12 13/32	315.1	8 3/16	208.0	RS3510
15 5/32	385.0	4 11/32	110.3	3 9/16	90.5	RS3993	15 1/2	393.7	12 13/32	315.1	8 3/16	208.0	RS3510XP
15 5/32	385.0	6 1/4	158.8	5 1/4	133.4	RS5453	15 1/2	393.7	12 13/32	315.1	8 3/16	208.0	RS3512
15 5/32	385.0	7 11/32	186.5	3 31/32	100.8	PA2369	15 1/2	393.7	12 1/2	317.5	9 1/8	231.8	LL2384
15 5/32	385.0	10 29/32	277.0	6 3/4	171.5	RS3750XP	15 1/2	393.7	12 1/2	317.5	9 1/8	231.8	PA2384
15 7/32	386.6	6 23/32	170.7	5 1/2	139.7	RS5295	15 1/2	393.7	12 1/2	317.5	9 1/8	231.8	PA2384XP
15 7/32	386.6	8 5/16	211.1	6 1/32	153.2	RS3511	15 1/2	393.7	13 3/4	349.3	6 23/32	170.7	PA1864-FN
15 7/32	386.6	8 5/16	211.1	6 1/32	153.2	RS3515	15 1/2	393.7	14 15/32	367.5	6 15/32	164.3	PA2600
15 7/32	386.6	9 3/32	231.0	6 29/32	175.4	RS3713	15 1/2	393.7	14 1/2	368.3	9 1/2	241.3	PA2624
15 1/4	387.4	4 1/8	104.8	3	76.2	PA3610	15 1/2	393.7	15 25/32	400.8	9 1/2	241.3	PA2959-FN
15 1/4	387.4	4 23/32	119.9	4	101.6	RS3995	15 17/32	394.5	6 5/8	168.3	4 1/4	108.0	PA2946
15 1/4	387.4	8 11/16	204.8	5 3/4	146.1	PA1686	15 17/32	394.5	7 11/32	186.5	4 5/32	105.6	RS5334
15 1/4	387.4	8 1/2	215.9	5 3/8	136.5	PA3467	15 17/32	394.5	13 15/32	342.1	8 5/32	207.2	RS4988
15 1/4	387.4	11 3/8	288.9	6 31/32	177.0	PA2385	15 17/32	394.5	14 7/32	361.2	8 15/16	227.0	RS3712
15 1/4	387.4	12 1/8	308.0	7 11/16	195.3	PA2833	15 17/32	394.5	16 1/8	409.6	7 7/16	188.9	PA2648
15 1/4	387.4	12 31/32	329.4	6 13/16	173.0	RS3518	15 9/16	395.3	4 1/8	104.8	3 7/16	87.3	RS5479
15 1/4	387.4	12 31/32	329.4	6 13/16	173.0	RS3518XP	15 9/16	395.3	5 9/16	141.3	4 7/16	112.7	PA2674
15 5/16	388.9	6 3/32	154.8	3 15/32	88.1	PA2314	15 9/16	395.3	5 11/16	144.5	4 15/16	125.4	PA2743
15 5/16	388.9	6 3/32	154.8	3 15/32	88.1	PA2420	15 9/16	395.3	7 3/4	196.9	3 15/32	88.1	PA4631-FN
15 5/16	388.9	7 1/2	190.5	3 3/4	95.3	PA2431	15 9/16	395.3	7 27/32	199.2	5	127.0	PA5297
15 5/16	388.9	7 13/16	198.4	3 15/32	88.1	PA1822-FN	15 9/16	395.3	9 13/16	249.2	5 3/16	131.8	PA2677
15 5/16	388.9	7 13/16	198.4	3 15/32	88.1	LL2418-FN	15 9/16	395.3	9 29/32	251.6	6 1/16	154.0	PA3775
15 5/16	388.9	7 13/16	198.4	3 15/32	88.1	PA2418-FN	15 9/16	395.3	10	254.0	4 27/32	123.0	PA3948
15 5/16	388.9	8 3/4	222.3	4 3/16	106.4	PA3439-FN	15 19/32	396.1	8 13/32	213.5	4 29/32	124.6	RS5435
15 5/16	388.9	11 1/8	282.6	6 23/32	170.7	PA3699	15 19/32	396.1	10	254.0	4 27/32	123.0	PA5357
15 5/16	388.9	12 1/32	305.6	7 11/16	195.3	LL2330	15 5/8	396.9	6 15/32	164.3	2 27/32	72.2	PA4825
15 5/16	388.9	12 1/32	305.6	7 11/16	195.3	PA2330	15 5/8	396.9	8 5/32	207.2	4 3/16	106.4	RS3934
15 11/32	389.7	8 1/32	204.0	5 1/32	127.8	RS4637	15 5/8	396.9	9 9/32	235.7	5 5/32	131.0	RS3532
15 11/32	389.7	9 23/32	246.9	6 5/16	160.3	RS5692	15 5/8	396.9	10 31/32	278.6	5 13/16	147.6	RS3548
15 11/32	389.7	12	304.8	6 31/32	177.0	PA1797	15 5/8	396.9	10 31/32	278.6	5 13/16	147.6	RS3548XP
15 3/8	390.5	4 9/16	115.9	3 7/16	87.3	PA1981	15 21/32	397.7	5 9/16	141.3	4 13/32	111.9	PA2435
15 3/8	390.5	5 29/32	150.0	3 31/32	100.8	PA3949	15 21/32	397.7	5 3/4	146.1	3 7/16	87.3	PA1912
15 3/8	390.5	6 3/8	161.9	3 1/4	82.6	LL2360-FN	15 21/32	397.7	7 11/32	186.5	4 5/32	105.6	RS3971
15 3/8	390.5	6 3/8	161.9	3 1/4	82.6	PA2360-FN	15 21/32	397.7	7 7/8	200.0	6 3/16	157.2	RS3741
15 3/8	390.5	6 27/32	173.8	3 15/32	88.1	PA2551	15 21/32	397.7	8 3/16	208.0	3 11/16	93.7	PA4709
15 3/8	390.5	7 3/32	180.2	3 15/32	88.1	PA3487	15 21/32	397.7	10 29/32	277.0	6 25/32	172.2	RS3750



WARNING: These products can expose you to chemicals, including Diisononyl Phthalate, Carbon black extracts, Nickel, 1,3 Butadiene, Ethylene Oxide, Epichlorohydrin, which are known to the State of California to cause cancer, and Bisphenol-A, Ethylene Glycol, Ethylene Oxide, 1,3 Butadiene, Epichlorohydrin, which are known to the State of California to cause birth defects or other reproductive harm. For more information go to www.P65Warnings.ca.gov.

ROUND AIR FILTERS BY LENGTH

LENGTH Inches	LENGTH (mm)	O.D. Inches	O.D. (mm)	I.D. Inches	I.D. (mm)	BALDWIN NUMBER	LENGTH Inches	LENGTH (mm)	O.D. Inches	O.D. (mm)	I.D. Inches	I.D. (mm)	BALDWIN NUMBER
15 11/16	398.5	5 9/16	141.3	4 13/32	111.9	RS3507	16 5/16	414.3	9 3/32	231.0	5 7/16	138.1	RS5441
15 11/16	398.5	6 23/32	170.7	6 1/16	154.0	RS30191	16 5/16	414.3	9 19/32	243.7	5 7/16	138.1	RS4969
15 11/16	398.5	11 1/2	292.1	7 1/4	184.2	PA2611	16 5/16	414.3	9 5/8	244.5	6 3/16	157.2	PA2459
15 11/16	398.5	12 1/16	306.4	5 11/16	144.5	PA2429	16 5/16	414.3	10	254.0	5 3/8	136.5	LL1902-FN
15 11/16	398.5	12 1/16	306.4	7 11/16	195.3	PA3558	16 5/16	414.3	10	254.0	5 3/8	136.5	PA1902-FN
15 23/32	399.3	5 1/4	133.4	3 23/32	94.5	RS3732	16 5/16	414.3	14 7/8	377.8	7 7/8	200.0	PA3768
15 23/32	399.3	5 29/32	150.0	4 3/8	111.1	RS5392	16 11/32	415.1	5 1/4	133.4	4 1/8	104.8	PA3578
15 23/32	399.3	7 11/16	195.3	4 17/32	115.1	RS3992	16 11/32	415.1	9 9/32	235.7	5 5/32	131.0	RS3731
15 3/4	400.1	5 1/2	139.7	3 3/4	95.3	RS5559	16 11/32	415.1	9 15/32	240.5	5 9/16	141.3	RS5348
15 3/4	400.1	10	254.0	4 31/32	126.2	PA5485-FN	16 11/32	415.1	13 25/32	350.0	7 15/16	201.6	RS4967
15 3/4	400.1	11	279.4	7 3/32	180.2	RS5291	16 3/8	415.9	5 23/32	145.3	4 19/32	116.7	PA2467
15 3/4	400.1	13 13/16	350.8	9 1/2	241.3	PA3602	16 3/8	415.9	5 15/16	150.8	4 27/32	123.0	PA2510
15 25/32	400.8	8 1/2	215.9	6 7/32	158.0	PA2883	16 3/8	415.9	8 1/4	209.6	7 1/8	181.0	PA2630
15 27/32	402.4	8 11/16	220.7	4 15/16	125.4	RS3994	16 3/8	415.9	8 5/8	219.1	4 1/4	108.0	PA1997
15 27/32	402.4	15 3/32	383.4	6 23/32	170.7	PA5425	16 3/8	415.9	8 3/4	222.3	4 3/16	106.4	LL2426-FN
15 7/8	403.2	7 5/8	193.7	6 1/16	154.0	PA2526	16 3/8	415.9	8 3/4	222.3	4 3/16	106.4	PA2426-FN
15 7/8	403.2	7 5/8	193.7	6 1/16	154.0	PA3480	16 3/8	415.9	9 7/32	234.2	4 27/32	123.0	PA1827
15 7/8	403.2	10 3/8	263.5	5 3/4	146.1	RS5627	16 3/8	415.9	10	254.0	5 11/16	144.5	PA2569
15 7/8	403.2	11 1/2	292.1	7 1/4	184.2	PA2604	16 3/8	415.9	10 1/16	255.6	3 9/16	90.5	PA1650-FN
15 7/8	403.2	12	304.8	6 1/2	165.1	RS30090-FN	16 3/8	415.9	11	279.4	4 27/32	123.0	PA3849
15 29/32	404.0	5 5/16	134.9	4 3/8	111.1	RS5548	16 3/8	415.9	12 1/32	305.6	7 11/16	195.3	LL1992
15 29/32	404.0	8 1/2	215.9	4 13/16	122.2	PA5556	16 3/8	415.9	12 1/2	317.5	6	152.4	PA2821
15 29/32	404.0	10 1/4	260.4	7 15/16	201.6	RS4636	16 3/8	415.9	13 3/4	349.3	6 3/4	171.5	PA1979-FN
15 15/16	404.8	14 5/32	359.6	9 1/2	241.3	PA1687	16 3/8	415.9	15 3/4	400.1	7 11/16	195.3	PA1992-FN
15 15/16	404.8	16 1/16	408.0	8 21/32	219.9	PA2839	16 13/32	416.7	5 1/4	133.4	3 3/4	95.3	RS4677
15 31/32	405.6	13 17/32	343.7	5 1/32	127.8	RS5343	16 7/16	417.5	4 21/32	118.3	3 15/16	100.0	PA2368
16	406.4	6 3/32	154.8	5 11/32	135.7	RS5361	16 7/16	417.5	6 11/16	169.9	2 27/32	72.2	PA4582
16	406.4	7 1/2	190.5	5 1/4	133.4	PA1893	16 7/16	417.5	8 3/8	212.7	4 11/16	119.1	RS4970
16	406.4	8 21/32	219.9	5 3/16	131.8	PA2540	16 7/16	417.5	8 1/2	215.9	4	101.6	RS5478-FN
16	406.4	9 1/16	230.2	4 5/8	117.5	PA1670	16 7/16	417.5	8 5/8	219.1	4 1/4	108.0	PA2495
16	406.4	9 29/32	251.6	6 1/16	154.0	PA3655	16 7/16	417.5	10 1/32	254.8	4 31/32	126.2	RS5344
16	406.4	10 3/8	263.5	6 1/32	153.2	LL2425	16 7/16	417.5	10 3/8	263.5	6 1/32	153.2	LL2521
16	406.4	10 3/8	263.5	6 1/32	153.2	PA2425	16 7/16	417.5	10 3/8	263.5	6 1/32	153.2	PA2521
16	406.4	12 1/32	305.6	6 23/32	170.7	PA2643	16 7/16	417.5	10 31/32	278.6	5 25/32	146.8	RS30285
16	406.4	12 1/16	306.4	7 11/16	195.3	LL2661	16 7/16	417.5	10 31/32	278.6	5 13/16	147.6	RS3506
16	406.4	12 1/16	306.4	7 11/16	195.3	PA2661	16 7/16	417.5	10 31/32	278.6	5 13/16	147.6	RS4561
16	406.4	12 15/32	316.7	7 7/8	200.0	PA1702	16 7/16	417.5	11	279.4	5 3/8	136.5	PA3854-FN
16	406.4	13 13/16	350.8	9 1/2	241.3	LL1649	16 7/16	417.5	12 31/32	329.4	7 3/4	196.9	RS3740
16	406.4	13 13/16	350.8	9 1/2	241.3	PA1649	16 15/32	418.3	9 3/16	233.4	4 13/16	122.2	PA4925
16	406.4	13 13/16	350.8	9 1/2	241.3	LL2685	16 15/32	418.3	9 17/32	242.1	4 13/16	122.2	RS4861
16	406.4	16 5/8	422.3	12	304.8	PA1632	16 15/32	418.3	10 7/16	265.1	6 3/16	157.2	RS5360
16 1/32	407.2	13 5/16	338.1	9 7/8	250.8	RS5389-FN	16 15/32	418.3	11	279.4	7 11/16	195.3	RS5296
16 1/32	407.2	16 1/8	409.6	7 7/16	188.9	PA2544	16 1/2	419.1	4 9/16	115.9	3 7/16	87.3	PA3809
16 1/16	408.0	4 1/4	108.0	3 3/8	85.7	RS3885	16 1/2	419.1	5 3/4	146.1	4 3/8	111.1	RS5628
16 3/32	408.8	5 1/4	133.4	4 1/8	104.8	PA2443	16 1/2	419.1	7 1/4	184.2	6 3/16	157.2	PA2967
16 3/32	408.8	12 1/16	306.4	9 7/8	250.8	RS4862	16 1/2	419.1	7 5/8	193.7	4 1/4	108.0	LL2783
16 1/8	409.6	7 1/4	184.2	3 5/8	92.1	RS5329	16 1/2	419.1	7 15/16	201.6	3 9/16	90.5	PA2484
16 1/8	409.6	12 13/16	325.4	5 15/16	150.8	RS4966	16 1/2	419.1	7 15/16	201.6	3 9/16	90.5	PA2856
16 1/8	409.6	13 3/32	332.6	8 9/32	210.3	RS5730	16 1/2	419.1	7 15/16	201.6	3 9/16	90.5	PA3460
16 5/32	410.4	5 5/32	131.0	4 1/32	102.4	PA2530	16 1/2	419.1	7 15/16	201.6	5 3/8	136.5	PA2523
16 5/32	410.4	9 1/8	231.8	5 13/16	147.6	RS5535	16 1/2	419.1	9 7/32	234.2	4 27/32	123.0	PA2641
16 5/32	410.4	9 25/32	248.4	5 21/32	143.7	RS5537	16 1/2	419.1	9 11/32	237.3	4 5/32	105.6	RS30059-FN
16 5/32	410.4	16 7/16	417.5	9 15/16	252.4	PA1815	16 1/2	419.1	9 29/32	251.6	6 1/16	154.0	PA2777
16 7/32	412.0	5 29/32	150.0	4 5/16	109.5	RS5676	16 1/2	419.1	10	254.0	5 3/8	136.5	PA4650-FN
16 7/32	412.0	9 1/16	230.2	4 5/8	117.5	PA2733	16 1/2	419.1	10 3/8	263.5	6 1/32	153.2	PA2538
16 1/4	412.8	5 21/32	143.7	4 7/16	112.7	RS5759	16 1/2	419.1	10 7/8	276.2	4 13/16	122.2	PA3675
16 1/4	412.8	6 3/32	154.8	3 15/32	88.1	PA1709	16 1/2	419.1	10 29/32	277.0	6 25/32	172.2	RS5452
16 1/4	412.8	7 1/16	179.4	5 29/32	150.0	RS5708	16 1/2	419.1	11	279.4	6 1/32	153.2	PA2300
16 1/4	412.8	7 13/16	198.4	3 15/32	88.1	PA1850-FN	16 1/2	419.1	11 1/8	282.6	6 23/32	170.7	LL1669
16 1/4	412.8	10 7/32	259.6	6 1/2	165.1	PA5528	16 1/2	419.1	11 1/8	282.6	6 23/32	170.7	PA1669
16 1/4	412.8	11 31/32	304.0	5 27/32	148.4	RS5507	16 1/2	419.1	11 1/8	282.6	6 23/32	170.7	LL1885
16 1/4	412.8	14	355.6	7 25/32	197.6	RS5776	16 1/2	419.1	11 1/8	282.6	6 23/32	170.7	PA1885
16 9/32	413.5	9 1/2	241.3	8 1/8	206.4	RS5758	16 1/2	419.1	11 1/8	282.6	6 23/32	170.7	PA1885XP
16 5/16	414.3	5 29/32	150.0	4 1/32	102.4	PA5497	16 1/2	419.1	11 1/8	282.6	6 23/32	170.7	PA2951
16 5/16	414.3	9 3/32	231.0	5 7/16	138.1	RS5409	16 1/2	419.1	11 7/16	290.5	6 3/16	157.2	PA3862-FN



WARNING: These products can expose you to chemicals, including Diisononyl Phthalate, Carbon black extracts, Nickel, 1,3 Butadiene, Ethylene Oxide, Epichlorohydrin, which are known to the State of California to cause cancer, and Bisphenol-A, Ethylene Glycol, Ethylene Oxide, 1,3 Butadiene, Epichlorohydrin, which are known to the State of California to cause birth defects or other reproductive harm. For more information go to www.P65Warnings.ca.gov.

ROUND AIR FILTERS BY LENGTH

LENGTH Inches	LENGTH (mm)	O.D. Inches	O.D. (mm)	I.D. Inches	I.D. (mm)	BALDWIN NUMBER	LENGTH Inches	LENGTH (mm)	O.D. Inches	O.D. (mm)	I.D. Inches	I.D. (mm)	BALDWIN NUMBER
16 1/2.....	419.1	12 1/32.....	305.6	7 7/8.....	200.0	PA3453	17 7/16.....	442.9	9 1/32.....	229.4	7 1/32.....	178.6	RS30129
16 1/2.....	419.1	12 1/8.....	308.0	7 11/16.....	195.3	LL1886	17 7/16.....	442.9	9 11/16.....	246.1	4 29/32.....	124.6	RS4562
16 1/2.....	419.1	12 1/8.....	308.0	7 11/16.....	195.3	PA1886	17 7/16.....	442.9	12 19/32.....	319.9	7 27/32.....	199.2	PA30010
16 1/2.....	419.1	12 1/8.....	308.0	7 11/16.....	195.3	PA1886XP	17 1/2.....	444.5	5 23/32.....	145.3	4 19/32.....	116.7	PA2621
16 1/2.....	419.1	12 9/32.....	311.9	6 31/32.....	177.0	RS30112	17 1/2.....	444.5	6 3/8.....	161.9	5 9/32.....	134.1	PA2853
16 1/2.....	419.1	12 15/32.....	316.7	6 3/16.....	157.2	PA3855-FN	17 1/2.....	444.5	7 1/16.....	179.4	5 11/16.....	144.5	RS5351
16 1/2.....	419.1	12 1/2.....	317.5	6.....	152.4	PA3652	17 1/2.....	444.5	7 3/32.....	179.8	6 3/8.....	161.8	RS30308
16 1/2.....	419.1	12 1/2.....	317.5	6.....	152.4	PA3860	17 1/2.....	444.5	9 7/32.....	234.2	5 27/32.....	148.4	PA2673
16 1/2.....	419.1	14 3/16.....	360.4	6 23/32.....	170.7	PA2533	17 1/2.....	444.5	13 3/8.....	339.7	8 3/8.....	212.7	LL2326
16 1/2.....	419.1	15 3/4.....	400.1	7 11/16.....	195.3	PA3786-FN	17 1/2.....	444.5	13 3/8.....	339.7	8 3/8.....	212.7	PA2326
16 17/32.....	419.9	8 13/32.....	213.5	4 11/16.....	119.1	RS5433	17 1/2.....	444.5	13 3/8.....	339.7	8 3/8.....	212.7	PA2326XP
16 9/16.....	420.7	8 5/32.....	207.2	4 3/16.....	106.4	RS3734	17 17/32.....	445.3	8 9/32.....	210.3	7 3/32.....	180.2	PA5446
16 9/16.....	420.7	8 5/32.....	207.2	4 3/16.....	106.4	RS3734XP	17 9/16.....	446.1	9 27/32.....	250.0	4 3/4.....	120.7	RS5411
16 9/16.....	420.7	8 5/32.....	207.2	4 3/16.....	106.4	RS3884	17 9/16.....	446.1	12 19/32.....	319.9	7 13/16.....	198.4	PA5505
16 9/16.....	420.7	8 7/8.....	225.4	4 1/8.....	104.8	PA2480	17 19/32.....	446.9	7 15/32.....	189.7	6 1/2.....	165.1	PA5275
16 9/16.....	420.7	10.....	254.0	5 11/16.....	144.5	PA2434	17 19/32.....	446.9	7 31/32.....	202.4	7.....	177.8	PA3925
16 19/32.....	421.5	5 15/32.....	138.9	4 1/2.....	114.3	RS5398	17 19/32.....	446.9	8 15/32.....	215.1	6 3/16.....	157.2	PA1880
16 19/32.....	421.5	13 1/2.....	342.9	7.....	7.0	PA30041	17 19/32.....	446.9	9 1/8.....	231.8	5 13/16.....	147.6	PA3906
16 19/32.....	421.5	14.....	355.6	7 25/32.....	197.6	PA3767	17 19/32.....	446.9	10.....	254.0	5 7/8.....	141.3	PA2742
16 5/8.....	421.9	13 1/2.....	343.2	7 1/16.....	179.6	PA30314	17 19/32.....	446.9	11 29/32.....	302.4	6 5/8.....	168.3	RS3724
16 5/8.....	422.3	5 23/32.....	145.3	4 19/32.....	116.7	PA5412	17 21/32.....	448.5	11 3/32.....	281.8	7 7/16.....	188.9	RS5538
16 21/32.....	423.1	4 29/32.....	124.6	3 31/32.....	100.8	PA5298	17 11/16.....	449.3	5 27/32.....	148.4	4 5/32.....	105.6	PA30194
16 21/32.....	423.1	8.....	203.2	4 3/8.....	111.1	RS5489	17 11/16.....	449.3	12 1/16.....	306.4	5 11/16.....	144.5	PA2428
16 21/32.....	423.1	12 3/4.....	323.9	8 11/32.....	211.9	PA2797	17 23/32.....	450.1	4 7/16.....	112.7	3 5/16.....	84.1	RS4673
16 11/16.....	423.9	12 1/32.....	305.6	7 11/16.....	195.3	LL2945	17 23/32.....	450.1	6 7/8.....	174.6	5 5/32.....	131.0	RS3531
16 11/16.....	423.9	12 1/32.....	305.6	7 11/16.....	195.3	PA2945	17 3/4.....	450.9	12 1/32.....	305.6	7 11/16.....	195.3	PA2612
16 23/32.....	424.7	8 13/16.....	223.8	5 17/32.....	140.5	RS5558	17 3/4.....	450.9	13 15/32.....	342.1	8 5/32.....	207.2	RS3738
16 23/32.....	424.7	8 27/32.....	224.6	7 1/8.....	181.0	RS4992	17 3/4.....	450.9	15 5/8.....	396.9	10 9/32.....	261.1	PA3933
16 3/4.....	425.2	11 9/16.....	293.9	5 13/16.....	147.6	RS30313	17 25/32.....	451.6	6 3/8.....	161.9	5 9/32.....	134.1	PA30108
16 3/4.....	425.5	8 13/32.....	213.5	6 3/16.....	157.2	PA5464	17 13/16.....	452.4	9 11/16.....	246.1	8 1/8.....	206.4	PA3551
16 3/4.....	425.5	8 1/2.....	215.9	4 5/32.....	105.6	PA3609	17 13/16.....	452.4	10 3/8.....	263.5	6 1/32.....	153.2	PA2382
16 3/4.....	425.5	8 1/2.....	215.9	4 5/32.....	105.6	PA4581	17 27/32.....	453.2	6 7/8.....	174.6	5 1/4.....	133.4	RS30058
16 13/16.....	427.0	8 5/16.....	211.1	6 1/32.....	153.2	RS3739	17 27/32.....	453.2	9 3/32.....	231.0	6 29/32.....	175.4	RS3701
16 13/16.....	427.0	8 27/32.....	224.5	7 1/8.....	181.0	RS30257	17 7/8.....	454.0	5 1/4.....	133.4	3 3/4.....	95.3	RS4621
16 7/8.....	428.6	8 13/16.....	223.8	5 5/32.....	131.0	RS5546	17 29/32.....	454.8	10 3/8.....	263.5	5 11/32.....	135.7	PA2784
16 7/8.....	428.6	9 7/32.....	234.2	5 5/16.....	134.9	PA5496	17 15/16.....	455.6	11.....	279.4	5 3/8.....	136.5	PA3808-FN
16 15/16.....	430.2	5 1/16.....	128.6	3 13/16.....	96.8	PA4611	17 15/16.....	455.6	12 19/32.....	319.9	7 27/32.....	199.2	PA30170
16 15/16.....	430.2	10 9/16.....	268.3	5 1/16.....	128.6	PA30171	18.....	457.2	10.....	254.0	5 1/32.....	127.8	RS5506
16 15/16.....	430.2	11.....	279.4	7 11/16.....	195.3	RS30192	18.....	457.2	12 3/4.....	323.9	8 11/32.....	211.9	PA2437
17.....	431.8	9 3/32.....	231.0	5 7/32.....	132.6	PA2546	18 1/32.....	458.0	11 11/32.....	122.9	4 27/32.....	123.0	PA30193-FN
17.....	431.8	9 1/8.....	231.8	5 13/16.....	147.6	PA3469	18 1/32.....	458.0	7 23/32.....	307.2	7 23/32.....	196.1	PA5751
17.....	431.8	9 9/32.....	235.7	5 5/32.....	131.0	RS4676	18 3/32.....	459.6	12 3/32.....	307.2	8 1/8.....	206.4	PA2782
17.....	431.8	11 25/32.....	299.2	7 3/4.....	196.9	RS5707	18 1/8.....	460.4	11 1/8.....	282.6	6 3/16.....	157.2	PA1768
17.....	431.8	12 3/4.....	323.9	8 11/32.....	211.9	PA2571	18 1/8.....	460.4	11 15/16.....	303.2	6 19/32.....	167.5	RS30142
17.....	431.8	13 7/8.....	352.4	9 13/32.....	238.9	PA3573	18 1/8.....	460.4	13 13/16.....	350.8	9 1/2.....	241.3	PA1631-S
17 1/32.....	432.6	7.....	177.8	3 3/8.....	85.7	PA1825	18 1/8.....	460.4	14 3/8.....	365.1	6 19/32.....	167.5	RS30142 KIT
17 1/32.....	432.6	8 5/8.....	219.1	7 1/32.....	178.6	PA1905	18 5/32.....	461.2	7 7/8.....	200.0	7 5/8.....	193.7	PA5365
17 1/16.....	433.4	4 23/32.....	119.9	2.....	50.8	PA10114	18 5/32.....	461.2	11 7/8.....	301.6	10 1/4.....	260.4	PA2508
17 1/8.....	435.0	5 29/32.....	150.0	4 7/16.....	112.7	RS30092	18 3/16.....	462.0	10 31/32.....	278.6	5 13/16.....	147.6	RS30091
17 1/8.....	435.0	8 1/4.....	209.6	7 1/8.....	181.0	PA2957	18 7/32.....	462.8	5 1/4.....	133.4	4 15/16.....	125.4	RS3717
17 5/32.....	435.8	12 3/32.....	307.2	7 23/32.....	196.1	PA3794	18 7/32.....	462.8	12 7/32.....	310.3	8 1/32.....	204.0	RS5356
17 3/16.....	436.6	6 19/32.....	167.5	3 21/32.....	92.9	PA2542	18 1/4.....	463.6	7 1/8.....	181.0	5 13/16.....	147.6	PA2397
17 3/16.....	436.6	7 5/16.....	185.7	6 5/16.....	160.3	RS5541	18 5/16.....	465.1	5 29/32.....	150.0	4 7/16.....	112.7	RS30217
17 3/16.....	436.6	8 1/8.....	206.4	4.....	101.6	PA3555	18 5/16.....	465.1	6.....	152.4	3 5/8.....	92.1	PA1610
17 3/16.....	436.6	9 7/8.....	250.8	5 5/16.....	134.9	RS5397	18 5/16.....	465.1	6 1/8.....	155.6	4 15/16.....	125.4	PA2388
17 1/4.....	438.2	5 1/2.....	139.7	3 1/8.....	79.4	PA1692	18 5/16.....	465.1	9 1/8.....	231.8	5 29/32.....	150.0	RS30062
17 1/4.....	438.2	10 7/16.....	265.1	5 5/8.....	142.9	RS30130	18 5/16.....	465.1	9 15/32.....	240.5	5 15/32.....	138.9	RS5440
17 9/32.....	438.9	12 31/32.....	329.4	6 13/16.....	173.0	RS3749	18 5/16.....	465.1	7 1/32.....	309.6	7 1/32.....	178.6	RS4963
17 5/16.....	439.7	6 5/8.....	168.3	5.....	127.0	RS5408	18 5/16.....	465.1	19 9/32.....	489.7	12 7/8.....	327.0	PA3932
17 5/16.....	439.7	10.....	254.0	5 1/2.....	139.7	PA2442	18 11/32.....	465.9	12 9/32.....	311.9	6 31/32.....	177.0	RS3727
17 3/8.....	441.3	7 5/8.....	193.7	6 1/16.....	154.0	PA2410	18 11/32.....	465.9	12 9/32.....	311.9	6 31/32.....	177.0	RS5390
17 3/8.....	441.3	9 11/16.....	230.2	5 3/8.....	136.5	PA2567	18 11/32.....	465.9	12 7/8.....	327.0	8 1/2.....	215.9	PA5364
17 13/32.....	442.1	7 7/8.....	200.0	4 9/16.....	115.9	RS4859	18 11/32.....	465.9	14 7/32.....	361.2	8 15/16.....	227.0	RS3700
17 7/16.....	442.9	5 5/16.....	134.9	3 11/16.....	93.7	RS30162	18 11/32.....	465.9	14 7/32.....	361.2	8 15/16.....	227.0	RS3700XP
17 7/16.....	442.9	7 15/32.....	189.7	6 7/32.....	158.0	PA5589	18 3/8.....	466.7	5 15/16.....	150.8	4 27/32.....	123.0	PA2462



WARNING: These products can expose you to chemicals, including Diisononyl Phthalate, Carbon black extracts, Nickel, 1,3 Butadiene, Ethylene Oxide, Epichlorohydrin, which are known to the State of California to cause cancer, and Bisphenol-A, Ethylene Glycol, Ethylene Oxide, 1,3 Butadiene, Epichlorohydrin, which are known to the State of California to cause birth defects or other reproductive harm. For more information go to www.P65Warnings.ca.gov.

ROUND AIR FILTERS BY LENGTH

LENGTH Inches	LENGTH (mm)	O.D. Inches	O.D. (mm)	I.D. Inches	I.D. (mm)	BALDWIN NUMBER	LENGTH Inches	LENGTH (mm)	O.D. Inches	O.D. (mm)	I.D. Inches	I.D. (mm)	BALDWIN NUMBER
18 3/8	466.7	7 5/8	193.7	6 1/16	154.0	PA2519	18 7/8	479.4	11 7/8	301.6	7 17/32	191.3	PA5687
18 3/8	466.7	7 5/8	193.7	6 1/16	154.0	PA2708	18 7/8	479.4	12 29/32	327.8	7 17/32	191.3	PA3765
18 3/8	466.7	9 7/32	234.2	4 27/32	123.0	PA1824	18 29/32	480.2	9 29/32	251.6	6 3/16	157.2	RS5432
18 3/8	466.7	9 7/32	234.2	5 27/32	148.4	PA2466	18 15/16	481.0	9 9/32	235.7	5 5/32	131.0	RS3517
18 3/8	466.7	10 3/8	263.5	6 1/32	153.2	PA2509	18 15/16	481.0	9 9/32	235.7	5 5/32	131.0	RS3517XP
18 3/8	466.7	10 31/32	278.6	5 17/32	140.5	RS5675							
18 3/8	466.7	11	279.4	6 1/32	153.2	PA2591	19	482.6	5 11/16	144.5	5 5/32	131.0	RS30224
18 13/32	467.5	7 1/16	179.4	5 3/4	146.1	RS30136	19	482.6	6 1/8	155.6	5 7/32	132.6	PA5499
18 13/32	467.5	15 25/32	400.8	9 1/2	241.3	PA2956-FN	19	482.6	6 3/8	161.9	5 7/16	138.1	PA3896
18 13/32	467.5	16 1/8	409.6	7 7/16	188.9	PA2595	19	482.6	12 1/2	317.5	9 1/8	231.8	LL2609
18 7/16	468.3	6 1/8	155.6	5 1/8	130.2	RS5549	19	482.6	12 1/2	317.5	9 1/8	231.8	PA2609
18 7/16	468.3	12 3/32	307.2	7 11/16	195.3	PA5487	19 1/32	483.4	12 13/32	315.1	8 3/16	208.0	RS3514
18 1/2	469.9	6 7/16	174.6	6 7/16	163.5	RS4549	19 1/32	483.4	12 13/32	315.1	8 3/16	208.0	RS3514XP
18 1/2	469.9	7 1/4	184.2	6 3/16	157.2	PA3668	19 1/16	484.2	6 7/8	174.6	5 13/32	137.3	PA2655
18 1/2	469.9	7 5/8	193.7	6 3/16	157.2	PA3893	19 1/16	484.2	7 5/32	181.8	5 1/2	139.7	RS5462
18 1/2	469.9	7 7/8	200.0	4 3/4	120.7	RS4672	19 3/32	485.0	9 3/32	231.0	6 29/32	175.4	RS4580
18 1/2	469.9	8 1/4	209.6	4 23/32	119.9	PA2750	19 3/32	485.0	11 29/32	302.4	6 5/8	168.3	RS3714
18 1/2	469.9	8 9/32	210.3	7 3/32	180.2	PA5562	19 1/8	485.8	6 7/8	174.6	5 13/32	137.3	PA4574
18 1/2	469.9	8 17/32	216.7	7 11/16	195.3	RS4643	19 1/8	485.8	11 31/32	304.0	7 3/8	187.3	RS5332
18 1/2	469.9	8 5/8	219.1	7 1/16	179.4	PA2574	19 5/32	486.6	7 1/16	179.4	6 15/32	164.3	RS5673
18 1/2	469.9	9 1/8	231.8	5 13/16	147.6	LL2688	19 5/32	486.6	8 15/32	215.1	6 5/32	156.4	PA3861
18 1/2	469.9	9 1/8	231.8	5 13/16	147.6	PA2688	19 5/32	486.6	9 11/16	246.1	4 19/32	116.7	RS30180
18 1/2	469.9	9 7/32	234.2	4 27/32	123.0	PA3600	19 1/4	489.0	11 9/16	293.7	9	228.6	RS5744
18 1/2	469.9	9 3/4	247.7	5 13/16	147.6	PA2620	19 9/32	489.7	9 3/8	238.1	8 1/16	204.8	PA5574
18 1/2	469.9	10 27/32	275.4	6 1/2	165.1	PA2852	19 9/32	489.7	15 1/32	381.8	10 9/16	268.3	PA5552
18 1/2	469.9	11 1/8	282.6	6 23/32	170.7	PA1823	19 5/16	490.5	4 15/16	122.2	3 5/8	92.1	PA3631
18 1/2	469.9	12 1/32	305.6	7 11/16	195.3	PA2409	19 3/8	492.1	11	279.4	5 13/16	147.6	RS3730
18 1/2	469.9	12 1/16	306.4	7 11/16	195.3	PA3688	19 3/8	492.1	12 1/4	311.2	5 5/32	131.0	PA3477
18 1/2	469.9	12 3/32	307.2	6 25/32	172.2	RS30057	19 3/8	492.1	14 7/32	361.2	8 15/16	227.0	RS4579
18 1/2	469.9	12 3/32	307.2	7 11/16	195.3	LL2525	19 13/32	492.9	7 1/2	190.5	4 1/8	104.8	RS30237
18 1/2	469.9	12 3/32	307.2	7 11/16	195.3	PA2525	19 13/32	492.9	9 21/32	245.3	5 17/32	140.5	RS30223
18 1/2	469.9	12 3/32	307.2	7 11/16	195.3	PA2952	19 13/32	492.9	11 3/32	281.8	7 7/16	188.9	RS5540
18 1/2	469.9	12 1/8	308.0	7 11/16	195.3	LL1846	19 13/32	492.9	12 7/8	327.0	8 11/32	211.9	PA5445
18 1/2	469.9	12 1/8	308.0	7 11/16	195.3	PA1846	19 7/16	493.7	5 5/32	131.0	4 1/32	102.4	PA4983
18 1/2	469.9	12 1/8	308.0	7 11/16	195.3	PA1846XP	19 7/16	493.7	5 1/4	133.4	4 1/8	104.8	PA2378
18 1/2	469.9	13 13/16	350.8	9 1/2	241.3	LL1894	19 7/16	493.7	10 27/32	275.4	6 17/32	165.9	PA30109
18 1/2	469.9	13 13/16	350.8	9 1/2	241.3	PA1894	19 1/2	495.3	6 3/8	161.9	5 9/32	134.1	PA2583
18 1/2	469.9	13 13/16	350.8	9 1/2	241.3	PA1894XP	19 1/2	495.3	7 3/8	187.3	6 1/8	155.6	PA2491
18 1/2	469.9	13 7/8	352.4	7 7/16	188.9	PA2468	19 1/2	495.3	9 1/2	241.3	4 7/8	123.8	RS5391
18 1/2	469.9	13 7/8	352.4	7 7/16	188.9	LL2618	19 1/2	495.3	9 17/32	242.1	5 5/32	131.0	PA3572
18 1/2	469.9	13 7/8	352.4	7 7/16	188.9	PA2618	19 1/2	495.3	9 27/32	250.0	6 1/4	158.8	PA2751
18 1/2	469.9	14 1/2	368.3	9 1/2	241.3	PA2749	19 1/2	495.3	11 17/32	292.9	6 17/32	165.9	PA3499
18 1/2	469.9	14 13/16	376.2	7 11/16	195.3	PA2478	19 1/2	495.3	12 1/32	305.6	7 11/16	195.3	PA2640
18 1/2	469.9	15 25/32	400.8	9 1/2	241.3	PA2663-FN	19 1/2	495.3	12 3/32	307.2	7 11/16	195.3	PA3916
18 1/2	469.9	16 1/4	412.8	9 1/2	241.3	PA4571	19 1/2	495.3	12 1/8	308.0	7 11/16	195.3	LL2676
18 17/32	470.7	11 27/32	300.8	6 9/16	166.7	RS5484	19 1/2	495.3	12 1/8	308.0	7 11/16	195.3	PA2676
18 9/16	471.5	6 3/8	161.9	5 19/32	142.1	PA3494	19 1/2	495.3	12 1/8	308.0	7 11/16	195.3	PA2676XP
18 9/16	471.5	15 3/4	400.1	7 11/16	195.3	PA1847-FN	19 1/2	495.3	13	330.2	9 1/8	231.8	RS4642
18 9/16	471.5	16 5/32	410.4	7 7/16	188.9	LL2333	19 1/2	495.3	13 23/32	348.5	9 1/4	235.0	PA3497
18 9/16	471.5	16 5/32	410.4	9 1/2	241.3	PA2333	19 1/2	495.3	16 5/32	410.4	7 7/16	188.9	LL2393
18 19/32	472.3	9 9/32	235.7	5 5/32	131.0	RS4620	19 1/2	495.3	16 5/32	410.4	7 7/16	188.9	PA2393
18 19/32	472.3	11 13/16	300.0	7 7/8	200.0	PA5588	19 17/32	496.1	8 1/32	204.0	5 3/16	131.8	RS5430
18 5/8	473.1	5 9/16	141.3	4 11/16	119.1	PA2814	19 17/32	496.1	16 1/8	409.6	8 11/32	211.9	PA2629
18 5/8	473.1	12 31/32	329.4	6 13/16	173.0	RS3530	19 17/32	496.1	18 5/16	465.1	12 1/8	308.0	LL2507
18 5/8	473.1	12 31/32	329.4	6 13/16	173.0	RS3530XP	19 17/32	496.1	18 5/16	465.1	12 1/8	308.0	PA2507
18 21/32	473.9	11 15/16	303.2	7 17/32	191.3	PA2776	19 9/16	496.9	9 17/32	242.1	5 5/32	131.0	PA2475
18 21/32	473.9	11 15/16	303.2	7 17/32	191.3	PA30235	19 9/16	496.9	9 17/32	242.1	5 1/4	133.4	PA5524
18 21/32	473.9	14 1/4	362.0	9 29/32	251.6	PA2781	19 19/32	497.7	5 29/32	150.0	4 13/32	111.9	RS3745
18 23/32	475.5	10 17/32	267.5	6 19/32	167.5	RS5534	19 5/8	498.5	9 1/16	230.2	5 3/8	136.5	PA2529
18 23/32	475.5	12 1/16	306.4	7 11/16	195.3	PA3780	19 5/8	498.6	11 11/16	297.2	7 27/32	198.9	RS30307
18 3/4	476.3	11 13/16	300.0	7 7/8	200.0	PA5274	19 7/16	498.7	14	355.6	9	228.6	RS30128
18 3/4	476.3	12 7/8	327.0	8 1/2	215.9	PA3754	19 21/32	499.3	5 15/16	150.8	4 9/32	108.7	RS30160
18 3/4	476.3	15 1/32	381.8	9 9/16	242.9	PA2801	19 21/32	499.3	7 5/32	181.8	5 27/32	148.4	RS5510
18 7/8	479.4	9 31/32	253.2	5 23/32	145.3	RS30161	19 21/32	499.3	9 27/32	250.0	7 13/32	188.1	RS5461
18 7/8	479.4	10 1/2	266.7	6 11/16	169.9	RS4959	19 11/16	500.1	10 29/32	277.0	7	228.6	PA30040
18 7/8	479.4	10 31/32	278.6	5 13/16	147.6	RS3888	19 11/16	500.1	11 3/8	288.9	6 3/8	161.9	RS5756



WARNING: These products can expose you to chemicals, including Diisononyl Phthalate, Carbon black extracts, Nickel, 1,3 Butadiene, Ethylene Oxide, Epichlorohydrin, which are known to the State of California to cause cancer, and Bisphenol-A, Ethylene Glycol, Ethylene Oxide, 1,3 Butadiene, Epichlorohydrin, which are known to the State of California to cause birth defects or other reproductive harm. For more information go to www.P65Warnings.ca.gov.

ROUND AIR FILTERS BY LENGTH

LENGTH Inches	LENGTH (mm)	O.D. Inches	O.D. (mm)	I.D. Inches	I.D. (mm)	BALDWIN NUMBER	LENGTH Inches	LENGTH (mm)	O.D. Inches	O.D. (mm)	I.D. Inches	I.D. (mm)	BALDWIN NUMBER
19 23/32	500.9	6 7/8	174.6	5 5/32	131.0	RS5313	20 23/32	526.3	11 29/32	302.4	6 5/8	168.3	RS3726
19 23/32	500.9	7 13/16	198.4	4 27/32	123.0	RS5767	20 3/4	527.1	11 1/2	292.1	7 1/4	184.2	PA4573
19 3/4	501.7	9 3/4	247.7	5 31/32	151.6	PA30037	20 13/16	528.6	10 17/32	267.5	6 19/32	167.5	RS5358
19 13/16	503.2	9 13/16	249.2	5 3/8	136.5	PA4984-FN	20 13/16	528.6	10 17/32	267.5	6 19/32	167.5	RS5508
19 13/16	503.2	10 3/8	263.5	6 1/32	153.2	PA2441	20 7/8	530.2	7 3/8	187.3	6 1/8	155.6	PA2615
19 13/16	503.2	13 1/2	342.9	6 15/16	6.9	PA30043	20 7/8	530.2	8 1/8	206.4	4 3/16	106.4	RS4794
19 7/8	504.8	9 3/32	231.0	4 13/16	122.2	PA2367	20 7/8	530.2	10	254.0	5 1/2	139.7	PA2377
19 29/32	505.6	10 31/32	278.6	5 13/16	147.6	RS3952	20 15/16	531.8	10 3/8	263.5	6 1/32	153.2	PA2430
19 15/16	506.4	4 1/4	108.0	3 7/16	87.3	RS5448	20 31/32	532.6	8 1/8	206.4	6 7/8	174.6	RS30009
19 31/32	507.2	7 1/16	179.4	5 11/16	144.5	RS3871	20 31/32	532.6	8 5/16	211.1	6 1/32	153.2	RS3721
19 31/32	507.2	7 1/16	179.4	5 11/16	144.5	RS4639							
19 31/32	507.2	12 1/32	305.6	7 11/16	195.3	PA2376							
20	508.0	7 1/2	190.5	5 1/4	133.4	PA2346	21	533.4	7 5/8	193.7	6 1/16	154.0	PA30146
20	508.0	10 11/16	271.5	6 11/16	169.9	RS4971	21	533.4	8 5/8	219.1	7 1/16	179.4	PA2672
20	508.0	11 25/32	299.2	7 3/4	196.9	RS5672	21	533.4	12	304.8	7 11/16	195.3	PA3559
20	508.0	12 3/4	323.9	8 3/8	212.7	PA5561	21	533.4	12 3/4	323.9	8 11/32	211.9	PA2398
20	508.0	13 7/8	352.4	7 7/16	188.9	PA2515	21 1/32	534.2	8 5/8	219.1	7 1/16	179.4	PA1976
20 1/32	508.8	10 31/32	278.6	5 13/16	147.6	RS5413	21 1/16	535.0	5 29/32	150.0	4 13/32	111.9	RS3719
20 1/16	509.5	7 3/32	179.8	6 3/8	161.8	RS30306	21 1/16	535.0	12 1/16	306.4	6 3/32	154.8	PA1952
20 1/8	511.2	9 5/8	244.5	5	127.0	PA3556	21 1/16	535.0	12 1/16	306.4	6 3/32	154.8	PA1953
20 5/32	512.0	13 19/32	345.3	5 25/32	146.8	RS5754	21 3/32	535.7	7 1/16	179.3	5 11/16	144.8	RS30328
20 3/16	512.8	11	279.4	6 1/2	165.1	PA5498	21 1/8	536.6	6 7/8	174.6	5 11/16	144.5	RS3729
20 3/16	512.8	12 29/32	327.8	8 5/8	219.1	PA3876	21 5/32	537.4	9 1/2	241.3	5 3/4	146.1	RS3996
20 1/4	514.4	7	177.8	4 13/32	111.9	PA1754	21 7/32	539.0	5 1/4	133.4	3 5/8	92.1	RS3975
20 1/4	514.4	7 15/16	201.6	3 9/16	90.5	PA3562	21 9/32	539.8	11 29/32	302.4	6 5/8	168.3	RS30143
20 11/32	516.7	9 3/32	231.0	6 29/32	175.4	RS4617	21 1/4	539.8	12 1/2	317.5	7 1/2	190.5	PA2490
20 3/8	517.5	7 5/8	193.7	6 1/16	154.0	PA2714	21 9/32	539.8	15 1/8	384.2	6 5/8	168.3	RS30143 KIT
20 3/8	517.5	7 15/16	201.6	6 11/16	154.0	PA2714	21 11/32	542.1	11 3/8	288.9	6 13/16	173.0	RS4564
20 3/8	517.5	10 3/8	263.5	6 1/2	165.1	PA2659	21 3/8	542.9	10 3/16	258.8	6 5/16	160.3	PA2786
20 3/8	517.5	12	304.8	4 5/8	117.5	PA2659	21 13/32	543.7	11 3/8	288.9	5 13/16	147.6	RS4618
20 3/8	517.5	12 3/16	309.6	6 1/32	153.2	PA2461	21 15/32	545.3	6 7/8	174.6	5 5/32	131.0	RS3927
20 3/8	517.5	12 3/16	309.6	6 7/8	174.6	PA2386	21 15/32	545.3	7 5/8	193.7	6 1/16	154.0	PA2362
20 3/8	517.5	12 3/16	309.6	7 1/4	184.2	RS30159	21 1/2	546.1	8 1/8	206.4	4 27/32	123.0	PA3898
20 3/8	517.5	12 13/16	325.4	7 11/16	195.3	LL2518	21 1/2	546.1	12 1/32	305.6	7 11/16	195.3	PA2713
20 3/8	517.5	12 13/16	325.4	7 11/16	195.3	PA2518	21 1/2	546.1	16 1/8	409.6	7 7/16	188.9	PA2394
20 3/8	517.5	14	355.6	7 11/16	195.3	PA2518XP	21 17/32	546.9	10 15/16	277.8	6 9/32	159.5	PA2982
20 13/32	518.3	5 3/4	146.1	7 11/16	195.3	PA2396	21 17/32	546.9	16 5/32	410.4	9 1/2	241.3	PA2734
20 7/16	519.1	10 1/4	260.4	3 7/16	87.3	PA3899	21 9/16	547.7	7 1/8	181.0	5 1/2	139.7	PA2964
20 7/16	519.1	11 1/2	292.1	8	203.2	RS5429	21 19/32	548.5	6 7/8	174.6	5 7/16	138.1	PA2915
20 15/32	519.9	10 27/32	275.4	6 3/16	157.2	PA2387	21 5/8	549.3	10 31/32	278.6	5 27/32	148.4	RS3718
20 15/32	519.9	11 3/32	281.8	6 1/2	165.1	PA3938	21 5/8	549.3	12 13/32	315.1	8 3/16	208.0	RS3720
20 1/2	520.7	6 1/8	155.6	8	203.2	RS4993	21 11/16	550.9	13 3/32	332.6	7 3/8	187.3	RS4572
20 1/2	520.7	7 3/16	182.6	4 15/16	125.4	PA2787	21 11/16	550.9	13 3/32	332.6	7 3/8	187.3	RS4613
20 1/2	520.7	8 3/4	222.3	4 13/16	122.2	RS30134	21 25/32	553.2	12 3/32	307.2	7 11/16	195.3	PA30145
20 1/2	520.7	10 13/32	264.3	4 3/16	106.4	PA3630-FN	21 13/16	554.0	8 13/32	213.5	6 3/16	157.2	PA3889
20 1/2	520.7	10 27/32	275.4	6 15/16	176.2	PA2851	21 7/8	555.6	9 9/32	235.7	5 5/32	131.0	RS3974
20 1/2	520.7	10 27/32	275.4	6 1/2	165.1	LL2582	21 7/8	555.6	12 3/16	309.6	6 31/32	177.0	RS30116
20 1/2	520.7	10 27/32	275.4	6 1/2	165.1	PA2582	21 7/8	555.6	12 9/32	311.9	6 31/32	177.0	RS3728
20 1/2	520.7	11 1/8	282.6	6 3/4	171.5	PA2345	21 15/16	557.2	7 3/32	180.2	2 15/32	62.7	RS5593XP
20 1/2	520.7	11 1/2	292.1	7 1/4	184.2	PA2654							
20 1/2	520.7	12 1/8	308.0	7 23/32	196.1	PA2840	22 3/32	561.2	5 29/32	150.0	4 13/32	111.9	RS30181
20 1/2	520.7	12 15/32	316.7	7 7/8	200.0	PA3892	22 3/32	561.2	7 1/16	179.4	5 11/16	144.5	RS3827
20 1/2	520.7	13 13/16	350.8	9 1/2	241.3	PA2573	22 3/32	561.2	9 3/32	231.0	6 7/8	174.6	RS5460
20 1/2	520.7	13 13/16	350.8	9 1/2	241.3	PA2573XP	22 5/32	562.8	11 3/32	281.8	7 7/16	188.9	RS30175
20 1/2	520.7	14 7/32	361.2	8 15/16	227.0	RS4616	22 3/16	563.6	10 13/32	264.3	5 27/32	148.4	RS4563
20 17/32	521.5	11 11/16	296.9	6 11/16	169.9	PA2704	22 3/16	563.6	10 29/32	277.0	8 5/32	207.2	PA2364
20 17/32	521.5	12 9/32	311.9	6 31/32	177.0	RS3870	22 3/16	563.6	11 11/16	297.2	7 27/32	198.9	RS30305
20 9/16	522.0	12 9/32	311.9	6 15/16	176.5	RS3870XP	22 3/16	563.6	12 23/32	323.1	9 9/32	235.7	PA5465
20 9/16	522.3	5 17/32	140.5	4 25/32	121.4	RS3997	22 1/4	565.2	12 1/2	317.5	7 1/2	190.5	PA2614
20 9/16	522.3	10 31/32	278.6	5 13/16	147.6	RS3744	22 9/32	565.9	12 31/32	329.4	6 13/16	173.0	RS3926
20 9/16	522.3	10 31/32	278.6	5 13/16	147.6	RS3744XP	22 3/8	568.3	8 1/4	209.6	7 3/32	180.2	PA2457
20 9/16	522.3	12 3/32	307.2	7 11/16	195.3	RS5509	22 7/16	569.9	14 7/32	361.2	8 15/16	227.0	RS5459
20 9/16	522.3	12 9/32	311.9	6 31/32	177.0	RS4638	22 7/16	569.9	15 1/32	381.8	10 9/16	268.3	PA5573
20 5/8	523.9	8 5/32	207.2	4 3/16	106.4	RS5447	22 15/32	570.7	11 11/16	296.9	6 23/32	170.7	PA2705
20 5/8	523.9	12 1/8	308.0	7	177.8	RS30135	22 15/32	570.7	11 11/16	296.9	6 23/32	170.7	PA4585
20 5/8	523.9	12 3/8	314.3	7 11/16	195.3	RS30133	22 1/2	571.5	7 1/16	179.4	6 13/32	162.7	RS5471
20 11/16	525.5	11	279.4	5 25/32	146.8	RS30216	22 1/2	571.5	7 15/16	201.6	3 9/16	90.5	PA3581



WARNING: These products can expose you to chemicals, including Diisononyl Phthalate, Carbon black extracts, Nickel, 1,3 Butadiene, Ethylene Oxide, Epichlorohydrin, which are known to the State of California to cause cancer, and Bisphenol-A, Ethylene Glycol, Ethylene Oxide, 1,3 Butadiene, Epichlorohydrin, which are known to the State of California to cause birth defects or other reproductive harm. For more information go to www.P65Warnings.ca.gov.

ROUND AIR FILTERS BY LENGTH

LENGTH Inches	LENGTH (mm)	O.D. Inches	O.D. (mm)	I.D. Inches	I.D. (mm)	BALDWIN NUMBER	LENGTH Inches	LENGTH (mm)	O.D. Inches	O.D. (mm)	I.D. Inches	I.D. (mm)	BALDWIN NUMBER
22 1/2	571.5	10 1/4	260.4	9 1/8	231.8	PA2563	23 31/32	608.8	8 5/16	211.1	7 11/32	186.5	PA3787
22 1/2	571.5	10 13/32	264.3	6 15/16	176.2	PA2715	24	609.6	13 7/8	352.4	7 7/16	188.9	LL2559
22 1/2	571.5	11 7/8	301.6	10 1/4	260.4	PA2454	24	609.6	13 7/8	352.4	7 7/16	188.9	PA2559
22 1/2	571.5	12 3/32	307.2	7 11/16	195.3	PA3887	24 1/32	610.4	12 25/32	324.6	8 3/8	212.7	LL2456
22 1/2	571.5	12 1/2	317.5	7 1/2	190.5	PA3464	24 1/32	610.4	12 25/32	324.6	8 3/8	212.7	PA2456
22 1/2	571.5	12 3/4	323.9	8 11/32	211.9	PA2698	24 1/32	610.4	12 25/32	324.6	8 3/8	212.7	PA2456XP
22 1/2	571.5	12 3/4	323.9	8 11/32	211.9	PA3579	24 1/8	612.8	7 15/16	201.6	4 5/8	117.5	PA2649
22 1/2	571.5	13 13/16	350.8	9 1/2	241.3	PA1975	24 1/4	616.0	12 29/32	327.8	8 1/2	215.9	PA3606
22 1/2	571.5	13 13/16	350.8	9 1/2	241.3	PA3588	24 3/8	619.1	11 9/16	293.7	9	228.6	RS5294
22 1/2	571.5	13 7/8	352.4	9 1/2	241.3	PA5699	24 1/2	622.3	9 1/4	235.0	6 3/4	171.5	PA3691
22 1/2	571.5	14 1/2	368.3	9 1/2	241.3	PA2675	24 1/2	622.3	12 1/8	308.0	7 11/16	195.3	PA2902
22 17/32	572.3	16 5/32	410.4	7 7/16	188.9	PA2679	24 1/2	622.3	13 11/32	338.9	8 11/32	211.9	PA4566
22 9/16	573.1	6 7/8	174.6	5 7/16	138.1	RS5415	24 1/2	622.3	14 1/4	362.0	9 15/16	252.4	PA5480
22 19/32	573.9	7 15/16	201.6	4 5/8	117.5	PA3946	24 1/2	622.3	14 11/16	373.1	10 11/32	262.7	LL2562
22 19/32	573.9	9	228.6	5 11/16	144.5	PA2531	24 1/2	622.3	14 11/16	373.1	10 11/32	262.7	PA2562
22 5/8	574.7	7 29/32	200.8	7 9/16	192.1	RS3999	24 1/2	622.3	14 11/16	373.1	10 11/32	262.7	PA2562XP
22 5/8	574.7	12 3/4	323.8	8 5/16	211.1	PA2989	24 1/2	622.3	15 3/8	390.5	10 11/32	262.7	PA2849
22 11/16	576.3	10 5/8	269.9	6 1/4	158.8	PA2757	24 1/2	622.3	15 25/32	400.8	10	254.0	PA3496
22 13/16	579.4	10 3/8	263.5	6 1/32	153.2	LL2312	24 5/8	625.5	9 3/32	231.0	7	177.8	RS4629
22 13/16	579.4	10 3/8	263.5	6 1/32	153.2	PA2312	24 5/8	625.5	11 11/16	296.9	7 27/32	199.2	RS5470
22 13/16	579.4	10 5/8	269.9	7 1/4	184.2	PA2963	24 5/8	625.5	12 23/32	323.1	7 13/16	198.4	RS5472
22 27/32	580.2	6 25/32	172.2	5 3/8	136.5	PA3865	24 3/4	628.7	10 7/8	276.2	6 23/32	170.7	PA3644
22 27/32	580.2	10 5/8	269.9	7 1/4	184.2	PA2914	24 3/4	628.7	22	558.8	15 9/16	395.3	PA3633
22 29/32	581.8	10 31/32	278.6	5 13/16	147.6	RS30232	24 13/16	630.2	13 3/32	332.6	7 5/8	193.7	RS5287XP
22 29/32	581.8	11 1/32	280.2	5 13/16	147.6	RS30182	24 13/16	630.2	13 3/32	332.6	7 5/8	193.7	RS30187XP
22 29/32	581.8	11 13/32	289.7	7 5/8	193.7	RS5288XP	24 13/16	630.2	13 1/8	333.0	7 5/8	193.8	RS5287
22 29/32	581.8	12 9/32	311.9	6 31/32	177.0	RS3764	24 27/32	631.0	9 21/32	245.3	5 5/32	131.0	RS4646
22 29/32	581.8	12 9/32	311.9	6 31/32	177.0	RS3826	24 7/8	631.8	14 7/32	361.2	8 15/16	227.0	RS4989
22 15/16	582.4	11 13/32	289.6	7 5/8	193.5	RS5288	24 7/8	631.8	17 23/32	450.1	11 7/16	290.5	RS5743
22 15/16	582.4	12 3/32	306.8	7	177.5	RS30327	24 7/8	631.8	17 23/32	450.1	11 7/16	290.5	RS5743XP
22 31/32	583.4	8 23/32	221.5	7 1/32	178.6	RS30088	25	635.0	11 7/8	301.6	7 3/8	187.3	PA2729
23	584.2	8 21/32	219.9	5 3/16	131.8	PA2623	25	635.0	12 3/4	323.9	8 11/32	211.9	PA2631
23	584.2	8 27/32	224.6	5 15/32	138.9	LL2482	25	635.0	14	355.6	9	228.6	RS30087
23	584.2	8 27/32	224.6	5 15/32	138.9	PA2482	25	635.0	16 5/8	422.3	12	304.8	PA3584
23	584.2	10 13/32	264.3	6 15/16	176.2	PA2703	25 9/32	642.1	9 11/32	237.3	8 1/8	206.4	PA3810
23	584.2	12 3/4	323.9	8 11/32	211.9	LL2317	25 1/2	647.7	9 9/32	235.7	5 25/32	146.8	RS4634
23	584.2	12 3/4	323.9	8 11/32	211.9	PA2317	25 1/2	647.7	9 9/32	235.7	5 25/32	146.8	RS4634XP
23 7/32	589.8	11 13/16	300.0	6 5/16	160.3	PA3484	25 17/32	648.5	9 9/32	235.7	5 25/32	146.8	RS3936
23 1/4	590.6	8 1/8	206.4	4 11/16	119.1	PA2785	25 19/32	650.1	11 1/2	292.1	7	177.8	PA3800
23 9/32	591.3	12 31/32	329.4	6 13/16	173.0	RS5414	25 19/32	650.1	13 1/2	342.9	6 25/32	6.8	PA30039
23 5/16	592.1	11 23/32	297.7	8 1/32	204.0	RS3998	25 11/16	652.3	11 1/32	279.9	7 3/32	179.8	PA30315
23 5/16	592.1	11 23/32	297.7	8 1/32	204.0	RS3998XP	25 23/32	653.3	10 31/32	278.6	7	177.8	PA5674
23 7/16	595.3	9 9/32	235.7	5 25/32	146.8	RS3516	25 3/4	654.1	7 3/8	187.3	6 1/8	155.6	PA2745
23 15/32	595.9	9 5/16	236.5	5 3/4	146.1	RS3516XP	25 13/16	655.6	13 3/32	332.6	7 3/8	187.3	RS3534
23 1/2	596.9	7 1/4	184.2	6 3/16	157.2	PA2903	25 7/8	657.2	7 3/8	187.3	6 1/8	155.6	PA1937
23 1/2	596.9	7 11/32	186.5	5 5/16	134.9	PA2726	25 29/32	658.1	13 1/2	343.2	8 1/16	204.7	PA30316
23 1/2	596.9	9 29/32	251.6	8 1/16	204.8	PA3498	26	660.4	13 7/8	352.4	7 7/16	188.9	PA2516
23 1/2	596.9	12 3/32	307.2	7 23/32	196.1	PA2962	26 1/32	661.2	14 13/16	376.2	9 19/32	243.7	PA5463
23 1/2	596.9	12 3/4	323.9	7 23/32	196.1	LL2361	26 7/32	666.0	13 9/32	337.3	7 5/32	181.8	PA3772
23 1/2	596.9	12 3/4	323.9	7 23/32	196.1	PA2361XP	26 13/32	670.8	9 3/32	231.1	7 1/8	180.6	RS30291
23 1/2	596.9	12 3/4	323.9	8 11/32	211.9	PA2580	26 1/2	673.1	10 3/8	263.5	6 1/16	154.0	PA3452
23 17/32	597.7	9 21/32	245.3	5 5/32	131.0	RS3743	26 1/2	673.1	11 7/8	301.6	7 1/8	181.0	PA2900
23 17/32	597.7	14 7/32	361.2	8	203.2	RS30008	26 1/2	673.1	12 3/4	323.9	8 11/32	211.9	PA2799
23 17/32	597.7	17 5/8	447.7	11 1/32	280.2	PA3637	26 1/2	673.1	12 3/4	323.9	8 11/32	211.9	PA2855
23 17/32	597.7	18 5/16	465.1	11	279.4	LL2363	26 1/2	673.1	12 3/4	323.9	8 11/32	211.9	PA2857
23 17/32	597.7	18 5/16	465.1	11	279.4	PA2363	26 1/2	673.1	12 3/4	323.9	8 11/32	211.9	PA2973
23 17/32	597.7	18 5/16	465.1	11	279.4	PA2363XP	26 1/2	673.1	12 3/4	323.9	8 11/32	211.9	PA3458
23 17/32	597.7	18 5/16	465.1	12 1/8	308.0	LL2453	26 1/2	673.1	12 25/32	324.6	8 11/32	211.9	PA3404
23 17/32	597.7	18 5/16	465.1	12 1/8	308.0	PA2453	26 1/2	673.1	12 25/32	324.6	8 11/32	211.9	PA3563
23 17/32	597.7	18 5/16	465.1	12 1/8	308.0	PA2453XP	26 1/2	673.1	13 13/16	350.8	9 1/2	241.3	PA3461
23 5/8	600.1	4 23/32	119.9	2 15/16	74.6	PA4876	26 1/2	673.1	13 13/16	350.8	9 1/2	241.3	PA3463
23 23/32	602.5	11 13/32	289.7	6 23/32	170.7	RS3539	26 1/2	673.1	13 13/16	350.8	9 1/2	241.3	PA3614
23 23/32	602.5	11 13/32	289.7	6 23/32	170.7	RS3539XP	26 5/8	676.3	13 7/8	352.4	8 7/16	214.3	PA3560
23 3/4	603.3	16 1/4	412.8	7 23/32	194.5	PA5323							



WARNING: These products can expose you to chemicals, including Diisononyl Phthalate, Carbon black extracts, Nickel, 1,3 Butadiene, Ethylene Oxide, Epichlorohydrin, which are known to the State of California to cause cancer, and Bisphenol-A, Ethylene Glycol, Ethylene Oxide, 1,3 Butadiene, Epichlorohydrin, which are known to the State of California to cause birth defects or other reproductive harm. For more information go to www.P65Warnings.ca.gov.

ROUND AIR FILTERS BY LENGTH

LENGTH Inches	LENGTH (mm)	O.D. Inches	O.D. (mm)	I.D. Inches	I.D. (mm)	BALDWIN NUMBER	LENGTH Inches	LENGTH (mm)	O.D. Inches	O.D. (mm)	I.D. Inches	I.D. (mm)	BALDWIN NUMBER
26 5/8.....	676.3	15 31/32.....	405.6	8 5/16.....	211.1	PA2988	28 1/2.....	723.9	9 1/2.....	241.3	6 1/2.....	165.1	PA2628
26 23/32.....	678.9	14 7/32.....	360.9	8 29/32.....	226.3	RS30290	28 1/2.....	723.9	9 11/16.....	246.1	5 3/16.....	131.8	PA2718
27.....	685.8	10 3/8.....	263.5	6 1/32.....	153.2	LL2493	28 1/2.....	723.9	10 13/32.....	264.3	6 15/16.....	176.2	PA2660
27.....	685.8	10 3/8.....	263.5	6 1/32.....	153.2	PA2493	28 1/2.....	723.9	13 13/16.....	350.8	9 1/2.....	241.3	PA3569
27.....	685.8	12 3/4.....	323.9	8 11/32.....	211.9	LL2608	29.....	736.6	8 11/16.....	220.7	2 3/16.....	55.6	PA2500
27.....	685.8	12 3/4.....	323.9	8 11/32.....	211.9	PA2608	29.....	736.6	8 27/32.....	224.6	5 13/16.....	147.6	LL2503
27.....	685.8	12 3/4.....	323.9	8 3/8.....	212.7	PA2357	29.....	736.6	8 27/32.....	224.6	5 13/16.....	147.6	PA2503
27.....	685.8	13 7/8.....	352.4	7 7/16.....	188.9	LL2458	29.....	736.6	10 13/32.....	264.3	6 15/16.....	176.2	PA2732
27.....	685.8	13 7/8.....	352.4	7 7/16.....	188.9	PA2458	29.....	736.6	10 13/32.....	264.3	6 15/16.....	176.2	PA3951
27 1/16.....	687.4	12 1/2.....	317.5	7 1/2.....	190.5	PA2744	29.....	736.6	12 3/4.....	323.9	8 11/32.....	211.9	PA2632
27 5/16.....	693.7	14 1/2.....	368.3	9 1/2.....	241.3	PA3806	29 1/2.....	749.3	13 7/8.....	352.4	10.....	254.0	PA2746
27 5/16.....	693.7	14 1/2.....	368.3	9 1/2.....	241.3	PA4606	29 3/4.....	755.7	12 3/4.....	323.9	8 3/8.....	212.7	PA2796
27 1/2.....	698.5	12 1/2.....	317.5	7 1/2.....	190.5	PA1936	30 1/32.....	762.8	17 23/32.....	450.1	11 7/16.....	290.5	RS5293
27 1/2.....	698.5	13 13/16.....	350.8	9 1/2.....	241.3	PA3587	30 1/32.....	762.8	17 23/32.....	450.1	11 7/16.....	290.5	RS5293XP
27 5/8.....	701.7	10.....	254.0	4 23/32.....	119.9	PA4887	32 1/2.....	825.5	7 15/16.....	201.6	3 9/16.....	90.5	PA3640
28 1/32.....	712.0	12 9/32.....	311.9	6 15/16.....	176.5	RS30311	34 5/8.....	879.5	12 3/4.....	323.9	8 5/16.....	211.1	PA3611
28 3/16.....	716.0	7 3/4.....	196.9	4.....	101.6	PA2771	34 5/8.....	879.5	12 3/4.....	323.9	8 3/8.....	212.7	PA3595
28 1/4.....	717.6	9 29/32.....	251.6	8 1/16.....	204.8	PA2747	36 1/2.....	927.1	12 25/32.....	324.6	8 11/32.....	211.9	PA3638
28 13/32.....	721.5	11 11/16.....	296.9	6 11/16.....	169.9	PA2680	36 5/8.....	930.3	12 3/4.....	323.9	8 3/8.....	212.7	PA3568
28 7/16.....	722.3	9 1/2.....	241.3	6 1/2.....	165.1	PA2658	36 5/8.....	930.3	13 7/8.....	352.4	8 3/8.....	212.7	PA3576
28 1/2.....	723.9	8 21/32.....	219.9	5 3/16.....	131.8	PA3478	28 1/2.....	723.9	8 27/32.....	224.6	5 13/16.....	147.6	PA2755
28 1/2.....	723.9	8 21/32.....	219.9	5 3/16.....	131.8	PA3478XP	28 1/2.....	723.9	9.....	228.6	5 11/16.....	144.5	PA2532
28 1/2.....	723.9	8 27/32.....	224.6	5 13/16.....	147.6	PA2755							
28 1/2.....	723.9	9.....	228.6	5 11/16.....	144.5	PA2532							

NOTES



WARNING: These products can expose you to chemicals, including Diisononyl Phthalate, Carbon black extracts, Nickel, 1,3 Butadiene, Ethylene Oxide, Epichlorohydrin, which are known to the State of California to cause cancer, and Bisphenol-A, Ethylene Glycol, Ethylene Oxide, 1,3 Butadiene, Epichlorohydrin, which are known to the State of California to cause birth defects or other reproductive harm. For more information go to www.P65Warnings.ca.gov.

PANEL AIR FILTERS

LENGTH x WIDTH x THICK Inches	LENGTH x WIDTH x THICK (mm)	BALDWIN NUMBER	LENGTH x WIDTH x THICK Inches	LENGTH x WIDTH x THICK (mm)	BALDWIN NUMBER
2 1/2 x 1 3/4 x 1 3/8	63.5 x 44.5 x 34.9	PA1600	7 23/32 x 5 1/8 x 1 9/16	196.1 x 130.2 x 39.7	PA30251
2 5/8 x 1 x 2 17/32	66.7 x 25.4 x 64.3	SA10359	7 23/32 x 6 1/4 x 2 5/16	196.1 x 158.8 x 58.7	PA4455
3 7/16 x 2 23/32 x 1 1/32	87.3 x 69.1 x 26.2	PA4905	7 23/32 x 7 15/32 x 2 5/16	196.1 x 189.7 x 58.7	PA4473
3 9/16 x 2 9/16 x 21/32	90.5 x 65.1 x 16.7	PA4855	7 3/4 x 6 5/16 x 2 3/4	196.9 x 160.3 x 69.9	PA10003
3 27/32 x 3 7/16 x 1 1/4	97.6 x 87.3 x 31.8	PA30053	7 3/4 x 7 13/32 x 1 15/16	196.9 x 188.1 x 49.2	PA4401
3 27/32 x 3 19/32 x 23/32	97.6 x 91.3 x 18.3	PA4094	7 3/4 x 5 7/8 x 1 13/32	197.1 x 149.1 x 36.1	PA10424
3 7/8 x 3 3/32 x 15/16	98.4 x 78.6 x 23.8	PA4735	7 25/32 x 3 5/8 x 1 13/16	197.6 x 92.1 x 46.0	PA4941
4 1/8 x 3 5/32 x 2 5/16	104.8 x 80.2 x 58.7	PA4854	7 25/32 x 5 9/16 x 2	197.6 x 141.3 x 50.8	PA10220
4 9/32 x 3 29/32 x 1 3/8	108.7 x 99.2 x 34.9	PA4734	7 25/32 x 7 19/32 x 13/32	197.6 x 192.9 x 10.5	PA30262
4 5/8 x 2 11/16 x 1 5/32	117.5 x 68.3 x 29.4	PA4853	7 13/16 x 6 13/16 x 1 15/32	198.4 x 173 x 37.3	PA10323
4 5/8 x 4 5/8 x 25/32	117.5 x 117.5 x 19.8	PA4885	7 13/16 x 6 13/16 x 2 3/32	198.4 x 173.0 x 53.1	PA10433
4 11/16 x 3 9/32 x 15/16	119.1 x 83.3 x 23.8	PA5350	7 27/32 x 7 x 1 25/32	199.5 x 178.0 x 45.0	PA10085
4 13/16 x 3 15/32 x 25/32	122.2 x 88.1 x 19.8	PA10217	7 7/8 x 6 5/16 x 5/8	200.0 x 160.3 x 15.9	PA5494
4 31/32 x 3 27/32 x 1 19/32	126.2 x 97.6 x 40.5	PA4908	7 7/8 x 7 x 1 19/32	200.0 x 177.8 x 40.5	PA2127
5 1/8 x 4 7/16 x 7/8	130.2 x 112.7 x 22.2	PA30055	7 7/8 x 7 1/8 x 21/32	200.0 x 181.0 x 16.7	PA30001
5 5/32 x 4 7/16 x 25/32	131.0 x 112.7 x 19.8	PA2222	7 7/8 x 7 7/16 x 23/32	200.0 x 188.9 x 18.3	PA4365
5 5/32 x 4 1/2 x 29/32	131.0 x 114.3 x 23.0	PA4754	7 29/32 x 7 3/16 x 21/32	200.8 x 182.6 x 16.7	PA30115
5 13/32 x 3 3/8 x 1 13/16	137.3 x 85.7 x 46.0	PA4852	7 15/16 x 4 7/16 x 1 9/16	201.6 x 112.7 x 39.7	PA10193 KIT
5 5/8 x 4 1/32 x 1 7/8	142.9 x 102.4 x 47.6	PA5353	7 15/16 x 7 7/8 x 23/32	201.6 x 200.0 x 18.3	PA5638
5 11/16 x 5 7/16 x 1 7/16	144.3 x 138.4 x 36.8	PA31014	8 x 3 19/32 x 3/4	203.2 x 91.3 x 19.1	PA30188
5 27/32 x 5 27/32 x 25/32	148.3 x 148.3 x 19.8	PA10016	8 x (4 1/4 to 6 1/4) x 1 7/16	203.2 x (108.0 to 158.8) x 36.5	PA4570
5 27/32 x 4 17/32 x 1	148.4 x 115.1 x 25.4	PA5393	8 1/32 x 7 3/32 x 31/32	204.0 x 180.2 x 24.6	PA10144
5 29/32 x 4 7/32 x 1 17/32	150.0 x 107.2 x 38.9	PA5729	8 1/32 x 7 1/8 x 15/16	204.0 x 181.1 x 23.9	PA10104
6 1/16 x 2 15/16 x 25/32	154.0 x 74.6 x 19.8	PA4460 KIT	8 1/32 x 7 19/32 x 1 7/8	204.0 x 192.9 x 47.6	PA10202
6 5/32 x 5 27/32 x 9 9/32	156.5 x 148.6 x 236.0	PA31013	8 1/16 x 6 3/32 x 1 15/32	204.7 x 154.7 x 37.6	PA10403
6 9/32 x 6 5/32 x 1 17/32	159.5 x 156.4 x 38.9	PA4979	8 1/16 x 5 1/4 x 1 5/8	204.8 x 133.4 x 41.3	PA2104
6 9/32 x 6 3/16 x 1 17/32	159.5 x 157.2 x 38.9	PA4730	8 1/16 x 6 x 6	204.8 x 152.4 x 152.4	PA1771
6 5/16 x 4 7/16 x 13/16	160.3 x 112.7 x 20.6	PA4555	8 1/16 x 8 1/16 x 25/32	204.8 x 204.8 x 19.8	PA10362
6 11/32 x 3 1/2 x 15/16	161.1 x 88.9 x 23.8	PA30051	8 3/32 x 8 x 25/32	205.5 x 202.9 x 19.8	PA10412
6 11/32 x 5 31/32 x 1 13/16	161.1 x 151.6 x 46.0	PA10266	8 3/32 x 5 9/32 x 1 5/8	205.6 x 134.1 x 41.3	PA5333
6 1/2 x 2 1/4 x 3 1/8	165.1 x 57.2 x 79.5	SA10100	8 3/32 x 7 27/32 x 1 5/16	205.6 x 199.2 x 33.3	PA10194
6 9/16 x 6 3/8 x 9/16	166.7 x 168.3 x 43.7	PA10167	8 1/8 x 4 1/2 x 19/32	206.4 x 114.3 x 15.1	PA5651
6 5/8 x 3 3/4 x 2 1/8	168.3 x 95.3 x 54.0	PA30144	8 5/32 x 5 27/32 x 1 15/32	207.2 x 148.4 x 37.3	PA10328
6 21/32 x 5 13/16 x 2 7/32	169.1 x 147.6 x 56.4	PA4366	8 5/32 x 6 3/32 x 2 3/16	207.2 x 154.8 x 55.6	PA4470
6 21/32 x 6 21/32 x 1 9/16	169.1 x 169.1 x 39.7	PA10397	8 5/32 x 7 5/16 x 1 5/32	207.2 x 185.7 x 29.4	PA5620
6 13/16 x 6 1/32 x 1 21/32	173.0 x 153.2 x 42.1	PA10269	8 3/16 x 4 9/16 x 19/32	208.0 x 115.9 x 15.2	PA30148
6 13/16 x 6 21/32 x 1 13/16	173.0 x 169.1 x 46.0	PA10380	8 3/16 x 4 9/16 x 1 13/16	208.0 x 115.9 x 46.0	PA5403
6 31/32 x 4 11/16 x 1 7/16	176.8 x 119.1 x 36.6	PA10275	8 3/16 x 6 1/32 x 1 3/16	208.0 x 153.4 x 30.0	PA30287
6 31/32 x 3 15/32 x 1 9/32	177.0 x 88.1 x 32.5	PA4750	8 3/16 x 6 31/32 x 1 3/4	208.0 x 177.0 x 44.5	PA10071
6 31/32 x 6 31/32 x 3/4	177.0 x 177.0 x 19.1	PA10372	8 3/16 x 7 13/32 x 2 11/32	208.0 x 188.1 x 64.3	PA10046
7 x 4 3/4 x 11/16	177.5 x 120.5 x 17.0	PA30261	8 7/32 x 5 23/32 x 7/8	208.8 x 145.3 x 22.2	PA30117
7 x 3 1/2 x 1 1/16	177.8 x 88.9 x 27.0	PA4906	8 7/32 x 5 7/8 x 1 15/32	208.8 x 149.2 x 37.3	PA4045
7 x 3 1/2 x 1 1/2	177.8 x 88.9 x 38.1	PA30050	8 7/32 x 7 1/4 x 1 21/32	208.8 x 184.2 x 42.1	PA4050
7 x 5 15/32 x 1/2	177.8 x 138.9 x 12.7	PA5719	8 7/32 x 8 1/32 x 1 3/16	209.0 x 204.0 x 30.0	PA10129
7 1/16 x 6 9/32 x 5/8	179.4 x 159.5 x 15.9	PA10318	8 1/4 x 4 5/8 x 25/32	209.6 x 117.5 x 19.8	PA30228
7 1/16 x (8 7/16 to 11 7/16) x 2 5/16	179.4 x (214.3 to 290.5) x 58.7	PA10392	8 1/4 x 5 31/32 x 8 1/8	209.6 x 151.6 x 206.4	PA1772
7 3/32 x 6 5/16 x 1	180.2 x 160.3 x 25.4	PA10159	8 1/4 x 6 15/32 x 1	209.6 x 164.3 x 25.4	PA10066
7 1/8 x 2 3/16 x 3/4	181.0 x 55.6 x 19.1	PA30056	8 9/32 x 4 15/32 x 23/32	210.3 x 113.5 x 18.3	PA10176
7 1/8 x 3 19/32 x 25/32	181.0 x 91.3 x 19.8	PA10365 KIT	8 9/32 x 8 1/32 x 25/32	210.3 x 204.0 x 19.8	PA4987
7 1/8 x 5 19/32 x 2 1/16	181.0 x 142.1 x 52.4	PA10256	8 9/32 x 8 9/32 x 1 15/16	210.3 x 210.3 x 49.2	PA3839
7 1/8 x 6 5/8 x 1 5/16	181.0 x 168.3 x 33.3	PA4443	8 5/16 x 8 5/16 x 8 1/16	211.1 x 211.1 x 204.8	PA1773
7 3/16 x 7 1/16 x 1 1/8	182.6 x 179.4 x 28.6	PA4411	8 11/32 x 3 21/32 x 11/32	211.9 x 92.9 x 38.9	PA5738
7 1/4 x 7 1/16 x 1 5/32	184.2 x 179.4 x 29.4	PA10157	8 11/32 x 3 31/32 x 1 3/32	211.9 x 100.8 x 27.8	PA30054
7 5/16 x 6 23/32 x 1 1/16	185.7 x 170.7 x 27.0	PA4352	8 11/32 x 7 1/2 x 1 1/16	211.9 x 190.5 x 27.0	PA5753
7 3/8 x 7 3/8 x 1	187.3 x 187.3 x 25.4	PA10370 KIT	8 11/32 x 7 5/8 x 1 3/32	211.9 x 193.7 x 27.8	PA30150
7 13/32 x 7 1/16 x 1 27/32	188.1 x 179.4 x 46.8	PA10227	8 3/8 x 7 1/4 x 1 1/8	212.7 x 184.2 x 28.6	PA4408
7 7/16 x 6 1/16 x 2 1/16	188.9 x 154.0 x 52.4	PA4105	8 3/8 x 8 1/16 x 1 31/32	212.7 x 204.8 x 50.0	PA4103
7 17/32 x 7 1/8 x 1 23/32	191.3 x 181.0 x 43.7	PA10389	8 3/8 x 8 5/16 x 21/32	212.7 x 211.1 x 16.7	PA4194
7 19/32 x 7 1/32 x 1 9/32	192.9 x 178.6 x 32.5	PA10378	8 3/8 x 8 3/8 x 2 7/32	212.7 x 212.7 x 56.4	PA2208
7 19/32 x 7 7/8 x 1 7/8	192.9 x 200.0 x 47.6	PA4099	8 13/32 x 6 5/16 x 1 31/32	213.5 x 160.3 x 50.0	PA4176
7 5/8 x 6 1/32 x 1 17/32	193.7 x 150.8 x 38.9	PA2160	8 13/32 x 7 5/8 x 1 1/8	213.5 x 193.7 x 28.6	PA10190
7 5/8 x 6 1/16 x 1 3/32	193.7 x 154.0 x 27.8	PA3840	8 7/16 x 7 11/16 x 1 1/8	214.3 x 195.3 x 28.8	PA4327
7 5/8 x 7 13/32 x 1 3/16	193.7 x 188.1 x 30.2	PA10146	7 1/16 x 7 3/4 x 2 3/16	214.3 x 196.9 x 55.6	PA4419
7 25/32 x 4 1/32 x 3/4	196.1 x 102.4 x 19.1	PA30152	8 7/16 x 8 3/8 x 1 3/16	214.3 x 212.7 x 30.2	PA10182
			8 7/16 x 6 1/4 x 2 11/16	214.4 x 158.5 x 68.1	PA10408
			8 15/32 x 7 29/32 x 1 3/8	214.9 x 200.9 x 35.1	PA10439
			8 15/32 x 7 9/32 x 1 5/32	215.0 x 185.0 x 29.0	PA10097
			8 15/32 x 6 1/2 x 1 7/8	215.1 x 165.1 x 47.6	PA10342
			8 15/32 x 7 19/32 x 1 1/8	215.1 x 192.9 x 28.6	PA4393



WARNING: These products can expose you to chemicals, including Diisononyl Phthalate, Carbon black extracts, Nickel, 1,3 Butadiene, Ethylene Oxide, Epichlorohydrin, which are known to the State of California to cause cancer, and Bisphenol-A, Ethylene Glycol, Ethylene Oxide, 1,3 Butadiene, Epichlorohydrin, which are known to the State of California to cause birth defects or other reproductive harm. For more information go to www.P65Warnings.ca.gov.

PANEL AIR FILTERS

LENGTH x WIDTH x THICK Inches	LENGTH x WIDTH x THICK (mm)	BALDWIN NUMBER	LENGTH x WIDTH x THICK Inches	LENGTH x WIDTH x THICK (mm)	BALDWIN NUMBER
8 15/32 x 8 15/32 x 21/32	215.1 x 215.1 x 16.7	PA4188	8 31/32 x 8 5/8 x 2 5/8	227.8 x 219.1 x 66.7	PA10301
8 1/2 x 7 3/8 x 1 1/8	215.9 x 186.9 x 29.0	PA10108	9 x 4 5/32 x 25/32	228.6 x 105.6 x 19.8	PA30229
8 1/2 x 7 5/8 x 3/4	215.9 x 193.7 x 19.1	PA5495	9 x 7 x 1 3/8	228.6 x 177.8 x 34.9	PA3777
8 1/2 x 7 21/32 x 31/32	215.9 x 194.5 x 24.6	PA4373	9 x 7 x 1 15/16	228.6 x 177.8 x 49.2	PA4421
8 1/2 x 7 11/16 x 5/8	215.9 x 195.3 x 15.9	PA4372	9 x 7 1/8 x 1 27/32	228.6 x 181.0 x 46.8	PA5631
8 1/2 x 7 3/4 x 31/32	215.9 x 196.9 x 24.6	PA10136	9 x 7 3/4 x 2 7/32	228.6 x 196.9 x 56.4	PA4160
8 1/2 x 8 7/16 x 29/32	215.9 x 214.3 x 23.0	PA10363	9 x 7 13/16 x 1 1/4	228.6 x 198.4 x 31.8	PA4405
8 1/2 x 8 1/2 x 1 5/8	215.9 x 215.9 x 41.3	PA2221	9 x 8 19/32 x 1 15/16	228.6 x 218.3 x 49.2	PA10064
8 17/32 x 3 1/16 x 27/32	216.7 x 77.8 x 21.4	PA10261	9 x 9 x 2 9/16	228.6 x 228.6 x 65.1	PA3495
8 17/32 x 6 9/16 x 1 5/16	216.7 x 166.7 x 33.3	PA10289	9 x 9 x 2 9/16	228.6 x 228.6 x 65.1	PA3804
8 17/32 x 7 23/32 x 1 1/32	216.7 x 196.1 x 26.2	PA10206 KIT	9 1/32 x 4 17/32 x 1 3/16	229.4 x 115.1 x 30.2	PA10150
8 17/32 x 7 7/8 x 25/32	216.7 x 196.9 x 19.8	PA10163	9 1/32 x 4 9/16 x 2 7/32	229.4 x 115.9 x 56.4	PA4155 KIT
8 17/32 x 7 15/16 x 1 31/32	216.7 x 201.6 x 50.0	PA5629	9 1/32 x 5 1/32 x 1/4	229.4 x 127.8 x 6.4	PA30165
8 17/32 x 6 3/16 x 1 3/16	217.0 x 157.0 x 30.0	PA10083	9 1/32 x 6 5/8 x 1 7/32	229.4 x 168.3 x 31.0	PA4018
8 9/16 x 5 3/32 x 1 11/32	217.5 x 129.4 x 34.1	PA30052	9 1/32 x 7 3/16 x 1 5/8	229.4 x 182.6 x 41.3	PA3929
8 19/32 x 4 5/32 x 31/32	218.3 x 105.6 x 24.6	PA5683	9 1/32 x 7 9/32 x 2 1/16	229.4 x 184.9 x 52.4	PA4015
8 19/32 x 8 15/32 x 1	218.3 x 215.1 x 25.4	PA10185	9 1/16 x 5 5/16 x 1 11/32	230.2 x 134.9 x 34.1	PA4442
8 5/8 x 6 3/16 x 1 11/32	219.1 x 157.2 x 34.1	PA5337	9 1/16 x 6 1/8 x 1 3/16	230.2 x 155.6 x 30.2	PA5714
8 5/8 x 6 1/4 x 1 3/16	219.1 x 158.8 x 30.2	PA10154	9 1/16 x 7 7/16 x 2 9/32	230.2 x 188.9 x 57.9	PA4441
8 5/8 x 7 11/16 x 31/32	219.1 x 195.3 x 24.6	PA5722	9 1/16 x 7 25/32 x 31/32	230.2 x 197.6 x 24.6	PA10149
8 5/8 x 8 11/32 x 31/32	219.1 x 211.9 x 24.6	PA5359	9 1/16 x 7 7/8 x 3/4	230.2 x 200.0 x 19.1	PA10373
8 21/32 x 4 7/8 x 19/32	219.9 x 123.8 x 15.1	PA5723	9 1/16 x 7 7/8 x 2 5/32	230.2 x 200.0 x 54.8	PA4108
8 21/32 x 5 29/32 x 25/32	219.9 x 150.0 x 19.8	PA5585	9 1/16 x 8 1/2 x 1 1/8	230.2 x 215.9 x 28.6	PA10179
8 21/32 x 7 23/32 x 11/32	219.9 x 196.1 x 8.7	PA32004	9 1/16 x 8 17/32 x 1 9/16	230.2 x 216.7 x 39.7	PA10343
8 21/32 x 7 27/32 x 25/32	219.9 x 199.2 x 19.8	PA4332	9 3/32 x 5 5/8 x 1 9/16	230.9 x 218.9 x 39.9	PA10419
8 11/16 x 8 15/32 x 1 1/4	220.5 x 215.4 x 31.5	PA4197	9 3/32 x 6 7/8 x 2 23/32	231.0 x 174.6 x 69.1	PA4938
8 11/16 x 4 1/4 x 1 17/32	220.7 x 108.0 x 38.9	PA4156 KIT	9 3/32 x 7 19/32 x 13 3/4	231.0 x 192.9 x 349.3	PA31006
8 11/16 x 7 27/32 x 1 3/16	220.7 x 199.2 x 30.2	PA4199	9 1/8 x 4 3/32 x 27/32	231.8 x 104.0 x 21.4	PA10204 KIT
8 11/16 x 7 7/8 x 1 25/32	220.7 x 200.0 x 45.2	PA4424	9 1/8 x 4 9/16 x 1 11/32	231.8 x 115.9 x 34.1	PA4469
8 11/16 x 8 9/32 x 1 15/16	220.7 x 210.3 x 49.2	PA4483	9 1/8 x 6 11/32 x 2 5/16	231.8 x 161.1 x 58.7	PA10391
8 25/32 x 7 9/16 x 2 1/8	222.0 x 192.0 x 54.0	PA4102	9 1/8 x 7 15/32 x 2 9/32	231.8 x 189.7 x 57.9	PA4447
8 3/4 x 8 x 1 5/32	222.2 x 203.2 x 29.2	PA10132	9 1/8 x 7 19/32 x 9 7/8	231.8 x 192.9 x 250.8	PA31004
8 3/4 x 4 5/16 x 11/16	222.3 x 109.5 x 17.5	PA10211 KIT	9 1/8 x 8 9/32 x 15/16	231.8 x 210.3 x 23.8	PA10209 KIT
8 3/4 x 7 3/8 x 1 13/32	222.3 x 187.3 x 35.7	PA10028	9 1/8 x 8 17/32 x 1 31/32	231.8 x 216.7 x 50.0	PA4198
8 3/4 x 7 3/8 x 1 25/32	222.3 x 187.3 x 45.2	PA4344	9 1/8 x 8 21/32 x 5/16	231.8 x 219.9 x 7.9	PA4392
8 3/4 x 11 5/16 x 1 7/16	222.3 x 287.3 x 36.5	PA4368	9 1/8 x 9 1/32 x 2 1/8	231.9 x 229.1 x 54.1	PA10276
8 3/4 x 6 17/32 x 1 1/4	222.5 x 166.1 x 32.0	PA30279	9 5/32 x 7 29/32 x 15/16	232.6 x 200.8 x 23.8	PA5622
8 13/16 x 8 1/4 x 25/32	223.5 x 210.0 x 20.0	PA10082	9 5/32 x 8 15/32 x 1 27/32	232.6 x 215.1 x 46.8	PA4436
8 13/16 x 6 5/8 x 1 31/32	223.8 x 168.3 x 50.0	PA2169	9 5/32 x 8 1/2 x 1 3/16	232.9 x 215.9 x 30.0	PA10431
8 13/16 x 7 27/32 x 1 9/16	223.8 x 199.2 x 39.7	PA10175 KIT	9 3/16 x 5 9/16 x 2 1/4	233.4 x 141.3 x 57.2	PA10307
8 13/16 x 7 7/8 x 1 3/32	224.0 x 199.9 x 27.9	PA10411	9 3/16 x 8 13/16 x 2 1/4	233.4 x 233.8 x 57.2	PA10041
8 27/32 x 4 13/32 x 1 1/8	224.6 x 111.9 x 28.6	PA4195 KIT	9 7/32 x 8 1/8 x 2 5/16	234.2 x 206.4 x 66.7	PA10280
8 27/32 x 7 27/32 x 13/32	225.0 x 199.0 x 10.0	PA30269	9 7/32 x 8 7/16 x 23/32	234.2 x 214.3 x 18.3	PA4371
8 7/8 x 3 31/32 x 31/32	225.4 x 100.8 x 24.6	PA10145 KIT	9 7/32 x 8 7/16 x 1 23/32	234.2 x 214.3 x 43.6	PA10205 KIT
8 7/8 x 5 5/16 x 1 5/8	225.4 x 134.9 x 41.3	PA3953	9 7/32 x 8 21/32 x 1 1/8	234.2 x 219.9 x 28.6	PA4196
8 7/8 x 5 31/32 x 1 9/16	225.4 x 151.6 x 39.7	PA4381	9 7/32 x 8 15/16 x 1 13/16	234.2 x 227.0 x 46.0	PA10004
8 7/8 x 6 21/32 x 1 5/16	225.4 x 169.1 x 33.3	PA4100	9 7/16 x 8 1/32 x 1 13/16	234.7 x 204.0 x 46.0	PA4386
8 7/8 x 6 27/32 x 1 5/16	225.4 x 173.8 x 33.3	PA30094	9 1/4 x 2 23/32 x 31/32	235.0 x 69.3 x 24.9	PA30331
8 7/8 x 6 31/32 x 1 7/16	225.4 x 177.0 x 36.5	PA31005	9 1/4 x 7 7/32 x 1 13/32	235.0 x 183.4 x 35.7	PA30141
8 7/8 x 6 31/32 x 1 7/16	225.4 x 177.0 x 36.5	PA31007	9 1/4 x 7 29/32 x 1 13/16	235 x 200.8 x 46	PA10306
8 7/8 x 7 13/32 x 1 1/2	225.4 x 188.1 x 38.1	PA4085	9 1/4 x 8 1/8 x 1 5/8	235.0 x 206.4 x 41.3	PA10070
8 7/8 x 7 3/4 x 13/16	225.4 x 196.9 x 20.6	PA10032	9 1/4 x 8 9/32 x 1 3/8	235.0 x 210.3 x 34.9	PA10166
8 7/8 x 8 7/8 x 1 13/32	225.4 x 225.4 x 35.7	PA4016	9 1/4 x 8 3/8 x 1 15/32	235.0 x 212.7 x 37.3	PA10333
8 29/32 x 7 11/16 x 1 3/16	226.1 x 195.1 x 30.0	PA10128	9 1/4 x 8 3/8 x 1 15/32	235.0 x 212.7 x 37.3	PA10334
8 29/32 x 7 27/32 x 1 1/8	226.2 x 199.2 x 28.6	PA10400	9 1/4 x 7 3/16 x 1 13/16	235.2 x 182.6 x 45.4	PA10059
8 29/32 x 8 3/16 x 1 25/32	226.2 x 208.0 x 45.2	PA2228	9 9/32 x 9 9/32 x 2 1/8	235.5 x 235.5 x 54.1	PA10267
8 29/32 x 8 5/8 x 1 3/4	226.2 x 219.1 x 44.5	PA4184	9 9/32 x 6 25/32 x 23/32	235.7 x 172.2 x 18.3	PA10002
8 15/16 x 2 1/2 x 3/4	227.0 x 63.5 x 19.1	PA30154	9 9/32 x 7 15/16 x 1 9/16	235.7 x 201.6 x 39.7	PA2212
8 15/16 x 6 19/32 x 2 1/8	227.0 x 167.5 x 54.0	PA5328	9 9/32 x 8 7/16 x 1 17/32	235.7 x 214.3 x 38.9	PA4335
8 15/16 x 7 9/32 x 1 1/32	227.0 x 184.9 x 26.2	PA4461	9 9/32 x 8 19/32 x 25/32	235.7 x 218.3 x 19.8	PA10009
8 15/16 x 7 3/4 x 1 3/4	227.0 x 196.9 x 44.5	PA4320	9 9/32 x 8 13/16 x 2 5/16	235.7 x 223.8 x 58.7	PA4349
8 15/16 x 7 7/8 x 1 3/16	227.0 x 200.0 x 30.2	PA10030	9 9/32 x 9 1/8 x 2 1/8	235.7 x 231.8 x 54.0	PA10255
8 15/16 x 7 7/8 x 1 3/16	227.0 x 200.0 x 30.2	PA30093	9 5/16 x 6 11/32 x 2 9/32	236.5 x 161.1 x 57.9	PA5314
8 15/16 x 7 29/32 x 21/32	227.0 x 200.8 x 16.7	PA4391	9 5/16 x 7 3/32 x 1 19/32	236.5 x 180.2 x 40.5	PA2231
8 15/16 x 8 5/16 x 31/32	227.0 x 211.1 x 24.6	PA10171	9 5/16 x 8 13/32 x 11/16	236.5 x 213.5 x 17.5	PA10141
8 15/16 x 6 25/32 x 1 5/8	227.1 x 172.5 x 40.9	PA10422	9 5/16 x 9 3/16 x 1 21/32	236.5 x 233.4 x 42.1	PA10321
8 15/16 x 8 11/32 x 1 9/16	227.1 x 211.8 x 39.9	PA10415	9 11/32 x 5 7/16 x 29/32	237.3 x 138.1 x 23.0	PA4149 KIT
8 31/32 x 6 5/16 x 1 1/2	227.8 x 160.3 x 38.1	PA5661	9 11/32 x 8 7/16 x 1 3/8	237.3 x 214.3 x 34.9	PA4426
8 31/32 x 6 31/32 x 2 17/32	227.8 x 177.0 x 64.3	PA5312 KIT	9 11/32 x 8 7/16 x 1 21/32	237.3 x 214.3 x 42.1	PA4132
8 31/32 x 8 1/32 x 1 5/8	227.8 x 204.0 x 41.3	PA10395			



WARNING: These products can expose you to chemicals, including Diisononyl Phthalate, Carbon black extracts, Nickel, 1,3 Butadiene, Ethylene Oxide, Epichlorohydrin, which are known to the State of California to cause cancer, and Bisphenol-A, Ethylene Glycol, Ethylene Oxide, 1,3 Butadiene, Epichlorohydrin, which are known to the State of California to cause birth defects or other reproductive harm. For more information go to www.P65Warnings.ca.gov.

PANEL AIR FILTERS

LENGTH x WIDTH x THICK Inches	LENGTH x WIDTH x THICK (mm)	BALDWIN NUMBER	LENGTH x WIDTH x THICK Inches	LENGTH x WIDTH x THICK (mm)	BALDWIN NUMBER
9 11/32 x 8 1/2 x 1 17/32	237.3 x 215.9 x 38.9	PA10183	9 7/8 x 5 29/32 x 1 7/16	250.8 x 150.0 x 36.5	PA2220
9 3/8 x 7 11/16 x 1 1/16	238.0 x 195.1 x 26.9	PA10081	9 7/8 x 7 7/8 x 1 3/16	250.8 x 200.0 x 30.2	PA10139
9 3/8 x 6 21/32 x 1 13/32	238.1 x 169.1 x 35.7	PA10376	9 7/8 x 8 5/16 x 2 3/32	250.8 x 211.1 x 53.2	PA10253
9 3/8 x 7 1/8 x 1 5/8	238.1 x 181 x 41.3	PA10297	9 7/8 x 8 13/32 x 2 3/32	250.8 x 213.5 x 53.2	PA4380
9 3/8 x 7 1/2 x 1 9/16	238.1 x 190.5 x 39.7	PA4313	9 7/8 x 8 23/32 x 1 3/16	250.8 x 221.5 x 30.2	PA4334
9 3/8 x 8 7/32 x 2 7/32	238.1 x 208.8 x 56.4	PA10320	9 7/8 x 7 3/32 x 1 3/8	251.0 x 180.1 x 35.1	PA10402
9 3/8 x 8 3/8 x 1 25/32	238.1 x 212.7 x 45.2	PA4329	9 7/8 x 8 7/32 x 25/32	251.0 x 209.0 x 20.1	PA10401
9 3/8 x 8 27/32 x 1 31/32	238.1 x 224.6 x 50.0	PA4178	9 7/8 x 9 13/16 x 1	251.0 x 249.5 x 25.2	PA30325
9 13/32 x 7 7/16 x 25/32	238.9 x 188.9 x 19.8	PA10131	9 29/32 x 5 9/32 x 1 17/32	251.6 x 134.1 x 38.9	PA10152 KIT
9 13/32 x 6 3/8 x 2 1/8	239.0 x 162.1 x 53.6	PA10086	9 29/32 x 7 27/32 x 2 1/16	251.6 x 199.2 x 52.4	PA4144
9 7/16 x 6 31/32 x 2 3/32	239.7 x 177.0 x 53.2	PA4446	9 29/32 x 9 5/8 x 25/32	251.6 x 244.5 x 19.8	PA10213
9 7/16 x 7 15/32 x 31/32	239.7 x 189.7 x 24.6	PA10147	9 15/16 x 7 1/32 x 1 9/16	252.4 x 178.6 x 39.7	PA4044
9 7/16 x 7 11/16 x 1 17/32	239.7 x 195.3 x 38.9	PA30151	9 15/16 x 7 1/32 x 2 3/16	252.4 x 178.6 x 55.6	PA4163
9 7/16 x 7 23/32 x 25/32	239.7 x 196.1 x 19.8	PA10364	9 31/32 x 6 1/32 x 2 3/16	253.2 x 153.2 x 55.6	PA5663
9 7/16 x 7 15/16 x 1 1/8	239.7 x 201.6 x 28.6	PA10130	9 31/32 x 6 25/32 x 1 13/32	253.2 x 172.2 x 35.7	PA10008
9 7/16 x 8 x 1 3/16	239.7 x 203.2 x 30.2	PA10014	9 31/32 x 6 13/16 x 1 23/32	253.2 x 173.0 x 43.7	PA4348
9 7/16 x 8 1/32 x 1 3/16	239.7 x 204.0 x 30.2	PA10369	9 31/32 x 8 1/2 x 1 3/8	253.2 x 216.0 x 35.0	PA10162
9 7/16 x 8 1/4 x 21/32	239.7 x 209.6 x 16.7	PA10155	9 31/32 x 8 3/4 x 1 3/16	253.2 x 222.3 x 30.2	PA10148
9 7/16 x 8 9/32 x 2 5/32	239.7 x 210.3 x 54.8	PA10270	9 31/32 x 9 3/16 x 1 23/32	253.2 x 233.4 x 43.7	PA4361
9 7/16 x 8 17/32 x 2	239.7 x 216.7 x 50.8	PA10238			
9 7/16 x 7 7/8 x 21/32	240.0 x 200.0 x 17.0	PA10396	10 x 5 5/8 x 25/32	254.0 x 142.9 x 19.8	PA10210 KIT
9 1/2 x 7 x 1 3/32	241.3 x 177.8 x 27.8	PA30096	10 x 5 5/8 x 25/32	254.0 x 142.9 x 19.8	PA5327
9 17/32 x 4 1/2 x 1 1/4	242.1 x 114.3 x 31.8	PA2138	10 x 6 x 2 3/16	254.0 x 152.4 x 55.6	PA3613
9 17/32 x 6 23/32 x 1/4	242.1 x 170.8 x 6.4	PA30166	10 x 6 7/8 x 1 5/8	254.0 x 174.6 x 41.3	PA4308
9 17/32 x 6 25/32 x 1 31/32	242.1 x 172.2 x 50.0	PA10039	10 x 9 1/4 x 1 1/4	254.0 x 235.0 x 32.0	PA10404
9 17/32 x 7 3/32 x 1 19/32	242.1 x 180.2 x 40.5	PA4109	10 x 9 9/32 x 2 1/4	254.0 x 235.7 x 57.2	PA4333
9 17/32 x 9 17/32 x 1 9/16	242.1 x 242.1 x 39.7	PA2191	10 x 9 7/8 x 25/32	254.0 x 251.0 x 20.1	PA30277
9 9/16 x 8 3/4 x 1 27/32	242.6 x 222.0 x 46.5	PA10414	10 x 10 x 2 9/16	254.0 x 254.0 x 65.1	PA3473
9 9/16 x 6 15/32 x 2 1/8	242.9 x 164.3 x 54.0	PA4382	10 1/32 x 5 17/32 x 1 19/32	254.8 x 140.5 x 40.5	PA10186 KIT
9 9/16 x 7 15/32 x 2 3/16	242.9 x 189.7 x 55.6	PA10010	10 1/32 x 7 7/16 x 1 15/32	254.8 x 188.9 x 37.3	PA4314
9 9/16 x 8 29/32 x 2 1/8	242.9 x 226.2 x 54.0	PA4449	10 1/32 x 8 3/16 x 2 13/32	254.8 x 208.0 x 61.1	PA4430
9 19/32 x 9 1/8 x 1 5/16	243.7 x 231.8 x 33.3	PA30174	10 1/32 x 7 15/16 x 1 7/32	254.8 x 210.6 x 31.0	PA30140
9 5/8 x 8 3/4 x 2 3/16	244.5 x 222.3 x 55.6	PA4438	10 1/16 x 7 5/32 x 1 9/16	255.6 x 181.8 x 39.7	PA4069
9 5/8 x 8 31/32 x 1 1/8	244.6 x 228.1 x 29.0	PA10418	10 1/16 x 8 3/4 x 11/16	255.6 x 222.3 x 17.5	PA4398
9 21/32 x 6 1/2 x 1	245.1 x 165.1 x 25.4	PA30310	10 1/16 x 9 31/32 x 1 3/8	255.6 x 253.2 x 34.9	PA10138
9 21/32 x 5 5/16 x 25/32	245.3 x 134.9 x 18.3	PA30080	10 3/32 x 7 x 1 5/16	256.4 x 177.8 x 33.3	PA2201
9 21/32 x 5 7/16 x 1 9/16	245.3 x 138.1 x 39.7	PA2204	10 3/32 x 7 15/16 x 1 23/32	256.4 x 201.6 x 43.7	PA4400
9 21/32 x 6 5/16 x 1 15/32	245.3 x 160.3 x 37.3	PA4043	10 3/32 x 9 13/16 x 1 21/32	256.4 x 249.2 x 42.1	PA4454
9 21/32 x 7 x 2 5/16	245.3 x 177.8 x 58.7	PA4048	10 3/32 x 10 1/32 x 1 3/4	256.4 x 254.8 x 44.5	PA10036
9 21/32 x 8 1/32 x 3/4	245.3 x 204.0 x 19.1	PA4404	10 1/8 x 7 29/32 x 1 3/16	257.0 x 200.7 x 30.0	PA10135
9 21/32 x 8 1/8 x 2 1/16	245.3 x 206.4 x 52.4	PA4060	10 1/8 x 3 7/8 x 1 1/2	257.2 x 98.4 x 38.1	PA10199 KIT
9 21/32 x 8 1/2 x 13/16	245.3 x 215.9 x 20.6	PA10165	10 1/8 x 5 1/32 x 3/16	257.2 x 127.8 x 4.8	PA5773
9 21/32 x 8 19/32 x 2 5/32	245.3 x 218.3 x 54.8	PA10346	10 1/8 x 7 3/4 x 1 11/16	257.2 x 196.9 x 42.9	PA4468
9 11/16 x 5 5/8 x 2 5/16	246.1 x 142.9 x 58.7	PA10057	10 1/8 x 8 9/32 x 1 11/16	257.2 x 210.3 x 42.9	PA4023
9 11/16 x 6 5/16 x 1 15/32	246.1 x 160.3 x 37.3	PA4084	10 1/8 x 8 7/16 x 2 3/16	257.2 x 214.3 x 65.6	PA4091
9 11/16 x 7 5/16 x 1 15/16	246.1 x 185.7 x 49.2	PA4452	10 5/32 x 3 31/32 x 31/32	258.0 x 100.8 x 24.6	PA4410 KIT
9 11/16 x 6 21/32 x 1 25/32	246.4 x 168.9 x 45.0	PA10407	10 5/32 x 5 3/4 x 1 7/8	258.0 x 146.1 x 47.6	PA4479
9 23/32 x 3 29/32 x 21/32	246.9 x 99.2 x 16.7	PA10191 KIT	10 5/32 x 5 29/32 x 31/32	258.0 x 150.0 x 24.6	PA10367
9 23/32 x 6 17/32 x 1 3/8	246.9 x 165.9 x 34.9	PA5633	10 5/32 x 6 13/32 x 2 1/16	258.0 x 162.7 x 52.4	PA4480
9 23/32 x 7 29/32 x 1 29/32	246.9 x 200.8 x 48.4	PA4471	10 5/32 x 6 13/32 x 2 3/32	258.0 x 162.7 x 53.2	PA10027
9 23/32 x 8 1/8 x 1 3/16	246.9 x 206.4 x 30.2	PA10170 KIT	10 5/32 x 6 1/2 x 1 9/16	258.0 x 165.1 x 39.7	PA10231
9 23/32 x 8 9/32 x 1 3/8	246.9 x 210.3 x 34.9	PA10156	10 5/32 x 6 1/2 x 1 11/16	258.0 x 165.1 x 42.9	PA4325
9 23/32 x 8 1/2 x 29/32	246.9 x 215.9 x 23.0	PA4317	10 5/32 x 6 17/32 x 27/32	258.0 x 165.9 x 21.4	PA30177
9 3/4 x 6 9/32 x 2 11/32	247.7 x 159.5 x 59.5	PA10337	10 5/32 x 8 3/16 x 2 3/32	258.0 x 208.0 x 53.2	PA10000
9 3/4 x 7 13/16 x 1 9/16	247.7 x 198.4 x 39.7	PA10134	10 5/32 x 8 1/16 x 1 9/16	258.1 x 205.0 x 39.9	PA10103
9 3/4 x 8 1/4 x 2 3/32	247.7 x 209.6 x 53.2	PA4354	10 3/16 x 5 7/8 x 2 7/32	258.8 x 149.2 x 56.4	PA4047
9 3/4 x 8 13/16 x 1 15/16	247.7 x 223.8 x 49.2	PA10245	10 3/16 x 7 x 1 31/32	258.8 x 177.8 x 50.0	PA4309
9 3/4 x 9 5/32 x 1 3/16	247.7 x 232.6 x 30.2	PA4486	10 7/32 x 6 15/32 x 2 13/32	259.6 x 164.3 x 61.1	PA4463
9 3/4 x 9 3/8 x 1 9/16	247.9 x 238.0 x 39.9	PA10084	10 1/4 x 6 17/32 x 1 13/32	260.4 x 165.9 x 35.7	PA5733
9 13/16 x 4 3/4 x 2 3/32	249.2 x 120.7 x 53.2	PA4305	10 1/4 x 6 5/8 x 1 7/32	260.4 x 168.3 x 31.0	PA10174
9 13/16 x 5 1/8 x 2 5/32	249.2 x 130.2 x 54.8	PA10272	10 1/4 x 6 3/4 x 2	260.4 x 171.5 x 50.8	PA2168
9 13/16 x 6 5/8 x 1 17/32	249.2 x 168.3 x 38.9	PA4311	10 1/4 x 7 3/32 x 1 17/32	260.4 x 180.2 x 38.9	PA4138
9 27/32 x 4 3/32 x 7/8	250.0 x 104.0 x 22.2	PA10195 KIT	10 1/4 x 8 x 2 1/4	260.4 x 203.2 x 57.2	PA4126
9 27/32 x 5 15/32 x 2 1/16	250.0 x 138.9 x 52.4	PA4049	10 9/32 x 7 29/32 x 1 3/16	261.1 x 200.8 x 30.2	PA10067
9 27/32 x 6 3/16 x 1 11/16	250.0 x 157.2 x 42.9	PA10382	10 5/16 x 5 21/32 x 1 1/2	261.9 x 143.7 x 38.1	PA4376
9 27/32 x 6 11/16 x 2	250.0 x 169.9 x 50.8	PA2214	10 5/16 x 6 15/16 x 2 9/32	261.9 x 176.2 x 57.9	PA10037
9 27/32 x 7 5/32 x 1 11/16	250.0 x 181.8 x 42.9	PA10188	10 5/16 x 8 3/32 x 1 3/4	261.9 x 205.6 x 44.5	PA4364
9 27/32 x 7 13/16 x 25/32	250.0 x 198.4 x 19.8	PA30173	10 5/16 x 8 7/32 x 1 3/16	261.9 x 208.8 x 30.2	PA10042
9 27/32 x 8 x 1 13/32	250.0 x 203.2 x 35.7	PA4474	10 11/32 x 9 3/8 x 1 3/16	262.4 x 238.1 x 30.2	PA10201
9 27/32 x 9 1/4 x 31/32	250.0 x 235.0 x 24.6	PA5798	10 11/32 x 5 9/32 x 2 3/16	262.7 x 134.1 x 55.6	PA4363



WARNING: These products can expose you to chemicals, including Diisononyl Phthalate, Carbon black extracts, Nickel, 1,3 Butadiene, Ethylene Oxide, Epichlorohydrin, which are known to the State of California to cause cancer, and Bisphenol-A, Ethylene Glycol, Ethylene Oxide, 1,3 Butadiene, Epichlorohydrin, which are known to the State of California to cause birth defects or other reproductive harm. For more information go to www.P65Warnings.ca.gov.

PANEL AIR FILTERS

LENGTH x WIDTH x THICK Inches	LENGTH x WIDTH x THICK (mm)	BALDWIN NUMBER	LENGTH x WIDTH x THICK Inches	LENGTH x WIDTH x THICK (mm)	BALDWIN NUMBER
10 11/32 x 5 15/32 x 31/32	262.7 x 138.9 x 24.6	CV15002	10 23/32 x 7 23/32 x 25/32	272.3 x 196.1 x 19.8	PA30113
10 11/32 x 6 1/2 x 1 9/16	262.7 x 165.1 x 39.7	PA5341	10 23/32 x 9 11/16 x 1 17/32	272.3 x 246.1 x 38.9	PA4164
10 11/32 x 6 23/32 x 1 13/32	262.7 x 170.7 x 35.7	PA4370	10 23/32 x 9 7/8 x 2	272.3 x 250.8 x 50.8	PA10294
10 11/32 x 7 1/4 x 1 3/16	262.7 x 184.2 x 30.2	PA10180 KIT	10 3/4 x 5 1/4 x 1 19/32	273.1 x 133.4 x 40.5	PA2103
10 3/8 x 7 x 1 13/32	263.5 x 177.8 x 35.7	PA5772	10 3/4 x 6 1/2 x 1 21/32	273.1 x 165.1 x 42.1	PA4079
10 3/8 x 7 17/32 x 25/32	263.5 x 191.3 x 19.8	PA10371	10 21/32 x 7 1/16 x 1 5/16	273.1 x 179.4 x 33.3	PA10025
10 3/8 x 9 19/32 x 1 3/16	263.5 x 243.7 x 30.2	PA4462	10 3/4 x 7 19/32 x 1 11/32	273.1 x 192.9 x 34.1	PA10295
10 13/32 x 5 5/8 x 11/16	264.3 x 142.9 x 17.5	PA4756	10 3/4 x 9 13/16 x 1 27/32	273.1 x 249.2 x 46.8	PA4425
10 13/32 x 7 15/32 x 25/32	264.3 x 189.7 x 19.8	PA10137	10 25/32 x 6 5/8 x 1 21/32	273.8 x 168.3 x 42.1	PA4104
10 13/32 x 7 1/2 x 2 3/32	264.3 x 190.5 x 53.2	PA4477	10 13/16 x 8 1/8 x 25/32	274.6 x 206.4 x 19.8	PA5320
10 13/32 x 8 11/32 x 2 11/16	264.3 x 211.9 x 68.3	PA10310	10 13/16 x 10 x 8 3/32	274.6 x 254.0 x 205.6	PA32001
10 13/32 x 8 3/8 x 1 25/32	264.3 x 212.7 x 45.2	PA4073	10 27/32 x 9 13/32 x 2 7/8	275.1 x 239.0 x 72.9	PA10093
10 7/16 x 7 11/32 x 2 9/32	264.9 x 186.4 x 57.9	PA10107	10 27/32 x 6 17/32 x 1 5/16	275.4 x 165.9 x 33.3	PA10296
10 7/16 x 5 15/32 x 1 1/2	265.1 x 138.9 x 38.1	PA31011	10 27/32 x 7 3/8 x 2 3/32	275.4 x 187.3 x 53.2	PA4345
10 7/16 x 5 3/4 x 1 7/8	265.1 x 146.1 x 47.6	PA4123	10 7/8 x 7 11/32 x 1 15/16	276.1 x 186.4 x 49.5	PA10088
10 7/16 x 6 1/2 x 3/8	265.1 x 165.1 x 9.5	PA30107	10 7/8 x 8 29/32 x 1 9/16	276.1 x 226.1 x 39.9	PA10440
10 7/16 x 6 19/32 x 1 5/16	265.1 x 167.5 x 33.3	PA4114	10 7/8 x 10 9/32 x 1 3/8	276.1 x 261.1 x 34.8	PA10277
10 7/16 x 7 1/8 x 1 7/16	265.1 x 181.0 x 36.5	PA4353	10 7/8 x 6 11/32 x 2 1/8	276.2 x 161.1 x 54.0	PA4193
10 7/16 x 8 21/32 x 1 31/32	265.1 x 219.9 x 50	PA10260	10 7/8 x 7 9/16 x 1 1/4	276.2 x 192.1 x 31.8	PA10172
10 7/16 x 9 7/32 x 15/16	265.1 x 234.2 x 23.8	PA10164	10 7/8 x 7 7/8 x 1 3/16	276.2 x 200.0 x 30.2	PA10043
10 7/16 x 10 13/32 x 1 23/32	265.1 x 264.3 x 43.7	PA4465	10 7/8 x 9 23/32 x 1 25/32	276.2 x 246.9 x 45.2	PA10244
10 15/32 x 6 15/32 x 2	265.9 x 164.3 x 50.8	PA10259	10 7/8 x 6 15/16 x 2 1/4	276.6 x 176.5 x 57.4	PA10409
10 15/32 x 9 29/32 x 1 7/8	265.9 x 251.6 x 47.6	PA4323	10 29/32 x 6 23/32 x 1 15/16	277.0 x 170.7 x 49.2	PA10420
10 15/32 x 9 15/16 x 1 9/16	265.9 x 252.4 x 39.7	PA10264	10 29/32 x 7 3/32 x 1 19/32	277.0 x 180.2 x 40.5	PA4076
10 15/32 x 10 3/16 x 1 15/32	265.9 x 258.8 x 37.3	PA4453	10 29/32 x 7 27/32 x 1 11/16	277.0 x 199.2 x 42.9	PA10044
10 1/2 x 5 3/4 x 2 5/32	266.7 x 146 x 54.8	PA10251	10 29/32 x 8 5/8 x 1 11/32	277.0 x 219.1 x 34.1	PA10018
10 1/2 x 6 23/32 x 1 21/32	266.7 x 170.7 x 42.1	PA2243	10 29/32 x 8 5/8 x 1 11/32	277.0 x 219.1 x 34.1	PA10034
10 1/2 x 7 7/8 x 1 9/16	266.7 x 200.0 x 39.7	PA4146	10 29/32 x 8 15/16 x 1 21/32	277.0 x 227.0 x 42.1	PA10271
10 1/2 x 8 5/16 x 1 1/2	266.7 x 211.1 x 38.1	PA10133	10 29/32 x 8 31/32 x 1 5/8	277.0 x 227.8 x 41.3	PA4476
10 1/2 x 8 1/32 x 1 21/32	267.0 x 204.0 x 41.9	PA10436	10 29/32 x 9 7/8 x 2 23/32	277.0 x 250.8 x 69.1	PA4162
10 17/32 x 2 21/32 x 25/32	267.5 x 67.5 x 19.8	PA10203 KIT	10 15/16 x 7 x 1 1/8	277.8 x 177.8 x 28.6	PA4112
10 17/32 x 6 23/32 x 1 15/16	267.5 x 170.7 x 49.2	PA4417	10 15/16 x 7 7/16 x 1 9/16	277.8 x 188.9 x 39.7	PA5720
10 17/32 x 10 7/16 x 1 31/32	267.5 x 265.1 x 50.0	PA10278	10 15/16 x 8 13/16 x 3/4	277.8 x 223.8 x 19.1	PA4475
10 17/32 x 4 3/8 x 1 13/32	267.7 x 111.5 x 36.1	PA10286	10 15/16 x 8 27/32 x 2 1/32	277.8 x 224.6 x 51.6	PA4431
10 9/16 x 4 11/16 x 1 15/16	268.3 x 119.1 x 49.2	PA10293	10 15/16 x 9 1/8 x 31/32	277.8 x 231.8 x 24.6	PA30000
10 9/16 x 6.21875 x 1 3/16	268.3 x 158 x 30.2	PA10184	10 15/16 x 9 11/32 x 1 15/32	277.8 x 237.3 x 37.0	PA4157
10 9/16 x 6 5/16 x 1 31/32	268.3 x 160.3 x 50.0	PA4175	10 15/16 x 9 29/32 x 4 3/8	277.8 x 251.6 x 111.1	PA4318
10 9/16 x 6 7/8 x 2 3/8	268.3 x 174.6 x 60.3	PA4402	10 15/16 x 9 15/16 x 4 13/32	277.8 x 252.4 x 111.9	PA4458
10 9/16 x 7 9/32 x 2 1/8	268.3 x 184.9 x 54.0	PA10379	10 31/32 x 7 1/4 x 2 1/32	278.4 x 183.9 x 51.6	PA10222
10 9/16 x 8 1/4 x 8 1/16	268.3 x 209.6 x 204.8	PA1774	10 31/32 x 7 3/8 x 1 23/32	278.6 x 187.3 x 43.7	PA10235
10 9/16 x 8 21/32 x 2 1/32	268.3 x 219.9 x 51.6	PA4374	10 31/32 x 7 1/16 x 1 3/4	278.9 x 179.1 x 44.4	PA10221
10 9/16 x 8 3/4 x 2 1/8	268.3 x 222.3 x 54.0	PA10237	10 31/32 x 9 9/16 x 25/32	278.9 x 243.1 x 19.6	PA10099
10 9/16 x 8 3/4 x 2 1/8	268.3 x 222.3 x 54.0	PA10265			
10 9/16 x 8 29/32 x 1 7/8	268.3 x 226.2 x 47.6	PA10240	11 x 7 1/4 x 2 11/32	279.4 x 184.2 x 59.5	PA10316
10 9/16 x 9 31/32 x 1 7/32	268.3 x 253.2 x 31.0	PA4133	11 x 8 5/8 x 1 23/32	279.4 x 219.1 x 43.7	PA10223
10 9/16 x 10 9/16 x 8 1/8	268.3 x 268.3 x 206.4	PA1776	11 x 11 x 2 3/16	279.4 x 279.4 x 55.6	PA2497
10 19/32 x 7 1/2 x 31/32	"269.0 x 190.5 x 24.6"	PA10282	11 11/32 x 10 29/32 x 2 27/32	279.9 x 277.1 x 71.9	PA10095
10 19/32 x 3 9/16 x 1 3/32	269.1 x 90.5 x 27.8	PA5698	11 1/32 x 6 5/16 x 1 25/32	280.2 x 160.3 x 45.2	PA5666
10 19/32 x 7 9/32 x 1 21/32	269.1 x 187.9 x 42.1	PA4484	11 1/32 x 9 1/2 x 1 1/16	280.2 x 241.3 x 27.0	PA10239
10 19/32 x 7 7/8 x 1 21/32	269.1 x 200.0 x 42.1	PA2189	11 1/32 x 10 x 1 3/8	280.2 x 254.0 x 34.9	PA10143
10 19/32 x 8 5/8 x 1 15/32	269.1 x 219.1 x 38.9	PA10394	11 1/16 x 6 9/16 x 1 5/16	281.0 x 166.7 x 33.3	PA2135
10 19/32 x 10 19/32 x 3/4	269.1 x 269.1 x 19.1	PA5319	11 1/16 x 9 7/32 x 2 1/16	281.0 x 234.2 x 52.4	PA10233
10 5/8 x 4 3/4 x 2 7/32	269.9 x 120.7 x 56.4	PA5774	11 1/16 x 9 21/32 x 3/4	281.0 x 245.3 x 19.1	PA10031
10 5/8 x 5 21/32 x 1 7/32	269.9 x 143.7 x 31	PA10247	11 1/16 x 10 9/16 x 13/16	281.0 x 268.3 x 17.5	PA4444
10 5/8 x 6 3/32 x 1 3/8	269.9 x 154.8 x 34.9	PA2121	11 3/32 x 5 3/8 x 1 11/16	281.8 x 136.5 x 42.9	PA10224
10 5/8 x 7 3/32 x 1 3/8	269.9 x 180.2 x 35.1	PA10040	11 3/32 x 7 1/8 x 2 9/32	281.8 x 181.0 x 57.9	PA4793
10 5/8 x 7 13/32 x 1 25/32	269.9 x 188.1 x 45.2	PA3414	11 3/32 x 8 3/16 x 1 3/16	281.8 x 208.0 x 30.2	PA4331
10 5/8 x 7 17/32 x 1 31/32	269.9 x 191.3 x 50.0	PA4387	11 1/8 x 6 25/32 x 25/32	282.6 x 172.2 x 19.8	PA5321
10 5/8 x 7 13/16 x 7/8	269.9 x 198.4 x 22.2	PA10160	11 1/8 x 7 1/2 x 2	282.6 x 190.5 x 50.8	PA10047
10 5/8 x 9 1/16 x 1 3/16	269.9 x 230.2 x 30.2	PA5516	11 1/8 x 8 13/16 x 5 1/4	282.6 x 223.8 x 57.2	PA4397
10 5/8 x 9 7/16 x 25/32	269.9 x 239.7 x 19.8	PA10181	11 1/8 x 8 15/16 x 2 21/32	282.6 x 227.0 x 67.5	CV15000
10 5/8 x 9 7/16 x 1	269.9 x 239.7 x 25.4	PA4169	11 3/16 x 8 15/16 x 1 7/8	284.2 x 227.0 x 47.6	PA4451
10 5/8 x 10 5/8 x 31/32	269.9 x 269.9 x 24.6	PA4857	11 3/16 x 9 1/4 x 2 5/32	284.2 x 235.3 x 54.8	PA10387
10 21/32 x 4 1/4 x 15/16	270.7 x 108.0 x 23.8	PA10216 KIT	11 3/16 x 9 15/16 x 1 9/16	284.2 x 252.4 x 39.7	PA4485
10 21/32 x 11 23/32 x 2 1/8	270.7 x 297.7 x 54.0	PA10232	11 3/16 x 9 15/16 x 1 11/16	284.2 x 252.4 x 42.9	PA4487
10 11/16 x 8 13/32 x 1 5/8	271.0 x 213.0 x 41.0	PA10091	11 3/16 x 10 3/16 x 2 9/32	284.2 x 258.8 x 57.9	PA10033
10 11/16 x 5 31/32 x 1 15/32	271.5 x 151.4 x 37.6	PA10388	11 3/16 x 10 3/16 x 3 5/16	284.2 x 258.8 x 84.1	PA10197
10 11/16 x 10 3/32 x 1 9/16	271.5 x 256.4 x 39.7	PA10015	11 3/16 x 10 5/16 x 1 9/32	284.2 x 261.9 x 32.5	PA10319
10 23/32 x 10 1/32 x 1 7/8	272.0 x 255.0 x 48.0	PA10063	11 7/32 x 6 1/8 x 1 7/32	285.0 x 155.6 x 31.0	PA2150
10 23/32 x 4 3/32 x 1 3/32	272.3 x 104.0 x 27.8	PA5650	11 7/32 x 6 11/32 x 1 5/8	285.0 x 161.1 x 41.3	PA4303



WARNING: These products can expose you to chemicals, including Diisononyl Phthalate, Carbon black extracts, Nickel, 1,3 Butadiene, Ethylene Oxide, Epichlorohydrin, which are known to the State of California to cause cancer, and Bisphenol-A, Ethylene Glycol, Ethylene Oxide, 1,3 Butadiene, Epichlorohydrin, which are known to the State of California to cause birth defects or other reproductive harm. For more information go to www.P65Warnings.ca.gov.

PANEL AIR FILTERS

LENGTH x WIDTH x THICK Inches	LENGTH x WIDTH x THICK (mm)	BALDWIN NUMBER	LENGTH x WIDTH x THICK Inches	LENGTH x WIDTH x THICK (mm)	BALDWIN NUMBER
11 7/32 x 7 x 29/32	285.0 x 177.8 x 23.0	PA30127	11 5/8 x 9 1/32 x 1 1/2	295.3 x 229.4 x 38.1	PA10326
11 7/32 x 7 17/32 x 1 25/32	285.0 x 191.3 x 45.2	PA2152	11 5/8 x 9 1/32 x 1 1/2	295.3 x 229.4 x 38.1	PA10329
11 7/32 x 8 3/16 x 1 13/16	285.2 x 208.0 x 46.0	PA30263	11 5/8 x 9 7/32 x 1 7/8	295.3 x 234.2 x 47.6	PA10283
11 1/4 x 6 13/32 x 2 9/16	285.8 x 162.7 x 65.1	PA4129	11 5/8 x 10 3/8 x 25/32	295.3 x 263.5 x 19.8	PA4304
11 1/4 x 6 19/32 x 1 21/32	285.8 x 167.5 x 42.1	PA2237	11 21/32 x 6 5/8 x 1 1/2	295.9 x 167.9 x 38.1	PA30268
11 1/4 x 8 5/8 x 29/32	285.8 x 219.1 x 23.0	PA4330	11 21/32 x 6 23/32 x 2 7/32	296.1 x 170.7 x 56.4	PA10304
11 1/4 x 8 29/32 x 1 17/32	285.8 x 226.2 x 38.9	PA10330	11 21/32 x 8 13/16 x 7/8	296.1 x 223.8 x 22.2	PA4384
11 9/32 x 6 15/32 x 2 3/32	286.5 x 164.3 x 53.2	PA10230	11 21/32 x 8 15/16 x 1 23/32	296.1 x 227.0 x 43.7	PA10241
11 9/32 x 8 29/32 x 1 19/32	286.5 x 226.2 x 40.5	PA2149	11 21/32 x 9 3/8 x 1 5/16	296.1 x 238.1 x 33.3	PA4341
11 9/32 x 8 15/16 x 1 29/32	286.5 x 227.0 x 48.4	PA3822	11 11/16 x 8 1/2 x 1 11/16	296.9 x 215.9 x 42.9	PA10080
11 9/32 x 9 13/16 x 2 23/32	286.5 x 249.2 x 69.1	PA4467	11 23/32 x 9 11/32 x 2	297.4 x 237.5 x 50.5	PA10413
11 5/16 x 5 29/32 x 2 7/32	287.3 x 150.0 x 56.4	PA10383	11 23/32 x 5 11/32 x 1 27/32	297.7 x 135.7 x 46.3	PA4183
11 5/16 x 8 3/8 x 1 19/32	287.3 x 212.7 x 40.5	PA10341	11 23/32 x 5 7/8 x 1 23/32	297.7 x 149.2 x 43.7	PA10268
11 5/16 x 10 x 1 25/32	287.3 x 254.0 x 45.2	PA10001	11 23/32 x 10 31/32 x 14 1/16	297.7 x 278.6 x 357.2	PA31000
11 5/16 x 10 1/2 x 1 1/2	287.3 x 266.7 x 38.1	PA31001	11 25/32 x 10 7/32 x 2 9/16	299.2 x 259.6 x 65.1	PA10045
11 11/32 x 10 31/32 x 1 1/2	288.0 x 278.9 x 38.1	PA10425	11 13/16 x 5 5/8 x 2 9/32	300.0 x 143.0 x 57.9	PA10441
11 11/32 x 3 15/32 x 25/32	288.1 x 88.1 x 19.8	PA5405	11 13/16 x 6 7/8 x 1 19/32	300.0 x 174.6 x 40.5	PA4351
11 11/32 x 6 5/8 x 1 7/16	288.1 x 168.3 x 36.5	PA5624	11 13/16 x 7 3/16 x 2 29/32	300.0 x 182.6 x 73.8	PA4464
11 11/32 x 7 1/4 x 1 1/16	288.1 x 184.2 x 27.0	PA4192	11 13/16 x 7 15/32 x 1 25/32	300.0 x 189.7 x 45.2	PA5511
11 11/32 x 8 15/32 x 1 13/32	288.1 x 215.1 x 35.7	PA4167	11 13/16 x 7 17/32 x 25/32	300.0 x 191.3 x 19.8	PA30156
11 3/8 x 9 1/32 x 31/32	288.5 x 229.1 x 24.9	PA10214	11 13/16 x 8 1/16 x 1 3/16	300.0 x 204.4 x 30.2	PA10189
11 3/8 x 5 1/16 x 15/16	288.9 x 128.6 x 23.8	PA4152	11 13/16 x 9 13/16 x 1 1/16	300.0 x 249.2 x 27.0	PA4652
11 3/8 x 5 29/32 x 2	288.9 x 150.0 x 50.8	PA4180	11 13/16 x 10 3/4 x 2 3/16	300.0 x 273.1 x 55.6	PA3823
11 3/8 x 6 15/32 x 1 5/8	288.9 x 164.3 x 41.3	PA4190	11 13/16 x 10 25/32 x 2 11/16	300.0 x 273.8 x 68.3	PA3763
11 3/8 x 6 9/16 x 3/8	288.9 x 166.7 x 9.5	PA5662	11 13/16 x 11 7/32 x 17/32	300.0 x 285.0 x 14.0	PA5691
11 3/8 x 9 3/8 x 2 3/32	288.9 x 238.1 x 53.2	PA4429	11 27/32 x 5 1/4 x 1 9/16	300.8 x 133.4 x 39.7	PA10208 KIT
11 3/8 x 9 3/4 x 1 15/32	288.9 x 247.7 x 37.3	PA4046	11 27/32 x 6 7/8 x 1 27/32	300.8 x 174.6 x 46.8	PA4434
11 3/8 x 10 1/4 x 29/32	288.9 x 260.4 x 23.0	PA10153	11 27/32 x 9 x 1 15/32	300.8 x 228.6 x 37.3	PA4481
11 3/8 x 10 1/4 x 29/32	288.9 x 260.4 x 23.0	PA10200	11 7/8 x 4 7/16 x 1 5/8	301.6 x 112.7 x 41.3	PA10313
11 3/8 x 10 7/16 x 6 19/32	288.9 x 265.1 x 167.5	PA31010	11 7/8 x 6 5/16 x 1 23/32	301.6 x 160.3 x 43.7	PA10248
11 3/8 x 11 3/8 x 1 3/32	288.9 x 288.9 x 27.8	PA10023	11 7/8 x 7 29/32 x 1 1/4	301.6 x 200.8 x 31.8	PA30114
11 3/8 x 11 3/8 x 1 3/4	288.9 x 288.9 x 44.5	PA4975	11 29/32 x 6 23/32 x 1 7/8	302.4 x 170.7 x 47.6	PA10026
11 3/8 x 10 27/32 x 2 9/32	289.1 x 275.1 x 57.9	PA10075	11 29/32 x 8 15/32 x 1 13/32	302.4 x 215.1 x 35.7	PA4312
11 13/32 x 4 23/32 x 1 23/32	289.7 x 119.9 x 43.7	PA3986	11 29/32 x 8 7/8 x 2 5/16	302.4 x 225.4 x 58.7	PA10302
11 13/32 x 6 1/8 x 1 1/8	289.7 x 155.6 x 28.6	PA10038	11 15/16 x 5 7/16 x 7/8	303.2 x 138.1 x 22.2	PA5318
11 13/32 x 6 5/16 x 1 3/16	289.7 x 160.3 x 30.2	PA4954	11 15/16 x 7 1/8 x 1 7/8	303.2 x 181.0 x 47.6	PA10006
11 13/32 x 7 19/32 x 1 31/32	289.7 x 192.9 x 50.0	PA4338	11 15/16 x 7 23/32 x 1 5/16	303.2 x 196.1 x 33.3	PA4423
11 13/32 x 10 3/16 x 1 11/16	289.7 x 258.8 x 42.9	PA10291	11 15/16 x 7 29/32 x 1 5/8	303.2 x 200.8 x 41.3	PA10072
11 7/16 x 10 5/32 x 2 1/16	290.5 x 258.0 x 52.4	PA10345	11 31/32 x 5 1/8 x 25/32	304.0 x 130.2 x 19.8	PA10215 KIT
11 15/32 x 6 15/16 x 2 5/8	291.1 x 176.0 x 67.1	PA10102	11 31/32 x 6 9/32 x 2 1/8	304.0 x 159.5 x 54.0	PA4413
11 15/32 x 8 7/8 x 1 1/4	291.1 x 225.0 x 32.0	PA10078	11 31/32 x 6 11/16 x 1 3/4	304.0 x 169.9 x 44.5	PA4321
11 15/32 x 5 3/32 x 1 13/16	291.3 x 129.4 x 46.0	PA4932	11 31/32 x 8 21/32 x 1/2	304.0 x 219.9 x 12.7	PA10017
11 15/32 x 7 11/32 x 1 5/32	291.3 x 186.5 x 29.4	PA4154	11 31/32 x 9 15/16 x 2 23/32	304.0 x 252.4 x 69.1	PA3897
11 15/32 x 8 5/16 x 1 19/32	291.3 x 211.1 x 40.5	PA4179	11 31/32 x 10 7/16 x 3	304.0 x 264.9 x 51.1	PA10094
11 15/32 x 8 11/32 x 1 1/2	291.3 x 211.9 x 38.1	PA4177			
11 15/32 x 9 1/16 x 2 5/16	291.3 x 230.2 x 58.7	PA4367	12 x 3 15/16 x 1 5/32	304.8 x 100.0 x 29.4	PA10196 KIT
11 1/2 x 6 31/32 x 2 3/4	292.1 x 177.0 x 70.1	PA10089	12 x 7 13/16 x 3/4	304.8 x 198.4 x 19.1	PA4986
11 1/2 x 6 31/32 x 3 5/32	292.1 x 177.0 x 80.2	PA10327	12 x 9 1/16 x 2 9/32	304.8 x 230.2 x 57.9	PA10317
11 1/2 x 7 1/32 x 1 21/32	292.1 x 178.6 x 42.1	PA2196	12 1/32 x 7 17/32 x 4	305.6 x 191.3 x 101.6	PA10246
11 1/2 x 7 3/32 x 2 1/4	292.1 x 180.2 x 57.2	PA4147	12 1/16 x 4 1/32 x 2 7/16	306.4 x 102.4 x 61.9	PA5739
11 1/2 x 7 5/16 x 1 3/32	292.1 x 185.7 x 27.8	PA10161	12 1/16 x 5 7/8 x 2 9/32	306.4 x 149.2 x 57.9	PA10332
11 1/2 x 8 3/16 x 1 23/32	292.1 x 208.0 x 43.7	PA4437	12 1/16 x 7 9/32 x 2 1/8	306.4 x 184.9 x 54.0	PA4077
11 1/2 x 9 1/4 x 1 5/8	292.1 x 235.0 x 41.3	PA10386	12 1/16 x 7 5/8 x 2 9/32	306.4 x 193.7 x 57.9	PA10024
11 17/32 x 6 1/32 x 1 5/8	292.9 x 153.2 x 41.3	PA2257	12 3/32 x 3 5/32 x 31/32	307.0 x 80.0 x 24.5	PA30281
11 17/32 x 7 9/16 x 1 3/16	292.9 x 192.1 x 30.2	PA5475	12 3/32 x 4 7/32 x 1 3/16	307.2 x 107.2 x 30.2	PA5768
11 17/32 x 7 7/8 x 1 11/16	292.9 x 200.0 x 42.9	PA4350	12 1/8 x 7 1/4 x 1 15/16	308.0 x 184.2 x 49.2	PA10315
11 9/16 x 6 1/2 x 1 7/8	293.7 x 165.1 x 47.6	PA10058	12 1/8 x 7 27/32 x 1 11/16	308.0 x 199.2 x 42.9	PA4081
11 9/16 x 6 31/32 x 31/32	293.7 x 177.0 x 24.6	PA30110	12 5/32 x 7 7/16 x 1 17/32	308.6 x 189.0 x 38.6	PA10069
11 9/16 x 10 x 1 17/32	293.8 x 254.0 x 38.5	PA10087	12 5/32 x 6 1/8 x 1 21/32	308.8 x 155.6 x 42.1	PA2041
11 9/16 x 9 21/32 x 1 3/8	293.9 x 245.1 x 35.1	PA10381	12 5/32 x 12 19/32 x 1 25/32	308.8 x 319.9 x 45.2	PA4170
11 19/32 x 3 3/4 x 1 3/16	294.5 x 95.3 x 30.2	PA4416 KIT	12 5/32 x 7 1/32 x 2 9/32	309.1 x 178.6 x 57.9	PA10410
11 19/32 x 9 3/32 x 1 13/16	294.5 x 231.0 x 46.0	PA10311	12 5/32 x 8 5/16 x 1 3/16	309.1 x 211.1 x 30.0	PA4174
11 5/8 x 5 9/32 x 2 3/32	295.3 x 134.1 x 53.2	PA4078	12 3/16 x 4 1/32 x 1 11/16	309.6 x 102.4 x 42.9	PA30252
11 5/8 x 6 7/16 x 2	295.3 x 163.5 x 50.8	PA10254	12 3/16 x 6 1/8 x 15/16	309.6 x 155.6 x 23.8	PA10314
11 5/8 x 6 7/8 x 1 5/8	295.3 x 174.6 x 41.3	PA10073	12 3/16 x 7 1/16 x 25/32	309.6 x 179.4 x 19.8	PA4394
11 5/8 x 7 3/32 x 1 23/32	295.3 x 180.2 x 43.7	PA4337	12 3/16 x 7 3/8 x 1 11/16	309.6 x 187.3 x 42.9	PA4028
11 5/8 x 7 3/16 x 2 7/16	295.3 x 182.6 x 61.9	PA10385	12 3/16 x 9 1/4 x 1 15/32	309.6 x 235.0 x 37.3	PA10344
11 5/8 x 8 5/16 x 1 3/8	295.3 x 211.1 x 34.9	PA10234	12 3/16 x 9 17/32 x 2 3/16	309.6 x 242.1 x 55.6	PA30004
11 5/8 x 8 29/32 x 2 1/4	295.3 x 226.2 x 57.2	PA10288	12 7/32 x 6 17/32 x 1 3/4	310.4 x 165.9 x 44.5	PA4181



WARNING: These products can expose you to chemicals, including Diisononyl Phthalate, Carbon black extracts, Nickel, 1,3 Butadiene, Ethylene Oxide, Epichlorohydrin, which are known to the State of California to cause cancer, and Bisphenol-A, Ethylene Glycol, Ethylene Oxide, 1,3 Butadiene, Epichlorohydrin, which are known to the State of California to cause birth defects or other reproductive harm. For more information go to www.P65Warnings.ca.gov.

PANEL AIR FILTERS

LENGTH x WIDTH x THICK Inches	LENGTH x WIDTH x THICK (mm)	BALDWIN NUMBER	LENGTH x WIDTH x THICK Inches	LENGTH x WIDTH x THICK (mm)	BALDWIN NUMBER
12 7/32 x 9 7/32 x 29/32	310.4 x 234.2 x 23.0	PA4159	12 25/32 x 7 5/8 x 1 19/32	324.6 x 193.7 x 40.5	PA4107
12 1/4 x 6 5/32 x 1 3/16	311.2 x 156.4 x 30.2	PA5679	12 13/16 x 6 1/32 x 2 9/32	325.4 x 153.2 x 57.9	PA5317
12 1/4 x 7 1/4 x 2 7/32	311.2 x 184.2 x 56.4	PA10398	12 13/16 x 7 7/8 x 2 3/16	325.4 x 200.0 x 55.6	PA10212 KIT
12 1/4 x 9 1/8 x 2 1/16	311.2 x 231.8 x 52.4	PA4127	12 13/16 x 10 9/16 x 8 5/32	325.4 x 268.3 x 207.2	PA1778
12 1/4 x 9 9/16 x 2 9/16	311.2 x 242.9 x 65.1	PA3781	12 13/16 x 11 1/32 x 2 5/32	325.4 x 280.2 x 54.8	PA10354
12 1/4 x 9 31/32 x 1 3/4	311.2 x 253.2 x 44.5	PA5766	12 27/32 x 5 25/32 x 2 1/8	326.2 x 146.8 x 54.0	PA4355
12 1/4 x 10 11/16 x 1 11/32	311.2 x 271.5 x 34.1	PA10207	12 27/32 x 5 7/8 x 1 21/32	326.2 x 149.2 x 42.1	PA2164
12 1/4 x 11 x 1 1/8	311.2 x 279.4 x 28.6	PA10390	12 27/32 x 6 5/8 x 1 1/4	326.2 x 168.3 x 31.8	PA4362
12 9/32 x 7 9/16 x 2 7/16	311.9 x 192.1 x 61.9	PA5331	12 7/8 x 5 17/32 x 1 23/32	327.0 x 140.5 x 43.7	PA4385
12 9/32 x 9 23/32 x 2 5/16	311.9 x 246.9 x 58.7	PA4113	12 7/8 x 7 21/32 x 1 7/8	327.0 x 194.5 x 47.6	PA10384
12 9/32 x 9 23/32 x 2 5/16	311.9 x 246.9 x 58.7	PA4134	12 7/8 x 12 x 2 9/16	327.0 x 304.8 x 65.1	PA3803
12 9/32 x 10 x 2	311.9 x 254.0 x 50.8	PA4412	12 29/32 x 3 17/32 x 1/2	327.8 x 89.7 x 12.7	PA5727
12 9/32 x 10 1/16 x 1 13/16	311.9 x 255.6 x 46.0	PA5482	12 29/32 x 5 27/32 x 1 19/32	327.8 x 148.4 x 40.5	PA4306
12 9/32 x 10 1/8 x 1 15/32	311.9 x 257.2 x 37.3	PA10393	12 29/32 x 10 3/32 x 1 17/32	327.8 x 256.4 x 38.9	PA30007
12 5/16 x 6 1/32 x 1 11/32	312.7 x 153.2 x 34.1	PA10169	12 15/16 x 5 7/8 x 1 31/32	328.6 x 149.2 x 50.0	PA10228
12 5/16 x 6 23/32 x 3 5/16	312.7 x 170.7 x 84.1	PA4171	12 15/16 x 10 7/16 x 2 23/32	328.6 x 265.1 x 69.1	PA4723
12 5/16 x 6 15/16 x 1 27/32	312.7 x 176.2 x 46.8	PA4360	12 15/16 x 8 15/32 x 2 1/4	328.7 x 215.1 x 57.2	PA10292
12 5/16 x 8 27/32 x 1 7/16	312.7 x 224.6 x 36.5	PA30122	12 31/32 x 9 15/32 x 2 1/32	329.4 x 240.5 x 51.6	PA10060
12 5/16 x 8 27/32 x 1 7/16	312.7 x 224.6 x 36.5	PA30123			
12 5/16 x 8 27/32 x 1 7/16	312.7 x 224.6 x 36.5	PA30124			
12 11/32 x 4 x 1 5/8	313.5 x 101.6 x 41.3	PA4319	13 x 5 7/8 x 2 3/16	330.2 x 149.2 x 55.6	PA2235
12 11/32 x 5 7/32 x 2 1/4	313.5 x 132.6 x 57.2	PA4399	13 x 7 x 1/2	330.2 x 177.8 x 12.5	PA3931
12 3/8 x 11 3/8 x 2 7/32	313.9 x 288.9 x 56.4	PA10427	13 x 7 11/32 x 1 11/32	330.2 x 186.5 x 26.2	PA10368
12 3/8 x 5 3/4 x 1 7/8	314.3 x 146.1 x 47.6	PA10305	13 x 8 1/2 x 2 9/32	330.2 x 215.9 x 57.9	PA4359
12 3/8 x 6 3/16 x 2 23/32	314.3 x 157.2 x 69.1	PA4090	13 x 9 1/2 x 2 29/32	330.2 x 241.3 x 73.8	PA4466
12 3/8 x 7 29/32 x 1 3/8	314.3 x 200.8 x 34.9	PA10219	13 1/16 x 6 5/32 x 1 21/32	331.8 x 156.4 x 42.1	PA10358
12 13/32 x 11 3/8 x 3	315.0 x 288.9 x 75.9	PA10428	13 1/16 x 6 15/32 x 1 15/32	331.8 x 164.3 x 37.3	PA2181
12 13/32 x 7 15/32 x 2 5/16	315.1 x 189.7 x 58.7	PA10308	13 1/16 x 7 19/32 x 1 3/16	331.8 x 192.9 x 30.2	PA10140
12 13/32 x 10 7/8 x 2 25/32	315.1 x 276.2 x 70.6	PA4600	13 3/32 x 5 3/8 x 1 3/8	332.6 x 136.5 x 34.9	PA10218
12 13/32 x 10 7/8 x 3 3/16	315.1 x 276.2 x 81.0	PA4601	13 1/8 x 6 13/32 x 1 3/16	334.0 x 162.7 x 30.2	PA10177
12 7/16 x 7 1/32 x 1 7/16	315.9 x 178.6 x 36.5	PA2230	13 1/8 x 6 15/16 x 1 25/32	334.0 x 175.2 x 45.2	PA4377
12 7/16 x 7 1/16 x 2 5/32	315.9 x 179.4 x 54.8	PA5632	13 3/16 x 5 11/32 x 1 21/32	335.0 x 135.7 x 42.1	PA2101A
12 7/16 x 11 11/16 x 2	315.9 x 296.9 x 50.8	PA4322	13 3/16 x 6 1/16 x 2	335 x 154 x 50.8	PA10258
12 15/32 x 10 9/32 x 2 17/32	316.7 x 261.1 x 64.3	PA30149	13 3/16 x 9 3/8 x 1 9/16	335.0 x 238.0 x 39.9	PA10098
12 1/2 x 6 1/2 x 1 3/4	317.5 x 165.1 x 44.5	PA3900	13 7/32 x 6 17/32 x 2 1/8	335.8 x 165.9 x 24.0	PA4369
12 1/2 x 7 1/16 x 1 7/16	317.5 x 179.4 x 36.5	PA4659	13 7/32 x 7 15/32 x 1 1/4	335.8 x 189.7 x 31.8	PA10298
12 17/32 x 7 1/16 x 1 5/8	318.3 x 179.4 x 41.3	PA5669	13 7/32 x 7 15/32 x 2 1/4	335.8 x 189.7 x 57.2	PA10229
12 17/32 x 7 19/32 x 1 11/16	318.3 x 192.9 x 42.9	PA4150	13 1/4 x 4 x 2 9/16	336.6 x 101.6 x 65.1	PA3828
12 9/16 x 6 1/2 x 1 7/16	319.1 x 165.1 x 36.5	PA5652	13 1/4 x 7 1/16 x 2 19/32	336.6 x 179.4 x 65.9	PA4110
12 9/16 x 8 x 3 1/16	319.1 x 203.2 x 77.8	PA5656	13 1/4 x 11 15/16 x 13/16	336.6 x 303.2 x 20.6	PA3482
12 19/32 x 5 1/8 x 1 7/8	319.9 x 130.2 x 47.6	PA30006	13 9/32 x 8 21/32 x 2 13/16	337.3 x 219.9 x 71.4	PA5621
12 19/32 x 5 29/32 x 1 5/8	319.9 x 150.0 x 41.3	PA2200	13 5/16 x 6 23/32 x 1 17/32	338.1 x 170.7 x 38.9	PA4124
12 19/32 x 5 31/32 x 2 9/32	319.9 x 151.6 x 57.9	PA4888	13 5/16 x 9 1/4 x 1 23/32	338.1 x 235.0 x 43.7	PA10273
12 19/32 x 6 1/2 x 1 7/8	319.9 x 165.1 x 47.6	PA5580	13 5/16 x 12 7/16 x 1 5/16	338.1 x 316.0 x 33.5	PA10406
12 19/32 x 6 21/32 x 1 15/16	319.9 x 169.1 x 49.2	PA30005	13 11/32 x 9 3/32 x 5/8	338.9 x 231.0 x 15.9	PA5765
12 19/32 x 6 15/16 x 1 27/32	319.9 x 176.2 x 46.8	PA4310	13 3/8 x 7 1/4 x 2 5/16	339.7 x 184.27 x 58.7	PA4120
12 19/32 x 7 1/4 x 31/32	319.9 x 184.2 x 24.6	PA4985	13 3/8 x 7 5/16 x 3 13/32	339.7 x 185.7 x 86.5	PA4148
12 19/32 x 7 3/4 x 1 15/32	319.9 x 196.9 x 37.3	PA4182	13 3/8 x 12 13/16 x 25/32	339.7 x 325.4 x 19.8	PA5690
12 19/32 x 9 11/32 x 1 13/32	319.9 x 237.3 x 35.7	PA4121	13 3/8 x 9 1/8 x 3	340.1 x 231.9 x 75.9	PA10426
12 19/32 x 9 11/32 x 2 7/16	319.9 x 237.3 x 61.9	PA4435	13 7/16 x 5 15/16 x 1 25/32	341.3 x 150.8 x 45.2	PA4191
12 19/32 x 9 1/2 x 2 1/16	319.9 x 241.3 x 52.4	PA4356	13 7/16 x 8 3/8 x 25/32	341.3 x 212.7 x 19.8	PA4682
12 19/32 x 10 5/8 x 5/8	319.9 x 269.9 x 15.9	PA3825	13 15/32 x 10 7/8 x 1 1/4	341.9 x 276.1 x 31.8	PA4358
12 19/32 x 8 3/4 x 2 9/32	320.0 x 222.0 x 57.9	PA10096	13 15/32 x 10 19/32 x 2 3/16	342.1 x 269.1 x 55.6	PA30183
12 5/8 x 5 x 2 17/32	320.7 x 127.0 x 64.3	PA10285	13 1/2 x 6 1/4 x 1 5/16	342.9 x 158.8 x 33.3	PA4092
12 5/8 x 6 11/32 x 2 15/16	321.1 x 161.1 x 74.6	PA4106	13 1/2 x 6 21/32 x 1 11/16	342.9 x 169.1 x 42.9	PA10331
12 5/8 x 6 11/16 x 2 15/32	321.1 x 169.9 x 63.0	PA10101	13 17/32 x 6 21/32 x 1 19/32	343.7 x 169.1 x 40.5	PA2163
12 21/32 x 5 5/16 x 1 7/8	321.5 x 134.9 x 47.6	PA10324	13 9/16 x 5 11/32 x 2 25/32	344.5 x 135.7 x 70.6	PA4428
12 21/32 x 8 9/32 x 1 9/16	321.5 x 210.3 x 39.7	PA10236	13 19/32 x 4 3/4 x 2 1/4	344.9 x 120.9 x 56.9	PA30249
12 21/32 x 9 1/4 x 15/16	321.5 x 235.0 x 23.8	PA4612	13 19/32 x 10 3/16 x 2 9/16	344.9 x 259.1 x 65.0	PA10106
12 11/16 x 9 3/4 x 2 9/32	322.1 x 247.4 x 57.9	PA10416	13 5/8 x 6 13/32 x 1 15/16	346.1 x 162.7 x 49.2	PA10284
12 11/16 x 9 3/4 x 3 1/16	322.1 x 247.4 x 78.0	PA10417	13 5/8 x 8 25/32 x 1 31/32	346.1 x 223.0 x 50.0	PA4396
12 11/16 x 6 7/32 x 1 19/32	322.3 x 158.0 x 40.5	PA10263	13 21/32 x 10 1/32 x 19/32	346.9 x 254.8 x 15.1	PA5637
12 11/16 x 6 15/16 x 1 3/16	322.3 x 176.2 x 30.2	PA10198 KIT	13 11/16 x 5 11/16 x 9/16	347.7 x 144.5 x 14.3	PA5778
12 23/32 x 5 27/32 x 2 7/32	323.1 x 148.4 x 56.4	PA5770	13 11/16 x 10 1/32 x 25/32	347.7 x 254.8 x 19.8	PA5694
12 23/32 x 6 3/32 x 2 5/16	323.1 x 154.8 x 58.7	PA4785	13 11/16 x 10 1/16 x 25/32	347.7 x 255.6 x 19.8	PA10158
12 3/4 x 4 7/8 x 1 7/32	323.9 x 123.8 x 31.0	PA4714	13 3/4 x 4 5/32 x 1 19/32	349.3 x 105.6 x 40.5	PA2218
12 3/4 x 9 23/32 x 1 25/32	323.9 x 246.9 x 45.2	PA4456	13 3/4 x 5 3/16 x 2 5/16	349.3 x 131.8 x 58.7	PA2234
12 3/4 x 10 1/16 x 1 31/32	323.9 x 255.6 x 50.0	PA10335	13 3/4 x 8 21/32 x 1 3/16	349.3 x 219.9 x 30.2	PA10142
12 3/4 x 11 9/16 x 1 1/8	323.9 x 293.7 x 28.6	PA4681	13 3/4 x 9 3/32 x 1 21/32	349.3 x 231.0 x 42.1	PA10077
12 3/4 x 2 5/8 x 1 3/16	324.1 x 67.1 x 30.2	PA30255	13 3/4 x 9 11/32 x 1 15/16	349.3 x 237.3 x 49.2	PA4151
			13 25/32 x 8 3/8 x 1 23/32	350.0 x 212.6 x 43.9	PA30329



WARNING: These products can expose you to chemicals, including Diisononyl Phthalate, Carbon black extracts, Nickel, 1,3 Butadiene, Ethylene Oxide, Epichlorohydrin, which are known to the State of California to cause cancer, and Bisphenol-A, Ethylene Glycol, Ethylene Oxide, 1,3 Butadiene, Epichlorohydrin, which are known to the State of California to cause birth defects or other reproductive harm. For more information go to www.P65Warnings.ca.gov.

PANEL AIR FILTERS

LENGTH x WIDTH x THICK Inches	LENGTH x WIDTH x THICK (mm)	BALDWIN NUMBER	LENGTH x WIDTH x THICK Inches	LENGTH x WIDTH x THICK (mm)	BALDWIN NUMBER
13 25/32 x 9 1/8 x 2 1/16	350.0 x 231.4 x 52.1	PA10430	15 1/32 x 5 3/16 x 1 3/16	382.0 x 32.1 x 30.0	PA30332
13 25/32 x 9 3/8 x 1 31/32	350.0 x 238.0 x 50.0	PA10438	15 1/16 x 7 9/32 x 1 5/16	382.6 x 184.9 x 33.3	PA4422
13 13/16 x 7 9/32 x 2 3/16	350.8 x 184.9 x 55.6	PA2244	15 1/8 x 5 25/32 x 1 31/32	383.8 x 146.6 x 50.3	PA31009
13 7/8 x 4 29/32 x 2 9/32	352.4 x 124.6 x 57.9	PA4316	15 1/8 x 6 11/16 x 2 1/8	384.0 x 169.9 x 54.1	PA30253
13 7/8 x 9 x 1 1/4	352.4 x 228.6 x 31.8	PA4439	15 1/8 x 6 5/32 x 15 31/32	384.2 x 156.2 x 405.9	PA31015
13 7/8 x 9 3/8 x 2 9/32	352.4 x 238.1 x 57.9	PA10022	15 1/4 x 7 5/16 x 2 3/8	384.7 x 185.7 x 60.3	PA10340
13 7/8 x 10 3/32 x 7/8	352.4 x 256.4 x 22.2	PA5306	15 5/32 x 5 1/4 x 1 5/8	385.0 x 133.4 x 41.3	PA10325
13 29/32 x 5 1/4 x 1 3/4	353.2 x 133.4 x 44.5	PA4440 KIT	15 5/32 x 5 23/32 x 13/32	385.0 x 145.3 x 10.32	PA30179
13 29/32 x 10 7/16 x 2 1/4	353.2 x 265.1 x 57.2	PA4390	15 5/32 x 8 1/16 x 1 9/32	385.0 x 204.8 x 32.5	PA4185
13 29/32 x 11 5/16 x 1 3/8	353.2 x 287.3 x 34.9	PA10309	15 3/16 x 5 15/16 x 8 5/32	385.8 x 150.8 x 207.2	PA1775
13 15/16 x 6 x 2 9/16	354.0 x 152.4 x 65.1	PA4554	15 3/16 x 8 1/4 x 8 1/8	385.8 x 209.6 x 206.4	PA1806
13 15/16 x 8 15/32 x 2 1/4	354.0 x 215.1 x 57.2	PA10312	15 3/16 x 10 9/16 x 8 5/32	385.8 x 268.3 x 207.2	PA1779
13 15/16 x 6 1/8 x 31/32	354.1 x 155.4 x 24.9	PA30330	15 7/32 x 6 5/32 x 15 1/8	386.3 x 156.2 x 384.6	PA31008
13 31/32 x 6 3/16 x 1 19/32	354.8 x 157.2 x 40.5	PA5339	15 1/4 x 4 29/32 x 1 7/32	387.4 x 124.6 x 31.0	PA30086
13 31/32 x 6 17/32 x 2 7/16	354.8 x 165.9 x 61.9	PA4165	15 1/4 x 5 1/4 x 1 15/32	387.4 x 133.4 x 37.3	PA31003
13 31/32 x 9 7/32 x 1 3/8	354.8 x 234.2 x 34.9	PA4488	15 1/4 x 7 5/16 x 2 3/16	387.4 x 185.7 x 55.6	PA3881
14 x 9 9/16 x 1 1/2	355.6 x 242.9 x 38.1	PA10303	15 11/32 x 4 29/32 x 1 7/16	389.7 x 124.6 x 36.5	PA5282
14 1/16 x 6 11/16 x 4 9/32	357.2 x 169.9 x 108.7	PA4433	15 3/8 x 3 5/8 x 1/2	390.5 x 92.1 x 12.7	PA30044
14 3/32 x 11 7/32 x 2 3/16	358.0 x 285.0 x 55.6	PA30002	15 3/8 x 5 19/32 x 23/32	390.5 x 142.1 x 18.3	PA5599
14 1/8 x 7 1/8 x 2 9/16	358.8 x 181.0 x 65.1	PA4654 KIT	15 7/16 x 6 3/32 x 21/32	392.1 x 154.8 x 16.7	PA5594
14 1/8 x 10 7/32 x 1 23/32	359.2 x 259.8 x 43.7	PA10076	15 7/16 x 7 5/16 x 2 9/32	392.1 x 185.7 x 57.9	PA10279
14 5/32 x 9 7/32 x 2 1/32	359.6 x 234.2 x 51.6	PA10225	15 9/16 x 8 9/32 x 3/16	395.3 x 210.3 x 4.8	PA5732
14 5/32 x 10 3/8 x 2 1/8	359.6 x 263.5 x 54.0	PA10012	15 19/32 x 12 27/32 x 2 3/4	396.1 x 326.2 x 69.9	PA4560
14 7/32 x 5 23/32 x 1 9/16	361.4 x 145.3 x 39.9	PA10281	15 5/8 x 10 1/32 x 1 1/32	396.9 x 254.8 x 26.2	PA5363
14 7/32 x 8 3/8 x 1 3/16	361.4 x 212.3 x 30.0	PA30272	15 21/32 x 4 11/32 x 1 1/32	397.3 x 110.0 x 26.4	PA30260
14 1/4 x 9 1/8 x 1 15/32	362.0 x 231.8 x 37.3	PA4478	15 21/32 x 6 7/16 x 1 17/32	397.7 x 163.5 x 38.9	PA5697
14 1/4 x 10 23/32 x 1 13/32	362.0 x 272.3 x 35.7	PA5712	15 23/32 x 7 3/32 x 1 9/16	399.3 x 180.2 x 39.7	PA3980
14 9/32 x 7 x 1 3/8	362.7 x 177.8 x 34.9	PA10178	15 3/4 x 5 3/16 x 25/32	400.0 x 131.8 x 19.8	PA5586
14 5/16 x 6 3/16 x 1 29/32	363.5 x 157.2 x 48.4	PA4448	15 3/4 x 6 3/8 x 2 1/8	400.1 x 161.9 x 54.0	PA30185
14 5/16 x 7 1/4 x 1 31/32	363.5 x 184.2 x 50.0	PA4111	15 13/16 x 7 3/32 x 1 5/8	401.6 x 180.2 x 41.3	PA4042
14 7/16 x 6 1/32 x 2 9/32	366.7 x 153.2 x 57.9	PA5680	15 7/8 x 7 27/32 x 1 19/32	403.2 x 199.2 x 40.5	PA2178
14 1/2 x 6 11/32 x 15/16	368.3 x 161.1 x 23.8	PA5725	15 29/32 x 6 25/32 x 1 13/32	404.0 x 172.2 x 35.7	PA4383
14 1/2 x 9 7/16 x 1 1/8	368.3 x 239.7 x 28.6	PA10249	15 29/32 x 7 7/8 x 2 3/16	404.0 x 200.0 x 55.6	PA5655
14 9/16 x 9 9/16 x 1 5/32	369.9 x 242.9 x 29.4	PA4324	15 15/16 x 6 1/4 x 2 9/32	404.9 x 159.0 x 57.9	PA10435
14 9/16 x 11 5/32 x 1 3/8	369.9 x 283.4 x 34.9	PA4336	15 31/32 x 5 7/8 x 14	405.6 x 149.2 x 355.6	PA31002
14 9/16 x 6 7/16 x 31/32	370.0 x 163.5 x 24.6	PA4489	15 31/32 x 7 1/16 x 1 3/16	405.6 x 179.4 x 30.2	PA5797
14 5/8 x 4 5/8 x 1 3/16	371.5 x 117.5 x 30.2	PA5625	15 31/32 x 7 29/32 x 2 5/32	405.6 x 200.8 x 54.8	PA2232
14 5/8 x 4 7/8 x 2 9/16	371.5 x 123.8 x 65.1	PA4567	15 31/32 x 8 13/16 x 2 19/32	405.6 x 223.8 x 55.9	PA10124
14 21/32 x 3 25/32 x 1 3/8	372.1 x 96.0 x 35.1	PA30270	16 x 7 1/16 x 1 3/16	406.4 x 179.4 x 30.2	PA5512
14 21/32 x 5 1/4 x 2 7/16	372.3 x 133.4 x 61.9	PA3886	16 x 8 x 2 3/16	406.4 x 203.2 x 55.6	PA3756
14 21/32 x 6 7/16 x 1 9/32	372.3 x 166.7 x 32.5	PA4128	16 x 11 31/32 x 2 3/16	406.4 x 304.0 x 58.7	PA5681
14 23/32 x 5 5/16 x 25/32	373.9 x 134.9 x 19.8	PA5493	16 1/16 x 4 23/32 x 2 5/16	408.0 x 119.9 x 58.7	PA5695
14 23/32 x 6 13/16 x 2 3/4	373.9 x 173.0 x 69.9	PA4172	16 1/16 x 5 11/16 x 15/16	408.0 x 144.5 x 23.8	PA10173
14 23/32 x 13 17/32 x 1 3/16	373.9 x 343.9 x 30.0	PA30258	16 3/32 x 11 23/32 x 1 3/16	408.9 x 297.7 x 30.2	PA5623
14 3/4 x 5 11/32 x 2 1/8	374.7 x 135.7 x 54.0	PA4307	16 1/8 x 5 27/32 x 10 1/32	409.6 x 148.4 x 254.8	PA31012
14 3/4 x 6 7/8 x 2 7/16	374.7 x 174.6 x 61.9	PA4635	16 1/8 x 5 31/32 x 2 19/32	409.6 x 151.6 x 65.9	PA5654
14 3/4 x 8 31/32 x 1 15/16	374.7 x 227.8 x 49.2	PA10242	16 5/16 x 6 1/2 x 3/4	414.0 x 165.0 x 19.0	PA30276
14 3/4 x 9 9/16 x 2 27/32	374.9 x 243.1 x 71.9	PA30299	16 3/8 x 6 7/8 x 2 31/32	415.5 x 174.8 x 75.4	CV15010
14 13/16 x 4 x 2 11/16	376.2 x 101.6 x 68.3	PA3829	16 3/8 x 8 9/16 x 1 9/16	415.9 x 217.5 x 39.7	PA4858
14 13/16 x 6 3/32 x 1 11/16	376.2 x 154.8 x 42.9	PA10300	16 3/8 x 9 27/32 x 27/32	415.9 x 250.0 x 21.4	PA5734
14 13/16 x 6 5/8 x 1 3/32	376.2 x 168.3 x 27.8	PA4409	16 7/16 x 5 x 1 7/16	417.5 x 127.0 x 36.5	PA2706
14 7/8 x 5 1/2 x 1 9/16	377.8 x 139.7 x 39.7	PA5492	16 7/16 x 5 9/16 x 2 9/16	417.5 x 141.3 x 65.1	PA3937
14 7/8 x 8 1/8 x 3	378.0 x 206.2 x 75.9	PA30333	16 7/16 x 6 5/32 x 29/32	417.5 x 156.4 x 23.0	PA4928
14 15/16 x 5 5/16 x 1 17/32	379.4 x 134.9 x 38.9	PA4956	16 17/32 x 5 x 1 3/16	419.9 x 127.0 x 30.2	PA30098
14 31/32 x 3 9/32 x 2 5/16	380.2 x 83.3 x 58.7	PA10007	16 5/8 x 5 9/16 x 2 9/16	421.9 x 141.0 x 65.3	PA30264
14 31/32 x 5 1/8 x 1 31/32	380.2 x 130.2 x 50.0	PA5399	16 5/8 x 5 3/8 x 1 9/32	422.3 x 136.5 x 32.5	PA10226
14 31/32 x 5 1/8 x 2 1/8	380.2 x 130.2 x 54.0	PA5400	16 11/16 x 7 29/32 x 1 3/8	423.9 x 200.8 x 34.9	PA10299
14 31/32 x 5 27/32 x 2 3/32	380.2 x 148.4 x 53.2	PA5740	16 11/16 x 8 7/8 x 2 1/4	423.9 x 225.4 x 57.2	PA5428
14 31/32 x 9 21/32 x 1 3/16	380.2 x 245.2 x 30.2	PA30172	16 3/4 x 4 13/32 x 1 1/8	425.5 x 111.9 x 28.6	PA4340
14 31/32 x 11 5/8 x 4 11/32	380.2 x 295.3 x 110.3	PA10257	16 13/16 x 11 11/16 x 2 9/16	427.0 x 296.97 x 65.1	PA5300
14 31/32 x 11 21/32 x 4 31/32	380.2 x 296.1 x 126.2	PA10262	16 15/16 x 4 11/32 x 1 3/16	430.0 x 110.0 x 30.0	PA30304
15 x 7 x 2 3/16	381.0 x 177.8 x 55.6	PA2936	16 15/16 x 4 11/32 x 1 3/16	430.0 x 110.0 x 30.0	PA30324
15 x 11 1/2 x 5 1/2	381.0 x 292.1 x 139.7	PA2450	16 15/16 x 5 1/8 x 1 19/32	430.2 x 130.2 x 40.5	PA10290
15 x 15 x 2 3/16	381.0 x 381.0 x 55.6	PA1961	17 x 6 x 2 3/16	431.8 x 152.4 x 55.6	PA4592
15 x 15 x 2 9/16	381.0 x 381.0 x 65.1	PA1960	17 x 8 x 2 3/16	431.8 x 203.2 x 55.6	PA3420
15 x 15 x 5 1/2	381.0 x 381.0 x 139.7	PA2554	17 x 10 x 2 3/16	431.8 x 254.0 x 55.6	PA2534
15 1/32 x 5 3/16 x 1 19/32	381.8 x 131.8 x 40.5	PA4912	17 x 10 1/32 x 2 3/16	431.8 x 254.8 x 55.6	PA5653



WARNING: These products can expose you to chemicals, including Diisononyl Phthalate, Carbon black extracts, Nickel, 1,3 Butadiene, Ethylene Oxide, Epichlorohydrin, which are known to the State of California to cause cancer, and Bisphenol-A, Ethylene Glycol, Ethylene Oxide, 1,3 Butadiene, Epichlorohydrin, which are known to the State of California to cause birth defects or other reproductive harm. For more information go to www.P65Warnings.ca.gov.

PANEL AIR FILTERS

LENGTH x WIDTH x THICK Inches	LENGTH x WIDTH x THICK (mm)	BALDWIN NUMBER	LENGTH x WIDTH x THICK Inches	LENGTH x WIDTH x THICK (mm)	BALDWIN NUMBER
17 1/32 x 2 7/8 x 1 7/8	432.6 x 73.0 x 47.6	PA5401	19 31/32 x 9 1/16 x 2 19/32	507.2 x 230.2 x 65.9	PA5711
17 1/8 x 4 13/16 x 1 3/4	435.0 x 122.2 x 44.5	PA5310	20 x 3 15/16 x 3 9/16	508.0 x 100.0 x 90.5	PA5757
17 1/8 x 8 7/16 x 2 11/16	435.0 x 214.3 x 68.3	PA3945	20 x 7 1/2 x 2 3/16	508.0 x 190.5 x 55.6	PA2354
17 9/32 x 5 21/32 x 21/32	438.9 x 143.7 x 16.7	PA5779	20 x 7 1/2 x 2 3/16	508.0 x 190.5 x 55.6	PA5315
17 5/16 x 10 19/32 x 1 17/32	439.7 x 269.1 x 38.9	PA2241	20 x 9 x 2 9/16	508.0 x 228.6 x 65.1	PA3869
17 13/32 x 4 23/32 x 1 3/16	442.1 x 119.9 x 30.2	PA10168	20 x 14 19/32 x 2 3/16	508.0 x 370.7 x 55.6	PA5636
17 15/32 x 8 1/2 x 5/8	443.7 x 215.9 x 15.9	PA3917	20 x 15 x 2 3/16	508.0 x 381.0 x 55.6	PA3944
17 1/2 x 4 1/4 x 3/16	444.5 x 108.0 x 4.8	PA5630	20 5/32 x 6 7/8 x 1 15/32	512.0 x 174.6 x 37.3	PA30126
17 1/2 x 6 x 2 9/16	444.5 x 152.4 x 65.1	PA3782	20 5/32 x 9 7/32 x 1 7/8	512.0 x 234.2 x 47.6	PA5642
17 21/32 x 8 1/8 x 1	448.5 x 206.4 x 25.4	PA5336	20 11/32 x 4 1/8 x 1 1/8	516.7 x 104.8 x 28.6	PA4153
17 21/32 x 8 1/8 x 1	448.5 x 206.4 x 25.4	PA5476	20 7/16 x 4 1/8 x 1 31/32	519.1 x 104.7 x 50.0	PA5710
17 11/16 x 4 13/16 x 19/32	449.6 x 121.9 x 15.0	PA30293	20 15/32 x 4 3/32 x 2	519.9 x 104.0 x 50.8	PA5404
17 3/4 x 7 13/32 x 1 7/32	450.9 x 191.3 x 31.0	PA4945	20 11/16 x 7 3/32 x 1 9/16	525.5 x 180.2 x 39.7	PA10339
17 29/32 x 5 27/32 x 1 3/16	454.8 x 148.4 x 30.2	PA5645	20 25/32 x 3 31/32 x 3 5/8	527.8 x 100.8 x 92.1	PA5755
17 29/32 x 5 15/16 x 15/32	454.8 x 150.8 x 11.9	PA5597	20 13/16 x 5 11/32 x 2 9/32	528.6 x 135.7 x 57.9	PA5581
18 x 10 x 2 15/16	457.2 x 254.0 x 74.6	PA3878	20 15/16 x 7 5/32 x 1 21/32	531.8 x 181.8 x 42.1	PA10287
18 1/8 x 9 7/16 x 1 3/16	460.4 x 239.7 x 30.2	PA5532	21 1/4 x 5 29/32 x 2 11/16	539.8 x 150.0 x 68.3	PA3440
18 5/32 x 6 31/32 x 1 1/2	461.0 x 177.0 x 38.1	PA10423	21 9/32 x 10 x 1 9/32	540.5 x 254.0 x 32.5	PA10374
18 5/32 x 15 9/16 x 19/32	461.2 x 395.3 x 15.1	PA4559	21 21/32 x 3 15/16 x 2 1/2	550.1 x 100.0 x 63.5	PA5396
8 7/16 x 8 1/8 x 1 29/32	463.3 x 206.4 x 48.4	PA10090	22 23/32 x 6 7/16 x 1 15/32	577.1 x 163.5 x 37.3	PA5340
18 1/4 x 3 7/8 x 3 3/16	463.6 x 98.4 x 81.0	PA3798	22 3/4 x 4 x 2 9/32	577.9 x 101.6 x 57.9	PA4801
18 5/16 x 3 1/16 x 1 5/8	465.1 x 77.8 x 41.3	PA4168	22 3/4 x 20 1/4 x 4 1/4	577.9 x 514.4 x 108.0	PA2313
18 5/16 x 5 5/16 x 2 5/32	465.1 x 134.9 x 54.8	PA5667	22 15/16 x 14 x 6 7/32	582.6 x 355.6 x 158.0	PA2315
18 11/32 x 7 x 2 5/32	465.9 x 177.8 x 54.8	PA5777	23 3/16 x 4 1/2 x 7/8	589.0 x 114.3 x 22.2	PA30137
18 11/32 x 8 31/32 x 25/32	465.9 x 227.8 x 19.8	PA30155	23 5/16 x 5 3/8 x 3 11/32	592.1 x 136.5 x 84.9	PA3928
18 3/8 x 7 9/32 x 2 13/16	466.7 x 184.9 x 71.4	PA4955	23 3/8 x 4 9/16 x 15/32	593.7 x 115.9 x 11.9	PA5598
18 7/16 x 5 1/4 x 2 3/16	468.3 x 133.4 x 55.6	PA3481	23 3/8 x 10 3/8 x 3 3/4	593.7 x 263.5 x 95.3	PA4668
18 1/2 x 4 9/16 x 2 1/4	469.9 x 115.9 x 57.2	PA5649	23 3/8 x 11 3/8 x 1 3/4	593.7 x 288.9 x 44.5	PA4663
18 17/32 x 3 17/32 x 1/2	470.7 x 89.7 x 12.7	PA5718 KIT	23 3/8 x 19 3/8 x 1 3/4	593.7 x 492.1 x 44.5	PA3873
18 9/16 x 4 21/32 x 1 3/8	471.5 x 118.3 x 34.9	PA4415	23 3/8 x 23 3/8 x 1 3/4	593.7 x 593.7 x 44.5	PA3872
18 19/32 x 7 7/16 x 2 13/16	472.3 x 188.9 x 71.4	PA5477	23 1/2 x 6 x 2 3/16	596.9 x 152.4 x 55.6	PA2626
18 19/32 x 7 7/8 x 2 19/32	472.3 x 200.0 x 65.9	PA5736	23 1/2 x 6 x 2 9/16	596.9 x 152.4 x 65.1	PA3658
18 13/16 x 4 1/8 x 1/2	477.8 x 104.8 x 12.7	PA5716	23 1/2 x 6 1/2 x 2 3/16	596.9 x 165.1 x 55.6	PA2502
18 29/32 x 3 15/32 x 1/2	480.2 x 88.1 x 12.7	PA5715	23 1/2 x 7 x 2 3/16	596.9 x 177.8 x 55.6	PA2356
18 29/32 x 4 7/8 x 19/32	480.2 x 123.8 x 15.1	PA30081	23 1/2 x 7 1/8 x 15/16	596.9 x 181.0 x 23.8	PA2499
19 x 19 x 5 3/8	482.6 x 482.6 x 136.5	PA2350	23 17/32 x 6 23/32 x 3 3/16	597.7 x 170.7 x 81.0	PA3843
19 x 19 x 5 3/8	482.6 x 482.6 x 136.5	PA2375	23 5/8 x 4 9/32 x 2 7/32	600.1 x 108.7 x 56.4	PA30045
19 1/32 x 8 13/32 x 12 3/16	483.0 x 213.4 x 309.4	PA32000	23 5/8 x 4 7/8 x 1 1/32	600.1 x 123.8 x 26.2	PA30190
19 1/32 x 8 13/32 x 7 9/32	483.0 x 213.4 x 184.7	PA32003	23 5/8 x 4 7/8 x 1 1/16	600.1 x 123.8 x 27.0	PA3939
19 1/16 x 6 15/16 x 2 1/8	484.2 x 76.2 x 54.0	PA5796	23 11/16 x 9 x 2 3/16	601.7 x 228.6 x 55.6	PA30064
19 1/8 x 11 1/4 x 2 7/16	485.8 x 285.8 x 61.9	PA4991	23 29/32 x 9 x 2 1/4	607.2 x 228.6 x 57.2	PA5283
19 9/32 x 8 31/32 x 2 23/32	489.7 x 227.8 x 69.1	PA30003	24 x 5 x 2 3/16	609.6 x 127.0 x 55.6	PA3676
19 3/8 x 5 3/4 x 3/8	492.1 x 146.1 x 9.5	PA5545	24 x 19 11/16 x 2 9/16	609.6 x 500.1 x 65.1	PA2947
19 13/32 x 5 27/32 x 1 3/16	492.9 x 148.4 x 30.2	PA5644	24 x 24 x 2 9/16	609.6 x 609.6 x 65.1	PA1765
19 7/16 x 3 5/16 x 2 1/4	493.7 x 84.1 x 57.2	PA10336	24 1/32 x 4 1/16 x 3 7/16	610.4 x 103.2 x 87.3	PA5696
19 7/16 x 19 7/16 x 5 5/16	493.7 x 493.7 x 134.9	PA2690	24 9/32 x 4 11/32 x 31/32	616.7 x 110.3 x 24.6	PA5678
19 7/16 x 19 7/16 x 8 1/16	493.7 x 493.7 x 204.8	PA2694	24 13/32 x 4 3/16 x 1 3/32	619.9 x 106.4 x 27.8	PA5618
19 1/2 x 9 1/2 x 1 3/4	495.3 x 241.3 x 44.5	PA30138	24 1/2 x 15 1/2 x 1 3/4	622.3 x 393.7 x 44.5	PA4662
19 1/2 x 11 1/2 x 1 3/4	495.3 x 292.1 x 44.5	PA30139	24 1/2 x 19 1/2 x 1 3/4	622.3 x 495.3 x 44.5	PA5457
19 1/2 x 15 1/2 x 1 3/4	495.3 x 393.7 x 44.5	PA4664	24 29/32 x 22 1/2 x 3 3/32	632.6 x 571.5 x 78.6	PA5426
19 1/2 x 19 1/2 x 1 3/4	495.3 x 495.3 x 44.5	PA4661	25 1/4 x 19 1/4 x 3 3/4	641.4 x 489.0 x 95.3	PA5454
19 1/2 x 19 1/2 x 1 25/32	495.3 x 495.3 x 45.2	PA4874	25 7/16 x 19 7/16 x 5 5/8	646.1 x 493.7 x 142.9	PA2691
19 1/2 x 19 1/2 x 2 19/32	495.3 x 495.3 x 65.9	PA2692	25 1/2 x 6 1/16 x 2 3/16	647.7 x 154.0 x 55.6	PA2572
19 1/2 x 19 1/2 x 5 1/4	495.3 x 495.3 x 133.4	PA3814	25 1/2 x 19 1/2 x 2 5/32	647.7 x 495.3 x 54.8	PA2693
19 1/2 x 19 1/2 x 5 1/4	495.3 x 495.3 x 133.4	PA3815	25 9/16 x 13 7/8 x 1 1/2	649.3 x 352.4 x 38.1	PA5688
19 1/2 x 19 1/2 x 5 9/16	495.3 x 495.3 x 141.3	PA2593	25 31/32 x 5 15/16 x 1 21/32	659.6 x 150.8 x 42.1	PA5781
19 1/2 x 19 1/2 x 5 11/16	495.3 x 495.3 x 144.5	PA2696	26 x 7 x 2 9/16	660.4 x 177.8 x 65.1	PA2753
19 21/32 x 5 9/32 x 2 19/32	499.3 x 134.1 x 65.9	PA5686	26 x 11 x 2 3/16	660.4 x 279.4 x 55.6	PA2935
19 11/16 x 3 15/16 x 3 9/16	500.1 x 100.0 x 90.5	PA3802	26 1/16 x 2 15/32 x 19/32	661.9 x 63.0 x 15.2	PA30292
19 11/16 x 7 7/8 x 2 5/32	500.1 x 200.0 x 54.8	PA5682	26 1/16 x 2 1/2 x 19/32	662.0 x 63.5 x 15.1	PA30164
19 13/16 x 19 13/16 x 8 1/8	503.2 x 503.2 x 206.4	PA1784	26 1/8 x 5 1/4 x 9 9/32	663.6 x 133.4 x 235.7	CA5790
19 27/32 x 5 31/32 x 8 5/32	504.0 x 151.6 x 207.2	PA1777	26 1/8 x 5 7/16 x 2 9/16	663.6 x 138.1 x 65.1	PA2844
19 27/32 x 8 7/8 x 1 3/16	504.0 x 225.4 x 30.2	PA5648			
19 7/8 x 8 1/4 x 8 5/32	504.8 x 209.6 x 207.2	PA1780			
19 7/8 x 10 9/16 x 8 5/32	504.8 x 268.3 x 207.2	PA1781			
19 7/8 x 15 7/32 x 8 5/32	504.8 x 386.6 x 207.2	PA1783			
19 29/32 x 12 25/32 x 8 5/32	505.6 x 324.6 x 207.2	PA1782			



WARNING: These products can expose you to chemicals, including Diisononyl Phthalate, Carbon black extracts, Nickel, 1,3 Butadiene, Ethylene Oxide, Epichlorohydrin, which are known to the State of California to cause cancer, and Bisphenol-A, Ethylene Glycol, Ethylene Oxide, 1,3 Butadiene, Epichlorohydrin, which are known to the State of California to cause birth defects or other reproductive harm. For more information go to www.P65Warnings.ca.gov.

PANEL AIR FILTERS

LENGTH x WIDTH x THICK Inches	LENGTH x WIDTH x THICK (mm)	BALDWIN NUMBER	LENGTH x WIDTH x THICK Inches	LENGTH x WIDTH x THICK (mm)	BALDWIN NUMBER
26 7/32 x 9 5/8 x 10 1/2	665.7 x 244.3 x 267.0	PA32002	32 3/16 x 9 13/32 x 3 1/2	817.6 x 238.9 x 88.9	PA4973
26 7/32 x 6 1/2 x 2 7/32	666.0 x 165.1 x 56.4	PA5771	32 3/4 x 4 13/16 x 1	831.9 x 122.2 x 25.4	PA10192
26 19/32 x 4 19/32 x 1 3/32	675.5 x 116.7 x 27.8	PA10375			
26 3/4 x 7 3/4 x 2 3/16	679.5 x 196.9 x 55.6	PA2448	33 x 4 x 2 7/32	838.2 x 101.6 x 56.4	PA5299
26 15/16 x 5 15/16 x 2 19/32	684.2 x 150.8 x 65.9	PA3877	33 x 6 1/2 x 2 3/16	838.2 x 165.1 x 55.6	PA2440
26 15/16 x 6 1/4 x 2 9/16	684.2 x 158.8 x 65.0	PA3824	33 5/16 x 9 23/32 x 27/32	846.1 x 246.9 x 21.4	PA5533
26 31/32 x 4 27/32 x 2 9/32	685.0 x 123.0 x 57.9	PA10338	33 31/32 x 5 15/16 x 1 21/32	862.8 x 150.8 x 42.1	PA5780
28 x 6 3/4 x 2 3/16	711.2 x 171.5 x 55.6	PA2463	34 17/32 x 5 5/16 x 2 13/32	877.1 x 134.9 x 61.1	PA5626
28 x 7 1/2 x 2 3/16	711.2 x 190.5 x 55.6	PA2353	36 x 6 1/2 x 2 3/16	914.4 x 165.1 x 55.6	PA2638
28 x 7 1/2 x 2 9/16	711.2 x 190.5 x 65.1	PA2352	36 7/16 x 14 x 6 3/16	925.5 x 355.6 x 157.2	PA2395
28 1/2 x 19 x 5 3/8	723.9 x 482.6 x 136.5	PA2444			
28 1/2 x 19 x 5 3/8	723.9 x 482.6 x 136.5	PA2564	37 x 6 x 2 3/16	939.8 x 152.4 x 55.6	PA2408
29 x 9 1/4 x 2 3/16	736.6 x 235.0 x 55.6	PA2329	38 x 5 x 2 3/16	965.2 x 127.0 x 55.6	PA2411
29 3/32 x 5 9/16 x 2 3/16	739.0 x 141.3 x 55.6	PA5668	38 x 6 x 2 3/16	965.2 x 152.4 x 55.6	PA2407
29 1/2 x 5 x 2 9/16	749.3 x 127.0 x 65.1	PA2752	38 x 6 x 2 9/16	965.2 x 152.4 x 65.1	PA2619
29 1/2 x 19 x 5	749.3 x 482.6 x 127.0	PA30074	38 x 7 x 2 3/16	965.2 x 177.8 x 55.6	PA2617
29 17/32 x 4 1/8 x 31/32	750.1 x 104.8 x 24.6	PA5713			
29 29/32 x 4 5/32 x 1/2	759.6 x 105.6 x 12.7	PA5726	40 25/32 x 8 1/32 x 2 19/32	1036.1 x 204.0 x 66.0	PA30271
29 29/32 x 9 17/32 x 2 3/16	759.6 x 242.1 x 55.6	PA5657			
29 15/16 x 6 x 2 9/16	760.4 x 152.4 x 65.1	PA3438	44 x 4 x 2 9/16	1117.6 x 101.6 x 65.1	PA2601
			44 15/16 x 4 x 2 3/16	1141.4 x 101.6 x 55.6	PA30049
30 x 5 31/32 x 2 1/8	762.0 x 151.6 x 54.0	PA30048			
30 x 20 x 3 9/16	762.0 x 508.0 x 90.5	PA2854	45 3/8 x 14 x 6 3/16	1152.5 x 355.6 x 157.2	PA2390
31 x 5 x 2 3/16	787.4 x 127.0 x 55.6	PA3442	47 x 6 x 2 9/16	1193.8 x 152.4 x 65.1	PA2464
			47 x 7 x 2 3/16	1193.8 x 177.8 x 55.6	PA2485
32 x 6 3/4 x 2 3/16	812.8 x 171.5 x 55.6	PA2436			
32 x 9 x 2 9/16	812.8 x 228.6 x 65.1	PA3421			

NOTES



WARNING: These products can expose you to chemicals, including Diisononyl Phthalate, Carbon black extracts, Nickel, 1,3 Butadiene, Ethylene Oxide, Epichlorohydrin, which are known to the State of California to cause cancer, and Bisphenol-A, Ethylene Glycol, Ethylene Oxide, 1,3 Butadiene, Epichlorohydrin, which are known to the State of California to cause birth defects or other reproductive harm. For more information go to www.P65Warnings.ca.gov.

OVAL, OBLONG & MISCELLANEOUS AIR FILTERS

LENGTH x O.D. x I.D. Inches	LENGTH x O.D. x I.D. (mm)	BALDWIN NUMBER	LENGTH x O.D. x I.D. Inches	LENGTH x O.D. x I.D. (mm)	BALDWIN NUMBER						
1 7/32.....31.0	4 25/32.....121.4	3 15/16.....100.0	4 1/16.....103.2	6 19/32.....167.5	5 1/32.....127.8	PA4731 PA5290 PA30119 PA4997 PA30072 PA30012 PA632 PA4704 PA4698	6 1/32.....152.4	8.....203.2	9 7/8.....250.8	CA5793 PA2233 CA5370 CA30102 PA10122 PA30118 PA10274 PA10062 CA4996 CA2194	
1 1/2.....38.1	10 5/16.....261.9	—	6.....152.4	12 31/32.....329.4	—	—	8.....203.2	—	—	—	—
1 9/16.....39.7	9.....228.6	—	6 1/32.....153.2	10 29/32.....277.0	—	—	6 9/32.....159.5	10 29/32.....277.0	—	—	—
1 19/32.....40.5	8 7/32.....208.8	—	6 1/2.....165.1	18 23/32.....475.5	—	—	6 21/32.....169.1	4 5/8.....117.5	4 31/32.....126.2	—	—
1 11/16.....42.9	10 7/8.....276.2	—	6 11/16.....169.9	10 1/4.....260.4	—	—	6 13/16.....173.0	5 1/2.....139.7	2 7/8.....73.0	—	—
1 23/32.....43.7	5 11/16.....144.5	3 7/8.....98.4	6 13/16.....173.0	6 7/32.....158.0	—	—	6 7/8.....174.6	7 7/8.....200.0	2 7/8.....73.0	—	—
1 3/4.....44.5	20 23/32.....526.3	18 5/16.....465.1	6 7/8.....174.6	7 7/8.....200.0	—	—	6 7/8.....174.6	8 1/16.....204.8	5 9/32.....134.1	—	—
1 13/16.....46.0	11 25/32.....299.2	—	7 1/8.....181.0	5 27/32.....148.4	—	—	7 1/8.....181.0	—	—	—	—
1 15/16.....49.2	7 17/32.....191.3	6 1/32.....153.2	7 7/32.....183.4	to 9 13/16...to 249.2	—	—	7 7/32.....183.4	10 29/32.....277.0	—	—	—
2 1/16.....52.4	4.....101.6	1 5/16.....33.3	7 5/16.....185.7	12 13/16.....325.4	—	—	7 5/16.....185.7	12 13/16.....325.4	—	—	—
2 1/8.....54.0	4 11/16.....119.1	2 29/32.....73.8	7 11/32.....186.5	12 7/32.....320.4	—	—	7 11/32.....186.5	12 7/32.....320.4	—	—	—
2 1/8.....54.0	5 1/16.....128.6	4 1/16.....103.2	7 7/16.....188.9	13 3/8.....339.7	—	—	7 7/16.....188.9	13 3/8.....339.7	—	—	—
2 1/8.....54.0	10 9/16.....268.3	9 1/16.....230.2	7 5/8.....193.7	7 3/8.....187.3	—	—	7 5/8.....193.7	7 3/8.....187.3	—	—	—
2 1/8.....54.0	14 9/16.....369.9	13 1/4.....336.6	7 23/32.....196.1	to 18 7/16...to 468.3	—	—	7 23/32.....196.1	21 3/4.....552.5	12 7/16.....315.9	—	—
2 3/16.....55.6	7 1/4.....184.2	6.....152.4	7 3/4.....196.9	11 11/16.....296.9	—	—	7 3/4.....196.9	11 11/16.....296.9	—	—	—
2 7/32.....56.4	8 27/32.....224.6	7 9/32.....184.9	8 1/16.....204.8	11 1/4.....285.8	—	—	8 1/16.....204.8	11 1/4.....285.8	4 3/8.....111.1	—	—
2 5/16.....58.7	4 15/32.....113.5	3 7/32.....81.8	8 3/8.....212.7	5 5/8.....142.9	—	—	8 3/8.....212.7	5 5/8.....142.9	6.....152.4	—	—
2 5/16.....58.7	8.....203.2	6 3/4.....171.5	8 13/32.....213.6	9 5/8.....244.1	—	—	8 13/32.....213.6	9 5/8.....244.1	6 7/8.....175.0	—	—
2 5/16.....58.7	12 13/16.....325.4	—	8 5/8.....219.1	5 9/16.....141.3	—	—	8 5/8.....219.1	5 9/16.....141.3	3 1/4.....82.6	—	—
2 5/16.....58.7	14 3/4.....374.7	—	8 23/32.....221.5	11 7/8.....301.6	—	—	8 23/32.....221.5	11 7/8.....301.6	—	—	—
2 11/32.....59.5	13 1/8.....333.4	10 5/8.....270.0	8 27/32.....224.6	7 3/8.....187.3	—	—	8 27/32.....224.6	7 3/8.....187.3	—	—	—
2 7/16.....61.9	6.....152.4	3 27/32.....97.6	9 3/16.....233.4	to 18 7/16...to 468.3	—	—	9 3/16.....233.4	11 7/16.....290.5	—	—	—
2 7/16.....61.9	8 9/16.....217.5	4 5/8.....117.5	9 5/16.....236.5	11 1/4.....285.8	—	—	9 5/16.....236.5	11 1/4.....285.8	—	—	—
2 1/2.....63.5	9 11/16.....246.1	8 3/16.....208.0	9 9/16.....242.9	12 3/32.....307.2	—	—	9 9/16.....242.9	12 3/32.....307.2	—	—	—
2 9/16.....65.1	7 7/8.....200.0	5 7/8.....141.3	9 9/16.....242.9	9 7/8.....250.8	—	—	9 9/16.....242.9	9 7/8.....250.8	6 11/16.....169.9	—	—
2 9/16.....65.1	8 1/4.....209.6	—	9 27/32.....250.0	11 1/32.....280.2	—	—	9 27/32.....250.0	11 1/32.....280.2	6 11/16.....169.9	—	—
2 9/16.....65.1	24 1/4.....616.0	22 27/32.....580.2	10 1/4.....260.4	11 3/16.....284.2	—	—	10 1/4.....260.4	11 3/16.....284.2	—	—	—
2 19/32.....65.9	6 3/32.....154.8	4 1/16.....103.2	11 1/4.....284.2	to 17 11/32...to 440.5	—	—	11 1/4.....284.2	to 17 11/32...to 440.5	—	—	—
2 11/16.....68.3	3 31/32.....100.8	1 1/4.....31.8	11 3/16.....284.2	—	—	—	11 3/16.....284.2	—	—	—	—
2 7/8.....73.0	4 1/2.....114.3	3 1/8.....79.4	11 7/16.....290.5	—	—	—	11 7/16.....290.5	—	—	—	—
2 7/8.....73.0	5 19/32.....142.1	3 11/16.....93.7	11 1/4.....285.8	—	—	—	11 1/4.....285.8	—	—	—	—
2 7/8.....73.0	14 9/16.....369.9	11 13/16.....300.0	11 3/16.....284.2	—	—	—	11 3/16.....284.2	—	—	—	—
2 29/32.....73.8	8 5/8.....219.1	6 27/32.....173.8	12 7/32.....310.4	—	—	—	12 7/32.....310.4	—	—	—	—
3 1/32.....77.0	7 1/4.....184.2	3 29/32.....99.2	12 13/16.....325.4	—	—	—	12 13/16.....325.4	—	—	—	—
3 1/16.....77.8	5 11/16.....144.5	3 7/8.....98.4	12 21/32.....321.5	—	—	—	12 21/32.....321.5	—	—	—	—
3 1/16.....77.8	5 3/4.....146.1	4 1/16.....103.2	13 1/4.....336.6	—	—	—	13 1/4.....336.6	—	—	—	—
3 3/32.....78.6	3 31/32.....100.8	1 5/8.....41.3	25.....635.0	—	—	—	25.....635.0	—	—	—	—
3 1/8.....79.4	5 3/32.....129.4	3 9/16.....90.5	9 9/32.....235.7	—	—	—	9 9/32.....235.7	—	—	—	—
3 1/8.....79.4	7 5/32.....181.8	6.....152.4	5 7/16.....138.1	—	—	—	5 7/16.....138.1	—	—	—	—
3 1/8.....79.4	7 7/16.....188.9	5 15/16.....150.8	8 7/8.....225.4	—	—	—	8 7/8.....225.4	—	—	—	—
3 5/32.....80.2	15 3/8.....390.5	11 17/32.....292.9	1 5/8.....41.3	—	—	—	1 5/8.....41.3	—	—	—	—
3 3/16.....81.0	6 5/32.....156.4	4 23/32.....119.9	5 1/2.....139.7	—	—	—	5 1/2.....139.7	—	—	—	—
3 7/32.....81.8	5 25/32.....146.8	4 5/32.....105.6	—	—	—	—	—	—	—	—	—
3 1/4.....82.6	7 5/16.....185.7	5 7/16.....138.1	—	—	—	—	—	—	—	—	—
3 9/32.....83.3	15 27/32.....402.4	12 3/4.....323.8	—	—	—	—	—	—	—	—	—
3 7/16.....87.3	5 9/32.....134.1	3 1/2.....88.9	—	—	—	—	—	—	—	—	—
3 1/2.....88.9	11 1/8.....282.6	8 7/8.....225.4	—	—	—	—	—	—	—	—	—
3 5/8.....92.1	4 13/32.....111.9	1 5/8.....41.3	—	—	—	—	—	—	—	—	—
3 5/8.....92.1	9 3/4.....247.7	5 1/2.....139.7	—	—	—	—	—	—	—	—	—

NOTES



WARNING: These products can expose you to chemicals, including Diisononyl Phthalate, Carbon black extracts, Nickel, 1,3 Butadiene, Ethylene Oxide, Epichlorohydrin, which are known to the State of California to cause cancer, and Bisphenol-A, Ethylene Glycol, Ethylene Oxide, 1,3 Butadiene, Epichlorohydrin, which are known to the State of California to cause birth defects or other reproductive harm. For more information go to www.P65Warnings.ca.gov.

BOXSTYLE FUEL FILTERS			CANTYPE FUEL FILTERS						
LENGTH x WIDTH x HEIGHT Inches	LENGTH x WIDTH x HEIGHT (mm)	BALDWIN NUMBER	LENGTH Inches	LENGTH (mm)	O.D. Inches	O.D. (mm)	I.D. Inches	I.D. (mm)	BALDWIN NUMBER
2 31/32 x 2 31/32 x 2 1/8	75.4 x 75.4 x 54.0	BF7881	2 25/32	70.6	3 15/32	88.1	29/32	23.0	BF7871
3 x 3 x 1	76.2 x 76.2 x 25.4	BF46125	2 13/16	71.4	3 7/16	87.3	3/4	19.1	BF825
3 15/32 x 3 7/16 x 2 1/8	88.1 x 87.3 x 54.0	BF7912	2 13/16	71.4	3 7/16	87.3	3/4	19.1	BF838-F2
4 3/8 x 3 9/32 x 2 5/8	111.1 x 83.3 x 66.7	BF806	2 13/16	71.4	3 7/16	87.3	1 7/16	36.5	BF9915
4 5/8 x 2 27/32 x 2 15/32	117.5 x 72.2 x 62.7	BF855	3 13/32	86.5	3 7/16	87.3	3/4	19.1	BF7537
4 21/32 x 2 27/32 x 2 15/32	118.3 x 72.2 x 62.7	BF7576	3 13/16	96.8	3 15/32	88.1	3/4	19.1	BF874
4 21/32 x 2 27/32 x 2 15/32	118.3 x 72.2 x 62.7	BF7579	4	101.6	3 15/32	88.1	29/32	23.0	BF7870
4 21/32 x 2 27/32 x 2 15/32	118.3 x 72.2 x 62.7	BF7580	4 7/16	112.7	3 15/32	88.1	3/4	19.1	BF884
4 15/16 x 3 11/16 x 3 11/32	125.4 x 93.7 x 84.9	BF909	5 13/32	137.3	3 15/32	88.1	3/4	19.1	BF812
4 15/16 x 3 11/16 x 3 11/32	125.4 x 93.7 x 84.9	BF912							
5 1/8 x 3 11/16 x 3 7/32	130.2 x 93.7 x 81.8	BF959							
6 11/32 x 3 9/32 x 2 21/32	161.1 x 83.3 x 67.5	BF856							
7 7/32 x 7 1/4 x 2 5/32	183.4 x 184.2 x 54.8	BF46087							

NOTES



WARNING: These products can expose you to chemicals, including Diisononyl Phthalate, Carbon black extracts, Nickel, 1,3 Butadiene, Ethylene Oxide, Epichlorohydrin, which are known to the State of California to cause cancer, and Bisphenol-A, Ethylene Glycol, Ethylene Oxide, 1,3 Butadiene, Epichlorohydrin, which are known to the State of California to cause birth defects or other reproductive harm. For more information go to www.P65Warnings.ca.gov.

OIL/AIR SEPARATOR ELEMENTS BY LENGTH

All Measurements in Inches and (Millimeters)

NOTE: All oil/air separator element filters have been sorted by length and then outside diameter.
The larger outside and inside diameters have been listed.

LENGTH Inches	LENGTH (mm)	O.D. Inches	O.D. (mm)	I.D. Inches	I.D. (mm)	BALDWIN NUMBER	LENGTH Inches	LENGTH (mm)	O.D. Inches	O.D. (mm)	I.D. Inches	I.D. (mm)	BALDWIN NUMBER
6 1/8	155.6	4 1/32	102.4	1 15/16	49.2	OAS98012	11 17/32	292.9	9 27/32	250.0	2 15/16	74.6	OAS99003
6 5/16	160.3	5 9/32	134.1	2 31/32	75.4	OAS99005	11 11/16	296.9	7 3/16	182.6	3 5/16	84.1	OAS98001
6 5/16	160.3	8 19/32	218.3	4 11/32	110.3	OAS99023	11 25/32	299.2	3 7/32	81.8	1 5/16	33.3	OAS98045
6 3/8	161.9	5 3/8	136.5	2 1/4	57.2	OAS98035	11 7/8	301.6	6 31/32	177.0	3 15/32	88.1	OAS99010
6 23/32	170.7	8 21/32	219.9	3	76.2	OAS99025	11 7/8	301.6	6 31/32	177.0	3 15/32	88.1	OAS99017
6 13/16	173.0	7 7/8	200.0	3 3/8	85.7	OAS98002	12	304.8	5 1/2	139.7	2 5/8	66.7	OAS98019
6 7/8	174.6	9 5/8	244.5	3	76.2	OAS98056	12 15/16	328.6	11 13/16	300.0	4 25/32	121.4	OAS99038
7 5/8	193.7	3 29/32	99.2	2 7/32	56.4	OAS98029	13 31/32	354.8	15 3/4	400.1	6 1/2	165.1	OAS99008
7 25/32	197.6	4 31/32	126.2	1 3/32	27.8	OAS99001	14	355.6	13 5/16	338.1	5 3/32	129.4	OAS98009
7 7/8	200.0	8 1/2	215.9	3 15/16	100.0	OAS99024	14 1/16	357.2	10 3/4	273.1	1 1/2	38.1	OAS98023
8 1/8	206.4	7 15/32	189.7	3 5/16	84.1	OAS98005	16 3/32	408.8	10 3/4	273.1	5 1/4	133.4	OAS98010
8 11/32	211.9	7 7/8	200.0	3 13/16	96.8	OAS98003	16 11/32	415.1	3 15/16	100.0	2 5/32	54.8	OAS98028
9 1/32	229.4	7 11/16	195.3	4 9/32	108.7	OAS99020	16 15/32	418.3	17	431.8	10 7/16	265.1	OAS98050
9 1/16	230.2	4 27/32	123.0	2 15/32	62.7	OAS98008	17 9/16	446.1	19 11/16	500.1	10 3/8	263.5	OAS98053
9 1/16	230.2	7 7/8	200.0	3 29/32	99.2	OAS98016	18 1/16	458.8	12 3/4	323.9	8 5/8	219.1	OAS99014
9 1/16	230.2	14 3/4	374.7	8 7/32	208.8	OAS98015	19 9/16	496.9	11 13/16	300.0	4 13/16	122.2	OAS99006
9 17/32	242.1	7 7/8	200.0	4 13/16	122.2	OAS99042	19 11/16	500.1	13 29/32	353.2	7 15/32	189.7	OAS98017
9 17/32	242.1	11 13/16	300.0	6 9/16	166.7	OAS99034	19 11/16	500.1	14 1/8	358.8	8 9/32	210.3	OAS98026
9 21/32	245.3	12	304.8	8 9/32	210.3	OAS99004	22 5/8	574.7	5 1/2	139.7	2 13/32	61.1	OAS98020
9 11/16	246.1	14	355.6	3 1/4	82.6	OAS98031	24 1/2	622.3	13 25/32	350.0	7 7/16	188.9	OAS98024
9 27/32	250.0	6 15/32	164.3	2 3/8	60.3	OAS99002	29 27/32	758.0	11 1/2	292.1	9 1/4	235.0	OAS98042
9 27/32	250.0	7 7/8	200.0	3 13/16	96.8	OAS98032	32 9/32	819.9	15 3/4	400.1	8 1/2	215.9	OAS99018
9 31/32	253.2	1 19/32	40.5	1 19/32	40.5	OAS99035							
10 3/32	256.4	8 1/2	215.9	5 19/32	142.1	OAS98058							
10 7/8	276.2	8 11/16	220.7	3 7/16	87.3	OAS98022							
10 29/32	277.0	14	355.6	7 7/16	188.9	OAS98033							
11	279.4	10 3/4	273.1	5 1/4	133.4	OAS98038							
11 7/16	290.5	5 3/4	146.1	2 5/16	58.7	OAS98044							

NOTES



WARNING: These products can expose you to chemicals, including Diisononyl Phthalate, Carbon black extracts, Nickel, 1,3 Butadiene, Ethylene Oxide, Epichlorohydrin, which are known to the State of California to cause cancer, and Bisphenol-A, Ethylene Glycol, Ethylene Oxide, 1,3 Butadiene, Epichlorohydrin, which are known to the State of California to cause birth defects or other reproductive harm. For more information go to www.P65Warnings.ca.gov.

OIL/AIR SEPARATOR SPIN-ON FILTERS BY TAP SIZE

	THREAD I.D.	O.D. Inches	O.D. (mm)	LENGTH Inches	LENGTH (mm)	GASKET	FEATURES	BALDWIN NUMBER
	1 1/4 - 11 BSP	5 17/32.....	140.5	10 7/8.....	276.2	[1] Included		OAS98006
	1 1/2 - 16	5 17/32.....	140.5	11 7/8.....	301.6	[1] Attached		OAS98061
	M16 x 1.5	3.....	76.2	4 29/32.....	124.6	[1] Included		OAS98000
	M23 x 1.5	3 7/8.....	98.4	8 1/4.....	209.6	[1] Included		OAS98060
	M24 x 1.5	3 27/32.....	97.6	8 5/16.....	211.1	[1] Included		OAS99048
	M32 x 1.5	4 11/32.....	110.3	10 3/8.....	263.5	[1] IncludedPS.....		OAS99028
	M39 x 1.5	5 1/2.....	139.7	7 3/32.....	180.2	[1] IncludedPS.....		OAS99029
	M39 x 1.5	5 1/2.....	139.7	12 1/32.....	305.6	[1] Included		OAS99047

NOTES



WARNING: These products can expose you to chemicals, including Diisononyl Phthalate, Carbon black extracts, Nickel, 1,3 Butadiene, Ethylene Oxide, Epichlorohydrin, which are known to the State of California to cause cancer, and Bisphenol-A, Ethylene Glycol, Ethylene Oxide, 1,3 Butadiene, Epichlorohydrin, which are known to the State of California to cause birth defects or other reproductive harm. For more information go to www.P65Warnings.ca.gov.

IN-LINE FILTERS BY INLET SIZE

INLET	OUTLET	O.D. Inches	O.D. (mm)	LENGTH Inches	LENGTH (mm)	BALDWIN NUMBER	INLET	OUTLET	O.D. Inches	O.D. (mm)	LENGTH Inches	LENGTH (mm)	BALDWIN NUMBER
1/8	3/16	3 7/16	87.3	3 19/32	91.3	BF9863	5/16	5/16	2 5/32	54.8	6 3/8	161.9	BF1008
1/8-27	1/8-27	2	51.1	3	76.2	BF46229	5/16	5/16	2 3/16	55.6	6 5/16	160.3	BF1185
1/8-27	1/2-20	2	50.8	3 7/16	87.3	BF843	5/16	5/16	2 3/16	55.6	12 13/32	315.0	BF46214
5/32	5/32	2 5/32	19.8	1 5/8	41.3	BF7860	5/16	5/16	2 7/32	56.4	7 1/32	178.6	BF7768
3/16	3/16	3/4	19.1	2 3/8	60.3	BF7843	5/16	5/16	2 7/32	56.4	7 3/32	180.2	BF7668
3/16	3/16	27/32	21.4	1 7/16	36.5	BF7857	5/16	5/16	2 1/4	57.2	6	152.4	BF1184
3/16	3/16	2 1/8	54.0	4 5/8	117.5	BF9807	5/16	5/16	2 9/32	57.9	6 9/16	166.7	BF7801
3/16	3/16	2 13/32	61.1	6 15/32	164.3	BF46221	5/16	5/16	2 5/16	58.7	4 11/32	110.3	BF795
1/4	1/4	13/16	20.6	1 3/4	44.5	BF7855	5/16	5/16	2 5/16	58.7	5 15/32	138.9	BF1049
1/4	1/4	1	25.4	3	76.2	BF46007	5/16	5/16	2 7/16	61.9	4 13/16	122.2	BF1123
1/4-18 NPT	1/8-27 NPT	1 7/32	31.0	2 15/32	62.7	BF46008	5/16	5/16	2 15/32	62.7	11 13/16	300.0	BF7641
1/4	1/4	1 9/32	32.5	3 5/16	84.1	BF46196	5/16	5/16	2 17/32	64.3	4 11/16	119.1	BF1104
1/4	1/4	1 13/32	35.7	4 5/32	105.6	BF7903	5/16	5/16	2 9/16	65.1	5	127.0	BF1163
1/4 or 5/16	1/4 or 5/16	1 15/32	37.3	4 7/32	107.2	BF7851	5/16	5/16	2 23/32	69.1	5	127.0	BF46212
Universal	Universal	1 29/32	48.4	4 1/16	103.2	BF833	5/16	5/16	2 23/32	69.1	5 3/32	129.4	BF46211
1/4	1/4	1 29/32	48.4	4 1/16	103.2	BF833-K2	5/16	5/16	2 3/4	69.9	6 3/16	157.2	BF7959
1/4 or 5/16	1/4 or 5/16	2 1/16	52.4	4 3/4	120.7	BF7863	5/16	5/16	2 3/4	69.9	5 17/32	142.1	BF46208
Universal	Universal	2 3/32	53.2	3 7/16	87.3	BF45000	5/16	5/16	2 3/4	69.9	5 3/4	146.1	BF1190
1/4	1/4	2 5/16	58.7	6 9/16	166.7	BF46220	5/16	5/16	2 25/32	70.6	6 1/32	153.2	BF46210
1/4	1/4	2 11/32	59.5	2 31/32	75.4	BF7625	5/16	5/16	2 25/32	70.6	2 19/32	65.9	BF1160
1/4	1/4	2 13/32	61.1	6 15/32	164.3	BF9805	5/16	5/16	2 13/16	71.4	5 3/4	146.1	BF46202
1/4	1/4	3 5/8	92.1	4 17/32	115.1	BF46000	5/16	5/16	2 13/16	71.4	6 1/32	153.2	BF46203
1/4-18	1/4-18	3 13/16	96.8	6 13/32	162.7	BF7726	5/16	5/16	2 13/16	71.4	6 17/32	165.9	BF929
9/32	9/32	1 27/32	46.8	3 3/8	85.7	BF7849	5/16	5/16	2 13/16	71.4	7 1/16	179.4	BF7962
9/32	9/32	1 7/8	47.6	3 17/32	89.7	BF932	5/16	5/16	2 15/16	74.6	4 25/32	121.4	BF7720
9/32	9/32	3 1/8	79.4	2 9/32	57.9	BF873	5/16	5/16	2 15/16	74.6	5 1/4	133.4	BF7963
9/32	9/32	4 1/16	103.2	2 1/4	57.2	BF933	5/16	5/16	2 15/16	74.6	6 1/8	155.6	BF46217
5/16	1/8-27	31/32	24.6	2 5/16	58.7	BF995	5/16	5/16	3 3/32	78.6	5 23/32	146.8	BF7809
5/16	1/8 PT	1 5/16	33.5	2 23/32	69.1	BF46242	5/16	5/16	3 1/8	79.4	2 1/4	57.2	BF805
5/16	7/32	7/8	22.2	1 15/32	37.3	PT9469	5/16	5/16	3 1/8	79.4	5 3/8	136.5	BF1105
5/16	1/4	2 1/8	54.0	4 11/16	119.1	BF7736-K1	5/16	5/16	3 1/8	79.4	5 13/16	147.6	BF966
5/16	5/16	1 5/16	23.8	3 1/32	77.0	BF989	5/16	5/16	3 1/8	79.4	6 25/32	172.2	BF1166
5/16	5/16	1 1/8	28.6	3 3/32	78.6	BF7861	5/16	5/16	3 1/8	79.4	2 9/32	57.9	BF1140
5/16	5/16	1 3/16	30.2	4 7/32	107.2	BF7865	5/16	5/16	3 5/32	80.2	6 3/16	157.2	BF7804
5/16	5/16	1 1/4	31.8	3 15/32	88.1	BF930	5/16	5/16	3 5/32	80.2	6 11/16	169.9	BF7803
5/16	5/16	1 5/16	33.3	1 3/4	44.5	BF7864	5/16	5/16	3 5/32	80.2	5 1/8	130.2	BF830
5/16	5/16	1 13/32	35.7	4 3/32	104.0	BF7848	5/16	5/16	3 3/16	81.0	6 1/4	158.8	BF1195
5/16	5/16	1 13/32	35.7	4 5/32	105.6	BF7725	5/16	5/16	3 7/32	81.8	6 15/16	176.2	BF7670
5/16	5/16	1 7/16	36.5	3 15/32	88.1	BF881	5/16	5/16	3 5/16	84.1	2 15/16	74.6	BF1150
5/16	5/16	1 7/16	36.5	3 27/32	97.6	BF7686	5/16	5/16	3 11/32	84.9	7 17/32	191.3	BF1047
1/4 or 5/16	1/4 or 5/16	1 15/32	37.3	4 7/32	107.2	BF7851	5/16	5/16	3 3/8	85.7	4 7/8	123.8	BF1048
Universal	Universal	1 1/2	38.1	3 15/32	88.1	BF930	5/16	5/16	3 3/8	85.7	6 5/8	168.3	BF1215
5/16	5/16	1 17/32	38.9	1 3/4	44.5	BF7864	5/16	5/16	3 3/8	85.7	6 21/32	169.1	BF7844
5/16	11/32	1 25/32	45.2	4 3/32	104.0	BF7848	5/16	5/16	3 15/32	88.1	7 13/16	198.4	BF7958
5/16	5/16	1 29/32	48.4	4 5/32	105.6	BF7725	5/16	5/16	3 5/8	92.1	6 5/8	168.3	BF7765
5/16	5/16	1 29/32	48.4	3 15/32	88.1	BF881	5/16	5/16	4 1/16	103.2	2 5/16	58.7	BF837
5/16	5/16	1 29/32	48.4	3 27/32	97.6	BF7686	5/16	3/8	2 7/32	56.4	6 3/8	161.9	BF1170
5/16	5/16	1 29/32	48.4	4 5/32	105.6	BF840-K1	5/16	3/8	2 5/32	54.8	6 3/4	171.5	BF7711
5/16	5/16	1 15/16	49.2	4 7/32	107.2	BF7851	5/16	3/8	2 5/32	54.8	6 13/16	173.0	BF7780
5/16	5/16	1 31/32	50.0	3 1/32	77.0	BF964	5/16	3/8	3 3/8	85.7	7	177.8	BF7965
5/16	5/16	1 31/32	50.0	3 15/16	100.0	BF865	5/16	3/8	3 9/16	90.5	4 11/16	119.1	BF46001
5/16	5/16	1 31/32	50.0	3 15/16	100.0	BF886	5/16	1/2	2 3/32	53.2	3 5/8	92.1	BF46194
5/16 or 3/8	5/16 or 3/8	2	50.8	8 1/8	206.4	BF7850	5/16	M12 x 1.25	2 13/16	71.4	5 3/16	131.8	BF925
Universal	Universal	2 1/16	52.4	4 17/32	115.1	BF7859	5/16	M14 x 1.5	2 9/16	65.1	4 9/32	108.7	BF46215
5/16	11/32	2 1/16	52.4	4 3/4	120.7	BF7863	5/16	M14 x 1.5	2 9/16	65.1	4 15/16	125.4	BF46207
5/16	5/16	2 1/16	52.4	17 9/32	438.9	BF46213	11/32	9/32	2 5/32	54.8	5 5/8	142.9	BF46084
5/16	5/16	2 1/8	54.0	2 15/16	74.6	BF1178	11/32	11/32	2 9/16	65.1	3 7/32	81.8	BF9906
5/16	5/16	2 1/8	54.0	3 21/32	92.9	BF7736	11/32	11/32	2 3/4	69.9	3 19/32	91.3	BF928
5/16	5/16	2 1/8	54.0	4 13/16	122.2	BF7713	11/32	11/32	3	76.2	2 17/32	64.3	BF46197
5/16	5/16	2 5/32	54.8	4	101.6	BF794	11/32	11/32	3 7/16	87.3	6 3/32	154.8	BF46199
5/16	5/16	2 5/32	54.8	4 5/16	109.5	BF1057	3/8	1/8-27	1	25.4	2 5/8	66.7	BF879
5/16	5/16	2 5/32	54.8	4 29/32	124.6	BF9848	3/8	[2] 5/16	2 5/32	54.8	9 17/32	242.1	BF1058
5/16	5/16	2 5/32	54.8	6 1/4	158.8	BF1182	3/8	3/8	1 29/32	48.4	3 13/16	96.8	BF1052
							3/8	3/8	1 29/32	48.4	3 13/16	96.8	BF1173
							3/8	3/8	1 29/32	48.4	3 7/8	98.4	BF836
							3/8	3/8	1 29/32	48.4	3 7/8	98.4	BF836-K3
							3/8	3/8	1 29/32	48.4	3 7/8	98.4	BF836-K4
							3/8	3/8	1 29/32	48.4	5 5/8	142.9	BF9905
							3/8 Quick Connect	3/8 Quick Connect	1 15/16	49.2	5 25/32	146.8	BF7719



WARNING: These products can expose you to chemicals, including Diisononyl Phthalate, Carbon black extracts, Nickel, 1,3 Butadiene, Ethylene Oxide, Epichlorohydrin, which are known to the State of California to cause cancer, and Bisphenol-A, Ethylene Glycol, Ethylene Oxide, 1,3 Butadiene, Epichlorohydrin, which are known to the State of California to cause birth defects or other reproductive harm. For more information go to www.P65Warnings.ca.gov.

IN-LINE FILTERS BY INLET SIZE

INLET	OUTLET	O.D. Inches	O.D. (mm)	LENGTH Inches	LENGTH (mm)	BALDWIN NUMBER	INLET	OUTLET	O.D. Inches	O.D. (mm)	LENGTH Inches	LENGTH (mm)	BALDWIN NUMBER
3/8	3/8	1 31/32	50.0	6 27/32	173.8	BF7769	9/16-18	9/16-18	1 31/32	50.0	3 23/32	94.5	BF7690
3/8	3/8	1 31/32	50.0	6 7/8	174.6	BF46222	5/8-18	3/8	2 9/32	57.9	4 3/4	120.7	BF858
5/16 or 3/8	5/16 or 3/8	2	50.8	8 1/8	206.4	BF7850	5/8-24	5/8-24	1 29/32	48.4	3 17/32	89.7	BF7519
Universal	Universal												
3/8	3/8	2 5/32	54.8	4 27/32	123.0	BF7762	11/16-16	13/16-16	1 1/2	38.1	2 13/16	71.4	PT9470
3/8	3/8	2 5/32	54.8	6 5/16	160.3	BF1174	11/16-16	13/16-16	2 3/16	55.6	3 11/16	93.7	PT9474
3/8	3/8	2 5/32	54.8	6 15/32	164.3	BF1172	7/8	7/8	5 1/2	139.7	11 15/16	303.2	PT8480
3/8	3/8	2 5/32	54.8	6 7/8	174.6	BF7771	1	1	4 1/32	102.4	7 31/32	202.4	PT8435-MPG
3/8	3/8	2 5/32	54.8	16 15/16	430.2	BF7630	1-14	1 1/16	4 1/4	108.0	5 11/32	135.7	BT8412
3/8	3/8	2 1/4	57.2	7	177.8	BF7742	M12 x 1.25	M12 x 1.25	2 17/32	64.3	3 31/32	100.8	BF7659
3/8	3/8	2 1/4	57.2	7 1/4	184.2	BF7800	M12 x 1.25	M12 x 1.25	2 3/4	69.9	4 13/32	111.9	BF1191
3/8	3/8	2 1/4	57.2	7 27/32	199.2	BF7805	M12 x 1.25	M12 x 1.25	2 3/4	69.9	4 29/32	124.6	BF1100
3/8	3/8	2 9/32	57.9	5 1/4	133.4	BF46193	M12 x 1.25	M12 x 1.25	2 13/16	71.4	5 3/16	131.8	BF46206
3/8	3/8	2 9/32	57.9	6 13/32	162.7	BF1046	M12 x 1.25	M12 x 1.25	3 13/32	86.5	3 13/16	96.8	BF46201
3/8	3/8	2 9/32	57.9	6 15/32	164.3	BF1045	M12 x 1.25	M12 x 1.25	3 13/32	86.5	3 7/8	98.4	BF1120
3/8	3/8	2 9/32	57.9	6 29/32	175.4	BF7802	M12 x 1.25	M14 x 1.5	2 13/16	71.4	4 5/8	117.5	BF46198
3/8	3/8	2 11/32	59.5	7 1/2	190.5	BF7937	M12 x 1.5	M14 x 1.5	3 13/32	86.5	5 23/32	146.8	BF1177
3/8	3/8	2 11/32	59.5	8 15/32	215.1	BF9851	M14 x 1.5	5/16	2 9/16	65.1	4 1/32	102.4	BF46216
3/8	3/8	2 3/4	69.9	4 1/4	108.0	BF7944	M14 x 1.5	5/16	2 9/16	65.1	4 3/16	106.4	BF7661
3/8	3/8	3 1/4	84.1	6 15/16	176.2	BF9857	M14 x 1.5	5/16	2 23/32	69.1	4 5/8	117.5	BF46209
3/8	3/8	3 3/8	85.7	7 5/32	181.8	BF9881	M14 x 1.5	7/16	2 3/4	69.9	4 1/8	104.8	BF7945
3/8	5/16	1 29/32	48.4	30	762.0	BF7669	M14 x 1.5	7/16	2 9/16	65.1	3 15/16	100.0	BF7662
3/8	5/16	1 29/32	48.4	36	914.4	BF1053	M14 x 1.5	M12 x 1.25	2 9/16	65.1	4 1/32	102.4	BF1061
3/8	5/16	1 31/32	50.0	24	609.6	BF7763	M14 x 1.5	M12 x 1.25	2 3/4	69.9	4 3/16	106.4	BF46204
3/8	5/16	2 5/32	54.8	6 13/32	162.7	BF1181	M14 x 1.5	M12 x 1.25	2 3/4	69.9	4 9/32	108.7	BF1050
3/8	5/16	2 7/32	56.4	7 3/32	180.2	BF7960	M14 x 1.5	M12 x 1.25	2 3/4	69.9	4 3/8	111.1	BF1179
3/8	5/16	2 11/32	59.5	8 11/32	211.9	BF7671	M14 x 1.5	M12 x 1.25	2 15/16	74.6	4 7/16	112.7	BF1193
3/8	5/16	2 5/8	66.7	6 9/16	166.7	BF1199	M14 x 1.5	M12 x 1.25	3 13/32	86.5	4 1/4	108.0	BF7721
3/8	5/16	3 1/16	77.8	6 1/16	154.0	BF890	M14 x 1.5	M12 x 1.5	3 1/8	79.4	5 11/32	135.7	BF885
3/8	5/16	3 17/32	89.7	4 27/32	123.0	BF46037	M14 x 1.5	M12 x 1.5	3 15/32	88.1	5 31/32	151.6	BF46195
3/8	1/2-20	11/16	17.5	2 27/32	72.2	BF46205	M14 x 1.5	M14 x 1.5	1 13/16	46.0	3 7/16	87.3	BF46005
3/8	M14 x 1.5	2 5/32	54.8	5 13/32	137.3	BF7667	M14 x 1.5	M14 x 1.5	2 5/32	54.8	4 7/16	112.7	BF1186
3/8	M16 x 1.5	2 5/32	54.8	4 7/8	123.8	BF868	M14 x 1.5	M14 x 1.5	2 17/32	64.3	3 3/4	95.3	BF7961
3/8	M16 x 1.5	2 5/32	54.8	5 3/8	136.5	BF1171	M14 x 1.5	M14 x 1.5	2 3/4	69.9	4 9/32	108.7	BF1148
13/32	1/2	3 19/32	91.3	4 23/32	119.9	BF7778	M14 x 1.5	M14 x 1.5	3 5/32	80.2	5 1/8	130.2	BF46200
7/16	3/8	3 5/8	92.1	4 29/32	124.6	BF9846	M16 x 1.5	3/8	2 1/8	54.0	6 1/4	158.8	BF7776
7/16	7/16	3 7/16	87.3	6 1/2	165.1	BF46218	M16 x 1.5	3/8	2 1/8	54.0	6 9/16	166.7	BF7775
7/16	7/16	3 15/32	88.1	8 1/4	209.6	BF46219	M16 x 1.5	3/8	2 9/32	57.9	5 3/8	136.5	BF7658
1/2-20	1/8-27	1 11/32	34.1	1 15/16	49.2	BF920	M16 x 1.5	3/8	2 5/16	58.7	5 11/32	135.7	BF7808
1/2	1/2	1 29/32	48.4	4 1/4	108.0	BF7693	M16 x 1.5	M16 x 1.5	2 5/16	58.7	4 7/16	112.7	BF853
1/2	1/2	2	50.8	4 7/16	112.7	BF7691							
9/16-18	9/16-18	1 29/32	48.4	3 7/8	98.4	BF9886							

NOTES



WARNING: These products can expose you to chemicals, including Diisononyl Phthalate, Carbon black extracts, Nickel, 1,3 Butadiene, Ethylene Oxide, Epichlorohydrin, which are known to the State of California to cause cancer, and Bisphenol-A, Ethylene Glycol, Ethylene Oxide, 1,3 Butadiene, Epichlorohydrin, which are known to the State of California to cause birth defects or other reproductive harm. For more information go to www.P65Warnings.ca.gov.

UPC CODE EXPLANATION

Baldwin Filters uses the “A” version of the UPC code. This is a twelve digit numeric bar code symbol, utilizing a series of narrow and wide parallel bars and spaces to represent numeric characters in a machine readable format.

The first digit of the bar code identifies the product category. The second, third, fourth, fifth and sixth digits are the vendor’s identification code assigned by the UPC Council. The seventh, eighth, ninth, tenth and eleventh digits are the vendor’s product code numbers assigned by the vendor. The twelfth digit is a check digit confirming the code has been accurately read.

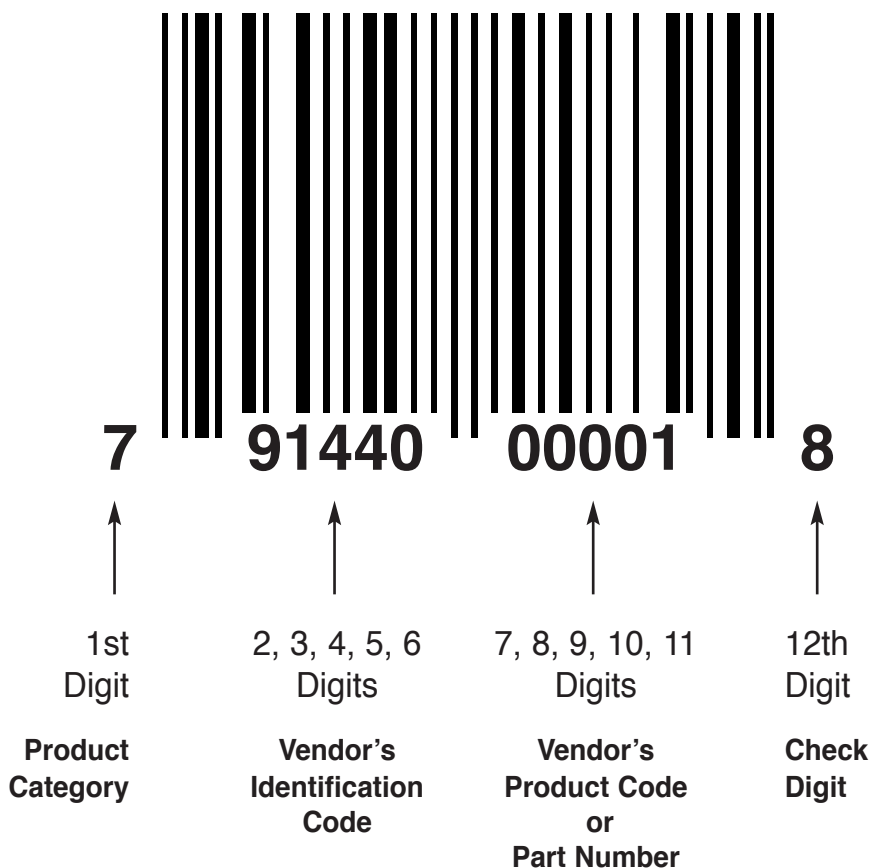

BALDWIN TO UPC (INDIVIDUAL PARTS)

BALDWIN NUMBER	UPC NUMBER	BALDWIN NUMBER	UPC NUMBER	BALDWIN NUMBER	UPC NUMBER	BALDWIN NUMBER	UPC NUMBER	BALDWIN NUMBER	UPC NUMBER
B2	791440000018	PT83-MPG	791440001060	P150	791440001947	PF224	791440002838	B307	791440003705
B2-HPG	791440000025	P84-2	791440001084	PT151	791440001954	PF225	791440002852	T308-M	791440003712
B4	791440000049	PT85	791440001091	PT152	791440001961	PF226	791440002876	B309	791440003729
BT5	791440000056	PT86-HD	791440001107	PT153	791440001978	B227	791440002883	BT310	7914400038462
B6	791440000063	PT87-S	791440001114	PT154	791440001985	B228	791440002890	PF311	791440003736
B6-HPG	791440000070	PT88-HD	791440001121	PF155	791440001992	B229	791440002906	PF312	791440003743
B7	791440000087	PT89	791440001138	B156	791440002005	BT230	791440002913	PF313	791440003750
B9	791440000094	PT90-10	791440001145	B157	791440002012	PF231	791440002920	PF314	791440003767
B10-AL	791440000100	PT90-MPG	791440001152	B159	791440002036	BD232	791440038455	PF316	791440003774
B10-AL BOWL	791440000117	PT91	791440001169	B160	791440002043	B233	791440002937	PT317-MPG	791440003781
B10-AL BSP	791440065482	PT93	791440001183	B161-S	791440002050	BT234	791440002951	PT318-MPG	791440003788
B10-AL BSPCS	791440088658	PT93-MPG	791440001190	P162	791440002067	P235	791440002968	PT319-MPG	791440003804
B10-AL CAP	791440000124	B95	791440001213	B163	791440002074	B236	791440002975	PT320-MPG	791440003811
PF10	791440000131	B95-MPG	791440001244	B164	791440002081	BT237	791440002982	BD324	791440003859
PF10-CS	791440000148	B95-SS	791440050396	B166	791440002104	BT238	791440002999	BD325	791440047518
PT11	791440000155	B96	791440001251	B167	791440002111	B239	791440003002	B326	791440003866
PT11-HD	791440000162	B96-MPG	791440001282	B168	791440002128	P240	791440003019	B329	791440003880
PT12	791440000179	B96-SS	791440050389	P170	791440002142	BT241	791440003026	BF330	791440003897
BF13	791440000186	B97	791440001299	P171	791440002159	P242	791440003033	PF332	791440003903
P15	791440000193	PT98-10	791440001305	P172	791440002166	B243	791440003040	B333	791440003910
S16-1	791440000209	PT98-MPG	791440001312	B173-S	791440002173	B244	791440003057	BT334	791440003927
P18	791440000230	B99	791440001329	P174	791440002180	B246	791440003071	B336	791440003941
P18-HD	791440000247	B99-B	791440001336	P176	791440002203	B247	791440003088	B337	791440003958
P19	791440000254	B99-MPG	791440001350	P177	791440002210	BT248	791440003095	BT338	791440003965
P20-HD	791440000261	B99-SS	791440050419	B178	791440002227	P249	791440003101	BT339	791440003972
P25	791440000339	P102	791440001381	B179	791440002234	BT251	791440003118	BT340	791440003989
P26	791440000346	BD103	791440001398	PT181 KIT	791440002258	B252	791440003125	BT341	791440003996
B27	791440000353	BD103-MPG	791440042674	P183	791440002272	B253	791440003132	BT342	791440004009
BD28	791440000360	BD103-SS	791440050402	P184	791440002296	B255	791440003156	BT343	791440004016
PT29	791440000377	P104	791440001404	PT185	791440002302	PT256	791440003163	BT344-S	791440004023
AFG30	791440000384	B105	791440001411	P186	791440002319	PT257	791440003170	BT345 KIT	791440004030
B30	791440000391	P106	791440001428	P187	791440002326	BT258	791440003187	BT346	791440004047
B31	791440000407	P106-HD	791440001435	PT189	791440002340	BT259	791440003194	BT347	791440004054
B33	791440000421	PT108	791440001459	PT189-MPG	791440002357	BT260	791440003200	BT348	791440004061
B34	791440000438	PT108-HD	791440001466	P190	791440002364	BT260-10	791440003217	BT349	791440004078
B35-S	791440000445	B109	791440001473	PT191	791440002371	BT261	791440003224	BT350	791440004085
AFG37R	791440000469	BC110	791440001480	PT191-10	791440002388	B262	791440003231	BT351	791440004092
B37	791440000476	BT111	791440001497	PT191-5	791440002395	B263	791440003248	BT351-MPG	791440069701
AFG38D	791440000483	BT112	791440001503	PT193	791440002418	BT264	791440003255	P352	791440004108
B39	791440000506	B113	791440001510	PT193 KIT	791440002425	PT265	791440003262	BT353	791440004115
P40	791440000513	B114	791440001527	PT193-3	791440002432	P266	791440003279	BT354	791440004122
P41	791440000520	PT115	791440001534	P194	791440002449	BT267	791440003286	BT355	791440004139
P42	791440000537	P116	791440001541	PT194-HD	791440002456	PT268	791440003293	P356	791440004146
B43-S	791440000544	PF116	791440001558	P194-HD10	791440002463	PT269	791440003309	BT357	791440004153
B45	791440000568	PT117	791440001565	PF194	791440002470	P271	791440003323	B358	791440004160
P47	791440000582	PT117-25	791440001572	B195	791440002487	PT273	791440003347	BT359	791440004177
PT48	791440000599	B118	791440001589	B196	791440002494	BT274	791440003354	B360	791440004184
B49	791440000605	PT119	791440001596	P198	791440002517	PT275	791440003361	BT361	791440004191
B50	791440000612	PT119-5	791440001602	B199	791440002524	PT275-10	791440003378	BT364	791440004214
P52	791440000636	PT119-HD	791440001619	B201-S	791440002548	P276	791440003385	BT365	791440004221
P53	791440000643	PT119-HD5	791440001626	B202	791440002555	PT277	791440003408	BT365-10	791440004238
P54	791440000650	B120	791440001640	P203	791440002562	B279	791440003415	BT366-10	791440004245
B56	791440000674	PF121	791440001657	P203-HD	791440002579	P280	791440003422	BT366-MPG	791440069695
P60	791440000711	PT122-5	791440001664	P203-HD10	791440002586	B281	791440003439	BT367	791440004252
PT61-HD	791440000728	BT124	791440001688	P204	791440002593	PT283	791440003460	BT367-S	791440004269
PT62	791440000735	P125	791440001695	P204-HD	791440002609	PT284	791440003477	BT368	791440004276
PT63-1	791440000742	BT126	791440001701	P204-HD10	791440002616	PT285	791440003484	B369	791440004283
PT66-HD	791440000773	P127	791440052918	B205	791440002623	BT287	791440003491	PT370	791440004290
P67	791440000780	B128	791440001718	P206	791440002630	BT287-3	791440058231	BT371-5	791440069718
P68	791440000797	B129	791440001725	PT207	791440002647	BT287-10	791440003507	BT371-10	791440004306
PT70	791440000810	B131	791440001749	PT207-10	791440002654	PT288-HD	791440003514	BT371-MPG	791440004313
PT71	791440000834	B132	791440001756	PT207-HD	791440002661	PT288-HD10	791440003521	BT372-10	791440004320
PT72	791440000858	C133-OW	791440001763	PT207-HD10	791440002678	PT289	791440003538	BT372-MPG	791440004327
P73	791440000872	C133-W	791440001770	PT208	791440002685	PT289-10	791440003545	PT373	791440004337
B74	791440000889	B134	791440001787	PT210	791440002692	PT290	791440003552	PT374	791440004344
B75	791440000896	PT135	791440001794	B211	791440002708	BT292	791440003576	PT375	791440004351
B76	791440000902	PT137	791440001817	PT212-5	791440002715	P294	791440003590	PT376	791440004368
B76-MPG	791440000933	PT138-10	791440001824	PT213	791440002722	B295	791440003606	PT377	791440004375
B76-SS	791440050426	PT138-25	791440001831	PT214(2)	791440002739	B296	791440003613	PT377-10	791440004382
PT79	791440000964	PT139-10	791440001848	BT215	791440002746	PT298-10	791440003620	B378	791440004399
P80	791440000988	P140	791440001855	BT216	791440002753	B299	791440003637	BT378-10	791440004405
P80-HD	791440000995	B141	791440001862	BT217	791440002760	T300-M	791440003644	PT379 KIT	791440004412
P81	791440001015	BD142	791440001879	B218	791440002777	B301	791440003651	PT380 KIT	791440004429
P82	791440001022	B143	791440001886	B220	791440002791	PT302	791440003668	PT381	791440004436
PT82-HD	791440001039	P144	791440001893	BT221	791440002807	T303-M	791440003675	PT382	791440004443
PT82-HD10	791440001046	PT146	791440001909	B222	791440002814	PT304	791440003682	PT383	791440004450
PT83	791440001053	P148	791440001923	BT223	791440002821	BT305	7914400038059	PT385	791440004467



WARNING: These products can expose you to chemicals, including Diisononyl Phthalate, Carbon black extracts, Nickel, 1,3 Butadiene, Ethylene Oxide, Epichlorohydrin, which are known to the State of California to cause cancer, and Bisphenol-A, Ethylene Glycol, Ethylene Oxide, 1,3 Butadiene, Epichlorohydrin, which are known to the State of California to cause birth defects or other reproductive harm. For more information go to www.P65Warnings.ca.gov.

BALDWIN TO UPC (INDIVIDUAL PARTS)

BALDWIN NUMBER	UPC NUMBER	BALDWIN NUMBER	UPC NUMBER	BALDWIN NUMBER	UPC NUMBER	BALDWIN NUMBER	UPC NUMBER	BALDWIN NUMBER	UPC NUMBER
PT385-E	791440004474	PT462	791440005419	PT554	791440006379	PA652	791440007376	BT775	791440008403
PT386	791440004481	PT463	791440005426	P555	791440006386	PA653	791440007383	PT776-MPG	791440008410
BT387	791440004488	PT466	791440005457	BT556-10	791440006393	PA654	791440007390	PT777	791440008427
BT387-10	791440004504	PT467-MPG	791440005464	PT558	791440006416	PA655	791440007406	BT778	791440008434
BT388	791440004511	PT468-MPG	791440005471	PT560 KIT	791440006423	PA656	791440007413	BT779	791440008441
BT388-10	791440004528	PT469	791440005488	PT561	791440006430	PA657	791440007420	BF781	791440008458
BT389	791440004535	BT470	791440005495	PT562-10	791440006454	PA658	791440007437	BF782	791440008465
BT389-10	791440004542	PT471	791440005501	PT563	791440006461	PA662	791440007475	BF783	791440008472
PT390-MPG	791440004559	BT472	791440005518	BT564	791440006478	PA666	791440007505	BF784	791440008489
PT391-MPG	791440004566	B474	791440005525	PT565	791440006485	PA669	791440007512	BF785	791440008496
PT392	791440004573	PT475	791440005532	PT566	791440006492	PT670	791440007529	BF786	791440008502
PT393	791440004580	P476	791440005549	PT567	791440006508	PT670-E	791440007536	BF788	791440008526
PT394-5	7914400045163	PT477	791440005556	PT567-10	791440006515	PA671	791440007543	BF789	791440008533
PT394-15	791440004597	S479	791440005570	PT568	791440006522	PA671-1	791440007550	BF790	791440008540
BT395	791440004603	PT480	791440005587	PT571	791440006553	PA675	791440007567	BF791	791440008557
PT396	791440004610	PT480-10	791440005594	PT573	791440006577	PT676	791440007574	BF791-O	7914400097612
PT397	791440004627	PT480-MPG	791440005600	BF577	791440006607	PA677	791440007581	BF792	791440008564
BT398	791440004634	BT472	791440005617	B481	791440006614	PA678	791440007598	BF794	791440008588
PT400	791440004641	PT483	791440005631	PT579	791440006621	PA680	791440007604	BF795	791440008595
PT401-MPG	791440004658	S485	791440005655	BF582	791440006676	PT682	7914400052970	BF797	791440008618
BT402	791440004665	BT486	791440005662	BF583	791440006683	PT683	7914400052987	BF798	791440008625
B403	791440004672	PT487	791440005679	BF584	791440006690	PT685-MPG	791440007611	BF799	791440008632
B404	791440004689	B488	791440005693	BF584-B	791440006706	PA691	791440007628	PF802	791440008670
JC405	791440004696	S489	791440005709	BF585	791440006713	PT691	7914400054844	PF804	791440008694
CU406	791440004702	PT490	791440005716	BF586	791440006720	PA693	791440007635	BF805	791440008700
DF408	791440004719	PT491	791440005723	BF586-D	791440006737	PT694	791440007642	BF806	791440008717
TC413-CPE5	791440004849	PT491-10	791440005747	BF587	791440006744	PA696	791440007666	PF807	791440008724
V414-B	791440004863	PT492	791440005754	BF587-D	791440006751	PA697	791440007673	PF809	791440008748
V414-FF	791440004870	PT493	791440005761	BF588	791440006768	PA699	791440007680	PF810	791440008755
F415-B	791440004887	B494	791440005778	BF591	791440006874	C704-L	791440007727	PF811	791440008762
P415-10	791440004890	B495	791440005785	BF592	791440006881	PT706-M	791440007741	BF812	791440008779
P415-10A	791440004904	B495-MPG	7914400062474	BF593	791440006898	PT707-HD	791440007765	PF814	791440008793
P415-25	791440004917	B495-SS	7914400050341	F594-F	7914400052949	PT707-HD10	791440007772	PF816	791440008816
P415-25A	791440004924	P496	791440005815	PF594	791440006904	PT707-HD3	791440007789	PF816-S	791440008823
P415-5	791440004931	P497	791440005822	PT595	791440006911	PT708-HD	791440007796	PF818	791440008847
P415-5A	791440004948	PT498	791440005839	BF596	791440006928	PT714	791440007802	PF819	791440008854
P415-5AN	791440004955	PT498-10	791440005846	BF597	791440006935	PT716	7914400050938	PF819-HD	791440008861
P415-GM	791440004962	PT499-5	791440005853	PF598	791440006942	PF717	791440007819	PF820-S	791440008877
V415-B	791440004979	F501-MD	791440005884	PF598-10	791440006959	PT718-5	791440007833	PF821-S	791440008885
V415-FF	791440004986	PT503	791440005907	PF599-30	791440006966	BF719	791440007840	PF822	791440008892
PT416	791440004993	PF506	791440005921	PF599	791440006973	BF720	791440007857	PF823	791440008908
PT418	791440005013	P507	791440005938	PF599-10	791440006980	P721	791440007864	PF823-E	791440008953
BT420	791440005037	PT508-MPG	791440005945	PF599-30	791440006997	PT722	791440007871	PF824	791440008960
B421	791440005044	PT509-MPG KIT	791440005952	PA602	791440007000	P723	791440007888	BF825	791440008984
S423	791440005051	PT510	791440005969	PA604	791440007017	PT725-MPG	791440007895	PF826	791440008991
BT424	791440005068	PT512	791440005976	B605	791440007024	PT727-DL	791440007901	PF827	791440009004
BT425	791440005075	PT513	791440005983	BT606-MPG	791440004647	PT727-HD	791440007918	PF828	791440009028
PT426	791440005082	PT514	791440005990	PA607	791440007048	PT727-HD10	791440007925	PF829(2)	791440009035
BT427	791440005099	PT515	791440006003	BT610-MPG	7914400045927	PT728-MPG	791440007932	BF830	791440009042
V429-B	791440005112	PT516	791440006010	BT611-MPG	7914400045958	PT729	791440007949	PF831	791440009059
V429-FF	791440005129	PT517	791440006027	PA612	791440007086	BT732	791440007970	BF833	791440009073
PT430-FF	791440005136	PT518	791440006034	PA613	791440007093	BT735	791440007994	BF833-K2	791440009080
PT431	791440005143	PT518-10	791440006041	BF614	791440007109	PT737	791440008014	F834-F	791440009097
PT433	791440005150	PT520	791440006058	PA615	791440007116	PT737-10	791440008021	PF834	791440009103
PT434	791440005167	BT521	791440006072	PA616	791440007123	V738-O	791440008038	BF836	791440009127
PT434-10	791440005174	PT522	791440006089	PA617	791440007130	BT739	791440008045	BF836-K3	791440009134
PT435	791440005181	BT525	791440006096	PA618	791440007147	C740-S	791440008052	BF836-K4	791440009141
PT436	791440005198	BT526	791440006102	PA618 FOAM	791440007154	C750-E	791440008144	BF837	791440009158
PT437	791440005204	BT526-10	791440006119	PA618-S	791440007161	C750-L	791440008151	BF838-F2	791440009165
BT438	791440005211	PT527	791440006126	PA621	791440007185	C750-L SINGLE	791440008168	PF838	791440009172
PT439	791440005228	P528	791440006133	PA625	791440007192	PT751	791440008175	BT839	791440009189
BT440	791440005235	P529	791440006140	PA631	791440007208	PT752	791440008182	BT839-10	791440009196
PT441	791440005242	PT534	791440006188	PA632	791440007215	PT753	791440008199	BF840	791440009202
PT442-MPG	791440005259	PT535	791440006195	PA633(2)	791440007222	PT757	791440008212	BF840-K1	791440009219
BT443	791440005266	BT536	791440006201	PA634	791440007239	PT757-10	791440008229	VT842-O	791440009233
PT445-MPG	791440005273	P537	791440006218	PA638	791440007246	PT760-10	791440008243	BF843	791440009240
P446	791440005280	PT538	791440006225	PA639	791440007253	PT760-25	791440008250	F844-A	791440009257
B447	791440005297	PT539	791440006232	PA640	791440007260	PT761	791440008267	F845-A	791440009264
P450	791440005310	P540	791440006249	PA641	791440007277	PT763	791440008281	PF845	791440009271
S451	791440005327	BT541	791440006263	PA642	791440007284	PT764	791440008298	PF846	791440009288
BT452	791440005334	PT543 KIT	791440006287	PA643	791440007291	PT765	791440008304	PF847	791440009295
P454	791440005358	P545	791440006300	PA644	791440007307	PT766	791440008311	PT849	791440009318
S455	791440005365	PT546	791440006317	PA645	791440007314	PT767	791440008328	PT849-10	791440009325
S456	791440005372	PT548	791440006324	PA648	791440007338	PT768	791440008335	V852-O	791440009356
PT457-MPG	791440005389	PT549	791440006331	PA649	791440007345	PT772	791440008373	BF853	791440009363
PT459	791440005396	PT550-10	791440006348	PA650	791440007352	PT773-MPG	791440008380	BF855	791440009387
PT461	791440005402	PT551-10	791440006355	PA651	791440007369	BT774	791440008397	BF856	791440009394



WARNING: These products can expose you to chemicals, including Diisononyl Phthalate, Carbon black extracts, Nickel, 1,3 Butadiene, Ethylene Oxide, Epichlorohydrin, which are known to the State of California to cause cancer, and Bisphenol-A, Ethylene Glycol, Ethylene Oxide, 1,3 Butadiene, Epichlorohydrin, which are known to the State of California to cause birth defects or other reproductive harm. For more information go to www.P65Warnings.ca.gov.

BALDWIN TO UPC (INDIVIDUAL PARTS)

BALDWIN NUMBER	UPC NUMBER	BALDWIN NUMBER	UPC NUMBER	BALDWIN NUMBER	UPC NUMBER	BALDWIN NUMBER	UPC NUMBER	BALDWIN NUMBER	UPC NUMBER
PF857	79144009400	PF949	791440010529	BF1181	791440049086	BF1282	791440057906	BF1371	791440079038
BF858	79144009417	F950-F	791440010536	BF1182	791440049116	BF1282-O	791440094529	BF1372	791440079342
PF859	79144009424	F950-F WO	791440053007	BF1184	791440049123	BF1283	791440063280	BF1373-SP	791440079199
PF860	79144009431	PF950	791440010543	BF1185	791440049130	BF1283-O	791440093515	BF1374-SP	791440079267
PF861	79144009448	PT951	791440010550	BF1186	791440049147	BF1283-SP	791440078482	BF1375	791440079274
BF862	79144009455	PF952	791440010567	BF1190	791440049413	BF1285-SP	791440064805	BF1376	791440079304
BF863	79144009462	F953-F	791440053014	BF1191	791440049420	BF1286	791440066052	BF1377	791440079359
PF864	79144009479	BF954	791440010574	BF1193	791440049444	BF1287-O	791440086395	BF1378-SPS	791440079502
BF865	79144009486	BF955	791440010581	BF1195	791440049468	BF1288-O	791440086401	BF1379	791440079618
BF865-K	79144009493	BF955 KIT	791440112490	BF1199	791440049529	BF1289-SP	791440086852	BF1379-O	791440111226
PF866	79144009509	BF956	791440010598	BF1201	791440011441	PF1291	791440062511	BF1380	791440079625
BF868	79144009523	BF957	791440010604	BF1204	791440045828	BF1292-O	791440087446	BF1380-O	791440110816
PF869	79144009530	BF957-D	791440010628	BF1204-O	791440097605	BF1293-SPS	791440078048	BF1381	791440079632
PF872	79144009554	BF958	791440010635	BF1204-SP	791440045910	BF1294-O	791440087453	BF1381-O	791440109537
BF873	79144009561	BF959	791440010642	BF1205	791440045811	BF1296-O	791440087613	BF1382-SP	791440079656
BF874	79144009578	P960	791440010659	BF1205-SP	791440045835	BF1297-O	791440087620	BF1383-O	791440087125
BF876	79144009592	BF962	791440010673	BF1210	791440011472	BF1298-O	791440088672	BF1384-SP	791440080249
BF877	79144009615	PF963	791440010680	BF1211	791440011489	BF1299-O	791440089112	BF1385-SPS	791440080843
BF879	79144009646	BF966	791440010710	BF1212	791440011496	FB1301	791440011731	BF1386-O	791440081253
BF880-FP	791440037991	PF967	791440010727	BF1212 FOAM	791440011502	FB1302	791440011748	BF1387-O	791440081345
BF881	79144009660	BF968	791440010734	BF1213	791440011526	OB1303	791440011755	BF1388-O	791440081352
PF882	79144009677	BF970	791440010741	BF1214	791440011533	OB1305	791440011779	BF1389-O	791440081567
PF883	79144009684	BF971	791440010758	BF1215	791440049383	FB1306	791440077447	BF1390-O	791440082205
BF884	79144009691	BF974-D	791440010772	BF1216	791440011540	FB1307	791440011786	BF1391-O	791440082250
BF885	79144009707	B975	791440010789	BF1217	791440051089	OB1308	791440011793	PF1392	791440086562
BF886	79144009714	BF976	791440010796	BF1218	791440011557	FB1309	791440011809	BF1392-SPS KIT	791440082748
BF888	79144009721	BF978	791440010819	BF1219	791440011564	FB1310	791440011816	BF1393-SP	791440082922
BF890	79144009745	BF979	791440010826	BF1220	791440011571	FB1311	791440011823	BF1394-SP	791440083042
BF891	79144009752	BF980	791440010833	BF1221	791440011588	OB1313	791440011830	BF1395-O	791440080521
BF892	79144009769	PF981	791440010840	BF1222	791440045675	OB1314	791440011847	BF1395-SP	791440083080
PF893	79144009776	BF984	791440010864	BF1222-O	791440087217	OB1315	791440011854	BF1396	791440083226
BF893-RV	79144009783	PF986	791440010871	BF1222-SP	791440045668	OB1316	791440011861	BF1397-SP	791440084001
PF894	79144009790	PF987	791440010888	BF1223	791440011595	OB1317	791440011878	BF1398-O	791440083288
PF894-RV	79144009806	BF988	791440010895	BF1223-O	791440087354	OB1318	791440011885	BF1399-SP	791440084094
BF896	79144009820	BF989	791440010901	BF1223-SP	791440046115	OB1319	791440011892	B1400	791440012035
BF897 KIT	79144009837	BF991	791440010925	BF1224	791440045033	OB1320	791440011908	B1402	791440012059
SF898	79144009844	BF992	791440010932	BF1225	791440011601	VG1325	791440011953	BD1403	791440054899
PF899	79144009851	BF995	791440010956	BF1226	791440011618	PG1326	791440011960	B1405	791440043442
BF900	79144009868	P996	791440010963	BF1231	791440043343	BF1329	791440045705	B1406	791440012080
PF902	79144009899	PF997	791440053021	BF1232	791440011632	BF1329-SP	791440045644	B1407	791440012097
PF902-S	79144009905	P998	791440010970	BF1233	791440011649	BF1330-SP	791440058033	B1410	791440043558
PT903	79144009912	P999-HD	791440010994	BF1239	791440042520	BF1339-SP	791440065437	B1413	791440045545
PF906	79144009950	BF1008	791440049871	BF1240	791440050327	BF1345	791440037892	B1416	791440054691
PF907	79144009967	V1044-O	791440011069	V1240-C	791440011670	BF1345-O	791440087262	P1418	791440050136
F908-A	79144009974	BF1045	791440049574	BF1248	791440050488	BF1345-SP	791440045804	P1419	791440050143
BF909	79144009981	BF1046	791440049581	BF1249	791440050983	BF1346	791440038356	B1421	791440050587
PF910	79144009998	BF1047	791440049598	BF1249-O	791440093423	BF1346-O	791440088467	B1422	791440050846
BF912	791440010024	BF1048	791440049604	BF1249-SP	791440052666	BF1346-SP	791440066014	B1425	791440051782
PF913	791440010031	BF1049	791440049611	BF1252	791440051041	BF1347	791440045781	B1428	791440012127
BF914	791440010048	BF1050	791440049628	BF1253	791440051515	BF1347-O	791440104662	B1429	791440038219
BF915	791440010055	BF1052	791440050549	BF1256	791440054530	BF1348	791440045903	B1430	791440043077
F916-C	791440010062	BF1053	791440050563	BF1257	791440053366	BF1348-O	791440088474	B1431	791440055865
PF916	791440010079	BF1056	791440050822	BF1258	791440047174	BF1348-SP	791440051898	B1432	791440055919
BF918-K	791440010109	BF1057	791440051171	BF1259	791440011694	BF1349	791440050624	P1433	791440056589
F919-C	791440010147	BF1058	791440051188	BF1261	791440054875	BF1350-SP	791440065062	B1434	791440058477
BF920	791440010192	BF1061	791440051201	BF1262	791440056817	BF1352-SPS	791440078161	B1435	791440058910
PF924	791440010239	BF1100	791440047723	BF1265	791440058286	BF1353-SPS	791440067462	B1438	791440058743
PF926	791440010253	BF1102	791440011076	BF1266	791440058729	BF1354-SPS	791440080645	P1440	791440058996
BF928	791440010277	BF1104	791440011090	BF1267	791440058781	BF1355	791440078604	B1441	791440060654
BF929	791440010284	BF1105	791440011106	BF1268	791440059023	BF1355-O	791440090460	P1443	791440060678
BF930	791440010291	BF1110	791440011144	BF1269	791440059290	BF1355-SP	791440076419	B1444	791440061651
BF932	791440010321	BF1120	791440011175	BF1270-SP	791440059375	BF1356	791440076754	B1446	791440062529
BF933	791440010338	BF1123	791440011182	BF1271	791440059856	BF1357	791440076853	B1447	791440064958
PF935	791440010352	BF1140	791440011250	BF1272-SPS	791440078055	BF1358-O	791440091313	P1510	791440012172
PF936	791440010369	BF1148	791440011281	BF1273-SP	791440056749	BF1358-SP	791440076877	P1511	791440012189
PF937	791440010376	BF1150	791440011298	BF1274-SP	791440059733	BF1359-SP	791440077775	V1520-R	791440012196
BF938	791440010383	BF1160	791440011342	BF1274-SPS	791440059740	BF1360	791440077973	V1542-C	791440012219
BF939	791440010390	BF1163	791440011366	BF1275	791440063785	BF1360-O	791440104655	V1544-T	791440012226
BF940	791440010406	BF1166	791440011380	BF1276	791440011700	BF1360-SP	791440083325	V1560	791440062580
BF941	791440010413	BF1170	791440011427	BF1277-SP	791440056732	BF1361	791440078185	P1561	791440075351
PF942	791440010420	BF1171	791440011434	BF1277-SPS	791440059337	BF1362	791440078499	P1562	791440075368
PF943	791440010437	BF1172	791440050266	BF1278	791440064072	BF1363	791440078611	P1563	791440075375
PF945	791440010451	BF1173	791440041493	BF1278-O	791440095120	BF1365	791440078758	P1565	791440075399
PF946	791440010468	BF1174	791440048898	BF1279	791440064089	BF1366-O	791440085855	P1566	791440075405
PF947	791440010475	BF1177	791440049024	BF1280	791440011717	BF1367	791440078994	P1567	791440075436
BF948	791440010482	BF1178	791440049031	BF1281	791440063297	OB1368	791440012011	P1568	791440075443
BF948-JD	791440010512	BF1179	791440049048	BF1281-O	791440093492	BF1370	791440079014	P1575	791440075559



WARNING: These products can expose you to chemicals, including Diisononyl Phthalate, Carbon black extracts, Nickel, 1,3 Butadiene, Ethylene Oxide, Epichlorohydrin, which are known to the State of California to cause cancer, and Bisphenol-A, Ethylene Glycol, Ethylene Oxide, 1,3 Butadiene, Epichlorohydrin, which are known to the State of California to cause birth defects or other reproductive harm. For more information go to www.P65Warnings.ca.gov.

BALDWIN TO UPC (INDIVIDUAL PARTS)

BALDWIN NUMBER	UPC NUMBER	BALDWIN NUMBER	UPC NUMBER	BALDWIN NUMBER	UPC NUMBER	BALDWIN NUMBER	UPC NUMBER	BALDWIN NUMBER	UPC NUMBER
PA1577	791440075573	PA1670	791440012974	PA1795	791440013810	LL1895	791440014633	SA2027	791440015562
PA1578	791440075634	PA1673	791440012981	PA1797	791440013827	PA1895	791440014640	PA2031	791440015579
PF1584	791440075528	PA1674	791440012998	PA1798	791440013834	PA1896	791440014657	PA2036	791440015609
PF1585	791440075535	PA1675	791440013001	PA1800	791440013841	PA1897	791440014664	PA2037	791440015616
PF1587	791440075597	LL1676-FN	791440013018	PA1802	791440013865	PA1898	791440014671	PA2038	791440015623
PA1600	791440012233	PA1676-FN	791440013025	PA1805	791440013889	PA1899	791440014688	SA2039	791440015630
PA1602	791440012240	PA1679	791440013032	PA1806	791440013896	PA1900	791440014695	PA2041	791440015647
PA1603	791440012257	PA1680	791440013049	PA1809	791440013919	PA1901	791440014701	PA2042	791440015654
PA1606	791440012264	LL1681-FN	791440013056	PA1810	791440013926	LL1902-FN	791440014718	PA2044	791440015661
PA1607	791440012271	PA1681-FN	791440013063	PA1814	791440013940	PA1902-FN	791440014725	SA2047	791440015683
LL1608	791440012288	PA1682	791440013070	PA1815	791440013957	PA1904	791440014732	PA2050	791440015692
PA1608	791440012295	PA1683	791440013087	PA1816	791440013964	PA1905	791440014749	PA2051	791440015708
PA1609	791440012301	PA1684	791440013094	PA1817	791440013971	PA1906	791440014756	PA2052	791440015715
PA1610	791440012318	PA1686	791440013100	PA1818	791440013988	PA1907-FN	791440014763	PA2053	791440015722
PA1613	791440012325	PA1687	791440013117	PA1819	791440013995	PA1909	791440014770	PA2061	791440015777
PA1613-S	791440012332	PA1688	791440013124	PA1821	791440014008	PA1911	791440014787	PA2063	791440015791
LL1614	791440012349	PA1689	791440013131	PA1822-FN	791440014015	PA1912	791440014794	PA2064	791440015807
PA1614	791440012356	LL1690-FN	791440013148	PA1823	791440014022	PA1913	791440014800	PA2065	791440015814
LL1615	791440012363	PA1690-FN	791440013155	PA1824	791440014039	PA1915	791440014817	PA2067	791440015838
PA1615	791440012370	PA1692	791440013162	PA1825	791440014046	PA1916	791440014824	PA2067 FOAM	791440073432
PA1615XP	791440090613	PA1696	791440013179	PA1826	791440014053	PA1919-FN	791440014831	PA2068	791440015845
PA1618	791440012394	PA1697	791440013186	PA1827	791440014060	PA1920	791440014848	PA2068 FOAM	791440067646
PA1619	791440012400	PA1698	791440013193	PA1828	791440014077	PA1921	791440014855	PA2069	791440015852
PA1620	791440012417	PA1699-FN	791440013209	PA1830-FN	791440014084	PA1922	791440014879	PA2069 FOAM	791440073425
PA1620-S	791440012424	PA1700	791440013216	PA1831	791440014091	PA1922-FN	791440014886	PA2070	791440015869
LL1621-2	791440012431	PA1701	791440013230	PA1832	791440014107	PA1926	791440014916	PA2071	791440015876
PA1621	791440012448	PA1701 ELE	791440013247	PA1834	791440014114	PA1932	791440014923	PA2072	791440015883
PA1621-2	791440012455	PA1701 FOAM	791440013254	PA1836	791440014121	PA1934	791440014930	PA2073	791440015890
PA1621-S	791440012462	PA1702	791440013261	PA1837-FN	791440014138	PA1936	791440014947	PA2074	791440015906
PA1625	791440012486	PA1702 FOAM	791440013285	PA1840	791440014152	PA1937	791440014954	PA2075	791440015913
LL1626-2	791440012493	PA1703	791440013292	PA1841	791440014169	PA1940	791440014961	PA2076	791440015920
PA1626	791440012509	PA1704	791440013315	PA1845	791440014176	PA1941-FN	791440014978	PA2077	791440015937
PA1626-2	791440012516	PA1705-2	791440013322	LL1846	791440014183	PA1945	791440015005	PA2079	791440015951
PA1627	791440012523	PA1706	791440013339	PA1846	791440014190	PA1946	791440015012	PA2081	791440015968
PA1629-S	791440012530	PA1707-FN	791440013346	PA1846XP	791440090774	PA1949	791440015029	PA2083	791440015982
LL1630-2	791440012547	PA1709	791440013353	PA1847-FN	791440014213	PA1951	791440015043	SA2084	791440015999
PA1630	791440012554	PA1710	791440013360	PA1848	791440014220	PA1952	791440015050	SA2085	791440016002
PA1630-2	791440012561	PA1712	791440013377	PA1849	791440014237	PA1953	791440015067	PA2091	791440016057
PA1631-S	791440012578	PA1718	791440013391	PA1850-FN	791440014244	PA1956-FN	791440015081	PA2092	791440016064
PA1632	791440012585	PA1719	791440013407	PA1851	791440014251	PA1957	791440015098	PA2093	791440016071
PA1633	791440012608	PA1721	791440013414	PA1852	791440014268	PA1960	791440015104	PA2094	791440016088
LL1634	791440012615	PA1726	791440013421	PA1857	791440014299	PA1961	791440015111	PA2095	791440016095
PA1634	791440012622	PA1735	791440013445	PA1858	791440014305	PA1963	791440015128	PA2096	791440016101
PA1634XP	791440090743	PA1748	791440013469	PA1859	791440014312	PA1967	791440015135	PA2099	791440016118
PA1635	791440012639	PA1749-FN	791440013476	PA1860	791440014329	PA1969	791440015142	PA2100	791440016125
LL1636-FN	791440012646	PA1750-FN	791440013483	PA1861	791440014336	PA1972	791440015166	PA2101A	791440016132
PA1636-FN	791440012653	PA1752-FN	791440013490	PA1863	791440014343	PA1973	791440015173	PA2102	791440016149
LL1637-FN	791440012660	PA1753-FN	791440013506	PA1864-FN	791440014367	PA1975	791440015197	PA2103	791440016156
PA1637-FN	791440012677	PA1754	791440013513	PA1865-FN	791440014374	PA1976	791440015203	PA2104	791440016163
PA1639	791440012684	PA1755-FN	791440013520	PA1866	791440014381	PA1977-FN	791440015210	PA2106	791440016187
PA1641	791440012691	PA1757	791440013537	PA1867	791440014398	PA1978-FN	791440015227	PA2107	791440016194
LL1642-2	791440012707	PA1758	791440013544	PA1868	791440014404	PA1979-FN	791440015241	PA2109	791440016217
PA1642-2	791440012714	PA1763	791440013551	PA1873	791440014411	PA1980-FN	791440015265	PA2110	791440016224
PA1643	791440012721	PA1765	791440013568	V1874-T	791440014428	PA1981	791440015272	PA2113	791440016255
PA1644	791440012738	PA1765 FOAM	791440013575	PA1875	791440014435	PA1982	791440015289	PA2114	791440016262
F1645-DS	791440012745	PA1768	791440013582	PA1877	791440014442	PA1985	791440015296	PA2115	791440016279
V1645-C	791440012752	PA1769	791440013599	PA1880	791440014459	PA1986	791440015302	PA2116	791440016286
LL1646-FN	791440012769	LL1761	791440013612	PA1881	791440014466	PA1986-K	791440015319	PA2117	791440016293
PA1646	791440012776	PA1772	791440013629	PA1882	791440014473	PA1987	791440015326	PA2121	791440016323
PA1646-FN	791440012783	PA1773	791440013636	LL1883-FN	791440014480	PA1989-FN	791440015333	PA2124	791440016354
PA1647	791440012790	PA1774	791440013643	LL1884	791440014497	LL1992	791440015340	PA2125	791440016361
PA1648	791440012806	PA1775	791440013650	PA1884	791440014503	PA1992-FN	791440015371	PA2127	791440016385
LL1649	791440012813	LL1766	791440013667	PA1884XP	791440090620	PA1995	791440015388	PA2134	791440016453
PA1649	791440012820	PA1777	791440013674	LL1885	791440014510	PA1996	791440015395	PA2135	791440016460
PA1650-FN	791440012837	PA1778	791440013681	PA1885	791440014527	PA1997	791440015401	PA2136	791440016477
PA1653	791440012851	PA1779	791440013698	PA1885XP	791440090545	PA1998	791440015418	PA2138	791440016491
V1656-O	791440012868	PA1780	791440013704	LL1886	791440014534	PA2001	791440015425	PA2139	791440016507
V1656-T	791440012875	PA1781	791440013711	PA1886	791440014541	PA2001 FOAM	791440042643	PA2139 FOAM	791440038585
PA1657	791440012882	PA1782	791440013728	PA1886XP	791440090736	PA2002	791440015432	PA2140	791440016514
PA1661(3)	791440012899	PA1783	791440013735	PA1888	791440014565	PA2005	791440015456	PA2147	791440016576
PA1663	791440012905	PA1784	791440013742	PA1889	791440014572	PA2006	791440015463	PA2148	791440016583
PA1664	791440012912	PA1786	791440013759	PA1891	791440014589	PA2007	791440015470	PA2149	791440016590
PA1666	791440012929	PA1787	791440013766	PA1892-FN	791440014596	PA2008	791440015487	PA2150	791440016606
LL1667-FN	791440012936	PA1788	791440013773	LL1893	791440014602	PA2009	791440015494	PA2152	791440016620
PA1667-FN	791440012943	PA1789	791440013780	LL1894	791440014619	PA2010	791440015500	PA2153	791440016637
LL1669	791440012950	PA1790	791440013797	PA1894	791440014626	PA2023	791440015531	PA2154	791440016644
PA1669	791440012967	PA1794-FN	791440013803	PA1894XP	791440090576	PA2024	791440015548	PA2156	791440016668



WARNING: These products can expose you to chemicals, including Diisononyl Phthalate, Carbon black extracts, Nickel, 1,3 Butadiene, Ethylene Oxide, Epichlorohydrin, which are known to the State of California to cause cancer, and Bisphenol-A, Ethylene Glycol, Ethylene Oxide, 1,3 Butadiene, Epichlorohydrin, which are known to the State of California to cause birth defects or other reproductive harm. For more information go to www.P65Warnings.ca.gov.

BALDWIN TO UPC (INDIVIDUAL PARTS)

BALDWIN NUMBER	UPC NUMBER	BALDWIN NUMBER	UPC NUMBER	BALDWIN NUMBER	UPC NUMBER	BALDWIN NUMBER	UPC NUMBER	BALDWIN NUMBER	UPC NUMBER
PA2158	791440016682	LL2326	791440017641	PA2396	791440018433	PA2467	791440019232	PA2544	791440020085
SA2159	791440016699	PA2326	791440017658	PA2397	791440018440	PA2468	791440019249	PA2545	791440020092
PA2160	791440016705	PA2326XP	791440090767	PA2398	791440018457	PA2469	791440019256	PA2546	791440020108
PA2162	791440016729	PA2328	791440017672	PA2399	791440018464	PA2472	791440019263	PA2547	791440020115
PA2163	791440016736	PA2329	791440017689	PA2401	791440018488	PA2473	791440019270	PA2548	791440020122
PA2164	791440016743	LL2330	791440017696	PA2402	791440018495	PA2474	791440019287	PA2550	791440020146
PA2167	791440016774	PA2330	791440017702	PA2403	791440018501	PA2475	791440019294	PA2551	791440020153
PA2168	791440016781	PA2331	791440017719	PA2404	791440018518	PA2476	791440019300	PA2552	791440020160
PA2169	791440016798	PA2332	791440017726	PA2405	791440018525	PA2477	791440019317	PA2553	791440020177
PA2171	791440016811	LL2333	791440017733	PA2406	791440018532	PA2478	791440019324	PA2554	791440020184
PA2178	791440016880	PA2333	791440017740	PA2407	791440018549	PA2479	791440019331	PA2554 FOAM	791440038615
PA2181	791440016910	PA2335	791440017757	PA2408	791440018556	PA2480	791440038608	PA2555	791440020207
PA2182	791440016927	PA2337	791440017764	PA2409	791440018563	PA2481	791440019348	PA2556	791440020221
PA2183	791440016934	PA2338-FN	791440017771	PA2410	791440018570	LL2482	791440019355	LL2557	791440020238
PA2188	791440016965	PA2339	791440017788	PA2411	791440018587	PA2482	791440019362	PA2557	791440020245
PA2189	791440016972	PA2340	791440017795	PA2412	791440018594	PA2483	791440019379	PA2558	791440020269
PA2191	791440016996	PA2341	791440017801	PA2413	791440018600	PA2484	791440019386	LL2559	791440020276
PA2193	791440017016	PA2342	791440017818	PA2414	791440018617	PA2485	791440019393	PA2559	791440020283
PA2194	791440017023	PA2343	791440017825	PA2415	791440018624	PA2486	791440019409	LL2562	791440020313
PA2196	791440017047	LL2344-FN	791440017832	PA2417-FN	791440018631	PA2487	791440019416	PA2562	791440020320
PA2200	791440043459	PA2344-FN	791440017849	LL2418-FN	791440018648	PA2488-FN	791440019423	PA2562XP	791440095659
PA2204	791440017115	PA2345	791440017856	PA2418-FN	791440018655	PA2489	791440019430	PA2563	791440020337
PA2207	791440017146	PA2346	791440017863	PA2419	791440018662	PA2490	791440019447	PA2564	791440020344
PA2208	791440017153	PA2347	791440017870	PA2420	791440018679	PA2491	791440019454	PA2566	791440020368
PA2212	791440017191	PA2349-FN	791440017894	PA2421	791440018686	LL2493	791440019478	PA2567	791440020375
PA2214	791440017214	PA2350	791440017900	PA2422	791440018693	PA2493	791440019485	PA2568	791440020382
PA2215	791440017221	PA2351	791440017917	PA2423	791440018709	PA2494	791440019508	PA2569	791440020399
PA2216	791440017238	PA2352	791440017924	LL2425	791440018716	PA2495	791440019515	PA2570	791440020405
PA2218	791440017252	PA2353	791440017931	PA2425	791440018723	PA2496	791440019522	PA2571	791440020412
PA2221	791440017283	PA2354	791440017948	LL2426-FN	791440018730	PA2497	791440019539	PA2572	791440020429
PA2222	791440017290	PA2356	791440017955	PA2426-FN	791440018747	PA2498	791440019546	PA2573	791440020436
PA2223	791440017306	PA2357	791440017979	PA2427	791440018754	PA2499	791440019553	PA2573XP	791440090552
PA2223 FOAM	791440067653	LL2358	791440017986	PA2428	791440018761	PA2500	791440019560	PA2574	791440020443
PA2224	791440017313	PA2358	791440017993	PA2429	791440018778	LL2502	791440019584	LL2575	791440020450
PA2225	791440017320	PA2359	791440018006	PA2430	791440018785	LL2503	791440019591	PA2575	791440020467
PA2226	791440017337	LL2360-FN	791440018013	PA2431	791440018792	PA2503	791440019607	PA2576	791440020474
PA2228	791440043473	PA2360-FN	791440018020	PA2432	791440018808	PA2504	791440019614	PA2577	791440020481
PA2230	791440043497	LL2361	791440018037	PA2433	791440018815	LL2507	791440019621	PA2578	791440020498
PA2231	791440045118	PA2361	791440018044	PA2434	791440018822	PA2507	791440019638	PA2579	791440020504
PA2232	791440045484	PA2361XP	791440103481	PA2435	791440018839	PA2508	791440019645	PA2580	791440020511
PA2233	791440045699	PA2362	791440018051	PA2436	791440018846	PA2509	791440019652	PA2581	791440020528
PA2234	791440046078	LL2363	791440018068	PA2437	791440018853	PA2510	791440019669	LL2582	791440020535
PA2235	791440046881	PA2363	791440018075	PA2438	791440018877	PA2511	791440019676	PA2582	791440020542
PA2237	791440049093	PA2363XP	791440090606	LL2439	791440018884	PA2512	791440019683	PA2583	791440020559
PA2240	791440049734	PA2364	791440018082	PA2439	791440018891	PA2513	791440019690	PA2585	791440020573
PA2241	791440049741	PA2367	791440018099	PA2440	791440018907	PA2514	791440019706	PA2586	791440020580
PA2243	791440049765	PA2368	791440018105	PA2441	791440018914	PA2515	791440019720	PA2587	791440020597
PA2244	791440049772	PA2369	791440018112	PA2442	791440018921	PA2516	791440019744	PA2588	791440020603
PA2256	791440017344	PA2370	791440018129	PA2443	791440018938	PA2517	791440019751	PA2589-FN	791440020610
PA2257	791440017351	PA2371	791440018136	PA2444	791440018945	LL2518	791440019768	PA2591	791440020634
PA2258	791440038592	PA2372	791440018143	PA2445	791440018952	PA2518	791440019775	PA2592	791440020641
PA2260	791440037601	PA2374	791440018167	PA2446	791440018969	PA2518XP	791440090729	PA2593	791440020658
PA2300	791440017368	PA2375	791440018174	LL2447-FN	791440018976	PA2519	791440019782	PA2595	791440020672
PA2301	791440017375	PA2376	791440018181	PA2447-FN	791440018983	PA2520	791440019805	PA2596	791440020689
PA2302-FN	791440017382	PA2377	791440018198	PA2448	791440018990	LL2521	791440019812	PA2598	791440020719
PA2303	791440017399	PA2378	791440018204	PA2450	791440019010	PA2521	791440019829	PA2599	791440020726
PA2304-FN	791440017405	PA2379	791440018211	PA2451	791440019027	PA2522	791440019836	PA2600	791440020733
PA2305	791440017412	PA2379-K	791440018228	PA2452	791440019034	PA2523	791440019843	PA2601	791440020740
PA2306	791440017429	PA2380-FN	791440018235	LL2453	791440019041	PA2524-FN	791440019850	PA2602	791440020757
PA2307	791440017436	PA2381	791440018242	PA2453	791440019058	LL2525	791440019867	PA2604	791440020771
PA2308	791440017443	PA2382	791440018266	PA2453XP	791440090583	PA2525	791440019874	PA2605	791440020788
PA2310	791440017467	PA2383	791440018273	PA2454	791440019065	PA2526	791440019881	PA2606	791440020795
LL2312	791440017474	LL2384	791440018280	PA2455	791440019072	PA2527	791440019898	PA2607	791440020801
PA2312	791440017481	PA2384	791440018297	LL2456	791440019089	PA2528	791440019904	LL2608	791440020818
PA2313	791440017498	PA2384XP	791440090590	PA2456	791440019096	PA2529	791440019911	PA2608	791440020825
PA2314	791440017504	PA2385	791440018303	PA2456XP	791440091375	PA2530	791440019928	LL2609	791440020832
PA2315	791440017511	PA2386	791440018310	PA2457	791440019102	PA2531	791440019942	PA2609	791440020849
PA2316	791440017535	PA2387	791440018327	LL2458	791440019119	PA2532	791440019966	PA2610	791440020856
LL2317	791440017542	PA2388	791440018334	PA2458	791440019126	PA2533	791440019980	PA2611	791440020863
PA2317	791440017559	PA2389-FN	791440018358	PA2459	791440019133	PA2534	791440019997	PA2612	791440020870
LL2318	791440017566	PA2390	791440018365	PA2460	791440019140	PA2535	791440020009	PA2613	791440020887
PA2318	791440017573	PA2391	791440018372	PA2461	791440019164	PA2536	791440020016	PA2614	791440020894
PA2319	791440017580	PA2392	791440018389	PA2462	791440019171	PA2538	791440020023	PA2615	791440020900
PA2320-FN	791440017597	LL2393	791440018396	PA2463	791440019188	PA2539	791440020030	PA2616	791440020917
PA2321	791440017603	PA2393	791440018402	PA2464	791440019195	PA2540	791440020047	PA2616XP	791440090750
PA2322	791440017610	PA2394	791440018419	PA2465	791440019218	PA2541-FN	791440020054	PA2617	791440020924
PA2323	791440017627	PA2395	791440018426	PA2466	791440019225	PA2542	791440020061	LL2618	791440020931



WARNING: These products can expose you to chemicals, including Diisononyl Phthalate, Carbon black extracts, Nickel, 1,3 Butadiene, Ethylene Oxide, Epichlorohydrin, which are known to the State of California to cause cancer, and Bisphenol-A, Ethylene Glycol, Ethylene Oxide, 1,3 Butadiene, Epichlorohydrin, which are known to the State of California to cause birth defects or other reproductive harm. For more information go to www.P65Warnings.ca.gov.

BALDWIN TO UPC (INDIVIDUAL PARTS)

BALDWIN NUMBER	UPC NUMBER	BALDWIN NUMBER	UPC NUMBER	BALDWIN NUMBER	UPC NUMBER	BALDWIN NUMBER	UPC NUMBER	BALDWIN NUMBER	UPC NUMBER
PA2618	791440020948	PA2694	791440021815	PA2785	791440022652	PA2874	791440023321	PA3416	791440054189
PA2619	791440020955	PA2696	791440021839	PA2786	791440022669	PA2875	791440023338	PA3417	791440054196
PA2620	791440020962	PA2698	791440021846	PA2787	791440022676	PA2876	791440023345	PA3419	791440052215
PA2621	791440020979	PA2699	791440021860	PA2788	791440022683	PA2877-FN	791440052680	PA3420	791440025592
PA2622	791440020986	PA2700	791440021877	PA2789	791440022690	PA2878	791440045408	PA3421	791440025608
PA2623	791440020993	PA2701	791440021884	PA2790-FN	791440022706	PA2880	791440053656	PA3430	791440038028
PA2624	791440021006	PA2702	791440021891	PA2791	791440022713	PA2881	791440053663	PA3435-FN	791440061934
PA2625	791440021013	PA2703	791440021907	PA2792	791440022720	PA2884	791440053694	PA3438	791440025615
PA2626	791440021020	PA2704	791440021914	PA2793	791440022737	PA2885	791440053700	PA3439-FN	791440025622
PA2627	791440021037	PA2705	791440021921	PA2794	791440022744	PA2887-FN	791440053717	PA3440	791440025639
PA2628	791440021044	PA2706	791440021938	PA2796	791440022768	PA2888	791440053724	PA3442	791440025653
PA2629	791440021051	PA2707	791440021945	PA2797	791440022775	PA2889	791440053731	PA3446	791440038646
PA2630	791440021068	PA2708	791440021952	PA2798	791440022782	PA2890	791440053748	PA3447	791440025677
PA2631	791440021075	PA2709	791440021969	PA2799	791440022799	PA2891	791440045415	PA3448	791440025684
PA2632	791440021082	PA2710	791440021976	PA2801	791440022805	PA2895	791440053762	PA3452	791440038653
PA2633-FN	791440021099	PA2711	791440021983	PA2803	791440022812	PA2896	791440061330	PA3453	791440025714
PA2634	791440021105	PA2712	791440021990	PA2804	791440046924	PA2897	791440053779	PA3457	791440025738
PA2635-FN	791440021112	PA2713	791440022003	PA2805	791440022836	PA2900	791440023352	PA3458	791440025745
PA2636	791440021129	PA2714	791440022010	PA2806	791440022843	PA2902	791440023369	PA3460	791440025769
PA2637	791440021136	PA2715	791440022027	PA2807	791440022850	PA2903	791440041141	PA3461	791440025776
PA2638	791440021143	PA2716	791440022034	PA2812	791440022867	PA2904	791440053809	PA3463	791440025790
PA2640	791440021150	PA2717	791440022041	PA2813	791440051317	PA2905	791440053816	PA3464	791440025806
PA2641	791440021174	PA2718	791440022058	PA2814	791440022874	PA2906	791440053823	PA3466-FN	791440025820
LL2642	791440021181	PA2719	791440022065	PA2815	791440022881	PA2909	791440053847	PA3467	791440025837
PA2642	791440021198	PA2721	791440022089	PA2816	791440022898	PA2912	791440053878	PA3469	791440025851
PA2643	791440021204	PA2722	791440022096	PA2817	791440022904	PA2913	791440053885	PA3470	791440025868
PA2644	791440021211	PA2723	791440022102	PA2818	791440022911	PA2914	791440053892	PA3471	791440025875
PA2645	791440021228	PA2724	791440022119	PA2819	791440022928	PA2915	791440053908	PA3472	791440067691
PA2646	791440021235	PA2725	791440022126	PA2820	791440022935	PA2932	791440023376	PA3472-FN	791440025882
PA2647	791440021242	PA2726	791440022133	PA2821	791440022942	PA2933	791440023383	PA3473	791440025899
PA2648	791440021259	PA2727	791440022140	PA2822	791440022959	PA2936	791440023406	PA3474	791440025905
PA2649	791440021266	PA2728	791440022157	PA2823	791440022966	PA2938	791440023413	PA3475	791440025912
PA2650	791440021273	PA2729	791440022164	PA2824	791440022973	PA2942	791440051645	PA3476	791440025929
PA2651	791440021280	PA2730	791440022171	PA2825	791440022980	PA2944-FN	791440023444	PA3477	791440025936
PA2652	791440021297	PA2731	791440022188	PA2826	791440022997	LL2945	791440023451	PA3478	791440025943
PA2653	791440021303	PA2732	791440022195	PA2827	791440023000	PA2945	791440023468	PA3478XP	791440103931
PA2653 FOAM	791440021310	PA2733	791440022201	PA2828	791440023017	PA2946	791440023475	PA3479	791440025950
PA2654	791440021327	PA2734	791440022225	PA2829	791440023024	PA2947	791440023482	PA3480	791440030459
PA2655	791440021334	PA2735	791440022232	PA2830	791440023031	PA2948	791440053939	PA3481	791440025967
PA2656	791440021358	PA2736	791440022249	PA2831	791440023038	PA2949-FN	791440023499	PA3482	791440025974
PA2657-FN	791440021365	PA2737	791440022256	PA2832	791440023055	PA2950	791440053946	PA3483	791440049284
PA2658	791440021372	PA2738	791440022263	PA2833	791440023062	PA2951	791440048836	PA3484	791440049277
PA2659	791440021396	PA2739	791440022270	PA2834	791440023079	PA2952	791440048850	PA3486	791440025981
PA2660	791440021402	PA2740	791440022287	PA2835	791440023086	PA2953	791440053953	PA3487	791440025998
LL2661	791440021419	PA2742	791440022300	PA2836	791440023093	PA2954-FN	791440053960	PA3491	791440038660
PA2661	791440021426	PA2743	791440022317	PA2837	791440023109	PA2955	791440045446	PA3492	791440026001
PA2662	791440021433	PA2744	791440022324	PA2838	791440045361	PA2956-FN	791440052727	PA3493	791440030527
PA2663-FN	791440021457	PA2745	791440022331	PA2839	791440023116	PA2957	791440052717	PA3494	791440047150
PA2664	791440021464	PA2746	791440022348	PA2840	791440053557	PA2958	791440053971	PA3495	791440026018
PA2665	791440021471	PA2747	791440022355	PA2843	791440023123	PA2959-FN	791440052697	PA3496	791440026025
PA2666	791440021488	PA2748	791440022362	PA2844	791440023130	PA2960	791440052703	PA3498	791440026049
LL2667	791440021495	PA2749	791440022386	PA2845	791440023147	PA2961-FN	791440052673	PA3499	791440041325
PA2667	791440021501	PA2750	791440022393	PA2846-FN	791440023154	PA2962	791440053984	RS3501	791440026056
PA2668	791440021518	PA2751	791440022409	PA2847	791440053571	PA2963	791440045453	RS3502	791440026063
PA2669-FN	791440021525	PA2752	791440022416	PA2848	791440023161	PA2964	791440053991	RS3503	791440026070
PA2670	791440021532	PA2753	791440022423	PA2849	791440023178	PA2967	791440054004	RS3504	791440026087
PA2672	791440021556	PA2754	791440022430	PA2851	791440023195	PA2968-FN	791440056701	RS3504XP	791440090941
PA2673	791440021563	PA2755	791440022447	PA2852	791440023202	PA2970	791440054028	RS3505	791440026094
PA2674	791440021570	PA2756	791440022454	PA2853	791440023219	PA2971	791440054035	RS3506	791440026100
PA2675	791440021594	PA2757	791440022461	PA2854	791440023222	PA2973	791440023505	RS3506XP	791440090927
LL2676	791440021600	PA2761	791440022478	PA2855	791440023239	PA2976-FN	791440054066	RS3507	791440026117
PA2676	791440021617	PA2763	791440022485	PA2856	791440023246	PA2977-FN	791440050273	RS3508	791440026124
PA2676XP	791440090781	PA2767	791440022492	PA2857	791440023253	PA2978	791440023529	RS3508XP	791440090835
PA2677	791440021624	PA2771	791440053489	PA2858	791440023260	PA2980	791440054073	RS3509	791440026131
PA2678	791440021631	PA2772	791440022505	PA2859-FN	791440053588	PA2982	791440054097	RS3510	791440026148
PA2679	791440021655	PA2773	791440022515	PA2860-FN	791440045378	PA2984	791440023536	RS3510XP	791440090811
PA2680	791440021662	PA2774	791440022522	PA2861	791440023277	PA2988	791440023543	RS3511	791440026155
PA2684-FN	791440021693	PA2775	791440022539	PA2862	791440045385	PA2989	791440023550	RS3512	791440026162
LL2685	791440021709	PA2776	791440022546	PA2862 FOAM	791440053595	HSG3077	791440082847	RS3513	791440026179
PA2687	791440021730	PA2777	791440022553	RS2863	791440023291	HSG3078	791440085558	RS3514	791440026186
LL2688	791440021747	PA2778-FN	791440022560	RS2863XP	791440090877	AB3349	791440085565	RS3514XP	791440090842
PA2688	791440021754	LL2779	791440022577	PA2865	791440023307	PA3404	791440025523	RS3515	791440026193
PA2689	791440021761	PA2779	791440022584	PA2866	791440053601	PA3405	791440054141	RS3516	791440026209
PA2690	791440021778	PA2781	791440022607	PA2867-FN	791440053618	PA3406-FN	791440025530	RS3516XP	791440110502
PA2691	791440021785	PA2782	791440045392	PA2869	791440045392	PA3411-FN	791440054158	RS3517	791440043039
PA2692	791440021792	PA2783	791440022638	PA2870-FN	791440053625	PA3414	791440054165	RS3517XP	791440090880
PA2693	791440021808	PA2784	791440022645	PA2871	791440052536	PA3415	791440054172	RS3518	791440038431



WARNING: These products can expose you to chemicals, including Diisononyl Phthalate, Carbon black extracts, Nickel, 1,3 Butadiene, Ethylene Oxide, Epichlorohydrin, which are known to the State of California to cause cancer, and Bisphenol-A, Ethylene Glycol, Ethylene Oxide, 1,3 Butadiene, Epichlorohydrin, which are known to the State of California to cause birth defects or other reproductive harm. For more information go to www.P65Warnings.ca.gov.

BALDWIN TO UPC (INDIVIDUAL PARTS)

BALDWIN NUMBER	UPC NUMBER	BALDWIN NUMBER	UPC NUMBER	BALDWIN NUMBER	UPC NUMBER	BALDWIN NUMBER	UPC NUMBER	BALDWIN NUMBER	UPC NUMBER
RS3518XP	791440108905	PA3633 FOAM	791440055803	RS3734XP	791440090934	PA3824	791440054417	PA3909	791440055678
RS3519	791440047501	PA3636	791440042667	RS3735	791440052598	PA3825	791440058071	PA3910-FN	791440057774
RS3520	791440038677	PA3637	791440042704	RS3736	791440052550	RS3826	791440057463	PA3911	791440057787
RS3521	791440050570	PA3638	791440042711	RS3737	791440052567	RS3827	791440057470	PA3914	791440057838
RS3528	791440038424	PA3640	791440042735	RS3738	791440052857	PA3828	791440058088	PA3915	791440057845
RS3529	791440042827	PA3643	791440042810	RS3739	791440052864	PA3829	791440058095	PA3916	791440057944
RS3530	791440038363	PA3644	791440042858	RS3740	791440053175	PA3832	791440054523	PA3917	791440058118
RS3530XP	791440090910	PA3645	791440042889	RS3741	791440053182	PA3833	791440054561	PA3918	791440058239
RS3531	791440048768	PA3650	791440043244	RS3743	791440054370	PA3834	791440054585	PA3919	791440058309
RS3532	791440039377	PA3651-FN	791440043251	RS3744	791440054707	PA3835	791440054592	RS3920	791440058354
RS3533	791440039384	PA3652	791440043268	RS3744XP	791440090804	PA3836	791440055049	RS3921	791440058361
RS3534	791440045170	PA3653	791440043299	RS3745	791440054714	PA3838	791440056350	RS3922	791440058378
RS3535	791440039391	PA3654	791440043428	RS3746	791440055209	PA3839	791440055077	RS3923	791440058385
RS3536	791440045132	PA3655	791440043589	RS3747	791440055148	PA3840	791440055087	PA3924-FN	791440058415
RS3537	791440042834	PA3656	791440043602	RS3749	791440055193	PA3843	791440054813	PA3925	791440058651
RS3538	791440038370	PA3657	791440043596	RS3750	791440056657	PA3844	791440056367	RS3926	791440058422
RS3539	791440045187	PA3658	791440043619	RS3750XP	791440109827	PA3847	791440056381	RS3927	791440058439
RS3539XP	791440093188	PA3660-FN	791440043800	PA3752	791440048485	PA3848-FN	791440056398	PA3928	791440058491
RS3540	791440038042	PA3664-FN	791440045590	PA3753	791440048492	PA3849	791440056404	PA3929	791440058545
RS3541	791440043848	PA3667-FN	791440043831	PA3754	791440048508	PA3850	791440056411	RS3930	791440058675
RS3542	791440041233	PA3668	791440045620	PA3755	791440048614	PA3851	791440056428	PA3931	791440058736
RS3543	791440041240	PA3669-FN	791440045637	PA3756	791440048621	PA3852-FN	791440056435	PA3932	791440058770
RS3544	791440041257	PA3670	791440045767	PA3757	791440048638	PA3853-FN	791440056442	PA3933	791440058712
RS3545	791440041264	PA3671-FN	791440045996	PA3758	791440048645	PA3854-FN	791440056459	RS3934	791440058873
RS3547	791440041288	PA3672	791440045989	PA3759	791440048652	PA3855-FN	791440056466	RS3935	791440058880
RS3548	791440040360	PA3674	791440046016	PA3760	791440048669	PA3859	791440056503	RS3936	791440058903
RS3548XP	791440090897	PA3675	791440046085	PA3761-FN	791440048683	PA3860	791440056510	PA3937	791440059047
RS3549	791440045729	PA3676	791440046092	PA3763	791440048737	PA3861	791440056527	PA3938	791440059078
RS3550	791440038448	PA3679	791440046528	RS3764	791440057456	PA3862-FN	791440056534	PA3939	791440059351
PA3551	791440026278	PA3680	791440046795	PA3765	791440048805	PA3863	791440056541	RS3940	791440059368
PA3554	791440026285	PA3681	791440046818	PA3766	791440048812	PA3864	791440056558	PA3941	791440059399
PA3555	791440026292	PA3682	791440046825	PA3767	791440049642	PA3865	791440056565	RS3942	791440059429
PA3556	791440026308	PA3683	791440046832	PA3768	791440049659	PA3867	791440055155	RS3943	791440059436
PA3557-FN	791440026315	PA3684	791440046849	PA3773	791440049657	PA3868	791440055162	PA3944	791440059483
PA3558	791440026322	PA3685	791440046856	PA3774	791440050051	PA3869	791440058064	PA3945	791440059450
PA3559	791440026339	PA3686	791440046863	PA3775	791440050068	RS3870	791440055179	PA3946	791440059467
PA3560	791440026346	PA3687	791440046870	PA3777	791440050235	RS3870XP	791440090828	PA3948	791440059474
PA3562	791440026353	PA3688	791440047228	PA3778	791440050259	RS3871	791440055186	PA3949	791440060760
PA3563	791440026360	PA3689	791440047549	PA3779-FN	791440050310	PA3872	791440055926	PA3950	791440059511
PA3565	791440026377	PA3690	791440047525	PA3780	791440050365	PA3873	791440055933	PA3951	791440059016
PA3566	791440026384	PA3691	791440048089	PA3781	791440050495	PA3874	791440055230	RS3952	791440059597
PA3568	791440037915	PA3697	791440047860	PA3782	791440050662	PA3875-FN	791440056022	PA3953	791440059498
PA3569	791440026391	PA3698	791440048171	PA3783	791440050679	PA3876	791440056770	RS3954	791440059603
PA3572	791440026438	PA3699	791440048201	PA3785-FN	791440051416	PA3877	791440055827	PA3956	791440059801
PA3573	791440026445	RS3700	791440043510	PA3786-FN	791440050952	PA3878	791440055834	PA3957	791440059863
PA3576	791440026469	RS3700XP	791440090859	PA3787	791440050921	PA3879-FN	791440055841	PA3957 FOAM	791440073418
PA3578	791440038035	RS3701	791440043527	PA3790	791440051546	PA3880	791440056039	PA3958	791440059948
PA3579	791440038738	RS3703	791440045736	PA3791-FN	791440051560	PA3881	791440056091	PA3959	791440060029
PA3580	791440026483	RS3704	791440045743	PA3792	791440051577	RS3882	791440056046	PA3961	791440059925
PA3581	791440026490	RS3705	791440045750	PA3794	791440051607	RS3882XP	791440098985	BA3964(4)	791440060074
PA3584	791440038745	RS3706	791440046344	PA3795	791440051751	RS3883	791440056053	BA3965(4)	791440060081
PA3587	791440037908	RS3707	791440046351	PA3796	791440051713	RS3884	791440056060	PA3966	791440060098
PA3588	791440037946	RS3708	791440046375	PA3797	791440051720	RS3885	791440056077	PA3967	791440060111
PA3595	791440038097	RS3709	791440046382	PA3798	791440051874	PA3886	791440056107	PA3969	791440060173
PA3597	791440037533	RS3710	791440046771	PA3800	791440052345	PA3887	791440056220	PA3970	791440060196
PA3598	791440037540	RS3711	791440046788	PA3801-FN	791440052772	RS3888	791440056237	RS3971	791440061095
PA3600	791440037595	RS3712	791440047563	PA3802	791440052482	PA3889	791440056244	PA3972	791440060197
PA3601	791440037649	RS3713	791440050358	PA3803	791440052499	PA3890	791440056282	PA3973	791440060203
PA3602	791440037700	RS3714	791440048188	PA3804	791440052505	PA3891	791440056343	RS3974	791440060227
PA3604	791440037724	RS3715	791440048232	PA3805-FN	791440052543	PA3892	791440056756	RS3975	791440060234
PA3605	791440037755	RS3716	791440049666	PA3806	791440053052	PA3893	791440056763	PA3978	791440060265
PA3606	791440037762	RS3717	791440049321	PA3807	791440054738	PA3894	791440056909	PA3979	791440060272
PA3607-FN	791440037779	RS3718	791440049307	PA3808-FN	791440053038	PA3895-FN	791440056923	PA3980	791440060357
PA3608-FN	791440037786	RS3719	791440049314	PA3809	791440053045	PA3896	791440056954	PA3983-FN	791440060623
PA3609	791440037793	RS3720	791440049703	PA3810	791440053106	PA3897	791440057005	PA3984	791440060791
PA3610	791440037809	RS3721	791440052468	PA3811-FN	791440053267	PA3898	791440056961	PA3985	791440060777
PA3611	791440037816	RS3722	791440050990	PA3812	791440053274	PA3899	791440056978	PA3986	791440060920
PA3612	791440038264	RS3723	791440051294	PA3814	791440053311	PA3900	791440057418	PA3987	791440060937
PA3613	791440038271	RS3724	791440052208	PA3815	791440053328	PA3901	791440057432	RS3988	791440060944
PA3614	791440038332	RS3727	791440052239	PA3816	791440058620	PA3901 FOAM	791440067660	PA3989-FN	791440061033
PA3627	791440042469	RS3728	791440052246	PA3817	791440058224	PA3902	791440057548	RS3990	791440060968
PA3628	791440042476	RS3729	791440052253	PA3818-FN	791440058217	PA3903	791440057555	RS3991	791440061026
PA3629	791440042483	RS3730	791440051881	PA3819	791440058590	PA3904	791440057562	RS3992	791440060975
PA3630-FN	791440042575	RS3731	791440052314	PA3820-FN	791440058613	PA3905	791440057579	RS3993	791440061279
PA3631	791440042582	RS3732	791440056824	RS3732	791440058200	PA3906	791440057586	RS3994	791440060982
PA3632	791440042599	RS3733	791440051980	PA3822	791440054394	PA3907	791440057791	RS3995	791440061286
PA3633	791440042605	RS3734	791440052734	PA3823	791440054400	PA3908	791440057761	RS3996	791440060999



WARNING: These products can expose you to chemicals, including Diisononyl Phthalate, Carbon black extracts, Nickel, 1,3 Butadiene, Ethylene Oxide, Epichlorohydrin, which are known to the State of California to cause cancer, and Bisphenol-A, Ethylene Glycol, Ethylene Oxide, 1,3 Butadiene, Epichlorohydrin, which are known to the State of California to cause birth defects or other reproductive harm. For more information go to www.P65Warnings.ca.gov.

BALDWIN TO UPC (INDIVIDUAL PARTS)

BALDWIN NUMBER	UPC NUMBER	BALDWIN NUMBER	UPC NUMBER	BALDWIN NUMBER	UPC NUMBER	BALDWIN NUMBER	UPC NUMBER	BALDWIN NUMBER	UPC NUMBER
RS3997	791440061293	PA4148	791440062542	PA4331	791440081383	PA4422	791440085985	PA4567	791440062177
RS3998	791440061002	PA4149 KIT	791440063082	PA4332	791440081390	PA4423	791440085992	PA4570	791440062382
RS3998XP	791440090866	PA4150	791440063464	PA4333	791440081574	PA4424	791440086142	PA4571	791440062924
RS3999	791440061040	PA4151	791440064317	PA4334	791440081505	PA4425	791440086418	RS4572	791440062597
PA4005	791440043435	PA4152	791440064492	PA4335	791440081512	PA4426	791440086425	PA4573	791440062832
PA4015	791440038691	PA4153	791440064508	PA4336	791440081581	PA4428	791440086685	PA4574	791440062849
PA4016	791440026551	PA4154	791440064515	PA4337	791440081604	PA4429	791440087026	RS4576	791440062870
PA4018	791440026588	PA4156 KIT	791440065048	PA4338	791440081796	PA4430	791440087057	RS4577	791440062887
PA4023	791440026582	PA4157	791440065055	PA4340	791440081802	PA4431	791440087231	RS4578	791440062900
PA4026	791440026599	PA4158	791440065253	PA4341	791440081819	PA4433	791440087675	RS4579	791440063129
PA4028	791440026605	PA4159	791440065406	PA4344	791440081826	PA4434	791440087965	RS4580	791440063136
PA4041	791440043565	PA4160	791440065444	PA4345	791440081833	PA4435	791440088108	PA4581	791440063143
PA4042	791440048959	RS4161	791440065451	PA4348	791440081840	PA4436	791440088160	PA4582	791440063150
PA4043	791440048966	PA4162	791440065536	PA4349	791440081857	PA4437	791440088177	PA4583-FN	791440063181
PA4044	791440049222	PA4163	791440065888	PA4350	791440081864	PA4438	791440088443	PA4585	791440063327
PA4045	791440049239	PA4164	791440066083	PA4351	791440081871	PA4439	791440089167	PA4592	791440063457
PA4046	791440049246	PA4165	791440066090	PA4352	791440081888	PA4440 KIT	791440089174	PA4593	791440063471
PA4047	791440049338	PA4166	791440066656	PA4353	791440081994	PA4441	791440089181	PA4594	791440063488
PA4048	791440049345	PA4167	791440066762	PA4354	791440082007	PA4442	791440089297	RS4595	791440063587
PA4049	791440049406	PA4168	791440067073	PA4355	791440082014	PA4443	791440089303	RS4597	791440063792
PA4050	791440026650	PA4169	791440067134	PA4356	791440082021	PA4444	791440089310	RS4598	791440063648
PA4060	791440026681	PA4170	791440072602	PA4358	791440082045	RS4445	791440089419	RS4599	791440063655
PA4069	791440043626	PA4171	791440074927	PA4359	791440082052	PA4446	791440089426	PA4600	791440063709
PA4070	791440043633	PA4172	791440076761	PA4360	791440082069	PA4447	791440089433	PA4601	791440063716
PA4071	791440043640	PA4173	791440077188	PA4361	791440082076	PA4448	791440089440	PA4602	791440063747
PA4072	791440043794	PA4174	791440077195	PA4362	791440082083	PA4449	791440089554	PA4603	791440064898
PA4073	791440043817	PA4175	791440077997	PA4363	791440082212	RS4450	791440089815	PA4604-FN	791440063808
PA4075	791440047068	PA4176	791440078000	PA4364	791440082239	PA4451	791440089891	PA4605	791440063815
PA4077	791440047532	PA4177	791440078123	PA4365	791440082266	PA4452	791440089907	PA4606	791440063822
PA4078	791440047679	PA4178	791440078666	PA4366	791440082267	PA4453	791440089914	PA4608	791440063853
PA4079	791440047877	PA4179	791440078673	PA4367	791440082335	PA4454	791440089945	PA4610 KIT	791440063921
PA4081	791440049536	PA4180	791440078680	PA4368	791440082342	PA4455	791440089969	PA4611	791440063891
PA4084	791440050044	PA4181	791440078697	PA4369	791440082359	PA4456	791440089983	PA4612	791440063938
PA4085	791440050303	PA4182	791440078703	PA4370	791440082366	PA4458	791440090019	RS4613	791440064393
PA4088	791440051140	PA4183	791440078710	PA4371	791440082373	PA4460 KIT	791440090101	PA4614	791440063952
PA4089	791440051157	PA4184	791440079090	PA4372	791440082380	PA4461	791440090125	RS4616	791440064041
PA4090	791440051164	PA4185	791440079366	PA4373	791440082397	PA4462	791440090132	RS4617	791440064058
PA4091	791440051218	PA4187	791440079649	PA4374	791440082458	PA4463	791440090163	RS4618	791440064386
PA4092	791440051409	PA4188	791440080270	PA4376	791440082489	PA4464	791440090309	PA4619	791440064690
PA4093	791440051737	RS4189	791440080294	PA4377	791440082496	PA4465	791440090422	RS4620	791440064409
PA4094	791440051744	PA4190	791440080300	PA4380	791440082502	PA4466	791440091016	RS4621	791440064416
PA4099	791440052307	PA4191	791440080317	PA4381	791440082519	PA4468	791440091528	RS4622	791440064423
PA4100	791440052444	PA4192	791440080409	PA4382	791440082526	PA4469	791440091535	RS4623	791440065246
PA4101	791440053090	PA4193	791440080416	PA4383	791440082533	PA4470	791440092297	PA4624	791440064652
PA4102	791440053137	PA4194	791440080423	PA4384	791440082540	PA4471	791440092310	PA4625	791440064669
PA4103	791440054516	PA4195 KIT	791440080430	PA4385	791440082557	PA4472	791440092365	PA4627	791440064966
PA4104	791440054639	PA4196	791440080447	PA4386	791440082564	PA4473	791440092440	PA4628	791440065178
PA4105	791440054646	PA4197	791440080454	PA4387	791440082571	PA4474	791440092532	RS4629	791440065215
PA4106	791440054653	PA4198	791440080461	PA4388	791440082649	PA4475	791440092853	PA4630	791440065550
PA4107	791440054660	PA4199	791440080478	PA4389	791440082656	PA4476	791440093669	PA4631-FN	791440065284
PA4108	791440054950	PA4303	791440080485	PA4390	791440082670	PA4477	791440093676	PA4632	791440065338
PA4109	791440054967	PA4304	791440080492	PA4391	791440082762	PA4478	791440093683	PA4633	791440065345
PA4110	791440055131	PA4305	791440080508	PA4392	791440082786	PA4479	791440093690	RS4634	791440065321
PA4111	791440056084	PA4306	791440080515	PA4393	791440082793	PA4480	791440093706	RS4634XP	791440104266
PA4112	791440057425	PA4307	791440080522	PA4394	791440082861	PA4481	791440094390	PA4635	791440065413
PA4113	791440057890	PA4308	791440080539	PA4396	791440082977	PA4483	791440094536	RS4636	791440065369
PA4114	791440058011	PA4309	791440080546	PA4397	791440082984	PA4484	791440094666	RS4637	791440065376
PA4118	791440059160	PA4310	791440080560	PA4398	791440082991	PA4485	791440094703	RS4638	791440065390
PA4120	791440059085	PA4311	791440080577	PA4399	791440083004	PA4486	791440095113	RS4639	791440065512
PA4121	791440059320	PA4312	791440080584	PA4400	791440083011	PA4487	791440095137	PA4640-FN	791440077300
PA4123	791440059559	PA4313	791440080591	PA4401	791440083097	PA4488	791440095144	PA4641	791440065574
PA4124	791440059566	PA4314	791440080607	PA4402	791440083103	PA4489	791440095151	RS4642	791440065581
PA4126	791440059849	SA4315	791440080553	PA4403	791440083134	PA4548	791440063341	RS4643	791440065598
PA4127	791440059924	PA4316	791440080652	PA4404	791440083141	RS4549	791440063334	PA4644	791440065611
PA4128	791440060319	PA4317	791440080669	PA4405	791440083158	PA4551	791440061231	PA4645-FN	791440065628
PA4129	791440060326	PA4318	791440080744	PA4408	791440083189	PA4552	791440061248	RS4646	791440065635
RS4130	791440060333	PA4319	791440080751	PA4409	791440083240	PA4553	791440061354	PA4647	791440065642
RS4131	791440060364	PA4320	791440080775	PA4410 KIT	791440083516	PA4554	791440061361	PA4648	791440065659
PA4132	791440060449	PA4321	791440080881	PA4411	791440083578	PA4555	791440061378	PA4649	791440065666
PA4133	791440060487	PA4322	791440080898	PA4412	791440083592	PA4557	791440061392	PA4650-FN	791440065727
PA4134	791440060869	PA4323	791440081048	PA4413	791440083608	PA4559	791440061880	PA4651	791440065758
PA4138	791440061125	PA4324	791440081062	PA4415	791440083622	PA4560	791440061910	PA4652	791440065895
SA4141	791440061194	PA4325	791440081109	PA4416 KIT	791440083677	RS4561	791440061958	PA4653	791440066106
PA4144	791440061965	PA4327	791440081086	PA4417	791440083776	RS4562	791440061989	PA4654 KIT	791440066151
PA4145	791440062238	PA4328	791440081093	PA4418	791440083868	RS4563	791440062016	PA4655	791440066182
PA4146	791440062528	PA4329	791440081215	PA4419	791440083875	RS4564	791440062023	PA4656	791440066267
PA4147	791440062535	PA4330	791440081376	PA4421	791440084155	PA4566	791440062153	PA4657	791440066281



WARNING: These products can expose you to chemicals, including Diisononyl Phthalate, Carbon black extracts, Nickel, 1,3 Butadiene, Ethylene Oxide, Epichlorohydrin, which are known to the State of California to cause cancer, and Bisphenol-A, Ethylene Glycol, Ethylene Oxide, 1,3 Butadiene, Epichlorohydrin, which are known to the State of California to cause birth defects or other reproductive harm. For more information go to www.P65Warnings.ca.gov.

BALDWIN TO UPC (INDIVIDUAL PARTS)

BALDWIN NUMBER	UPC NUMBER	BALDWIN NUMBER	UPC NUMBER	BALDWIN NUMBER	UPC NUMBER	BALDWIN NUMBER	UPC NUMBER	BALDWIN NUMBER	UPC NUMBER
PA4659	791440066328	RS4803	791440068810	PA4955	791440075207	B5145	791440066922	RS5345	791440081307
PA4660	791440066335	RS4804	791440068827	PA4956	791440075214	B5176	791440027121	RS5347	791440081321
PA4661	791440066847	RS4806	791440068841	RS4959	791440075252	B5177	791440027138	RS5348	791440081338
PA4662	791440066854	RS4807	791440068858	PA4960-FN	791440075054	BW5178	791440027145	PA5350	791440079045
PA4663	791440066861	PA4809	791440068872	PA4961	791440075078	BW5179	791440027152	RS5351	791440079120
PA4664	791440066878	PA4813	791440068919	RS4962	791440075269	BW5182	791440066298	CA5352	791440079137
PA4665-FN	791440066601	PA4819	791440068971	RS4963	791440075276	BW5183	791440079021	PA5353	791440079403
PA4666	791440066618	PA4820	791440068988	RS4966	791440075283	BW5200	791440053281	RS5354	791440079236
PA4668	791440066885	PA4823	791440069015	RS4967	791440075290	BW5201	791440057401	RS5355	791440079243
RS4672	791440067042	PA4824	791440069022	RS4968	791440075306	BW5250	791440060050	RS5356	791440079427
RS4673	791440067059	PA4825	791440069039	RS4969	791440075313	PE5270	791440091894	PA5357	791440079434
PA4674-FN	791440067066	PA4827	791440069053	RS4970	791440075320	PE5271	791440091900	RS5358	791440079465
RS4676	791440067264	PA4829	791440069077	RS4971	791440075337	PE5272	791440094925	PA5359	791440079526
RS4677	791440067271	PA4830	791440069084	RS4972	791440075344	RS5273	791440094949	RS5360	791440079557
RS4678	791440067288	PA4833-FN	791440069107	PA4973	791440076013	PA5274	791440094970	RS5361	791440079564
RS4679	791440067295	PA4834-FN	791440069114	PA4975	791440075993	PA5275	791440094987	PA5363	791440079601
RS4680	791440067325	PA4848	791440069251	PA4977-FN	791440075979	PA5276	791440094994	PA5364	791440079786
PA4681	791440067363	PA4852	791440067547	PA4978	791440075982	CA5278	791440095045	PA5365	791440079793
PA4682	791440067424	PA4852 FOAM	791440067554	PA4979	791440075955	PA5281	791440095076	CA5366	791440079861
PA4683	791440067523	PA4853	791440067561	PA4983	791440076310	PA5282	791440095083	CA5368	791440079885
PA4689	791440067639	PA4854	791440067578	PA4984-FN	791440076303	PA5283	791440095090	CA5369	791440079892
PA4692	791440067745	PA4855	791440067592	PA4985	791440076372	BA5284	791440095106	CA5370	791440079908
PA4693	791440067752	PA4857	791440072503	PA4986	791440076389	RS5285	791440095168	BA5371	791440081956
PA4694	791440067769	PA4858	791440072527	PA4987	791440076396	RS5287	791440109803	BA5373	791440085619
PA4695	791440067776	RS4859	791440072541	RS4988	791440076518	RS5287XP	791440095212	BA5374	791440078840
PA4696 FOAM	791440067783	PA4860	791440072558	RS4989	791440076563	RS5288	791440109810	BA5375	791440078857
PA4697-FN	791440067790	RS4861	791440073470	PA4991	791440076594	RS5288XP	791440096608	BA5376	791440078864
PA4698	791440067806	RS4862	791440072565	RS4992	791440076679	PA5289	791440095236	BA5377	791440085626
CA4700	791440066571	RS4863	791440072572	RS4993	791440076785	PA5290	791440095229	BA5378	791440085118
PA4701	791440066588	RS4864	791440073463	RS4994	791440076686	RS5291	791440095250	BA5379	791440085725
CA4702	791440066724	PA4865-FN	791440073333	RS4995	791440076693	RS5292	791440095267	RS5387 KIT	791440079977
CA4703	791440066731	PA4870-FN	791440073340	CA4996	791440094796	RS5293	791440095616	PA5388	791440079984
PA4704	791440066717	PA4871	791440073357	PA4997	791440094802	RS5293XP	791440103597	RS5389-FN	791440080010
PA4705	791440067820	PA4872	791440073364	CA4999	791440076808	RS5294	791440096523	RS5390	791440080034
PA4706	791440067837	PA4873	791440073371	CFB5000	791440026704	PA5297	791440096554	RS5391	791440080089
PA4707	791440067844	PA4874	791440073388	CS5007	791440026742	PA5298	791440096561	RS5392	791440080171
PA4708	791440067851	PA4876	791440073401	CS5008	791440026759	PA5299	791440096592	PA5393	791440080225
PA4709	791440067868	PA4877	791440072626	CS5009	791440026766	PA5300	791440076907	RS5395-FN	791440080928
PA4711	791440067882	PA4878	791440072633	CS5010	791440026773	RS5301	791440076990	PA5396	791440080935
PA4713	791440067905	PA4879	791440072640	CS5011	791440026780	PA5302	791440077058	RS5397	791440080942
PA4714	791440067912	PA4881	791440072654	CS5012	791440026797	PA5303	791440077072	RS5398	791440080959
PA4715	791440067929	PA4883	791440072688	CSC5013	791440026803	RS5304	791440077102	PA5399	791440080966
PA4716	791440067936	PA4885	791440072701	CTK5028	791440026865	RS5305	791440077126	PA5400	791440080973
PA4720	791440067974	PA4886	791440072718	CTK5029	791440043237	PA5306	791440077133	PA5401	791440080980
PA4723	791440068001	PA4887	791440072725	CTK5029-M	791440079144	PA5310	791440077256	PA5403	791440081000
PA4727	791440068049	PA4888	791440072732	CTK5029-1	791440059528	PA5311	791440077321	PA5404	791440081017
PA4730	791440068070	PA4889	791440072749	CTK5029-4	791440050211	PA5312 KIT	791440077348	PA5405	791440081024
PA4731	791440068087	PA4890	791440072756	CS5057	791440026889	RS5313	791440077355	PA5406-FN	791440081031
PA4732	791440068094	PA4891	791440072763	CS5058	791440026896	PA5314	791440077362	RS5408	791440081123
PA4733	791440068100	PA4893	791440072787	OTK5060	791440026902	PA5315	791440077454	RS5409	791440081116
PA4734	791440068117	PA4895	791440072800	OTK5061	791440026919	PA5316	791440077461	PA5410-FN	791440081130
PA4735	791440068124	PA4896	791440072817	OTK5063	791440026933	PA5317	791440077478	RS5411	791440081147
PA4736 FOAM	791440068131	PA4897	791440072824	BW5070	791440026940	PA5318	791440077492	PA5412	791440081161
PA4737	791440068148	PA4900	791440072848	BW5071	791440026957	PA5319	791440077508	RS5413	791440081178
PA4738	791440068155	PA4902	791440072862	BW5072	791440026964	PA5320	791440077515	RS5414	791440081239
PA4740	791440068179	PA4903	791440072879	BW5073	791440026971	PA5321	791440077522	RS5415	791440081246
PA4741	791440068186	PA4905	791440072893	BW5074	791440026988	PA5323	791440077669	CA5416	791440081420
PA4743	791440068209	PA4906	791440072909	BW5075	791440026995	PA5324-FN	791440077706	CA5417	791440081437
PA4750	791440068278	PA4907	791440072916	BW5076	791440027008	RS5325	791440077713	PA5418	791440081444
PA4753	791440068308	PA4908	791440072923	BW5082	791440043107	PA5326	791440077720	CA5419	791440081468
PA4754	791440068315	PA4910	791440072947	BW5086	791440057593	PA5327	791440077867	CA5420	791440081475
PA4755	791440068322	PA4911	791440072954	B5087	791440058262	PA5328	791440077874	CA5421	791440081485
PA4756	791440068339	PA4912	791440075092	B5088	791440058279	RS5329	791440077881	RS5422	791440081891
PA4758	791440068353	PA4918	791440073029	B5089	791440063440	PA5331	791440078192	PA5423-FN	791440081963
PA4760	791440068377	PA4919	791440073036	B5090	791440066573	RS5332	791440078376	RS5424	791440082151
PA4763	791440068407	PA4925	791440073098	B5091	791440082830	PA5333	791440078444	PA5425	791440082663
PA4764	791440068414	PA4928	791440073128	P5092	791440091542	RS5334	791440078741	PA5426	791440082687
PA4766	791440068438	PA4929	791440073135	B5134	791440027046	RS5335	791440078475	PA5428	791440082878
PA4769	791440068469	PA4930	791440073142	BW5136	791440027053	PA5336	791440078543	RS5429	791440082939
PA4773	791440068506	PA4931	791440073159	BW5137	791440027060	PA5337	791440078635	RS5430	791440082946
RS4775	791440068520	PA4932	791440073166	BW5138	791440027077	PA5338-FN	791440078642	RS5431	791440082960
PA4778	791440068568	PA4934	791440073180	BW5139	791440027084	PA5339	791440078871	RS5432	791440083035
PA4781	791440068599	PA4935	791440073197	BW5140	791440027091	PA5340	791440078895	RS5433	791440083059
PA4793	791440068711	PA4938	791440073227	BW5141	791440027107	PA5341	791440078918	RS5434	791440083493
RS4794	791440068728	PA4939	791440073234	BW5142	791440052581	RS5342	791440078970	RS5435	791440085633
PA4795	791440068735	PA4942	791440073265	BW5143	791440057029	RS5343	791440078987	PA5436	791440083639
PA4802	791440068803	PA4945	791440075108	B5144	791440064065	RS5344	791440081291	PA5437	791440084100



WARNING: These products can expose you to chemicals, including Diisononyl Phthalate, Carbon black extracts, Nickel, 1,3 Butadiene, Ethylene Oxide, Epichlorohydrin, which are known to the State of California to cause cancer, and Bisphenol-A, Ethylene Glycol, Ethylene Oxide, 1,3 Butadiene, Epichlorohydrin, which are known to the State of California to cause birth defects or other reproductive harm. For more information go to www.P65Warnings.ca.gov.

BALDWIN TO UPC (INDIVIDUAL PARTS)

BALDWIN NUMBER	UPC NUMBER	BALDWIN NUMBER	UPC NUMBER	BALDWIN NUMBER	UPC NUMBER	BALDWIN NUMBER	UPC NUMBER	BALDWIN NUMBER	UPC NUMBER
RS5438	791440083370	RS5537	791440090439	PA5667	791440091504	RS5761	791440093638	BK6068	791440109445
RS5440	791440083646	RS5538	791440087996	PA5668	791440091511	PA5762	791440093645	BK6069	791440109490
RS5441	791440083653	RS5539	791440088009	PA5669	791440091566	PA5763	791440093713	BK6070	791440098060
RS5442	791440083844	RS5540	791440088016	RS5670	791440091573	PA5764	791440093720	BK6071	791440092044
RS5443	791440083851	RS5541	791440088023	RS5672	791440091610	PA5765	791440093751	BK6073	791440093126
PA5445	791440083714	RS5543	791440089730	RS5673	791440091627	PA5766	791440093805	BK6074	791440093133
PA5446	791440083721	RS5544	791440089747	PA5674	791440091634	RS5767	791440093812	BK6075	791440093140
RS5447	791440083738	PA5545	791440088085	RS5675	791440091641	PA5768	791440093836	BK6076	791440092464
RS5448	791440083745	RS5546	791440088139	RS5676	791440091658	PA5770	791440094451	BK6077	791440092471
RS5449	791440085909	RS5547	791440088771	PA5678	791440091719	PA5771	791440094468	BK6080	791440092501
CA5450	791440094722	RS5548	791440088788	PA5679	791440091740	PA5772	791440094475	BK6081	791440093782
PA5451	791440089402	RS5549	791440088795	PA5680	791440091771	PA5773	791440094482	BK6082	791440109506
RS5452	791440085732	RS5550	791440088764	PA5681	791440091795	PA5774	791440094505	BK6083	791440109315
RS5453	791440085756	PA5552	791440088344	PA5682	791440091832	RS5776	791440094550	BK6085	791440109513
PA5454	791440085664	PA5554	791440088368	PA5683	791440091924	PA5777	791440094574	BK6086	791440104280
RS5455	791440085671	PA5556	791440088382	RS5684	791440092136	PA5778	791440094581	BK6087	791440104297
RS5456	791440085688	PA5557	791440088399	RS5685	791440092143	PA5779	791440094598	BK6088	791440109322
PA5457	791440085787	RS5558	791440088450	PA5686	791440092150	PA5780	791440094628	BK6089	791440108646
RS5458	791440085831	RS5559	791440088641	PA5687	791440092167	PA5781	791440094635	BK6090	791440108127
RS5459	791440085930	PA5561	791440088656	PA5688	791440092174	RS5782	791440094673	BK6092	791440108677
RS5460	791440085947	RS5562	791440088573	PA5689	791440092181	RS5783	791440094680	BK6093	791440108943
RS5461	791440086111	PA5563	791440088597	PA5690	791440092198	RS5784	791440094741	BK6094	791440109124
RS5462	791440086128	BA5566	791440088665	PA5691	791440092204	PA5785	791440094710	BK6095	791440111271
PA5463	791440087958	PA5573	791440089013	RS5692	791440092211	PA5786	791440094727	BK6096	791440111288
PA5464	791440086166	PA5574	791440089020	RS5693	791440092228	PA5787	791440094734	BK6097	791440111295
PA5465	791440086227	PA5580	791440089761	PA5694	791440092235	CA5788	791440094789	BK6098	791440111301
PA5467	791440086258	PA5581	791440089778	PA5695	791440092242	CA5789	791440094819	BK6099	791440111318
PA5468	791440092129	PA5583	791440089792	PA5696	791440092259	CA5790	791440094826	BK6102	791440116221
RS5470	791440086340	PA5584	791440089808	PA5697	791440092266	CA5791	791440094833	BK6103	791440116238
RS5471	791440086357	PA5585	791440089921	PA5698	791440092327	PA5792	791440094840	BK6104	791440116245
RS5472	791440086364	PA5586	791440089938	PA5699	791440092334	CA5793	791440094857	BK6105	791440116269
PA5473	791440086302	BF5587-D	791440076488	PA5700	791440092342	PA5796	791440094895	BK6106	791440116276
PA5475	791440086319	PA5588	791440089822	RS5707	791440092617	PA5797	791440094901	BK6107	791440116283
PA5476	791440086326	PA5589	791440089839	RS5708	791440092624	PA5798	791440094918	BK6108	791440116290
PA5477	791440086333	RS5591XP	791440098336	PA5710	791440092693	BF5800	791440027190	BK6110	791440109735
RS5478-FN	791440086630	BA5592	791440090002	PA5711	791440092709	BF5801	791440027183	BK6112	791440109858
RS5479	791440086647	RS5593XP	791440098343	PA5712	791440092716	BF5810	791440027206	BK6114	791440116160
PA5482	791440086449	PA5594	791440090033	PA5713	791440092723	BF5812	791440027213	BK6115	791440116290
RS5483	791440086500	PA5597	791440090057	PA5716	791440092761	BF5813	791440027220	BK6116	791440116030
RS5484	791440086517	PA5618	791440090194	PA5719	791440092792	BF5813-O	791440097599	BK6117	791440110533
PA5485-FN	791440086531	PA5619	791440090200	PA5720	791440092815	BF5815	791440060036	BK6118	791440110649
PA5486	791440086579	PA5620	791440090217	PA5722	791440092839	BF5816	791440066977	BK6120	791440116306
PA5487	791440086548	PA5621	791440090224	PA5723	791440092846	6017	791440027282	BK6121	791440115958
RS5489	791440094642	PA5622	791440090231	PA5725	791440092884	6020	791440027305	BK6124	791440116771
RS5490	791440094659	PA5623	791440090248	PA5727	791440092914	6021	791440027312	BK6130	791440117013
PA5491	791440086753	PA5624	791440090255	PA5728	791440092921	BK6022	791440084049	BK6138	791440105447
PA5492	791440086760	PA5625	791440090279	PA5728 FOAM	791440092938	BK6023	791440084056	BK6140	791440106789
PA5493	791440086777	PA5626	791440090293	PA5729	791440092952	BK6024	791440084063	BK6161	791440086661
PA5494	791440086791	RS5627	791440090316	RS5730	791440092969	BK6025	791440084070	BK6167	791440087699
PA5495	791440086807	RS5628	791440090323	RS5731	791440092976	BK6026	791440084087	BK6181	791440079335
PA5496	791440086838	PA5629	791440090330	PA5732	791440092983	BK6027	791440084124	BK6183	791440072510
PA5497	791440086845	PA5630	791440090347	PA5733	791440093157	BK6028	791440085640	BK6184	791440067455
PA5498	791440086890	PA5631	791440090354	PA5734	791440093195	BK6029	791440085749	BK6185	791440076952
PA5499	791440086906	PA5632	791440090372	PA5735	791440093218	BK6030	791440085923	BK6187	791440078208
CA5500	791440086913	PA5633	791440090477	PA5736	791440093225	BK6031	791440085961	BK6195	791440056633
PA5503	791440086975	PA5636	791440090514	PA5738	791440093294	BK6032	791440085978	BK6196	791440056640
PA5504	791440086982	PA5637	791440090699	PA5739	791440093300	BK6033	791440086524	BK6215	791440062030
PA5505	791440087071	PA5644	791440090705	RS5741	791440093324	BK6034	791440088061	BK6287	791440052338
RS5506	791440087460	RS5641	791440091009	RS5742	791440093331	BK6035	791440088078	BK6341	791440062979
RS5507	791440087132	PA5642	791440091085	RS5743	791440093338	BK6045	791440086036	BK6375	791440046450
RS5508	791440087156	PA5644	791440091108	RS5743XP	791440093355	BK6049	791440089457	BK6376	791440046542
RS5509	791440087194	PA5649	791440091245	RS5744	791440093362	BK6050	791440089464	BK6380	791440027725
RS5510	791440087200	PA5650	791440091265	RS5745	791440093379	BK6051	791440094888	BK6426	791440077843
PA5511	791440087248	PA5651	791440091283	RS5746	791440096585	BK6053	791440089495	BK6429	791440079410
PA5512	791440087255	PA5652	791440091290	RS5747	791440093386	BK6054	791440089501	BK6438	791440086654
CA5514	791440087293	PA5653	791440091306	RS5748	791440093393	BK6055	791440089976	BK6440	791440066120
PA5515	791440087309	PA5654	791440091320	RS5749	791440093409	BK6056	791440090095	BK6451	791440077935
PA5516	791440087347	PA5655	791440091337	RS5750	791440093416	BK6057	791440108844	BK6452	791440077942
RS5517	791440087491	PA5656	791440091399	PA5751	791440093430	BK6058	791440090651	BK6457	791440087224
PA5528	791440087835	PA5657	791440091405	PA5752	791440093454	BK6059	791440090675	BK6464	791440078598
PA5529	791440087842	PA5658	791440091412	PA5753	791440093522	BK6060	791440091269	BK6467	791440064355
PA5530	791440087859	PA5661	791440091443	RS5754	791440093539	BK6061	791440091349	BK6561	791440028081
PA5532	791440087934	PA5662	791440091450	PA5755	791440093546	BK6062	791440091351	BK6562	791440028098
PA5533	791440087941	PA5663	791440091467	RS5756	791440093553	BK6063	791440091368	BK6579	791440046252
RS5534	791440090361	PA5664	791440091474	PA5757	791440093591	BK6064	791440091597	BK6583	791440047211
RS5535	791440090453	PA5665	791440091481	RS5758	791440093607	BK6065	791440091726	BK6595	791440054752
RS5536	791440088757	PA5666	791440091498	RS5759	791440093614	BK6067	791440091955	BK6600	791440028128



WARNING: These products can expose you to chemicals, including Diisononyl Phthalate, Carbon black extracts, Nickel, 1,3 Butadiene, Ethylene Oxide, Epichlorohydrin, which are known to the State of California to cause cancer, and Bisphenol-A, Ethylene Glycol, Ethylene Oxide, 1,3 Butadiene, Epichlorohydrin, which are known to the State of California to cause birth defects or other reproductive harm. For more information go to www.P65Warnings.ca.gov.

BALDWIN TO UPC (INDIVIDUAL PARTS)

BALDWIN NUMBER	UPC NUMBER	BALDWIN NUMBER	UPC NUMBER	BALDWIN NUMBER	UPC NUMBER	BALDWIN NUMBER	UPC NUMBER	BALDWIN NUMBER	UPC NUMBER
BK6601	791440028135	B7024	791440028623	B7163	791440058019	B7274	791440071926	B7385	791440087552
BK6610	791440028203	B7025	791440028630	B7164	791440058026	B7275	791440071933	B7386	791440087569
BK6613	791440077119	B7026-MPG	791440048706	B7165	791440058057	B7276	791440071940	B7387	791440087576
BK6619	791440045538	BD7028	791440037618	BD7166	791440058149	B7277	791440071957	B7388	791440088146
BK6634	791440053236	BD7029	791440051225	B7167	791440058446	B7280	791440071988	B7390	791440088238
BK6650	791440085657	B7030	791440040243	BD7168	791440058644	B7281	791440071995	B7393	791440088252
BK6652	791440082175	B7031	791440038851	BD7169	791440058668	B7283	791440072015	BC7394	791440092419
BK6653	791440083110	B7033	791440054233	B7170	791440058750	B7285	791440072039	B7395	791440092549
BK6654	791440077966	B7034	791440054240	B7171	791440058767	B7286	791440072046	B7396	791440077393
BK6656	791440082953	P7035	791440038110	B7172	791440059641	B7287	791440072053	B7397	791440079946
BK6657	791440083127	B7039	791440037854	BC7173	791440059412	B7289	791440072077	P7398	791440080348
BK6658	791440076495	B7042	791440038875	B7174-MPG	791440061262	B7290	791440072084	P7399	791440080355
BK6659	791440076501	B7044	791440038387	B7175	791440058408	B7291	791440072091	P7400	791440080362
BK6661	791440076365	B7045	791440043671	BD7176	791440060142	B7292	791440072107	B7401	791440080379
BK6662	791440076099	B7047	791440038066	B7177	791440060210	B7293	791440072114	B7402	791440080614
BK6663	791440076037	B7049	791440044999	P7178	791440060289	B7294	791440072121	B7403	791440080621
BK6665	791440072596	P7050	791440043718	B7179	791440060296	B7295	791440072138	P7406	791440080911
BK6666	791440077904	B7051	791440037625	B7180	791440058552	B7298	791440074705	B7407	791440081055
BK6670	791440067103	P7052	791440045712	B7181	791440060739	B7299	791440066755	P7408	791440081185
BK6675	791440065956	P7053	791440037588	B7182	791440060845	P7303	791440074743	B7409	791440081192
BK6676	791440065963	P7058	791440038226	P7183	791440061064	P7305	791440075030	B7410	791440081208
BK6683	791440063884	P7059	791440038233	P7185	791440061477	B7306	791440076297	P7411	791440081222
BK6686	791440063020	P7081	791440043145	BC7186 KIT	791440061613	P7308	791440076464	P7413	791440081277
BK6693	791440066045	B7082	791440043282	B7187	791440061736	BD7309	791440058941	P7414	791440081284
BK6694	791440062566	P7083	791440043329	P7188	791440061941	BD7310	791440060685	P7415	791440081369
BK6696	791440061057	P7084	791440043350	B7189	791440060852	B7311-MPG	791440076532	B7416	791440081413
BK6700	791440028241	B7089	791440045019	P7190	791440061972	P7312	791440076549	P7417	791440081987
BK6702	791440045972	B7091	791440045217	B7191	791440062047	P7313	791440076570	P7418	791440081611
BK6704	791440056138	P7092	791440045552	P7192	791440062078	B7314	791440076747	B7419	791440081789
BK6705	791440056145	P7093	791440045569	P7193	791440062092	BT7316	791440076914	B7420	791440081918
BK6710	791440028265	BD7095	791440046061	BC7194	791440062146	BD7317	791440076969	B7422	791440081925
BK6720	791440028296	B7097	791440046610	P7195	791440062214	B7318	791440077041	P7423	791440081949
BK6721	791440028302	B7099	791440047020	P7196	791440062399	P7319	791440077089	B7424	791440082090
BK6723	791440028326	P7102	791440047082	B7197	791440064034	B7320	791440077171	P7426	791440082106
BK6764	791440042254	P7103	791440047556	P7199	791440062603	P7321	791440077263	P7427	791440082113
BK6780	791440028333	P7104	791440047587	B7215	791440062993	B7322	791440077324	B7428	791440082168
BK6799	791440046955	BD7105	791440047594	B7216	791440063105	B7324	791440077676	B7430	791440082274
BK6903	791440064225	P7106	791440047600	B7217	791440063112	BD7325	791440077744	B7431	791440082304
BK6923	791440078369	P7107	791440047617	B7219	791440063371	BC7326	791440078529	B7432	791440082311
BK6930	791440080157	B7113	791440047846	B7220	791440063877	B7327	791440078567	B7433	791440082328
BK6931	791440080164	P7114	791440048263	B7221	791440063907	B7328	791440078659	B7434	791440082441
BK6933	791440080201	B7116	791440048720	B7222	791440063914	P7329	791440078963	B7435	791440082625
BK6934	791440066502	B7117	791440048829	B7223	791440064164	P7330	791440079069	P7436	791440082717
BK6942	791440083295	B7119	791440050297	B7224	791440064430	PT7332	791440079113	P7437	791440082724
BK6953	791440083806	B7121	791440050525	B7225	791440064478	B7333	791440079830	P7438	791440083769
BK6954	791440083813	B7124	791440051300	B7227	791440064621	B7334	791440080058	B7440	791440082818
BK6955	791440083820	B7125	791440051393	BC7228	791440064645	B7335-MPG	791440080041	B7441	791440082854
BK6956	791440085800	P7126	791440051324	B7229	791440064683	P7336 KIT	791440080102	P7442	791440083028
BK6980	791440081529	P7127	791440051478	P7230	791440064850	P7337	791440080263	B7443	791440083202
BK6982	791440081543	B7128	791440052086	B7231	791440064881	P7338	791440080287	B7444	791440083219
BK6983	791440081734	V7129-C	791440052529	P7232	791440064942	BT7349	791440076266	B7445	791440083233
BK6984	791440081550	B7130	791440052604	P7233	791440065017	B7350	791440080418	B7446	791440083264
BK6985	791440083783	B7131	791440052611	P7235	791440065086	B7351-MPG	791440085510	B7449	791440083950
BK6986	791440083790	P7132	791440053120	B7237	791440065086	B7352	791440085596	P7450	791440083301
BK6987	791440083998	P7134	791440054325	B7238	791440065383	BD7355	791440085794	B7451	791440083318
BK6997	791440084117	B7135	791440054363	B7239	791440065475	B7356	791440085848	B7452	791440083363
P7000 KIT	791440038134	P7136	791440054608	B7240	791440065499	B7357	791440085886	B7453	791440083486
B7001	791440048195	P7137	791440054615	B7241	791440065680	B7359	791440085916	P7454	791440083558
P7003	791440028487	P7138	791440054622	BC7242	791440066229	B7360	791440086135	P7455	791440083660
B7004	791440028494	B7139	791440054677	B7243	791440066366	B7361	791440086180	BC7456 KIT	791440083837
B7005	791440028500	BD7141	791440055094	B7245	791440066779	B7362	791440086234	B7457	791440083806
P7007	791440038813	B7142	791440055124	B7246	791440067035	B7363	791440086371	B7458	791440083813
B7009	791440028531	B7143	791440055810	P7247	791440067165	P7364	791440086388	B7459	791440083820
B7010	791440028548	B7144	791440055957	B7249-MPG	791440067219	P7365	791440086456	B7461	791440083848
B7011	791440028555	P7145	791440056619	BD7250	791440067387	B7367	791440086555	B7466	791440086889
P7012	791440038820	B7151	791440056848	BD7252	791440067394	P7368	791440086623	B7467	791440088702
P7013	791440042568	B7152	791440056855	P7255	791440071735	B7370	791440086920	B7468	791440088719
B7014	791440028562	BD7153	791440056886	P7256	791440071742	B7372	791440087187	B7469	791440088726
P7015	791440046627	BD7154	791440056893	P7259	791440071773	B7373	791440087316	B7477	791440088863
P7016	791440046726	B7155	791440056930	P7260	791440071780	B7375	791440087385	B7483	791440088931
P7017	791440046733	B7156	791440057494	P7263	791440071810	B7376	791440087392	BC7485	791440089051
B7018	791440028579	B7157	791440057760	B7264	791440071827	B7377	791440087408	B7486	791440089143
B7019	791440028586	BD7158	791440057852	P7267	791440071858	B7378	791440087422	B7487	791440089150
B7020	791440028593	BD7159	791440057951	P7268	791440071865	B7379	791440087484	P7488	791440089204
P7021	791440046474	BD7160	791440057968	BD7160	791440071872	P7269	791440087729	P7489	791440089211
B7022	791440028609	B7161	791440058125	B7271	791440071896	B7383	791440087538	P7490	791440089334
B7023	791440028616	B7162	791440058002	B7273	791440071919	B7384	791440087545	B7491	791440089341



WARNING: These products can expose you to chemicals, including Diisononyl Phthalate, Carbon black extracts, Nickel, 1,3 Butadiene, Ethylene Oxide, Epichlorohydrin, which are known to the State of California to cause cancer, and Bisphenol-A, Ethylene Glycol, Ethylene Oxide, 1,3 Butadiene, Epichlorohydrin, which are known to the State of California to cause birth defects or other reproductive harm. For more information go to www.P65Warnings.ca.gov.

BALDWIN TO UPC (INDIVIDUAL PARTS)

BALDWIN NUMBER	UPC NUMBER	BALDWIN NUMBER	UPC NUMBER	BALDWIN NUMBER	UPC NUMBER	BALDWIN NUMBER	UPC NUMBER	BALDWIN NUMBER	UPC NUMBER
P7492	791440089860	BF7614	791440050501	PF7734	791440061866	PF7834	791440069480	BF7927	791440079151
P7493	791440089952	P7615	791440050518	PF7735	791440061927	PF7836	791440069503	PF7928	791440079533
P7494	791440090088	PT7616	791440050600	BF7736	791440062276	BF7837	791440069510	BF7929 KIT	791440079540
P7495	791440090415	PT7617	791440050617	BF7736-K1	791440069664	BF7838	791440069527	PF7930	791440079687
B7496	791440090538	PF7618	791440050907	BF7742	791440062658	BF7839	791440069534	BF7931	791440079847
B7497	791440090965	BF7619	791440050969	PF7744	791440062801	BF7840	791440069541	BF7932	791440079854
B7499	791440091689	BF7623	791440051492	BF7745-D	791440066472	BF7841	791440069558	PF7934 KIT	791440080133
F7500	791440028715	BF7624	791440051669	BF7746-D	791440066465	BF7842	791440069565	PF7935	791440080218
P7500	791440028722	BF7625	791440051775	BF7747	791440063204	BF7843	791440069572	PF7936	791440080331
B7501	791440091887	BF7626	791440052031	PF7748	791440063211	BF7844	791440069589	BF7937	791440080393
P7502	791440091993	PF7627	791440052048	PF7749	791440063228	BF7845	791440069596	PF7938	791440080638
B7503	791440092112	BF7628	791440052222	BF7750	791440063273	BF7847	791440069619	PF7939	791440080850
BD7504	791440092273	BF7629	791440052277	PF7751	791440062955	BF7848	791440069626	BF7940	791440080867
P7505	791440088290	BF7630	791440052291	BF7753	791440063679	BF7849	791440069633	BF7941	791440080874
B7506	791440092280	BF7631	791440052321	PF7755	791440063209	BF7850	791440069640	BF7942	791440080904
B7507	791440092402	BF7632	791440052352	BF7756	791440063730	BF7851	791440069657	BF7943	791440081154
P7508	791440092587	BF7633	791440053113	PF7758	791440063839	PF7852 KIT	791440072497	BF7944	791440081260
BD7509	791440092686	BF7634	791440053298	BF7759	791440064207	BF7853	791440072534	BF7945	791440081406
P7510	791440093232	BF7635	791440053373	BF7760	791440063969	BF7855	791440074576	PF7946	791440081499
B7511	791440093263	BF7637	791440086159	PF7761	791440064843	BF7857	791440074590	PF7947	791440081598
P7512	791440093737	BF7639	791440054431	BF7762	791440064157	BF7859	791440074613	BF7948	791440081635
B7513	791440093744	BF7639-D	791440054837	BF7763	791440064287	BF7860	791440074620	BF7949-D	791440081659
P7514	791440093768	BF7640	791440056251	BF7765	791440064485	BF7861	791440074637	BF7949-DM	791440083332
P7515	791440093829	BF7641	791440052437	BF7766	791440065154	BF7863	791440074644	BF7950-D	791440081666
B7516	791440094413	BF7644	791440052741	PF7767	791440065543	BF7864	791440074651	BF7951-D	791440081741
P7517	791440094437	BF7645	791440052628	BF7768	791440065871	BF7865	791440074668	BF7952-D	791440081758
BF7519	791440028760	BF7648	791440053069	BF7769	791440066144	BF7866	791440074675	BF7954-D	791440081772
BF7522	791440048911	BF7653	791440056268	PF7770	791440066168	PF7869	791440074484	BF7955	791440081901
BF7528	791440028821	PF7655	791440057487	BF7771	791440066274	BF7872	791440074514	BF7956-D	791440081932
BF7529	791440028838	BF7656	791440054462	BF7772	791440066595	PF7873	791440074521	BF7957	791440082182
BF7531	791440038882	BF7657	791440055032	BF7773	791440066694	PF7874	791440074538	BF7958	791440082243
BF7532	791440046559	BF7658	791440054974	BF7774	791440066700	BF7875	791440074545	BF7959	791440082410
BF7534	791440041530	BF7659	791440054912	BF7775	791440066853	PF7876	791440074552	BF7960	791440082427
BF7535	791440045248	BF7661	791440054936	BF7776	791440066960	PF7877	791440074569	BF7961	791440082434
BF7537	791440054264	BF7663	791440054974	PF7777	791440067004	BF7878	791440075047	BF7962	791440082588
BF7538	791440028852	BF7664	791440054981	BF7778	791440067011	BF7879	791440075665	BF7963	791440082595
BF7541	791440037984	BF7666	791440055056	PF7779	791440067080	BF7880	791440071889	BF7964-D	791440082601
BF7544	791440039796	BF7667	791440055117	BF7780	791440067141	BF7881	791440075924	BF7965	791440082755
PF7545	791440043664	BF7668	791440057500	PF7782	791440067486	PF7882	791440075917	BF7966	791440082823
BF7546	791440037865	BF7669	791440055858	BF7783-D	791440067493	BF7883	791440076280	BF7967	791440082915
PF7549	791440037632	BF7670	791440055940	BF7784-D	791440067509	BF7886	791440076433	BF7968	791440083257
PF7550	791440037687	BF7671	791440056121	BF7785-D	791440067516	BF7888	791440076860	BF7968-O	791440097629
PF7551	791440037694	BF7672-D	791440066403	BF7786-D	791440067530	BF7889	791440076600	BF7969	791440083684
BF7552	791440037748	BF7673-D	791440066434	PF7787	791440069299	PF7889-10	791440076617	BF7970	791440085862
PF7553	791440038240	BF7674-D	791440066441	PF7788	791440069305	PF7889-30	791440076624	BF7971-D	791440083349
PF7554	791440038257	BF7675-D	791440066427	BF7798-O	791440110410	BF7890	791440076631	BF7971-DM	791440083356
PF7556	791440038325	BF7677-D	791440066458	BF7798-SP	791440076723	PF7890-10	791440076648	BF7972	791440083752
BF7557	791440028869	PF7678	791440054578	PF7799	791440064768	PF7890-30	791440076655	PF7973	791440083981
BF7558	791440028883	BF7679-D	791440066397	BF7800	791440064775	BF7892	791440076884	PF7974	791440085503
BF7559	791440038349	PF7680	791440057036	BF7801	791440064782	PF7894	791440077027	PF7975	791440085589
BF7571	791440041295	BF7681-D	791440066380	BF7802	791440064793	PF7895	791440077034	BF7976	791440085695
PF7572	791440042537	BF7682-D	791440066410	BF7803	791440064799	BF7896	791440077096	PF7977	791440077690
BF7576	791440042766	BF7683	791440059658	BF7804	791440064980	BF7898-D	791440077157	PF7978	791440085763
B7577	791440028906	B7685	791440058392	BF7805	791440064997	PF7899	791440077270	BF7979	791440085879
BF7579	791440042773	BF7686	791440058507	BF7806	791440065000	PF7900	791440077287	PF7980	791440085954
BF7580	791440042780	PF7687	791440058521	BF7806-O	791440110397	BF7903	791440077379	BF7981	791440086005
BF7584	791440043138	BF7690	791440058576	BF7808	791440065031	BF7904-D	791440077386	PF7982	791440086210
B7585	791440043275	BF7691	791440058866	BF7809	791440065079	BF7905-D	791440077416	PF7983	791440086074
BF7586	791440043305	BF7693	791440058897	PF7812 KIT	791440065130	BF7906-D	791440077423	PF7984	791440086081
BF7587	791440043312	BF7695	791440059283	BF7813	791440065314	BF7907	791440077430	BF7985	791440086104
PF7588	791440043336	BF7696	791440059665	BF7814	791440065352	BF7908	791440077553	PF7986	791440086203
BF7591-D	791440045521	BF7697	791440059917	BF7815	791440067233	BF7909	791440077560	BF7987	791440086241
PF7592	791440045583	PF7698	791440059900	PF7816	791440069312	PF7910	791440077584	BF7988	791440086265
BF7593	791440046122	BF7699-D	791440066489	PF7817	791440069329	BF7911	791440077890	BF7989-D	791440086289
PF7594	791440046283	B7700	791440066830	PF7818	791440069336	BF7912	791440078130	BF7990	791440086432
PF7595	791440046290	BF7711	791440060715	PF7819	791440069343	BF7913	791440078154	BF7993	791440086487
PF7596	791440046412	BF7713	791440060470	PF7820	791440069350	PF7914	791440078406	PF7994	791440086609
PF7597	791440046535	PF7715	791440060494	BF7821	791440069367	BF7915	791440078413	BF7995	791440086616
BF7598	791440047570	PF7716	791440060500	PF7822	791440069374	BF7916	791440078536	BF7996	791440086678
B7600	791440028937	BF7717	791440060517	PF7823	791440069381	BF7917	791440078550	BF7997	791440086784
B7600-SS	791440050433	PF7718	791440060647	PF7824	791440069398	BF7919	791440078819	BF7998	791440086821
BF7602	791440047662	BF7719	791440061088	PF7825	791440069404	BF7921	791440078901	BF8301	791440029071
BF7606	791440047822	BF7720	791440061101	PF7826	791440069411	BF7922	791440079007	BF8302	791440038899
PT607	791440051676	BF7721	791440061132	PF7828	791440069428	BF7923	791440079052	BF8304	791440029095
BF7608	791440048942	BF7725	791440061163	PF7829	791440069442	BF7924	791440079250	BF8305	791440029101
BF7612	791440050457	BF7726	791440061408	PF7832	791440069466	BF7925	791440079397	PT8306-10	791440029118
BF7613	791440050464	PF7733	791440061859	PF7833	791440069473	FD7926	791440079380	PT8306-25	791440029125



WARNING: These products can expose you to chemicals, including Diisononyl Phthalate, Carbon black extracts, Nickel, 1,3 Butadiene, Ethylene Oxide, Epichlorohydrin, which are known to the State of California to cause cancer, and Bisphenol-A, Ethylene Glycol, Ethylene Oxide, 1,3 Butadiene, Epichlorohydrin, which are known to the State of California to cause birth defects or other reproductive harm. For more information go to www.P65Warnings.ca.gov.

BALDWIN TO UPC (INDIVIDUAL PARTS)

BALDWIN NUMBER	UPC NUMBER	BALDWIN NUMBER	UPC NUMBER	BALDWIN NUMBER	UPC NUMBER	BALDWIN NUMBER	UPC NUMBER	BALDWIN NUMBER	UPC NUMBER
BT8307-MPG	791440030466	BT8418	791440056114	BT8503-MPG	791440063167	BT8879-MPG	791440055773	PT8982-MPG	791440070417
BT8308-MPG	791440030473	PT8419	791440056190	BT8504	791440063174	BT8880-MPG	791440056183	PT8984-MPG	791440070431
BT8309-MPG KIT	791440051096	BT8420	791440056985	BT8505	791440063617	PT8883	791440064935	PT8985-MPG	791440070448
BT8309-MPG	791440030480	BT8421-MPG	791440057517	PT8506-MPG	791440063525	BT8884-MPG	791440065093	PT8986-MPG	791440070455
BT8310-MPG	791440030497	BT8422-MPG	791440057524	PT8507-MPG	791440063532	PT8885-MPG	791440065161	PT8987-MPG	791440070462
BT8312	791440029132	BT8423	791440057531	BT8509-MPG	791440063600	BT8886-MPG	791440065192	PT8989-MPG	791440070486
BT8314	791440029149	PT8425	791440057869	BT8510-MPG	791440063662	PT8887	791440065468	PT8990-MPG	791440070493
BT8316-MPG	791440038905	BT8426-MPG	791440057937	PT8511	791440065529	PT8888	791440065505	PT8991-MPG	791440070509
PT8318-MPG	791440029156	PT8427	791440058170	BT8512	791440064836	PT8889	791440065604	PT8992-MPG	791440070516
PT8319	791440043152	BT8428-MPG	791440058248	PT8517-MPG	791440066250	BT8890-MPG	791440065697	PT8993-MPG	791440070523
BT8320	791440029163	BT8429	791440058316	PT8519-MPG	791440065147	PT8891-MPG	791440065734	PT8994-MPG	791440070530
BT8323	791440038943	BT8432-MPG	791440058569	OV8700	791440057326	BT8892-MPG	791440065741	PT8995-MPG	791440070547
BT8328	791440038080	PT8433-MPG	791440058583	OV8701	791440057333	PT8893	791440065864	PT8996-MPG	791440070554
PT8329	791440042926	PT8435-MPG	791440058798	OS8703	791440057357	PT8894-MPG	791440066069	PT8997-MPG	791440070561
PT8330-MPG	791440038943	PT8436	791440058804	OS8704	791440057364	PT8895-MPG	791440066076	PT8998-MPG	791440070578
PT8331-MPG	791440038141	BT8437	791440058811	OS8707	791440066359	PT8896	791440066113	PT8999-MPG	791440070585
BT8333	791440038950	BT8439-MPG	791440059061	OP8709	791440057388	PT8897-MPG	791440066212	H9001	791440029255
PT8334	791440043725	BT8440-MPG	791440059030	BT8711	791440055353	OB8711	791440066236	OB8711	791440029279
PT8335	791440043176	PT8441	791440059177	OB8712	791440055360	BT8899	791440066243	H9013	791440029293
PT8338	791440043657	PT8442	791440059382	OB8720	791440055445	BT8900	791440066304	H9014	791440029309
PT8339	791440045897	BT8443	791440059504	OB8721	791440055452	BT8901-MPG	791440066496	H9020	791440029323
PT8341	791440043169	BT8444	791440059610	OB8722	791440055469	BT8902	791440066649	H9021	791440029330
BT8344	791440037571	BT8445	791440059788	OB8724	791440055483	BT8903	791440066663	H9024	791440029347
PT8345	791440038073	PT8446-MPG	791440059795	OV8728	791440081642	BT8904-MPG	791440066670	H9036	791440029361
BT8347	791440038295	PT8447-MPG	791440059870	OB8731	791440057067	BT8905	791440067028	H9041	791440029408
PT8350	791440039353	P8448	791440059887	OB8732	791440057074	BT8906	791440067127	H9042	791440029415
PT8351	791440041196	BT8449	791440060005	OB8741	791440057135	PT8907-MPG	791440067158	H9043	791440029422
PT8352	791440041189	BT8449-10	791440060012	OB8742	791440057142	BT8908	791440067226	H9043-V	791440077621
PT8353	791440041202	BT8450	791440060104	OB8743	791440057128	PT8909	791440067240	H9044	791440029439
PT8354	791440042490	PT8451-MPG	791440060135	OB8744	791440057173	BT8910-MPG	791440067301	H9045	791440029446
PT8355	791440042506	PT8452	791440060159	OB8745	791440057180	BT8911-MPG	791440067318	H9046	791440029453
PT8356	791440043091	PT8453	791440060340	OP8750	791440083530	PT8912	791440067400	H9047	791440029460
BT8357	791440043206	PT8455-MPG	791440060616	OP8751	791440083547	BT8913-MPG	791440069671	H9048	791440029477
PT8359	791440043374	PT8456-MPG	791440060692	OP8752	791440083554	BT8914	791440069725	H9049	791440029484
PT8361	791440044968	BT8457-MPG	791440060753	OP8753	791440083561	BT8915	791440069732	H9050	791440029491
PT8363	791440045095	PT8458-MPG	791440060784	OB8771	791440057197	BT8916	791440069749	H9051	791440029507
PT8366	791440045231	PT8459	791440060883	OB8772	791440057203	BT8917	791440069756	H9052	791440063631
BT8368	791440045491	BT8460	791440062931	OB8773	791440057395	BT8918	791440069763	H9054	791440029521
PT8370-MPG	791440047112	PT8461	791440063976	CFB8784	791440092945	BT8919	791440069770	H9055	791440029538
PT8371-MPG	791440047129	BT8462-MPG	791440064145	BT8800-MPG	791440060548	BT8920	791440069787	H9056	791440029545
PT8372	791440047655	BT8463-MPG	791440064552	BT8801-MPG	791440060555	BT8922	791440069800	H9058	791440029569
PT8375-MPG	791440048140	BT8464	791440064569	BT8802-MPG	791440029194	BT8926	791440069848	H9060	791440029576
PT8376-MPG	791440048157	BT8465	791440064576	BT8803-MPG	791440029200	BT8927	791440069855	H9062	791440029583
PT8378-MPG	791440048676	PT8468	791440064539	BT8805-MPG	791440057913	BT8928	791440069862	H9069	791440029590
PT8380	791440051805	BT8470	791440064600	BT8812-MPG	791440029231	BT8930	791440069868	H9070	791440029606
BT8381	791440049680	BT8471-MPG	791440064684	BT8813-MPG	791440029248	BT8931	791440069893	H9071	791440029613
BT8382	791440050105	BT8472	791440064691	BT8830	791440042995	BT8935	791440069930	H9072	791440029620
PT8383	791440050129	BT8473	791440064707	BT8831	791440043015	BT8937	791440069954	H9072-V	791440075757
BT8384	791440050334	BT8474	791440064514	BT8832	791440043008	PT8939-MPG	791440069978	H9073	791440029637
PT8385	791440050532	BT8475	791440064521	BT8833	791440058163	PT8940-MPG	791440069985	H9074	791440029644
PT8386	791440050594	BT8475-MPG	791440073548	BT8834-MPG	791440062320	PT8941-MPG	791440069992	H9075	791440029651
PT8387	791440050686	BT8476	791440064538	BT8840-MPG	791440038394	PT8943-MPG	791440070011	H9075-V	791440077539
PT8388	791440050693	BT8476-MPG	791440069688	BT8841-MPG	791440046917	PT8945-MPG	791440070035	H9076	791440029668
BT8391	791440050945	BT8477	791440064545	BT8842-MPG	791440051973	PT8946-MPG	791440070042	H9076-V	791440075764
PT8392	791440051003	BT8477-MPG	791440073555	BT8843-MPG	791440052000	PT8947-MPG	791440070059	H9077	791440029675
BT8393	791440051454	PT8478	791440061606	BT8844	791440042636	PT8948-MPG	791440070066	H9078	791440029682
PT8394-MPG	791440051553	PT8479	791440061637	BT8845	791440042629	PT8950-MPG	791440070080	H9078-V	791440075771
PT8395	791440051621	PT8480	791440061644	BT8846	791440045934	PT8951-MPG	791440070097	H9079	791440029699
PT8396	791440051638	PT8481	791440062634	BT8847	791440059634	PT8952-MPG	791440070103	H9080	791440029705
BT8397-MPG	791440051850	PT8484	791440061897	BT8848-MPG	791440051652	PT8954-MPG	791440070127	H9081	791440029712
BT8398-MPG	791440051904	PT8485	791440062054	BT8849-MPG	791440055735	PT8955-MPG	791440070134	H9082	791440029729
PT8400-MPG	791440052079	BT8486	791440062108	BT8850-MPG	791440039867	PT8956-MPG	791440070141	H9083	791440029736
BT8401-MPG	791440052123	PT8487	791440062122	BT8851-MPG	791440039322	PT8957-MPG	791440070158	H9084	791440029743
PT8402-MPG	791440052178	BT8488	791440062139	BT8852-MPG	791440045941	PT8958-MPG	791440070165	H9085	791440029750
PT8403-MPG	791440052192	PT8489	791440062160	BT8853-MPG	791440053304	PT8959-MPG	791440070172	H9086	791440029767
PT8404-MPG	791440052284	PT8490-MPG	791440062221	BT8855-MPG	791440055742	PT8960-MPG	791440070189	H9087	791440062252
PT8407	791440053076	PT8491	791440062283	BT8856-MPG	791440059573	PT8962-MPG	791440070219	H9092	791440029774
PT8408	791440053083	PT8492	791440062290	BT8861	791440039891	PT8967-MPG	791440070264	H9093	791440029781
BT8409	791440053199	BT8493	791440062375	BT8862	791440038400	PT8969-MPG	791440070288	H9096	791440029804
PT8410	791440058187	PT8494	791440062504	BT8863	791440038417	PT8970-MPG	791440070295	H9097	791440029811
PT8411	791440058194	PT8495-MPG	791440062665	BT8870-MPG	791440046429	PT8971-MPG	791440070301	H9103	791440029828
BT8412	791440054424	PT8496-MPG	791440062788	BT8873	791440046451	PT8972-MPG	791440070318	H9107	791440029835
BT8413	791440055896	BT8497-MPG	791440062856	BT8874-MPG	791440046443	PT8974-MPG	791440070332	H9108	791440029842
PT8414-MPG	791440055001	PT8498	791440062917	BT8875-MPG	791440046566	PT8975-MPG	791440070349	H9110	791440029859
BT8415	791440055889	BT8499	791440063006	BT8876-MPG	791440048775	PT8978-MPG	791440070370	H9111	791440029866
BT8416	791440055100	BT8501-MPG	791440063051	BT8877-MPG	791440055759	PT8980-MPG	791440070394	H9112	791440029873
BT8417	791440055872	BT8502	791440063099	BT8878-MPG	791440055766	PT8981-MPG	791440070400	H9113	791440029880



WARNING: These products can expose you to chemicals, including Diisononyl Phthalate, Carbon black extracts, Nickel, 1,3 Butadiene, Ethylene Oxide, Epichlorohydrin, which are known to the State of California to cause cancer, and Bisphenol-A, Ethylene Glycol, Ethylene Oxide, 1,3 Butadiene, Epichlorohydrin, which are known to the State of California to cause birth defects or other reproductive harm. For more information go to www.P65Warnings.ca.gov.

BALDWIN TO UPC (INDIVIDUAL PARTS)

BALDWIN NUMBER	UPC NUMBER	BALDWIN NUMBER	UPC NUMBER	BALDWIN NUMBER	UPC NUMBER	BALDWIN NUMBER	UPC NUMBER	BALDWIN NUMBER	UPC NUMBER
H9114	791440029897	PT9242	791440074064	BT9358	791440077911	BT9440	791440090378	BT9533	791440094420
H9123	791440029903	PT9244	791440074088	PT9359-MPG	791440078017	PT9441-MPG	791440090668	PT9535-MPG	791440094611
PT9127	791440070646	PT9245	791440074095	BT9360	791440078024	BT9442-MPG	791440091023	PT9536-MPG	791440094765
PT9129	791440070660	PT9247	791440074118	PT9361	791440078031	PT9443	791440091054	PT9537-MPG	791440095021
PT9131	791440070684	PT9248	791440074125	BT9362-MPG	791440078109	PT9444-MPG	791440091061	BT9553	791440085497
PT9132	791440070691	PT9250	791440074149	BT9363-MPG	791440078116	PT9445-MPG	791440091153	PT9554-MPG	791440085527
PT9134	791440070714	PT9251	791440074156	BT9364	791440078390	PT9446	791440091160	PT9555	791440085534
PT9135	791440070721	PT9254	791440074187	BT9365-MPG	791440078420	PT9447	791440091177	PT9556-MPG	791440085541
PT9136	791440070738	PT9255	791440074194	BT9366-MPG	791440078437	PT9448	791440091184	PT9557	791440085572
PT9137	791440070745	PT9256-MPG	791440074200	BT9367-MPG	791440078451	PT9449	791440091191	BT9558-MPG	791440085817
PT9139	791440070769	PT9257	791440074217	BT9368-MPG	791440078505	PT9450-MPG	791440091207	PT9559-MPG	791440085824
PT9140	791440070776	PT9258	791440074224	BT9369-MPG	791440078512	PT9451-MPG	791440091214	BT9560-MPG	791440086067
PT9142	791440070790	PT9260	791440074248	BT9370-MPG	791440078574	PT9452	791440091221	BT9561	791440086197
PT9143	791440070806	PT9261-MPG	791440074255	BT9371-MPG	791440078727	PT9453-MPG	791440084490	P9600	791440094444
PT9144	791440070813	PT9264	791440074286	PT9372	791440078796	BT9454	791440091238	B9601	791440094567
PT9145	791440070820	PT9266	791440074309	PT9373-MPG	791440079106	BT9456	791440091702	P9602	791440095007
PT9147	791440070844	PT9267	791440074316	PT9374	791440078888	PT9459-MPG	791440091788	P9603	791440095014
PT9148	791440070851	PT9268	791440074323	PT9375	791440078932	PT9462	791440091825	B9604	791440095609
PT9149	791440070868	PT9272	791440074361	PT9376	791440078949	PT9463	791440091856	P9605	791440095678
PT9150	791440070875	PT9277	791440074415	BT9377	791440078956	BT9464	791440091849	B9606	791440096615
PT9152	791440070899	PT9278	791440074422	PT9378-MPG	791440079083	BT9465	791440091917	B9607	791440096622
PT9153	791440070905	PT9279	791440074439	PT9379	791440079168	BT9466-MPG	791440091962	BF9800	791440086999
PT9155	791440070929	PT9282-MPG	791440073647	PT9380-MPG	791440079182	PT9468	791440092457	PF9801	791440087002
PT9157	791440070943	PT9283-MPG	791440073654	PT9381-MPG	791440079281	PT9469	791440092662	BF9802	791440087040
PT9158	791440070950	PT9284-MPG	791440073661	BT9382	791440079298	PT9470	791440092679	PF9803	791440087088
PT9161	791440070981	PT9286-MPG	791440073685	PT9383-MPG	791440079441	BT9471	791440092808	PF9804	791440087149
PT9162	791440070998	PT9287-MPG	791440073692	PT9384-MPG	791440079458	PT9472	791440093256	BF9805	791440087170
PT9163	791440071001	PT9288-MPG	791440073708	PT9385-MPG	791440079472	S9475	791440093461	BF9807	791440087323
BT9164	791440071018	PT9289-MPG	791440073715	PT9386-MPG	791440079489	PT9476-MPG	791440093485	BF9808-D	791440087330
PT9165	791440071025	PT9290-MPG	791440073722	BT9387	791440079915	PT9477	791440093843	BF9809-D	791440087361
PT9167	791440071049	PT9291-MPG	791440073739	BT9388	791440079953	PT9478-MPG	791440093850	BF9810-D	791440087378
PT9168	791440071056	PT9293-MPG	791440073760	PT9389-MPG	791440079991	PT9479-MPG	791440093867	BF9811-SP	791440087415
PT9169	791440071063	PT9296-MPG	791440073791	PT9390-MPG	791440080027	PT9481-MPG	791440093881	BF9812	791440087507
PT9170	791440071070	PT9297-MPG	791440073807	BT9391-MPG	791440080065	PT9482-MPG	791440093898	BF9813	791440087514
PT9171	791440071087	PT9300-MPG	791440073838	PT9392-MPG	791440080119	PT9483-MPG	791440093904	PF9814	791440087521
PT9172	791440071094	PT9303-MPG	791440073869	BT9393-MPG	791440080126	PT9484-MPG	791440093911	BF9815	791440087583
PT9174	791440071117	PT9304-MPG	791440073876	PT9394-MPG	791440080270	PT9486-MPG	791440093935	BF9816	791440087606
PT9175	791440071124	PT9306-MPG	791440073890	PT9395-MPG	791440080768	PT9487-MPG	791440093942	BF9817	791440087637
PT9176	791440071131	PT9307-MPG	791440073906	PT9396	791440080829	PT9488-MPG	791440093959	BF9818	791440087644
PT9178	791440071155	PT9308-MPG	791440073913	PT9397-MPG	791440080836	PT9489-MPG	791440093966	BF9820	791440087668
PT9179	791440071162	PT9309-MPG	791440073920	BT9398-MPG	791440081482	PT9490-MPG	791440093973	BF9821	791440087682
PT9180	791440071179	PT9310-MPG	791440073937	PT9399-MPG	791440081970	PT9491-MPG	791440093980	BF9822-D	791440087705
PT9181	791440071186	PT9311-MPG	791440073944	BT9400-MPG	791440082120	PT9492-MPG	791440093997	PF9823	791440087712
PT9183	791440071209	PT9313-MPG	791440073968	PT9401	791440082137	PT9493-MPG	791440094000	PF9825	791440087743
PT9185	791440071223	PT9315 KIT	791440073982	BT9402	791440082144	PT9494-MPG	791440094017	PF9826	791440087750
PT9186	791440071230	BT9316-MPG	791440073531	PT9403-MPG	791440082199	PT9495-MPG	791440094024	BF9827-D	791440087927
PT9187	791440071247	BT9318	791440075009	PT9404-MPG	791440082243	PT9496-MPG	791440094031	BF9828-D	791440087989
PT9188	791440071254	BT9320	791440073579	PT9405	791440082298	PT9497-MPG	791440094048	PF9829 KIT	791440088153
PT9189	791440071261	BT9321	791440073586	PT9406-MPG	791440082465	PT9498-MPG	791440094055	BF9830-D	791440088191
PT9191	791440071285	BT9324	791440073616	PT9407-MPG	791440082618	PT9499-MPG	791440094062	BF9831	791440088214
PT9193	791440071308	BT9326	791440073630	BT9408	791440082632	PT9500-MPG	791440094079	BF9833-D	791440088269
PT9195	791440071322	H9327	791440075016	PT9409-MPG	791440082809	PT9501-MPG	791440094086	BF9834	791440088276
PT9196	791440071339	PT9328-MPG	791440075023	PT9410-MPG	791440083066	PT9502-MPG	791440094093	BF9835-D	791440088283
PT9197	791440071346	PT9329	791440075245	PT9411-MPG	791440083073	PT9503-MPG	791440094109	BF9836-D	791440088436
PT9199	791440071360	PT9330-MPG	791440075233	PT9413-MPG	791440083271	PT9504-MPG	791440094116	BF9837-D	791440088511
PT9200	791440071377	PT9331	791440075887	PT9414-MPG	791440083691	PT9505-MPG	791440094123	BF9839-D	791440088627
PT9203	791440071407	PT9332	791440075870	PT9415-MPG KIT	791440079212	PT9507	791440094147	BF9841	791440088733
PT9205	791440071421	PT9337-MPG	791440076112	PT9416-MPG KIT	791440079229	PT9508	791440094154	BF9842	791440088801
PT9208	791440071452	PT9338-MPG	791440076259	PT9417	791440083943	PT9509	791440094161	BF9844	791440088900
PT9209	791440071469	PT9340-MPG	791440076341	PT9418	791440083974	PT9510	791440094178	BF9846	791440089099
PT9210	791440071476	PT9341	791440076525	PT9419-MPG	791440084184	PT9511	791440094185	BF9847-D	791440089105
PT9212	791440071490	PT9342-MPG	791440076587	PT9420-MPG	791440086272	PT9513	791440094208	BF9848	791440089198
PT9214	791440071513	BT9343-MPG	791440076662	PT9421-MPG	791440086692	PT9514	791440094215	BF9850	791440089235
PT9215	791440071520	PT9344	791440076730	BT9422	791440086814	PT9515	791440094222	BF9851	791440089327
PT9217	791440071544	BT9345	791440076792	PT9423	791440086883	PT9516	791440094239	BF9852	791440089358
PT9221	791440071582	BT9346-MPG	791440076815	PT9424	791440086968	PT9517	791440094246	BF9857	791440089488
PT9222	791440071599	BT9347-MPG	791440076822	PT9425-MPG	791440087019	PT9518-MPG	791440094260	BF9858 KIT	791440089518
PT9223	791440071605	PT9348-MPG	791440076839	PT9426	791440087033	PT9519-MPG	791440094277	BF9860	791440090118
PT9224	791440071612	BT9349-MPG	791440076846	PT9427-MPG	791440087101	PT9520-MPG	791440094284	PF9861	791440090149
PT9225	791440071629	PT9350-MPG	791440076976	PT9429-MPG	791440087118	PT9523-MPG	791440094307	PF9862	791440090170
PT9227	791440071643	PT9351-MPG	791440076983	PT9430-MPG	791440087477	PT9524-MPG	791440094314	BF9863	791440090187
PT9228	791440071650	PT9352	791440077317	PT9432-MPG	791440087971	PT9525-MPG	791440094321	BF9864	791440090282
H9231	791440071681	BT9353-MPG	791440077409	BT9433	791440087972	PT9526-MPG	791440094338	PF9865	791440090286
PT9237	791440074019	PT9354-MPG	791440077485	PT9434	791440088092	PT9528	791440094345	BF9866-O	791440090385
PT9238	791440074026	PT9355-MPG	791440077577	PT9435-MPG	791440088184	PT9529	791440094352	BF9867-O	791440090446
PT9239	791440074033	BT9356	791440077652	BT9436-MPG	791440089136	PT9530	791440094369	PF9868	791440090507
PT9240	791440074040	PT9357	791440077683	BT9439	791440089716	PT9532	791440094383	BF9869	791440090644



WARNING: These products can expose you to chemicals, including Diisononyl Phthalate, Carbon black extracts, Nickel, 1,3 Butadiene, Ethylene Oxide, Epichlorohydrin, which are known to the State of California to cause cancer, and Bisphenol-A, Ethylene Glycol, Ethylene Oxide, 1,3 Butadiene, Epichlorohydrin, which are known to the State of California to cause birth defects or other reproductive harm. For more information go to www.P65Warnings.ca.gov.

BALDWIN TO UPC (INDIVIDUAL PARTS)

BALDWIN NUMBER	UPC NUMBER	BALDWIN NUMBER	UPC NUMBER	BALDWIN NUMBER	UPC NUMBER	BALDWIN NUMBER	UPC NUMBER	BALDWIN NUMBER	UPC NUMBER
PF9870	791440090682	PA10025	791440103634	PA10117	791440113480	PA10196 KIT	791440114227	PA10274	791440111752
BF9871-O	791440090798	PA10026	791440103641	PA10118	791440113503	PA10197	79144011929	PA10275	791440111721
PF9872	791440090958	PA10027	791440103658	PA10119	791440113237	PA10198 KIT	791440112681	PA10276	791440111776
PF9873	791440090996	PA10028	791440103665	PA10120	791440114548	PA10199 KIT	791440112841	PA10277	791440112049
BF9874-DM	791440091030	PA10030	791440103689	PA10121	791440114166	PA10200	791440114395	PA10278	791440111516
BF9875-DM	791440091047	PA10031	791440103696	PA10122	791440114883	PA10201	791440113022	PA10279	791440111769
BF9876	791440091078	PA10032	791440103702	PA10123	791440114579	PA10202	791440114081	PA10280	791440111790
BF9877	791440091382	PA10033	791440103924	PA10124	791440115316	PA10203 KIT	791440114722	PA10281	791440111936
BF9878	791440091559	PA10034	791440103993	PA10125	791440114975	PA10204 KIT	791440113510	PA10282	791440112315
PF9879	791440091757	RS10035	791440104235	PA10126	791440115446	PA10205 KIT	791440114326	PA10283	791440111899
BF9880	791440091764	PA10036	791440104372	SA10127	791440112124	PA10206 KIT	791440115088	PA10284	791440112179
BF9881	791440091801	PA10037	791440104501	PA10128	791440111424	PA10207	791440114364	PA10285	791440111981
BF9883	791440091863	PA10038	791440105638	PA10129	791440111554	PA10208 KIT	791440114371	PA10286	791440112278
BF9884	791440091931	PA10039	791440105645	PA10130	791440111615	PA10209 KIT	791440113404	PA10287	791440112957
BF9885	791440091948	PA10040	791440105652	PA10131	791440113046	PA10210 KIT	791440114821	PA10288	791440112094
BF9886	791440091986	PA10041	791440105669	PA10132	791440111998	PA10211 KIT	791440114852	PA10289	791440112438
BF9887	791440092020	PA10042	791440105676	PA10133	791440111639	PA10212 KIT	791440115484	PA10290	791440111660
BF9888	791440092037	PA10043	791440105683	PA10134	791440112872	PA10213	791440113985	PA10291	791440111837
PF9889	791440092051	PA10044	791440105744	PA10135	791440112506	PA10214	791440114876	PA10292	791440112001
PF9890	791440092068	PA10045	791440105751	PA10136	791440112377	PA10215 KIT	791440115217	PA10293	791440112766
BF9891-D	791440092075	PA10046	791440105768	PA10137	791440111868	PA10216 KIT	791440114111	PA10294	791440112476
BF9892-D	791440092082	PA10047	791440107298	PA10138	791440113381	PA10217	791440112209	PA10295	791440112612
BF9893	791440092099	PA10057	791440107885	PA10139	791440112933	PA10218	791440113770	PA10296	791440112445
BF9894	791440092105	PA10058	791440108356	PA10140	791440113640	PA10219	791440112407	PA10297	791440113251
BF9895 KIT	791440092303	PA10059	791440108363	PA10141	791440113282	PA10220	791440111547	PA10298	791440113497
PF9897	791440092358	PA10060	791440108455	PA10142	791440112261	PA10221	791440111530	PA10299	791440111738
BF9898-O	791440092372	PA10061	791440108547	PA10143	791440112087	PA10222	791440111851	PA10300	791440112582
PF9899	791440092389	PA10062	791440108622	PA10144	791440113244	PA10223	791440112186	PA10301	791440112650
BF9901 KIT	791440092433	PA10063	791440111325	PA10145 KIT	791440112216	PA10224	791440112148	PA10302	791440113442
BF9903-SP	791440092525	PA10064	791440108714	PA10146	791440113060	PA10225	791440112698	PA10303	791440113169
BF9904	791440092570	PA10066	791440108936	PA10147	791440113435	PA10226	791440112865	PA10304	791440112551
BF9905	791440092747	PA10067	791440108950	PA10148	791440113015	PA10227	791440112780	PA10305	791440113329
BF9906	791440092891	PA10068	791440109001	PA10149	791440112919	PA10228	791440111967	PA10306	791440113633
PF9907	791440092990	PA10069	791440109032	PA10150	791440114005	PA10229	791440112964	PA10307	791440113343
PF9908 KIT	791440093164	PA10070	791440109049	PA10152 KIT	791440112759	PA10230	791440113299	PA10308	791440113374
BF9910	791440093201	PA10071	791440109056	PA10153	791440112711	PA10231	791440112995	PA10309	791440112810
PF9911	791440093249	PA10072	791440109063	PA10154	791440113824	PA10232	791440112247	PA10310	791440112353
BF9912-O	791440093478	PA10073	791440109070	PA10155	791440114357	PA10233	791440112360	PA10311	791440112728
BF9913	791440093508	PA10075	791440109285	PA10156	791440114494	PA10234	791440113305	PA10312	791440113336
PF9914 KIT	791440093577	PA10076	791440109308	PA10157	791440115255	PA10235	791440113039	PA10313	791440113541
BF9915	791440093584	PA10077	791440109339	PA10158	791440115293	PA10236	791440113589	PA10314	791440113930
BF9916	791440093652	PA10078	791440109346	PA10159	791440112384	PA10237	791440113527	PA10315	791440113831
BF9917	791440093775	PA10080	791440110311	PA10160	791440113725	PA10238	791440113183	PA10316	791440113077
BF9918 KIT	791440093799	PA10081	791440109520	PA10161	791440113565	PA10239	791440113466	PA10317	791440113893
PF9919	791440094499	PA10082	791440109599	PA10162	791440114531	PA10240	791440113657	PA10318	791440114616
BF9920	791440094604	PA10083	791440109988	PA10163	791440114036	PA10241	791440113138	PA10319	791440114814
BF9921-O	791440094697	PA10084	791440109636	PA10164	791440112667	PA10242	791440114470	PA10320	791440112131
BF9922-O	791440094758	PA10085	791440109650	PA10165	791440114845	PA10243	791440114296	PA10321	791440114968
BF9923-O	791440094956	PA10086	791440110304	PA10166	791440113992	PA10244	791440114937	PA10323	791440114609
PF9924 KIT	791440095175	PA10087	791440110359	PA10167	791440114999	PA10245	791440114418	PA10324	791440112858
BF9925-O	791440095199	PA10088	791440109889	PA10168	791440114425	PA10246	791440113572	PA10325	791440112926
BF9927	791440095274	PA10089	791440109902	PA10169	791440115002	PA10247	791440115460	PA10326	791440114159
PF9928	791440096639	PA10090	791440109919	PA10170 KIT	791440114753	PA10248	791440112575	PA10327	791440114555
PF9929	791440096646	PA10091	791440109995	PA10171	791440112643	PA10249	791440113879	PA10328	791440115194
PA10000	791440096677	PA10093	791440110069	PA10172	791440114012	PA10250	791440114487	PA10329	791440114593
PA10001	791440096684	PA10094	791440110076	PA10173	791440115262	PA10251	791440115071	PA10330	791440115415
PA10002	791440096691	PA10095	791440110083	PA10174	791440115453	PA10253	791440115095	PA10331	791440114500
PA10003	791440096813	PA10096	791440110366	PA10175 KIT	791440115378	PA10254	791440113695	PA10332	791440115347
PA10004	791440096868	PA10097	791440110687	PA10176	791440115385	PA10255	791440114043	PA10333	791440115392
RS10005	791440096875	PA10098	791440110700	PA10177	791440115477	PA10256	791440113053	PA10334	791440115408
PA10006	791440096905	PA10099	791440110717	PA10178	791440115330	PA10257	791440114319	PA10335	791440114128
PA10007	791440096929	SA10100	791440110793	PA10179	791440113602	PA10258	791440114791	PA10336	791440115064
PA10008	791440097995	PA10101	791440110915	PA10180 KIT	791440115125	PA10259	791440114708	PA10337	791440115132
PA10009	791440098312	PA10102	791440110922	PA10181	791440112025	PA10260	791440115101	PA10338	791440115231
PA10010	791440098930	PA10103	791440110991	PA10182	791440115019	PA10261	791440115279	PA10339	791440115361
PA10011	791440098947	PA10104	791440111004	PA10183	791440114692	PA10262	791440114340	PA10340	791440115422
PA10012	791440098992	PA10106	791440111028	PA10184	791440114517	PA10263	791440114401	PA10341	791440114258
PA10014	791440100619	PA10107	791440111035	PA10185	791440115170	PA10264	791440113350	PA10342	791440115491
PA10015	791440100787	PA10108	791440111158	PA10186 KIT	791440113855	PA10265	791440114333	PA10343	791440114647
PA10016	791440100893	PA10109	791440112469	PA10188	791440114838	PA10266	791440114678	PA10344	791440114913
PA10017	791440100909	PA10110	791440112223	PA10189	791440114777	PA10267	791440111882	PA10345	791440114142
PA10018	791440101005	PA10111	791440112636	PA10190	791440114920	PA10268	791440113473	PA10346	791440112346
PA10020	791440102484	PA10112	791440112834	PA10191 KIT	791440113534	PA10269	791440112742	RS10347	791440114272
RS10021	791440102606	PA10113	791440112568	PA10192	791440112018	PA10270	791440111806	RS10348	791440115118
PA10022	791440103412	PA10114	791440114210	PA10193 KIT	791440113923	PA10271	791440114289	RS10349	791440115026
PA10023	791440103610	PA10115	791440112421	PA10194	791440113701	PA10272	791440113619	RS10350	791440115309
PA10024	791440103627	PA10116	791440112902	PA10195 KIT	791440112193	PA10273	791440113732	RS10351	791440114661



WARNING: These products can expose you to chemicals, including Diisononyl Phthalate, Carbon black extracts, Nickel, 1,3 Butadiene, Ethylene Oxide, Epichlorohydrin, which are known to the State of California to cause cancer, and Bisphenol-A, Ethylene Glycol, Ethylene Oxide, 1,3 Butadiene, Epichlorohydrin, which are known to the State of California to cause birth defects or other reproductive harm. For more information go to www.P65Warnings.ca.gov.

BALDWIN TO UPC (INDIVIDUAL PARTS)

BALDWIN NUMBER	UPC NUMBER	BALDWIN NUMBER	UPC NUMBER	BALDWIN NUMBER	UPC NUMBER	BALDWIN NUMBER	UPC NUMBER	BALDWIN NUMBER	UPC NUMBER
PA10352	791440112889	PA10431	791440116894	20021	791440086708	PT23036-MPG	791440095649	PT23115-MPG	791440096431
PA10353	791440115163	PA10433	791440117112	20022	791440086715	PT23037-MPG	791440095656	PT23116-MPG	791440096448
PA10354	791440113145	PA10435	791440117136	20023	791440086722	PT23038-MPG	791440095663	PT23117-MPG	791440096455
PA10355	791440112537	PA10436	791440117143	20024	791440086739	PT23039-MPG	791440095670	PT23118-MPG	791440096462
PA10356	791440114098	PA10438	791440117167	20025	791440100848	PT23040-MPG	791440095687	PT23119-MPG	791440096479
PA10357	791440114890	PA10439	791440117174	20026	791440110113	PT23041-MPG	791440095694	PT23120-MPG	791440096486
PA10358	791440113268	PA10440	791440117181	20027	791440110120	PT23042-MPG	791440095700	PT23122	791440097803
SA10359	791440113596	PA10441	791440117211	20028	791440110038	PT23043-MPG	791440095717	PT23123	791440097810
SA10360	791440114654	CV15000	791440084032	20029	791440110472	PT23044-MPG	791440095724	PT23124	791440097834
SA10361	791440113084	CV15001	791440089853	20030	791440110779	PT23045-MPG	791440095731	PT23125-MPG	791440097841
PA10362	791440111448	CV15002	791440090156	20031	791440113398	PT23046-MPG	791440095748	PT23126-MPG	791440097858
PA10363	791440111462	CV15003	791440093560	20033	791440114029	PT23047-MPG	791440095755	PT23127-MPG	791440097865
PA10364	791440111486	CV15004	791440096943	20035	791440113367	PT23048-MPG	791440095762	PT23128-MPG	791440097872
PA10365 KIT	791440112520	CV15005	791440104693	20037	791440112414	PT23049-MPG	791440095779	PT23129-MPG	791440097889
PA10367	791440111653	CV15006	791440105546	20041	791440114265	PT23050-MPG	791440095786	PT23131-MPG	791440097902
PA10368	791440113213	CV15007	791440109018	20042	791440112599	PT23051-MPG	791440095793	PT23132-MPG	791440097919
PA10369	791440111783	CV15008	791440109025	20043	791440111820	PT23052-MPG	791440095809	PT23133-MPG	791440097926
PA10370 KIT	791440114463	CV15010	791440109674	20044	791440113794	PT23053-MPG	791440095816	PT23135-MPG	791440097940
PA10371	791440112339	CV15011	791440110335	20045	791440112322	PT23054-MPG	791440095823	PT23136	791440097780
PA10372	791440113886	CV15015	791440116481	20046	791440114562	PT23055-MPG	791440095830	PT23137	791440097827
PA10373	791440113206	CV15016	791440116672	20048	791440111417	PT23056-MPG	791440095847	PT23138	791440098015
PA10374	791440112797	BA16000	791440104204	20050	791440114586	PT23057-MPG	791440095854	PT23139-MPG	791440098268
PA10375	791440112971	PE17000	791440105515	20051	791440114067	PT23058-MPG	791440095861	BT23140-MPG	791770098275
PA10376	791440112162	PE17001	791440106918	20052	791440112100	PT23059-MPG	791440095878	PT23142	791440098029
PA10378	791440112063	PE17002 KIT	791440116368	20053	791440113411	PT23060-MPG	791440095885	PT23143	791440098036
PA10379	791440111707	18002	791440047884	20054	791440111684	PT23061-MPG	791440095892	PT23144	791440098043
PA10380	791440111950	18004	791440047907	20055	791440114135	PT23062-MPG	791440095908	PT23145	791440098050
PA10381	791440115507	18007	791440047938	20057	791440115439	PT23063-MPG	791440095915	PT23146	791440098057
PA10382	791440113909	18009	791440047952	20058	791440112988	PT23064-MPG	791440095922	PT23147	791440098064
PA10383	791440112544	18010	791440047969	20060	791440113862	PT23065-MPG	791440095939	PT23149	791440098098
PA10384	791440114630	18013	791440047990	20061	791440113756	PT23066-MPG	791440095946	PT23150	791440098104
PA10385	791440113107	18022	791440051355	20062	791440113175	PT23067-MPG	791440095953	PT23151	791440098111
PA10386	791440113817	18024	791440051348	20063	791440112827	PT23068-MPG	791440095960	PT23152	791440098118
PA10387	791440112605	18025	791440051331	20064	791440113626	PT23070-MPG	791440095984	PT23154	791440098142
PA10388	791440115972	18027	791440113916	20065	791440113916	PT23071-MPG	791440095991	PT23155	791440098159
PA10389	791440113008	18029	791440052758	20066	791440114241	PT23072-MPG	791440096004	PT23156	791440098166
PA10390	791440112230	18032	791440055728	20067	791440112773	PT23073-MPG	791440096011	PT23158	791440098180
PA10391	791440111646	18033	791440056206	20068	791440115224	PT23074-MPG	791440096028	PT23159	791440098197
PA10392	791440112483	18034	791440056213	20069	791440114074	PT23075-MPG	791440096035	PT23160	791440098203
PA10393	791440113671	18055	791440059757	20070	791440116092	PT23076-MPG	791440096042	PT23161	791440098210
PA10394	791440114203	18056	791440059764	20071	791440116993	PT23077-MPG	791440096059	PT23162	791440098227
PA10395	791440112155	18057	791440059771	20072	791440117006	PT23078-MPG	791440096066	PT23163	791440098234
PA10396	791440115989	18104	791440029989	BW21000	791440097483	PT23079-MPG	791440096073	PT23164	791440098241
PA10397	791440113800	18139	791440030015	PT23000	791440095298	PT23080-MPG	791440096080	PT23165	791440098258
PA10398	791440115156	18155	791440030039	PT23001	791440095281	PT23081-MPG	791440096097	PT23166	791440098265
PA10399	791440113848	18171	791440030053	PT23002	791440095304	PT23082-MPG	791440096103	PT23170	791440098302
PA10400	791440115514	18198	791440030077	PT23003	791440095311	PT23083-MPG	791440096110	PT23172	791440098326
PA10401	791440115590	18236	791440030114	PT23004	791440095328	PT23084-MPG	791440096127	PT23173	791440098333
PA10402	791440115613	18245	791440030121	PT23005	791440095335	PT23085-MPG	791440096134	PT23174	791440098340
PA10403	791440115682	18264	791440060371	PT23006	791440095342	PT23086-MPG	791440096141	PT23175	791440098357
PA10404	791440115910	18265	791440060388	PT23007	791440095359	PT23087-MPG	791440096158	PT23176	791440098364
PA10405	791440115927	18267	791440060456	PT23008	791440095366	PT23088-MPG	791440096165	PT23178	791440098388
PA10406	791440115996	18268	791440039148	PT23009	791440095373	PT23089-MPG	791440096172	PT23179	791440098395
PA10407	791440116078	19739	791440030329	PT23010	791440095380	PT23090-MPG	791440096189	PT23180	791440098418
PA10408	791440116146	19828	791440030343	PT23011	791440095397	PT23091-MPG	791440096196	PT23182	791440098425
PA10409	791440116153	19922	791440030442	PT23012	791440095403	PT23092-MPG	791440096202	PT23183	791440098432
PA10410	791440116313	19996	791440064553	PT23013	791440095410	PT23093-MPG	791440096219	PT23184	791440098449
PA10411	791440116320	19999	791440064584	PT23014	791440095427	PT23094-MPG	791440096226	PT23185	791440098456
PA10412	791440116337	20000	791440064591	PT23015	791440095434	PT23095-MPG	791440096233	PT23186	791440098463
PA10413	791440116382	20002	791440064614	PT23016	791440095441	PT23096-MPG	791440096240	PT23187	791440098470
PA10414	791440116412	20003	791440065765	PT23017	791440095458	PT23097-MPG	791440096257	PT23188	791440098487
PA10415	791440116436	20004	791440065796	PT23018	791440095465	PT23098-MPG	791440096264	PT23189	791440098494
PA10416	791440116443	20005	791440067370	PT23019	791440095472	PT23100-MPG	791440096288	PT23190	791440098500
PA10417	791440116450	20006	791440077782	PT23020	791440095489	PT23101-MPG	791440096295	PT23193-MPG	791440098531
PA10418	791440116504	20007	791440077799	PT23022	791440095502	PT23102-MPG	791440096301	PT23195-MPG	791440098555
PA10419	791440116511	20008	791440077805	PT23023	791440095519	PT23103-MPG	791440096318	PT23196-MPG	791440098562
PA10420	791440116528	20010	791440077829	PT23024	791440095526	PT23104-MPG	791440096325	PT23197-MPG	791440098579
PA10421	791440116542	20011	791440077836	PT23025	791440095533	PT23105-MPG	791440096332	PT23198-MPG	791440098586
PA10422	791440116559	20012	791440077850	PT23027	791440095557	PT23106-MPG	791440096349	PT23200-MPG	791440098609
PA10423	791440116566	20013	791440078062	PT23028-MPG	791440095564	PT23107-MPG	791440096356	PT23201-MPG	791440098616
PA10424	791440116634	20014	791440080386	PT23029-MPG	791440095571	PT23108-MPG	791440096363	PT23202-MPG	791440098623
PA10425	791440116665	20015	791440081673	PT23030-MPG	791440095588	PT23109-MPG	791440096370	PT23203-MPG	791440098630
PA10426	791440116801	20016	791440081680	PT23031-MPG	791440095595	PT23110-MPG	791440096387	PT23204-MPG	791440098647
PA10427	791440116856	20017	791440081697	PT23032-MPG	791440095602	PT23111-MPG	791440096394	PT23205-MPG	791440098654
PA10428	791440116863	20018	791440081703	PT23033-MPG	791440095610	PT23112-MPG	791440096401	PT23206-MPG	791440098661
SA10429	791440116870	20019	791440081710	PT23034-MPG	791440095625	PT23113-MPG	791440096417	PT23207-MPG	791440098678
PA10430	791440116887	20020	791440081727	PT23035-MPG	791440095632	PT23114-MPG	791440096424	PT23209-MPG	791440098692



WARNING: These products can expose you to chemicals, including Diisononyl Phthalate, Carbon black extracts, Nickel, 1,3 Butadiene, Ethylene Oxide, Epichlorohydrin, which are known to the State of California to cause cancer, and Bisphenol-A, Ethylene Glycol, Ethylene Oxide, 1,3 Butadiene, Epichlorohydrin, which are known to the State of California to cause birth defects or other reproductive harm. For more information go to www.P65Warnings.ca.gov.

BALDWIN TO UPC (INDIVIDUAL PARTS)

BALDWIN NUMBER	UPC NUMBER	BALDWIN NUMBER	UPC NUMBER	BALDWIN NUMBER	UPC NUMBER	BALDWIN NUMBER	UPC NUMBER	BALDWIN NUMBER	UPC NUMBER
PT23211-MPG	791440099715	PT23294-MPG	791440100541	PT23382-MPG	791440101760	PT23460	791440102705	BT23542-MPG	791440104686
PT23212-MPG	791440099722	PT23295-MPG	791440100558	PT23383-MPG	791440101777	PT23461	791440102712	BT23543-MPG	791440104785
PT23213-MPG	791440099739	PT23297	791440100572	PT23384-MPG	791440101784	PT23462	791440102729	PT23544-MPG	791440104792
PT23214-MPG	791440099746	PT23306	791440100947	PT23385-MPG	791440101791	PT23463	791440102736	PT23545-MPG	791440104808
PT23215-MPG	791440099753	PT23308	791440101029	PT23386-MPG	791440101807	PT23464	791440102743	PT23546-MPG	791440104815
PT23216-MPG	791440099760	PT23309	791440101036	PT23387-MPG	791440101814	PT23465	791440102750	BT23555-MPG	791440105225
PT23217-MPG	791440099777	PT23310	791440101043	PT23388-MPG	791440101821	PT23467	791440102774	PT23556-MPG	791440105256
PT23218-MPG	791440099784	PT23311	791440101050	PT23389-MPG	791440101838	PT23468	791440102781	PT23560	791440105621
PT23219-MPG	791440099791	PT23312	791440101067	PT23390-MPG	791440101845	PT23469	791440102798	PT23561-MPG	791440106796
PT23220-MPG	791440099807	PT23313	791440101074	PT23391-MPG	791440101852	PT23470	791440102804	PT23565-MPG	791440106925
PT23221-MPG	791440099814	PT23314	791440101081	PT23392-MPG	791440101869	PT23471	791440102811	PT23566-MPG	791440106932
PT23222-MPG	791440099838	PT23315	791440101098	PT23393-MPG	791440101876	PT23472	791440102828	PT23567-MPG	791440106949
PT23224-MPG	791440099845	PT23316	791440101104	PT23394-MPG	791440101883	PT23473	791440102835	PT23568-MPG	791440106956
PT23226-MPG	791440099869	PT23317	791440101111	PT23395-MPG	791440101890	PT23474	791440102842	PT23569-MPG	791440106963
PT23227-MPG	791440099876	PT23318	791440101128	PT23396-MPG	791440101906	PT23475	791440102859	PT23570-MPG	791440106970
PT23228-MPG	791440099883	PT23319	791440101135	PT23397-MPG	791440101913	PT23476	791440102866	PT23571-MPG	791440106987
PT23229-MPG	791440099890	PT23320	791440101142	PT23398-MPG	791440101920	PT23477	791440102873	PT23572-MPG	791440106994
PT23230-MPG	791440099906	PT23321	791440101159	PT23399-MPG	791440101937	PT23478	791440102880	PT23573-MPG	791440107007
PT23231-MPG	791440099913	PT23322	791440101166	PT23400-MPG	791440101944	PT23479	791440102897	PT23574-MPG	791440107014
PT23232-MPG	791440099920	PT23323	791440101173	PT23401-MPG	791440101951	PT23480	791440102903	PT23575-MPG	791440107021
PT23233-MPG	791440099937	PT23324	791440101180	PT23402-MPG	791440101968	PT23481	791440102910	PT23576-MPG	791440107038
PT23234-MPG	791440099944	PT23325	791440101197	PT23403-MPG	791440101975	PT23482	791440102927	PT23577-MPG	791440107045
PT23235-MPG	791440099951	PT23326	791440101203	PT23404-MPG	791440101982	PT23483-MPG	791440102934	PT23578-MPG	791440107052
PT23236-MPG	791440099968	PT23327	791440101210	PT23405-MPG	791440101999	PT23484-MPG	791440102941	PT23579-MPG	791440107069
PT23237-MPG	791440099975	PT23328	791440101227	PT23406-MPG	791440102002	PT23485-MPG	791440102958	PT23580-MPG	791440107076
PT23238-MPG	791440099982	PT23329	791440101234	PT23407-MPG	791440102019	PT23486-MPG	791440102965	PT23581-MPG	791440107083
PT23239-MPG	791440099999	PT23330	791440101241	PT23408-MPG	791440102026	PT23487-MPG	791440102972	PT23582-MPG	791440107090
PT23240-MPG	791440100008	PT23331	791440101258	PT23409-MPG	791440102033	PT23488-MPG	791440102989	PT23583-MPG	791440107107
PT23241-MPG	791440100015	PT23332	791440101265	PT23410-MPG	791440102040	PT23489-MPG	791440102996	PT23585	791440107120
PT23242-MPG	791440100022	PT23333	791440101272	PT23411-MPG	791440102057	PT23490-MPG	791440103009	PT23586	791440107137
PT23243-MPG	791440100039	PT23334	791440101289	PT23412-MPG	791440102064	PT23491-MPG	791440103016	PT23587	791440107144
PT23244-MPG	791440100046	PT23335	791440101296	PT23413-MPG	791440102071	PT23492-MPG	791440103023	PT23588	791440107151
PT23245-MPG	791440100053	PT23336	791440101302	PT23414-MPG	791440102095	PT23493-MPG	791440103030	PT23589	791440107168
PT23246-MPG	791440100060	PT23337	791440101319	PT23415-MPG	791440102088	PT23494-MPG	791440103047	PT23590	791440107175
PT23247-MPG	791440100077	PT23338-MPG	791440101326	PT23416-MPG	791440102101	PT23495-MPG	791440103054	PT23591-MPG	791440107199
PT23248-MPG	791440100084	PT23339-MPG	791440101333	PT23417-MPG	791440102118	PT23496-MPG	791440103061	PT23592	791440107304
PT23249-MPG	791440100091	PT23340-MPG	791440101340	PT23418-MPG	791440102125	PT23497-MPG	791440103078	PT23595-MPG	791440107717
PT23250-MPG	791440100107	PT23341-MPG	791440101357	PT23419-MPG	791440102132	PT23498-MPG	791440103085	PT23597-MPG	791440107779
PT23251-MPG	791440100114	PT23342-MPG	791440101364	PT23420-MPG	791440102149	PT23499-MPG	791440103092	PT23598-MPG	791440107793
PT23252-MPG	791440100121	PT23343-MPG	791440101371	PT23421-MPG	791440102156	PT23500-MPG	791440103108	PT23600	791440107830
PT23253-MPG	791440100138	PT23344-MPG	791440101388	PT23422-MPG	791440102163	PT23501-MPG	791440103115	BT23603-MPG	791440107762
PT23254-MPG	791440100145	PT23346-MPG	791440101401	PT23423-MPG	791440102170	PT23502-MPG	791440103122	BT23604	791440107786
PT23255-MPG	791440100152	PT23346-MPG	791440101401	PT23424-MPG	791440102187	PT23503-MPG	791440103139	PT23605-MPG	791440107816
PT23257-MPG	791440100176	PT23347-MPG	791440101418	PT23425-MPG	791440102194	PT23504-MPG	791440103146	BT23607-MPG	791440107878
PT23258-MPG	791440100183	PT23348-MPG	791440101425	PT23426-MPG	791440102200	PT23505-MPG	791440103153	BT23609-MPG	791440108325
PT23259-MPG	791440100190	PT23349-MPG	791440101432	PT23427-MPG	791440102217	PT23506-MPG	791440103160	BT23611	791440108509
PT23260-MPG	791440100206	PT23350-MPG	791440101449	PT23428-MPG	791440102224	PT23507-MPG	791440103177	PT23613-MPG	791440108783
PT23261-MPG	791440100213	PT23351-MPG	791440101456	PT23429-MPG	791440102231	PT23508-MPG	791440103184	PT23616-MPG	791440109179
PT23262-MPG	791440100220	PT23352-MPG	791440101463	PT23430-MPG	791440102248	PT23509-MPG	791440103191	BT23617	791440109575
PT23263-MPG	791440100237	PT23353-MPG	791440101470	PT23431-MPG	791440102255	PT23510-MPG	791440103207	BT23619-MPG	791440110670
PT23264-MPG	791440100244	PT23354-MPG	791440101487	PT23432-MPG	791440102262	PT23511-MPG	791440103214	PT23624	791440110618
PT23265-MPG	791440100251	PT23355-MPG	791440101494	PT23433-MPG	791440102279	PT23512-MPG	791440103221	PT23625	791440110625
PT23266-MPG	791440100268	PT23356-MPG	791440101500	PT23434-MPG	791440102286	PT23513-MPG	791440103238	BT23628	791440111240
PT23267-MPG	791440100275	PT23357-MPG	791440101517	PT23435-MPG	791440102293	PT23514-MPG	791440103245	PT23629	791440111262
PT23269-MPG	791440100299	PT23358-MPG	791440101524	PT23436-MPG	791440102309	PT23515-MPG	791440103252	BT23630	791440111624
PT23270-MPG	791440100305	PT23359-MPG	791440101531	PT23437-MPG	791440102316	PT23516-MPG	791440103269	BT23631	791440111465
PT23271-MPG	791440100312	PT23360-MPG	791440101548	PT23438-MPG	791440102323	PT23517-MPG	791440103276	PT23633	791440111489
PT23272-MPG	791440100329	PT23361-MPG	791440101555	PT23439-MPG	791440102330	PT23518-MPG	791440103283	PT23637-MPG	791440115675
PT23273-MPG	791440100336	PT23362-MPG	791440101562	PT23440-MPG	791440102347	PT23519-MPG	791440103290	PA30000	791440096653
PT23274-MPG	791440100343	PT23363-MPG	791440101579	PT23441-MPG	791440102354	PT23520-MPG	791440103306	PA30001	791440096660
PT23275-MPG	791440100350	PT23364-MPG	791440101586	PT23442-MPG	791440102361	PT23521-MPG	791440103313	PA30002	791440096752
PT23276-MPG	791440100367	PT23365-MPG	791440101593	PT23443-MPG	791440102378	PT23522-MPG	791440103320	PA30003	791440096769
PT23277-MPG	791440100374	PT23366-MPG	791440101609	PT23444-MPG	791440102385	PT23523-MPG	791440103337	PA30004	791440096776
PT23278-MPG	791440100381	PT23367-MPG	791440101616	PT23445-MPG	791440102392	PT23524-MPG	791440103344	PA30005	791440096783
PT23279-MPG	791440100398	PT23369-MPG	791440101630	PT23446-MPG	791440102408	BT23525-MPG	791440103429	PA30006	791440096790
PT23280-MPG	791440100404	PT23370-MPG	791440101647	PT23447-MPG	791440102415	PT23526	791440103474	PA30007	791440096806
PT23281-MPG	791440100411	PT23371-MPG	791440101654	PT23448-MPG	791440101422	PT23527	791440103535	RS30008	791440096820
PT23282-MPG	791440100428	PT23372-MPG	791440101661	PT23449-MPG	791440102439	PT23528-MPG	791440103757	RS30009	791440096837
PT23283-MPG	791440100435	PT23373-MPG	791440101678	PT23450-MPG	791440102446	PT23530	791440104242	PA30010	791440096882
PT23284-MPG	791440100442	PT23374-MPG	791440101685	PT23451	791440102613	PT23531-MPG	791440104020	PA30011	791440096950
PT23285-MPG	791440100459	PT23375-MPG	791440101692	PT23453	791440102637	PT23532-MPG	791440104211	PA30012	791440096967
PT23286-MPG	791440100466	PT23376-MPG	791440101708	PT23454	791440102644	PT23533	791440104259	PA30013	791440096974
PT23287-MPG	791440100473	PT23377-MPG	791440101715	PT23455	791440102651	PT23535	791440104327	PA30014	791440096981
PT23289-MPG	791440100497	PT23378-MPG	791440101722	PT23456	791440102668	PT23536	791440104334	PA30015	791440096998
PT23290-MPG	791440100503	PT23379-MPG	791440101739	PT23457	791440102675	BT23537	791440104532	PA30016	791440097001
PT23291-MPG	791440100510	PT23380-MPG	791440101746	PT23458	791440102682	BT23539	791440104570	PA30017	791440097018
PT23292-MPG	791440100527	PT23381-MPG	791440101753	PT23459	791440102699	BT23540	791440104587	PA30018	791440097025



WARNING: These products can expose you to chemicals, including Diisononyl Phthalate, Carbon black extracts, Nickel, 1,3 Butadiene, Ethylene Oxide, Epichlorohydrin, which are known to the State of California to cause cancer, and Bisphenol-A, Ethylene Glycol, Ethylene Oxide, 1,3 Butadiene, Epichlorohydrin, which are known to the State of California to cause birth defects or other reproductive harm. For more information go to www.P65Warnings.ca.gov.

BALDWIN TO UPC (INDIVIDUAL PARTS)

BALDWIN NUMBER	UPC NUMBER	BALDWIN NUMBER	UPC NUMBER	BALDWIN NUMBER	UPC NUMBER	BALDWIN NUMBER	UPC NUMBER	BALDWIN NUMBER	UPC NUMBER
PA30019	791440097032	CA30103	791440103498	RS30182	791440105164	PA30299	791440111141	BD40027	791440104556
PA30020	791440097049	CA30104	791440103528	PA30183	791440105171	PA30301	791440113664	BT40028	791440105027
PA30021	791440097056	CA30105	791440103511	PA30185	791440105478	PA30302	791440114234	BT40029	791440105218
PA30022	791440097063	RS30106	791440102545	RS30187XP	791440105492	PA30303	791440114951	P40030	791440105034
PA30023	791440097070	PA30107	791440102552	PA30188	791440105539	PA30304	791440111363	P40031-MPG	791440105072
PA30024	791440097087	PA30108	791440102576	PA30189	791440105560	RS30305	791440111370	BT40032	791440105287
PA30025	791440097094	PA30109	791440102569	PA30190	791440105577	RS30306	791440111387	P40033	791440105386
PA30026	791440097100	PA30110	791440102583	RS30191	791440105584	RS30307	791440115521	BT40034	791440105461
PA30027	791440097117	RS30112	791440102590	RS30192	791440105591	RS30308	791440115538	P40035	791440105690
PA30028	791440097124	PA30113	791440103382	PA30193-FN	791440105805	PA30309	791440115583	B40036	791440105706
PA30029	791440097131	PA30114	791440103399	PA30194	791440105812	PA30310	791440115705	P40037	791440105775
PA30030	791440097148	PA30115	791440103405	PA30200	791440107229	RS30311	791440115743	BT40038	791440105782
PA30031	791440097155	RS30116	791440103436	CA30201	791440107236	RS30313	791440115767	P40042	791440107205
PA30032	791440097179	PA30117	791440103467	CA30202	791440107243	PA30314	791440115774	B40050	791440107458
PA30033	791440097186	PA30118	791440103542	PA30204	791440108608	PA30315	791440115781	B40051	791440107465
PA30034	791440097193	PA30119	791440103559	PA30206	791440108370	PA30316	791440115798	P40052	791440107687
PA30035	791440097209	RS30120	791440103573	PA30207	791440108387	PA30317	791440115804	B40053	791440107731
PA30036	791440097216	RS30121	791440103580	PA30208	791440108394	PA30318	791440115811	B40054	791440107748
PA30037	791440097223	PA30122	791440103801	RS30209	791440107908	PA30319	791440115828	B40056	791440107847
PA30038	791440097230	PA30123	791440103818	PA30211	791440107922	PA30320	791440115835	PA40058	791440108226
PA30039	791440097247	PA30124	791440103825	RS30212	791440107946	PA30321	791440115842	P40061	791440108578
PA30040	791440097254	PA30125	791440103832	RS30213	791440107953	PA30322	791440115859	P40062	791440108615
PA30041	791440097261	PA30126	791440103948	RS30216	791440107984	PA30323	791440115866	B40063	791440110496
PA30042	791440097278	PA30127	791440103955	RS30217	791440107991	PA30324	791440115897	BT40065	791440108882
PA30043	791440097285	RS30128	791440103979	RS30220	791440108035	PA30325	791440115903	BT40066-MPG	791440109377
PA30044	791440097292	RS30129	791440103986	RS30221	791440108042	RS30327	791440116016	BT40067-MPG	791440109384
PA30045	791440097308	RS30130	791440104228	RS30222XP	791440108059	RS30328	791440116023	P40069	791440109698
PA30048	791440097339	CA30131	791440107267	RS30223	791440108066	PA30329	791440116054	B40070	791440109742
PA30049	791440097346	CA30132	791440107274	RS30224	791440108073	PA30330	791440116085	S40071	791440109773
PA30050	791440097353	RS30133	791440104105	RS30225	791440108080	PA30331	791440116375	B40073	791440110571
PA30051	791440097360	RS30134	791440104112	RS30226	791440108097	PA30332	791440116399	PA40074	791440110946
PA30052	791440097377	RS30135	791440104181	RS30227	791440108103	PA30333	791440116788	PA40076	791440111059
PA30053	791440097384	RS30136	791440104198	PA30228	791440108196	PA31000	791440105317	OB40078	791440112940
PA30054	791440097391	PA30137	791440104129	PA30229	791440108202	PA31001	791440105348	OB40079	791440112056
PA30055	791440097407	PA30138	791440104136	RS30232	791440108288	PA31002	791440105324	OB40080	791440113961
PA30056	791440097414	PA30139	791440104143	PA30233-FN	791440108301	PA31003	791440105355	P40081	791440113220
RS30057	791440097421	PA30140	791440104150	RS30234	791440108332	PA31004	791440105393	P40083	791440111844
RS30058	791440097438	PA30141	791440104167	PA30235	791440107939	PA31005	791440105423	PA40085	791440115187
RS30059-FN	791440097445	RS30142	791440104976	RS30236	791440108004	PA31006	791440105409	PA40086	791440113190
RS30060-FN	791440097452	RS30142 KIT	791440104983	RS30237	791440108561	PA31007	791440105430	PA40089	791440112629
RS30061	791440097469	RS30143	791440104990	RS30238	791440108400	PA31008	791440105881	PA40090	791440112803
RS30062	791440097476	RS30143 KIT	791440105003	RS30239	791440108431	PA31009	791440105898	PA40091	791440114104
PA30063	791440097162	PA30144	791440104174	RS30242	791440108448	PA31010	791440105331	PA40093	791440113459
PA30064	791440098008	PA30145	791440104426	PA30243	791440108660	PA31011	791440105362	PA40094	791440111523
RS30065	791440098039	PA30146	791440104433	PA30244	791440108653	PA31012	791440105416	PA40095	791440111813
RS30065 KIT	791440098046	RS30147	791440104419	PA30249	791440111332	PA31013	791440105867	PA40096	791440114739
PA30066	791440098114	PA30148	791440104273	PA30251	791440108868	PA31014	791440105874	PA40098	791440114432
PA30067	791440098121	PA30149	791440104358	PA30252	791440108912	PA31015	791440108974	PA40099	791440112032
PA30068	791440098138	PA30150	791440104365	PA30253	791440108981	PA32000	791440106833	PA40100	791440111493
PA30069	791440098145	PA30151	791440104389	PA30255	791440110106	PA32001	791440106819	PA40101	791440114388
PA30070	791440098152	PA30152	791440105720	RS30257	791440109261	PA32002	791440106864	PA40102	791440111943
CA30071	791440098169	PA30153	791440104440	PA30258	791440109421	PA32003	791440106840	PA40103	791440111561
PA30072	791440098176	PA30154	791440104457	PA30260	791440109544	PA32004	791440106826	PA40104	791440111431
PA30073	791440098183	PA30155	791440104464	PA30261	791440109551	B40000	791440096721	PA40105	791440111400
PA30074	791440098190	PA30156	791440104471	PA30262	791440109568	P40001	791440096738	PA40106	791440112070
PA30075	791440098282	PA30157	791440104488	PA30263	791440110373	P40002	791440097957	PA40107	791440111585
PA30076	791440098305	PA30158	791440104594	PA30264	791440110694	P40003	791440096912	PA40108	791440112117
RS30077	791440098954	RS30159	791440104600	PA30268	791440109926	C40004	791440097971	PA40109	791440111974
RS30078	791440098961	RS30160	791440104617	PA30269	791440109971	C40005	791440097989	PA40110	791440112292
CA30079	791440099005	RS30161	791440104624	PA30270	791440109964	B40006	791440097964	PA40111	791440111578
PA30080	791440100596	RS30162	791440104631	PA30271	791440110137	BC40007	791440098022	PA40112	791440111677
PA30081	791440100602	PA30163	791440104679	PA30272	791440110458	P40008	791440098074	PA40113	791440111479
PA30086	791440100770	PA30164	791440104761	RS30273	791440109865	BC40009	791440098084	PA40114	791440111592
RS30087	791440103764	PA30165	791440105270	RS30274	791440109872	PA40010	791440098091	PA40115	791440112452
RS30088	791440103771	PA30166	791440105263	PA30275	791440109933	P40011	791440098237	PA40116	791440112254
RS30090-FN	791440100831	RS30168	791440104877	PA30276	791440109940	PA40012	791440098244	PA40117	791440114623
RS30091	791440100855	RS30169	791440104884	PA30277	791440110021	B40013	791440098251	PA40118	791440114173
RS30092	791440100862	PA30170	791440104822	PA30279	791440110151	PA40014	791440098269	PA40119	791440111509
PA30093	791440100886	PA30171	791440104846	PA30281	791440110465	BT40015	791440100763	B40120	791440112704
PA30094	791440100916	PA30172	791440104907	RS30282	791440110540	P40017	791440104044	B40121	791440115354
PA30095	791440100930	PA30173	791440104914	PA30284	791440110564	PA40019	791440102491	B40124	791440111714
PA30096	791440100954	PA30174	791440105041	RS30285	791440110755	P40020	791440103450	B40125	791440114715
PA30098	791440101012	RS30175	791440105058	PA30287	791440110786	P40021	791440103603	B40126	791440112285
RS30099	791440102507	PA30177	791440105089	RS30290	791440110960	B40022-MPG	791440103566	B40127	791440113176
PA30100	791440102514	PA30179	791440105126	RS30291	791440110977	PA40023	791440103719	B40128	791440113091
PA30101	791440102521	RS30180	791440105140	PA30292	791440111073	P40024	791440103726	B40129	791440112674
CA30102	791440103504	RS30181	791440105157	PA30293	791440111080	PA40025	791440103733	PA40130	791440113787



WARNING: These products can expose you to chemicals, including Diisononyl Phthalate, Carbon black extracts, Nickel, 1,3 Butadiene, Ethylene Oxide, Epichlorohydrin, which are known to the State of California to cause cancer, and Bisphenol-A, Ethylene Glycol, Ethylene Oxide, 1,3 Butadiene, Epichlorohydrin, which are known to the State of California to cause birth defects or other reproductive harm. For more information go to www.P65Warnings.ca.gov.

BALDWIN TO UPC (INDIVIDUAL PARTS)

BALDWIN NUMBER	UPC NUMBER	BALDWIN NUMBER	UPC NUMBER	BALDWIN NUMBER	UPC NUMBER	BALDWIN NUMBER	UPC NUMBER	BALDWIN NUMBER	UPC NUMBER
P40131	791440114784	PF46076	791440105614	PF46186	791440115323	OAS98019	791440098534	G120-A	791440030756
P40132	791440114685	PF46077	791440105713	PF46187	791440114050	OAS98020	791440098541	G123	791440030787
B40133	791440115576	BF46078-D	791440105799	PF46188	791440115248	OAS98021	791440098558	G127	791440030817
P40134	791440115606	PF46079	791440105829	PF46189	791440113275	OAS98022	791440098565	G132	791440030855
B40136	791440115699	PF46080	791440105836	BF46192	791440114760	OAS98023	791440098572	G133	791440030862
B40137	791440115712	PF46081	791440105843	BF46193	791440113312	OAS98024	791440098589	G140-A	791440030923
B40138	791440115729	PF46082	791440105850	BF46194	791440111608	OAS98025	791440098596	G141-AF	791440034396
BD40139	791440115965	BF46083-O	791440106758	BF46195	791440112896	OAS98026	791440098602	G143	791440030954
B40140	791440116184	BF46084	791440106871	BF46196	791440114982	OAS98027	791440098619	G144	791440030961
B40142	791440116351	BF46085	791440107182	BF46197	791440115149	OAS98028	791440098626	G145-AF	791440034419
P40143	791440116429	BF46087	791440107281	BF46198	791440114197	OAS98029	791440098633	G147-A	791440030978
B40145	791440116689	PF46088	791440107311	BF46199	791440115033	OAS98031	791440098657	G148	791440030985
B40150	791440116924	PF46091	791440107359	BF46200	791440114456	OAS98032	791440098664	G153	791440031005
P40156	791440117310	PF46092	791440108493	BF46201	791440114524	OAS98033	791440098671	G154	791440031012
BF45000	791440098299	PF46094	791440107397	BF46202	791440115040	OAS98034	791440098688	G155	791440031029
BF46000	791440096707	BF46098-O	791440107366	BF46203	791440113688	OAS98035	791440098695	G157	791440031036
BF46001	791440096714	BF46099-O	791440107380	BF46204	791440114906	OAS98036	791440098701	G161	791440031074
BF46002	791440096745	BF46100-O	791440107373	BF46205	791440113152	OAS98037	791440098718	G162	791440031081
PF46003	791440096844	BF46101-O	791440107403	BF46206	791440113978	OAS98038	791440098725	G164-A	791440031098
PF46004	791440096851	PF46103	791440107700	BF46207	791440112735	OAS98039	791440098732	G165	791440031104
BF46005	791440096899	BF46104	791440108110	BF46208	791440113718	OAS98040	791440098749	G168-B	791440031128
BF46006	791440097490	BF46105-O	791440108134	BF46209	791440112391	OAS98042	791440098763	G169	791440031135
BF46007	791440097506	PF46106	791440108141	BF46210	791440113749	OAS98043	791440098770	G171	791440031159
BF46008	791440097513	PF46108	791440108165	BF46211	791440113947	OAS98044	791440098787	G172-A	791440031173
PF46009	791440097520	BF46109-O	791440108189	BF46212	791440113558	OAS98045	791440098794	G183	791440032265
PF46010 KIT	791440097537	BF46111	791440108257	BF46213	791440111912	OAS98046	791440098800	G184-A	791440031227
BF46012	791440097551	PF46112	791440104495	BF46214	791440115057	OAS98049	791440098831	G193	791440031265
BF46013	791440097568	BF46113-D	791440108318	BF46215	791440112513	OAS98050	791440098848	G196-B	791440031289
BF46014	791440097575	BF46116 KIT	791440108585	BF46216	791440113114	OAS98052	791440098862	G202	791440031319
BF46015	791440097582	BF46117	791440108462	BF46217	791440111875	OAS98053	791440098879	G203	791440031326
BF46016-O	791440097636	PF46118	791440108479	BF46218	791440111745	OAS98054	791440098886	G204-A	791440031333
BF46017-O	791440097643	PF46119	791440108486	BF46219	791440114180	OAS98056	791440098909	G206	791440031357
BF46018-O	791440097650	BF46122	791440109605	BF46220	791440114807	OAS98057	791440098916	G207-AF	791440034440
BF46019-O	791440097667	BF46123-O	791440108691	BF46221	791440113954	OAS98058	791440098923	G208-A	791440031364
BF46020-O	791440097674	BF46125	791440108721	BF46222	791440115286	OAS98060	791440103740	G210	791440031388
BF46021-O	791440097681	PF46126	791440108745	BF46223	791440114449	OAS98061	791440105737	G211	791440031395
BF46022-O	791440097698	BF46127	791440108820	BF46224	791440113121	OAS99001	791440072169	G214	791440031401
BF46023-O	791440097704	BF46128-D	791440108967	BF46225	791440113428	OAS99002	791440072176	G219	791440031425
BF46024-O	791440097711	BF46129	791440108998	BF46227	791440115569	OAS99003	791440072183	G220	791440031432
BF46025-O	791440097728	PF46130	791440109155	BF46228	791440115736	OAS99004	791440072190	G222-B	791440031449
BF46026-O	791440097735	BF46131	791440109193	BF46229	791440115873	OAS99005	791440072206	G225-AF	791440059146
BF46027-O	791440097742	BF46134-O	791440109223	BF46230	791440115880	OAS99006	791440072213	G229	791440031487
BF46028-O	791440097759	PF46135	791440109292	BF46233	791440116047	OAS99008	791440072237	G232	791440031507
BF46029-O	791440097766	PF46137	791440109391	BF46234	791440116061	OAS99010	791440072251	G233-A	791440031517
BF46030-O	791440097773	PF46137 KIT	791440110229	PF46235	791440116108	OAS99014	791440072299	G233-B	791440031524
BF46031	791440098053	PF46138	791440109414	PF46236	791440116115	OAS99015	791440072305	G236-A	791440031555
BF46032	791440098107	PF46140	791440110441	PF46237	791440116122	OAS99017	791440072329	G238	791440031579
PF46033	791440098206	BF46141	791440109582	PF46238	791440116139	OAS99018	791440072336	G239	791440031586
BF46034	791440098978	PF46142	791440109612	PF46241	791440116498	OAS99020	791440072350	G240	791440031593
BF46036 KIT	791440100879	BF46143	791440109629	BF46242	791440116535	OAS99023	791440072381	G241	791440031609
BF46037	791440100923	PF46145	791440109728	BF46244	791440116641	OAS99024	791440072398	G243-A	791440031616
BF46038-D	791440100985	BF46147-O	791440109780	BF46248	791440116696	OAS99025	791440072404	G247	791440031630
BF46039-D	791440100992	BF46149-SP	791440109841	PF46250	791440116849	OAS99028	791440072435	G251	791440031661
BF46040-D	791440102460	BF46150-O	791440109896	BF46251-SP	791440116931	OAS99029	791440072442	G252	791440031678
BF46041-D	791440103351	PF46151	791440109957	BF46252-SP	791440116948	OAS99034	791440074774	G253-A	791440031685
BF46042-D	791440103368	PF46152	791440116405	BF46256	791440116955	OAS99035	791440074781	G255	791440031692
BF46043-D	791440103375	BF46156	791440110168	PF46258	791440117068	OAS99038	791440074811	G257	791440031715
BF46044-D	791440103443	BF46157	791440110175	PF46259	791440117198	OAS99047	791440107663	G260	791440031722
BF46045-D	791440103849	BF46158	791440110182	BD50000	791440105096	OAS99048	791440107670	G261	791440031739
PF46046	791440103962	BF46159	791440110199	BF63000	791440104839	G15-AF	791440033764	G263	791440031753
BF46048	791440104037	BF46161	791440110212	OAS98000	791440098963	G21-AF	791440033801	G264-A	791440031760
PF46049	791440104549	BF46162-O	791440110403	OAS98001	791440098935	ES24-B	791440030558	G265	791440031777
BF46050	791440104303	BF46163-O	791440110427	OAS98002	791440098367	ES24-D	791440054271	G268	791440031791
BF46051	791440104341	BF46164-O	791440110434	OAS98003	791440098374	G25-AF	791440033818	G269	791440031807
BF46052	791440104396	BF46169-O	791440110656	OAS98005	791440098398	G31-AF	791440034129	G270	791440031814
PF46056	791440104709	BF46170	791440110663	OAS98006	791440098404	G34-AF	791440034150	G273	791440031821
PF46057	791440104719	PF46171	791440110748	OAS98008	791440098428	G37-AF	791440034167	G274	791440031838
PF46059	791440104730	PF46172 KIT	791440110885	OAS98009	791440098435	G39-AF	791440034179	G275	791440031845
BF46061	791440104754	BF46173-O	791440110892	OAS98010	791440098442	G102-A	791440030619	G278	791440031852
BF46062	791440104778	BF46175	791440110984	OAS98011	791440098459	G103	791440030626	G280	791440031876
BF46064-D	791440110878	BF46176	791440111165	OAS98012	791440098466	G103-N	791440054288	G281	791440031883
BF46065-SPS	791440105607	BF46179	791440111196	OAS98013	791440098473	G104	791440030633	G283	791440031906
BF46068	791440105188	BF46181-O	791440111257	OAS98014	791440098480	G105	791440030640	G285-AF	791440034471
BF46069	791440105195	BF46182-O	791440111356	OAS98015	791440098497	G106	791440030657	G286-C	791440047167
BF46071	791440105232	BF46183	791440111905	OAS98016	791440098503	G107	791440030664	G288	791440031913
BF46072	791440105249	BF46184	791440112308	OAS98017	791440098510	G115-A	791440030718	G289	791440031920
BF46073	791440105294	BF46185	791440111394	OAS98018	791440098527	G115-MSB	791440030725	G291	791440031944



WARNING: These products can expose you to chemicals, including Diisononyl Phthalate, Carbon black extracts, Nickel, 1,3 Butadiene, Ethylene Oxide, Epichlorohydrin, which are known to the State of California to cause cancer, and Bisphenol-A, Ethylene Glycol, Ethylene Oxide, 1,3 Butadiene, Epichlorohydrin, which are known to the State of California to cause birth defects or other reproductive harm. For more information go to www.P65Warnings.ca.gov.

BALDWIN TO UPC (INDIVIDUAL PARTS)

BALDWIN NUMBER	UPC NUMBER	BALDWIN NUMBER	UPC NUMBER	BALDWIN NUMBER	UPC NUMBER	BALDWIN NUMBER	UPC NUMBER	BALDWIN NUMBER	UPC NUMBER
G293-B	791440059092	G402	791440032705	ES1031	791440059122	66-30	791440065857	200-30U	791440036239
G296	791440031951	G403	791440032712	ES1032	791440033245	66-W	791440034990	200-31	791440036246
G298-AF	791440034501	G406	791440032743	ES1034	791440033252	75	791440035003	200-DEPR KIT	791440080799
G299	791440031968	G409	791440032774	ES1036	791440033276	75-21	791440035027	200-GK	791440036321
G302	791440031989	G410	791440032781	ES1039	791440076211	75-W30	791440065819	200-M	791440036369
G303	791440031992	G411	791440032798	ES1041	791440033283	85-EK	791440035034	200-MFV	791440036390
G304	791440032002	G412	791440032804	ES1049	791440033306	85-P	791440035041	200-MMV	791440036406
G305	791440032019	G416	791440032835	ES1066	791440033337	85-V	791440035058	200-W30	791440036451
G306	791440032026	G417	791440032842	ES1067	791440033344	100	791440035126	201	791440036468
G307	791440032033	G422-AF	791440034587	ES1068	791440033351	100-12	791440035157	201-30	791440036475
G309-B	791440032040	G431	791440032880	ES1071	791440033368	100-21	791440035232	201-W	791440036499
G310	791440032057	G432	791440032897	ES1074	791440033375	100-21AL	791440060418	285-DS	791440036505
G314	791440032071	G433	791440032903	G1086-AF	791440033825	100-21BP	791440035249	286-SK	791440036512
G315	791440032088	G434	791440032910	ES1092	791440033382	100-21M	791440035270	300	791440036529
G323	791440032149	G435	791440032927	ES1303-A	791440033399	100-28	791440035324	300-DHRAS5	791440036666
G332	791440032187	G436	791440032934	ES1303-B	791440033405	100-29	791440035331	300-H	791440036741
G333	791440032194	G438	791440032958	ES1369-A	791440033412	100-30	791440035348	300-W30	791440065840
G336	791440032217	G439	791440032965	ES1376	791440051256	100-BP	791440035416	301	791440036956
G340	791440032248	G441	791440032972	ES1377	791440045651	100-DEPR KIT	791440080805	301-30	791440036963
G342	791440032255	G442	791440032989	G1972	791440076235	100-GK	791440035454	301-CS	791440036970
G343-A	791440032262	G443	791440032996	G1973	791440033177	100-M	791440035485	301-MPG	791440034624
G344	791440032279	G444	791440033009	ES3012	791440033474	100-MFV	791440035508	301-W	791440036987
G347	791440032293	G445	791440033016	ES3028	791440033481	100-MMV	791440035515	500	791440036994
G348-AF	791440039667	G446	791440033023	ES3029	791440033498	100-MNTG KIT	791440080812	500-12	791440037007
G354	791440032316	G447	791440033030	ES3063	791440033528	100-W	791440035546	500-15	791440037014
G356	791440032330	G449-B	791440033047	ES3231	791440066748	100-W30	791440065826	500-BP22	791440037038
G359	791440032354	G458	791440033061	ES4007	791440039773	101	791440035577	500-MFVBP22	791440088122
G360	791440032361	G467	791440033108	ES4008	791440039769	101-30	791440001374	501	791440037052
G362	791440032378	G468	791440033115	1S-9133	791440033559	101-W	791440035591	501-30	791440037069
G363	791440032385	G472-AF	791440059153	4L-8212-R	791440033603	140-50 KIT	791440035652	501-W	791440037076
G366	791440032408	G480	791440033139	5H-5601	791440033627	150	791440035737	PKG50	791440046399
G368	791440032415	G483	791440040106	5M-954	791440033634	150-31	791440035812	PKG400	791440040496
G369-B	791440060913	G494	791440076198	6L-1540	791440033658	150-GK	791440035850	PKG401	791440040502
G369-V	791440066007	G498-A	791440040052	7B-7635	791440033665	150-H	791440035867	PKG402	791440040519
G372	791440032446	G499-AF	791440039650	8M-7830	791440033740	150-M	791440035881	PKG406	791440040557
G376	791440032484	G501-AF	791440033832	24-WLK	791440034778	150-W30	791440065833	PKG406-W	791440040564
G379	791440032507	AF521-WN	791440049352	55-EK	791440034792	151	791440035911	PKG411	791440058842
G380	791440032514	G523-AF	791440076204	60-21	791440034822	151-30	791440035928	PKG412	791440058859
G381-A	791440032521	AF525-WN	791440049369	60-21A	791440034839	151-W	791440035935	PKG470	791440063549
G382	791440032538	G534-AF	791440079519	60-30	791440034877	185-DS	791440035942	PKG470-DVD	791440063556
G382-V	791440032545	G704	791440065987	60-35A	791440034914	186-SK	791440035997	PKG470-S	791440063570
G385	791440032576	G710	791440065994	60-GK	791440034921	200	791440036000	PKG475	791440067431
G386	791440032583	G717	791440062573	61	791440034938	200-15	791440036079	PKG475-R	791440076440
G392	791440032613	G725	791440063303	61-W	791440034945	200-21	791440036130	PKG475-S	791440067448
G394	791440032637	ES1001	791440033184	65	791440034952	200-21BP	791440036147		
G397	791440032668	ES1023	791440033207	65-35A	791440034976	200-21H	791440036154		
G400	791440032682	ES1026	791440033214	65-W30	791440065802	200-21HBP	791440036161		
G401	791440032699	ES1030	791440033238	66	791440034983	200-21M	791440036178		

NOTES



WARNING: These products can expose you to chemicals, including Diisononyl Phthalate, Carbon black extracts, Nickel, 1,3 Butadiene, Ethylene Oxide, Epichlorohydrin, which are known to the State of California to cause cancer, and Bisphenol-A, Ethylene Glycol, Ethylene Oxide, 1,3 Butadiene, Epichlorohydrin, which are known to the State of California to cause birth defects or other reproductive harm. For more information go to www.P65Warnings.ca.gov.

UPC TO BALDWIN (INDIVIDUAL PARTS)

UPC NUMBER	BALDWIN NUMBER	UPC NUMBER	BALDWIN NUMBER	UPC NUMBER	BALDWIN NUMBER	UPC NUMBER	BALDWIN NUMBER	UPC NUMBER	BALDWIN NUMBER
79144000018	B2	791440001107	PT86-HD	791440002036	B159	791440002920	PF231	791440003804	PT319-MPG
79144000025	B2-HPG	791440001114	PT87-S	791440002043	B160	791440002937	B233	791440003811	PT320-MPG
79144000049	B4	791440001121	PT88-HD	791440002050	B161-S	791440002951	BT234	791440003859	BD324
79144000056	BT5	791440001138	PT89	791440002067	P162	791440002968	P235	791440003866	B326
79144000063	B6	791440001145	PT90-10	791440002074	B163	791440002975	B236	791440003880	B329
79144000070	B6-HPG	791440001152	PT90-MPG	791440002081	B164	791440002982	BT237	791440003897	BF330
79144000087	B7	791440001169	PT91	791440002104	B166	791440002999	BT238	791440003903	PF332
79144000094	B9	791440001183	PT93	791440002111	B167	791440003002	B239	791440003910	B333
79144000100	B10-AL	791440001190	PT93-MPG	791440002128	B168	791440003019	P240	791440003927	BT334
79144000117	B10-AL BOWL	791440001213	B95	791440002142	P170	791440003026	BT241	791440003941	B336
79144000124	B10-AL CAP	791440001244	B95-MPG	791440002159	P171	791440003033	P242	791440003958	B337
79144000131	PF10	791440001251	B96	791440002166	P172	791440003040	B243	791440003965	BT338
79144000148	PF10-CS	791440001282	B96-MPG	791440002173	B173-S	791440003057	B244	791440003972	BT339
79144000155	PT11	791440001299	B97	791440002180	P174	791440003071	B246	791440003989	BT340
79144000162	PT11-HD	791440001305	PT98-10	791440002203	P176	791440003088	B247	791440003996	BT341
79144000179	PT12	791440001312	PT98-MPG	791440002210	P177	791440003095	BT248	791440004009	BT342
79144000186	BF13	791440001329	B99	791440002227	B178	791440003101	P249	791440004016	BT343
79144000193	P15	791440001336	B99-B	791440002234	B179	791440003118	BT251	791440004023	BT344-S
79144000209	S16-1	791440001350	B99-MPG	791440002258	PT181 KIT	791440003125	B252	791440004030	BT345 KIT
79144000230	P18	791440001374	101-30	791440002265	G183	791440003132	B253	791440004047	BT346
79144000247	P18-HD	791440001381	P102	791440002272	P183	791440003156	B255	791440004054	BT347
79144000254	P19	791440001398	BD103	791440002296	P184	791440003163	PT256	791440004061	BT348
79144000261	P20-HD	791440001404	P104	791440002302	PT185	791440003170	PT257	791440004078	BT349
79144000339	P25	791440001411	B105	791440002319	P186	791440003187	PT258	791440004085	BT350
79144000346	P26	791440001428	P106	791440002326	P187	791440003194	BT259	791440004092	BT351
79144000353	B27	791440001435	P106-HD	791440002340	PT189	791440003200	BT260	791440004108	P352
79144000360	BD28	791440001459	PT108	791440002357	PT189-MPG	791440003217	BT260-10	791440004115	BT353
79144000377	PT29	791440001466	PT108-HD	791440002364	P190	791440003224	BT261	791440004122	BT354
79144000384	AFG30	791440001473	B109	791440002371	PT191	791440003231	B262	791440004139	BT355
79144000391	B30	791440001480	BC110	791440002388	PT191-10	791440003248	B263	791440004146	P356
79144000407	B31	791440001497	BT111	791440002395	PT191-5	791440003255	BT264	791440004153	BT357
79144000421	B33	791440001503	BT112	791440002418	PT193	791440003262	PT265	791440004160	B358
79144000438	B34	791440001510	B113	791440002425	PT193 KIT	791440003279	P266	791440004177	BT359
79144000445	B35-S	791440001527	B114	791440002432	PT193-3	791440003286	BT267	791440004184	B360
79144000469	AFG37R	791440001534	PT115	791440002449	P194	791440003293	PT268	791440004191	BT361
79144000476	B37	791440001541	P116	791440002456	P194-HD	791440003309	PT269	791440004214	BT364
79144000483	AFG38D	791440001558	PF116	791440002463	P194-HD10	791440003323	P271	791440004221	BT365
79144000506	B39	791440001565	PT117	791440002470	PF194	791440003347	PT273	791440004238	BT365-10
79144000513	P40	791440001572	PT117-25	791440002487	B195	791440003354	BT274	791440004245	BT366-10
79144000520	P41	791440001589	B118	791440002494	B196	791440003361	PT275	791440004252	BT367
79144000537	P42	791440001596	PT119	791440002517	P198	791440003378	PT275-10	791440004269	BT367-S
79144000544	B43-S	791440001602	PT119-5	791440002524	B199	791440003385	P276	791440004276	BT368
79144000568	B45	791440001619	PT119-HD	791440002548	B201-S	791440003408	PT277	791440004283	B369
79144000582	P47	791440001626	PT119-HD5	791440002555	B202	791440003415	B279	791440004290	PT370
79144000599	PT48	791440001640	B120	791440002562	P203	791440003422	P280	791440004306	BT371-10
79144000605	B49	791440001657	PF121	791440002579	P203-HD	791440003439	B281	791440004313	BT371-MPG
79144000612	B50	791440001664	PT122-5	791440002586	P203-HD10	791440003460	PT283	791440004320	BT372-10
79144000636	P52	791440001688	BT124	791440002593	P204	791440003477	PT284	791440004337	PT373
79144000643	P53	791440001695	P125	791440002609	P204-HD	791440003484	PT285	791440004344	BT374
79144000650	P54	791440001701	BT126	791440002616	P204-HD10	791440003491	BT287	791440004351	PT375
79144000674	B56	791440001718	B128	791440002623	B205	791440003507	BT287-10	791440004368	PT376
79144000711	P60	791440001725	B129	791440002630	P206	791440003514	PT288-HD	791440004375	PT377
79144000728	PT61-HD	791440001749	B131	791440002647	PT207	791440003521	PT288-HD10	791440004382	PT377-10
79144000735	PT62	791440001756	B132	791440002654	PT207-10	791440003538	PT289	791440004399	B378
79144000742	PT63-1	791440001763	C133-OW	791440002661	PT207-HD	791440003545	PT289-10	791440004405	B378-10
79144000773	PT66-HD	791440001770	C133-W	791440002678	PT207-HD10	791440003552	PT290	791440004412	PT379 KIT
79144000780	P67	791440001787	B134	791440002685	PT208	791440003576	BT292	791440004429	PT380 KIT
79144000797	P68	791440001794	PT135	791440002692	PT210	791440003590	P294	791440004436	PT381
79144000810	PT70	791440001817	PT137	791440002708	B211	791440003606	B295	791440004443	PT382
79144000834	PT71	791440001824	PT138-10	791440002715	PT212-5	791440003613	B296	791440004450	PT383
79144000858	PT72	791440001831	PT138-25	791440002722	PT213	791440003620	PT298-10	791440004467	PT385
79144000872	P73	791440001848	PT139-10	791440002739	PT214(2)	791440003637	B299	791440004474	PT385-E
79144000889	B74	791440001855	P140	791440002746	BT215	791440003644	T300-M	791440004481	PT386
79144000896	B75	791440001862	B141	791440002753	BT216	791440003651	B301	791440004498	BT387
79144000902	B76	791440001879	BD142	791440002760	BT217	791440003668	PT302	791440004504	BT387-10
79144000933	B76-MPG	791440001886	B143	791440002777	B218	791440003675	T303-M	791440004511	BT388
79144000964	PT79	791440001893	P144	791440002791	B220	791440003682	PT304	791440004528	BT388-10
79144000988	P80	791440001909	PT146	791440002807	BT221	791440003705	B307	791440004535	BT389
79144000995	P80-HD	791440001923	P148	791440002814	B222	791440003712	T308-M	791440004542	BT389-10
79144001015	P81	791440001947	P150	791440002821	BT223	791440003729	B309	791440004559	PT390-MPG
79144001022	P82	791440001954	PT151	791440002838	PF224	791440003736	PF311	791440004566	PT391-MPG
79144001039	PT82-HD	791440001961	PT152	791440002852	PF225	791440003743	PF312	791440004573	PT392
79144001046	PT82-HD10	791440001978	PT153	791440002876	PF226	791440003750	PF313	791440004580	PT393
79144001053	PT83	791440001985	PT154	791440002883	B227	791440003767	PF314	791440004597	PT394-15
79144001060	PT83-MPG	791440001992	PF155	791440002890	B228	791440003774	PF316	791440004603	BT395
79144001084	P84-2	791440002005	B156	791440002906	B229	791440003781	PT317-MPG	791440004610	PT396
79144001091	PT85	791440002012	B157	791440002913	BT230	791440003798	PT318-MPG	791440004627	PT397



WARNING: These products can expose you to chemicals, including Diisononyl Phthalate, Carbon black extracts, Nickel, 1,3 Butadiene, Ethylene Oxide, Epichlorohydrin, which are known to the State of California to cause cancer, and Bisphenol-A, Ethylene Glycol, Ethylene Oxide, 1,3 Butadiene, Epichlorohydrin, which are known to the State of California to cause birth defects or other reproductive harm. For more information go to www.P65Warnings.ca.gov.

UPC TO BALDWIN (INDIVIDUAL PARTS)

UPC NUMBER	BALDWIN NUMBER	UPC NUMBER	BALDWIN NUMBER	UPC NUMBER	BALDWIN NUMBER	UPC NUMBER	BALDWIN NUMBER	UPC NUMBER	BALDWIN NUMBER
791440004634	BT398	791440005617	B481	791440006676	BF582	791440007666	PA696	791440008755	PF810
791440004641	PT400	791440005631	PT483	791440006683	BF583	791440007673	PA697	791440008762	PF811
791440004658	PT401-MPG	791440005655	S485	791440006690	BF584	791440007680	PA699	791440008779	BF812
791440004665	BT402	791440005662	BT486	791440006706	BF584-B	791440007727	C704-L	791440008793	PF814
791440004672	B403	791440005679	PT487	791440006713	BF585	791440007741	P706-M	791440008816	PF816
791440004689	B404	791440005693	B488	791440006720	BF586	791440007765	PT707-HD	791440008823	PF816-S
791440004696	JC405	791440005709	S489	791440006737	BF586-D	791440007772	PT707-HD10	791440008847	PF818
791440004702	CU406	791440005716	PT490	791440006744	BF587	791440007789	PT707-HD3	791440008854	PF819
791440004719	DF408	791440005723	PT491	791440006751	BF587-D	791440007796	PT708-HD	791440008861	PF819-HD
791440004849	TC413-CPE5	791440005747	PT491-10	791440006768	BF588	791440007802	PT714	791440008878	PF820-S
791440004863	V414-B	791440005754	PT492	791440006874	BF591	791440007819	PF717	791440008885	PF821-S
791440004870	V414-FF	791440005761	PT493	791440006881	BF592	791440007833	PT718-5	791440008892	PF822
791440004887	F415-B	791440005778	B494	791440006898	BF593	791440007840	BF719	791440008908	PF823
791440004894	P415-10	791440005785	B495	791440006904	PF594	791440007857	BF720	791440008953	PF823-E
791440004900	P415-10A	791440005815	P496	791440006911	PT595	791440007864	P721	791440008960	PF824
791440004917	P415-25	791440005822	P497	791440006928	BF596	791440007871	PT722	791440008984	BF825
791440004924	P415-25A	791440005839	PT498	791440006935	BF597	791440007888	P723	791440008991	PF826
791440004931	P415-5	791440005846	PT498-10	791440006942	PF598	791440007895	PT725-MPG	791440009004	PF827
791440004948	P415-5A	791440005853	PT499-5	791440006959	PF598-10	791440007901	PT727-DL	791440009028	PF828
791440004955	P415-5AN	791440005884	F501-MD	791440006966	PF598-30	791440007918	PT727-HD	791440009035	PF829(2)
791440004962	P415-GM	791440005907	PT503	791440006973	PF599	791440007925	PT727-HD10	791440009042	BF830
791440004979	V415-B	791440005921	PF506	791440006980	PF599-10	791440007932	PT728-MPG	791440009059	PF831
791440004986	V415-FF	791440005938	P507	791440006997	PF599-30	791440007949	PT729	791440009073	BF833
791440004993	PT416	791440005945	PT508-MPG	791440007000	PA602	791440007970	BT732	791440009080	BF833-K2
791440005013	PT418	791440005952	PT509-MPG KIT	791440007017	PA604	791440007994	BT735	791440009097	BF834-F
791440005037	BT420	791440005969	PT510	791440007024	B605	791440008014	PT737	791440009103	PF834
791440005044	B421	791440005976	PT512	791440007048	PA607	791440008021	PT737-10	791440009127	BF836
791440005051	S423	791440005983	PT513	791440007086	PA612	791440008038	V730-0	791440009134	BF836-K3
791440005068	BT424	791440005990	PT514	791440007093	PA613	791440008045	BT739	791440009141	BF836-K4
791440005075	BT425	791440006003	PT515	791440007109	BF614	791440008052	C740-S	791440009158	BF837
791440005082	PT426	791440006010	PT516	791440007116	PA615	791440008144	C750-E	791440009165	BF838-F2
791440005099	BT427	791440006027	PT517	791440007123	PA616	791440008151	C750-L	791440009172	PF838
791440005112	V429-B	791440006034	PT518	791440007130	PA617	791440008168	C750-L SINGLE	791440009189	BT839
791440005129	V429-FF	791440006041	PT518-10	791440007147	PA618	791440008175	PT751	791440009196	BT839-10
791440005136	PT430-FF	791440006058	PT520	791440007154	PA618 FOAM	791440008182	PT752	791440009202	BF840
791440005143	PT431	791440006072	BT521	791440007161	PA618-S	791440008199	PT753	791440009219	BF840-K1
791440005150	PT433	791440006089	PT522	791440007185	PA621	791440008212	PT757	791440009233	VT842-O
791440005167	PT434	791440006096	BT525	791440007192	PA625	791440008229	PT757-10	791440009240	BF843
791440005174	PT434-10	791440006102	BT526	791440007208	PA631	791440008243	PT760-10	791440009257	F844-A
791440005181	PT435	791440006119	BT526-10	791440007215	PA632	791440008250	PT760-25	791440009264	F845-A
791440005198	PT436	791440006126	PT527	791440007222	PA633(2)	791440008267	PT761	791440009271	PF845
791440005204	PT437	791440006133	P528	791440007239	PA634	791440008281	PT763	791440009288	PF846
791440005211	BT438	791440006140	P529	791440007246	PA638	791440008298	PT764	791440009295	PF847
791440005228	PT439	791440006188	PT534	791440007253	PA639	791440008304	PT765	791440009318	PT849
791440005235	BT440	791440006195	PT535	791440007260	PA640	791440008311	PT766	791440009325	PT849-10
791440005242	PT441	791440006201	BT536	791440007277	PA641	791440008328	PT767	791440009356	V852-O
791440005259	PT442-MPG	791440006218	P537	791440007284	PA642	791440008335	PT768	791440009363	BF853
791440005266	BT443	791440006225	PT538	791440007291	PA643	791440008373	PT772	791440009387	BF855
791440005273	PT445-MPG	791440006232	PT539	791440007307	PA644	791440008380	PT773-MPG	791440009394	BF856
791440005280	P446	791440006249	P540	791440007314	PA645	791440008397	BT774	791440009400	PF857
791440005297	B447	791440006263	BT541	791440007338	PA648	791440008403	BT775	791440009417	BF858
791440005310	P450	791440006287	PT543 KIT	791440007345	PA649	791440008410	PT776-MPG	791440009424	PF859
791440005327	S451	791440006300	P545	791440007352	PA650	791440008427	PT777	791440009431	PF860
791440005334	BT452	791440006317	PT546	791440007369	PA651	791440008434	BT778	791440009448	PF861
791440005358	P454	791440006324	PT548	791440007376	PA652	791440008441	BT779	791440009455	BF862
791440005365	S455	791440006331	PT549	791440007383	PA653	791440008458	BF781	791440009462	BF863
791440005372	S456	791440006348	PT550-10	791440007390	PA654	791440008465	BF782	791440009479	PF864
791440005389	PT457-MPG	791440006355	PT551-10	791440007406	PA655	791440008472	BF783	791440009486	BF865
791440005396	PT459	791440006379	PT554	791440007413	PA656	791440008489	BF784	791440009493	BF865-K
791440005402	PT461	791440006386	P555	791440007420	PA657	791440008496	BF785	791440009509	PF866
791440005419	PT462	791440006393	BT556-10	791440007437	PA658	791440008502	BF786	791440009523	BF868
791440005426	PT463	791440006416	PT558	791440007475	PA662	791440008526	BF788	791440009530	PF869
791440005457	PT466	791440006423	PT560 KIT	791440007505	PA666	791440008533	BF789	791440009554	PF872
791440005464	PT467-MPG	791440006430	PT561	791440007512	PA669	791440008540	BF790	791440009561	BF873
791440005471	PT468-MPG	791440006454	PT562-10	791440007529	PT670	791440008557	BF791	791440009578	BF874
791440005488	PT469	791440006461	PT563	791440007536	PT670-E	791440008564	BF792	791440009592	BF876
791440005495	BT470	791440006478	BT564	791440007543	PA671	791440008588	BF794	791440009615	BF877
791440005501	PT471	791440006485	PT565	791440007550	PA671-1	791440008595	BF795	791440009646	BF879
791440005518	BT472	791440006492	PT566	791440007567	PA675	791440008618	BF797	791440009660	BF881
791440005525	B474	791440006508	PT567	791440007574	PT676	791440008625	BF798	791440009677	PF882
791440005532	PT475	791440006515	PT567-10	791440007581	PA677	791440008632	BF799	791440009684	PF883
791440005549	P476	791440006522	PT568	791440007598	PA678	791440008670	PF802	791440009691	BF884
791440005556	PT477	791440006553	PT571	791440007604	PA680	791440008694	PF804	791440009707	BF885
791440005570	S479	791440006577	PT573	791440007611	PT685-MPG	791440008700	BF805	791440009714	BF886
791440005587	PT480	791440006607	BF577	791440007628	PA691	791440008717	BF806	791440009721	BF888
791440005594	PT480-10	791440006614	PT578	791440007635	PA693	791440008724	PF807	791440009745	BF890
791440005600	PT480-MPG	791440006621	PT579	791440007642	PT694	791440008748	PF809	791440009752	BF891



WARNING: These products can expose you to chemicals, including Diisononyl Phthalate, Carbon black extracts, Nickel, 1,3 Butadiene, Ethylene Oxide, Epichlorohydrin, which are known to the State of California to cause cancer, and Bisphenol-A, Ethylene Glycol, Ethylene Oxide, 1,3 Butadiene, Epichlorohydrin, which are known to the State of California to cause birth defects or other reproductive harm. For more information go to www.P65Warnings.ca.gov.

UPC TO BALDWIN (INDIVIDUAL PARTS)

UPC NUMBER	BALDWIN NUMBER	UPC NUMBER	BALDWIN NUMBER	UPC NUMBER	BALDWIN NUMBER	UPC NUMBER	BALDWIN NUMBER	UPC NUMBER	BALDWIN NUMBER
791440009769	BF892	791440010888	PF987	791440012257	PA1603	791440013063	PA1681-FN	791440013940	PA1814
791440009776	PF893	791440010895	BF988	791440012264	PA1606	791440013070	PA1682	791440013957	PA1815
791440009783	PF893-RV	791440010901	BF989	791440012271	PA1607	791440013087	PA1683	791440013964	PA1816
791440009790	PF894	791440010925	BF991	791440012288	LL1608	791440013094	PA1684	791440013971	PA1817
791440009806	PF894-RV	791440010932	BF992	791440012295	PA1608	791440013100	PA1686	791440013988	PA1818
791440009820	BF896	791440010956	BF995	791440012301	PA1609	791440013117	PA1687	791440013995	PA1819
791440009837	BF897 KIT	791440010963	P996	791440012318	PA1610	791440013124	PA1688	791440014008	PA1821
791440009844	SF898	791440010970	P998	791440012325	PA1613	791440013131	PA1689	791440014015	PA1822-FN
791440009851	PF899	791440010994	P999-HD	791440012332	PA1613-S	791440013148	LL1690-FN	791440014022	PA1823
791440009868	BF900	791440011069	V1044-O	791440012349	LL1614	791440013155	PA1690-FN	791440014039	PA1824
791440009899	PF902	791440011076	BF1102	791440012356	PA1614	791440013162	PA1692	791440014046	PA1825
791440009905	PF902-S	791440011090	BF1104	791440012363	LL1615	791440013179	PA1696	791440014053	PA1826
791440009912	PT903	791440011106	BF1105	791440012370	PA1615	791440013186	PA1697	791440014060	PA1827
791440009950	PF906	791440011144	BF1110	791440012394	PA1618	791440013193	PA1698	791440014077	PA1828
791440009967	PF907	791440011175	BF1120	791440012400	PA1619	791440013209	PA1699-FN	791440014084	PA1830-FN
791440009974	F908-A	791440011182	BF1123	791440012417	PA1620	791440013216	PA1700	791440014091	PA1831
791440009981	BF909	791440011250	BF1140	791440012424	PA1620-S	791440013230	PA1701	791440014107	PA1832
791440009998	PF910	791440011281	BF1148	791440012431	LL1621-2	791440013247	PA1701 ELE	791440014114	PA1834
791440010024	BF912	791440011298	BF1150	791440012448	PA1621	791440013254	PA1701 FOAM	791440014121	PA1836
791440010031	PF913	791440011342	BF1160	791440012455	PA1621-2	791440013261	PA1702	791440014138	PA1837-FN
791440010048	BF914	791440011366	BF1163	791440012462	PA1621-S	791440013285	PA1702 FOAM	791440014152	PA1840
791440010055	BF915	791440011380	BF1166	791440012486	PA1625	791440013292	PA1703	791440014169	PA1841
791440010062	F916-C	791440011427	BF1170	791440012493	LL1626-2	791440013315	PA1704	791440014176	PA1845
791440010079	PF916	791440011434	BF1171	791440012509	PA1626	791440013322	PA1705-2	791440014183	LL1846
791440010109	BF918-K	791440011441	BF1201	791440012516	PA1626-2	791440013339	PA1706	791440014190	PA1846
791440010147	F919-C	791440011472	BF1210	791440012523	PA1627	791440013346	PA1707-FN	791440014213	PA1847-FN
791440010192	BF920	791440011489	BF1211	791440012530	PA1629-S	791440013353	PA1709	791440014220	PA1848
791440010239	PF924	791440011496	BF1212	791440012547	LL1630-2	791440013360	PA1710	791440014237	PA1849
791440010253	PF926	791440011502	BF1212 FOAM	791440012554	PA1630	791440013377	PA1712	791440014244	PA1850-FN
791440010277	BF928	791440011526	BF1213	791440012561	PA1630-2	791440013391	PA1718	791440014251	PA1851
791440010284	BF929	791440011533	BF1214	791440012578	PA1631-S	791440013407	PA1719	791440014268	PA1852
791440010291	BF930	791440011540	BF1216	791440012585	PA1632	791440013414	PA1721	791440014299	PA1857
791440010321	BF932	791440011557	BF1218	791440012608	PA1633	791440013421	PA1726	791440014305	PA1858
791440010338	BF933	791440011564	BF1219	791440012615	LL1634	791440013445	PA1735	791440014312	PA1859
791440010352	PF935	791440011571	BF1220	791440012622	PA1634	791440013469	PA1748	791440014329	PA1860
791440010369	PF936	791440011588	BF1221	791440012639	PA1635	791440013476	PA1749-FN	791440014336	PA1861
791440010376	PF937	791440011595	BF1223	791440012646	LL1636-FN	791440013483	PA1750-FN	791440014343	PA1863
791440010383	BF938	791440011601	BF1225	791440012653	PA1636-FN	791440013490	PA1752-FN	791440014367	PA1864-FN
791440010390	BF939	791440011618	BF1226	791440012660	LL1637-FN	791440013506	PA1753-FN	791440014374	PA1865-FN
791440010406	BF940	791440011632	BF1232	791440012677	PA1637-FN	791440013513	PA1754	791440014381	PA1866
791440010413	BF941	791440011649	BF1233	791440012684	PA1639	791440013520	PA1755-FN	791440014398	PA1867
791440010420	PF942	791440011670	V1240-C	791440012691	PA1641	791440013537	PA1757	791440014404	PA1868
791440010437	PF943	791440011694	BF1259	791440012707	LL1642-2	791440013544	PA1758	791440014411	PA1873
791440010451	PF945	791440011700	BF1276	791440012714	PA1642-2	791440013551	PA1763	791440014428	V1874-T
791440010468	PF946	791440011717	BF1280	791440012721	PA1643	791440013568	PA1765	791440014435	PA1875
791440010475	PF947	791440011731	FB1301	791440012738	PA1644	791440013575	PA1765 FOAM	791440014442	PA1877
791440010482	BF948	791440011748	FB1302	791440012745	F1645-DS	791440013582	PA1768	791440014459	PA1880
791440010512	BF948-JD	791440011755	OB1303	791440012752	V1645-C	791440013599	PA1769	791440014466	PA1881
791440010529	PF949	791440011779	OB1305	791440012769	LL1646-FN	791440013612	PA1771	791440014473	PA1882
791440010536	F950-F	791440011786	FB1307	791440012776	PA1646	791440013629	PA1772	791440014480	PA1883-FN
791440010543	PF950	791440011793	OB1308	791440012783	PA1646-FN	791440013636	PA1773	791440014497	LL1884
791440010550	PT951	791440011809	FB1309	791440012790	PA1647	791440013643	PA1774	791440014503	PA1884
791440010567	PF952	791440011816	FB1310	791440012806	PA1648	791440013650	PA1775	791440014510	LL1885
791440010574	BF954	791440011823	FB1311	791440012813	LL1649	791440013667	PA1776	791440014527	PA1885
791440010581	BF955	791440011830	OB1313	791440012820	PA1649	791440013674	PA1777	791440014534	LL1886
791440010598	BF956	791440011847	OB1314	791440012837	PA1650-FN	791440013681	PA1778	791440014541	PA1886
791440010604	BF957	791440011854	OB1315	791440012851	PA1653	791440013698	PA1779	791440014565	PA1888
791440010628	BF957-D	791440011861	OB1316	791440012868	V1656-O	791440013704	PA1780	791440014572	PA1889
791440010635	BF958	791440011878	OB1317	791440012875	V1656-T	791440013711	PA1781	791440014589	PA1891
791440010642	BF959	791440011885	OB1318	791440012882	PA1657	791440013728	PA1782	791440014596	PA1892-FN
791440010659	P960	791440011892	OB1319	791440012899	PA1661(3)	791440013735	PA1783	791440014602	PA1893
791440010673	BF962	791440011908	OB1320	791440012905	PA1663	791440013742	PA1784	791440014619	LL1894
791440010680	PF963	791440011953	VG1325	791440012912	PA1664	791440013759	PA1786	791440014626	PA1894
791440010710	BF966	791440011960	PG1326	791440012929	PA1666	791440013766	PA1787	791440014633	LL1895
791440010727	PF967	791440012011	OB1368	791440012936	LL1667-FN	791440013773	PA1788	791440014640	PA1895
791440010734	BF968	791440012035	B1400	791440012943	PA1667-FN	791440013780	PA1789	791440014657	PA1896
791440010741	BF970	791440012059	B1402	791440012950	LL1669	791440013797	PA1790	791440014664	PA1897
791440010758	PF971	791440012080	B1406	791440012967	PA1669	791440013803	PA1794-FN	791440014671	PA1898
791440010772	BF974-D	791440012097	B1407	791440012974	PA1670	791440013810	PA1795	791440014688	PA1899
791440010789	B975	791440012127	B1428	791440012981	PA1673	791440013827	PA1797	791440014695	PA1900
791440010796	BF976	791440012172	P1510	791440012998	PA1674	791440013834	PA1798	791440014701	PA1901
791440010819	BF978	791440012189	P1511	791440013001	PA1675	791440013841	PA1800	791440014718	LL1902-FN
791440010826	BF979	791440012196	V1520-R	791440013018	LL1676-FN	791440013865	PA1802	791440014725	PA1902-FN
791440010833	BF980	791440012219	V1542-C	791440013025	PA1676-FN	791440013889	PA1805	791440014732	PA1904
791440010840	PF981	791440012226	V1544-T	791440013032	PA1679	791440013896	PA1806	791440014749	PA1905
791440010864	BF984	791440012233	PA1600	791440013049	PA1680	791440013919	PA1809	791440014756	PA1906
791440010871	PF986	791440012240	PA1602	791440013056	LL1681-FN	791440013926	PA1810	791440014763	PA1907-FN



WARNING: These products can expose you to chemicals, including Diisononyl Phthalate, Carbon black extracts, Nickel, 1,3 Butadiene, Ethylene Oxide, Epichlorohydrin, which are known to the State of California to cause cancer, and Bisphenol-A, Ethylene Glycol, Ethylene Oxide, 1,3 Butadiene, Epichlorohydrin, which are known to the State of California to cause birth defects or other reproductive harm. For more information go to www.P65Warnings.ca.gov.

UPC TO BALDWIN (INDIVIDUAL PARTS)

UPC NUMBER	BALDWIN NUMBER	UPC NUMBER	BALDWIN NUMBER	UPC NUMBER	BALDWIN NUMBER	UPC NUMBER	BALDWIN NUMBER	UPC NUMBER	BALDWIN NUMBER
791440014770	PA1909	791440015807	PA2064	791440017115	PA2204	791440018037	LL2361	791440018846	PA2436
791440014787	PA1911	791440015814	PA2065	791440017146	PA2207	791440018044	PA2361	791440018853	PA2437
791440014794	PA1912	791440015838	PA2067	791440017153	PA2208	791440018051	PA2362	791440018877	PA2438
791440014800	PA1913	791440015845	PA2068	791440017191	PA2212	791440018068	LL2363	791440018884	LL2439
791440014817	PA1915	791440015852	PA2069	791440017214	PA2214	791440018075	PA2363	791440018891	PA2439
791440014824	PA1916	791440015869	PA2070	791440017221	PA2215	791440018082	PA2364	791440018907	PA2440
791440014831	PA1919-FN	791440015876	PA2071	791440017238	PA2216	791440018099	PA2367	791440018914	PA2441
791440014848	PA1920	791440015883	PA2072	791440017252	PA2218	791440018105	PA2368	791440018921	PA2442
791440014855	PA1921	791440015890	PA2073	791440017283	PA2221	791440018112	PA2369	791440018938	PA2443
791440014879	PA1922	791440015906	PA2074	791440017290	PA2222	791440018129	PA2370	791440018945	PA2444
791440014886	PA1922-FN	791440015913	PA2075	791440017306	PA2223	791440018136	PA2371	791440018952	PA2445
791440014916	PA1926	791440015920	PA2076	791440017313	PA2224	791440018143	PA2372	791440018969	PA2446
791440014923	PA1932	791440015937	PA2077	791440017320	PA2225	791440018167	PA2374	791440018976	LL2447-FN
791440014930	PA1934	791440015951	PA2079	791440017337	PA2226	791440018174	PA2375	791440018983	PA2447-FN
791440014947	PA1936	791440015968	PA2081	791440017344	PA2256	791440018181	PA2376	791440018990	PA2448
791440014954	PA1937	791440015982	PA2083	791440017351	PA2257	791440018198	PA2377	791440019010	PA2450
791440014961	PA1940	791440015999	SA2084	791440017368	PA2300	791440018204	PA2378	791440019027	PA2451
791440014978	PA1941-FN	791440016002	SA2085	791440017375	PA2301	791440018211	PA2379	791440019034	PA2452
791440015005	PA1945	791440016057	PA2091	791440017382	PA2302-FN	791440018228	PA2379-K	791440019041	LL2453
791440015012	PA1946	791440016064	PA2092	791440017399	PA2303	791440018235	PA2380-FN	791440019058	PA2453
791440015029	PA1949	791440016071	PA2093	791440017405	PA2304-FN	791440018242	PA2381	791440019065	PA2454
791440015043	PA1951	791440016088	PA2094	791440017412	PA2305	791440018266	PA2382	791440019072	PA2455
791440015050	PA1952	791440016095	PA2095	791440017429	PA2306	791440018273	PA2383	791440019089	LL2456
791440015067	PA1953	791440016101	PA2096	791440017436	PA2307	791440018280	LL2384	791440019096	PA2456
791440015081	PA1956-FN	791440016118	PA2099	791440017443	PA2308	791440018297	PA2384	791440019102	PA2457
791440015098	PA1957	791440016125	PA2100	791440017467	PA2310	791440018303	PA2385	791440019119	LL2458
791440015104	PA1960	791440016132	PA2101A	791440017474	LL2312	791440018310	PA2386	791440019126	PA2458
791440015111	PA1961	791440016149	PA2102	791440017481	PA2312	791440018327	PA2387	791440019133	PA2459
791440015128	PA1963	791440016156	PA2103	791440017498	PA2313	791440018334	PA2388	791440019140	PA2460
791440015135	PA1967	791440016163	PA2104	791440017504	PA2314	791440018358	PA2389-FN	791440019164	PA2461
791440015142	PA1969	791440016187	PA2106	791440017511	PA2315	791440018365	PA2390	791440019171	PA2462
791440015166	PA1972	791440016194	PA2107	791440017535	PA2316	791440018372	PA2391	791440019188	PA2463
791440015173	PA1973	791440016217	PA2109	791440017542	LL2317	791440018389	PA2392	791440019195	PA2464
791440015197	PA1975	791440016224	PA2110	791440017559	PA2317	791440018396	LL2393	791440019218	PA2465
791440015203	PA1976	791440016255	PA2113	791440017566	LL2318	791440018402	PA2393	791440019225	PA2466
791440015210	PA1977-FN	791440016262	PA2114	791440017573	PA2318	791440018419	PA2394	791440019232	PA2467
791440015227	PA1978-FN	791440016279	PA2115	791440017580	PA2319	791440018426	PA2395	791440019249	PA2468
791440015241	PA1979-FN	791440016286	PA2116	791440017597	PA2320-FN	791440018433	PA2396	791440019256	PA2469
791440015265	PA1980-FN	791440016293	PA2117	791440017603	PA2321	791440018440	PA2397	791440019263	PA2472
791440015272	PA1981	791440016323	PA2121	791440017610	PA2322	791440018457	PA2398	791440019270	PA2473
791440015289	PA1982	791440016354	PA2124	791440017627	PA2323	791440018464	PA2399	791440019287	PA2474
791440015296	PA1985	791440016361	PA2125	791440017641	LL2326	791440018488	PA2401	791440019294	PA2475
791440015302	PA1986	791440016385	PA2127	791440017658	PA2326	791440018495	PA2402	791440019300	PA2476
791440015319	PA1986-K	791440016453	PA2134	791440017672	PA2328	791440018501	PA2403	791440019317	PA2477
791440015326	PA1987	791440016460	PA2135	791440017689	PA2329	791440018518	PA2404	791440019324	PA2478
791440015333	PA1989-FN	791440016477	PA2136	791440017696	LL2330	791440018525	PA2405	791440019331	PA2479
791440015340	LL1992	791440016491	PA2138	791440017702	PA2330	791440018532	PA2406	791440019348	PA2481
791440015371	PA1992-FN	791440016507	PA2139	791440017719	PA2331	791440018549	PA2407	791440019355	LL2482
791440015388	PA1995	791440016514	PA2140	791440017726	PA2332	791440018556	PA2408	791440019362	PA2482
791440015395	PA1996	791440016576	PA2147	791440017733	LL2333	791440018563	PA2409	791440019379	PA2483
791440015401	PA1997	791440016583	PA2148	791440017740	PA2333	791440018570	PA2410	791440019386	PA2484
791440015418	PA1998	791440016590	PA2149	791440017757	PA2335	791440018587	PA2411	791440019393	PA2485
791440015425	PA2001	791440016606	PA2150	791440017764	PA2337	791440018594	PA2412	791440019409	PA2486
791440015432	PA2002	791440016620	PA2152	791440017771	PA2338-FN	791440018600	PA2413	791440019416	PA2487
791440015456	PA2005	791440016637	PA2153	791440017788	PA2339	791440018617	PA2414	791440019423	PA2488-FN
791440015463	PA2006	791440016644	PA2154	791440017795	PA2340	791440018624	PA2415	791440019430	PA2489
791440015470	PA2007	791440016668	PA2156	791440017801	PA2341	791440018631	PA2417-FN	791440019447	PA2490
791440015487	PA2008	791440016682	PA2158	791440017818	PA2342	791440018648	LL2418-FN	791440019454	PA2491
791440015494	PA2009	791440016699	SA2159	791440017825	PA2343	791440018655	PA2418-FN	791440019478	LL2493
791440015500	PA2010	791440016705	PA2160	791440017832	LL2344-FN	791440018662	PA2419	791440019485	PA2493
791440015531	PA2023	791440016729	PA2162	791440017849	PA2344-FN	791440018679	PA2420	791440019508	PA2494
791440015548	PA2024	791440016736	PA2163	791440017856	PA2345	791440018686	PA2421	791440019515	PA2495
791440015562	SA2027	791440016743	PA2164	791440017863	PA2346	791440018693	PA2422	791440019522	PA2496
791440015579	PA2031	791440016774	PA2167	791440017870	PA2347	791440018709	PA2423	791440019539	PA2497
791440015609	PA2036	791440016781	PA2168	791440017894	PA2349-FN	791440018716	LL2425	791440019546	PA2498
791440015616	PA2037	791440016798	PA2169	791440017900	PA2350	791440018723	PA2425	791440019553	PA2499
791440015623	PA2038	791440016811	PA2171	791440017917	PA2351	791440018730	LL2426-FN	791440019560	PA2500
791440015630	SA2039	791440016880	PA2178	791440017924	PA2352	791440018747	PA2426-FN	791440019584	PA2502
791440015647	PA2041	791440016910	PA2181	791440017931	PA2353	791440018754	PA2427	791440019591	LL2503
791440015654	PA2042	791440016927	PA2182	791440017948	PA2354	791440018761	PA2428	791440019607	PA2503
791440015661	PA2044	791440016934	PA2183	791440017955	PA2356	791440018778	PA2429	791440019614	PA2504
791440015692	PA2050	791440016965	PA2188	791440017979	PA2357	791440018785	PA2430	791440019621	LL2507
791440015708	PA2051	791440016972	PA2189	791440017986	LL2358	791440018792	PA2431	791440019638	PA2507
791440015715	PA2052	791440016996	PA2191	791440017993	PA2358	791440018808	PA2432	791440019645	PA2508
791440015722	PA2053	791440017016	PA2193	791440018006	PA2359	791440018815	PA2433	791440019652	PA2509
791440015777	PA2061	791440017023	PA2194	791440018013	LL2360-FN	791440018822	PA2434	791440019669	PA2510
791440015791	PA2063	791440017047	PA2196	791440018020	PA2360-FN	791440018839	PA2435	791440019676	PA2511



WARNING: These products can expose you to chemicals, including Diisononyl Phthalate, Carbon black extracts, Nickel, 1,3 Butadiene, Ethylene Oxide, Epichlorohydrin, which are known to the State of California to cause cancer, and Bisphenol-A, Ethylene Glycol, Ethylene Oxide, 1,3 Butadiene, Epichlorohydrin, which are known to the State of California to cause birth defects or other reproductive harm. For more information go to www.P65Warnings.ca.gov.

UPC TO BALDWIN (INDIVIDUAL PARTS)

UPC NUMBER	BALDWIN NUMBER	UPC NUMBER	BALDWIN NUMBER	UPC NUMBER	BALDWIN NUMBER	UPC NUMBER	BALDWIN NUMBER	UPC NUMBER	BALDWIN NUMBER
791440019683	PA2512	791440020603	PA2588	791440021464	PA2664	791440022355	PA2747	791440023178	PA2849
791440019690	PA2513	791440020610	PA2589-FN	791440021471	PA2665	791440022362	PA2748	791440023192	PA2851
791440019706	PA2514	791440020634	PA2591	791440021488	PA2666	791440022386	PA2749	791440023208	PA2852
791440019720	PA2515	791440020641	PA2592	791440021495	LL2667	791440022393	PA2750	791440023215	PA2853
791440019744	PA2516	791440020658	PA2593	791440021501	PA2667	791440022409	PA2751	791440023222	PA2854
791440019751	PA2517	791440020672	PA2595	791440021518	PA2668	791440022416	PA2752	791440023239	PA2855
791440019768	LL2518	791440020696	PA2596	791440021525	PA2669-FN	791440022423	PA2753	791440023246	PA2856
791440019775	PA2518	791440020719	PA2598	791440021532	PA2670	791440022430	PA2754	791440023253	PA2857
791440019782	PA2519	791440020726	PA2599	791440021556	PA2672	791440022447	PA2755	791440023260	PA2858
791440019805	PA2520	791440020733	PA2600	791440021563	PA2673	791440022454	PA2756	791440023277	PA2861
791440019812	LL2521	791440020740	PA2601	791440021570	PA2674	791440022461	PA2757	791440023291	RS2863
791440019829	PA2521	791440020757	PA2602	791440021594	PA2675	791440022478	PA2761	791440023307	PA2865
791440019836	PA2522	791440020771	PA2604	791440021600	LL2676	791440022485	PA2763	791440023321	PA2874
791440019843	PA2523	791440020788	PA2605	791440021617	PA2676	791440022492	PA2767	791440023338	PA2875
791440019850	PA2524-FN	791440020795	PA2606	791440021624	PA2677	791440022508	PA2772	791440023345	PA2876
791440019867	LL2525	791440020801	PA2607	791440021631	PA2678	791440022515	PA2773	791440023352	PA2900
791440019874	PA2525	791440020818	LL2608	791440021655	PA2679	791440022522	PA2774	791440023369	PA2902
791440019881	PA2526	791440020825	PA2608	791440021662	PA2680	791440022539	PA2775	791440023376	PA2932
791440019898	PA2527	791440020832	LL2609	791440021693	PA2684-FN	791440022546	PA2776	791440023383	PA2933
791440019904	PA2528	791440020849	PA2609	791440021709	LL2685	791440022553	PA2777	791440023406	PA2936
791440019911	PA2529	791440020856	PA2610	791440021730	PA2687	791440022560	PA2778-FN	791440023413	PA2938
791440019928	PA2530	791440020863	PA2611	791440021747	LL2688	791440022577	LL2779	791440023444	PA2944-FN
791440019942	PA2531	791440020870	PA2612	791440021754	PA2688	791440022584	PA2779	791440023451	LL2945
791440019966	PA2532	791440020887	PA2613	791440021761	PA2689	791440022607	PA2781	791440023468	PA2945
791440019980	PA2533	791440020894	PA2614	791440021778	PA2690	791440022614	PA2782	791440023475	PA2946
791440019997	PA2534	791440020900	PA2615	791440021785	PA2691	791440022638	PA2783	791440023482	PA2947
791440020009	PA2535	791440020917	PA2616	791440021792	PA2692	791440022645	PA2784	791440023499	PA2949-FN
791440020016	PA2536	791440020924	PA2617	791440021808	PA2693	791440022652	PA2785	791440023505	PA2973
791440020023	PA2538	791440020931	LL2618	791440021815	PA2694	791440022669	PA2786	791440023529	PA2978
791440020030	PA2539	791440020948	PA2618	791440021839	PA2696	791440022676	PA2787	791440023536	PA2984
791440020047	PA2540	791440020955	PA2619	791440021846	PA2698	791440022683	PA2788	791440023543	PA2988
791440020054	PA2541-FN	791440020962	PA2620	791440021860	PA2699	791440022690	PA2789	791440023550	PA2989
791440020061	PA2542	791440020979	PA2621	791440021877	PA2700	791440022706	PA2790-FN	791440025523	PA3404
791440020085	PA2544	791440020986	PA2622	791440021884	PA2701	791440022713	PA2791	791440025530	PA3406-FN
791440020092	PA2545	791440020993	PA2623	791440021891	PA2702	791440022720	PA2792	791440025592	PA3420
791440020108	PA2546	791440021006	PA2624	791440021907	PA2703	791440022737	PA2793	791440025608	PA3421
791440020115	PA2547	791440021013	PA2625	791440021914	PA2704	791440022744	PA2794	791440025615	PA3428
791440020122	PA2548	791440021020	PA2626	791440021921	PA2705	791440022768	PA2796	791440025622	PA3439-FN
791440020146	PA2550	791440021037	PA2627	791440021938	PA2706	791440022775	PA2797	791440025639	PA3440
791440020153	PA2551	791440021044	PA2628	791440021945	PA2707	791440022782	PA2798	791440025653	PA3442
791440020160	PA2552	791440021051	PA2629	791440021952	PA2708	791440022799	PA2799	791440025677	PA3447
791440020177	PA2553	791440021068	PA2630	791440021969	PA2709	791440022805	PA2801	791440025684	PA3448
791440020184	PA2554	791440021075	PA2631	791440021976	PA2710	791440022812	PA2803	791440025714	PA3453
791440020207	PA2555	791440021082	PA2632	791440021983	PA2711	791440022836	PA2805	791440025738	PA3457
791440020221	PA2556	791440021099	PA2633-FN	791440021990	PA2712	791440022843	PA2806	791440025745	PA3458
791440020238	LL2557	791440021105	PA2634	791440022003	PA2713	791440022850	PA2807	791440025769	PA3460
791440020245	PA2557	791440021112	PA2635-FN	791440022010	PA2714	791440022867	PA2812	791440025776	PA3461
791440020269	PA2558	791440021129	PA2636	791440022027	PA2715	791440022874	PA2814	791440025790	PA3463
791440020276	LL2559	791440021136	PA2637	791440022034	PA2716	791440022881	PA2815	791440025806	PA3464
791440020283	PA2559	791440021143	PA2638	791440022041	PA2717	791440022898	PA2816	791440025820	PA3466-FN
791440020313	LL2562	791440021150	PA2640	791440022058	PA2718	791440022904	PA2817	791440025837	PA3467
791440020320	PA2562	791440021174	PA2641	791440022065	PA2719	791440022911	PA2818	791440025851	PA3469
791440020337	PA2563	791440021181	LL2642	791440022089	PA2721	791440022928	PA2819	791440025868	PA3470
791440020344	PA2564	791440021198	PA2642	791440022096	PA2722	791440022935	PA2820	791440025875	PA3471
791440020368	PA2566	791440021204	PA2643	791440022102	PA2723	791440022942	PA2821	791440025882	PA3472-FN
791440020375	PA2567	791440021211	PA2644	791440022119	PA2724	791440022959	PA2822	791440025899	PA3473
791440020382	PA2568	791440021228	PA2645	791440022126	PA2725	791440022966	PA2823	791440025905	PA3474
791440020399	PA2569	791440021235	PA2646	791440022133	PA2726	791440022973	PA2824	791440025912	PA3475
791440020405	PA2570	791440021242	PA2647	791440022140	PA2727	791440022980	PA2825	791440025929	PA3476
791440020412	PA2571	791440021259	PA2648	791440022157	PA2728	791440022997	PA2826	791440025936	PA3477
791440020429	PA2572	791440021266	PA2649	791440022164	PA2729	791440023000	PA2827	791440025943	PA3478
791440020436	PA2573	791440021273	PA2650	791440022171	PA2730	791440023017	PA2828	791440025950	PA3479
791440020443	PA2574	791440021280	PA2651	791440022188	PA2731	791440023024	PA2829	791440025967	PA3481
791440020450	LL2575	791440021297	PA2652	791440022195	PA2732	791440023031	PA2830	791440025974	PA3482
791440020467	PA2575	791440021303	PA2653	791440022201	PA2733	791440023048	PA2831	791440025981	PA3486
791440020474	PA2576	791440021310	PA2653 FOAM	791440022225	PA2734	791440023055	PA2832	791440025998	PA3487
791440020481	PA2577	791440021327	PA2654	791440022232	PA2735	791440023062	PA2833	791440026001	PA3492
791440020498	PA2578	791440021334	PA2655	791440022249	PA2736	791440023079	PA2834	791440026018	PA3495
791440020504	PA2579	791440021358	PA2656	791440022256	PA2737	791440023086	PA2835	791440026025	PA3496
791440020511	PA2580	791440021365	PA2657-FN	791440022263	PA2738	791440023093	PA2836	791440026049	PA3498
791440020528	PA2581	791440021372	PA2658	791440022270	PA2739	791440023109	PA2837	791440026056	RS3501
791440020535	LL2582	791440021396	PA2659	791440022287	PA2740	791440023116	PA2839	791440026063	RS3502
791440020542	PA2582	791440021402	PA2660	791440022300	PA2742	791440023123	PA2843	791440026070	RS3503
791440020559	PA2583	791440021419	LL2661	791440022317	PA2743	791440023130	PA2844	791440026087	RS3504
791440020573	PA2585	791440021426	PA2661	791440022324	PA2744	791440023147	PA2845	791440026094	RS3505
791440020580	PA2586	791440021433	PA2662	791440022331	PA2745	791440023154	PA2846-FN	791440026100	RS3506
791440020597	PA2587	791440021457	PA2663-FN	791440022348	PA2746	791440023161	PA2848	791440026117	RS3507



WARNING: These products can expose you to chemicals, including Diisononyl Phthalate, Carbon black extracts, Nickel, 1,3 Butadiene, Ethylene Oxide, Epichlorohydrin, which are known to the State of California to cause cancer, and Bisphenol-A, Ethylene Glycol, Ethylene Oxide, 1,3 Butadiene, Epichlorohydrin, which are known to the State of California to cause birth defects or other reproductive harm. For more information go to www.P65Warnings.ca.gov.

UPC TO BALDWIN (INDIVIDUAL PARTS)

UPC NUMBER	BALDWIN NUMBER	UPC NUMBER	BALDWIN NUMBER	UPC NUMBER	BALDWIN NUMBER	UPC NUMBER	BALDWIN NUMBER	UPC NUMBER	BALDWIN NUMBER
791440026124	RS3508	791440028128	BK6600	791440029651	H9075	791440031333	G204-A	791440032538	G382
791440026131	RS3509	791440028135	BK6601	791440029668	H9076	791440031357	G206	791440032545	G382-V
791440026148	RS3510	791440028203	BK6610	791440029675	H9077	791440031364	G208-A	791440032576	G385
791440026155	RS3511	791440028241	BK6700	791440029682	H9078	791440031388	G210	791440032583	G386
791440026162	RS3512	791440028265	BK6710	791440029699	H9079	791440031395	G211	791440032613	G392
791440026179	RS3513	791440028296	BK6720	791440029705	H9080	791440031401	G214	791440032637	G394
791440026186	RS3514	791440028302	BK6721	791440029712	H9081	791440031425	G219	791440032668	G397
791440026193	RS3515	791440028326	BK6723	791440029729	H9082	791440031432	G220	791440032682	G400
791440026209	RS3516	791440028333	BK6780	791440029736	H9083	791440031449	G222-B	791440032699	G401
791440026278	PA3551	791440028487	P7003	791440029743	H9084	791440031487	G229	791440032705	G402
791440026285	PA3554	791440028494	B7004	791440029750	H9085	791440031500	G232	791440032712	G403
791440026292	PA3555	791440028500	B7005	791440029767	H9086	791440031517	G233-A	791440032743	G406
791440026308	PA3556	791440028531	B7009	791440029774	H9092	791440031524	G233-B	791440032774	G409
791440026315	PA3557-FN	791440028548	B7010	791440029781	H9093	791440031555	G236-A	791440032781	G410
791440026322	PA3558	791440028555	B7011	791440029804	H9096	791440031579	G238	791440032798	G411
791440026339	PA3559	791440028562	B7014	791440029811	H9097	791440031586	G239	791440032804	G412
791440026346	PA3560	791440028579	B7018	791440029828	H9103	791440031593	G240	791440032835	G416
791440026353	PA3562	791440028586	B7019	791440029835	H9107	791440031609	G241	791440032842	G417
791440026360	PA3563	791440028593	B7020	791440029842	H9108	791440031616	G243-A	791440032880	G431
791440026377	PA3565	791440028609	B7022	791440029859	H9110	791440031630	G247	791440032897	G432
791440026384	PA3566	791440028616	B7023	791440029866	H9111	791440031661	G251	791440032903	G433
791440026391	PA3569	791440028623	B7024	791440029873	H9112	791440031678	G252	791440032910	G434
791440026438	PA3572	791440028630	B7025	791440029880	H9113	791440031685	G253-A	791440032927	G435
791440026445	PA3573	791440028715	F7500	791440029897	H9114	791440031692	G255	791440032934	G436
791440026469	PA3576	791440028722	P7500	791440029903	H9123	791440031715	G257	791440032958	G438
791440026483	PA3580	791440028760	BF7519	791440029989	18104	791440031722	G260	791440032965	G439
791440026490	PA3581	791440028821	BF7528	791440030015	18139	791440031739	G261	791440032972	G441
791440026551	PA4016	791440028838	BF7529	791440030039	18155	791440031753	G263	791440032989	G442
791440026568	PA4018	791440028852	BF7538	791440030053	18171	791440031760	G264-A	791440032996	G443
791440026582	PA4023	791440028869	BF7557	791440030077	18198	791440031777	G265	791440033009	G444
791440026599	PA4026	791440028883	BF7558	791440030114	18236	791440031791	G268	791440033016	G445
791440026605	PA4028	791440028906	B7577	791440030121	18245	791440031807	G269	791440033023	G446
791440026650	PA4050	791440028937	B7600	791440030329	19739	791440031814	G270	791440033030	G447
791440026681	PA4060	791440029071	BT8301	791440030343	19828	791440031821	G273	791440033047	G449-B
791440026704	CFB5000	791440029095	BT8304	791440030442	19992	791440031838	G274	791440033061	G458
791440026742	CS5007	791440029101	PT8305	791440030459	PA3480	791440031845	G275	791440033108	G467
791440026759	CS5008	791440029118	PT8306-10	791440030466	BT8307-MPG	791440031852	G278	791440033115	G468
791440026766	CS5009	791440029125	PT8306-25	791440030473	BT8308-MPG	791440031876	G280	791440033139	G480
791440026773	CS5010	791440029132	BT8312	791440030480	BT8309-MPG	791440031883	G281	791440033177	G1973
791440026780	CS5011	791440029149	BT8314	791440030497	BT8310-MPG	791440031906	G283	791440033184	ES1001
791440026797	CSC5012	791440029156	PT8318-MPG	791440030527	PA3493	791440031913	G288	791440033207	ES1023
791440026803	CSC5013	791440029163	BT8320	791440030558	ES24-B	791440031920	G289	791440033214	ES1026
791440026865	CTK5028	791440029194	BT8802-MPG	791440030619	G102-A	791440031944	G291	791440033238	ES1030
791440026889	CS5057	791440029200	BT8803-MPG	791440030626	G103	791440031951	G296	791440033245	ES1032
791440026896	CS5058	791440029231	BT8812-MPG	791440030633	G104	791440031968	G299	791440033252	ES1034
791440026902	OTK5060	791440029248	BT8813-MPG	791440030640	G105	791440031982	G302	791440033276	ES1036
791440026919	OTK5061	791440029255	H9001	791440030657	G106	791440031999	G303	791440033283	ES1041
791440026933	OTK5063	791440029279	H9007	791440030664	G107	791440032002	G304	791440033306	ES1049
791440026940	BW5070	791440029293	H9013	791440030718	G115-A	791440032019	G305	791440033337	ES1066
791440026957	BW5071	791440029309	H9014	791440030725	G115-MSB	791440032026	G306	791440033344	ES1067
791440026964	BW5072	791440029323	H9020	791440030756	G120-A	791440032033	G307	791440033351	ES1068
791440026971	BW5073	791440029330	H9021	791440030787	G123	791440032040	G309-B	791440033368	ES1071
791440026988	BW5074	791440029347	H9024	791440030817	G127	791440032057	G310	791440033375	ES1074
791440026995	BW5075	791440029361	H9036	791440030855	G132	791440032071	G314	791440033382	ES1092
791440027008	BW5076	791440029408	H9041	791440030862	G133	791440032088	G315	791440033399	ES1303-A
791440027046	B5134	791440029415	H9042	791440030923	G140-A	791440032149	G323	791440033405	ES1303-B
791440027053	BW5136	791440029422	H9043	791440030954	G143	791440032187	G332	791440033412	ES1369-A
791440027060	BW5137	791440029439	H9044	791440030961	G144	791440032194	G333	791440033474	ES3012
791440027077	BW5138	791440029446	H9045	791440030978	G147-A	791440032217	G336	791440033481	ES3028
791440027084	BW5139	791440029453	H9046	791440030985	G148	791440032248	G340	791440033498	ES3029
791440027091	BW5140	791440029460	H9047	791440031005	G153	791440032255	G342	791440033528	ES3063
791440027107	BW5141	791440029477	H9048	791440031012	G154	791440032262	G343-A	791440033559	1S-9133
791440027121	B5176	791440029484	H9049	791440031029	G155	791440032279	G344	791440033603	4L-8212-R
791440027138	B5177	791440029491	H9050	791440031036	G157	791440032293	G347	791440033627	5H-5601
791440027145	BW5178	791440029507	H9051	791440031074	G161	791440032316	G354	791440033634	5M-954
791440027152	BW5179	791440029521	H9054	791440031081	G162	791440032330	G356	791440033658	6L-1540
791440027183	BF5801	791440029538	H9055	791440031098	G164-A	791440032354	G359	791440033665	7B-7635
791440027190	BF5800	791440029545	H9056	791440031104	G165	791440032361	G360	791440033740	8M-7830
791440027206	BF5810	791440029569	H9058	791440031128	G168-B	791440032378	G362	791440033764	G15-AF
791440027213	BF5812	791440029576	H9060	791440031135	G169	791440032385	G363	791440033801	G21-AF
791440027220	BF5813	791440029583	H9062	791440031159	G171	791440032408	G366	791440033818	G25-AF
791440027282	6017	791440029590	H9069	791440031173	G172-A	791440032415	G368	791440033825	G1086-AF
791440027305	6020	791440029606	H9070	791440031227	G184-A	791440032446	G372	791440033832	G501-AF
791440027312	6021	791440029613	H9071	791440031265	G193	791440032484	G376	791440034129	G31-AF
791440027725	BK6380	791440029620	H9072	791440031289	G196-B	791440032507	G379	791440034150	G34-AF
791440028081	BK6561	791440029637	H9073	791440031319	G202	791440032514	G380	791440034167	G37-AF
791440028098	BK6562	791440029644	H9074	791440031326	G203	791440032521	G381-A	791440034174	G39-AF



WARNING: These products can expose you to chemicals, including Diisononyl Phthalate, Carbon black extracts, Nickel, 1,3 Butadiene, Ethylene Oxide, Epichlorohydrin, which are known to the State of California to cause cancer, and Bisphenol-A, Ethylene Glycol, Ethylene Oxide, 1,3 Butadiene, Epichlorohydrin, which are known to the State of California to cause birth defects or other reproductive harm. For more information go to www.P65Warnings.ca.gov.

UPC TO BALDWIN (INDIVIDUAL PARTS)

UPC NUMBER	BALDWIN NUMBER	UPC NUMBER	BALDWIN NUMBER	UPC NUMBER	BALDWIN NUMBER	UPC NUMBER	BALDWIN NUMBER	UPC NUMBER	BALDWIN NUMBER
791440034396	G141-AF	791440036987	301-W	791440038615	PA2554 FOAM	791440042834	RS3537	791440045415	PA2891
791440034419	G145-AF	791440036994	500	791440038646	PA3446	791440042858	PA3644	791440045446	PA2955
791440034440	G207-AF	791440037007	500-12	791440038653	PA3452	791440042889	PA3645	791440045453	PA2963
791440034471	G285-AF	791440037014	500-15	791440038660	PA3491	791440042926	PT8329	791440045484	PA2232
791440034501	G298-AF	791440037038	500-BP22	791440038677	RS3520	791440042995	BT8830	791440045491	BT8368
791440034587	G422-AF	791440037052	501	791440038691	PA4015	791440043008	BT8832	791440045521	BF7591-D
791440034624	301-MPG	791440037069	501-30	791440038738	PA3579	791440043015	BT8831	791440045538	BK6619
791440034778	24-WLK	791440037076	501-W	791440038745	PA3584	791440043039	RS3517	791440045545	B1413
791440034792	55-EK	791440037533	PA3597	791440038813	P7007	791440043060	RS3548	791440045552	P7092
791440034822	60-21	791440037540	PA3598	791440038820	P7012	791440043077	B1430	791440045569	P7093
791440034839	60-21A	791440037571	PT8344	791440038851	B7031	791440043091	PT8356	791440045583	PF7592
791440034877	60-30	791440037588	P7053	791440038875	B7042	791440043107	BW5082	791440045590	PA3664-FN
791440034914	60-35A	791440037595	PA3600	791440038882	BF7531	791440043138	BF7584	791440045620	PA3668
791440034921	60-GK	791440037601	PA2260	791440038899	BT8302	791440043145	P7081	791440045637	PA3669-FN
791440034938	.61	791440037618	BD7028	791440038905	BT8316-MPG	791440043152	RT8319	791440045644	BF1329-SP
791440034945	61-W	791440037625	B7051	791440038912	BT8323	791440043169	PT8341	791440045651	ES1377
791440034952	.65	791440037632	PF7549	791440038943	PT8330-MPG	791440043176	PT8335	791440045668	BF1222-SP
791440034976	65-35A	791440037649	PA3601	791440038950	BT8333	791440043206	BT8357	791440045675	BF1222
791440034983	.66	791440037687	PF7550	791440038967	BT8850-MPG	791440043237	CTK5029	791440045699	PA2233
791440034990	66-W	791440037694	PF7551	791440038981	BT8861	791440043244	PA3650	791440045705	BF1329
791440035003	.75	791440037700	PA3602	791440039148	18268	791440043251	PA3651-FN	791440045712	P7052
791440035027	75-21	791440037724	PA3604	791440039322	BT8851-MPG	791440043268	PA3652	791440045729	RS3549
791440035034	85-EK	791440037748	BF7552	791440039353	PT8350	791440043275	B7585	791440045736	RS3703
791440035041	85-P	791440037755	PA3605	791440039377	RS3532	791440043282	B7082	791440045743	RS3704
791440035058	85-V	791440037762	PA3606	791440039384	RS3533	791440043299	PA3653	791440045750	RS3705
791440035126	100	791440037779	PA3607-FN	791440039391	RS3535	791440043305	BF7586	791440045767	PA3670
791440035157	100-12	791440037786	PA3608-FN	791440039650	G499-AF	791440043312	BF7587	791440045781	BF1347
791440035232	100-21	791440037793	PA3609	791440039667	G348-AF	791440043329	P7083	791440045804	BF1345-SP
791440035249	100-21BP	791440037809	PA3610	791440039766	ES4008	791440043336	PF7588	791440045811	BF1205
791440035270	100-21M	791440037816	PA3611	791440039773	ES4007	791440043343	BF1231	791440045828	BF1204
791440035324	100-28	791440037854	B7039	791440040052	G498-A	791440043350	P7084	791440045835	BF1205-SP
791440035331	100-29	791440037885	BF7546	791440040106	G483	791440043374	PT8359	791440045897	PT8339
791440035348	100-30	791440037892	BF1345	791440040243	B7030	791440043428	PA3654	791440045903	BF1348
791440035416	100-BP	791440037908	PA3587	791440040496	PKG400	791440043435	PA4005	791440045910	BF1204-SP
791440035454	100-GK	791440037915	PA3588	791440040502	PKG401	791440043442	B1405	791440045927	BT610-MPG
791440035485	100-M	791440037946	PA3588	791440040519	PKG402	791440043459	PA2200	791440045934	BT8846
791440035508	100-MFV	791440037960	BF7544	791440040557	PKG406	791440043473	PA2228	791440045941	BT8852-MPG
791440035515	100-MMV	791440037984	BF7541	791440040564	PKG406-W	791440043497	PA2230	791440045958	BT611-MPG
791440035546	100-W	791440037991	BF880-FP	791440041141	PA2903	791440043510	RS3700	791440045972	BK6702
791440035577	101	791440038028	PA3430	791440041189	PT8352	791440043527	RS3701	791440045989	PA3672
791440035591	101-W	791440038035	PA3578	791440041196	PT8351	791440043558	B1410	791440045996	PA3671-FN
791440035652	140-50 KIT	791440038042	RS3540	791440041202	PT8353	791440043565	PA4041	791440046016	PA3674
791440035737	150	791440038059	BT305	791440041233	RS3542	791440043589	PA3655	791440046061	BD7095
791440035812	150-31	791440038066	B7047	791440041240	RS3543	791440043596	PA3657	791440046078	PA2234
791440035850	150-GK	791440038073	PT8345	791440041257	RS3544	791440043602	PA3656	791440046085	PA3675
791440035867	150-H	791440038080	BT8328	791440041264	RS3545	791440043619	PA3658	791440046092	PA3676
791440035881	150-M	791440038097	PA3595	791440041288	RS3547	791440043626	PA4069	791440046115	BF1223-SP
791440035911	151	791440038110	P7035	791440041295	BF7571	791440043633	PA4070	791440046122	BF7593
791440035928	151-30	791440038127	BT372-MPG	791440041325	PA3499	791440043640	PA4071	791440046252	BK6579
791440035935	151-W	791440038134	P7000 KIT	791440041493	BF1173	791440043657	PT8338	791440046283	PF7594
791440035942	185-DS	791440038141	PT8331-MPG	791440041530	BF7534	791440043664	PF7545	791440046290	PF7595
791440035977	186-SK	791440038219	B1429	791440042254	BK6764	791440043671	B7045	791440046344	RS3706
791440036000	200	791440038226	P7058	791440042469	PA3627	791440043718	P7050	791440046351	RS3707
791440036079	200-15	791440038233	P7059	791440042476	PA3628	791440043725	PT8334	791440046375	RS3708
791440036130	200-21	791440038240	PF7553	791440042483	PA3629	791440043794	PA4072	791440046382	RS3709
791440036147	200-21BP	791440038257	PF7554	791440042490	PT8354	791440043800	PA3660-FN	791440046399	PK650
791440036154	200-21H	791440038264	PA3612	791440042506	PT8355	791440043817	PA4073	791440046412	PF7596
791440036161	200-21HBP	791440038271	PA3613	791440042520	BF1239	791440043831	PA3667-FN	791440046429	BT8870-MPG
791440036178	200-21M	791440038295	BT8347	791440042537	PF7572	791440043848	RS3541	791440046443	BT8874-MPG
791440036239	200-30U	791440038325	PF7556	791440042568	P7013	791440044968	PT8361	791440046450	BK6375
791440036246	200-31	791440038332	PA3614	791440042575	PA3630-FN	791440044999	B7049	791440046467	BT606-MPG
791440036321	200-GK	791440038349	BF7559	791440042582	PA3631	791440045019	B7089	791440046474	P7021
791440036369	200-M	791440038356	BF1346	791440042599	PA3632	791440045033	BF1224	791440046511	BT8873
791440036390	200-MFV	791440038363	RS3530	791440042605	PA3633	791440045095	PT8363	791440046528	PA3679
791440036406	200-MMV	791440038370	RS3538	791440042629	BT8845	791440045118	PA2231	791440046535	PF7597
791440036451	200-W30	791440038387	B7044	791440042636	BT8844	791440045132	RS3536	791440046542	BK6376
791440036468	201	791440038394	BT8840-MPG	791440042643	PA2001 FOAM	791440045163	PT394-5	791440046559	BF7532
791440036475	201-30	791440038400	BT8862	791440042667	PA3636	791440045170	RS3534	791440046566	BT8875-MPG
791440036499	201-W	791440038417	BT8863	791440042674	BD103-MPG	791440045187	RS3539	791440046610	B7097
791440036505	285-DS	791440038424	RS3528	791440042704	PA3637	791440045217	B7091	791440046627	P7015
791440036512	286-SK	791440038431	RS3518	791440042711	PA3638	791440045231	PT8366	791440046726	P7016
791440036529	300	791440038448	RS3550	791440042735	PA3640	791440045248	BF7535	791440046733	P7017
791440036666	300-DHRA55	791440038455	BD232	791440042766	BF7576	791440045361	PA2838	791440046771	RS3710
791440036741	300-H	791440038462	BT310	791440042773	BF7579	791440045378	PA2860-FN	791440046788	RS3711
791440036956	301	791440038585	PA2139 FOAM	791440042780	BF7580	791440045385	PA2862	791440046795	PA3680
791440036963	301-30	791440038592	PA2258	791440042810	PA3643	791440045392	PA2869	791440046818	PA3681
791440036970	301-CS	791440038608	PA2480	791440042827	RS3529	791440045408	PA2878	791440046825	PA3682



WARNING: These products can expose you to chemicals, including Diisononyl Phthalate, Carbon black extracts, Nickel, 1,3 Butadiene, Ethylene Oxide, Epichlorohydrin, which are known to the State of California to cause cancer, and Bisphenol-A, Ethylene Glycol, Ethylene Oxide, 1,3 Butadiene, Epichlorohydrin, which are known to the State of California to cause birth defects or other reproductive harm. For more information go to www.P65Warnings.ca.gov.

UPC TO BALDWIN (INDIVIDUAL PARTS)

UPC NUMBER	BALDWIN NUMBER	UPC NUMBER	BALDWIN NUMBER	UPC NUMBER	BALDWIN NUMBER	UPC NUMBER	BALDWIN NUMBER	UPC NUMBER	BALDWIN NUMBER
791440046832	PA3683	791440048942	BF7608	791440050488	BF1248	791440051874	PA3798	791440053182	RS3741
791440046849	PA3684	791440048959	PA4042	791440050495	PA3781	791440051881	RS3730	791440053199	BT8409
791440046856	PA3685	791440048966	PA4043	791440050501	BF7614	791440051898	BF1348-SP	791440053236	BK6634
791440046863	PA3686	791440049024	BF1177	791440050518	P7615	791440051904	BT8398-MPG	791440053267	PA3811-FN
791440046870	PA3687	791440049031	BF1178	791440050525	BT121	791440051973	BT8842-MPG	791440053274	PA3812
791440046917	BT8841-MPG	791440049048	BF1179	791440050532	PT8385	791440051980	RS3733	791440053281	BW5200
791440046924	PA2804	791440049086	BF1181	791440050549	BF1052	791440052000	BT8843-MPG	791440053298	BF7634
791440046955	BK6799	791440049093	PA2237	791440050563	BF1053	791440052031	BF7626	791440053304	BT8853-MPG
791440047020	B7099	791440049116	BF1182	791440050570	RS3521	791440052048	PF7627	791440053311	PA3814
791440047068	PA4075	791440049123	BF1184	791440050587	B1421	791440052079	PT8400-MPG	791440053328	PA3815
791440047082	P7102	791440049130	BF1185	791440050594	BT8386	791440052086	B7128	791440053366	BF1257
791440047112	PT8370-MPG	791440049147	BF1186	791440050600	PT7616	791440052123	BT8401-MPG	791440053373	BF7635
791440047129	PT8371-MPG	791440049222	PA4044	791440050617	PT7617	791440052178	PT8402-MPG	791440053489	PA2771
791440047150	PA3494	791440049239	PA4045	791440050624	BF1349	791440052192	PT8403-MPG	791440053557	PA2840
791440047167	G286-C	791440049246	PA4046	791440050662	PA3782	791440052208	RS3726	791440053571	PA2847
791440047174	BF1258	791440049277	PA3484	791440050679	PA3783	791440052215	PA3419	791440053588	PA2859-FN
791440047211	BK6583	791440049284	PA3483	791440050686	PT8387	791440052222	BF7628	791440053595	PA2862 FOAM
791440047228	PA3688	791440049307	RS3718	791440050693	PT8388	791440052239	RS3727	791440053601	PA2866
791440047501	RS3519	791440049314	RS3719	791440050822	BF1056	791440052246	RS3728	791440053618	PA2867-FN
791440047518	BD325	791440049321	RS3717	791440050846	B1422	791440052253	RS3729	791440053625	PA2870-FN
791440047525	PA3690	791440049338	PA4047	791440050907	PF7618	791440052277	BF7629	791440053656	PA2880
791440047532	PA4077	791440049345	PA4048	791440050921	PA3787	791440052284	PT8404-MPG	791440053663	PA2881
791440047549	PA3689	791440049352	AF521-WN	791440050938	PT7716	791440052291	BF7630	791440053694	PA2884
791440047556	P7103	791440049369	AF525-WN	791440050945	BT8391	791440052307	PA4099	791440053700	PA2885
791440047563	RS3712	791440049383	BF1215	791440050952	PA3786-FN	791440052314	RS3731	791440053717	PA2887-FN
791440047570	BF7598	791440049406	PA4049	791440050969	BF7619	791440052321	BF7631	791440053724	PA2888
791440047587	P7104	791440049413	BF1190	791440050983	BF1249	791440052338	BK6287	791440053731	PA2889
791440047594	BD1015	791440049420	BF1191	791440050990	RS3722	791440052345	PA3800	791440053748	PA2890
791440047600	P7106	791440049444	BF1193	791440051003	PT8392	791440052352	BF7632	791440053762	PA2895
791440047617	P7107	791440049468	BF1195	791440051041	BF1252	791440052437	BF7641	791440053779	PA2897
791440047655	PT8372	791440049529	BF1199	791440051089	BF1217	791440052444	PA4100	791440053809	PA2904
791440047662	BF7602	791440049536	PA4081	791440051096	BT8308-MPG KIT	791440052468	RS3721	791440053816	PA2905
791440047679	PA4078	791440049567	PA3773	791440051140	PA4088	791440052482	PA3802	791440053823	PA2906
791440047723	BF1100	791440049574	BF1045	791440051157	PA4089	791440052499	PA3803	791440053847	PA2909
791440047822	BF7606	791440049581	BF1046	791440051164	PA4090	791440052505	PA3804	791440053878	PA2912
791440047846	B7113	791440049598	BF1047	791440051171	BF1057	791440052529	V7129-C	791440053885	PA2913
791440047860	PA3697	791440049604	BF1048	791440051188	BF1058	791440052536	PA2871	791440053892	PA2914
791440047877	PA4079	791440049611	BF1049	791440051201	BF1061	791440052543	PA3805-FN	791440053908	PA2915
791440047884	18002	791440049628	BF1050	791440051218	PA4091	791440052550	RS3736	791440053939	PA2948
791440047907	18004	791440049642	PA3767	791440051225	BD7029	791440052567	RS3737	791440053946	PA2950
791440047938	18007	791440049659	PA3768	791440051256	ES1376	791440052581	BW5142	791440053953	PA2953
791440047952	18009	791440049666	RS3716	791440051294	RS3724	791440052598	RS3735	791440053960	PA2954-FN
791440047969	18010	791440049680	BT8381	791440051300	BF7124	791440052604	B7130	791440053977	PA2958
791440047990	18013	791440049703	RS3720	791440051317	PA2813	791440052611	BF7131	791440053984	PA2962
791440048089	PA3691	791440049734	PA2240	791440051324	PT7126	791440052628	BF7645	791440053991	PA2964
791440048140	PT8375-MPG	791440049741	PA2241	791440051331	18025	791440052666	BF1249-SP	791440054004	PA2967
791440048157	PT8376-MPG	791440049765	PA2243	791440051348	18024	791440052673	PA2961-FN	791440054028	PA2970
791440048171	PA3698	791440049772	PA2244	791440051355	18022	791440052680	PA2877-FN	791440054035	PA2971
791440048188	RS3714	791440049871	BF1008	791440051379	18027	791440052697	PA2959-FN	791440054066	PA2976-FN
791440048195	B7001	791440050044	PA4084	791440051393	B7125	791440052703	PA2960	791440054073	PA2980
791440048201	PA3699	791440050051	PA3774	791440051409	PA4092	791440052710	PA2957	791440054097	PA2982
791440048232	RS3715	791440050068	PA3775	791440051416	PA3785-FN	791440052727	PA2956-FN	791440054141	PA3405
791440048263	P7114	791440050105	BT8382	791440051454	BT8393	791440052734	RS3734	791440054158	PA3411-FN
791440048485	PA3752	791440050129	PT8383	791440051478	PT7127	791440052741	BF7644	791440054165	PA3414
791440048492	PA3753	791440050136	P1418	791440051492	BF7623	791440052758	18029	791440054172	PA3415
791440048508	PA3754	791440050143	P1419	791440051508	SA2047	791440052772	PA3801-FN	791440054189	PA3416
791440048614	PA3755	791440050211	CTK5029-4	791440051515	BF1253	791440052857	RS3738	791440054196	PA3417
791440048621	PA3756	791440050235	PA3777	791440051546	PA3790	791440052864	RS3739	791440054233	B7033
791440048638	PA3757	791440050259	PA3778	791440051553	PT8394-MPG	791440052918	P127	791440054240	B7034
791440048645	PA3758	791440050266	BF1172	791440051560	PA3791-FN	791440052949	F594-F	791440054264	BF7537
791440048652	PA3759	791440050273	PA2977-FN	791440051577	PA3792	791440052970	PT682	791440054271	ES24-D
791440048669	PA3760	791440050297	B7119	791440051607	PA3794	791440052987	PT683	791440054288	G103-N
791440048676	PT8378-MPG	791440050303	PA4085	791440051621	PT8395	791440053007	F950-F WO	791440054325	P7134
791440048683	PA3761-FN	791440050310	PA3779-FN	791440051638	PT8396	791440053014	F953-F	791440054363	BF7135
791440048706	B7026-MPG	791440050327	BF1240	791440051645	PA2942	791440053021	PF997	791440054370	RS3743
791440048720	B7116	791440050334	BT8384	791440051652	BT8848-MPG	791440053038	PA3808-FN	791440054394	PA3822
791440048737	PA3763	791440050341	B495-SS	791440051669	BF7624	791440053045	PA3809	791440054400	PA3823
791440048768	RS3531	791440050358	RS3713	791440051676	P7607	791440053052	PA3806	791440054417	PA3824
791440048775	BT8876-MPG	791440050365	PA3780	791440051713	PA3796	791440053069	BF7648	791440054424	BT8412
791440048805	PA3765	791440050389	B96-SS	791440051720	PA3797	791440053076	PT8407	791440054431	BF7639
791440048812	PA3766	791440050396	B95-SS	791440051737	PA4093	791440053083	PT8408	791440054462	BF7656
791440048829	B7117	791440050402	BD103-SS	791440051744	PA4094	791440053090	PA4101	791440054516	PA4103
791440048836	PA2951	791440050419	B99-SS	791440051751	PA3795	791440053106	PA3810	791440054523	PA3832
791440048850	PA2952	791440050426	B76-SS	791440051775	BF7625	791440053113	BF7633	791440054530	BF1256
791440048881	PA2235	791440050433	B7600-SS	791440051782	B1425	791440053120	P7132	791440054561	PA3833
791440048898	BF1174	791440050457	BF7612	791440051805	PT8380	791440053137	PA4102	791440054578	PF7678
791440048911	BF7522	791440050464	BF7613	791440051850	BT8397-MPG	791440053175	RS3740	791440054585	PA3834



WARNING: These products can expose you to chemicals, including Diisononyl Phthalate, Carbon black extracts, Nickel, 1,3 Butadiene, Ethylene Oxide, Epichlorohydrin, which are known to the State of California to cause cancer, and Bisphenol-A, Ethylene Glycol, Ethylene Oxide, 1,3 Butadiene, Epichlorohydrin, which are known to the State of California to cause birth defects or other reproductive harm. For more information go to www.P65Warnings.ca.gov.

UPC TO BALDWIN (INDIVIDUAL PARTS)

UPC NUMBER	BALDWIN NUMBER	UPC NUMBER	BALDWIN NUMBER	UPC NUMBER	BALDWIN NUMBER	UPC NUMBER	BALDWIN NUMBER	UPC NUMBER	BALDWIN NUMBER
791440054592	PA3835	791440056077	RS3885	791440057388	OP8709	791440058491	PA3928	791440059658	BF7683
791440054608	PT136	791440056084	PA4111	791440057395	OB8773	791440058507	BF7686	791440059665	BF7696
791440054615	P7137	791440056091	PA3881	791440057401	BW5201	791440058521	PF7687	791440059733	BF1274-SP
791440054622	PA7138	791440056107	PA3886	791440057418	PA3900	791440058545	PA3929	791440059740	BF1274-SPS
791440054639	PA4104	791440056114	BT8418	791440057425	PA4112	791440058552	B7180	791440059757	18055
791440054646	PA1105	791440056121	BF7671	791440057432	PA3901	791440058569	BT8432-MPG	791440059764	18056
791440054653	PA4106	791440056138	BK6704	791440057456	RS3764	791440058576	BF7690	791440059771	18057
791440054660	PA4107	791440056145	BK6705	791440057463	RS3826	791440058583	PT8433-MPG	791440059788	BT8445
791440054677	B7139	791440056183	BT8880-MPG	791440057470	RS3827	791440058590	PA3819	791440059795	PT8446-MPG
791440054691	B1416	791440056190	PT8419	791440057487	PF7655	791440058613	PA3820-FN	791440059801	PA3956
791440054707	RS3744	791440056206	18033	791440057494	B7156	791440058620	PA3816	791440059849	PA4126
791440054714	RS3745	791440056213	18034	791440057500	BF7668	791440058644	BD7168	791440059856	BF1271
791440054738	PA3807	791440056220	PA3887	791440057517	BT8421-MPG	791440058651	PA3925	791440059863	PA3957
791440054752	BK6595	791440056237	RS3888	791440057524	BT8422-MPG	791440058668	BD7169	791440059870	PT8447-MPG
791440054813	PA3843	791440056244	PA3889	791440057531	BT8423	791440058675	RS3930	791440059887	P8448
791440054837	BF7639-D	791440056251	BF7640	791440057548	PA3902	791440058705	PA3932	791440059900	PF7698
791440054844	PT691	791440056268	BF7653	791440057555	PA3903	791440058712	PA3933	791440059917	BF7697
791440054875	BF1261	791440056282	PA3890	791440057562	PA3904	791440058729	BF1266	791440059924	PA4127
791440054899	BD1403	791440056343	PA3891	791440057579	PA3905	791440058736	PA3931	791440059948	PA3958
791440054905	BF7658	791440056350	PA3838	791440057586	PA3906	791440058743	B1438	791440059955	PA3961
791440054912	BF7659	791440056367	PA3844	791440057593	BW5086	791440058750	B7170	791440060005	BT8449
791440054936	BF7661	791440056381	PA3847	791440057661	PA3908	791440058767	B7171	791440060012	BT8449-10
791440054950	PA4108	791440056398	PA3848-FN	791440057678	PA3909	791440058781	BF1267	791440060029	PA3959
791440054967	PA4109	791440056404	PA3849	791440057760	B7157	791440058798	PT8435-MPG	791440060036	BF5815
791440054974	BF7663	791440056411	PA3850	791440057777	PA3910-FN	791440058804	PT8436	791440060050	BW5250
791440054981	BF7664	791440056428	PA3851	791440057784	PA3911	791440058811	BT8437	791440060074	BA3964(4)
791440055001	PT8414-MPG	791440056435	PA3852-FN	791440057791	PA3907	791440058842	PKG411	791440060081	BA3965(4)
791440055032	BF7657	791440056442	PA3853-FN	791440057838	PA3914	791440058859	PKG412	791440060098	PA3966
791440055049	PA3836	791440056459	PA3854-FN	791440057845	PA3915	791440058866	BF7691	791440060104	BT8450
791440055056	BF7666	791440056466	PA3855-FN	791440057852	BD7158	791440058873	RS3934	791440060111	PA3967
791440055070	PA3839	791440056503	PA3859	791440057869	PT8425	791440058880	RS3935	791440060135	PT8451-MPG
791440055087	PA3840	791440056510	PA3860	791440057890	PA4113	791440058897	BF7693	791440060142	BD7176
791440055094	BD7141	791440056527	PA3861	791440057906	BF1282	791440058903	RS3936	791440060159	PT8452
791440055100	BT8416	791440056534	PA3862-FN	791440057913	BT8805-MPG	791440058910	B1435	791440060166	PA3969
791440055117	BF7667	791440056541	PA3863	791440057937	BT8426-MPG	791440058941	BD7309	791440060173	PA3970
791440055124	B7142	791440056558	PA3864	791440057944	PA3916	791440058996	P1440	791440060197	PA3972
791440055131	PA4110	791440056565	PA3865	791440057951	BD7159	791440059016	PA3951	791440060203	PA3973
791440055148	RS3747	791440056589	P1433	791440057968	BD7160	791440059023	BF1268	791440060210	B7177
791440055155	PA3867	791440056619	PT145	791440058002	B7162	791440059030	BT8440-MPG	791440060227	RS3974
791440055162	PA3868	791440056633	BK6195	791440058019	B7163	791440059047	PA3937	791440060234	RS3975
791440055179	RS3870	791440056640	BK6196	791440058026	B7164	791440059061	BT8439-MPG	791440060265	PA3978
791440055186	RS3871	791440056657	RS3750	791440058033	BF1330-SP	791440059078	PA3938	791440060272	PA3979
791440055193	RS3749	791440056701	PA2968-FN	791440058057	B7165	791440059085	PA4120	791440060289	P7178
791440055209	RS3746	791440056732	BF1277-SP	791440058064	PA3869	791440059092	G293-B	791440060296	B7179
791440055230	PA3874	791440056749	BF1273-SP	791440058071	PA3825	791440059122	ES1031	791440060319	PA4128
791440055353	OB8711	791440056756	PA3892	791440058088	PA3828	791440059146	G225-AF	791440060326	PA4129
791440055360	OB8712	791440056763	PA3893	791440058095	PA3829	791440059153	G472-AF	791440060333	RS4130
791440055445	OB8720	791440056770	PA3876	791440058101	PA4114	791440059160	PA4111	791440060340	PT8453
791440055452	OB8721	791440056817	BF1262	791440058118	PA3917	791440059177	PT8441	791440060357	PA3980
791440055469	OB8722	791440056824	RS3732	791440058125	B7161	791440059283	BF7695	791440060364	RS4131
791440055483	OB8724	791440056848	B7151	791440058149	BD7166	791440059290	BF1269	791440060371	18264
791440055728	18032	791440056855	B7152	791440058163	BT8833	791440059320	PA4121	791440060388	18265
791440055735	BT8849-MPG	791440056886	BD7153	791440058170	PT8427	791440059337	BF1277-SPS	791440060418	100-21AL
791440055742	BT8855-MPG	791440056893	BD7154	791440058187	PT8410	791440059351	PA3939	791440060449	PA4132
791440055759	BT8877-MPG	791440056909	PA3894	791440058194	PT8411	791440059368	RS3940	791440060456	18267
791440055766	BT8878-MPG	791440056923	PA3895-FN	791440058200	PA3821	791440059375	BF1270-SP	791440060470	BF7713
791440055773	BT8879-MPG	791440056930	B7155	791440058217	PA3818-FN	791440059382	PT8442	791440060487	PA4133
791440055803	PA3633 FOAM	791440056954	PA3896	791440058224	PA3817	791440059399	PA3941	791440060494	PF7715
791440055810	B7143	791440056961	PA3898	791440058231	BT287-3	791440059412	BC7173	791440060500	PF7716
791440055827	PA3877	791440056978	PA3899	791440058248	BT8428-MPG	791440059429	RS3942	791440060517	BF7717
791440055834	PA3878	791440056985	BT8420	791440058262	B5087	791440059436	RS3943	791440060548	BT8800-MPG
791440055841	PA3879-FN	791440057005	PA3897	791440058279	B5088	791440059443	PA3944	791440060555	BT8801-MPG
791440055858	BF7669	791440057029	BW5143	791440058286	BF1265	791440059450	PA3945	791440060616	PT8455-MPG
791440055865	B1431	791440057036	PF7680	791440058293	PA3918	791440059467	PA3946	791440060623	PA3983-FN
791440055872	BT8417	791440057067	OB8731	791440058309	PA3919	791440059474	PA3948	791440060647	PF7718
791440055889	BT8415	791440057074	OB8732	791440058316	BT8429	791440059498	PA3953	791440060654	B1441
791440055896	BT8413	791440057128	OB8743	791440058354	RS3920	791440059504	BT8443	791440060678	P1443
791440055919	B1432	791440057135	OB8741	791440058361	RS3921	791440059511	PA3950	791440060685	BD7310
791440055926	PA3872	791440057142	OB8742	791440058378	RS3922	791440059528	CTK5029-1	791440060692	PT8456-MPG
791440055933	PA3873	791440057173	OB8744	791440058385	RS3923	791440059559	PA4123	791440060715	BF7711
791440055940	BF7670	791440057180	OB8745	791440058392	B7685	791440059566	PA4124	791440060739	B7181
791440055957	B7144	791440057197	OB8771	791440058408	B7175	791440059573	BT8856-MPG	791440060753	BT8457-MPG
791440056022	PA3875-FN	791440057203	OB8772	791440058415	PA3924-FN	791440059597	RS3952	791440060760	PA3949
791440056039	PA3880	791440057326	OV8700	791440058422	RS3926	791440059603	RS3954	791440060777	PA3985
791440056046	RS3882	791440057333	OV8701	791440058439	RS3927	791440059610	BT8444	791440060784	PT8458-MPG
791440056053	RS3883	791440057357	OS8703	791440058446	B7167	791440059634	BT8847	791440060791	PA3984
791440056060	RS3884	791440057364	OS8704	791440058477	B1434	791440059641	B7172	791440060845	B7182



WARNING: These products can expose you to chemicals, including Diisononyl Phthalate, Carbon black extracts, Nickel, 1,3 Butadiene, Ethylene Oxide, Epichlorohydrin, which are known to the State of California to cause cancer, and Bisphenol-A, Ethylene Glycol, Ethylene Oxide, 1,3 Butadiene, Epichlorohydrin, which are known to the State of California to cause birth defects or other reproductive harm. For more information go to www.P65Warnings.ca.gov.

UPC TO BALDWIN (INDIVIDUAL PARTS)

UPC NUMBER	BALDWIN NUMBER	UPC NUMBER	BALDWIN NUMBER	UPC NUMBER	BALDWIN NUMBER	UPC NUMBER	BALDWIN NUMBER	UPC NUMBER	BALDWIN NUMBER
791440060852	B7189	791440062139	BT8488	791440063556	PKG470-DVD	791440064935	PT8883	791440065888	PA4163
791440060869	PA4134	791440062146	BC7194	791440063570	PKG470-S	791440064942	P7232	791440065895	PA4652
791440060883	PT8459	791440062153	PA4566	791440063587	RS4595	791440064966	PA4627	791440065956	BK6675
791440060913	G369-B	791440062160	PT8489	791440063600	BT8509-MPG	791440064973	BF7803	791440065963	BK6676
791440060920	PA3986	791440062177	PA4567	791440063617	BT8505	791440064980	BF7804	791440065987	G704
791440060937	PA3987	791440062214	P7195	791440063631	H9052	791440064997	BF7805	791440065994	G710
791440060944	RS3988	791440062221	PT8490-MPG	791440063648	RS4598	791440065000	BF7806	791440066007	G369-V
791440060968	RS3990	791440062238	PA4145	791440063655	RS4599	791440065017	P7233	791440066014	BF1346-SP
791440060975	RS3992	791440062252	H9087	791440063662	BT8510-MPG	791440065031	BF7808	791440066045	BK6693
791440060982	RS3994	791440062276	BF7736	791440063679	BF7753	791440065048	PA4156 KIT	791440066052	BF1286
791440060999	RS3996	791440062283	PT8491	791440063709	PA4600	791440065055	PA4157	791440066069	PT8894-MPG
791440061002	RS3998	791440062290	PT8492	791440063716	PA4601	791440065062	BF1350-SP	791440066076	PT8895-MPG
791440061026	RS3991	791440062320	BT8834-MPG	791440063730	BF7756	791440065079	BF7809	791440066083	PA4164
791440061033	PA3989-FN	791440062375	BT8493	791440063747	PA4602	791440065086	P7235	791440066090	PA4165
791440061040	RS3999	791440062382	PA4570	791440063761	B7219	791440065093	PT8884-MPG	791440066106	PA4653
791440061057	BK6686	791440062399	P7196	791440063785	BF1275	791440065130	PF7812 KIT	791440066113	PT8896
791440061064	P7183	791440062474	B495-MPG	791440063792	RS4597	791440065147	PT8519-MPG	791440066120	BK6440
791440061088	BF7719	791440062504	PT8494	791440063808	PA4604-FN	791440065154	BF7766	791440066144	BF7769
791440061095	RS3971	791440062511	PF1291	791440063815	PA4605	791440065161	PT8885-MPG	791440066151	PA4654 KIT
791440061101	BF7720	791440062528	PA4146	791440063822	PA4606	791440065178	PA4628	791440066168	PF7770
791440061125	PA4138	791440062535	PA4147	791440063839	PF7758	791440065192	BT8886-MPG	791440066182	PA4655
791440061132	BF7721	791440062542	PA4148	791440063853	PA4608	791440065215	RS4629	791440066212	PT8897-MPG
791440061163	BF7725	791440062559	B1446	791440063877	B7220	791440065246	RS4623	791440066229	BC7242
791440061194	SA4141	791440062566	BK6694	791440063884	BK6683	791440065253	PA4158	791440066236	BT8898
791440061231	PA4551	791440062573	G717	791440063891	PA4611	791440065284	PA4631-FN	791440066243	BT8899
791440061248	PA4552	791440062580	V1560	791440063907	B7221	791440065314	BF7813	791440066250	PT8517-MPG
791440061262	B7174-MPG	791440062597	RS4572	791440063914	B7222	791440065321	RS4634	791440066267	PA4656
791440061279	RS3993	791440062603	P7199	791440063921	PA4610 KIT	791440065338	PA4632	791440066274	BF7771
791440061286	RS3995	791440062634	PT8481	791440063938	PA4612	791440065345	PA4633	791440066281	PA4657
791440061293	RS3997	791440062658	BF7742	791440063952	PA4614	791440065352	BF7814	791440066298	BW5182
791440061330	PA2896	791440062665	PT8495-MPG	791440063969	BF7760	791440065369	RS4636	791440066304	BT8900
791440061354	PA4553	791440062788	PT8496-MPG	791440063976	PT8461	791440065376	RS4637	791440066328	PA4659
791440061361	PA4554	791440062801	PF7744	791440064027	BF7759	791440065383	B7238	791440066335	PA4660
791440061378	PA4555	791440062832	PA4573	791440064034	B7197	791440065390	RS4638	791440066359	OS8707
791440061392	PA4557	791440062849	PA4574	791440064041	RS4616	791440065406	PA4159	791440066366	B7243
791440061408	BF7726	791440062856	BT8497-MPG	791440064058	RS4617	791440065413	PA4635	791440066380	BF7681-D
791440061415	PT8462-MPG	791440062870	RS4576	791440064065	B5144	791440065420	PF7755	791440066397	BF7679-D
791440061439	PT8468	791440062887	RS4577	791440064072	BF1278	791440065437	BF1339-SP	791440066403	BF7672-D
791440061460	PT8470	791440062900	RS4578	791440064089	BF1279	791440065444	PA4160	791440066410	BF7682-D
791440061477	P7185	791440062917	PT8498	791440064157	BF7762	791440065451	RS4161	791440066427	BF7675-D
791440061484	BT8471-MPG	791440062924	PA4571	791440064164	B7223	791440065468	PT8887	791440066434	BF7673-D
791440061491	BT8472	791440062931	BT8460	791440064225	BK6903	791440065475	B7239	791440066441	BF7674-D
791440061507	BT8473	791440062955	PF7751	791440064287	BF7763	791440065482	B10-AL BSP	791440066458	BF7677-D
791440061514	BT8474	791440062979	BK6341	791440064317	PA4151	791440065499	B7240	791440066465	BF7746-D
791440061521	BT8475	791440062993	B7215	791440064355	BK6467	791440065505	PT8888	791440066472	BF7745-D
791440061538	BT8476	791440063006	BT8499	791440064386	RS4618	791440065512	RS4639	791440066489	BF7699-D
791440061545	BT8477	791440063020	BK6686	791440064393	RS4613	791440065529	PT8511	791440066496	BT8901-MPG
791440061552	BT8463-MPG	791440063051	BT8501-MPG	791440064409	RS4620	791440065536	PA4162	791440066502	BK6934
791440061569	BT8464	791440063082	PA4149 KIT	791440064416	RS4621	791440065543	PF7767	791440066517	CA4700
791440061576	BT8465	791440063099	BT8502	791440064423	RS4622	791440065550	PA4630	791440066524	PA4701
791440061606	PT8478	791440063105	B7216	791440064430	B7224	791440065557	PA4641	791440066539	BF7772
791440061613	BC7186 KIT	791440063112	B7217	791440064478	B7225	791440065581	RS4642	791440066601	PA4665-FN
791440061637	PT8479	791440063129	RS4579	791440064485	BF7765	791440065598	RS4643	791440066618	PA4666
791440061644	PT8480	791440063136	RS4580	791440064492	PA4152	791440065604	PT8889	791440066649	BT8902
791440061651	B1444	791440063143	PA4581	791440064508	PA4153	791440065611	PA4644	791440066656	PA4166
791440061736	B7187	791440063150	PA4582	791440064515	PA4154	791440065628	PA4645-FN	791440066663	BT8903
791440061859	PF7733	791440063167	BT8503-MPG	791440064553	19996	791440065635	RS4646	791440066670	BT8904-MPG
791440061866	PF7734	791440063174	BT8504	791440064584	19999	791440065642	PA4647	791440066694	BF7773
791440061880	PA4559	791440063181	PA4583-FN	791440064591	20000	791440065659	PA4648	791440066700	BF7774
791440061897	PT8484	791440063204	BF7747	791440064614	20002	791440065666	PA4649	791440066717	PA4704
791440061910	PA4560	791440063211	PF7748	791440064621	B7227	791440065673	B5090	791440066724	CA4702
791440061927	PF7735	791440063228	PF7749	791440064645	BC7228	791440065680	B7241	791440066731	CA4703
791440061934	PA3435-FN	791440063273	BF7750	791440064652	PA4628	791440065697	BT8890-MPG	791440066748	ES3231
791440061941	P7188	791440063280	BF1283	791440064669	PA4625	791440065727	PA4650-FN	791440066755	B7299
791440061958	RS4561	791440063297	BF1281	791440064683	B7229	791440065734	PT8891-MPG	791440066762	PA4167
791440061965	PA4144	791440063303	G725	791440064690	PA4619	791440065741	BT8892-MPG	791440066779	B7245
791440061972	P7190	791440063327	PA4585	791440064768	PF7799	791440065758	PA4651	791440066830	B7700
791440061989	RS4562	791440063334	RS4549	791440064775	BF7800	791440065765	20003	791440066847	PA4661
791440062016	RS4563	791440063341	PA4548	791440064782	BF7801	791440065796	20004	791440066854	PA4662
791440062023	RS4564	791440063440	B5089	791440064799	BF7802	791440065802	65-W30	791440066861	PA4663
791440062030	BK6215	791440063457	PA4592	791440064805	BF1285-SP	791440065819	75-W30	791440066878	PA4664
791440062047	B7191	791440063464	PA4150	791440064836	BT8512	791440065826	100-W30	791440066885	PA4668
791440062054	PT8485	791440063471	PA4593	791440064843	PF7761	791440065833	150-W30	791440066922	B5145
791440062078	P7192	791440063488	PA4594	791440064850	P7230	791440065840	300-W30	791440066953	BF7775
791440062092	P7193	791440063525	PT8506-MPG	791440064881	B7231	791440065857	66-30	791440066960	BF7776
791440062108	BT8486	791440063532	PT8507-MPG	791440064898	PA4603	791440065864	PT8893	791440066977	BF5816
791440062122	PT8487	791440063549	PKG470	791440064928	B1447	791440065871	BF7768	791440067004	PF7777



WARNING: These products can expose you to chemicals, including Diisononyl Phthalate, Carbon black extracts, Nickel, 1,3 Butadiene, Ethylene Oxide, Epichlorohydrin, which are known to the State of California to cause cancer, and Bisphenol-A, Ethylene Glycol, Ethylene Oxide, 1,3 Butadiene, Epichlorohydrin, which are known to the State of California to cause birth defects or other reproductive harm. For more information go to www.P65Warnings.ca.gov.

UPC TO BALDWIN (INDIVIDUAL PARTS)

UPC NUMBER	BALDWIN NUMBER	UPC NUMBER	BALDWIN NUMBER	UPC NUMBER	BALDWIN NUMBER	UPC NUMBER	BALDWIN NUMBER	UPC NUMBER	BALDWIN NUMBER
791440067011	BF7778	791440068131	PA4736 FOAM	791440069688	BT8476-MPG	791440070820	PT9145	791440072039	B7285
791440067028	BT8905	791440068148	PA4737	791440069695	BT366-MPG	791440070844	PT9147	791440072046	B7286
791440067035	B7246	791440068155	PA4738	791440069701	BT351-MPG	791440070851	PT9148	791440072053	B7287
791440067042	RS4672	791440068179	PA4740	791440069718	BT371-5	791440070868	PT9149	791440072077	B7289
791440067059	RS4673	791440068186	PA4741	791440069725	BT8914	791440070875	PT9150	791440072084	B7290
791440067066	PA4674-FN	791440068209	PA4743	791440069732	BT8915	791440070899	PT9152	791440072091	B7291
791440067073	PA4168	791440068278	PA4750	791440069749	BT8916	791440070905	PT9153	791440072107	B7292
791440067080	PF7779	791440068308	PA4753	791440069756	BT8917	791440070929	PT9155	791440072114	B7293
791440067103	BK6670	791440068315	PA4754	791440069763	BT8918	791440070943	PT9157	791440072121	B7294
791440067127	BT8906	791440068322	PA4755	791440069770	BT8919	791440070950	PT9158	791440072138	B7295
791440067134	PA4169	791440068339	PA4756	791440069787	BT8920	791440070981	PT9161	791440072169	OAS99001
791440067141	BF7780	791440068353	PA4758	791440069800	BT8922	791440070998	PT9162	791440072176	OAS99002
791440067158	PT8907-MPG	791440068377	PA4760	791440069848	BT8926	791440071001	PT9163	791440072183	OAS99003
791440067165	P7247	791440068407	PA4763	791440069855	BT8927	791440071018	BT9164	791440072190	OAS99004
791440067219	B7249-MPG	791440068414	PA4764	791440069862	BT8928	791440071025	PT9165	791440072206	OAS99005
791440067226	BT8908	791440068438	PA4766	791440069866	BT8930	791440071049	PT9167	791440072213	OAS99006
791440067233	BF7815	791440068469	PA4769	791440069893	BT8931	791440071056	PT9168	791440072237	OAS99008
791440067240	PT8909	791440068506	PA4773	791440069930	BT8935	791440071063	PT9169	791440072251	OAS99010
791440067264	RS4676	791440068520	RS4775	791440069954	BT8937	791440071070	PT9170	791440072299	OAS99014
791440067271	RS4677	791440068568	PA4778	791440069978	PT8939-MPG	791440071087	PT9171	791440072305	OAS99015
791440067288	RS4678	791440068599	PA4781	791440069985	PT8940-MPG	791440071094	PT9172	791440072329	OAS99017
791440067295	RS4679	791440068711	PA4793	791440069992	PT8941-MPG	791440071117	PT9174	791440072336	OAS99018
791440067301	BT8910-MPG	791440068728	RS4794	791440070011	PT8943-MPG	791440071124	PT9175	791440072350	OAS99020
791440067318	BT8911-MPG	791440068735	PA4795	791440070035	PT8945-MPG	791440071131	PT9176	791440072381	OAS99023
791440067325	RS4680	791440068803	PA4802	791440070042	PT8946-MPG	791440071155	PT9178	791440072398	OAS99024
791440067363	PA4681	791440068810	RS4803	791440070059	PT8947-MPG	791440071162	PT9179	791440072404	OAS99025
791440067370	20005	791440068827	RS4804	791440070066	PT8948-MPG	791440071179	PT9180	791440072435	OAS99028
791440067387	BD7250	791440068841	RS4806	791440070080	PT8950-MPG	791440071186	PT9181	791440072442	OAS99029
791440067394	BD7252	791440068858	RS4807	791440070097	PT8951-MPG	791440071209	PT9183	791440072497	PF7852 KIT
791440067400	PT8912	791440068872	PA4809	791440070103	PT8952-MPG	791440071223	PT9185	791440072503	PA4857
791440067424	PA4682	791440068919	PA4813	791440070127	PT8954-MPG	791440071230	PT9186	791440072510	BK6183
791440067431	PKG475	791440068971	PA4819	791440070134	PT8955-MPG	791440071247	PT9187	791440072527	PA4858
791440067448	PKG475-S	791440068988	PA4820	791440070141	PT8956-MPG	791440071254	PT9188	791440072534	BF7853
791440067455	BK6184	791440069015	PA4823	791440070158	PT8957-MPG	791440071261	PT9189	791440072541	RS4859
791440067462	BF1353-SPS	791440069022	PA4824	791440070165	PT8958-MPG	791440071285	PT9191	791440072558	PA4860
791440067486	PF7782	791440069039	PA4825	791440070172	PT8959-MPG	791440071308	PT9193	791440072565	RS4862
791440067493	BF7783-D	791440069053	PA4827	791440070189	PT8960-MPG	791440071322	PT9195	791440072572	RS4863
791440067509	BF7784-D	791440069077	PA4829	791440070219	PT8962-MPG	791440071339	PT9196	791440072596	BK6665
791440067516	BF7785-D	791440069084	PA4830	791440070264	PT8967-MPG	791440071346	PT9197	791440072602	PA4170
791440067523	PA4683	791440069107	PA4833-FN	791440070288	PT8969-MPG	791440071360	PT9199	791440072626	PA4877
791440067530	BF7786-D	791440069114	PA4834-FN	791440070295	PT8970-MPG	791440071377	PT9200	791440072633	PA4878
791440067547	PA4852	791440069251	PA4848	791440070301	PT8971-MPG	791440071407	PT9203	791440072640	PA4879
791440067554	PA4852 FOAM	791440069299	PF7787	791440070318	PT8972-MPG	791440071421	PT9205	791440072664	PA4881
791440067561	PA4853	791440069305	PF7788	791440070332	PT8974-MPG	791440071452	PT9208	791440072688	PA4883
791440067578	PA4854	791440069312	PF7816	791440070349	PT8975-MPG	791440071469	PT9209	791440072701	PA4885
791440067592	PA4855	791440069329	PF7817	791440070370	PT8978-MPG	791440071476	PT9210	791440071476	PA4886
791440067639	PA4689	791440069336	PF7818	791440070394	PT8980-MPG	791440071490	PT9212	791440072725	PA4887
791440067646	PA2068 FOAM	791440069343	PF7819	791440070400	PT8981-MPG	791440071513	PT9214	791440072732	PA4888
791440067653	PA2223 FOAM	791440069350	PF7820	791440070417	PT8982-MPG	791440071520	PT9215	791440072749	PA4889
791440067660	PA3901 FOAM	791440069367	BF7821	791440070431	PT8984-MPG	791440071544	PT9217	791440072756	PA4890
791440067691	PA3472	791440069374	PF7822	791440070448	PT8985-MPG	791440071582	PT9221	791440072763	PA4891
791440067745	PA4692	791440069381	PF7823	791440070455	PT8986-MPG	791440071599	PT9222	791440072787	PA4893
791440067752	PA4693	791440069398	PF7824	791440070462	PT8987-MPG	791440071605	PT9223	791440072800	PA4895
791440067769	PA4694	791440069404	PF7825	791440070486	PT8989-MPG	791440071612	PT9224	791440072817	PA4896
791440067776	PA4695	791440069411	PF7826	791440070493	PT8990-MPG	791440071629	PT9225	791440072824	PA4897
791440067783	PA4696 FOAM	791440069428	PF7828	791440070509	PT8991-MPG	791440071643	PT9227	791440072848	PA4900
791440067790	PA4697-FN	791440069442	PF7830	791440070516	PT8992-MPG	791440071650	PT9228	791440072862	PA4902
791440067806	PA4698	791440069466	PF7832	791440070523	PT8993-MPG	791440071681	H9231	791440072879	PA4903
791440067820	PA4705	791440069473	PF7833	791440070530	PT8994-MPG	791440071735	P7255	791440072893	PA4905
791440067837	PA4706	791440069480	PF7834	791440070547	PT8995-MPG	791440071742	P7256	791440072909	PA4906
791440067844	PA4707	791440069503	PF7836	791440070554	PT8996-MPG	791440071773	PT259	791440072916	PA4907
791440067851	PA4708	791440069510	BF7837	791440070561	PT8997-MPG	791440071780	PT260	791440072923	PA4908
791440067868	PA4709	791440069527	BF7838	791440070578	PT8998-MPG	791440071810	PT263	791440072947	PA4910
791440067882	PA4711	791440069534	BF7839	791440070585	PT8999-MPG	791440071827	PT264	791440072954	PA4911
791440067905	PA4713	791440069541	BF7840	791440070646	PT9127	791440071858	PT267	791440073029	PA4918
791440067912	PA4714	791440069558	BF7841	791440070660	PT9129	791440071865	PT268	791440073036	PA4919
791440067929	PA4715	791440069565	BF7842	791440070684	PT9131	791440071872	P7269	791440073098	PA4925
791440067936	PA4716	791440069572	BF7843	791440070691	PT9132	791440071889	BF7880	791440073128	PA4928
791440067974	PA4720	791440069589	BF7844	791440070714	PT9134	791440071896	B7271	791440073135	PA4929
791440068001	PA4723	791440069596	BF7845	791440070721	PT9135	791440071919	B7273	791440073142	PA4930
791440068049	PA4727	791440069619	BF7847	791440070738	PT9136	791440071926	B7274	791440073159	PA4931
791440068070	PA4730	791440069626	BF7848	791440070745	PT9137	791440071933	B7275	791440073166	PA4932
791440068087	PA4731	791440069633	BF7849	791440070769	PT9139	791440071940	B7276	791440073180	PA4934
791440068094	PA4732	791440069640	BF7850	791440070776	PT9140	791440071957	B7277	791440073197	PA4935
791440068100	PA4733	791440069657	BF7851	791440070790	PT9142	791440071988	B7280	791440073227	PA4938
791440068117	PA4734	791440069664	BF7736-K1	791440070806	PT9143	791440071995	B7281	791440073234	PA4939
791440068124	PA4735	791440069671	BT8913-MPG	791440070813	PT9144	791440072015	B7283	791440073265	PA4942



WARNING: These products can expose you to chemicals, including Diisononyl Phthalate, Carbon black extracts, Nickel, 1,3 Butadiene, Ethylene Oxide, Epichlorohydrin, which are known to the State of California to cause cancer, and Bisphenol-A, Ethylene Glycol, Ethylene Oxide, 1,3 Butadiene, Epichlorohydrin, which are known to the State of California to cause birth defects or other reproductive harm. For more information go to www.P65Warnings.ca.gov.

UPC TO BALDWIN (INDIVIDUAL PARTS)

UPC NUMBER	BALDWIN NUMBER	UPC NUMBER	BALDWIN NUMBER	UPC NUMBER	BALDWIN NUMBER	UPC NUMBER	BALDWIN NUMBER	UPC NUMBER	BALDWIN NUMBER
791440073333	PA4865-FN	791440074613	BF7859	791440076372	PA4985	791440077379	BF7903	791440078499	BF1362
791440073340	PA4870-FN	791440074620	BF7860	791440076389	PA4986	791440077386	BF7904-D	791440078505	BT9368-MPG
791440073357	PA4871	791440074637	BF7861	791440076396	PA4987	791440077393	BF7906	791440078512	BT9369-MPG
791440073364	PA4872	791440074644	BF7863	791440076419	BF1355-SP	791440077409	BT9353-MPG	791440078529	BC7326
791440073371	PA4873	791440074651	BF7864	791440076433	BF7886	791440077416	BF7905-D	791440078536	PF7916
791440073388	PA4874	791440074668	BF7865	791440076440	PKG475-R	791440077423	BF7906-D	791440078543	PA5336
791440073401	PA4876	791440074675	BF7866	791440076464	P7308	791440077430	BF7907	791440078550	BF7917
791440073418	PA3957 FOAM	791440074705	B7298	791440076488	BF5587-D	791440077447	FB1306	791440078567	B7327
791440073425	PA2069 FOAM	791440074743	P7303	791440076495	BK6658	791440077454	PA5315	791440078574	BT9370-MPG
791440073432	PA2067 FOAM	791440074774	OAS99034	791440076501	BK6659	791440077461	PA5316	791440078598	BK6464
791440073463	RS4864	791440074781	OAS99035	791440076518	RS4988	791440077478	PA5317	791440078604	BF1355
791440073470	RS4861	791440074811	OAS99038	791440076525	PT9341	791440077485	PT9354-MPG	791440078611	BF1363
791440073531	BT9316-MPG	791440074927	PA4171	791440076532	B7311-MPG	791440077492	PA5318	791440078635	PA5337
791440073548	BT8475-MPG	791440075009	BT9318	791440076549	P7312	791440077508	PA5319	791440078642	PA5338-FN
791440073555	BT8477-MPG	791440075016	H9327	791440076563	RS4989	791440077515	PA5320	791440078659	B7328
791440073579	BT9320	791440075023	PT9328-MPG	791440076570	P7313	791440077522	PA5321	791440078666	PA4178
791440073586	BT9321	791440075030	P7305	791440076587	PT9342-MPG	791440077539	H9075-V	791440078673	PA4179
791440073616	BT9324	791440075047	PF7878	791440076594	PA4991	791440077553	BF7908	791440078680	PA4180
791440073630	BT9326	791440075054	PA4960-FN	791440076600	PF7889	791440077560	BF7909	791440078697	PA4181
791440073647	PT9282-MPG	791440075078	PA4961	791440076617	PF7889-10	791440077577	PT9355-MPG	791440078703	PA4182
791440073654	PT9283-MPG	791440075092	PA4912	791440076624	PF7889-30	791440077584	PF7910	791440078710	PA4183
791440073661	PT9284-MPG	791440075108	PA4945	791440076631	PF7890	791440077621	H9043-V	791440078727	BT9371-MPG
791440073685	PT9286-MPG	791440075207	PA4955	791440076648	PF7890-10	791440077652	BT9356	791440078741	RS5334
791440073692	PT9287-MPG	791440075214	PA4956	791440076655	PF7890-30	791440077669	PA5323	791440078758	BF1365
791440073708	PT9288-MPG	791440075245	PT9329	791440076662	BT9343-MPG	791440077676	B7324	791440078796	PT9372
791440073715	PT9289-MPG	791440075252	RS4959	791440076679	RS4992	791440077683	PT9357	791440078819	BF7919
791440073722	PT9290-MPG	791440075269	RS4962	791440076686	RS4994	791440077690	PF7977	791440078840	BA5374
791440073739	PT9291-MPG	791440075276	RS4963	791440076693	RS4995	791440077706	PA5324-FN	791440078857	BA5375
791440073760	PT9293-MPG	791440075283	RS4966	791440076723	BF7798-SP	791440077713	RS5325	791440078864	BA5376
791440073791	PT9296-MPG	791440075290	RS4967	791440076730	PT9344	791440077720	PA5326	791440078871	PA5339
791440073807	PT9297-MPG	791440075306	RS4968	791440076747	B7314	791440077744	BD7325	791440078888	PT9374
791440073838	PT9300-MPG	791440075313	RS4969	791440076754	BF1356	791440077753	BF1359-SP	791440078895	PA5340
791440073869	PT9303-MPG	791440075320	RS4970	791440076761	PA4172	791440077782	20006	791440078901	BF7921
791440073876	PT9304-MPG	791440075337	RS4971	791440076785	RS4993	791440077799	20007	791440078918	PA5341
791440073890	PT9306-MPG	791440075344	RS4972	791440076792	BT9345	791440077805	20008	791440078932	PT9375
791440073906	PT9307-MPG	791440075351	P1561	791440076808	CA4999	791440077829	20010	791440078949	PT9376
791440073913	PT9308-MPG	791440075368	P1562	791440076815	BT9346-MPG	791440077836	20011	791440078956	BT9377
791440073920	PT9309-MPG	791440075375	P1563	791440076822	PT9347-MPG	791440077843	BK6426	791440078963	P7329
791440073937	PT9310-MPG	791440075399	P1565	791440076839	PT9348-MPG	791440077850	20012	791440078970	RS5342
791440073944	PT9311-MPG	791440075405	P1566	791440076846	BT9349-MPG	791440077867	PA5327	791440078987	RS5343
791440073968	PT9313-MPG	791440075436	P1567	791440076853	BF1357	791440077874	PA5328	791440078994	BF1367
791440073982	PT9315 KIT	791440075443	P1568	791440076860	BF7888	791440077881	RS5329	791440079007	BF7922
791440074019	PT9237	791440075528	PF1584	791440076877	BF1358-SP	791440077904	BK6666	791440079014	BF1370
791440074026	PT9238	791440075535	PF1585	791440076884	BF7892	791440077911	BT9358	791440079021	BW5183
791440074033	PT9239	791440075559	P1575	791440076897	PA5300	791440077935	BK6451	791440079038	BF1371
791440074040	PT9240	791440075573	P1577	791440076914	BT7316	791440077942	BK6452	791440079045	PA5350
791440074064	PT9242	791440075597	PF1587	791440076952	BK6185	791440077966	BK6654	791440079052	BF7923
791440074088	PT9244	791440075634	P1578	791440076969	BD7317	791440077973	BF1360	791440079069	P7330
791440074095	PT9245	791440075665	BF7879	791440076976	PT9350-MPG	791440077980	BF7911	791440079083	PT9378-MPG
791440074118	PT9247	791440075733	PT9330-MPG	791440076983	PT9351-MPG	791440077997	PA4175	791440079090	PA4184
791440074125	PT9248	791440075757	H9072-V	791440076990	RS5301	791440078000	PA4176	791440079106	PT9373-MPG
791440074149	PT9250	791440075764	H9076-V	791440077027	PF7894	791440078017	PT9359-MPG	791440079113	PT7332
791440074156	PT9251	791440075771	H9078-V	791440077034	PF7895	791440078024	BT9360	791440079120	RS5351
791440074187	PT9254	791440075870	PT9331	791440077041	B7318	791440078031	PT9361	791440079137	CA5352
791440074194	PT9255	791440075887	PT9332	791440077058	PA5302	791440078048	BF1293-SPS	791440079144	CTK5029-M
791440074200	PT9256-MPG	791440075917	PF7882	791440077072	PA5303	791440078055	BF1272-SPS	791440079151	BF7927
791440074217	PT9257	791440075924	BF7881	791440077089	P7309	791440078062	20013	791440079168	PT9379
791440074224	PT9258	791440075955	PA4979	791440077096	PF7896	791440078109	BT9362-MPG	791440079182	PT9380-MPG
791440074248	PT9260	791440075962	PA4978	791440077102	RS5304	791440078116	BT9363-MPG	791440079199	BF1373-SP
791440074255	PT9261-MPG	791440075979	PA4977-FN	791440077119	BK6613	791440078123	PA4177	791440079212	PT9415-MPG KIT
791440074286	PT9264	791440075993	PA4975	791440077126	RS5305	791440078130	BF7912	791440079229	PT9416-MPG KIT
791440074309	PT9266	791440076013	PA4973	791440077133	PA5306	791440078154	BF7913	791440079236	RS5354
791440074316	PT9267	791440076037	BK6663	791440077157	BF7898-D	791440078161	BF1352-SPS	791440079243	RS5355
791440074323	PT9268	791440076099	BK6662	791440077171	B7320	791440078185	BF1361	791440079250	BF7924
791440074361	PT9272	791440076112	PT9337-MPG	791440077188	PA4173	791440078192	PA5331	791440079267	BF1374-SP
791440074415	PT9277	791440076198	G494	791440077195	PA4174	791440078208	BK6187	791440079274	BF1375
791440074422	PT9278	791440076204	G523-AF	791440077256	PA5310	791440078369	BK6923	791440079281	PT9381-MPG
791440074439	PT9279	791440076211	ES1039	791440077263	P7321	791440078376	RS5332	791440079298	BF9382
791440074484	PF7869	791440076235	G1972	791440077270	PF7899	791440078390	BT9364	791440079304	BF1376
791440074514	PF7872	791440076259	PT9338-MPG	791440077287	PF7900	791440078406	PF7914	791440079335	BK6181
791440074521	PF7873	791440076266	BT7349	791440077300	PA4640-FN	791440078413	BF7915	791440079342	BF1372
791440074538	PF7874	791440076280	BF7883	791440077317	PT9352	791440078420	BT9365-MPG	791440079359	BF1377
791440074545	PF7875	791440076297	B7306	791440077324	B7322	791440078437	BT9366-MPG	791440079366	PA4185
791440074552	PF7876	791440076303	PA4984-FN	791440077331	PA5311	791440078444	PA5333	791440079380	FD7926
791440074569	PF7877	791440076310	PA4983	791440077348	PA5312 KIT	791440078451	BT9367-MPG	791440079397	BF7925
791440074576	BF7855	791440076341	PT9340-MPG	791440077355	RS5313	791440078475	RS5335	791440079403	PA5353
791440074590	BF7857	791440076365	BK6661	791440077362	PA5314	791440078482	BF1283-SP	791440079410	BK6429



WARNING: These products can expose you to chemicals, including Diisononyl Phthalate, Carbon black extracts, Nickel, 1,3 Butadiene, Ethylene Oxide, Epichlorohydrin, which are known to the State of California to cause cancer, and Bisphenol-A, Ethylene Glycol, Ethylene Oxide, 1,3 Butadiene, Epichlorohydrin, which are known to the State of California to cause birth defects or other reproductive harm. For more information go to www.P65Warnings.ca.gov.

UPC TO BALDWIN (INDIVIDUAL PARTS)

UPC NUMBER	BALDWIN NUMBER	UPC NUMBER	BALDWIN NUMBER	UPC NUMBER	BALDWIN NUMBER	UPC NUMBER	BALDWIN NUMBER	UPC NUMBER	BALDWIN NUMBER
791440079427	RS5356	791440080508	PA4305	791440081376	PA4330	791440082182	BF7957	791440083042	BF1394-SP
791440079434	PA5357	791440080515	PA4306	791440081383	PA4331	791440082199	PT9403-MPG	791440083059	RS5433
791440079441	PT9383-MPG	791440080522	PA4307	791440081390	PA4332	791440082205	BF1390-O	791440083066	PT9410-MPG
791440079458	PT9384-MPG	791440080539	PA4308	791440081406	BF7945	791440082212	PA4363	791440083073	PT9411-MPG
791440079465	RS5358	791440080546	PA4309	791440081413	B7416	791440082229	PA4364	791440083080	BF1395-SP
791440079472	PT9385-MPG	791440080553	SA4315	791440081420	CA5416	791440082236	PA4365	791440083097	PA4401
791440079489	PT9386-MPG	791440080560	PA4310	791440081437	CA5417	791440082243	PT9404-MPG	791440083103	PA4402
791440079502	BF1378-SPS	791440080577	PA4311	791440081444	PA5418	791440082250	BF1391-O	791440083110	BK6653
791440079519	G534-AF	791440080584	PA4312	791440081451	CA5421	791440082267	PA4366	791440083127	BK6657
791440079526	PA5359	791440080591	PA4313	791440081468	CA5419	791440082274	B7430	791440083134	PA4403
791440079533	PF7928	791440080607	PA4314	791440081475	CA5420	791440082298	PT9405	791440083141	PA4404
791440079540	BF7929 KIT	791440080614	B7402	791440081482	BT9398-MPG	791440082304	B7431	791440083158	PA4405
791440079557	RS5360	791440080621	B7403	791440081499	PF7946	791440082311	B7432	791440083189	PA4408
791440079564	RS5361	791440080638	PF7938	791440081505	PA4334	791440082328	B7433	791440083202	B7443
791440079601	PA5363	791440080645	BF1354-SPS	791440081512	PA4335	791440082335	PA4367	791440083219	B7444
791440079618	BF1379	791440080652	PA4316	791440081529	BK6980	791440082342	PA4368	791440083226	BF1396
791440079625	BF1380	791440080669	PA4317	791440081543	BK6982	791440082359	PA4369	791440083233	B7445
791440079632	BF1381	791440080720	PT9394-MPG	791440081550	BK6984	791440082366	PA4370	791440083240	PA4409
791440079649	PA4187	791440080744	PA4318	791440081567	BF1389-O	791440082373	PA4371	791440083257	BF7968
791440079656	BF1382-SP	791440080751	PA4319	791440081574	PA4333	791440082380	PA4372	791440083264	B7446
791440079687	PF7930	791440080768	PT9395-MPG	791440081581	PA4336	791440082397	PA4373	791440083271	PT9413-MPG
791440079786	PA5364	791440080775	PA4320	791440081598	PF7947	791440082403	BF7958	791440083288	BF1398-O
791440079793	PA5365	791440080799	200-DEPR KIT	791440081604	PA4337	791440082410	BF7959	791440083295	BK6942
791440079830	B7333	791440080805	100-DEPR KIT	791440081611	P7418	791440082427	BF7960	791440083301	P7450
791440079847	BF7931	791440080812	100-MNTG KIT	791440081635	BF7948	791440082434	BF7961	791440083318	B7451
791440079854	BF7932	791440080829	PT9396	791440081642	OV8728	791440082441	B7434	791440083325	BF1360-SP
791440079861	CA5366	791440080836	PT9397-MPG	791440081659	BF7949-D	791440082458	PA4374	791440083332	BF7949-DM
791440079885	CA5368	791440080843	BF1385-SPS	791440081666	BF7950-D	791440082465	PT9406-MPG	791440083349	BF7971-D
791440079892	CA5369	791440080850	PF7939	791440081673	20015	791440082489	PA4376	791440083356	BF7971-DM
791440079908	CA5370	791440080867	BF7940	791440081680	20016	791440082496	PA4377	791440083363	B7452
791440079915	BT9387	791440080874	BF7941	791440081697	20017	791440082502	PA4380	791440083370	RS5438
791440079946	B7397	791440080881	PA4321	791440081703	20018	791440082519	PA4381	791440083486	B7453
791440079953	BT9388	791440080898	PA4322	791440081710	20019	791440082526	PA4382	791440083493	RS5434
791440079977	RS5387 KIT	791440080904	BF7942	791440081727	20020	791440082533	PA4383	791440083516	PA4410 KIT
791440079984	PA5388	791440080911	P7406	791440081734	BK6983	791440082540	PA4384	791440083530	OP8750
791440079991	PT9389-MPG	791440080928	RS5395-FN	791440081741	BF7951-D	791440082557	PA4385	791440083547	OP8751
791440080010	RS5389-FN	791440080935	PA5396	791440081758	BF7952-D	791440082564	PA4386	791440083554	OP8752
791440080027	PT9390-MPG	791440080942	RS5397	791440081772	BF7954-D	791440082571	PA4387	791440083561	OP8753
791440080034	RS5390	791440080959	RS5398	791440081789	B7419	791440082588	BF7962	791440083578	PA4411
791440080041	B7335-MPG	791440080966	PA5399	791440081796	PA4338	791440082595	BF7963	791440083585	P7454
791440080058	B7334	791440080973	PA5400	791440081802	PA4340	791440082601	BF7964-D	791440083592	PA4412
791440080065	BT9391-MPG	791440080980	PA5401	791440081819	PA4341	791440082618	PT9407-MPG	791440083608	PA4413
791440080089	RS5391	791440081000	PA5403	791440081826	PA4344	791440082625	B7435	791440083622	PA4415
79144008102	P7336 KIT	791440081017	PA5404	791440081833	PA4345	791440082632	BT9408	791440083639	PA5436
79144008119	BT9392-MPG	791440081024	PA5405	791440081840	PA4348	791440082649	PA4388	791440083646	RS5440
791440081126	BT9393-MPG	791440081031	PA5406-FN	791440081857	PA4349	791440082656	PA4389	791440083653	RS5441
791440081133	PF7934 KIT	791440081048	PA4323	791440081864	PA4350	791440082663	PA5425	791440083660	P7455
791440081157	BK6930	791440081055	B7407	791440081871	PA4351	791440082670	PA4390	791440083677	PA4416 KIT
791440081164	BK6931	791440081062	PA4324	791440081888	PA4352	791440082687	PA5426	791440083684	BF7969
791440081171	RS5392	791440081086	PA4327	791440081895	RS5422	791440082717	P7436	791440083691	PT9414-MPG
79144008201	BK6933	791440081093	PA4328	791440081901	BF7955	791440082724	P7437	791440083714	PA5445
791440082018	PF7935	791440081109	PA4325	791440081918	B7420	791440082748	BF1392-SPS KIT	791440083721	PA5446
791440082025	PA5393	791440081116	RS5409	791440081925	B7422	791440082755	BF7965	791440083738	RS5447
791440082049	BF1384-SP	791440081123	RS5408	791440081932	BF7956-D	791440082762	PA4391	791440083745	RS5448
791440082063	P7337	791440081130	PA5410-FN	791440081949	P7423	791440082786	PA4392	791440083752	BF7972
791440082070	PA4188	791440081147	RS5411	791440081956	BA5371	791440082793	PA4393	791440083769	P7438
791440082087	P7338	791440081154	BF7943	791440081963	PA5423-FN	791440082809	PT9409-MPG	791440083776	PA4417
791440082094	RS4189	791440081161	PA5412	791440081970	PT9399-MPG	791440082816	B7440	791440083783	BK6985
791440083000	PA4190	791440081178	RS5413	791440081987	P7417	791440082823	BF7966	791440083790	BK6986
791440083017	PA4191	791440081185	P7408	791440081994	PA4353	791440082830	B5091	791440083806	BK6953
791440083031	PF7936	791440081192	B7409	791440082007	PA4354	791440082847	HSG3077	791440083813	BK6954
791440083048	P7398	791440081208	B7410	791440082014	PA4355	791440082854	B7441	791440083820	BK6955
791440083055	P7399	791440081215	PA4329	791440082021	PA4356	791440082861	PA4394	791440083837	BC7456 KIT
791440083062	P7400	791440081222	P7411	791440082045	PA4358	791440082878	PA5428	791440083844	RS5442
791440083079	B7401	791440081239	RS5414	791440082052	PA4359	791440082915	BF7967	791440083851	RS5443
791440083086	20014	791440081246	RS5415	791440082069	PA4360	791440082922	BF1393-SP	791440083868	PA4418
791440083093	BF7937	791440081253	BF1386-O	791440082076	PA4361	791440082939	RS5429	791440083875	PA4419
791440084009	PA4192	791440081260	BF7944	791440082083	PA4362	791440082946	RS5430	791440083943	PT9417
791440084016	PA4193	791440081277	P7413	791440082090	B7424	791440082953	BK6656	791440083950	B7449
791440084023	PA4194	791440081284	P7414	791440082106	P7426	791440082960	RS5431	791440083974	PT9418
791440084030	PA4195 KIT	791440081291	RS5344	791440082113	P7427	791440082977	PA4396	791440083981	PF7973
791440084047	PA4196	791440081307	RS5345	791440082120	BT9400-MPG	791440082984	PA4397	791440083998	BK6987
791440084054	PA4197	791440081321	RS5347	791440082137	PT9401	791440082991	PA4398	791440084001	BF1397-SP
791440084061	PA4198	791440081338	RS5348	791440082144	BT9402	791440083004	PA4399	791440084018	B7350
791440084078	PA4199	791440081345	BF1387-O	791440082151	RS5424	791440083011	PA4400	791440084032	CV15000
791440084085	PA4303	791440081352	BF1388-O	791440082168	B7428	791440083028	P7442	791440084049	BK6022
791440084092	PA4304	791440081369	P7415	791440082175	BK6652	791440083035	RS5432	791440084056	BK6023



WARNING: These products can expose you to chemicals, including Diisononyl Phthalate, Carbon black extracts, Nickel, 1,3 Butadiene, Ethylene Oxide, Epichlorohydrin, which are known to the State of California to cause cancer, and Bisphenol-A, Ethylene Glycol, Ethylene Oxide, 1,3 Butadiene, Epichlorohydrin, which are known to the State of California to cause birth defects or other reproductive harm. For more information go to www.P65Warnings.ca.gov.

UPC TO BALDWIN (INDIVIDUAL PARTS)

UPC NUMBER	BALDWIN NUMBER	UPC NUMBER	BALDWIN NUMBER	UPC NUMBER	BALDWIN NUMBER	UPC NUMBER	BALDWIN NUMBER	UPC NUMBER	BALDWIN NUMBER
791440084063	BK6024	791440086265	BF7988	791440087170	BF9805	791440088160	PA4436	791440089488	BF9857
791440084070	BK6025	791440086272	PT9420-MPG	791440087184	BF7372	791440088177	PA4437	791440089495	BK6053
791440084087	BK6026	791440086289	BF7989-D	791440087197	RS5510	791440088184	PT9435-MPG	791440089501	BK6054
791440084094	BF1399-SP	791440086302	PA5473	791440087200	RS5510	791440088191	BF9830-D	791440089518	BF9858 KIT
791440084100	PA5437	791440086319	PA5475	791440087217	BF1222-O	791440088214	BF9831	791440089716	BT9439
791440084117	BK6997	791440086326	PA5476	791440087224	BK6457	791440088238	B7930	791440089730	RS5543
791440084124	BK6027	791440086333	PA5477	791440087231	PA4431	791440088252	B7393	791440089747	RS5544
791440084148	PT9419-MPG	791440086340	RS5470	791440087248	PA5511	791440088269	BF9833-D	791440089754	PA4449
791440084155	PA4421	791440086357	RS5471	791440087255	PA5512	791440088276	BF9834	791440089761	PA5580
791440084490	PT9453-MPG	791440086364	RS5472	791440087262	BF1345-O	791440088283	BF9835-D	791440089778	PA5581
791440085497	BT9553	791440086371	B7363	791440087293	CA5514	791440088290	P7505	791440089792	PA5583
791440085503	PF7974	791440086388	P7364	791440087309	PA5515	791440088306	B7457	791440089808	PA5584
791440085510	B7351-MPG	791440086395	BF1287-O	791440087316	B7373	791440088313	B7458	791440089815	RS4450
791440085527	PT9554-MPG	791440086401	BF1288-O	791440087323	BF9807	791440088320	B7459	791440089822	PA5588
791440085534	PT9555	791440086418	PA4425	791440087330	BF9808-D	791440088344	PA5552	791440089839	PA5589
791440085541	PT9556-MPG	791440086425	PA4426	791440087347	PA5516	791440088368	PA5554	791440089853	CV15001
791440085558	HSG3078	791440086432	BF7990	791440087354	BF1223-O	791440088382	PA5556	791440089860	P7492
791440085565	AB3349	791440086449	PA5482	791440087361	BF9809-D	791440088399	PA5557	791440089891	PA4451
791440085572	PT9557	791440086456	P7365	791440087378	BF9810-D	791440088436	BF9836-D	791440089907	PA4452
791440085589	PF7975	791440086487	BF7993	791440087385	B7375	791440088443	PA4438	791440089914	PA4453
791440085596	B7352	791440086500	RS5483	791440087392	B7376	791440088450	RS5558	791440089921	PA5585
791440085619	BA5373	791440086517	RS5484	791440087408	B7377	791440088467	BF1346-O	791440089938	PA5586
791440085626	BA5377	791440086524	BK6033	791440087415	BF9811-SP	791440088474	BF1348-O	791440089945	PA4454
791440085633	RS5435	791440086531	PA5485-FN	791440087422	B7378	791440088498	B7461	791440089952	P7493
791440085640	BK6028	791440086548	PA5487	791440087446	BF1292-O	791440088511	BF9837-D	791440089969	PA4455
791440085657	BK6650	791440086555	B7367	791440087453	BF1294-O	791440088566	PA5561	791440089976	BK6055
791440085664	PA5454	791440086562	PF1392	791440087460	RS5506	791440088573	PA5562	791440089983	PA4456
791440085671	RS5455	791440086579	PA5486	791440087477	PT9430-MPG	791440088597	PA5563	791440090002	BA5592
791440085688	RS5456	791440086609	PF7994	791440087484	B7379	791440088627	BF9839-D	791440090019	PA4458
791440085695	BF7976	791440086616	BF7995	791440087491	RS5517	791440088641	RS5559	791440090033	PA5594
791440085718	BA5378	791440086623	P7368	791440087507	BF9812	791440088658	B10-AL BSPCS	791440090057	PA5597
791440085725	BA5379	791440086630	RS5478-FN	791440087514	BF9813	791440088665	BA5566	791440090088	P7494
791440085732	RS5452	791440086647	RS5479	791440087521	PF9814	791440088672	BF1298-O	791440090095	BK6056
791440085749	BK6029	791440086654	BK6438	791440087538	B7383	791440088689	B7466	791440090101	PA4460 KIT
791440085756	RS5453	791440086661	BK6161	791440087545	B7384	791440088702	B7467	791440090118	BF9860
791440085763	PF7978	791440086678	BF7996	791440087552	B7385	791440088719	B7468	791440090125	PA4461
791440085787	PA5457	791440086685	PA4428	791440087569	B7386	791440088726	B7469	791440090132	PA4462
791440085794	BD7355	791440086692	BT9421-MPG	791440087576	B7387	791440088733	BF9841	791440090149	PF9861
791440085800	BK6956	791440086708	20021	791440087583	BF9815	791440088757	RS5536	791440090156	CV15002
791440085817	BT9558-MPG	791440086715	20022	791440087606	BF9816	791440088764	RS5550	791440090163	PA4463
791440085824	PT9559-MPG	791440086722	20023	791440087613	BF1296-O	791440088771	RS5547	791440090170	PF9862
791440085831	RS5458	791440086739	20024	791440087620	BF1297-O	791440088788	RS5548	791440090187	BF9863
791440085848	B7356	791440086753	PA5491	791440087637	BF9817	791440088795	RS5549	791440090194	PA5618
791440085855	BF1366-O	791440086760	PA5492	791440087644	BF9818	791440088801	BF9842	791440090200	PA5619
791440085862	BF7970	791440086777	PA5493	791440087668	BF9820	791440088863	B7477	791440090217	PA5620
791440085879	BF7979	791440086784	BF7997	791440087675	PA4433	791440088890	BF9844	791440090224	PA5621
791440085886	B7357	791440086791	PA5494	791440087682	BF9821	791440088931	B7483	791440090231	PA5622
791440085909	RS5449	791440086807	PA5495	791440087699	BK6167	791440088913	PA5573	791440090248	PA5623
791440085916	B7359	791440086814	BT9422	791440087705	BF9822-D	791440088920	PA5574	791440090255	PA5624
791440085923	BK6030	791440086821	BF7998	791440087712	PF9823	791440088951	BC7485	791440090262	BF9864
791440085930	RS5459	791440086838	PA5496	791440087729	P7380	791440088999	BF9846	791440090279	PA5625
791440085947	RS5460	791440086845	PA5497	791440087743	PF9825	791440089105	BF9847-D	791440090286	PF9865
791440085954	PF7980	791440086852	BF1289-SP	791440087750	PF9826	791440089112	BF1299-O	791440090293	PA5626
791440085961	BK6031	791440086863	PT9423	791440087835	PA5528	791440089136	BT9436-MPG	791440090309	PA4464
791440085978	BK6032	791440086890	PA5498	791440087842	PA5529	791440089143	B7486	791440090316	RS5627
791440085985	PA4422	791440086906	PA5499	791440087859	PA5530	791440089150	B7487	791440090323	RS5628
791440085992	PA4423	791440086913	CA5500	791440087910	PT9432-MPG	791440089167	PA4439	791440090330	PA5629
791440086005	BF7981	791440086920	B7370	791440087927	BF9827-D	791440089174	PA4440 KIT	791440090347	PA5630
791440086036	BK6045	791440086968	PT9424	791440087934	PA5532	791440089181	PA4441	791440090354	PA5631
791440086067	BT9560-MPG	791440086975	PA5503	791440087941	PA5533	791440089198	BF9848	791440090361	RS5534
791440086074	PF7983	791440086982	PA5504	791440087958	PA5463	791440089204	P7488	791440090378	BT9440
791440086081	PF7984	791440086999	BF9800	791440087965	PA4434	791440089211	P7489	791440090385	BF9866-O
791440086104	BF7985	791440087002	PF9801	791440087972	BT9433	791440089235	BF9850	791440090392	PA5632
791440086111	RS5461	791440087019	PT9425-MPG	791440087989	BF9828-D	791440089297	PA4442	791440090415	P7495
791440086128	RS5462	791440087026	PA4429	791440087996	RS5538	791440089303	PA4443	791440090422	PA4465
791440086135	B7360	791440087033	PT9426	791440088009	RS5539	791440089310	PA4444	791440090439	RS5537
791440086142	PA4424	791440087040	BF9802	791440088016	RS5540	791440089327	BF9851	791440090446	BF9867-O
791440086159	BF7637	791440087057	PA4430	791440088023	RS5541	791440089334	P7490	791440090453	RS5535
791440086166	PA5464	791440087064	BT7237	791440088061	BK6034	791440089341	B7491	791440090460	BF1355-O
791440086180	B7361	791440087071	PA5505	791440088078	BK6035	791440089358	BF9852	791440090477	PA5633
791440086197	BT9561	791440087088	PF9803	791440088085	PA5545	791440089402	PA5451	791440090507	PF9868
791440086203	PF7986	791440087101	PT9427-MPG	791440088092	PT9434	791440089419	RS4445	791440090514	PA5636
791440086210	PF7982	791440087118	PT9429-MPG	791440088108	PA4435	791440089426	PA4446	791440090521	BF1395-O
791440086227	PA5465	791440087125	BF1383-O	791440088122	500-MFVBP22	791440089433	PA4447	791440090538	B7496
791440086234	B7362	791440087132	RS5507	791440088139	RS5546	791440089440	PA4448	791440090545	PA1885XP
791440086241	BF7987	791440087149	PF9804	791440088146	B7388	791440089457	BK6049	791440090552	PA2573XP
791440086258	PA5467	791440087156	RS5508	791440088153	PF9829 KIT	791440089464	BK6050	791440090569	PA2562XP



WARNING: These products can expose you to chemicals, including Diisononyl Phthalate, Carbon black extracts, Nickel, 1,3 Butadiene, Ethylene Oxide, Epichlorohydrin, which are known to the State of California to cause cancer, and Bisphenol-A, Ethylene Glycol, Ethylene Oxide, 1,3 Butadiene, Epichlorohydrin, which are known to the State of California to cause birth defects or other reproductive harm. For more information go to www.P65Warnings.ca.gov.

UPC TO BALDWIN (INDIVIDUAL PARTS)

UPC NUMBER	BALDWIN NUMBER	UPC NUMBER	BALDWIN NUMBER	UPC NUMBER	BALDWIN NUMBER	UPC NUMBER	BALDWIN NUMBER	UPC NUMBER	BALDWIN NUMBER
791440090576	PA1894XP	791440091474	PA5664	791440092365	PA4472	791440093492	BF1281-O	791440094338	PT9526-MPG
791440090583	PA2453XP	791440091481	PA5665	791440092372	BF9898-O	791440093508	BF9913	791440094345	PT9528
791440090590	PA2384XP	791440091498	PA5666	791440092389	PF9899	791440093515	BF1283-O	791440094352	PT9529
791440090606	PA2363XP	791440091504	PA5667	791440092402	B7507	791440093522	PA5753	791440094369	PT9530
791440090613	PA1615XP	791440091511	PA5668	791440092419	BC7394	791440093539	RS5754	791440094383	PT9532
791440090620	PA1884XP	791440091528	PA4468	791440092426	PA5700	791440093546	PA5755	791440094390	PA4481
791440090644	BF9869	791440091535	PA4469	791440092433	PF9901 KIT	791440093553	RS5756	791440094413	B7516
791440090651	BK6058	791440091542	P5092	791440092440	PA4473	791440093560	CV15003	791440094420	BT9533
791440090668	PT9441-MPG	791440091559	BF9878	791440092457	PT9468	791440093577	PF9914 KIT	791440094437	P7517
791440090675	BK6059	791440091566	PA5669	791440092464	BK6076	791440093584	BF9915	791440094444	P9600
791440090682	PF9870	791440091573	RS5670	791440092471	BK6077	791440093591	PA5757	791440094451	PA5770
791440090699	PA5637	791440091597	BK6064	791440092501	BK6080	791440093607	RS5758	791440094468	PA5771
791440090705	PA5638	791440091610	RS5672	791440092525	BF9903-SP	791440093614	RS5759	791440094475	PA5772
791440090729	PA2518XP	791440091627	RS5673	791440092532	PA4474	791440093638	RS5761	791440094482	PA5773
791440090736	PA1886XP	791440091634	PA5674	791440092549	B7395	791440093645	PA5762	791440094499	PF9919
791440090743	PA1634XP	791440091641	RS5675	791440092570	BF9904	791440093652	BF9916	791440094505	PA5774
791440090750	PA2616XP	791440091658	RS5676	791440092587	P7508	791440093669	PA4476	791440094529	BF1282-O
791440090767	PA2326XP	791440091689	B7499	791440092617	RS5707	791440093676	PA4477	791440094536	PA4483
791440090774	PA1846XP	791440091702	BT9456	791440092624	RS5708	791440093683	PA4478	791440094550	RS5776
791440090781	PA2676XP	791440091719	PA5678	791440092662	PT9469	791440093690	PA4479	791440094567	B9601
791440090798	BF9871-O	791440091726	BK6065	791440092679	PT9470	791440093706	PA4480	791440094574	PA5777
791440090804	RS3744XP	791440091740	PA5679	791440092686	BD7509	791440093713	PA5763	791440094581	PA5778
791440090811	RS3510XP	791440091757	PF9879	791440092693	PA5710	791440093720	PA5764	791440094598	PA5779
791440090828	RS3870XP	791440091764	BF9880	791440092709	PA5711	791440093737	P7512	791440094604	BF9920
791440090835	RS3508XP	791440091771	PA5680	791440092716	PA5712	791440093744	B7513	791440094611	PT9535-MPG
791440090842	RS3514XP	791440091788	PT9459-MPG	791440092723	PA5713	791440093751	PA5765	791440094628	PA5780
791440090859	RS3700XP	791440091795	PA5681	791440092747	BF9905	791440093768	P7514	791440094635	PA5781
791440090866	RS3998XP	791440091801	BF9881	791440092761	PA5716	791440093775	BF9917	791440094642	RS5489
791440090873	RS2863XP	791440091825	PT9462	791440092792	PA5719	791440093782	BK6081	791440094659	RS5490
791440090880	RS3517XP	791440091832	PA5682	791440092808	BT9471	791440093799	BF9918 KIT	791440094666	PA4484
791440090897	RS3548XP	791440091849	BT9464	791440092815	PA5720	791440093805	PA5766	791440094673	RS5782
791440090910	RS3530XP	791440091856	PT9463	791440092839	RS5722	791440093812	RS5767	791440094680	RS5783
791440090927	RS3506XP	791440091863	BF9883	791440092846	PA5723	791440093829	P7515	791440094697	BF9921-O
791440090934	RS3734XP	791440091887	B7501	791440092853	PA4475	791440093836	PA5768	791440094703	PA4485
791440090941	RS3504XP	791440091894	PE5270	791440092884	PA5725	791440093843	PT9477	791440094710	PA5785
791440090958	PF9872	791440091900	PE5271	791440092891	BF9906	791440093850	PT9478-MPG	791440094727	PA5786
791440090965	B7497	791440091917	BT9465	791440092914	PA5727	791440093867	PT9479-MPG	791440094734	PA5787
791440090996	PF9873	791440091924	PA5683	791440092921	PA5728	791440093881	PT9481-MPG	791440094741	RS5784
791440091009	RS5641	791440091931	BF9884	791440092938	PA5728 FOAM	791440093898	PT9482-MPG	791440094758	BF9922-O
791440091016	PA4466	791440091948	BF9885	791440092945	CFB8784	791440093904	PT9483-MPG	791440094765	PT9536-MPG
791440091023	BT9442-MPG	791440091955	BK6067	791440092952	PA5729	791440093911	PT9484-MPG	791440094772	CA5450
791440091030	BF9874-DM	791440091962	BT9466-MPG	791440092969	RS5730	791440093935	PT9486-MPG	791440094789	CA5788
791440091047	BF9875-DM	791440091986	BF9886	791440092976	RS5731	791440093942	PT9487-MPG	791440094796	CA4996
791440091054	PT9443	791440091993	P7502	791440092983	PA5732	791440093959	PT9488-MPG	791440094802	PA4997
791440091061	PT9444-MPG	791440092020	BF9887	791440092990	PF9907	791440093966	PT9489-MPG	791440094819	CA5789
791440091078	BF9876	791440092037	BF9888	791440093126	BK6073	791440093973	PT9490-MPG	791440094826	CA5790
791440091085	PA5642	791440092044	BK6071	791440093133	BK6074	791440093980	PT9491-MPG	791440094833	CA5791
791440091108	PA5644	791440092051	PF9889	791440093140	BK6075	791440093997	PT9492-MPG	791440094840	PA5792
791440091153	PT9445-MPG	791440092068	PF9890	791440093157	PA5733	791440094000	PT9493-MPG	791440094857	CA5793
791440091160	PT9446	791440092075	BF9891-D	791440093164	PF9908 KIT	791440094017	PT9494-MPG	791440094888	BK6051
791440091177	PT9447	791440092082	BF9892-D	791440093188	RS3539XP	791440094024	PT9495-MPG	791440094895	PA5796
791440091184	PT9448	791440092099	BF9893	791440093195	PA5734	791440094031	PT9496-MPG	791440094901	PA5797
791440091191	PT9449	791440092105	BF9894	791440093201	BF9910	791440094048	PT9497-MPG	791440094918	PA5798
791440091207	PT9450-MPG	791440092112	B7503	791440093218	PA5735	791440094055	PT9498-MPG	791440094925	PE5273
791440091214	PT9451-MPG	791440092129	PA5468	791440093225	PA5736	791440094062	PT9499-MPG	791440094949	RS5273
791440091221	PT9452	791440092136	RS5684	791440093232	P7510	791440094079	PT9500-MPG	791440094956	BF9923-O
791440091238	BT9454	791440092143	RS5685	791440093249	PF9911	791440094086	PT9501-MPG	791440094970	PA5274
791440091245	PA5649	791440092150	PA5686	791440093256	PT9472	791440094093	PT9502-MPG	791440094987	PA5275
791440091269	BK6060	791440092167	PA5687	791440093263	B7511	791440094109	PT9503-MPG	791440094994	PA5276
791440091276	PA5650	791440092174	PA5688	791440093294	PA5738	791440094116	PT9504-MPG	791440095007	P9602
791440091283	PA5651	791440092181	PA5689	791440093300	PA5739	791440094123	PT9505-MPG	791440095014	P9603
791440091290	PA5652	791440092198	PA5690	791440093324	RS5741	791440094147	PT9507	791440095021	PT9537-MPG
791440091306	PA5653	791440092204	PA5691	791440093331	RS5742	791440094154	PT9508	791440095045	CA5278
791440091313	BF1358-O	791440092211	RS5692	791440093348	RS5743	791440094161	PT9509	791440095076	PA5281
791440091320	PA5654	791440092228	RS5693	791440093355	RS5743XP	791440094178	PT9510	791440095083	PA5282
791440091337	PA5655	791440092235	PA5694	791440093362	RS5744	791440094185	PT9511	791440095090	PA5283
791440091344	BK6061	791440092242	PA5695	791440093379	RS5745	791440094208	PT9513	791440095106	BA5284
791440091351	BK6062	791440092259	PA5696	791440093386	RS5747	791440094215	PT9514	791440095113	PA4486
791440091368	BK6063	791440092266	PA5697	791440093393	RS5748	791440094222	PT9515	791440095120	BF1278-O
791440091375	PA2456XP	791440092273	BD7504	791440093409	RS5749	791440094239	PT9516	791440095137	PA4487
791440091382	BF9877	791440092280	B7506	791440093416	RS5750	791440094246	PT9517	791440095144	PA4488
791440091399	PA5656	791440092297	PA4470	791440093423	BF1249-O	791440094260	PT9518-MPG	791440095151	PA4489
791440091405	PA5657	791440092303	BF9895 KIT	791440093430	PA5751	791440094277	PT9519-MPG	791440095168	RS5285
791440091412	PA5658	791440092310	PA4471	791440093454	PA5752	791440094284	PT9520-MPG	791440095175	PF9924 KIT
791440091443	PA5661	791440092327	PA5698	791440093461	S9475	791440094307	PT9523-MPG	791440095199	BF9925-O
791440091450	PA5662	791440092334	PA5699	791440093478	BF9912-O	791440094314	PT9524-MPG	791440095212	RS5287XP
791440091467	PA5663	791440092358	PF9897	791440093485	PT9476-MPG	791440094321	PT9525-MPG	791440095229	PA5290



WARNING: These products can expose you to chemicals, including Diisononyl Phthalate, Carbon black extracts, Nickel, 1,3 Butadiene, Ethylene Oxide, Epichlorohydrin, which are known to the State of California to cause cancer, and Bisphenol-A, Ethylene Glycol, Ethylene Oxide, 1,3 Butadiene, Epichlorohydrin, which are known to the State of California to cause birth defects or other reproductive harm. For more information go to www.P65Warnings.ca.gov.

UPC TO BALDWIN (INDIVIDUAL PARTS)

UPC NUMBER	BALDWIN NUMBER	UPC NUMBER	BALDWIN NUMBER	UPC NUMBER	BALDWIN NUMBER	UPC NUMBER	BALDWIN NUMBER	UPC NUMBER	BALDWIN NUMBER
791440095236	PA5289	791440096042	PT23076-MPG	791440096851	PF46004	791440097650	BF46018-O	791440098503	OAS98016
791440095250	RS5291	791440096059	PT23077-MPG	791440096868	PA10004	791440097667	BF46019-O	791440098510	OAS98017
791440095267	RS5292	791440096066	PT23078-MPG	791440096875	RS10005	791440097674	BF46020-O	791440098527	OAS98018
791440095274	BF9927	791440096073	PT23079-MPG	791440096882	PA30010	791440097681	BF46021-O	791440098534	OAS98019
791440095281	PT23001	791440096080	PT23080-MPG	791440096889	BF46005	791440097698	BF46022-O	791440098541	OAS98020
791440095298	PT23000	791440096097	PT23081-MPG	791440096895	PA10006	791440097704	BF46023-O	791440098558	OAS98021
791440095304	PT23002	791440096103	PT23082-MPG	791440096912	P40003	791440097711	BF46024-O	791440098565	OAS98022
791440095311	PT23003	791440096110	PT23083-MPG	791440096929	PA10007	791440097728	BF46025-O	791440098572	OAS98023
791440095328	PT23004	791440096127	PT23084-MPG	791440096943	CV15004	791440097735	BF46026-O	791440098589	OAS98024
791440095335	PT23005	791440096134	PT23085-MPG	791440096950	PA30011	791440097742	BF46027-O	791440098596	OAS98025
791440095342	PT23006	791440096141	PT23086-MPG	791440096963	OAS98000	791440097759	BF46028-O	791440098603	OAS98026
791440095359	PT23007	791440096158	PT23087-MPG	791440096967	PA30012	791440097766	BF46029-O	791440098619	OAS98027
791440095366	PT23008	791440096165	PT23088-MPG	791440096974	PA30013	791440097773	BF46030-O	791440098626	OAS98028
791440095373	PT23009	791440096172	PT23089-MPG	791440096981	PA30014	791440097780	PT23136	791440098633	OAS98029
791440095380	PT23010	791440096189	PT23090-MPG	791440096988	PA30015	791440097787	PT23137	791440098640	OAS98030
791440095397	PT23011	791440096196	PT23091-MPG	791440097001	PA30016	791440097794	PT23138	791440098647	OAS98031
791440095403	PT23012	791440096202	PT23092-MPG	791440097018	PA30017	791440097801	PT23139	791440098654	OAS98032
791440095410	PT23013	791440096219	PT23093-MPG	791440097025	PA30018	791440097808	PT23140	791440098661	OAS98033
791440095427	PT23014	791440096226	PT23094-MPG	791440097032	PA30019	791440097815	PT23141	791440098668	OAS98034
791440095434	PT23015	791440096233	PT23095-MPG	791440097049	PA30020	791440097822	PT23142	791440098675	OAS98035
791440095441	PT23016	791440096240	PT23096-MPG	791440097056	PA30021	791440097829	PT23143	791440098682	OAS98036
791440095458	PT23017	791440096257	PT23097-MPG	791440097063	PA30022	791440097836	PT23144	791440098689	OAS98037
791440095465	PT23018	791440096264	PT23098-MPG	791440097070	PA30023	791440097843	PT23145	791440098696	OAS98038
791440095472	PT23019	791440096288	PT23100-MPG	791440097087	PA30024	791440097850	PT23146	791440098703	OAS98039
791440095489	PT23020	791440096295	PT23101-MPG	791440097094	PA30025	791440097857	PT23147	791440098710	OAS98040
791440095502	PT23022	791440096301	PT23102-MPG	791440097100	PA30026	791440097864	PT23148	791440098717	OAS98041
791440095519	PT23023	791440096318	PT23103-MPG	791440097117	PA30027	791440097871	PT23149	791440098724	OAS98042
791440095526	PT23024	791440096325	PT23104-MPG	791440097124	PA30028	791440097878	P40002	791440098731	OAS98043
791440095533	PT23025	791440096332	PT23105-MPG	791440097131	PA30029	791440097885	B40006	791440098738	OAS98044
791440095557	PT23027	791440096349	PT23106-MPG	791440097148	PA30030	791440097892	C40004	791440098745	OAS98045
791440095564	PT23028-MPG	791440096356	PT23107-MPG	791440097155	PA30031	791440097900	C40005	791440098752	OAS98046
791440095571	PT23029-MPG	791440096363	PT23108-MPG	791440097162	PA30032	791440097907	PA10008	791440098759	OAS98047
791440095588	PT23030-MPG	791440096370	PT23109-MPG	791440097179	PA30033	791440097914	PA30064	791440098766	OAS98048
791440095595	PT23031-MPG	791440096387	PT23110-MPG	791440097186	PA30034	791440097921	PT23130	791440098773	OAS98049
791440095601	PT23032-MPG	791440096394	PT23111-MPG	791440097193	PA30035	791440097928	BC40007	791440098780	OAS98050
791440095618	PT23033-MPG	791440096400	PT23112-MPG	791440097209	PA30036	791440097935	RS30065	791440098787	OAS98051
791440095625	PT23034-MPG	791440096417	PT23113-MPG	791440097216	PA30037	791440097942	RS30066	791440098794	OAS98052
791440095632	PT23035-MPG	791440096424	PT23114-MPG	791440097223	PA30038	791440097949	BF46031	791440098801	OAS98053
791440095649	PT23036-MPG	791440096431	PT23115-MPG	791440097230	PA30039	791440097956	BK6007	791440098808	OAS98054
791440095656	PT23037-MPG	791440096448	PT23116-MPG	791440097247	PA30040	791440097963	P40008	791440098815	OAS98055
791440095663	PT23038-MPG	791440096455	PT23117-MPG	791440097254	PA30041	791440097970	BC40009	791440098822	OAS98056
791440095670	PT23039-MPG	791440096462	PT23118-MPG	791440097261	PA30042	791440097977	P40010	791440098829	OAS98057
791440095687	PT23040-MPG	791440096479	PT23119-MPG	791440097278	PA30043	791440097984	P40011	791440098836	OAS98058
791440095694	PT23041-MPG	791440096486	PT23120-MPG	791440097285	PA30044	791440097991	BC40010	791440098843	OAS98059
791440095700	PT23042-MPG	791440096509	B9604	791440097292	PA30045	791440097998	PA30067	791440098850	OAS98060
791440095717	PT23043-MPG	791440096516	RS5293	791440097308	PA30046	791440098005	PA30068	791440098857	OAS98061
791440095724	PT23044-MPG	791440096523	RS5294	791440097315	PA30047	791440098012	PA30069	791440098864	OAS98062
791440095731	PT23045-MPG	791440096530	PA5297	791440097322	PA30048	791440098019	PA30070	791440098871	OAS98063
791440095748	PT23046-MPG	791440096537	PA5298	791440097329	PA30049	791440098026	CA30071	791440098878	OAS98064
791440095755	PT23047-MPG	791440096544	PA5299	791440097336	PA30050	791440098033	CA30072	791440098885	OAS98065
791440095762	PT23048-MPG	791440096551	P9605	791440097343	PA30051	791440098040	PA30073	791440098892	OAS98066
791440095779	PT23049-MPG	791440096558	RS5746	791440097350	PA30052	791440098047	PA30074	791440098899	OAS98067
791440095786	PT23050-MPG	791440096565	PA5297	791440097357	PA30053	791440098054	PA30075	791440098906	OAS98068
791440095793	PT23051-MPG	791440096572	RS5288XP	791440097364	PA30054	791440098061	PF46033	791440098913	OAS98069
791440095809	PT23052-MPG	791440096579	B9606	791440097371	PA30055	791440098068	P40011	791440098920	OAS98070
791440095816	PT23053-MPG	791440096586	B9607	791440097378	PA30056	791440098075	P40012	791440098927	OAS98071
791440095823	PT23054-MPG	791440096593	PF9928	791440097385	RS30057	791440098082	B40013	791440098934	OAS98072
791440095830	PT23055-MPG	791440096600	PF9929	791440097392	RS30058	791440098089	PT23139-MPG	791440098941	OAS98073
791440095847	PT23056-MPG	791440096607	PA30000	791440097399	RS30059-FN	791440098096	PA30076	791440098948	OAS98074
791440095854	PT23057-MPG	791440096614	PA30001	791440097406	RS30060-FN	791440098103	BF45000	791440098955	OAS98075
791440095861	PT23058-MPG	791440096621	PA10000	791440097413	RS30061	791440098110	PA30077	791440098962	OAS98076
791440095878	PT23059-MPG	791440096628	PA10001	791440097420	RS30062	791440098117	PA10009	791440098969	OAS98077
791440095885	PT23060-MPG	791440096635	PA10002	791440097427	BW21000	791440098124	P40014	791440098976	OAS98078
791440095892	PT23061-MPG	791440096642	BF46000	791440097434	BF46000	791440098131	P40015	791440098983	OAS98079
791440095908	PT23062-MPG	791440096649	BF46001	791440097441	BF46007	791440098138	RS5593XP	791440098990	OAS98080
791440095915	PT23063-MPG	791440096656	B40000	791440097448	BF46008	791440098145	OAS98001	791440098997	OAS98081
791440095922	PT23064-MPG	791440096663	P40001	791440097455	BF46009	791440098152	OAS98002	791440099004	OAS98082
791440095939	PT23065-MPG	791440096670	BF46002	791440097462	PF46009	791440098159	OAS98003	791440099011	OAS98083
791440095946	PT23066-MPG	791440096677	BF46003	791440097469	PF46010 KIT	791440098166	OAS98004	791440099018	OAS98084
791440095953	PT23067-MPG	791440096684	PA30002	791440097476	BF46012	791440098173	OAS98005	791440099025	OAS98085
791440095960	PT23068-MPG	791440096691	PA30003	791440097483	BF46013	791440098180	OAS98006	791440099032	OAS98086
791440095967	PT23069-MPG	791440096698	PA30004	791440097490	BF46014	791440098187	OAS98007	791440099039	OAS98087
791440095984	PT23070-MPG	791440096705	PA30005	791440097497	BF46015	791440098194	OAS98008	791440099046	OAS98088
791440095991	PT23071-MPG	791440096712	PA30006	791440097504	BF5813-O	791440098201	PA30078	791440099053	OAS98089
791440096004	PT23072-MPG	791440096719	PA30007	791440097511	BF1204-O	791440098208	OAS98011	791440099060	OAS98090
791440096011	PT23073-MPG	791440096726	PA10003	791440097518	BF791-O	791440098215	OAS98012	791440099067	OAS98091
791440096028	PT23074-MPG	791440096733	RS30008	791440097525	BF7968-O	791440098222	OAS98013	791440099074	OAS98092
791440096035	PT23075-MPG	791440096740	RS30009	791440097532	BF46016-O	791440098229	OAS98014	791440099081	OAS98093
		791440096747	PF46003	791440097539	BF46017-O	791440098236	OAS98015	791440099088	OAS98094



WARNING: These products can expose you to chemicals, including Diisononyl Phthalate, Carbon black extracts, Nickel, 1,3 Butadiene, Ethylene Oxide, Epichlorohydrin, which are known to the State of California to cause cancer, and Bisphenol-A, Ethylene Glycol, Ethylene Oxide, 1,3 Butadiene, Epichlorohydrin, which are known to the State of California to cause birth defects or other reproductive harm. For more information go to www.P65Warnings.ca.gov.

UPC TO BALDWIN (INDIVIDUAL PARTS)

UPC NUMBER	BALDWIN NUMBER	UPC NUMBER	BALDWIN NUMBER	UPC NUMBER	BALDWIN NUMBER	UPC NUMBER	BALDWIN NUMBER	UPC NUMBER	BALDWIN NUMBER
791440099425	PT23182	791440100305	PT23270-MPG	791440101319	PT23337	791440102088	PT23415-MPG	791440102910	PT23481
791440099432	PT23183	791440100312	PT23271-MPG	791440101326	PT23338-MPG	791440102095	PT23414-MPG	791440102927	PT23482
791440099449	PT23184	791440100329	PT23272-MPG	791440101333	PT23339-MPG	791440102101	PT23416-MPG	791440102934	PT23483-MPG
791440099456	PT23185	791440100336	PT23273-MPG	791440101340	PT23340-MPG	791440102118	PT23417-MPG	791440102941	PT23484-MPG
791440099463	PT23186	791440100343	PT23274-MPG	791440101357	PT23341-MPG	791440102125	PT23418-MPG	791440102958	PT23485-MPG
791440099470	PT23187	791440100350	PT23275-MPG	791440101364	PT23342-MPG	791440102132	PT23419-MPG	791440102965	PT23486-MPG
791440099487	PT23188	791440100367	PT23276-MPG	791440101371	PT23343-MPG	791440102149	PT23420-MPG	791440102972	PT23487-MPG
791440099500	PT23190	791440100374	PT23277-MPG	791440101388	PT23344-MPG	791440102156	PT23421-MPG	791440102989	PT23488-MPG
791440099531	PT23193-MPG	791440100381	PT23278-MPG	791440101401	PT23346-MPG	791440102163	PT23422-MPG	791440102996	PT23489-MPG
791440099555	PT23195-MPG	791440100398	PT23279-MPG	791440101401	PT23346-MPG	791440102170	PT23423-MPG	791440103009	PT23490-MPG
791440099562	PT23196-MPG	791440100404	PT23280-MPG	791440101418	PT23347-MPG	791440102187	PT23424-MPG	791440103016	PT23491-MPG
791440099579	PT23197-MPG	791440100411	PT23281-MPG	791440101422	PT23348-MPG	791440102194	PT23425-MPG	791440103023	PT23492-MPG
791440099586	PT23198-MPG	791440100428	PT23282-MPG	791440101425	PT23348-MPG	791440102200	PT23426-MPG	791440103030	PT23493-MPG
791440099609	PT23200-MPG	791440100435	PT23283-MPG	791440101432	PT23349-MPG	791440102217	PT23427-MPG	791440103047	PT23494-MPG
791440099616	PT23201-MPG	791440100442	PT23284-MPG	791440101449	PT23350-MPG	791440102224	PT23428-MPG	791440103054	PT23495-MPG
791440099623	PT23202-MPG	791440100459	PT23285-MPG	791440101456	PT23351-MPG	791440102231	PT23429-MPG	791440103061	PT23496-MPG
791440099630	PT23203-MPG	791440100466	PT23286-MPG	791440101463	PT23352-MPG	791440102248	PT23430-MPG	791440103078	PT23497-MPG
791440099647	PT23204-MPG	791440100473	PT23287-MPG	791440101470	PT23353-MPG	791440102255	PT23431-MPG	791440103085	PT23498-MPG
791440099654	PT23205-MPG	791440100497	PT23289-MPG	791440101487	PT23354-MPG	791440102262	PT23432-MPG	791440103092	PT23499-MPG
791440099661	PT23206-MPG	791440100503	PT23290-MPG	791440101500	PT23356-MPG	791440102279	PT23433-MPG	791440103108	PT23500-MPG
791440099678	PT23207-MPG	791440100510	PT23291-MPG	791440101517	PT23357-MPG	791440102286	PT23434-MPG	791440103115	PT23501-MPG
791440099692	PT23209-MPG	791440100527	PT23292-MPG	791440101524	PT23358-MPG	791440102293	PT23435-MPG	791440103122	PT23502-MPG
791440099715	PT23211-MPG	791440100541	PT23294-MPG	791440101531	PT23359-MPG	791440102309	PT23436-MPG	791440103139	PT23503-MPG
791440099722	PT23212-MPG	791440100558	PT23295-MPG	791440101548	PT23360-MPG	791440102316	PT23437-MPG	791440103146	PT23504-MPG
791440099739	PT23213-MPG	791440100572	PT23297	791440101555	PT23361-MPG	791440102323	PT23438-MPG	791440103153	PT23505-MPG
791440099746	PT23214-MPG	791440100596	PA30080	791440101562	PT23362-MPG	791440102330	PT23439-MPG	791440103160	PT23506-MPG
791440099753	PT23215-MPG	791440100602	PA30081	791440101579	PT23363-MPG	791440102347	PT23440-MPG	791440103177	PT23507-MPG
791440099760	PT23216-MPG	791440100619	PA10014	791440101586	PT23364-MPG	791440102354	PT23441-MPG	791440103184	PT23508-MPG
791440099777	PT23217-MPG	791440100763	BT40015	791440101593	PT23365-MPG	791440102361	PT23442-MPG	791440103191	PT23509-MPG
791440099784	PT23218-MPG	791440100770	PA30086	791440101609	PT23366-MPG	791440102378	PT23443-MPG	791440103207	PT23510-MPG
791440099791	PT23219-MPG	791440100787	PA10015	791440101616	PT23367-MPG	791440102385	PT23444-MPG	791440103214	PT23511-MPG
791440099807	PT23220-MPG	791440100831	RS30090-FN	791440101630	PT23369-MPG	791440102392	PT23445-MPG	791440103221	PT23512-MPG
791440099814	PT23221-MPG	791440100848	20025	791440101647	PT23370-MPG	791440102408	PT23446-MPG	791440103238	PT23513-MPG
791440099838	PT23223-MPG	791440100855	RS30091	791440101654	PT23371-MPG	791440102415	PT23447-MPG	791440103245	PT23514-MPG
791440099845	PT23224-MPG	791440100862	RS30092	791440101661	PT23372-MPG	791440102439	PT23449-MPG	791440103252	PT23515-MPG
791440099869	PT23226-MPG	791440100879	BF46036 KIT	791440101678	PT23373-MPG	791440102446	PT23450-MPG	791440103269	PT23516-MPG
791440099876	PT23227-MPG	791440100886	PA30093	791440101685	PT23374-MPG	791440102460	BF46040-D	791440103276	PT23517-MPG
791440099883	PT23228-MPG	791440100893	PA10016	791440101692	PT23375-MPG	791440102484	PA10020	791440103283	PT23518-MPG
791440099890	PT23229-MPG	791440100909	PA10017	791440101708	PT23376-MPG	791440102491	P40019	791440103290	PT23519-MPG
791440099906	PT23230-MPG	791440100916	PA30094	791440101715	PT23377-MPG	791440102507	RS30099	791440103306	PT23520-MPG
791440099913	PT23231-MPG	791440100923	BF46037	791440101722	PT23378-MPG	791440102514	PA30100	791440103313	PT23521-MPG
791440099920	PT23232-MPG	791440100930	PA30095	791440101739	PT23379-MPG	791440102521	PA30101	791440103320	PT23522-MPG
791440099937	PT23233-MPG	791440100947	PT23306	791440101746	PT23380-MPG	791440102545	RS30106	791440103337	PT23523-MPG
791440099944	PT23234-MPG	791440100954	PA30096	791440101753	PT23381-MPG	791440102552	PA30107	791440103344	PT23524-MPG
791440099951	PT23235-MPG	791440100965	BF46038-D	791440101760	PT23382-MPG	791440102569	PA30109	791440103351	BF46041-D
791440099968	PT23236-MPG	791440100992	BF46039-D	791440101777	PT23383-MPG	791440102576	PA30108	791440103368	BF46042-D
791440099975	PT23237-MPG	791440101005	PA10018	791440101784	PT23384-MPG	791440102583	PA30110	791440103375	BF46043-D
791440099982	PT23238-MPG	791440101012	PA30098	791440101791	PT23385-MPG	791440102590	RS30112	791440103382	PA30113
791440099999	PT23239-MPG	791440101029	PT23308	791440101794	PT23388-MPG	791440102606	RS10021	791440103399	PA30114
791440100008	PT23240-MPG	791440101036	PT23309	791440101807	PT23386-MPG	791440102613	PT23451	791440103405	PA30115
791440100015	PT23241-MPG	791440101043	PT23310	791440101814	PT23387-MPG	791440102637	PT23453	791440103412	PA10022
791440100022	PT23242-MPG	791440101050	PT23311	791440101821	PT23388-MPG	791440102644	PT23454	791440103429	BT23525-MPG
791440100039	PT23243-MPG	791440101067	PT23312	791440101838	PT23389-MPG	791440102651	PT23455	791440103436	RS30116
791440100046	PT23244-MPG	791440101074	PT23313	791440101845	PT23390-MPG	791440102668	PT23456	791440103443	BF46044-D
791440100053	PT23245-MPG	791440101081	PT23314	791440101852	PT23391-MPG	791440102675	PT23457	791440103450	PA40020
791440100060	PT23246-MPG	791440101098	PT23315	791440101869	PT23392-MPG	791440102682	PT23458	791440103467	PA30117
791440100077	PT23247-MPG	791440101104	PT23316	791440101876	PT23393-MPG	791440102699	PT23459	791440103474	PT23526
791440100084	PT23248-MPG	791440101111	PT23317	791440101883	PT23394-MPG	791440102705	PT23460	791440103481	PA2361XP
791440100091	PT23249-MPG	791440101128	PT23318	791440101890	PT23395-MPG	791440102712	PT23461	791440103498	CA30103
791440100107	PT23250-MPG	791440101135	PT23319	791440101906	PT23396-MPG	791440102729	PT23462	791440103504	CA30102
791440100114	PT23251-MPG	791440101142	PT23320	791440101913	PT23397-MPG	791440102736	PT23463	791440103511	CA30105
791440100121	PT23252-MPG	791440101159	PT23321	791440101920	PT23398-MPG	791440102743	PT23464	791440103528	CA30104
791440100138	PT23253-MPG	791440101166	PT23322	791440101937	PT23399-MPG	791440102750	PT23465	791440103535	PT23527
791440100145	PT23254-MPG	791440101173	PT23323	791440101944	PT23400-MPG	791440102774	PT23467	791440103542	PA30118
791440100152	PT23255-MPG	791440101180	PT23324	791440101951	PT23401-MPG	791440102781	PT23468	791440103559	PA30119
791440100176	PT23257-MPG	791440101197	PT23325	791440101968	PT23402-MPG	791440102798	PT23469	791440103566	B40022-MPG
791440100183	PT23258-MPG	791440101203	PT23326	791440101975	PT23403-MPG	791440102804	PT23470	791440103573	RS30120
791440100190	PT23259-MPG	791440101210	PT23327	791440101982	PT23404-MPG	791440102811	PT23471	791440103580	RS30121
791440100206	PT23260-MPG	791440101227	PT23328	791440101999	PT23405-MPG	791440102828	PT23472	791440103597	RS5293XP
791440100213	PT23261-MPG	791440101234	PT23329	791440102002	PT23406-MPG	791440102835	PT23473	791440103603	P40021
791440100220	PT23262-MPG	791440101241	PT23330	791440102019	PT23407-MPG	791440102842	PT23474	791440103610	PA10023
791440100237	PT23263-MPG	791440101258	PT23331	791440102026	PT23408-MPG	791440102859	PT23475	791440103627	PA10024
791440100244	PT23264-MPG	791440101265	PT23332	791440102033	PT23409-MPG	791440102866	PT23476	791440103634	PA10025
791440100251	PT23265-MPG	791440101272	PT23333	791440102040	PT23410-MPG	791440102873	PT23477	791440103641	PA10026
791440100268	PT23266-MPG	791440101289	PT23334	791440102057	PT23411-MPG	791440102880	PT23478	791440103658	PA10027
791440100275	PT23267-MPG	791440101296	PT23335	791440102064	PT23412-MPG	791440102897	PT23479	791440103665	PA10028
791440100299	PT23269-MPG	791440101302	PT23336	791440102071	PT23413-MPG	791440102903	PT23480	791440103689	PA10030



WARNING: These products can expose you to chemicals, including Diisononyl Phthalate, Carbon black extracts, Nickel, 1,3 Butadiene, Ethylene Oxide, Epichlorohydrin, which are known to the State of California to cause cancer, and Bisphenol-A, Ethylene Glycol, Ethylene Oxide, 1,3 Butadiene, Epichlorohydrin, which are known to the State of California to cause birth defects or other reproductive harm. For more information go to www.P65Warnings.ca.gov.

UPC TO BALDWIN (INDIVIDUAL PARTS)

UPC NUMBER	BALDWIN NUMBER	UPC NUMBER	BALDWIN NUMBER	UPC NUMBER	BALDWIN NUMBER	UPC NUMBER	BALDWIN NUMBER	UPC NUMBER	BALDWIN NUMBER
791440103696	PA10031	791440104686	BT23542-MPG	791440105683	PA10043	791440107663	OAS99047	791440108820	BF46127
791440103702	PA10032	791440104693	CV15005	791440105690	P40035	791440107670	OAS99048	791440108844	BK6057
791440103719	P40023	791440104709	PF46056	791440105706	B40036	791440107687	P40052	791440108868	PA30251
791440103726	PA0024	791440104719	PF46057	791440105713	PF46077	791440107700	PF46103	791440108882	BT40065
791440103733	P40025	791440104730	PF46059	791440105720	PA30152	791440107717	PT23595-MPG	791440108905	RS3518XP
791440103740	OAS98060	791440104754	BF46061	791440105737	OAS98061	791440107731	B40053	791440108912	PA30252
791440103757	PT23528-MPG	791440104761	PA30164	791440105744	PA10044	791440107748	B40054	791440108936	PA10066
791440103764	RS30087	791440104778	BF46062	791440105751	PA10045	791440107762	BT23603-MPG	791440108943	BK6093
791440103771	RS30088	791440104785	BT23543-MPG	791440105768	PA10046	791440107779	PT23597-MPG	791440108950	PA10067
791440103801	PA30122	791440104792	PT23544-MPG	791440105775	P40037	791440107786	BT23604	791440108967	BF46128-D
791440103818	PA30123	791440104808	PT23545-MPG	791440105782	BT40038	791440107793	PT23598-MPG	791440108974	PA31015
791440103825	PA30124	791440104815	PT23546-MPG	791440105799	BF46078-D	791440107816	BT23605-MPG	791440108981	PA30253
791440103832	PA30125	791440104822	PA30170	791440105805	PA30193-FN	791440107830	PT23600	791440108998	BF46129
791440103849	BF46045-D	791440104839	BF63000	791440105812	PA30194	791440107847	B40056	791440109001	PA10068
791440103924	PA10033	791440104846	PA30171	791440105829	PF46079	791440107878	BT23607-MPG	791440109018	CV15007
791440103931	PA3478XP	791440104877	RS30168	791440105836	PF46080	791440107885	PA10057	791440109025	CV15008
791440103948	PA30126	791440104884	RS30169	791440105843	PF46081	791440107908	RS30209	791440109032	PA10069
791440103955	PA30127	791440104907	PA30172	791440105850	PF46082	791440107922	PA30211	791440109049	PA10070
791440103962	PF46046	791440104914	PA30173	791440105867	PA31013	791440107939	PA30235	791440109056	PA10071
791440103979	RS30128	791440104976	RS30142	791440105874	PA31014	791440107946	RS30212	791440109063	PA10072
791440103986	RS30129	791440104983	RS30142 KIT	791440105881	PA31008	791440107953	RS30213	791440109070	PA10073
791440103993	PA10034	791440104990	RS30143	791440105898	PA31009	791440107984	RS30216	791440109124	BK6094
791440104020	PT23531-MPG	791440105003	RS30143 KIT	791440106758	BF46083-O	791440107991	RS30217	791440109155	PF46130
791440104037	BF46048	791440105027	BT40028	791440106789	BK6140	791440108004	RS30236	791440109179	PT23616-MPG
791440104044	P40017	791440105034	P40030	791440106796	PT23561-MPG	791440108035	RS30220	791440109193	BF46131
791440104105	RS30133	791440105041	PA30174	791440106819	PA32001	791440108042	RS30221	791440109223	BF46134-O
791440104112	RS30134	791440105058	RS30175	791440106826	PA32004	791440108059	RS30222XP	791440109261	RS30257
791440104129	PA30137	791440105072	P40031-MPG	791440106833	PA32000	791440108066	RS30223	791440109285	PA10075
791440104136	PA30138	791440105089	PA30177	791440106840	RS32003	791440108073	RS30224	791440109292	PF46135
791440104143	PA30139	791440105096	BD50000	791440106864	PA32002	791440108080	RS30225	791440109308	PA10076
791440104150	PA30140	791440105126	PA30179	791440106871	BF46084	791440108097	RS30226	791440109315	BK6083
791440104167	PA30141	791440105140	RS30180	791440106918	PE17001	791440108103	RS30227	791440109322	BK6088
791440104174	PA30144	791440105157	RS30181	791440106925	PT23565-MPG	791440108110	BF46104	791440109339	PA10077
791440104181	RS30135	791440105164	RS30182	791440106932	PT23566-MPG	791440108127	BK6090	791440109346	PA10078
791440104198	RS30136	791440105171	PA30183	791440106949	PT23567-MPG	791440108134	BF46105-O	791440109377	BT40066-MPG
791440104204	BA16000	791440105188	BF46068	791440106956	PT23568-MPG	791440108141	PF46106	791440109384	BT40067-MPG
791440104211	PT23532-MPG	791440105195	BF46069	791440106963	PT23569-MPG	791440108165	PF46108	791440109391	PF46137
791440104228	RS30130	791440105218	BT40029	791440106970	PT23570-MPG	791440108189	BF46109-O	791440109414	PF46138
791440104235	RS10035	791440105225	BT23555-MPG	791440106987	PT23571-MPG	791440108196	PA30228	791440109421	PA30258
791440104242	PT23530	791440105232	BF46071	791440106994	PT23572-MPG	791440108202	PA30229	791440109445	BK6068
791440104259	PT23533	791440105249	BF46072	791440107007	PT23573-MPG	791440108226	P40058	791440109490	BK6069
791440104266	RS4634XP	791440105256	PT23556-MPG	791440107014	PT23574-MPG	791440108257	BF46111	791440109506	BK6082
791440104273	PA30148	791440105263	PA30166	791440107021	PT23575-MPG	791440108288	RS30232	791440109513	BK6085
791440104280	BK6086	791440105270	PA30165	791440107038	PT23576-MPG	791440108301	PA30233-FN	791440109520	PA10081
791440104297	BK6087	791440105287	BT40032	791440107045	PT23577-MPG	791440108318	BF46113-D	791440109537	BF1381-O
791440104303	BF46050	791440105294	BF46073	791440107052	PT23578-MPG	791440108325	BT23609-MPG	791440109544	PA30260
791440104327	PT23535	791440105317	PA31000	791440107069	PT23579-MPG	791440108332	RS30234	791440109551	PA30261
791440104334	PT23536	791440105324	PA31002	791440107076	PT23580-MPG	791440108356	PA10058	791440109568	PA30262
791440104341	BF46051	791440105331	PA31010	791440107083	PT23581-MPG	791440108363	PA10059	791440109575	BT23617
791440104358	PA30149	791440105348	PA31001	791440107090	PT23582-MPG	791440108370	PA30206	791440109582	BF46141
791440104365	PA30150	791440105355	PA31003	791440107106	PT23583-MPG	791440108387	PA30207	791440109599	PA10082
791440104372	PA10036	791440105362	PA31011	791440107120	PT23585	791440108394	PA30208	791440109605	BF46122
791440104389	PA30151	791440105386	P40033	791440107137	PT23586	791440108400	RS30238	791440109612	PF46142
791440104396	BF46052	791440105393	PA31004	791440107144	PT23587	791440108431	RS30239	791440109629	BF46143
791440104419	RS30147	791440105409	PA31006	791440107151	PT23588	791440108448	RS30242	791440109636	PA10084
791440104426	PA30145	791440105416	PA31012	791440107168	PT23589	791440108455	PA10060	791440109650	PA10085
791440104433	PA30146	791440105423	PA31005	791440107175	PT23590	791440108462	BF46117	791440109674	CV15010
791440104440	PA30153	791440105430	PA31007	791440107182	BF46085	791440108479	PF46118	791440109698	PA0069
791440104457	PA30154	791440105447	BK6138	791440107199	PT23591-MPG	791440108486	PF46119	791440109728	PF46145
791440104464	PA30155	791440105461	BT40034	791440107205	P40042	791440108493	PF46092	791440109735	BK6110
791440104471	PA30156	791440105478	PA30185	791440107229	PA30200	791440108509	BT23611	791440109742	B40070
791440104488	PA30157	791440105492	RS30187XP	791440107236	CA30201	791440108547	PA10061	791440109773	S40071
791440104495	PF46112	791440105515	PE17000	791440107243	CA30202	791440108561	RS30237	791440109780	BF46147-O
791440104501	PA10037	791440105539	PA30188	791440107267	CA30131	791440108578	P40061	791440109803	RS5287
791440104532	BT23537	791440105546	CV15006	791440107274	CA30132	791440108585	BF46116 KIT	791440109810	RS5288
791440104549	PF46049	791440105560	PA30189	791440107281	BF46087	791440108608	PA30204	791440109827	RS3750XP
791440104556	BD40027	791440105577	PA30190	791440107298	PA10047	791440108615	P40062	791440109841	BF46149-SP
791440104570	BT23539	791440105584	RS30191	791440107304	PT23592	791440108622	PA10062	791440109858	BK6112
791440104587	BT23540	791440105591	RS30192	791440107311	PF46088	791440108646	BK6089	791440109865	RS30273
791440104594	PA30158	791440105607	BF46065-SPS	791440107359	PF46091	791440108653	PA30244	791440109872	RS30274
791440104600	RS30159	791440105614	PF46076	791440107366	BF46098-O	791440108660	PA30243	791440109889	PA10088
791440104617	RS30160	791440105621	PT23560	791440107373	BF46100-O	791440108677	BK6092	791440109896	BF46150-O
791440104624	RS30161	791440105638	PA10038	791440107380	BF46099-O	791440108691	BF46123-O	791440109902	PA10089
791440104631	RS30162	791440105645	PA10039	791440107397	PF46094	791440108714	PA10064	791440109919	PA10090
791440104655	BF13655	791440105652	PA10040	791440107403	BF46101-O	791440108721	BF46125	791440109926	PA30268
791440104662	BF1347-O	791440105669	PA10041	791440107458	B40050	791440108745	PF46126	791440109933	PA30275
791440104679	PA30163	791440105676	PA10042	791440107465	B40051	791440108783	PT23613-MPG	791440109940	PA30276



WARNING: These products can expose you to chemicals, including Diisononyl Phthalate, Carbon black extracts, Nickel, 1,3 Butadiene, Ethylene Oxide, Epichlorohydrin, which are known to the State of California to cause cancer, and Bisphenol-A, Ethylene Glycol, Ethylene Oxide, 1,3 Butadiene, Epichlorohydrin, which are known to the State of California to cause birth defects or other reproductive harm. For more information go to www.P65Warnings.ca.gov.

UPC TO BALDWIN (INDIVIDUAL PARTS)

UPC NUMBER	BALDWIN NUMBER	UPC NUMBER	BALDWIN NUMBER	UPC NUMBER	BALDWIN NUMBER	UPC NUMBER	BALDWIN NUMBER	UPC NUMBER	BALDWIN NUMBER
791440109957	PF46151	791440111196	BF46179	791440112018	PA10192	791440112780	PA10227	791440113558	BF46212
791440109964	PA30270	791440111226	BF1379-O	791440112025	PA10181	791440112797	PA10374	791440113565	PA10161
791440109971	PA30269	791440111240	BT23628	791440112032	P40099	791440112803	P40090	791440113572	PA10246
791440109988	PA10083	791440111257	BF46181-O	791440112049	PA10277	791440112810	PA10309	791440113589	PA10236
791440109995	PA10091	791440111264	PT23629	791440112056	OB40079	791440112827	.20063	791440113596	SA10359
791440110021	PA30277	791440111271	BK6095	791440112063	PA10378	791440112834	PA10112	791440113602	PA10179
791440110038	.20028	791440111288	BK6096	791440112070	P40106	791440112841	PA10199 KIT	791440113619	PA10272
791440110069	PA10093	791440111295	BK6097	791440112087	PA10143	791440112858	PA10324	791440113626	.20064
791440110076	PA10094	791440111301	BK6098	791440112094	PA10288	791440112865	PA10226	791440113633	PA10306
791440110083	PA10095	791440111318	BK6099	791440112100	.20052	791440112872	PA10134	791440113640	PA10140
791440110106	PA30255	791440111325	PA10063	791440112117	PA10108	791440112889	PA10352	791440113657	PA10240
791440110113	.20026	791440111332	PA30249	791440112124	SA10127	791440112896	BF46195	791440113664	PA30301
791440110120	.20027	791440111356	BF46182-O	791440112131	PA10320	791440112902	PA10116	791440113671	PA10393
791440110137	PA30271	791440111363	PA30304	791440112148	PA10224	791440112919	PA10149	791440113688	BF46203
791440110151	PA30279	791440111370	RS30305	791440112155	PA10395	791440112926	PA10325	791440113695	PA10254
791440110168	BF46156	791440111387	RS30306	791440112162	PA10376	791440112933	PA10139	791440113701	PA10194
791440110175	BF46157	791440111394	FB46185	791440112179	PA10284	791440112940	OB40078	791440113718	BF46208
791440110182	BF46158	791440111400	P40105	791440112186	PA10223	791440112957	PA10287	791440113725	PA10160
791440110199	BF46159	791440111417	.20048	791440112193	PA10195 KIT	791440112964	PA10229	791440113732	PA10273
791440110212	BF46161	791440111424	PA10128	791440112209	PA10217	791440112971	PA10375	791440113749	BF46210
791440110229	PF46137 KIT	791440111431	P40104	791440112216	PA10145 KIT	791440112988	.20058	791440113756	.20061
791440110304	PA10086	791440111448	PA10362	791440112223	PA10110	791440112995	PA10231	791440113763	.20062
791440110311	PA10080	791440111455	BT23631	791440112230	PA10390	791440113008	PA10389	791440113770	PA10218
791440110335	CV15011	791440111462	PA10363	791440112247	PA10232	791440113015	PA10148	791440113787	P40130
791440110359	PA10087	791440111479	P40113	791440112254	P40116	791440113022	PA10201	791440113794	.20044
791440110366	PA10096	791440111486	PA10364	791440112261	PA10142	791440113039	PA10235	791440113800	PA10397
791440110373	PA30263	791440111493	P40100	791440112278	PA10286	791440113046	PA10131	791440113817	PA10386
791440110397	BF7806-O	791440111509	PA0119	791440112285	B40126	791440113053	PA10256	791440113824	PA10154
791440110403	BF46162-O	791440111516	PA10278	791440112292	P40110	791440113060	PA10146	791440113831	PA10315
791440110410	BF798-O	791440111523	P40094	791440112308	FB46184	791440113077	PA10316	791440113848	PA10399
791440110427	BF46163-O	791440111530	PA10221	791440112315	PA10282	791440113084	SA10361	791440113855	PA10186 KIT
791440110434	BF46164-O	791440111547	PA10220	791440112322	.20045	791440113091	B40128	791440113862	.20060
791440110441	PF46140	791440111554	PA10129	791440112339	PA10371	791440113107	PA10385	791440113879	PA10249
791440110458	PA30272	791440111561	P40103	791440112346	PA10346	791440113114	BF46216	791440113886	PA10372
791440110465	PA30281	791440111578	PA0111	791440112353	PA10310	791440113121	BF46224	791440113893	PA10317
791440110472	.20029	791440111585	P40107	791440112360	PA10233	791440113138	PA10241	791440113909	PA10382
791440110496	B40063	791440111592	P40114	791440112377	PA10136	791440113145	PA10354	791440113916	.20065
791440110502	RS3516XP	791440111608	BF46194	791440112384	PA10159	791440113152	BF46205	791440113923	PA10193 KIT
791440110533	BK6117	791440111615	PA10130	791440112391	BF46209	791440113169	PA10303	791440113930	PA10314
791440110540	RS30282	791440111622	BT23630	791440112407	PA10219	791440113176	B40127	791440113947	BF46211
791440110564	PA30284	791440111639	PA10133	791440112414	.20037	791440113183	PA10238	791440113954	BF46221
791440110571	B40073	791440111646	PA10391	791440112421	PA10115	791440113190	P40086	791440113961	OB40080
791440110618	PT23624	791440111653	PA10367	791440112438	PA10289	791440113206	PA10373	791440113978	BF46206
791440110625	PT23625	791440111660	PA10290	791440112445	PA10296	791440113213	PA10368	791440113985	PA10213
791440110649	BK6118	791440111677	P40112	791440112452	P40115	791440113220	P40081	791440113992	PA10166
791440110656	BF46169-O	791440111684	.20054	791440112469	PA10109	791440113237	PA10119	791440114005	PA10150
791440110663	BF46170	791440111707	PA10379	791440112476	PA10294	791440113244	PA10144	791440114012	PA10172
791440110670	BT23619-MPG	791440111714	B40124	791440112483	PA10392	791440113251	PA10297	791440114029	.20033
791440110687	PA10097	791440111721	PA10275	791440112490	BF955 KIT	791440113268	PA10358	791440114036	PA10163
791440110694	PA30264	791440111738	PA10299	791440112506	PA10135	791440113275	PF46189	791440114043	PA10255
791440110700	PA10098	791440111745	BF46218	791440112513	BF46215	791440113282	PA10141	791440114050	PF46187
791440110717	PA10099	791440111752	PA10274	791440112520	PA10365 KIT	791440113299	PA10230	791440114067	.20051
791440110748	PF46171	791440111769	PA10279	791440112537	PA10355	791440113305	PA10234	791440114074	.20069
791440110755	RS30285	791440111776	PA10276	791440112544	PA10383	791440113312	BF46193	791440114081	PA10202
791440110779	.20030	791440111783	PA10369	791440112551	PA10304	791440113329	PA10305	791440114098	PA10356
791440110786	PA30287	791440111790	PA10280	791440112568	PA10113	791440113336	PA10312	791440114104	P40091
791440110793	SA10100	791440111806	PA10270	791440112575	PA10248	791440113343	PA10307	791440114111	PA10216 KIT
791440110816	BF1380-O	791440111813	P40095	791440112582	PA10300	791440113350	PA10264	791440114128	PA10335
791440110878	BF46064-D	791440111820	.20043	791440112599	.20042	791440113367	.20035	791440114135	.20055
791440110885	PF46172 KIT	791440111837	PA10291	791440112605	PA10387	791440113374	PA10308	791440114142	PA10345
791440110892	BF46173-O	791440111844	P40083	791440112612	PA10295	791440113381	PA10138	791440114159	PA10326
791440110915	PA10101	791440111851	PA10222	791440112629	P40089	791440113398	.20031	791440114166	PA10121
791440110922	PA10102	791440111868	PA10137	791440112636	PA10111	791440113404	PA10209 KIT	791440114173	P40118
791440110946	P40074	791440111875	BF46217	791440112643	PA10171	791440113411	.20053	791440114180	BF46219
791440110960	RS30290	791440111882	PA10267	791440112650	PA10301	791440113428	BF46225	791440114197	BF46198
791440110977	RS30291	791440111899	PA10283	791440112667	PA10164	791440113435	PA10147	791440114203	PA10394
791440110984	BF46175	791440111905	FB46183	791440112674	B40129	791440113442	PA10302	791440114210	PA10114
791440110991	PA10103	791440111912	BF46213	791440112681	PA10198 KIT	791440113459	P40093	791440114227	PA10196 KIT
791440111004	PA10104	791440111929	PA10197	791440112698	PA10225	791440113466	PA10239	791440114234	PA30302
791440111028	PA10106	791440111936	PA10281	791440112704	B40120	791440113473	PA10268	791440114241	.20066
791440111035	PA10107	791440111943	P40102	791440112711	PA10153	791440113480	PA10117	791440114258	PA10341
791440111059	P40076	791440111950	PA10380	791440112728	PA10131	791440113497	PA10298	791440114265	.20041
791440111073	PA30292	791440111967	PA10228	791440112735	BF46207	791440113503	PA10118	791440114272	RS10347
791440111080	PA30293	791440111974	P40109	791440112742	PA10269	791440113510	PA10204 KIT	791440114289	PA10271
791440111141	PA30299	791440111981	PA10285	791440112759	PA10152 KIT	791440113527	PA10237	791440114296	PA10243
791440111158	PA10108	791440111998	PA10132	791440112766	PA10293	791440113534	PA10191 KIT	791440114319	PA10257
791440111165	BF46176	791440112001	PA10292	791440112773	.20067	791440113541	PA10313	791440114326	PA10205 KIT



WARNING: These products can expose you to chemicals, including Diisononyl Phthalate, Carbon black extracts, Nickel, 1,3 Butadiene, Ethylene Oxide, Epichlorohydrin, which are known to the State of California to cause cancer, and Bisphenol-A, Ethylene Glycol, Ethylene Oxide, 1,3 Butadiene, Epichlorohydrin, which are known to the State of California to cause birth defects or other reproductive harm. For more information go to www.P65Warnings.ca.gov.

UPC TO BALDWIN (INDIVIDUAL PARTS)

UPC NUMBER	BALDWIN NUMBER	UPC NUMBER	BALDWIN NUMBER	UPC NUMBER	BALDWIN NUMBER	UPC NUMBER	BALDWIN NUMBER	UPC NUMBER	BALDWIN NUMBER
791440114333	PA10265	791440114821	PA10210 KIT	791440115323	PF46186	791440115880	BF46230	791440116443	PA10416
791440114340	PA10262	791440114838	PA10188	791440115330	PA10178	791440115897	PA30324	791440116450	PA10417
791440114357	PA10155	791440114845	PA10165	791440115347	PA10332	791440115903	PA30325	791440116481	CV15015
791440114364	PA10207	791440114852	PA10211 KIT	791440115354	B40121	791440115910	PA10404	791440116498	PF46241
791440114371	PA10208 KIT	791440114869	PT23633	791440115361	PA10339	791440115927	PA10405	791440116504	PA10418
791440114388	P40101	791440114876	PA10214	791440115378	PA10175 KIT	791440115958	BK6121	791440116511	PA10419
791440114395	PA10200	791440114883	PA10122	791440115385	PA10176	791440115965	BD40139	791440116528	PA10420
791440114401	PA10263	791440114890	PA10357	791440115392	PA10333	791440115972	PA10388	791440116535	BF46242
791440114418	PA10245	791440114906	BF46204	791440115408	PA10334	791440115989	PA10396	791440116542	PA10421
791440114425	PA10168	791440114913	PA10344	791440115415	PA10330	791440115996	PA10406	791440116559	PA10422
791440114432	P40098	791440114920	PA10190	791440115422	PA10340	791440116016	RS30327	791440116566	PA10423
791440114449	BF46223	791440114937	PA10244	791440115439	20057	791440116023	RS30328	791440116634	PA10424
791440114456	BF46200	791440114951	PA30303	791440115446	PA10126	791440116030	BK6116	791440116641	BF46244
791440114463	PA10370 KIT	791440114968	PA10321	791440115453	PA10174	791440116047	BF46233	791440116665	PA10425
791440114470	PA10242	791440114975	PA10125	791440115460	PA10247	791440116054	PA30329	791440116672	CV15016
791440114487	PA10250	791440114982	BF46196	791440115477	PA10177	791440116061	BF46234	791440116689	B40145
791440114494	PA10156	791440114999	PA10167	791440115484	PA10212 KIT	791440116078	PA10407	791440116696	BF46248
791440114500	PA10331	791440115002	PA10169	791440115491	PA10342	791440116085	PA30330	791440116771	BK6124
791440114517	PA10184	791440115019	PA10182	791440115507	PA10381	791440116092	20070	791440116788	PA30333
791440114524	BF46201	791440115026	RS10349	791440115514	PA10400	791440116108	PF46235	791440116801	PA10426
791440114531	PA10162	791440115033	BF46199	791440115521	RS30307	791440116115	PF46236	791440116849	PF46250
791440114548	PA10120	791440115040	BF46202	791440115538	RS30308	791440116122	PF46237	791440116856	PA10427
791440114555	PA10327	791440115057	BF46214	791440115569	BF46227	791440116139	PF46238	791440116863	PA10428
791440114562	20046	791440115064	PA10336	791440115576	B40133	791440116146	PA10408	791440116870	SA10429
791440114579	PA10123	791440115071	PA10251	791440115583	PA30309	791440116153	PA10409	791440116887	PA10430
791440114586	20050	791440115088	PA10206 KIT	791440115590	PA10401	791440116160	BK6114	791440116894	PA10431
791440114593	PA10329	791440115095	PA10253	791440115606	P40134	791440116184	B40140	791440116924	B40150
791440114609	PA10323	791440115101	PA10260	791440115613	PA10402	791440116221	BK6102	791440116931	BF46251-SP
791440114616	PA10318	791440115118	RS10348	791440115675	PT23637-MPG	791440116238	BK6103	791440116948	BF46252-SP
791440114623	P40117	791440115125	PA10180 KIT	791440115682	PA10403	791440116245	BK6104	791440116955	BF46256
791440114630	PA10384	791440115132	PA10337	791440115699	B40136	791440116252	BK6108	791440116993	20071
791440114647	PA10343	791440115149	BF46197	791440115705	PA30310	791440116269	BK6105	791440117006	20072
791440114654	SA10360	791440115156	PA10398	791440115712	B40137	791440116276	BK6106	791440117013	BK6130
791440114661	RS10351	791440115163	PA10353	791440115729	B40138	791440116283	BK6107	791440117068	PF46258
791440114678	PA10266	791440115170	PA10185	791440115736	BF46228	791440116290	BK6115	791440117112	PA10433
791440114685	P40132	791440115187	P40085	791440115743	RS30311	791440116306	BK6120	791440117136	PA10435
791440114692	PA10183	791440115194	PA10328	791440115767	RS30313	791440116313	PA10410	791440117143	PA10436
791440114708	PA10259	791440115217	PA10215 KIT	791440115774	PA30314	791440116320	PA10411	791440117167	PA10438
791440114715	B40125	791440115224	20068	791440115781	PA30315	791440116337	PA10412	791440117174	PA10439
791440114722	PA10203 KIT	791440115231	PA10338	791440115798	PA30316	791440116351	B40142	791440117181	PA10440
791440114739	P40096	791440115248	PF46188	791440115804	PA30317	791440116368	PE17002 KIT	791440117198	PF46259
791440114753	PA10170 KIT	791440115255	PA10157	791440115811	PA30318	791440116375	PA30331	791440117211	PA10441
791440114760	BF46192	791440115262	PA10173	791440115828	PA30319	791440116382	PA10413	791440117310	P40156
791440114777	PA10189	791440115279	PA10261	791440115835	PA30320	791440116399	PA30332	791770098275	BT23140-MPG
791440114784	P40131	791440115286	BF46222	791440115842	PA30321	791440116405	PF46152		
791440114791	PA10258	791440115293	PA10158	791440115859	PA30322	791440116412	PA10414		
791440114807	BF46220	791440115309	RS10350	791440115866	PA30323	791440116429	P40143		
791440114814	PA10319	791440115316	PA10124	791440115873	BF46229	791440116436	PA10415		

NOTES



WARNING: These products can expose you to chemicals, including Diisononyl Phthalate, Carbon black extracts, Nickel, 1,3 Butadiene, Ethylene Oxide, Epichlorohydrin, which are known to the State of California to cause cancer, and Bisphenol-A, Ethylene Glycol, Ethylene Oxide, 1,3 Butadiene, Epichlorohydrin, which are known to the State of California to cause birth defects or other reproductive harm. For more information go to www.P65Warnings.ca.gov.

BALDWIN CASE TO 1/2/5 (SHIPPING CASES)

BALDWIN CASE NUMBER	I 2/5 NUMBER	BALDWIN CASE NUMBER	I 2/5 NUMBER	BALDWIN CASE NUMBER	I 2/5 NUMBER	BALDWIN CASE NUMBER	I 2/5 NUMBER	BALDWIN CASE NUMBER	I 2/5 NUMBER	BALDWIN CASE NUMBER	I 2/5 NUMBER
107914400001512	B2	1079144000113512	PT89	1079144000216312	P172	1079144000315312	B255	1079144000412912	BT354		
107914400002212	B2-HPG	1079144000114212	PT90-10	1079144000217012	B173-S	1079144000316012	PT256	1079144000413612	BT355		
107914400004612	B4	1079144000115912	PT90-MPG	1079144000218712	P174	1079144000317712	PT257	1079144000414312	P356		
107914400005312	BT5	1079144000116612	PT91	1079144000220012	P176	1079144000318412	PT258	1079144000415012	BT357		
107914400006012	B6	1079144000118012	PT93	1079144000221712	P177	1079144000319112	BT259	1079144000416712	B358		
107914400007712	B6-HPG	1079144000119712	PT93-MPG	1079144000222412	B178	1079144000320712	BT260	107914400041746	BT359		
107914400008412	B7	107914400012106	B95	1079144000223112	B179	1079144000321412	BT260-10	1079144000418112	B360		
107914400009112	B9	107914400012416	B95-MPG	1079144000226210	G183	1079144000322112	BT261	1079144000419812	BT361		
10791440001076	B10-AL	107914400012586	B96	1079144000227912	P183	1079144000323812	B262	1079144000421112	BT364		
10791440001146	B10-AL BOWL	107914400012896	B96-MPG	1079144000229312	P184	1079144000324512	B263	1079144000422812	BT365		
10791440001216	B10-AL CAP	107914400012966	B97	1079144000230912	PT185	1079144000325212	BT264	1079144000423512	BT365-10		
107914400013812	PF10	107914400013026	PT98-10	1079144000231612	P186	1079144000326912	PT265	1079144000424212	BT366-10		
107914400014512	PF10-CS	107914400013196	PT98-MPG	1079144000232312	P187	1079144000327612	P266	1079144000425912	BT367		
107914400015212	PT11	107914400013266	B99	1079144000234712	PT189	1079144000328312	BT267	1079144000426612	BT367-S		
107914400016912	PT11-HD	107914400013336	B99-B	1079144000235412	PT189-MPG	1079144000329012	PT268	1079144000427312	BT368		
107914400017612	PT12	107914400013576	B99-MPG	1079144000236112	P190	1079144000330612	PT269	1079144000428012	B369		
107914400018312	BF13	1079144000137118	101-30	107914400023856	PT191-10	1079144000332012	P271	107914400042974	PT370		
107914400019012	P15	1079144000138812	P102	107914400024466	P194	1079144000334412	PT273	1079144000430312	BT371-10		
107914400020612	S16-1	107914400013956	BD103	107914400024536	P194-HD	1079144000335112	BT274	1079144000431012	BT371-MPG		
107914400023712	P18	1079144000140112	P104	107914400024606	P194-HD10	1079144000336812	PT275	1079144000432712	BT372-10		
107914400024412	P18-HD	107914400014186	B105	107914400024776	PF194	1079144000337512	PT275-10	1079144000433412	PT373		
107914400025112	P19	1079144000142512	P106	1079144000248412	B195	1079144000338212	P276	1079144000434112	PT374		
107914400026812	P20-HD	1079144000143212	P106-HD	107914400024916	B196	1079144000340512	PT277	1079144000435812	PT375		
107914400033612	P25	1079144000145612	PT108	1079144000251412	P198	1079144000341212	B279	1079144000436512	PT376		
107914400034312	P26	1079144000146312	PT108-HD	1079144000252112	B199	1079144000342912	P280	1079144000437212	PT377		
107914400035012	B27	1079144000147012	B109	1079144000254512	B201-S	1079144000343612	B281	1079144000438912	PT377-10		
107914400036712	BD28	1079144000148712	BC110	1079144000255212	B202	1079144000346712	PT283	1079144000439612	B378		
107914400037412	PT29	1079144000149412	BT111	1079144000256912	P203	1079144000347412	PT284	1079144000440212	B378-10		
107914400039812	B30	1079144000150012	BT112	1079144000257612	P203-HD	107914400034816	PT285	107914400044196	PT379 KIT		
107914400040412	B31	1079144000151712	B113	1079144000258312	P203-HD10	107914400034986	BT287	1079144000443312	PT381		
107914400042812	B33	1079144000152412	B114	1079144000259012	P204	107914400035046	BT287-10	1079144000444012	PT382		
107914400043512	B34	1079144000153112	PT115	1079144000260612	P204-HD	1079144000351112	PT288-HD	1079144000445712	PT383		
107914400044212	B35-S	107914400015556	PF116	1079144000261312	P204-HD10	1079144000352812	PT288-HD10	1079144000446412	PT385		
10791440004666	AFG37R	107914400015626	PT117	107914400026206	B205	1079144000353512	PT289	1079144000447112	PT385-E		
107914400047312	B37	107914400015796	PT117-25	1079144000263712	P206	1079144000354212	PT289-10	1079144000448812	PT386		
10791440004806	AFG38D	1079144000158612	B118	1079144000264412	PT207	1079144000355912	PT290	107914400044956	BT387		
107914400050312	B39	1079144000164712	B120	1079144000265112	PT207-10	1079144000357312	BT292	107914400045016	BT387-10		
107914400051012	P40	1079144000165412	PF121	1079144000266812	PT207-HD	1079144000359712	P294	107914400045186	BT388		
107914400052712	P41	1079144000168512	BT124	1079144000267512	PT207-HD10	1079144000360312	B295	107914400045256	BT388-10		
107914400053412	P42	1079144000169212	P125	107914400026826	PT208	1079144000361012	B296	107914400045326	BT389		
107914400054112	B43-S	1079144000170812	BT126	1079144000269912	PT210	1079144000362712	PT298-10	107914400045496	BT389-10		
107914400056512	B45	1079144000171512	B128	1079144000270512	B211	1079144000363412	B299	1079144000455612	PT390-MPG		
107914400058912	P47	1079144000172212	B129	1079144000272912	PT213	1079144000364112	T300-M	1079144000456312	PT391-MPG		
107914400059612	PT48	1079144000174612	B131	1079144000273612	PT214(2)	1079144000365812	B301	1079144000457012	PT392		
10791440006026	B49	1079144000175312	B132	1079144000274312	BT215	1079144000366512	PT302	1079144000458712	PT393		
107914400061912	B50	107914400017607	C133-OW	1079144000275012	BT216	1079144000367212	T303-M	107914400045946	PT394-15		
107914400063312	P52	107914400017777	C133-W	1079144000276712	BT217	1079144000368912	PT304	1079144000460012	BT395		
107914400064012	P53	1079144000178412	B134	1079144000277412	B218	1079144000370212	B307	1079144000461712	PT396		
107914400065712	P54	1079144000179112	PT135	107914400027986	B220	1079144000371912	T308-M	107914400046244	PT397		
107914400067112	B56	1079144000181412	PT137	1079144000280412	BT221	1079144000372612	B309	1079144000463112	BT398		
107914400071812	P60	1079144000182112	PT138-10	1079144000281112	B222	1079144000373312	PF311	107914400046486	PT400		
107914400072512	PT61-HD	1079144000183812	PT138-25	1079144000282812	BT223	1079144000374012	PF312	107914400046556	PT401-MPG		
107914400073212	PT62	1079144000184512	PT139-10	1079144000283512	PF224	1079144000375712	PF313	1079144000466212	BT402		
107914400074912	PT63-1	1079144000185212	P140	1079144000285912	PF225	1079144000376412	PF314	1079144000467912	B403		
107914400077012	PT66-HD	1079144000186912	B141	1079144000287312	PF226	107914400037716	PF316	107914400046866	B404		
107914400078712	P67	1079144000187612	BD142	1079144000288012	B227	107914400038566	BD324	1079144000469312	JC405		
107914400079412	P68	1079144000188312	B143	1079144000289712	B228	1079144000386312	B326	1079144000470912	CU406		
107914400081712	PT70	1079144000189012	P144	1079144000290312	B229	1079144000388712	B329	107914400047166	DF408		
107914400083112	PT71	1079144000190612	PT146	1079144000291012	BT230	1079144000389412	BF330	1079144000484612	TC413-CP5E		
107914400085512	PT72	1079144000192012	P148	1079144000292712	PF231	1079144000390012	PF332	107914400048604	V414-B		
107914400087912	P73	1079144000194412	P150	1079144000293412	B233	107914400039176	B333	107914400048774	V414-FB		
107914400088612	B74	1079144000195112	PT151	107914400029586	BT234	1079144000392412	BT334	107914400048844	F415-B		
107914400089312	B75	1079144000196812	PT152	1079144000296512	P235	1079144000394812	B336	107914400048914	P415-10		
107914400090912	B76	1079144000197512	PT153	1079144000297212	B236	1079144000395512	B337	107914400049074	P415-10A		
107914400093012	B76-MPG	1079144000198212	PT154	1079144000298912	BT237	1079144000396212	BT338	107914400049144	P415-25		
107914400096112	PT79	1079144000199912	PF155	1079144000299612	BT238	1079144000397912	BT339	107914400049214	P415-25A		
107914400098512	P80	1079144000200212	B156	107914400030096	B239	1079144000398612	BT340	107914400049384	P415-5		
107914400099212	P80-HD	1079144000201912	B157	1079144000301612	P240	1079144000399312	BT341	107914400049454	P415-5A		
107914400101212	P81	1079144000203312	B159	1079144000302312	BT241	1079144000400612	BT342	107914400049524	P415-5AN		
107914400102912	P82	1079144000204012	B160	1079144000303012	P242	107914400040136	BT343	107914400049694	P415-GM		
107914400103612	PT82-HD	1079144000205712	B161-S	1079144000304712	B243	1079144000402012	BT344-S	107914400049764	V415-B		
107914400104312	PT82-HD10	1079144000206412	P162	1079144000305412	B244	1079144000404412	BT346	107914400049834	V415-FF		
10791440010506	PT83	1079144000207112	B163	1079144000307812	B246	1079144000405112	BT347	1079144000499012	PT416		
10791440010676	PT83-MPG	1079144000208812	B164	1079144000308512	B247	1079144000406812	BT348	107914400050104	PT418		
107914400108112	P84-2	1079144000210112	B166	1079144000309212	BT248	1079144000407512	BT349	1079144000503412	BT420		
107914400109812	PT85	1079144000211812	B167	1079144000310812	P249	1079144000408212	BT350	1079144000504112	B421		
107914400110412	PT86-HD	1079144000212512	B168	1079144000311512	BT251	1079144000409912	BT351	1079144000505812	S423		
107914400111112	PT87-S	1079144000214912	P170	1079144000312212	B252	107914400041056	P352	107914400050656	BT424		
107914400112812	PT88-HD	1079144000215612	P171	1079144000313912	B253	1079144000411212	BT353	107914400050726	BT425		

BALDWIN CASE TO I 2/5 (SHIPPING CASES)

BALDWIN CASE NUMBER	I 2/5 QTY. NUMBER	BALDWIN CASE NUMBER	I 2/5 QTY. NUMBER	BALDWIN CASE NUMBER	I 2/5 QTY. NUMBER	BALDWIN CASE NUMBER	I 2/5 QTY. NUMBER	BALDWIN CASE NUMBER	I 2/5 QTY. NUMBER	BALDWIN CASE NUMBER	I 2/5 QTY. NUMBER
1079144000508912	PT426	107914400061856	PT534	107914400074726	PA662	1079144000867712	PF802	1079144000971112	BF886		
1079144000509612	BT427	1079144000619212	PT535	107914400075196	PA669	1079144000869112	PF804	1079144000972812	BF888		
107914400051194	V429-B	1079144000620812	BT536	1079144000752612	PT670	1079144000870712	BF805	1079144000974212	BF890		
107914400051264	V429-FF	107914400062156	P537	1079144000753312	PT670-E	1079144000871412	BF806	1079144000975912	BF891		
107914400051336	PT430-FF	1079144000622212	PT538	107914400075646	PA675	1079144000872112	PF807	1079144000976612	BF892		
1079144000514012	PT431	1079144000624612	P540	107914400075886	PA677	1079144000874512	PF809	1079144000977312	PF893		
1079144000515712	PT433	1079144000626012	BT541	107914400075956	PA678	1079144000875212	PF810	1079144000978012	PF893-RV		
1079144000516412	PT434	107914400062846	PT543 KIT	107914400076016	PA680	1079144000876912	PF811	1079144000979712	PF894		
1079144000517112	PT434-10	1079144000630712	P545	1079144000761812	PT685-MPG	1079144000877612	BF812	1079144000980312	PF894-RV		
1079144000518812	PT435	1079144000631412	PT546	107914400076256	PA691	1079144000879012	PF814	1079144000982712	BF896		
1079144000519512	PT436	107914400063216	PT548	107914400076326	PA693	1079144000881312	PF816	1079144000984112	SF898		
1079144000520112	PT437	1079144000633812	PT549	107914400076636	PA696	1079144000882012	PF816-S	1079144000985812	PF899		
1079144000521812	BT438	107914400063456	PT550-10	107914400076706	PA697	1079144000884412	PF818	1079144000986512	BF900		
1079144000522512	PT439	1079144000637612	PT554	107914400076876	PA699	1079144000885112	PF819	1079144000988612	PF902		
1079144000523212	BT440	1079144000638312	P555	107914400077244	C704-L	1079144000886812	PF819-HD	1079144000990212	PF902-S		
1079144000524912	PT441	1079144000639012	BT556-10	107914400077484	P706-M	1079144000887512	PF820-S	1079144000991912	PT903		
1079144000525612	PT442-MPG	107914400064136	PT558	1079144000776212	PT707-HD	1079144000888212	PF821-S	1079144000995712	PF906		
107914400052636	BT443	1079144000643712	PT561	107914400077912	PT707-HD10	1079144000889912	PF822	1079144000996412	PF907		
1079144000527012	PT445-MPG	1079144000645112	PT562-10	1079144000778612	PT707-HD3	1079144000890512	PF823	107914400099716	F908-A		
1079144000528712	P446	1079144000646812	PT563	1079144000779312	PT708-HD	1079144000895012	PF823-E	1079144000998812	BF909		
1079144000529412	B447	1079144000647512	BT564	107914400078096	PT714	1079144000896712	PF824	1079144000999512	PF910		
1079144000531712	PA450	107914400064826	PT565	1079144000781612	PF717	1079144000898112	BF825	1079144001002112	BF912		
1079144000532412	S451	1079144000649912	PT566	107914400078304	P718-5	1079144000899812	PF826	1079144001003812	PF913		
1079144000533112	BT452	1079144000650512	PT567	1079144000784712	BF719	1079144000900112	PF827	107914400100456	BF914		
1079144000535512	PA454	1079144000651212	PT567-10	1079144000785412	BF720	1079144000902512	PF828	1079144001005212	BF915		
1079144000536212	S455	1079144000652912	PT568	1079144000786112	P721	107914400090326	PF829(2)	1079144001006912	F916-C		
1079144000537912	S456	1079144000660412	BF577	107914400078786	PT722	1079144000904912	BF830	1079144001007612	PF916		
107914400053866	PT457-MPG	1079144000661112	PT578	1079144000788512	P723	1079144000905612	PF831	1079144001010612	BF918-K		
1079144000539312	PT459	1079144000662812	PT579	107914400078926	PT725-MPG	1079144000907012	BF833	1079144001014460	F919-C		
1079144000540912	PT461	1079144000667312	BF582	1079144000790824	PT727-DL	1079144000908712	BF833-K2	1079144001019912	BF920		
107914400054166	PT462	1079144000668012	BF583	1079144000791512	PT727-HD	1079144000909412	BF834-F	1079144001023612	PF924		
1079144000542312	PT463	1079144000669712	BF584	1079144000792212	PT727-HD10	1079144000910012	PF834	1079144001025012	PF926		
1079144000545412	PT466	1079144000670312	BF584-B	1079144000793912	PT728-MPG	1079144000912412	BF836	1079144001027412	BF928		
107914400054616	PT467-MPG	1079144000671012	BF585	107914400079464	PT729	1079144000913112	BF836-K3	1079144001028112	BF929		
1079144000547812	PT468-MPG	1079144000672712	BF586	107914400079776	BT732	1079144000914812	BF836-K4	1079144001029812	BF930		
1079144000549212	BT470	1079144000673412	BF586-D	1079144000799112	BT735	1079144000915512	BF837	1079144001032812	BF932		
1079144000550812	PT471	1079144000674112	BF587	1079144000801112	PT737	1079144000916212	BF838-F2	1079144001033512	PF933		
1079144000551512	BT472	1079144000675812	BF587-D	1079144000802812	PT737-10	1079144000917912	PF838	1079144001035912	PF935		
1079144000552212	B474	1079144000676512	BF588	1079144000803512	V738-0	1079144000918612	BT839	1079144001036612	PF936		
1079144000553912	PT475	1079144000687112	BF591	1079144000804212	W739	1079144000919312	BT839-10	1079144001037312	PF937		
1079144000554612	PA476	1079144000688812	BF592	1079144000805912	C740-S	1079144000920912	BF840	1079144001038012	BF938		
1079144000555312	PT477	1079144000689512	BF593	107914400081414	C750-E	1079144000921612	BF840-K1	1079144001039712	BF939		
1079144000557712	S479	1079144000690112	PF594	107914400081584	C750-L	1079144000923012	VT842-O	1079144001040312	BF940		
1079144000558412	PT480	1079144000691812	BT595	107914400081726	PT751	1079144000924712	BF843	1079144001041012	BF941		
1079144000559112	PT480-10	107914400069256	BF596	107914400081896	PT752	1079144000925412	BF844-A	1079144001042712	PF942		
1079144000560712	PT480-MPG	1079144000693212	BF597	107914400082196	PT757	1079144000926112	BF845-A	1079144001043412	PF943		
1079144000561412	B481	1079144000694912	PF598	107914400082266	PT757-10	1079144000927812	PF845	1079144001045812	PF945		
1079144000565212	S485	1079144000695612	PF598-10	1079144000824012	PT760-10	1079144000928512	PF846	1079144001046512	PF946		
107914400056696	BT486	1079144000696312	PF598-30	1079144000825712	PT760-25	1079144000929212	PF847	1079144001047212	PF947		
1079144000567612	PT487	1079144000697012	PF599	1079144000826412	PT761	1079144000931512	PT849	1079144001048912	BF948		
1079144000569012	B488	1079144000698712	PF599-10	107914400082886	PT763	1079144000932212	PT849-10	1079144001051912	BF948-JD		
1079144000570612	S489	1079144000699412	PF599-30	1079144000829512	PT764	1079144000935312	V852-O	1079144001053312	F950-F		
1079144000575112	PT492	107914400070076	PA602	1079144000830112	PT765	1079144000936012	BF853	1079144001054012	PF950		
107914400057686	PT493	107914400070146	PA604	107914400083186	PT766	1079144000938412	BF855	1079144001055712	PT951		
1079144000577512	B494	1079144000702112	B605	107914400083256	PT767	1079144000939112	BF856	1079144001056412	PF952		
107914400057826	B495	107914400070456	PA607	107914400083326	PT768	1079144000940712	PF857	1079144001057112	BF954		
1079144000581212	PA96	107914400070836	PA612	107914400083706	PT772	1079144000941412	BF858	1079144001058812	BF955		
1079144000582912	P497	107914400070906	PA613	107914400083876	PT773-MPG	1079144000942112	PF859	1079144001059512	BF956		
1079144000583612	PT498	1079144000710612	BF614	107914400084006	BT775	1079144000943812	PF860	1079144001060112	BF957		
1079144000584312	PT498-10	107914400071136	PA615	1079144000841712	PT776-MPG	1079144000944512	PF861	1079144001062512	BF957-D		
107914400058814	F501-MD	107914400071516	PA618 FOAM	1079144000842412	PT777	1079144000945212	BF862	1079144001063212	BF958		
1079144000592812	PF506	107914400071826	PA621	1079144000843112	BT778	1079144000946912	BF863	1079144001064912	BF959		
1079144000593512	P507	107914400071996	PA625	1079144000844812	BT779	1079144000947612	PF864	1079144001065612	P960		
1079144000594212	PT508-MPG	107914400072056	PA631	1079144000845512	BF781	1079144000948312	BF865	1079144001067012	PF962		
1079144000596612	PT510	107914400072126	PA632	1079144000846212	BF782	1079144000949012	BF865-K	1079144001068712	PF963		
107914400059734	PT512	1079144000722912	PA633(2)	1079144000847912	BF783	1079144000950612	PF866	1079144001071712	BF966		
1079144000598012	PT513	107914400072366	PA634	107914400084866	BF784	1079144000952012	BF868	1079144001072412	PF967		
1079144000599712	PT514	107914400072434	PA638	107914400084936	BF785	1079144000953712	PF869	1079144001073112	BF968		
107914400060004	PT515	107914400072676	PA640	1079144000850912	BF786	1079144000955112	PF872	1079144001074812	BF970		
1079144000601712	PT516	107914400072816	PA642	1079144000852312	BF788	1079144000956812	BF873	1079144001075512	BF971		
1079144000602412	PT517	1079144000729812	PA643	1079144000853012	BF789	1079144000957512	BF874	1079144001077912	BF974-D		
107914400060556	PT520	1079144000730412	PA644	1079144000854712	BF790	1079144000959912	BF876	1079144001078612	B975		
1079144000607912	BT521	107914400073356	PA648	1079144000855412	BF791	1079144000961212	BF877	1079144001079312	BF976		
1079144000608612	PT522	107914400073426	PA649	1079144000856112	BF792	1079144000964312	BF879	1079144001081612	BF978		
1079144000609312	BT525	107914400073596	PA650	1079144000858512	BF794	1079144000966712	BF881	1079144001082312	BF979		
1079144000610912	BT526	107914400073664	PA651	1079144000859212	BF795	1079144000967412	PF882	1079144001083012	PF980		
1079144000611612	BT526-10	107914400073736	PA652	1079144000861512	BF797	1079144000968112	PF883	1079144001084712	PF981		
1079144000613012	P528	107914400074276	PA657</								

BALDWIN CASE TO I 2/5 (SHIPPING CASES)

BALDWIN CASE NUMBER	QTY.	I 2/5 NUMBER	BALDWIN CASE NUMBER	QTY.	I 2/5 NUMBER	BALDWIN CASE NUMBER	QTY.	I 2/5 NUMBER	BALDWIN CASE NUMBER	QTY.	I 2/5 NUMBER	BALDWIN CASE NUMBER	QTY.	I 2/5 NUMBER
1079144001088512		PF987	107914400134116		PA1721	107914400159896		PA2083	107914400192606		PA2472	107914400291606		BT8320
1079144001089212		BF988	107914400134426		PA1735	1079144001599612		SA2084	107914400193076		PA2476	107914400291916		BT8802-MPG
1079144001090812		BF989	1079144001346612		PA1748	1079144001600912		SA2085	107914400193146		PA2477	107914400292076		BT8803-MPG
1079144001092212		BF991	1079144001353412		PA1757	107914400160546		PA2091	107914400193766		PA2483	107914400292386		BT8812-MPG
1079144001093912		BF992	107914400135416		PA1758	107914400160616		PA2092	107914400213176	PA2653 FOAM		107914400299866		18104
1079144001095312		BF995	1079144001355812		PA1763	107914400160856		PA2094	1079144002278912		PA2798	107914400300126		18139
1079144001096012		P996	1079144001357212	PA1765 FOAM		107914400160924		PA2095	107914400265586		PA4016	107914400300366		18155
1079144001097712		P998	107914400137566		PA1786	107914400161086		PA2096	107914400265656		PA4018	107914400300506		18171
1079144001099112		P999-HD	107914400138316		PA1798	107914400161156		PA2099	107914400265896		PA4023	107914400300746		18198
1079144001106612		V1044-H	107914400138486		PA1800	107914400161226		PA2100	107914400265966		PA4026	107914400301116		18236
1079144001107312		BF1102	107914400138626		PA1802	107914400161396		PA2101A	107914400266026		PA4028	107914400301286		18245
1079144001109712		BF1104	107914400138866		PA1805	107914400161466		PA2102	107914400266576		PA4050	107914400303406		19828
1079144001110312		BF1105	107914400139164		PA1809	107914400161536		PA2103	107914400266886		PA4060	107914400304496		19992
1079144001114112		BF1110	107914400139476		PA1814	107914400161606		PA2104	1079144002674912		CS5007	107914400304636		BT8307-MPG
1079144001117212		BF1120	107914400140746		PA1828	107914400161846		PA2106	1079144002675612		CS5008	107914400304706		BT8308-MPG
1079144001118912		BF1123	107914400141046		PA1832	107914400161916		PA2107	107914400267636		CS5009	1079144003493512		61
1079144001125712		BF1140	107914400141116		PA1834	107914400162146		PA2109	107914400267944		CS5012	1079144003494212		61-W
1079144001128812		BF1148	107914400141666		PA1841	107914400162216		PA2110	107914400268936		CS5058	1079144003498012		66
1079144001129512		BF1150	107914400142656		PA1852	107914400162526		PA2113	1079144002690910		OTK5060	1079144003499712		66-W
1079144001134912		BF1160	107914400142966		PA1857	107914400162696		PA2114	1079144002691612		OTK5061	1079144003557418		101
1079144001136312		BF1163	107914400143026		PA1858	107914400162766		PA2115	1079144002693010		OTK5063	1079144003559818		101-W
1079144001138712		BF1166	107914400143196		PA1859	107914400162834		PA2116	1079144002694712		BW5070	1079144003581818		151
1079144001142412		BF1170	107914400143266		PA1860	107914400162906		PA2117	1079144002695412		BW5071	1079144003592518		151-30
1079144001143112		BF1171	107914400143336		PA1861	107914400163206		PA2121	1079144002696112		BW5072	1079144003593218		151-W
1079144001144812		BF1201	107914400144184		PA1873	107914400163516		PA2124	1079144002698712		BW5073	107914400364658		201
1079144001147912		BF1210	107914400144254		VI874-T	107914400163686		PA2125	1079144002698512		BW5074	107914400364728		201-30
1079144001148612		BF1211	1079144001443212		PA1875	107914400163826		PA2127	1079144002699212		BW5075	107914400364968		201-W
1079144001149312		BF1212	107914400145626		PA1888	107914400164506		PA2134	1079144002700512		BW5076	107914400369534		301
1079144001150912	BF1212 FOAM		107914400145796		PA1889	107914400164676		PA2135	1079144002704312		B5134	107914400369604		301-30
1079144001152312		BF1213	107914400145866		PA1891	107914400164746		PA2136	1079144002705012		BW5136	107914400369774		301-CS
1079144001153012		BF1214	1079144001477712		PA1909	107914400164986		PA2138	1079144002706712		BW5137	107914400369844		301-W
107914400115476		BF1216	1079144001481412		PA1915	107914400165046		PA2139	1079144002707412		BW5138	107914400370594		501
1079144001155412		BF1218	107914400149374		PA1934	107914400165116		PA2140	1079144002708112		BW5139	107914400370664		501-30
1079144001156112		BF1219	107914400150196		PA1946	107914400165736		PA2147	1079144002709812		BW5140	107914400370734		501-W
1079144001157812		BF1220	107914400150266		PA1949	107914400165806		PA2148	1079144002710412		BW5141	1079144003757812		PT8344
1079144001158512		BF1221	107914400150406		PA1951	107914400165976		PA2149	1079144002712812		B5176	1079144003758512		P7053
1079144001159212		BF1223	107914400151256		PA1963	107914400166036		PA2150	1079144002713512		B5177	1079144003761512		BD7028
1079144001160812		BF1225	107914400151496		PA1969	107914400166276		PA2152	1079144002714212		BW5178	1079144003782212		B7051
1079144001161512		BF1226	107914400151706		PA1973	107914400166346		PA2153	1079144002715912		BW5179	1079144003783912		PF7549
1079144001163912		BF1232	1079144001529312		PA1985	107914400166416		PA2154	1079144002718012		BF5801	1079144003788412		PF7550
1079144001164612		BF1233	107914400154226		PA2001	107914400166656		PA2156	1079144002719712		BF5800	1079144003789112		PF7551
107914400116778		VI240-C	107914400154396		PA2002	107914400166896		PA2158	1079144002720312		BF5810	1079144003774512		BF7552
1079144001169112		BF1259	107914400154536		PA2005	1079144001669612		SA2159	1079144002721012		BF5812	1079144003785112		B7039
1079144001170712		BF1276	107914400154606		PA2006	107914400167026		PA2160	1079144002722712		BF5813	1079144003788212		BF7546
1079144001171412		BF1280	107914400154776		PA2007	107914400167266		PA2162	107914400272896		6017	1079144003789912		BF1345
1079144001203212		B1400	107914400154846		PA2008	107914400167336		PA2163	107914400273026		6020	1079144003796712		BF7544
1079144001205612		B1402	107914400154916		PA2009	107914400167406		PA2164	1079144002731912		6021	1079144003798112		BF7541
1079144001208712		B1406	107914400155076		PA2010	107914400167716		PA2167	107914400284843		P7003	1079144003799812		BF880-FP
1079144001209412		B1407	107914400155386		PA2023	107914400167886		PA2168	107914400284916		B7004	1079144003805612		BT305
1079144001212412		B1428	107914400155456		PA2024	107914400167956		PA2169	107914400285076		B7005	1079144003806312		B7047
107914400121794		P1510	1079144001556912		SA2027	107914400168186		PA2171	1079144002853812		B7009	1079144003807012		PT8345
107914400121864		P1511	107914400155766		PA2031	107914400168876		PA2178	1079144002854512		B7010	1079144003808712		BT8328
107914400121934		VI520-R	107914400156066		PA2036	107914400169176		PA2181	107914400285526		B7011	1079144003811712		P7035
107914400122166		VI542-C	107914400156136		PA2037	107914400169626		PA2188	1079144002856912		B7014	1079144003812412		BT372-MPG
1079144001222316		VI544-T	1079144001563712		SA2039	107914400169796		PA2189	1079144002857612		B7018	107914400381316		P7000 KIT
1079144001223012		PA1600	107914400156446		PA2041	107914400169936		PA2191	107914400285836		B7019	1079144003821612		B1429
1079144001225412		PA1603	107914400156514		PA2042	107914400170136		PA2193	1079144002859012		B7020	1079144003824712		PF7553
107914400125206		PA1627	107914400156686		PA2044	107914400170206		PA2194	1079144002860612		B7022	1079144003825412		PF7554
107914400126056		PA1633	107914400156896		PA2050	107914400170446		PA2196	1079144002861312		B7023	107914400382926		BT8347
107914400126816		PA1639	107914400157056		PA2051	107914400171126		PA2204	1079144002862012		B7024	1079144003834612		BF7559
1079144001274212		F1645-DS	107914400157126		PA2052	107914400171436		PA2207	1079144002863712		B7025	1079144003835312		BF1346
107914400127597		VI645-C	107914400157296		PA2053	107914400171506		PA2208	107914400287124		F7500	1079144003838412		B7044
107914400128036		PA1648	107914400157746		PA2061	107914400171986		PA2212	107914400287294		P7500	107914400383916		BT8840-MPG
107914400128656		VI656-O	107914400157986		PA2063	107914400172116		PA2214	1079144002876712		BF7519	107914400384076		BT8862
107914400128726		VI656-T	107914400158046		PA2064	107914400172356		PA2216	1079144002882812		BF7528	107914400384146		BT8863
107914400128896		PA1657	107914400158116		PA2065	107914400172596		PA2218	1079144002883512		BF7529	1079144003845212		BD232
107914400128966		PA1661(3)	107914400158356		PA2067	107914400172806		PA2221	1079144002885912		BF7538	1079144003846912		BT310
1079144001292612		PA1666	107914400158426		PA2068	107914400172976		PA2222	1079144002886612		BF7557	1079144003858212		PA2139 FOAM
1079144001303912		PA1679	107914400158596		PA									

BALDWIN CASE TO I 2/5 (SHIPPING CASES)

BALDWIN CASE NUMBER	CASE QTY.	I 2/5 NUMBER	BALDWIN CASE NUMBER	CASE QTY.	I 2/5 NUMBER	BALDWIN CASE NUMBER	CASE QTY.	I 2/5 NUMBER	BALDWIN CASE NUMBER	CASE QTY.	I 2/5 NUMBER	BALDWIN CASE NUMBER	CASE QTY.	I 2/5 NUMBER	BALDWIN CASE NUMBER	CASE QTY.	I 2/5 NUMBER
107914400389406		PT8330-MPG	1079144004566512		BF1222-SP	1079144004904512		BF1179	107914400513526		18022	107914400546676		PA4107			
107914400389576		BT8333	1079144004567212		BF1222	1079144004908312		BF1181	107914400513766		18027	1079144005467412		BT139			
107914400389646		BT8850-MPG	107914400456966		PA2233	107914400490906		PA2237	1079144005139012		BT7125	1079144005469812		B1416			
107914400389886		BT8861	1079144004570212		BF1329	1079144004911312		BF1182	107914400514066		PA4092	107914400548346		BF7639-D			
107914400391456		18268	1079144004571912		P7052	1079144004912012		BF1184	1079144005145112		BT8393	1079144005487212		BF1261			
107914400393296		BT8851-MPG	1079144004578812		BF1347	1079144004913712		BF1185	107914400514996		BF7623	107914400548966		BD1403			
1079144003935012		PT8350	1079144004580112		BF1345-SP	1079144004914412		BF1186	1079144005150512		SA2047	1079144005490212		BF7658			
107914400402406		B7030	1079144004581812		BF1205	107914400492296		PA4044	1079144005151212		BF1253	1079144005491912		BF7659			
1079144004118612		PT8352	1079144004582512		BF1204	107914400492366		PA4045	107914400516596		BT8848-MPG	1079144005493312		BF7661			
1079144004119312		PT8351	1079144004583212		BF1205-SP	107914400492436		PA4046	1079144005166612		BF7624	107914400549576		BF7658			
107914400412096		PT8353	1079144004589412		PT8339	107914400493356		PA4047	107914400517346		PA4093	107914400549646		PA4109			
107914400412926		BF7571	1079144004590012		BF1348	107914400493426		PA4048	107914400517416		PA4094	1079144005497112		BF7663			
1079144004149012		BF1173	1079144004628012		BF1204-SP	1079144004938012		BF1215	1079144005177212		BF7625	1079144005498812		BF7664			
1079144004153712		BF7534	107914400459246		BT610-MPG	107914400494036		PA4049	1079144005178912		B1425	1079144005503912		BF7657			
1079144004249712		PT8354	107914400459316		BT8846	1079144004941012		BF1190	1079144005189512		BF1348-SP	107914400550466		PA3836			
1079144004250312		PT8355	107914400459486		BT8852-MPG	1079144004942712		BF1191	1079144005190112		BT8398-MPG	1079144005505312		BF7666			
107914400425276		BF1239	107914400459556		BT611-MPG	1079144004944112		BF1193	107914400519706		BT8842-MPG	107914400550776		PA3839			
1079144004253412		PF7572	1079144004606812		BD7095	1079144004946512		BF1195	107914400520076		BT8843-MPG	107914400550846		PA3840			
1079144004256512		P7013	107914400460756		PA2234	1079144004952612		BF1199	1079144005203812		BF7626	107914400550916		BD7141			
107914400426266		BT8845	1079144004611212		BF1223-SP	107914400495336		PA4081	107914400520456		PF7627	107914400551076		BT8416			
107914400426336		BT8844	1079144004612912		BF7593	107914400495646		PA3773	1079144005208312		B7128	1079144005511412		BF7667			
1079144004264012		PA2001 FOAM	1079144004628012		PF7594	1079144004957112		PA3045	107914400521206		BT8401-MPG	1079144005512112		BT7142			
107914400426716		BD103-MPG	1079144004629712		PF7595	1079144004958812		BF1046	1079144005219912		PT8403-MPG	107914400551386		PA4110			
1079144004276312		BF7576	1079144004641912		PF7596	1079144004959512		BF1047	107914400522126		PA3419	107914400552526		18032			
1079144004277012		BF7579	107914400464266		BT8870-MPG	1079144004960112		BF1048	1079144005222912		BF7628	1079144005527326		BT8849-MPG			
1079144004278712		BF7580	107914400464406		BT8874-MPG	1079144004961812		BF1049	1079144005227412		BF7629	1079144005527496		BT8855-MPG			
1079144004292312		PT8329	1079144004646412		BT606-MPG	1079144004962512		BF1050	1079144005228112		PT8404-MPG	1079144005528112		BT8877-MPG			
107914400429926		BT8830	1079144004647112		P7021	107914400496876		BT8381	107914400523046		PA4099	1079144005528612		BT8878-MPG			
107914400430056		BT8832	107914400465186		BT8873	107914400497316		PA2240	1079144005232812		BF7631	1079144005527706		BT8879-MPG			
1079144004307412		B1430	1079144004653212		PF7597	107914400497626		PA2243	1079144005235912		BF7632	1079144005581712		B7143			
1079144004309812		PT8356	1079144004655612		BF7532	107914400497796		PA2244	107914400524416		PA4100	1079144005586212		B1431			
1079144004310412		BW5082	107914400465636		BT8875-MPG	1079144004987812		BF1008	107914400525267		V7129-C	1079144005587912		BT8417			
1079144004313512		BF7584	1079144004662412		P7015	107914400500416		PA4084	1079144005258812		BW5142	1079144005588612		BT8415			
1079144004314212		P7081	1079144004672312		P7016	107914400501026		BT8382	1079144005260112		B7130	1079144005589312		BT8413			
1079144004315912		PT8319	1079144004673012		P7017	1079144005013312		P1418	1079144005261812		B7131	1079144005591612		B1432			
1079144004316612		PT8341	107914400469146		BT8841-MPG	1079144005014012		P1419	1079144005262512		BF7645	1079144005592312		PA3872			
107914400431736		PT8335	1079144004702712		B7099	1079144005026312		BF1172	1079144005266312		BF1249-SP	1079144005593012		PA3873			
1079144004320312		BT8357	107914400470656		PA4075	1079144005029412		BT7119	1079144005274812		BF7644	1079144005594712		BF7670			
1079144004323244		CTK5029	1079144004711912		PT8370-MPG	107914400503006		PA4085	107914400527556		18029	1079144005595412		BT7144			
1079144004327212		B7585	107914400471266		PT8371-MPG	1079144005032412		BF1240	1079144005291512		P127	107914400560366		PA3880			
1079144004328912		B7082	1079144004717112		BF1258	1079144005033112		BT8384	1079144005294612		F594-F	107914400560816		PA4111			
1079144004330212		BF7586	1079144004751512		BD325	107914400503486		B495-SS	1079144005300412		F950-F WO	107914400561116		BT8418			
1079144004331912		BF7587	107914400475396		PA4077	107914400503866		B96-SS	1079144005301112		F953-F	107914400561806		BT8880-MPG			
1079144004332612		P7083	1079144004755312		P7103	107914400503936		B99-SS	1079144005302812		PF997	1079144005619712		PT8419			
1079144004333312		PF7588	1079144004757712		BF7598	107914400504096		BD103-SS	1079144005306612		BF7648	107914400562036		18033			
1079144004334012		BF1231	1079144004758412		P7104	107914400504166		B99-SS	1079144005307312		PT8407	107914400562106		18034			
1079144004335712		P7084	107914400475916		BD7105	1079144005042312		B76-SS	1079144005311012		BF7633	1079144005625812		BF7640			
107914400434326		PA4005	1079144004760712		P7106	1079144005043012		B7600-SS	1079144005312712		P7132	1079144005626512		BF7653			
1079144004344912		B1405	1079144004761412		P7107	1079144005045412		BF7612	107914400531346		PA4102	107914400562896		PA3890			
107914400434566		PA2200	1079144004765212		PT8372	1079144005046112		BF7613	1079144005319612		BT8409	1079144005658612		P1433			
107914400434706		PA2228	1079144004766912		BF7602	1079144005048512		BF1248	1079144005328812		BW5200	1079144005661612		P7145			
107914400434946		PA2230	107914400476766		PA4078	1079144005050812		BF7614	1079144005329512		BF7634	107914400567396		BF1277-SP			
1079144004355512		B1410	1079144004772012		BF1100	1079144005051512		P7615	107914400533016		BT8853-MPG	1079144005674612		BF1273-SP			
107914400436236		PA4069	1079144004782912		BF7606	1079144005052212		BT121	1079144005336312		BF1257	107914400568146		BF1262			
107914400436306		PA4070	1079144004784312		B7113	1079144005053912		PT8385	107914400533706		BF7635	1079144005684512		B7151			
107914400436476		PA4071	107914400478676		PA3697	1079144005054612		BF1052	1079144005359212		PA2862 FOAM	1079144005685212		BT7152			
1079144004365412		PT8338	107914400478746		PA4079	1079144005058412		B1421	1079144005369112		PA2884	107914400568836		BD7153			
1079144004366112		PF7545	107914400478816		18002	1079144005059112		BT8386	107914400541626		PA3414	107914400568906		BD7154			
1079144004367812		B7045	107914400479046		18004	1079144005061412		PT7617	1079144005423012		B7033	107914400569376		BT7155			
1079144004371512		P7050	107914400479356		18007	1079144005062112		BF1349	1079144005424712		B7034	1079144005698212		BT8420			
107914400437226		PT8334	107914400479596		18009	1079144005082912		BF1056	1079144005426112		BF7537	1079144005702612		BW5143			
107914400437916		PA4072	107914400479666		18010	1079144005084312		B1422	1079144005432212		P7134	1079144005703312		PF7680			
107914400438146		PA4073	107914400479976		18013	1079144005090412		PF7618	107914400543606		B7135	1079144005740812		BW5201			
1079144004499612		B7049	107914400481476		PT8375-MPG	1079144005094212		BT8391	107914400543916		PA3822	107914400574226		PA4112			
1079144004501612		B7089	107914400481546		PT8376-MPG	1079144005096612		BF7619	107914400544076		PA3823	107914400574396		PA3901			
1079144004503012		BF1224	1079144004819212		B7001	1079144005098012		BF1249	1079144005442112		BT8412	1079144005748412		PF7655			
1079144004509212		PT8363	1079144004826012		P7114	1079144005100012		PT8392	107914400544386		BF7639	1079144005749112		BT7156			
107914400451156		PA2231															

BALDWIN CASE TO 1/2/5 (SHIPPING CASES)

BALDWIN CASE NUMBER	QTY.	I 2/5 NUMBER	BALDWIN CASE NUMBER	QTY.	I 2/5 NUMBER	BALDWIN CASE NUMBER	QTY.	I 2/5 NUMBER	BALDWIN CASE NUMBER	QTY.	I 2/5 NUMBER	BALDWIN CASE NUMBER	QTY.	I 2/5 NUMBER
1079144005805412		B7165	107914400601706		PA3970	1079144006255612		B1446	1079144006501412		P7233	1079144006692912		B5145
107914400580786		PA3825	1079144006021712		B7177	107914400625874		V1560	1079144006503812		BF7808	1079144006695012		BF7775
107914400581086		PA4114	1079144006028612		P7178	1079144006260012		P7199	107914400650526		PA4157	1079144006696712		BF7776
107914400581226		B7161	1079144006029312		B7179	1079144006263112		PT8481	1079144006506912		BF1350-SP	1079144006697412		BF5816
107914400581466		BD7166	107914400603166		PA4128	1079144006265512		BF7742	1079144006507612		BF7809	1079144006700112		PF7777
107914400581606		BT8833	107914400603236		PA4129	1079144006278512		PT8496-MPG	1079144006508312		P7235	1079144006701812		BF7778
107914400582386		BT287-3	107914400603474		PT8453	1079144006280812		PF7744	1079144006509012		PT8884-MPG	1079144006702512		BT8905
1079144005824512		BT8428-MPG	107914400603546		PA3980	1079144006285312		BT8497-MPG	1079144006513712		PF7812 KIT	107914400670326		B7246
1079144005826912		B5087	107914400603786		18264	1079144006293812		BT8460	1079144006515112		BF7766	1079144006708712		PF7779
1079144005827612		B5088	107914400603856		18265	1079144006295212		PF7751	1079144006516812		PT8885-MPG	107914400671246		BT8906
1079144005828312		BF1265	107914400604466		PA4132	1079144006299012		B7215	107914400651996		BT8886-MPG	107914400671316		PA4169
1079144005831312		BT8429	107914400604536		18267	1079144006300312		BT8499	107914400652506		PA4158	1079144006714812		BF7780
1079144005839912		B7685	1079144006047712		BF7713	1079144006305812		BT8501-MPG	1079144006531112		BF7813	1079144006715512		PT8907-MPG
107914400584056		B7175	107914400604846		PA4133	107914400630896		PA4149 KIT	107914400653356		PA4632	1079144006716212		P7247
1079144005844312		B7167	107914400604916		PF7715	1079144006309612		BT8502	1079144006534212		PA4633	107914400672166		B7249-MPG
1079144005847412		B1434	1079144006051412		BF7717	1079144006310212		B7216	1079144006535912		BF7814	1079144006722312		BT8908
1079144005850412		BF7686	107914400605526		BT8801-MPG	107914400631196		B7217	1079144006538012		B7238	1079144006723012		BF7815
1079144005852812		PF7687	107914400606206		PA3983-FN	107914400631646		BT8503-MPG	107914400654036		PA4159	107914400673086		BT8910-MPG
107914400585426		PA3929	1079144006064412		PF7718	1079144006317112		BT8504	1079144006542712		PF7755	107914400673156		BT8911-MPG
107914400585596		B7180	1079144006065112		B1441	1079144006320112		BF7747	1079144006543412		BF1339-SP	107914400673606		PA4681
107914400585666		BT8432-MPG	1079144006067512		P1443	1079144006321812		PF7748	107914400654416		PA4160	107914400673776		20005
1079144005857312		BF7690	107914400606826		BD7310	1079144006322512		PF7749	107914400654726		B7239	107914400673846		BD7250
107914400586656		BD7169	1079144006071212		BF7711	1079144006327012		BF7750	107914400654896		B10-AL BSP	107914400673916		BD7252
1079144005872612		BF1266	1079144006073612		B7181	1079144006328712		BF1283	1079144006549612		B7240	1079144006740712		PT8912
107914400587336		PA3931	107914400607506		BT8457-MPG	1079144006329412		BF1281	1079144006550212		PT8888	107914400674216		PA4682
1079144005874012		B1438	107914400608426		B7182	1079144006344712		B5089	107914400655336		PA4162	1079144006746912		BF1353-SPS
1079144005875712		B7170	1079144006085912		B7189	107914400634616		PA4150	1079144006554012		PF7767	107914400674836		PF7782
1079144005876412		B7171	107914400608666		PA4134	1079144006353912		PT8507-MPG	107914400656014		PT8889	1079144006749012		BF7783-D
1079144005878812		BF1267	1079144006088012		PT8459	1079144006360712		BT8509-MPG	1079144006567012		B5090	1079144006750612		BF7784-D
107914400588186		BT8437	107914400609276		PA3986	1079144006361412		BT8505	107914400656876		B7241	1079144006751312		BF7785-D
1079144005886312		BF7691	107914400610614		P7183	1079144006367612		BF7753	107914400656946		BT8890-MPG	1079144006753712		BF7786-D
1079144005889412		BF7693	1079144006108512		BF7719	107914400637066		PA4600	107914400657486		BT8892-MPG	1079144006754412		PA4852
1079144005891712		B1435	1079144006110812		BF7720	107914400637136		PA4601	107914400657626		20003	1079144006755112		PA4852 FOAM
107914400589486		BD7309	107914400611226		PA4138	1079144006373712		BF7756	107914400657936		20004	1079144006756812		PA4853
1079144005899312		P1440	1079144006113912		BF7721	1079144006376812		B7219	1079144006585412		66-30	107914400675756		PA4854
1079144005902012		BF1268	1079144006116012		BF7725	1079144006378212		BF1275	107914400658616		PT8893	1079144006759912		PA4855
1079144005903712		BT8440-MPG	1079144006119112		SA4141	1079144006383612		PF7758	1079144006587812		BF7768	1079144006763612		PA4689
107914400590686		BT8439-MPG	1079144006123812		PA4551	1079144006387412		B7220	107914400658856		PA4163	1079144006764312		PA2068 FOAM
107914400590826		PA4120	1079144006124512		PA4552	1079144006390412		B7221	1079144006601112		BF1346-SP	1079144006765012		PA2223 FOAM
107914400591676		PA4118	1079144006126912		B7174-MPG	1079144006391112		B7222	1079144006605912		BF1286	1079144006766712		PA3901 FOAM
107914400592806		BF7695	107914400613756		PA4555	107914400639356		PA4612	107914400660806		PA4164	1079144006776612		PA4694
1079144005929712		BF1269	107914400613996		PA4557	1079144006396612		BF7760	1079144006614112		BF7769	1079144006777312		PA4695
107914400593276		PA4121	1079144006140512		BF7726	107914400639736		PT8461	1079144006616512		PF7770	1079144006778012		PA4696 FOAM
107914400593346		BF1277-SPS	1079144006141212		PT8462-MPG	1079144006402412		BF7759	1079144006622612		BC7242	107914400678036		PA4698
1079144005937212		BF1270-SP	1079144006143612		PT8468	1079144006403112		B7197	1079144006623312		BT8898	107914400678416		PA4707
107914400593966		PA3941	1079144006146712		PT8470	1079144006406212		B5144	107914400662406		BT8899	107914400678894		PA4711
1079144005941912		BC7173	1079144006147412		P7185	1079144006407912		BF1278	1079144006627112		BF7771	107914400679196		PA4714
107914400594956		PA3953	1079144006149812		BT8472	1079144006408612		BF1279	1079144006629512		BW5182	1079144006797112		PA4720
1079144005950112		BT8443	1079144006150412		BT8473	1079144006415412		BF7762	1079144006630112		BT8900	107914400680082		PA4723
107914400595566		PA4123	1079144006151112		BT8474	1079144006416112		B7223	1079144006636312		B7243	1079144006804612		PA4727
107914400595636		PA4124	1079144006152812		BT8475	107914400643146		PA4151	1079144006638712		BF7681-D	107914400680776		PA4730
107914400595706		BT8856-MPG	107914400615356		BT8476	107914400644376		B7224	1079144006639412		BF7679-D	107914400680846		PA4731
1079144005961712		BT8444	107914400615426		BT8477	1079144006447512		B7225	1079144006640012		BF7672-D	1079144006809112		PA4732
107914400596316		BT8847	107914400615596		BT8463-MPG	1079144006448212		BF7765	1079144006641712		BF7682-D	107914400681076		PA4733
1079144005964812		B7172	107914400615666		BT8464	107914400644996		PA4152	1079144006642412		BF7675-D	107914400681146		PA4734
1079144005965512		BF7683	107914400615736		BT8465	107914400645126		PA4154	1079144006643112		BF7673-D	1079144006812112		PA4735
1079144005966212		BF7696	1079144006161012		BC7186 KIT	107914400645506		19996	1079144006644812		BF7674-D	1079144006813812		PA4736 FOAM
107914400597306		BF1274-SP	1079144006165812		B1444	107914400645816		19999	1079144006645512		BF7677-D	107914400681456		PA4737
107914400597476		BF1274-SPS	107914400617336		B7187	107914400645986		20000	1079144006646212		BF7746-D	107914400681526		PA4738
107914400597546		18055	1079144006185612		PF7733	107914400646116		20002	1079144006647912		BF7745-D	107914400682756		PA4750
107914400597616		18056	1079144006186312		PF7734	1079144006462812		B7227	1079144006648612		BF7699-D	107914400683126		PA4754
107914400597786		18057	1079144006189412		PT8484	1079144006464212		BC7228	107914400664936		BT8901-MPG	1079144006832910		PA4755
1079144005978512		BT8445	1079144006192412		PF7735	107914400646806		B7229	107914400665856		PA4701	107914400683366		PA4756
107914400598466		PA4126	1079144006194812		P7188	1079144006476512		PF7799	1079144006659212		BF7772	1079144006835012		PA4758
1079144005985312		BF1271	107914400619626		PA4144	1079144006477212		BF7800	1079144006664612		BT8902	1079144006837412		PA4760
107914400598606		PA3957	1079144006204412		B7191	1079144006478912		BF7801	107914400666536		PA4166	1079144006840412		PA4763
1079144005988412		B8448	1079144006205112		PT8485	1079144006479612		BF7802	1079144006666012		BT8903	107914400684116		PA4764
1079144005990712		PF7698	1079144006210512		BT8486	1079144006480212	</							

BALDWIN CASE TO I 2/5 (SHIPPING CASES)

BALDWIN CASE NUMBER	I 2/5 QTY.	BALDWIN CASE NUMBER	I 2/5 QTY.	BALDWIN CASE NUMBER	I 2/5 QTY.	BALDWIN CASE NUMBER	I 2/5 QTY.	BALDWIN CASE NUMBER	I 2/5 QTY.	BALDWIN CASE NUMBER	I 2/5 QTY.
1079144006930212	PF7788	1079144007193012	B7275	1079144007592112	BF7881	107914400778336	20011	107914400795236	PA5359		
1079144006931912	PF7816	1079144007194712	B7276	1079144007595212	PA4979	107914400778576	20012	1079144007953012	PF7928		
1079144006932612	PF7817	1079144007195412	B7277	1079144007599012	PA4975	107914400778646	PA5327	1079144007961512	BF1379		
107914400693324	PF7818	1079144007198512	B7280	1079144007611912	PT9337-MPG	107914400778716	PA5328	1079144007962212	BF1380		
1079144006934012	PF7819	1079144007199212	B7281	1079144007626312	B77349	1079144007797012	BF1360	1079144007963912	BF1381		
1079144006935712	PF7820	1079144007201212	B7283	1079144007628712	BF7883	1079144007798712	BF7911	1079144007964612	PA4187		
1079144006936412	BF7821	1079144007203612	B7285	1079144007629412	B7306	107914400779946	PA4175	1079144007965312	BF1382-SP		
1079144006937130	PF7822	1079144007204312	B7286	107914400763796	PA4985	107914400780076	PA4176	107914400796846	PF7930		
1079144006938812	PF7823	1079144007205012	B7287	107914400763866	PA4986	1079144007804512	BF1293-SPS	1079144007983712	BF7333		
1079144006939530	PF7824	1079144007207412	B7289	107914400763936	PA4987	1079144007805212	BF1272-SPS	1079144007984412	BF7931		
1079144006940112	PF7825	1079144007208112	B7290	107914400764166	BF1355-SP	107914400780686	20013	107914400798516	BF7932		
1079144006941812	PF7826	1079144007209812	B7291	1079144007643012	BF7886	107914400781066	BT9362-MPG	107914400799126	BT9387		
107914400694256	PF7828	1079144007210412	B7292	1079144007646112	P7308	107914400781136	BT9363-MPG	1079144007994312	B7397		
1079144006944912	PF7830	1079144007211112	B7293	1079144007648512	BF5587-D	107914400781206	PA4177	1079144007995012	BT9388		
1079144006946312	PF7832	1079144007212812	B7294	1079144007653912	B7311-MPG	1079144007813712	BF7912	107914400800486	B7335-MPG		
1079144006947012	BF7833	1079144007249412	PF7852 KIT	107914400765466	P7312	107914400781516	BF7913	1079144008005512	B7334		
1079144006948712	PF7834	107914400725006	PA4857	1079144007657712	P7313	1079144007816812	BF1352-SPS	107914400800626	BT9391-MPG		
1079144006950012	PF7836	1079144007253112	BF7853	1079144007658412	PT9342-MPG	1079144007818212	BF1361	1079144008010912	P7336 KIT		
1079144006951712	BF7837	107914400726096	PA4170	1079144007660712	PF7889	107914400783976	BT9364	107914400801166	BT9392-MPG		
1079144006952412	BF7838	1079144007263012	PA4878	1079144007661412	PF7889-10	1079144007841012	BF7915	107914400801236	BT9393-MPG		
1079144006953120	BF7839	1079144007264712	PA4879	1079144007662112	PF7889-30	107914400784276	BT9365-MPG	1079144008013012	PF7934 KIT		
1079144006954812	BF7840	1079144007268512	PA4883	1079144007663812	PF7890	107914400784346	BT9366-MPG	1079144008021512	PF7935		
1079144006955512	BF7841	107914400727084	PA4885	1079144007664512	PF7890-10	107914400784416	PA5333	107914400802226	PA5393		
1079144006956212	BF7842	1079144007271512	PA4886	1079144007665212	PF7890-30	107914400784586	BT9367-MPG	1079144008024612	BF1384-SP		
1079144006957912	BF7843	107914400727396	PA4888	107914400766696	BT9343-MPG	1079144007848912	BF1283-SP	107914400802776	PA4188		
1079144006958612	BF7844	107914400727536	PA4890	1079144007672012	BF7798-SP	1079144007849612	BF1362	1079144008028412	P7338		
1079144006959312	BF7845	1079144007276012	PA4891	1079144007673712	PT9344	107914400785026	BT9368-MPG	107914400803076	PA4190		
1079144006961612	BF7847	1079144007280712	PA4895	107914400767446	B7314	107914400785196	BT9369-MPG	107914400803146	PA4191		
1079144006962312	BF7848	1079144007286912	PA4902	1079144007675112	BF1356	1079144007852612	BC7326	1079144008033812	PF7936		
1079144006963012	BF7849	1079144007289012	PA4905	107914400767686	PA4172	1079144007853312	PF7916	1079144008034512	P7398		
1079144006964712	BF7850	107914400729066	PA4906	107914400767996	BT9345	1079144007855712	BF7917	1079144008035212	P7399		
1079144006965412	BF7851	1079144007291312	PA4907	1079144007681212	BT9346-MPG	1079144007856412	B7327	1079144008036912	P7400		
1079144006966112	BF7736-K1	1079144007292012	PA4908	107914400768296	BT9347-MPG	107914400785716	BT9370-MPG	1079144008037612	B7401		
1079144006967812	BT8913-MPG	107914400729446	PA4910	107914400768436	BT9349-MPG	107914400786016	BF1355	107914400803836	20014		
107914400696856	BT8476-MPG	1079144007295112	PA4911	107914400768506	BF1357	1079144007861812	BF1363	1079144008039012	BF7937		
1079144006969212	BT366-MPG	1079144007315612	PA4931	1079144007686712	BF7888	107914400786326	PA5337	107914400804066	PA4192		
107914400697086	BT351-MPG	107914400731636	PA4932	1079144007688412	BF1358-SP	1079144007865612	B7328	107914400804136	PA4193		
1079144006971512	BT371-5	1079144007318712	PA4934	1079144007688112	BF7892	107914400786636	PA4178	107914400804206	PA4194		
1079144006972212	BT8914	1079144007319412	PA4935	1079144007691112	BT7316	107914400786706	PA4179	107914400804376	PA4195 KIT		
1079144006974612	BT8916	107914400732244	PA4938	1079144007696612	BD7317	107914400786876	PA4180	107914400804446	PA4196		
1079144006975312	BT8917	1079144007323112	PA4939	107914400770246	PF7894	107914400786946	PA4181	107914400804516	PA4197		
1079144006976012	BT8918	1079144007336112	PA4872	107914400770316	PF7895	107914400787006	PA4182	107914400804686	PA4198		
1079144006977712	BT8919	1079144007337812	PA4873	1079144007704812	B7318	107914400787176	PA4183	107914400804756	PA4199		
1079144006978412	BT8920	1079144007338512	PA4874	1079144007708612	P7319	107914400787246	BT9371-MPG	107914400804826	PA4303		
1079144006980712	BT8922	1079144007341512	PA3957 FOAM	1079144007709312	PF7896	1079144007875512	BF1365	107914400804996	PA4304		
1079144006984512	BT8926	1079144007342212	PA2069 FOAM	107914400771306	PA5306	1079144007881612	BF7919	107914400805056	PA4305		
107914400698526	BT8927	1079144007343912	PA2067 FOAM	1079144007715412	BF7898-D	107914400788474	BA5374	107914400805126	PA4306		
1079144006986912	BT8928	107914400735456	BT8475-MPG	1079144007717812	B7320	107914400788544	BA5375	107914400805296	PA4307		
107914400698836	BT8930	107914400735526	BT8477-MPG	107914400771926	PA4174	107914400788614	BA5376	107914400805366	PA4308		
107914400698906	BT8931	1079144007358312	BT9321	107914400773216	B7322	107914400788786	PA5339	107914400805436	PA4309		
1079144006993712	BT8935	107914400736136	BT9324	1079144007733812	PA5311	1079144007888512	PT9374	1079144008055012	SA4315		
107914400699516	BT8937	1079144007402312	PT9238	107914400773456	PA5312 KIT	1079144007890812	BF7921	107914400805676	PA4310		
1079144007064312	PT9127	1079144007403012	PT9239	107914400773696	PA5314	107914400789156	PA5341	107914400805746	PA4311		
1079144007068112	PT9131	1079144007424512	PT9260	1079144007737612	BF7903	107914400789394	PT9375	107914400805816	PA4312		
1079144007071112	PT9134	1079144007448112	PF7869	1079144007738312	BF7904-D	107914400789606	P7329	107914400805986	PA4313		
1079144007072812	PT9135	1079144007451112	PF7872	107914400773906	B7396	1079144007899112	BF1367	107914400806046	PA4314		
1079144007073512	PT9136	1079144007452812	PF7873	107914400774066	BT9353-MPG	1079144007900412	BF7922	107914400806116	B7402		
1079144007079712	PT9142	1079144007453512	PF7874	1079144007741312	BF7905-D	1079144007901112	BF1370	1079144008062812	B7403		
1079144007080312	PT9143	1079144007454212	PF7875	1079144007742012	BF7906-D	1079144007902812	BW5183	107914400806356	PF7938		
1079144007081012	PT9144	1079144007455912	PF7876	1079144007743712	BF7907	1079144007903512	BF1371	1079144008064212	BF1354-SPS		
1079144007084112	PT9147	1079144007456612	PF7877	1079144007746812	PA5316	1079144007905912	BF7923	107914400806596	PA4316		
1079144007104612	PT9167	1079144007457312	BF7855	107914400774756	PA5317	107914400790666	P7330	107914400806666	PA4317		
1079144007106010	PT9169	1079144007459712	BF7857	1079144007748212	PT9354-MPG	107914400790976	PA4184	1079144008072712	PT9394-MPG		
1079144007111412	PT9174	107914400746106	BF7859	107914400774996	PA5318	1079144007914124	CTK5029-M	107914400807586	PA4319		
1079144007117612	PT9180	1079144007462712	BF7860	107914400775056	PA5319	1079144007915812	BF7927	107914400807656	PT9395-MPG		
1079144007118312	PT9181	1079144007463412	BF7861	107914400775126	PA5320	1079144007918912	PT9380-MPG	107914400807726	PA4320		
1079144007122012	PT9185	1079144007464112	BF7863	107914400775296	PA5321	1079144007919612	BF1373-SP	1079144008082612	PT9396		
1079144007151012	PT9214	1079144007465812	BF7864	1079144007755012	BF7908	1079144007925712	BF7924	1079144008084012	BF1385-SPS		
1079144007173212	P7255	1079144007466512	BF7865	1079144007756712	BF7909	1079144007926412	BF1374-SP	1079144008085712	PF7939		
1079144007174912	P7256	1079144007467212	BF7866	1079144007758112	PF7910	1079144007927112	BF1375	1079144008086412	BF7940		
1079144007177012	P7259	1079144007470212	B7298	107914400776596	BT9356	1079144007929512	BT9382	1079144008087112	BF7941		
1079144007178712	P7260	1079144007474012	P7303	107914400776736	B7324	1079144007930112	BF1376	107914400808886	PA4321		
1079144007181712	P7263	1079144007478812	OAS99035	1079144007769712	PF7977	1079144007934912	BF1377	107914400808956	PA4322		
1079144007182412	P7264	1079144007500612	BT9318	107914400777416	BD7325	1079144007935612	BF1372	1079144008090112	BF7942		
1079144007187912	P7269	1079144007503712	P7305	1079144007777212	BF1359-SP	107914400793636	PA4185	1079144008091812	P7406		
1079144007188612	BF7880	1079144007504412	PF7878	107914400777896	20006	10791					

BALDWIN CASE TO 1/25 (SHIPPING CASES)

BALDWIN CASE NUMBER	CASE QTY.	I 2/5 NUMBER	BALDWIN CASE NUMBER	CASE QTY.	I 2/5 NUMBER	BALDWIN CASE NUMBER	CASE QTY.	I 2/5 NUMBER	BALDWIN CASE NUMBER	CASE QTY.	I 2/5 NUMBER	BALDWIN CASE NUMBER	CASE QTY.	I 2/5 NUMBER
107914400811066		PA4325	1079144008227112		B7430	1079144008348312		B7453	1079144008656912		PF1392	107914400881676		PA4436
1079144008115112		BF7943	1079144008229512		PT9405	107914400835136		PA4410 KIT	1079144008660612		PF7994	107914400881746		PA4437
1079144008118212		P7408	1079144008230112		B7431	1079144008353712		OP8750	1079144008661312		BF7995	1079144008818112		PT9435-MPG
1079144008119912		B7409	1079144008231812		B7432	1079144008354412		OP8751	1079144008662012		P7368	1079144008819812		BF9830-D
1079144008120512		B7410	1079144008232512		B7433	1079144008355112		OP8752	107914400866756		BF7996	1079144008821112		BF9831
107914400812126		PA4329	107914400823326		PA4367	1079144008356812		OP8753	107914400866826		PA4428	1079144008823512		B7390
1079144008122912		P7411	107914400823496		PA4368	107914400835756		PA4411	107914400866996		BT9421-MPG	1079144008825912		B7393
1079144008125012		BF1386-O	107914400823566		PA4369	1079144008358212		P7454	107914400867056		20021	1079144008826612		BF9833-D
1079144008126712		BF7944	107914400823636		PA4370	107914400835996		PA4412	107914400867296		20023	1079144008827312		BF9834
1079144008127412		P7413	107914400823706		PA4371	107914400836056		PA4413	1079144008678112		BF7997	1079144008828012		BF9835-D
1079144008128112		P7414	107914400823876		PA4372	107914400836296		PA4415	107914400867986		PA5494	107914400882976		P7505
1079144008134212		BF1387-O	107914400823946		PA4373	1079144008366712		P7455	107914400868046		PA5495	1079144008830312		B7457
1079144008135912		BF1388-O	1079144008240012		BF7958	107914400836746		PA4416 KIT	107914400868116		BT9422	1079144008831012		B7458
1079144008136612		P7415	1079144008241712		BF7959	1079144008368112		BF7969	1079144008682812		BF7998	1079144008832712		B7459
107914400813736		PA4330	1079144008242412		BF7960	1079144008369812		PT9414-MPG	1079144008685912		BF1289-SP	1079144008843312		BF9836-D
107914400813806		PA4331	1079144008243112		BF7961	1079144008375912		BF7972	1079144008688012		PT9423	107914400884406		PA4438
107914400813976		PA4332	1079144008244812		B7434	1079144008376612		P7438	1079144008692712		B7370	1079144008846412		BF1346-O
1079144008140312		BF7945	107914400824556		PA4374	107914400837736		PA4417	1079144008696512		PT9424	1079144008847112		BF1348-O
107914400814106		B7416	107914400824666		PA4376	1079144008383412		BC7456 KIT	1079144008699612		BF9800	1079144008849512		B7461
107914400814896		BT9398-MPG	107914400824936		PA4377	107914400838656		PA4418	1079144008700912		PF9801	1079144008851812		BF9837-D
107914400814966		PF7946	107914400825096		PA4380	107914400838726		PA4419	107914400870166		PT9425-MPG	1079144008862412		BF9839-D
107914400815026		PA4334	107914400825166		PA4381	107914400839012		PT9417	107914400870236		PA4429	107914400886556		B10-AL BSPCS
107914400815196		PA4335	107914400825236		PA4382	1079144008395712		B7449	1079144008703012		PT9426	107914400886624		BA5566
1079144008156412		BF1389-O	107914400825306		PA4383	1079144008397112		PT9418	1079144008704712		BF9802	1079144008867912		BF1298-O
107914400815716		PA4333	107914400825476		PA4384	1079144008400812		BF1397-SP	107914400870546		PA4430	1079144008868612		B7466
107914400815886		PA4336	107914400825546		PA4385	1079144008401512		B7350	1079144008706112		BT7237	1079144008870912		B7467
1079144008159512		PF7947	107914400825616		PA4386	107914400840394		CV15000	1079144008708512		PF9803	1079144008871612		B7468
107914400816016		PA4337	107914400825786		PA4387	1079144008409112		BF1399-SP	107914400871086		PT9427-MPG	1079144008872312		B7469
1079144008161812		P7418	1079144008258512		BF7962	1079144008414512		PT9419-MPG	1079144008712212		BF1383-O	1079144008873012		BF9841
107914400816326		BF7948	1079144008259212		BF7963	107914400841526		PA4421	107914400871466		PF9804	1079144008880812		BF9842
1079144008165612		BF7949-D	1079144008260812		BF7964-D	107914400844974		PT9453-MPG	1079144008717712		BF9805	1079144008886012		B7477
1079144008166312		BF7950-D	1079144008263912		BT9408	1079144008454912		BT9553	1079144008718412		B7372	1079144008890712		BF9844
107914400816706		20015	107914400826466		PA4388	10791440084550012		PF7974	1079144008721412		BF1222-O	1079144008893812		B7483
107914400816876		20016	107914400826776		PA4390	10791440084551712		B7351-MPG	107914400872386		PA4431	10791440088905812		BC7485
107914400816946		20017	107914400827146		P7436	10791440084553112		PT9555	1079144008726912		BF1345-O	10791440088909612		BF9846
107914400817006		20018	1079144008272112		P7437	10791440084558612		PF7975	1079144008731312		B7373	10791440088910212		BF9847-D
107914400817246		20020	107914400827456		BF1392-SPS KIT	10791440084559312		B7352	1079144008732012		BF9807	10791440088911912		BF1299-O
1079144008174812		BF7951-D	1079144008275212		BF7965	10791440084569212		BF7976	1079144008733712		BF9808-D	1079144008891336		BT9436-MPG
1079144008175512		BF7952-D	107914400827696		PA4391	1079144008458154		BA5378	1079144008735112		BF1223-O	10791440088914012		B7486
1079144008177912		BF7954-D	107914400827836		PA4392	1079144008457224		BA5379	1079144008736812		BF9809-D	10791440088915712		B7487
1079144008178612		P7419	107914400827906		PA4393	107914400845816012		PF7978	1079144008737512		BF9810-D	1079144008891646		PA4439
107914400817936		PA4338	1079144008281312		B7440	107914400845878412		PA5457	1079144008738212		B7375	1079144008891716		PA4440 KIT
107914400818096		PA4340	1079144008282012		BF7966	1079144008459716		BD7355	1079144008739912		B7376	1079144008891886		PA4441
107914400818166		PA4341	1079144008283712		B5091	1079144008458146		BT9558-MPG	1079144008740512		B7377	10791440088919512		BF9848
107914400818236		PA4344	1079144008285112		B7441	10791440084584512		B7356	1079144008741212		BF9811-SP	10791440088920112		P7488
107914400818306		PA4345	107914400828686		PA4394	10791440084585212		BF1366-O	1079144008742912		B7378	10791440088921812		P7489
107914400818476		PA4348	107914400828756		PA5428	10791440084586912		BF7970	1079144008744312		BF1292-O	10791440088923212		BF9850
107914400818546		PA4349	1079144008291212		BF7967	10791440084587612		BF7979	1079144008745012		BF1294-O	1079144008892946		PA4442
107914400818616		PA4350	1079144008292912		BF1393-SP	10791440084588312		B7357	1079144008747412		PT9430-MPG	1079144008893006		PA4443
107914400818786		PA4351	107914400829746		PA4396	10791440084591312		B7359	1079144008748112		B7379	1079144008893176		PA4444
107914400818856		PA4352	107914400829816		PA4397	1079144008459826		PA4422	1079144008750412		BF9812	10791440088932412		BF9851
1079144008190812		BF7955	107914400829986		PA4398	1079144008459996		PA4423	1079144008751112		BF9813	10791440088933112		P7490
1079144008191512		B7420	107914400830016		PA4399	10791440084600212		BF7981	1079144008752812		PF9814	10791440088934812		B7491
1079144008192212		B7422	107914400830186		PA4400	1079144008460646		BT9560-MPG	1079144008753512		B7383	10791440088935512		BF9852
1079144008193912		BF7956-D	1079144008302512		P7442	10791440084607112		PF7983	1079144008754212		B7384	1079144008894236		PA4446
1079144008194612		P7423	1079144008304912		BF1394-SP	10791440084608812		PF7984	1079144008755912		B7385	1079144008894306		PA4447
1079144008198412		P7417	1079144008308712		BF1395-SP	10791440084610112		BF7985	1079144008756612		B7386	1079144008894476		PA4448
107914400819916		PA4353	107914400830946		PA4401	10791440084613212		B7360	1079144008757312		B7387	10791440088948512		BF9857
107914400820046		PA4354	107914400831006		PA4402	1079144008461496		PA4424	1079144008758012		BF9815	1079144008897136		PT9439
107914400820116		PA4355	107914400831316		PA4403	10791440084615612		BF7637	1079144008760312		BF9816	1079144008897516		PA4449
107914400820286		PA4356	107914400831486		PA4404	10791440084618712		B7361	1079144008761012		BF1296-O	1079144008897686		PA5580
107914400820426		PA4358	107914400831556		PA4405	10791440084619412		BT9561	1079144008762712		BF1297-O	10791440088985012		CV15001
107914400820596		PA4359	107914400831866		PA4408	10791440084620012		PF7986	1079144008763412		BF9817	10791440088986712		P7492
107914400820666		PA4360	1079144008320912		B7443	10791440084621712		PF7982	1079144008764112		BF9818	1079144008899046		PA4452
107914400820736		PA4361	1079144008321612		B7444	10791440084623112		B7362	1079144008765112		BF9820	1079144008899166		PA4453
107914400820806		PA4362	1079144008322312		BF1396	10791440084624812		BF7987	107914400876726		PA4433	1079144008899426		PA4454
1079144008209712		B7424	1079144008323012		B7445	10791440084626212		BF7988	1079144008768912		BF9821	10791440088995912		P7493
1079144008210312		P7426	107914400832476											

BALDWIN CASE TO I 2/5 (SHIPPING CASES)

BALDWIN CASE NUMBER	CASE QTY.	I 2/5 NUMBER	BALDWIN CASE NUMBER	CASE QTY.	I 2/5 NUMBER	BALDWIN CASE NUMBER	CASE QTY.	I 2/5 NUMBER	BALDWIN CASE NUMBER	CASE QTY.	I 2/5 NUMBER	BALDWIN CASE NUMBER	CASE QTY.	I 2/5 NUMBER	BALDWIN CASE NUMBER	CASE QTY.	I 2/5 NUMBER
107914400902076		PA5619	107914400921196		B7503	1079144009449612		PF9919	1079144009759612		BF5813-O	107914401036556		PA10027			
107914400902146		PA5620	107914400921886		PA5689	107914400945026		PA5774	1079144009760212		BF1204-O	107914401036626		PA10028			
107914400902386		PA5622	107914400921956		PA5690	1079144009452612		BF1282-O	1079144009761912		BF791-O	107914401036886		PA10030			
107914400902456		PA5623	107914400922016		PA5691	107914400945366		PA4483	1079144009762612		BF7968-O	107914401036936		PA10031			
107914400902526		PA5624	107914400922326		PA5694	1079144009456412		B9601	1079144009763312		BF46016-O	107914401037096		PA10032			
107914400902696		BF9864	107914400922706		BD7504	107914400946016		BF9920	1079144009764012		BF46017-O	1079144010371612		P40023			
1079144009028312		PF9865	1079144009228712		B7506	107914400946636		PA4484	1079144009765712		BF46018-O	1079144010372312		PA00024			
107914400903066		PA4464	107914400922946		PA4470	1079144009469412		BF9921-O	1079144009766412		BF46019-O	1079144010373012		P400025			
107914400903376		PA5629	107914400923006		BF9895 KIT	107914400947006		PA4485	1079144009767112		BF46020-O	1079144010384612		BF46045-D			
107914400903516		PA5631	107914400923176		PA4471	107914400923176		BF9922-O	1079144009768812		BF46021-O	107914401039216		PA10033			
107914400903756		BT9440	107914400923246		PA5698	107914400948096		PA4997	1079144009769512		BF46022-O	107914401039456		PA30126			
1079144009038212		BF9866-O	1079144009235512		PF9897	1079144009492212		PE5272	1079144009770112		BF46023-O	1079144010396912		PF46046			
107914400903996		PA5632	1079144009237912		BF9898-O	1079144009495312		BF9923-O	1079144009771812		BF46024-O	1079144010403412		BF46048			
107914400904296		PA4465	1079144009238612		PF9899	1079144009499112		PA5276	1079144009772512		BF46025-O	1079144010404112		P40017			
1079144009044312		BF9867-O	107914400924096		B7507	1079144009500412		P9602	1079144009773212		BF46026-O	1079144010413312		PA30138			
1079144009046712		BF1355-O	1079144009241612		BC7394	1079144009501112		P9603	1079144009774912		BF46027-O	1079144010414012		PA30139			
107914400904746		PA5633	1079144009242312		PA5700	1079144009502812		PT9537-MPG	1079144009775612		BF46028-O	107914401041576		PA30140			
1079144009050412		PF9868	1079144009243012		PF9901 KIT	107914400950806		PA5282	1079144009776312		BF46029-O	107914401041636		PA30141			
1079144009052812		BF1395-O	107914400924476		PA4473	107914400951034		BA5284	1079144009777012		BF46030-O	107914401041716		PA30144			
1079144009053512		B7496	1079144009252212		BF9903-SP	107914400951106		PA4486	1079144009778712		PT23136	1079144010430012		BF46050			
1079144009064112		BF9869	1079144009254612		B7395	1079144009512712		BF1278-O	1079144009780012		PT23122	1079144010433312		PT23536			
107914400906656		PT9441-MPG	1079144009257712		BF9904	107914400951346		PA4487	1079144009781712		PT23123	1079144010434812		BF46052			
1079144009068912		PF9870	107914400925846		P7508	107914400951726		PF9924 KIT	107914400978246		PT23137	107914401043796		PA10036			
107914400906966		PA5637	1079144009266912		PT9469	1079144009519612		BF9925-O	1079144009783112		PT23124	107914401043866		PA30151			
107914400907026		PA5638	1079144009267612		PT9470	1079144009527112		BF9927	1079144009784812		PT23125-MPG	1079144010439312		BF46052			
1079144009079512		BF9871-O	107914400926836		BD7509	1079144009650612		B9604	1079144009785512		PT23126-MPG	1079144010444712		PA30153			
1079144009095512		PF9872	1079144009274412		BF9905	1079144009657512		P9605	1079144009786212		PT23127-MPG	107914401044536		PA30154			
1079144009096212		B7497	1079144009280512		BT9471	10791440096612812		B9606	1079144009787912		PT23128-MPG	1079144010448512		PA30157			
1079144009099312		PF9873	107914400928126		PA5720	1079144009662912		B9607	1079144009788612		PT23129-MPG	1079144010449212		PF46112			
107914400910136		PA4466	107914400928366		PA5722	1079144009663612		PF9928	1079144009791612		PT23132-MPG	107914401045086		PA10037			
1079144009102012		BT9442-MPG	107914400928436		PA5723	1079144009664312		PF9929	1079144009795412		PA0002	1079144010454612		PF46049			
1079144009103712		BF9874-DM	107914400928506		PA4475	107914400966446		PA10000	1079144009796112		B40006	107914401045536		BD40027			
1079144009104412		BF9875-DM	107914400928816		PA5725	107914400966616		PA10001	1079144009798612		C40005	107914401046526		BF1360-O			
107914400910686		PT9444-MPG	1079144009289812		BF9906	107914400966696		PA10002	107914400979926		PA10008	107914401046696		BF1347-O			
1079144009107512		BF9876	107914400929116		PA5727	1079144009670412		BF46000	1079144009802912		BC40007	107914401046906		CV15005			
1079144009116712		PT9446	107914400929286		PA5728	1079144009671112		BF46001	1079144009805012		BF46031	1079144010470612		PF46056			
1079144009117412		PT9447	107914400929356		PA5728 FOAM	1079144009672812		B40000	107914400980746		P40008	1079144010471612		PF46057			
1079144009118112		PT9448	107914400929596		PA5729	1079144009673512		PA0001	107914400980816		BC40009	1079144010473712		PF46059			
1079144009119812		PT9449	107914400929806		PA5732	107914400968036		PA30007	1079144009809812		PA00010	107914401047516		BF46061			
1079144009120412		PT9450-MPG	1079144009299712		PF9907	107914400968106		PA10003	1079144009810412		BF46032	107914401047756		BF46062			
1079144009131012		BF1358-O	107914400931546		PA5733	1079144009684112		PF46003	107914400981736		PA30072	107914401047826		BT23543-MPG			
1079144009138912		BF9877	1079144009320812		BF9910	1079144009685812		PF46004	1079144009820312		PF46033	1079144010479912		PT23544-MPG			
107914400914196		PA5658	1079144009323912		P7510	107914400968656		PA10004	1079144009823412		P40011	1079144010483612		BF63000			
107914400914406		PA5661	1079144009324612		PF9911	1079144009689612		BF46005	1079144009824112		PA0012	107914401049736		RS30142			
107914400914576		PA5662	1079144009326012		B7511	107914400969026		PA10006	1079144009829812		BF45000	1079144010502412		BT40028			
107914400914956		PA5666	107914400932916		PA5738	1079144009691912		PA0003	1079144009832612		PA0014	1079144010503112		PA0030			
107914400915256		PA4468	1079144009342012		BF1249-O	107914400969266		PA10007	107914400983446		PA10011	107914401050486		PA30174			
107914400915326		PA4469	1079144009346812		S9475	107914400969576		PA30011	1079144009837512		BF46034	107914401050796		P40031-MPG			
1079144009154912		P5092	1079144009347512		BF9912-O	1079144009696012		OAS98000	107914401005936		PA30080	107914401050866		PA30177			
1079144009155612		BF9878	107914400934826		PT9476-MPG	107914400969646		PA30012	107914401006166		PA10014	107914401050936		BD50000			
107914400915636		PA5669	1079144009349912		BF1281-O	1079144009698812		PA30014	1079144010076012		BT40015	107914401051236		PA30179			
1079144009168612		B7499	1079144009350512		BF9913	1079144009700812		PA30016	107914401007776		PA30086	1079144010518512		BF46068			
1079144009170912		PT9456	1079144009351212		BF1283-O	1079144009701512		PA30017	107914401007846		PA10015	1079144010519212		BF46069			
107914400917476		PA5679	107914400935296		PA5753	1079144009702212		PA30018	107914401008456		20025	1079144010521512		BT40029			
107914400917546		PF9879	1079144009356712		CV15003	1079144009703912		PA30019	107914401008766		BF46036 KIT	107914401052226		BT23555-MPG			
1079144009176112		BF9880	107914400935746		PF9914 KIT	107914400935746		PA30022	107914401008836		PA30093	1079144010523912		PF46071			
1079144009180812		BF9881	1079144009358112		BF9915	1079144009708412		PA30024	107914401008906		PA10016	1079144010524612		BF46072			
1079144009182212		PT9462	1079144009365912		BF9916	1079144009713812		PA30029	107914401009066		PA10017	1079144010528412		BT40032			
1079144009184612		BT9464	107914400936666		PA4476	107914400971456		PA30030	1079144010092012		BF46037	1079144010529112		BF46073			
1079144009185312		PT9463	107914400936736		PA4477	1079144009715212		PA30031	1079144010098212		BF46038-D	1079144010538312		P40033			
1079144009186012		BF9883	107914400936806		PA4478	1079144009719012		PA30034	1079144010099912		BF46039-D	1079144010546812		BT40034			
1079144009188412		B7501	107914400936976		PA4479	1079144009720612		PA30035	107914401010026		PA10018	107914401054756		PA30185			
1079144009189112		PE5270	107914400937036		PA4480	107914400972996		PA30044	1079144010246712		BF46040-D	1079144010551212		PE17000			
1079144009190712		PE5271	1079144009373412		P7512	107914400973506		PA30050	1079144010249812		PA0019	107914401055366		PA30188			
1079144009191412		BT9465	107914400937416		B7513	107914400973676		PA30051	1079144010335812		BF46041-D	1079144010555676		PA30189			
107914400919216		PA5683	107914400937586		PA5765	107914400973746		PA30052	107914401033656		BF46042-D	107914401055746		PA30190			
1079144009193812		BF9884	107914														

BALDWIN CASE TO I 2/5 (SHIPPING CASES)

BALDWIN CASE NUMBER	QTY.	I 2/5 NUMBER	BALDWIN CASE NUMBER	QTY.	I 2/5 NUMBER	BALDWIN CASE NUMBER	QTY.	I 2/5 NUMBER	BALDWIN CASE NUMBER	QTY.	I 2/5 NUMBER	BALDWIN CASE NUMBER	QTY.	I 2/5 NUMBER
107914401057586		PA10045	107914401091906		BF46131	107914401107146		PA10099	107914401119336		PA10281	107914401128176		PA10309
107914401057656		PA10046	107914401092206		BF46134-O	107914401107456		PF46171	1079144011194012		PA40102	1079144011282412		20063
1079144010577212		PA00037	107914401092826		PA10075	107914401107766		20030	107914401119576		PA10380	107914401128486	PA10199	KIT
1079144010578912		BT40038	107914401092996		PF46135	107914401107836		PA30287	107914401119646		PA10228	107914401128556		PA10324
1079144010579612		BF46078-D	107914401093056		PA10076	1079144011079012		SA10100	1079144011197112		PA40109	107914401128796		PA10134
107914401058336		PF46080	107914401093366		PA10077	1079144011081312		BF1380-O	107914401119886		PA10285	107914401128866		PA10352
1079144010584012		PF46081	107914401093436		PA10078	107914401108756		BF46064-D	107914401119956		PA10132	1079144011289312		BF46195
1079144010585712		PF46082	107914401093746		BT40066-MPG	107914401108826		PF46172-KIT	107914401120086		PA10292	107914401129166		PA10149
107914401067556		BF46083-O	107914401093816		BT40067-MPG	107914401108996		BF46173-O	107914401120226		PA10181	107914401129236		PA10325
1079144010679312		PT23561-MPG	1079144010939812		PF46137	107914401109126		PA10101	1079144011203912		PA0099	107914401129306		PA10139
1079144010687812		BF46084	1079144010941112		PF46138	107914401109296		PA10102	107914401120466		PA10277	1079144011294712		OB40078
1079144010691512		PE17001	107914401095276		PA10081	107914401109436		PA0074	1079144011205312		OB40079	107914401129616		PA10229
1079144010718912		BF46085	1079144010953412		BF1381-O	1079144011098112		BF46175	107914401120606		PA10378	107914401129786		PA10375
107914401072026		PA00442	107914401095416		PA30260	107914401109986		PA10103	1079144011207712		PA40106	107914401129856		20058
1079144010728812		BF46087	107914401095586		PA30261	107914401110016		PA10104	107914401120846		PA10143	107914401129926		PA10231
107914401072956		PA10047	107914401095656		PA30262	107914401110256		PA10106	107914401120916		PA10288	107914401130056		PA10389
107914401073016		PT23592	1079144010957212		BT23617	107914401110326		PA10107	107914401121076		20052	107914401130126		PA10148
1079144010731812		PF46088	1079144010958912		BF46141	1079144011105612		PA0076	1079144011211412		PA40108	107914401130296		PA10201
107914401073566		PF46091	107914401095966		PA10082	107914401111486		PA30299	1079144011212112		SA10127	107914401130366		PA10235
107914401073636		BF46098-O	1079144010960212		BF46122	107914401111556		PA10108	107914401121386		PA10320	107914401130436		PA10131
107914401073706		BF46100-O	107914401096196		PF46142	1079144011116212		BF46176	107914401121456		PA10224	107914401130506		PA10256
107914401073876		BF46099-O	1079144010962612		BF46143	107914401111936		BF46179	107914401121526		PA10395	107914401130676		PA10146
107914401073946		PF46094	107914401096336		PA10084	1079144011122312		BF1379-O	107914401121696		PA10376	107914401130746		PA10316
107914401074006		BF46101-O	107914401096576		PA10085	1079144011124712		BT23628	107914401121766		PA10284	1079144011308112		SA10361
1079144010745512		B40050	10791440109671		CV15010	107914401112546		BF46181-O	107914401121836		PA10223	1079144011309812		B40128
1079144010746212		B40051	107914401096956		PA0069	1079144011126112		PT23629	107914401121906		PA10195	107914401131046		PA10385
1079144010768412		PA0052	107914401097256		PF46145	107914401113226		PA10063	107914401122066		PA10217	1079144011311112		BF46216
1079144010770712		PF46103	1079144010974912		B40070	107914401113396		PA30249	107914401122136		PA10145	1079144011312812		BF46224
107914401077386		B40053	1079144010977012		S40071	1079144011135312		BF46182-O	107914401122376		PA10390	107914401131356		PA10241
1079144010774512		B40054	1079144010978712		BF46147-O	107914401113606		PA30304	107914401122446		PA10232	107914401131426		PA10354
107914401077696		BT23603-MPG	1079144010984812		BF46149-SP	1079144011140712		PA40105	1079144011225112		PA0116	1079144011315912		BF46205
1079144010777612		PT23597-MPG	1079144010986212		RS30273	107914401114146		20048	107914401122686		PA10142	107914401131666		PA10303
1079144010778312		BT23604	1079144010987912		RS30274	107914401114216		PA10128	107914401122756		PA10286	1079144011317312		B40127
107914401078136		BT23605-MPG	107914401098866		PA10088	1079144011143812		PA40104	1079144011228212		B40126	107914401131806		PA10238
1079144010784412		B40056	107914401098936		BF46150-O	107914401114456		PA10362	1079144011229912		PA40110	1079144011319712		PA40086
107914401078756		BT23607-MPG	107914401099096		PA10089	1079144011145212		BT23631	107914401123126		PA10282	107914401132036		PA10373
107914401078826		PA10057	107914401099166		PA10090	107914401114696		PA10363	107914401123296		20045	107914401132106		PA10368
107914401079431		RS30212	107914401099476		PA30276	1079144011147612		PA40113	107914401123436		PA10346	1079144011322712		PA40081
107914401079501		RS30213	1079144010995412		PF46151	107914401114836		PA10364	107914401123506		PA10310	107914401132416		PA10144
1079144010811712		BF46104	107914401099616		PA30270	1079144011149012		PA40100	107914401123676		PA10233	107914401132586		PA10297
107914401081316		BF46105-O	1079144010997812		PA30269	1079144011150612		PA40119	107914401123746		PA10136	107914401132656		PA10358
107914401081486		PF46106	107914401099856		PA10083	107914401115136		PA10278	107914401123816		PA10159	1079144011327212		PF46189
1079144010816212		BF46108	107914401099926		PA10091	1079144011152012		PA40094	1079144011239812		BF46209	107914401132896		PA10141
107914401081866		PF46109-O	107914401100286		PA30277	107914401115376		PA10221	107914401124046		PA10219	107914401132966		PA10230
1079144010822312		PA0058	107914401100356		20028	107914401115446		PA10220	107914401124116		20037	107914401133026		PA10234
1079144010825412		BF46111	107914401100666		PA10093	107914401115516		PA10129	107914401124356		PA10289	1079144011331912		BF46193
1079144010831512		BF46113-D	107914401100736		PA10094	1079144011156812		PA40103	107914401124426		PA10296	107914401133266		PA10305
107914401083536		PA10058	107914401100806		PA10095	1079144011157512		PA40111	1079144011245912		PA40115	107914401133336		PA10312
107914401083606		PA10059	107914401101036		PA30255	1079144011158212		PA40107	107914401124736		PA10294	107914401133406		PA10307
107914401084526		PA10060	107914401101106		20026	1079144011159912		PA40114	107914401124806		PA10392	107914401133576		PA10264
107914401084696		BF46117	107914401101276		20027	1079144011160512		BF46194	107914401124976		BF955	107914401133646		20035
1079144010847612		PF46118	107914401101586		PA30279	107914401116126		PA10130	107914401125036		PA10135	107914401133716		PA10308
1079144010848312		PF46119	1079144011016512		BF46156	1079144011162912		BT23630	1079144011251012		BF46215	107914401133886		PA10138
107914401084906		PF46092	1079144011017212		BF46157	107914401116366		PA10133	107914401125276		PA10365	1079144011339512		20031
1079144010850612		BT23611	1079144011018912		BF46158	107914401116436		PA10391	107914401125346		PA10355	107914401134016	PA10209	KIT
1079144010857512		PA0061	1079144011019612		BF46159	107914401116506		PA10367	107914401125416		PA10383	107914401134186		20053
107914401085826		BF46116	1079144011021912		BF46161	1079144011167412		PA40112	107914401125586		PA10304	1079144011342512		BF46225
1079144010860512		PA30204	107914401103016		PA10086	107914401116816		20054	107914401125656		PA10113	107914401134326		PA10147
107914401086296		PA10062	107914401103186		PA10080	107914401117046		PA10379	107914401125726		PA10248	107914401134496		PA10302
107914401086986		BF46123-O	107914401103326		CV15011	1079144011171112		B40124	107914401125896		PA10300	1079144011345612		PA40093
107914401087116		PA10064	107914401103566		PA10087	107914401117286		PA10275	107914401125966		20042	107914401134636		PA10239
1079144010872812		BF46125	107914401103636		PA10096	107914401117356		PA10299	107914401126026		PA10387	107914401134706		PA10268
1079144010874212		PF46126	107914401103706		PA30263	1079144011174212		BF46218	107914401126196		PA10295	107914401134946		PA10298
1079144010882712		BF46127	1079144011039412		BF7806-O	107914401117666		PA10279	1079144011262612		PA40089	107914401135176	PA10204	KIT
107914401088656		PA30251	1079144011040012		BF46162-O	107914401117736		PA10276	107914401126406		PA10171	107914401135246		PA10237
1079144010888912		BT40065	1079144011041712		BF7798-O	107914401117806		PA10369	107914401126576		PA10301	107914401135316		PA10191
107914401089196		PA30252	1079144011042412		BF46163-O									

BALDWIN CASE TO I 2/5 (SHIPPING CASES)

BALDWIN CASE NUMBER	CASE QTY.	I 2/5 NUMBER	BALDWIN CASE NUMBER	CASE QTY.	I 2/5 NUMBER	BALDWIN CASE NUMBER	CASE QTY.	I 2/5 NUMBER	BALDWIN CASE NUMBER	CASE QTY.	I 2/5 NUMBER	BALDWIN CASE NUMBER	CASE QTY.	I 2/5 NUMBER	BALDWIN CASE NUMBER	CASE QTY.	I 2/5 NUMBER
1079144011368512		BF46203	107914401142006		PA10394	107914401148116		PA10319	107914401154296		PA10340	107914401163896		PA10413			
107914401136926		PA10254	107914401142176		PA10114	107914401148286		PA10210 KIT	107914401154366		20057	107914401163966		PA30332			
107914401137086		PA10194	107914401142246		PA10196 KIT	107914401148356		PA10188	107914401154506		PA10174	1079144011640212		PF46152			
1079144011371512		BF46208	1079144011423112		PA30302	107914401148426		PA10165	107914401154676		PA10247	107914401164196		PA10414			
107914401137226		PA10160	107914401142486		20066	107914401148596		PA10211 KIT	107914401154746		PA10177	1079144011642612		P40143			
107914401137396		PA10273	107914401142556		PA10341	107914401148666		PT23633	107914401154816		PA10212 KIT	107914401164336		PA10415			
1079144011374612		BF46210	107914401142626		20041	107914401148736		PA10214	107914401154986		PA10342	107914401164406		PA10416			
107914401137536		20061	107914401142866		PA10271	107914401148976		PA10357	107914401155046		PA10381	107914401164576		PA10417			
107914401137606		20062	107914401143306		PA10265	1079144011490312		BF46204	107914401155116		PA10400	107914401164886		CV15015			
107914401137776		PA10218	107914401143546		PA10155	107914401149106		PA10344	1079144011556612		BF46227	1079144011649512		PF46241			
1079144011378412		PA0130	107914401143616		PA10207	107914401149276		PA10190	1079144011557312		B40133	107914401165016		PA10418			
107914401137916		20044	107914401143786		PA10208 KIT	107914401149346		PA10244	107914401155976		PA10401	107914401165186		PA10419			
107914401138076		PA10397	1079144011438512		P40101	107914401149586		PA30303	1079144011560312		PA0134	107914401165256		PA10420			
107914401138146		PA10386	107914401143926		PA10200	107914401149656		PA10321	107914401156106		PA10402	1079144011653212		BF46242			
107914401138216		PA10154	107914401144086		PA10263	1079144011498912		BF46196	107914401156726		PT23637-MPG	107914401165496		PA10421			
107914401138386		PA10315	107914401144156		PA10245	107914401149966		PA10167	107914401156896		PA10403	107914401165566		PA10422			
107914401138456		PA10399	1079144011443912		P40098	107914401150096		PA10169	1079144011569612		B40136	107914401165636		PA10423			
107914401138526		PA10186 KIT	1079144011444612		BF46223	107914401150166		PA10182	107914401157026		PA30310	107914401166316		PA10424			
107914401138696		20060	1079144011445312		BF46200	1079144011503012		BF46199	107914401157196		B40137	107914401166486		BF46244			
107914401138766		PA10249	107914401144606		PA10370 KIT	1079144011504712		BF46202	107914401157266		B40138	107914401166626		PA10425			
107914401138836		PA10372	107914401144776		PA10242	107914401150786		PA10251	1079144011573312		BF46228	1079144011667912		CV15016			
107914401138906		PA10317	107914401144846		PA10250	107914401150856		PA10206 KIT	1079144011587012		BF46229	107914401166866		B40145			
107914401139066		PA10382	107914401144916		PA10156	107914401150926		PA10253	1079144011588712		BF46230	107914401166936		BF46248			
107914401139136		20065	107914401145076		PA10331	107914401151086		PA10260	107914401158946		PA30324	107914401167856		PA30333			
107914401139206		PA10193 KIT	1079144011452112		BF46201	107914401151226		PA10180 KIT	107914401159006		PA30325	107914401168086		PA10426			
107914401139376		PA10314	107914401145386		PA10162	107914401151396		PA10337	107914401159176		PA10404	1079144011684612		PF46250			
1079144011394412		BF46211	107914401145526		PA10327	1079144011514612		BF46197	107914401159626		BD40139	107914401168536		PA10427			
1079144011395112		BF46221	107914401145696		20046	107914401151536		PA10398	107914401159796		PA10388	107914401168606		PA10428			
1079144011397512		BF46206	107914401145836		20050	107914401151606		PA10353	107914401159866		PA10396	107914401168776		SA10429			
107914401139826		PA10213	107914401145906		PA10329	107914401151776		PA10185	107914401159936		PA10406	107914401168846		PA10430			
107914401139996		PA10166	107914401146066		PA10323	1079144011518412		P40085	1079144011604412		BF46233	107914401168916		PA10431			
107914401140026		PA10150	107914401146136		PA10318	107914401151916		PA10328	107914401160516		PA30329	1079144011692112		B40150			
107914401140196		PA10172	1079144011462012		P40117	107914401152146		PA10215 KIT	1079144011606812		BF46234	107914401169386		BF46251-SP			
107914401140336		PA10163	107914401146376		PA10384	107914401152216		20068	107914401160756		PA10407	107914401169456		BF46252-SP			
107914401140406		PA10255	107914401146446		PA10343	1079144011524512		PF46188	107914401160826		PA30330	107914401169526		BF46256			
1079144011405712		PF46187	1079144011465112		SA10360	107914401152526		PA10157	107914401160996		20070	107914401169906		20071			
107914401140646		20051	107914401146756		PA10266	107914401152696		PA10173	1079144011610512		PF46235	107914401170036		20072			
107914401140716		20069	1079144011468212		P40132	107914401152766		PA10261	107914401161126		PF46236	1079144011706512		PF46258			
107914401140886		PA10202	107914401146996		PA10183	1079144011528312		BF46222	107914401161296		PF46237	107914401171196		PA10433			
107914401140956		PA10356	107914401147056		PA10259	107914401152906		PA10158	1079144011613612		PF46238	107914401171336		PA10435			
1079144011410112		P40091	1079144011471212		B40125	1079144011532012		PF46186	107914401161436		PA10408	107914401171406		PA10436			
107914401141186		PA10216 KIT	107914401147296		PA10203 KIT	107914401153376		PA10178	107914401161506		PA10409	107914401171646		PA10438			
107914401141256		PA10335	1079144011473612		P40096	107914401153446		PA10332	1079144011618112		B40140	107914401171716		PA10439			
107914401141326		20055	107914401147506		PA10170 KIT	1079144011535112		B40121	107914401163106		PA10410	107914401171886		PA10440			
107914401141496		PA10345	1079144011476712		BF46192	107914401153756		PA10175 KIT	107914401163276		PA10411	1079144011719512		PF46259			
107914401141566		PA10326	107914401147746		PA10189	107914401153826		PA10176	107914401163346		PA10412	107914401172186		PA10441			
1079144011417012		P40118	1079144011478112		P40131	107914401153996		PA10333	107914401163586		B40142	1079144011731712		P40156			
1079144011418712		BF46219	107914401147986		PA10258	107914401154056		PA10334	1079144011636512		PE17002 KIT						
1079144011419412		BF46198	1079144011480412		BF46220	107914401154126		PA10330	107914401163726		PA30331						

NOTES

I 2/5 TO BALDWIN CASE (SHIPPING CASES)

I 2/5 NUMBER	CASE QTY.	BALDWIN NUMBER	I 2/5 NUMBER	CASE QTY.	BALDWIN NUMBER	I 2/5 NUMBER	CASE QTY.	BALDWIN NUMBER	I 2/5 NUMBER	CASE QTY.	BALDWIN NUMBER	I 2/5 NUMBER	CASE QTY.	BALDWIN NUMBER
ITF Code Qty/Case	BDW #													
1079144000015	12	B2	10791440001128	12	PT88-HD	10791440002156	12	P171	10791440003139	12	B253	10791440004112	12	BT353
1079144000022	12	B2-HPG	10791440001135	12	PT89	10791440002163	12	P172	10791440003153	12	B255	10791440004129	12	BT354
1079144000046	12	B4	10791440001142	12	PT90-10	10791440002170	12	B173-S	10791440003160	12	PT256	10791440004136	12	BT355
1079144000053	12	BT5	10791440001159	12	PT90-MPG	10791440002187	12	P174	10791440003177	12	PT257	10791440004143	12	P356
1079144000060	12	B6	10791440001166	12	PT91	10791440002200	12	P176	10791440003184	12	PT258	10791440004150	12	BT357
1079144000077	12	B6-HPG	10791440001180	12	PT93	10791440002217	12	P177	10791440003191	12	BT259	10791440004167	12	B358
1079144000084	12	B7	10791440001197	12	PT93-MPG	10791440002224	12	B178	10791440003207	12	BT260	10791440004174	6	BT359
1079144000091	12	B9	10791440001210	6	B95	10791440002231	12	B179	10791440003214	12	BT260-10	10791440004181	12	B360
1079144000107	6	B10-AL	10791440001241	6	B95-MPG	10791440002262	10	G183	10791440003221	12	BT261	10791440004198	12	BT361
1079144000114	6	B10-AL BOWL	10791440001258	6	B96	10791440002279	10	P183	10791440003238	12	B262	10791440004211	12	BT364
1079144000121	6	B10-AL CAP	10791440001289	6	B96-MPG	10791440002293	12	P184	10791440003245	12	B263	10791440004228	12	BT365
1079144000138	12	PF10	10791440001296	6	B97	10791440002309	12	PT185	10791440003252	12	BT264	10791440004235	12	BT365-10
1079144000145	12	PF10-CS	10791440001302	6	PT98-10	10791440002316	12	P186	10791440003269	12	PT265	10791440004242	12	BT366-10
1079144000152	12	PT11	10791440001319	6	PT98-MPG	10791440002323	12	P187	10791440003276	12	P266	10791440004259	12	BT367
1079144000169	12	PT11-HD	10791440001326	6	B99	10791440002347	12	PT189	10791440003283	12	BT267	10791440004266	12	BT367-S
1079144000176	12	PT12	10791440001333	6	B99-B	10791440002354	12	PT189-MPG	10791440003290	12	PT268	10791440004273	12	BT368
1079144000183	12	BF13	10791440001357	6	B99-MPG	10791440002361	12	P190	10791440003306	12	PT269	10791440004280	12	B369
1079144000190	12	P15	10791440001371	18	101-30	10791440002385	6	PT191-10	10791440003320	12	P271	10791440004297	4	PT370
1079144000206	12	S16-1	10791440001388	12	P102	10791440002446	6	P194	10791440003344	12	PT273	10791440004303	12	BT371-10
1079144000237	12	P18	10791440001395	6	BD103	10791440002453	6	P194-HD	10791440003351	12	BT274	10791440004310	12	BT371-MPG
1079144000244	12	P18-HD	10791440001401	12	P104	10791440002460	6	P194-HD10	10791440003368	12	PT275	10791440004327	12	BT372-10
1079144000251	12	P19	10791440001418	6	B105	10791440002477	6	PF194	10791440003375	12	PT275-10	10791440004334	12	PT373
1079144000268	12	P20-HD	10791440001425	12	P106	10791440002484	12	B195	10791440003382	12	P276	10791440004341	12	PT374
1079144000336	12	P25	10791440001432	12	PT106-HD	10791440002491	6	B196	10791440003405	12	PT277	10791440004358	12	PT375
1079144000343	12	P26	10791440001456	12	PT108	10791440002514	12	P198	10791440003412	12	B279	10791440004365	12	PT376
1079144000350	12	B27	10791440001463	12	PT108-HD	10791440002521	12	B199	10791440003429	12	P280	10791440004372	12	PT377
1079144000367	12	BD28	10791440001470	12	B109	10791440002545	12	B201-S	10791440003436	12	B281	10791440004389	12	PT377-10
1079144000374	12	PT29	10791440001487	12	BC110	10791440002552	12	B202	10791440003467	12	PT283	10791440004396	12	B378
1079144000398	12	B30	10791440001494	12	BT111	10791440002569	12	P203	10791440003474	12	PT284	10791440004402	12	B378-10
1079144000404	12	B31	10791440001500	12	BT112	10791440002576	12	P203-HD	10791440003481	6	PT285	10791440004419	6	PT379 KIT
1079144000428	12	B33	10791440001517	12	B113	10791440002583	12	P203-HD10	10791440003498	6	BT287	10791440004433	12	PT381
1079144000435	12	B34	10791440001524	12	B114	10791440002590	12	P204	10791440003504	6	BT287-10	10791440004440	12	PT382
1079144000442	12	B35-S	10791440001531	12	PT115	10791440002606	12	P204-HD	10791440003511	12	PT288-HD	10791440004457	12	PT383
1079144000466	6	AFG37R	10791440001555	6	PF116	10791440002613	12	P204-HD10	10791440003528	12	PT288-HD10	10791440004464	12	PT385
1079144000473	12	B37	10791440001562	6	PT117	10791440002620	6	B205	10791440003535	12	PT289	10791440004471	12	PT385-E
1079144000480	6	AFG38D	10791440001579	6	PT117-25	10791440002637	12	P206	10791440003542	12	PT289-10	10791440004488	12	PT386
1079144000503	12	B39	10791440001586	12	B118	10791440002644	12	PT207	10791440003559	12	PT290	10791440004495	6	BT387
1079144000510	12	P40	10791440001647	12	B120	10791440002651	12	PT207-10	10791440003573	12	BT292	10791440004501	6	BT387-10
1079144000527	12	P41	10791440001654	12	PF121	10791440002668	12	PT207-HD	10791440003597	12	P294	10791440004518	6	BT388
1079144000534	12	P42	10791440001685	12	BT124	10791440002675	12	PT207-HD10	10791440003603	12	B295	10791440004525	6	BT388-10
1079144000541	12	B43-S	10791440001692	12	P125	10791440002682	6	PT208	10791440003610	12	B296	10791440004532	6	BT389
1079144000555	12	B45	10791440001708	12	BT126	10791440002699	12	PT210	10791440003627	12	PT298-10	10791440004549	6	BT389-10
1079144000589	12	B47	10791440001715	12	B128	10791440002705	12	B211	10791440003634	12	B299	10791440004556	12	PT390-MPG
1079144000596	12	PT48	10791440001722	12	B129	10791440002729	12	PT213	10791440003641	12	T300-M	10791440004563	12	PT391-MPG
1079144000602	6	B49	10791440001746	12	B131	10791440002736	12	PT214(2)	10791440003658	12	B301	10791440004570	12	PT392
1079144000619	12	B50	10791440001753	12	B132	10791440002743	12	BT125	10791440003665	12	PT302	10791440004587	12	PT393
1079144000633	12	P52	10791440001760	7	C133-OW	10791440002750	12	BT216	10791440003672	12	T303-M	10791440004594	6	PT394-15
1079144000640	12	P53	10791440001777	7	C133-W	10791440002767	12	BT217	10791440003689	12	PT304	10791440004600	12	BT395
1079144000657	12	P54	10791440001784	12	B134	10791440002774	12	B218	10791440003702	12	B307	10791440004617	12	PT396
1079144000671	12	B56	10791440001791	12	PT135	10791440002798	6	B220	10791440003719	12	T308-M	10791440004624	4	PT397
1079144000718	12	P60	10791440001814	12	PT137	10791440002804	12	BT221	10791440003726	12	B309	10791440004631	12	BT398
1079144000725	12	PT61-HD	10791440001821	12	PT138-10	10791440002811	12	B222	10791440003733	12	PF311	10791440004648	12	PT400
1079144000732	12	PT62	10791440001838	12	PT138-25	10791440002828	12	BT223	10791440003740	12	PF312	10791440004655	6	PT401-MPG
1079144000749	12	PT63-1	10791440001845	12	PT139-10	10791440002835	12	PF224	10791440003757	12	PF313	10791440004662	12	BT402
1079144000770	12	PT66-HD	10791440001852	12	P140	10791440002859	12	PF225	10791440003764	12	PF314	10791440004679	12	B403
1079144000787	12	P67	10791440001869	12	B141	10791440002873	12	PF226	10791440003771	6	PF316	10791440004686	6	B404
1079144000794	12	P68	10791440001876	12	BD142	10791440002880	12	B227	10791440003788	6	BD324	10791440004693	12	JC405
1079144000817	12	PT70	10791440001883	12	B143	10791440002897	12	B228	10791440003805	12	B326	10791440004710	12	CU406
1079144000831	12	PT71	10791440001890	12	P144	10791440002903	12	B229	10791440003822	12	B329	10791440004716	6	DF408
1079144000855	12	PT72	10791440001906	12	PT146	10791440002910	12	BT230	10791440003839	12	BF330	10791440004846	12	TC413-CPE5
1079144000879	12	PT73	10791440001920	12	P148	10791440002927	12	PF231	10791440003894	12	PF332	10791440004860	4	V414-B
1079144000886	12	B74	10791440001944	12	P150	10791440002934	12	B233	10791440003900	12	PF333	10791440004877	4	V414-FF
1079144000893	12	B75	10791440001951	12	PT151	10791440002958	6	BT234	10791440003917	6	B333	10791440004884	4	F415-B
1079144000909	12	B76	10791440001968	12	PT152	10791440002965	12	P235	10791440003924	12	B336	10791440004891	4	P415-10
1079144000930	12	B76-MPG	10791440001975	12	PT153	10791440002972	12	B236	10791440003931	12	B337	10791440004907	4	P415-10A
1079144000961	12	PT79	10791440001982	12	PT154	10791440002989	12	BT237	10791440003938	12	BT338	10791440004914	4	P415-25
1079144000985	12	P80	10791440001999	12	PF155	10791440002996	12	BT238	10791440003945	12	BT339	10791440004921	4	P415-25A
1079144000992	12	P80-HD	10791440002002	12	B156	1								

I 2/5 TO BALDWIN CASE (SHIPPING CASES)

UPC NUMBER	CASE QTY.	BALDWIN NUMBER	UPC NUMBER	CASE QTY.	BALDWIN NUMBER	UPC NUMBER	CASE QTY.	BALDWIN NUMBER	UPC NUMBER	CASE QTY.	BALDWIN NUMBER	UPC NUMBER	CASE QTY.	BALDWIN NUMBER
10791440005072	6	BT425	10791440006147	6	P529	10791440007434	6	PA658	10791440008639	6	BF799	10791440009704	12	BF885
10791440005089	12	PT426	10791440006185	6	PT534	10791440007472	6	PA662	10791440008677	12	PF802	10791440009711	12	BF886
10791440005096	12	BT427	10791440006192	12	PT535	10791440007519	6	PA669	10791440008691	12	PF804	10791440009728	12	BF888
10791440005119	4	V429-B	10791440006208	12	BT536	10791440007526	12	PT670	10791440008707	12	BF805	10791440009742	12	BF890
10791440005126	4	V429-FF	10791440006215	6	P537	10791440007533	12	PT670-E	10791440008714	12	BF806	10791440009759	12	BF891
10791440005133	6	PT430-FF	10791440006222	12	PT538	10791440007564	6	PA675	10791440008721	12	PF807	10791440009766	12	BF892
10791440005140	12	PT431	10791440006246	12	P540	10791440007588	6	PA677	10791440008745	12	PF809	10791440009773	12	PF893
10791440005157	12	PT433	10791440006260	12	BT541	10791440007595	6	PA678	10791440008752	12	PF810	10791440009780	12	PF893-RV
10791440005164	12	PT434	10791440006284	6	PT543 KIT	10791440007601	6	PA680	10791440008769	12	PF811	10791440009797	12	PF894
10791440005171	12	PT434-10	10791440006307	12	P545	10791440007618	12	PT685-MPG	10791440008776	12	BF812	10791440009803	12	PF894-RV
10791440005188	12	PT435	10791440006314	12	PT546	10791440007625	6	PA691	10791440008790	12	PF814	10791440009827	12	BF896
10791440005195	12	PT436	10791440006321	6	PT548	10791440007632	6	PA693	10791440008813	12	PF816	10791440009841	12	SF898
10791440005201	12	PT437	10791440006338	12	PT549	10791440007663	6	PA696	10791440008820	12	PF816-S	10791440009858	12	PF899
10791440005218	12	BT438	10791440006345	6	PT550-10	10791440007670	6	PA697	10791440008844	12	PF818	10791440009865	12	BF900
10791440005225	12	PT439	10791440006376	12	PT554	10791440007687	6	PA699	10791440008851	12	PF819	10791440009896	12	PF902
10791440005232	12	BT440	10791440006383	12	P555	10791440007724	4	C704-L	10791440008868	12	PF819-HD	10791440009902	12	PF902-S
10791440005249	12	PT441	10791440006390	12	BT556-10	10791440007748	4	P706-M	10791440008875	12	PF820-S	10791440009919	12	PT903
10791440005256	12	PT442-MPG	10791440006413	6	PT558	10791440007762	12	PT707-HD	10791440008882	12	PF821-S	10791440009957	12	PF906
10791440005263	6	BT443	10791440006437	12	PT561	10791440007779	12	PT707-HD10	10791440008899	12	PF822	10791440009964	12	PF907
10791440005270	12	PT445-MPG	10791440006451	12	PT562-10	10791440007786	12	PT707-HD3	10791440008905	12	PF823	10791440009971	6	F908-A
10791440005287	12	P446	10791440006468	12	PT563	10791440007793	12	PT708-HD	10791440008950	12	PF823-E	10791440009988	12	BF909
10791440005294	12	B447	10791440006475	12	BT564	10791440007809	6	PT714	10791440008967	12	PF824	10791440009995	12	PF910
10791440005317	12	P450	10791440006482	6	PT565	10791440007816	12	PF717	10791440008981	12	BF825	10791440010021	12	BF912
10791440005324	12	S451	10791440006499	12	PT566	10791440007830	4	PT718-5	10791440008998	12	PF826	10791440010038	12	PF913
10791440005331	12	BT452	10791440006505	12	PT567	10791440007847	12	BF719	10791440009001	12	PF827	10791440010045	6	BF914
10791440005355	12	P454	10791440006512	12	PT567-10	10791440007854	12	BF720	10791440009025	12	PF828	10791440010052	12	BF915
10791440005362	12	S455	10791440006529	12	PT568	10791440007861	12	PT721	10791440009032	6	PF829(2)	10791440010069	12	F916-C
10791440005379	12	S456	10791440006604	12	BF577	10791440007878	6	PT722	10791440009049	12	BF830	10791440010076	12	PF916
10791440005386	6	PT457-MPG	10791440006611	12	PT578	10791440007885	12	P723	10791440009056	12	PF831	10791440010106	12	BF918-K
10791440005393	12	PT459	10791440006628	12	PT579	10791440007892	6	PT725-MPG	10791440009070	12	BF833	10791440010144	60	F919-C
10791440005409	12	PT461	10791440006673	12	BF582	10791440007908	24	PT727-DL	10791440009087	12	BF833-K2	10791440010199	12	BF920
10791440005416	6	PT462	10791440006680	12	BF583	10791440007915	12	PT727-HD	10791440009094	12	F834-F	10791440010236	12	PF924
10791440005423	12	PT463	10791440006697	12	BF584	10791440007922	12	PT727-HD10	10791440009100	12	PF834	10791440010250	12	PF926
10791440005454	12	PT466	10791440006703	12	BF584-B	10791440007939	12	PT728-MPG	10791440009124	12	BF836	10791440010274	12	BF928
10791440005461	6	PT467-MPG	10791440006710	12	BF585	10791440007946	4	PT729	10791440009131	12	BF836-K3	10791440010281	12	BF929
10791440005478	12	PT468-MPG	10791440006727	12	BF586	10791440007977	6	BT732	10791440009148	12	BF836-K4	10791440010298	12	BF930
10791440005492	12	BT470	10791440006734	12	BF586-D	10791440007991	12	BT735	10791440009155	12	BF837	10791440010328	12	BF932
10791440005508	12	PT471	10791440006741	12	BF587	10791440008011	12	PT737	10791440009162	12	BF838-F2	10791440010335	12	BF933
10791440005515	12	BT472	10791440006758	12	BF587-D	10791440008028	12	PT737-10	10791440009179	12	PF838	10791440010359	12	PF935
10791440005522	12	B474	10791440006765	12	BF588	10791440008035	12	V738-O	10791440009186	12	BT839	10791440010366	12	PF936
10791440005539	12	PT475	10791440006871	12	BF591	10791440008042	12	BT739	10791440009193	12	BT839-10	10791440010373	12	PF937
10791440005546	12	P476	10791440006888	12	BF592	10791440008059	12	C740-S	10791440009209	12	BF840	10791440010380	12	BF938
10791440005553	12	PT477	10791440006895	12	BF593	107914400080814	4	C750-E	10791440009216	12	BF840-K1	10791440010397	12	BF939
10791440005577	12	S479	10791440006901	12	PF594	10791440008158	4	C750-L	10791440009230	12	VT842-O	10791440010403	12	BF940
10791440005584	12	PT480	10791440006918	12	BT595	10791440008172	6	PT751	10791440009247	12	BF843	10791440010410	12	BF941
10791440005591	12	PT480-10	10791440006925	6	BF596	10791440008189	6	PT752	10791440009254	12	F844-A	10791440010427	12	PF942
10791440005607	12	PT480-MPG	10791440006932	12	BF597	10791440008219	12	PT757	10791440009261	12	BF845-A	10791440010434	12	PF943
10791440005614	12	B481	10791440006949	12	PF598	10791440008226	6	PT757-10	10791440009278	12	PF845	10791440010458	12	PF945
10791440005652	12	S485	10791440006956	12	PF598-10	10791440008240	12	PT760-10	10791440009285	12	PF846	10791440010465	12	PF946
10791440005669	6	BT486	10791440006963	12	PF598-30	10791440008257	12	PT760-25	10791440009292	12	PF847	10791440010472	12	PF947
10791440005676	12	PT487	10791440006970	12	PF599	10791440008264	12	PT761	10791440009315	12	PT849	10791440010489	12	BF948
10791440005690	12	B488	10791440006987	12	PF599-10	10791440008288	6	PT763	10791440009322	12	PT849-10	10791440010519	12	BF948-JD
10791440005706	12	S489	10791440006994	12	PF599-30	10791440008295	12	PT764	10791440009353	12	V852-O	10791440010533	12	F950-F
10791440005751	12	PT492	10791440007007	6	PA602	10791440008301	12	PT765	10791440009360	12	BF853	10791440010540	12	PF950
10791440005768	6	PT493	10791440007014	6	PA604	10791440008318	6	PT766	10791440009384	12	BF855	10791440010557	12	PT951
10791440005775	12	B494	10791440007021	12	B605	10791440008325	12	PT767	10791440009391	12	BF856	10791440010564	12	PF952
10791440005782	6	B495	10791440007045	6	PA607	10791440008332	6	PT768	10791440009407	12	PF857	10791440010571	12	BF954
10791440005812	12	P496	10791440007083	6	PA612	10791440008370	6	PT772	10791440009414	12	BF858	10791440010588	12	BF955
10791440005829	12	P497	10791440007090	6	PA613	10791440008387	6	PT773-MPG	10791440009421	12	PF859	10791440010595	12	BF956
10791440005836	12	PT498	10791440007106	12	BF614	10791440008400	6	BT775	10791440009438	12	PF860	10791440010601	12	BF957
10791440005843	12	PT498-10	10791440007113	6	PA615	10791440008417	12	PT776-MPG	10791440009445	12	PF861	10791440010625	12	BF957-D
10791440005881	4	F501-MD	10791440007151	6	PA618 FOAM	10791440008424	12	PT777	10791440009452	12	BF862	10791440010632	12	BF958
10791440005928	12	PF506	10791440007182	6	PA621	10791440008431	12	BT778	10791440009469	12	BF863	10791440010649	12	BF959
10791440005935	12	P507	10791440007199	6	PA625	10791440008448	12	BT779	10791440009476	12	PF864	10791440010656	12	P960
10791440005942	12	PT508-MPG	10791440007205	6	PA631	10791440008455	12	BF781	10791440009483	12	BF865	10791440010670	12	BF962
10791440005966	12	PT510	10791440007212	6	PA632	10791440008462	12	BF782	10791440009490	12	BF865-K	10791440010687	12	PF963
10791440005973	4	PT512	10791440007229	12	PA633(2)	10791440008479	12	BF783	1079144000					

I 2/5 TO BALDWIN CASE (SHIPPING CASES)

I 2/5 NUMBER	CASE QTY.	BALDWIN NUMBER	I 2/5 NUMBER	CASE QTY.	BALDWIN NUMBER	I 2/5 NUMBER	CASE QTY.	BALDWIN NUMBER	I 2/5 NUMBER	CASE QTY.	BALDWIN NUMBER	I 2/5 NUMBER	CASE QTY.	BALDWIN NUMBER
10791440010878	12	PF986	10791440013404	6	PA1719	10791440015965	6	PA2081	10791440017877	6	PA2347	10791440029153	12	PT8318-MPG
10791440010885	12	PF987	10791440013411	6	PA1721	10791440015989	6	PA2083	10791440019260	6	PA2472	10791440029160	6	BT8320
10791440010892	12	BF988	10791440013442	6	PA1735	10791440015996	12	SA2084	10791440019307	6	PA2476	10791440029191	6	BT8802-MPG
10791440010908	12	BF989	10791440013466	12	PA1748	10791440016009	12	SA2085	10791440019314	6	PA2477	10791440029207	6	BT8803-MPG
10791440010922	12	BF991	10791440013534	12	PA1757	10791440016054	6	PA2091	10791440019376	6	PA2483	10791440029238	6	BT8812-MPG
10791440010939	12	BF992	10791440013541	6	PA1758	10791440016061	6	PA2092	10791440021317	6	PA2653 FOAM	10791440029986	6	18104
10791440010953	12	BF995	10791440013558	12	PA1763	10791440016085	6	PA2094	10791440022789	12	PA2798	10791440030012	6	18139
10791440010960	12	P996	10791440013572	12	PA1765 FOAM	10791440016092	4	PA2095	10791440026558	6	PA4016	10791440030036	6	18155
10791440010977	12	P998	10791440013756	6	PA1786	10791440016108	6	PA2096	10791440026565	6	PA4018	10791440030050	6	18171
10791440010991	12	P999-HD	10791440013831	6	PA1798	10791440016115	6	PA2099	10791440026589	6	PA4023	10791440030074	6	18198
10791440011066	12	V1044-O	10791440013848	6	PA1800	10791440016122	6	PA2100	10791440026596	6	PA4026	10791440030111	6	18236
10791440011073	12	BF1102	10791440013862	6	PA1802	10791440016139	6	PA2101A	10791440026602	6	PA4028	10791440030128	6	18245
10791440011097	12	BF1104	10791440013886	6	PA1805	10791440016146	6	PA2102	10791440026657	6	PA4050	10791440030340	6	19828
10791440011103	12	BF1105	10791440013916	4	PA1809	10791440016153	6	PA2103	10791440026688	6	PA4060	10791440030449	6	19992
10791440011141	12	BF1110	10791440013947	6	PA1814	10791440016160	6	PA2104	10791440026749	12	CS5007	10791440030463	6	BT8307-MPG
10791440011172	12	BF1120	10791440014074	6	PA1828	10791440016184	6	PA2106	10791440026756	12	CS5008	10791440030470	6	BT8308-MPG
10791440011189	12	BF1123	10791440014104	6	PA1832	10791440016191	6	PA2107	10791440026763	6	CS5009	10791440034935	12	61
10791440011257	12	BF1140	10791440014111	6	PA1834	10791440016214	6	PA2109	10791440026794	4	CS5012	10791440034942	12	61-W
10791440011288	12	BF1148	10791440014166	6	PA1841	10791440016221	6	PA2110	10791440026893	6	CS5058	10791440034980	12	66
10791440011295	12	BF1150	10791440014265	6	PA1852	10791440016252	6	PA2113	10791440026909	10	OTK5060	10791440034997	12	66-W
10791440011349	12	BF1160	10791440014296	6	PA1857	10791440016269	6	PA2114	10791440026916	12	OTK5061	10791440035574	18	101
10791440011363	12	BF1163	10791440014302	6	PA1858	10791440016276	6	PA2115	10791440026930	10	OTK5063	10791440035598	18	101-W
10791440011387	12	BF1166	10791440014319	6	PA1859	10791440016283	4	PA2116	10791440026947	12	BW5070	10791440035918	18	151
10791440011424	12	BF1170	10791440014326	6	PA1860	10791440016290	6	PA2117	10791440026954	12	BW5071	10791440035925	18	151-30
10791440011431	12	BF1171	10791440014333	6	PA1861	10791440016320	6	PA2121	10791440026961	12	BW5072	10791440035932	18	151-W
10791440011448	12	BF1201	10791440014418	4	PA1873	10791440016351	6	PA2124	10791440026978	12	BW5073	10791440036465	8	201
10791440011479	12	BF1210	10791440014425	4	V1874-T	10791440016368	6	PA2125	10791440026985	12	BW5074	10791440036472	8	201-30
10791440011486	12	BF1211	10791440014432	12	PA1875	10791440016382	6	PA2127	10791440026992	12	BW5075	10791440036496	8	201-W
10791440011493	12	BF1212	10791440014562	6	PA1888	10791440016450	6	PA2134	10791440027005	12	BW5076	10791440036953	4	301
10791440011509	12	BF1212 FOAM	10791440014579	6	PA1889	10791440016467	6	PA2135	10791440027043	12	B5134	10791440036960	4	301-30
10791440011523	12	BF1213	10791440014586	6	PA1891	10791440016474	6	PA2136	10791440027050	12	BW5136	10791440036977	4	301-CS
10791440011530	12	BF1214	10791440014777	12	PA1909	10791440016498	6	PA2138	10791440027067	12	BW5137	10791440036984	4	301-W
10791440011547	6	BF1216	10791440014814	12	PA1915	10791440016504	6	PA2139	10791440027074	12	BW5138	10791440037059	4	501
10791440011554	12	BF1218	10791440014937	4	PA1934	10791440016511	6	PA2140	10791440027081	12	BW5139	10791440037066	4	501-30
10791440011561	12	BF1219	10791440015019	6	PA1946	10791440016573	6	PA2147	10791440027098	12	BW5140	10791440037073	4	501-W
10791440011578	12	BF1220	10791440015026	6	PA1949	10791440016580	6	PA2148	10791440027104	12	BW5141	10791440037578	12	PT8344
10791440011585	12	BF1221	10791440015040	6	PA1951	10791440016597	6	PA2149	10791440027128	12	B5176	10791440037585	12	P7303
10791440011592	12	BF1223	10791440015125	6	PA1963	10791440016603	6	PA2150	10791440027135	12	B5177	10791440037615	12	B07028
10791440011608	12	BF1225	10791440015149	6	PA1969	10791440016627	6	PA2152	10791440027142	12	BW5178	10791440037622	12	B7501
10791440011615	12	BF1226	10791440015170	6	PA1973	10791440016634	6	PA2153	10791440027159	12	BW5179	10791440037639	12	PF7559
10791440011639	12	BF1232	10791440015293	12	PA1985	10791440016641	6	PA2154	10791440027180	12	BF5801	10791440037684	12	PF7550
10791440011646	12	BF1233	10791440015422	6	PA2001	10791440016665	6	PA2156	10791440027197	12	BF5800	10791440037691	12	PF7551
10791440011677	8	V1240-C	10791440015439	6	PA2002	10791440016689	6	PA2158	10791440027203	12	BF5810	10791440037745	12	BF7552
10791440011691	12	BF1259	10791440015453	6	PA2005	10791440016696	12	SA2159	10791440027210	12	BF5812	10791440037851	12	B7039
10791440011707	12	BF1276	10791440015460	6	PA2006	10791440016702	6	PA2160	10791440027227	12	BF5813	10791440037882	12	BF7546
10791440011714	12	BF1280	10791440015477	6	PA2007	10791440016726	6	PA2162	10791440027289	6	6017	10791440037899	12	BF1345
10791440012032	12	BF1400	10791440015484	6	PA2008	10791440016733	6	PA2163	10791440027302	6	6020	10791440037967	12	BF7544
10791440012056	12	B1402	10791440015491	6	PA2009	10791440016740	6	PA2164	10791440027319	6	6021	10791440037981	12	BF7541
10791440012087	12	B1406	10791440015507	6	PA2010	10791440016771	6	PA2167	10791440028484	3	P7003	10791440037998	12	BF880-FP
10791440012094	12	B1407	10791440015538	6	PA2023	10791440016788	6	PA2168	10791440028491	6	B7004	10791440038056	12	BT305
10791440012124	12	B1428	10791440015545	6	PA2024	10791440016795	6	PA2169	10791440028507	6	B7005	10791440038063	12	B7047
10791440012179	4	P1510	10791440015569	12	SA2027	10791440016818	6	PA2171	10791440028538	12	B7009	10791440038070	12	PT8345
10791440012186	4	P1511	10791440015576	6	PA2031	10791440016887	6	PA2178	10791440028545	12	B7010	10791440038087	12	BT8328
10791440012193	4	V1520-R	10791440015606	6	PA2036	10791440016917	6	PA2181	10791440028552	6	B7011	10791440038117	12	P7035
10791440012216	6	V1542-C	10791440015613	6	PA2037	10791440016962	6	PA2188	10791440028569	12	B7014	10791440038124	12	BT372-MPG
10791440012223	16	V1544-T	10791440015637	12	SA2039	10791440016979	6	PA2189	10791440028576	12	B7018	10791440038131	6	P7000 KIT
10791440012230	12	PA1600	10791440015644	6	PA2041	10791440016993	6	PA2191	10791440028583	6	B7019	10791440038216	12	B1429
10791440012254	12	PA1603	10791440015651	4	PA2042	10791440017013	6	PA2193	10791440028590	12	B7020	10791440038247	12	PF7553
10791440012520	6	PA1627	10791440015668	6	PA2044	10791440017020	6	PA2194	10791440028606	12	B7022	10791440038254	12	PF7554
10791440012605	6	PA1633	10791440015699	6	PA2050	10791440017044	6	PA2196	10791440028613	12	B7023	10791440038292	6	BT8347
10791440012681	6	PA1639	10791440015705	6	PA2051	10791440017112	6	PA2204	10791440028620	12	B7024	10791440038346	12	BF7559
10791440012742	12	F1645-DS	10791440015712	6	PA2052	10791440017143	6	PA2207	10791440028637	12	B7025	10791440038353	12	BF1346
10791440012759	7	V1645-C	10791440015729	6	PA2053	10791440017150	6	PA2208	10791440028712	4	F7500	10791440038384	12	B7044
10791440012803	6	PA1648	10791440015774	6	PA2061	10791440017198	6	PA2212	10791440028729	4	P7500	10791440038391	6	BT8840-MPG
10791440012865	6	V1656-O	10791440015798	6	PA2063	10791440017211	6	PA2214	10791440028767	12	BF7519	10791440038407	6	BT8862
10791440012872	6	V1656-T	10791440015804	6	PA2064	10791440017235	6	PA2216	10791440028828	12	BF7528	10791440038414	6	BT8863
10791440012889	6	PA1657	10791440015811</											

I 2/5 TO BALDWIN CASE (SHIPPING CASES)

I 2/5 NUMBER	CASE BALDWIN QTY. NUMBER	I 2/5 NUMBER	CASE BALDWIN QTY. NUMBER	I 2/5 NUMBER	CASE BALDWIN QTY. NUMBER	I 2/5 NUMBER	CASE BALDWIN QTY. NUMBER	I 2/5 NUMBER	CASE BALDWIN QTY. NUMBER
10791440038919	12.....BT8323	10791440045641	12.....BF1329-SP	10791440049038	12.....BF1178	10791440051345	6.....18024	10791440054650	6.....PA4106
10791440038940	6.....PT8330-MPG	10791440045665	12.....BF1222-SP	10791440049045	12.....BF1179	10791440051352	6.....18022	10791440054667	6.....PA4107
10791440038957	6.....BT8333	10791440045672	12.....BF1222	10791440049083	12.....BF1181	10791440051376	6.....18027	10791440054674	12.....B7139
10791440038964	6.....BT8850-MPG	10791440045696	6.....PA2233	10791440049090	6.....PA2237	10791440051390	12.....B7125	10791440054698	12.....B1416
10791440038988	6.....BT8861	10791440045702	12.....BF1329	10791440049113	12.....BF1182	10791440051406	6.....PA4092	10791440054834	6.....BF7639-D
10791440039145	6.....18268	10791440045719	12.....P7052	10791440049120	12.....BF1184	10791440051451	12.....BT8393	10791440054872	12.....BF1261
10791440039329	6.....BT8851-MPG	10791440045788	12.....BF1347	10791440049137	12.....BF1185	10791440051499	6.....BF7623	10791440054896	6.....BD1403
10791440039350	12.....PT8350	10791440045801	12.....BF1345-SP	10791440049144	12.....BF1186	10791440051505	12.....SA2047	10791440054902	12.....BF7658
10791440040240	6.....B7030	10791440045818	12.....BF1205	10791440049229	6.....PA4044	10791440051512	12.....BF1253	10791440054919	12.....BF7659
10791440041186	12.....PT8352	10791440045825	12.....BF1204	10791440049236	6.....PA4045	10791440051659	6.....BT8848-MPG	10791440054933	12.....BF7661
10791440041193	12.....PT8351	10791440045832	12.....BF1205-SP	10791440049243	6.....PA4046	10791440051666	12.....BF7624	10791440054957	6.....PA4108
10791440041209	6.....PT8355	10791440045894	12.....PT8339	10791440049335	6.....PA4047	10791440051734	6.....PA4093	10791440054964	6.....PA4109
10791440041292	6.....BF7571	10791440045900	12.....BF1348	10791440049342	6.....PA4048	10791440051741	6.....PA4094	10791440054971	12.....BF7663
10791440041490	12.....BF1173	10791440045917	12.....BF1204-SP	10791440049380	12.....BF1215	10791440051772	12.....BF7625	10791440054988	12.....BF7664
10791440041537	12.....BF7534	10791440045924	6.....BT610-MPG	10791440049403	6.....PA4049	10791440051789	12.....B1425	10791440055039	12.....BF7657
10791440042497	12.....PT8354	10791440045931	6.....BT8846	10791440049410	12.....BF1190	10791440051895	12.....BF1348-SP	10791440055046	6.....PA3836
10791440042503	12.....PT8355	10791440045948	6.....BT8852-MPG	10791440049427	12.....BF1191	10791440051901	12.....BT8398-MPG	10791440055053	12.....BF7666
10791440042527	6.....BF1239	10791440045955	6.....BT611-MPG	10791440049441	12.....BF1193	10791440051970	6.....BT8842-MPG	10791440055077	6.....PA3839
10791440042534	12.....PF7572	10791440046068	12.....BD7095	10791440049465	12.....BF1195	10791440052007	6.....BT8843-MPG	10791440055084	6.....PA3840
10791440042565	12.....P7013	10791440046075	6.....PA2234	10791440049526	12.....BF1199	10791440052038	12.....BF7626	10791440055091	6.....BD7141
10791440042626	6.....BT8845	10791440046112	12.....BF1223-SP	10791440049533	6.....PA4071	10791440052045	6.....PF7627	10791440055107	6.....BT8416
10791440042633	6.....BT8844	10791440046129	12.....BF7593	10791440049564	6.....PA3083	10791440052083	12.....B7128	10791440055114	12.....BF7667
10791440042640	12.....PA2001 FOAM	10791440046280	12.....PF7594	10791440049571	12.....BF1045	10791440052120	6.....BT8401-MPG	10791440055121	12.....B7142
10791440042671	6.....BD103-MPG	10791440046297	12.....PF7595	10791440049588	12.....BF1046	10791440052199	12.....PT8403-MPG	10791440055138	6.....PA4110
10791440042763	12.....BF7576	10791440046419	12.....PF7596	10791440049595	12.....BF1047	10791440052212	6.....PA3419	10791440055175	6.....18032
10791440042770	12.....BF7579	10791440046426	6.....BT8870-MPG	10791440049601	12.....BF1048	10791440052229	12.....BF7628	10791440055173	6.....BT8849-MPG
10791440042787	12.....BF7580	10791440046440	6.....BT8874-MPG	10791440049618	12.....BF1049	10791440052274	12.....BF7629	10791440055179	6.....BT8855-MPG
10791440042823	12.....PT8329	10791440046464	12.....BT606-MPG	10791440049625	12.....BF1050	10791440052281	12.....PT8404-MPG	10791440055156	6.....BT8877-MPG
10791440042992	6.....BT8830	10791440046471	12.....P7021	10791440049687	6.....BT8381	10791440052304	6.....PA4099	10791440055163	6.....BT8878-MPG
10791440043005	6.....BT8832	10791440046518	6.....BT8873	10791440049731	6.....PA2240	10791440052328	12.....BF7631	10791440055170	6.....BT8879-MPG
10791440043074	12.....B1430	10791440046532	12.....PF7597	10791440049762	6.....PA2243	10791440052359	12.....BF7632	10791440055177	12.....B7143
10791440043098	12.....PT8356	10791440046556	12.....BF7532	10791440049779	6.....PA2244	10791440052441	6.....PA4100	10791440055182	12.....B1431
10791440043104	12.....BW5082	10791440046563	6.....BT8875-MPG	10791440049878	12.....BF1008	10791440052526	7.....V7129-C	10791440055189	12.....BT8417
10791440043135	12.....BF7584	10791440046624	12.....P7015	10791440050041	6.....PA4084	10791440052588	12.....BW5142	10791440055196	12.....BT8415
10791440043142	12.....P7081	10791440046723	12.....P7016	10791440050102	6.....BT8382	10791440052601	12.....B7130	10791440055193	12.....BT8413
10791440043159	12.....PT8319	10791440046730	12.....P7017	10791440050133	12.....P1418	10791440052618	12.....B7131	10791440055191	12.....B1432
10791440043166	12.....PT8341	10791440046914	6.....BT8841-MPG	10791440050140	12.....P1419	10791440052625	12.....BF7645	10791440055192	12.....PA3872
10791440043173	6.....PT8335	10791440047027	12.....B7099	10791440050263	12.....BF1172	10791440052663	12.....BF1249-SP	10791440055190	12.....PA3873
10791440043203	12.....BT8357	10791440047065	6.....PA4075	10791440050294	12.....B7119	10791440052748	12.....BF7644	10791440055197	12.....BF7670
10791440043234	24.....CTK5029	10791440047119	6.....PT8370-MPG	10791440050300	6.....PA4085	10791440052755	6.....18029	10791440055194	12.....B7144
10791440043272	12.....B7585	10791440047126	6.....PT8371-MPG	10791440050324	12.....BF1240	10791440052915	12.....P127	10791440055191	6.....PA3880
10791440043289	12.....B7082	10791440047171	12.....BF1258	10791440050331	12.....BT8384	10791440052946	12.....F594-F	10791440055198	6.....PA4111
10791440043302	12.....BF7586	10791440047515	12.....BD325	10791440050348	6.....B495-SS	10791440053004	12.....F950-F WO	10791440055111	6.....BT8418
10791440043319	12.....BF7587	10791440047539	6.....PA4077	10791440050386	6.....B96-SS	10791440053011	12.....F953-F	10791440055180	6.....BT8880-MPG
10791440043326	12.....P7083	10791440047553	12.....P7103	10791440050393	6.....B95-SS	10791440053028	12.....PF997	10791440055197	12.....PT8419
10791440043333	12.....PF7588	10791440047577	12.....BF7598	10791440050409	6.....BD103-SS	10791440053066	12.....BF7648	10791440055203	6.....18033
10791440043340	12.....BF1231	10791440047584	12.....P7104	10791440050416	6.....B99-SS	10791440053073	12.....PT8407	10791440055210	6.....18034
10791440043357	12.....P7084	10791440047591	6.....BD7105	10791440050423	12.....B76-SS	10791440053110	12.....BF7633	10791440055258	12.....BF7640
10791440043432	6.....PA4005	10791440047607	12.....P7106	10791440050430	12.....B7600-SS	10791440053127	12.....P7132	10791440055265	12.....BF7653
10791440043449	12.....B1405	10791440047614	12.....P7107	10791440050454	12.....BF7612	10791440053134	6.....PA4102	10791440055289	6.....PA3890
10791440043456	6.....PA2200	10791440047652	12.....PT8372	10791440050461	12.....BF7613	10791440053196	12.....BT8409	10791440055686	12.....P1433
10791440043470	6.....PA2228	10791440047669	12.....BF7602	10791440050485	12.....BF1248	10791440053288	12.....BW5200	10791440055616	12.....P7145
10791440043494	6.....PA2230	10791440047676	6.....PA4078	10791440050508	12.....BF7614	10791440053295	12.....BF7634	10791440055639	6.....BF1277-SP
10791440043555	12.....B1410	10791440047720	12.....BF1100	10791440050515	12.....P7615	10791440053301	6.....BT8853-MPG	10791440055646	12.....BF1273-SP
10791440043623	6.....PA4069	10791440047829	12.....BF7606	10791440050522	12.....BT8121	10791440053363	12.....BF1257	10791440055614	6.....BF1262
10791440043630	6.....PA4070	10791440047843	12.....B7113	10791440050539	12.....PT8385	10791440053370	6.....BF7635	10791440055684	6.....B7151
10791440043647	6.....PA4071	10791440047867	6.....PA3697	10791440050546	12.....BF1052	10791440053592	12.....PA2862 FOAM	10791440055682	12.....B7152
10791440043654	12.....PT8338	10791440047874	6.....PA4079	10791440050584	12.....B1421	10791440053691	12.....PA2884	10791440055683	6.....BD7153
10791440043661	12.....PF7545	10791440047881	6.....18009	10791440050591	12.....BT8386	10791440054162	6.....PA3414	10791440055689	6.....BD7154
10791440043678	12.....B7045	10791440047904	6.....18004	10791440050614	12.....PT7617	10791440054230	12.....B7033	10791440055697	6.....B7155
10791440043715	12.....P7050	10791440047935	6.....18007	10791440050621	12.....BF1349	10791440054247	12.....BF7034	10791440055692	12.....BT8420
10791440043722	6.....PT8334	10791440047959	6.....18009	10791440050829	12.....BF1056	10791440054261	12.....BF7537	10791440055702	12.....BW5143
10791440043791	6.....PA4072	10791440047966	6.....18010	10791440050843	12.....B1422	10791440054322	12.....P7134	10791440055703	12.....PF7680
10791440043814	6.....PA4073	10791440047977	6.....18013	10791440050904	12.....PF7618	10791440054360	6.....B7135	10791440055708	12.....BW5201
10791440044996	12.....B7049	10791440048147	6.....PT8375-MPG	10791440050942	12.....BT8391	10791440054391	6.....PA3822	10791440055742	6.....PA4112
10791440045016	12.....B7089	10791440048154	6.....PT8376-MPG	10791440050966	12.....BF7619	10791440054407	6.....PA3823	10791440055749	6.....PA3901
10791440045030	12.....BF1224	10791440048192	12.....B7001	10791440050980	12.....BF1249	10791440054442	12.....BT8412	10791440055744	12.....PF7655
10791440045092	12.....PT8363	10791440048260	12.....P7114	10791440051000	12.....BT8392	10791440054438	6.....BF7639	10791440055749	12.....B7156
10791440045115	6.....PA2231	10791440048703	12.....B7026-MPG	10791440051048	12.....BF1252	10791440054469	12.....BF7656	10791440055707	12.....BF7668
10791440045160	12.....PT394-5	10791440048727	12.....B7116	10791440051086	12.....BF1217	10791440054513	6.....PA4103	10791440055721	6.....BT8422-MPG
10791440045214	12.....B7091	10791440048734	6.....PA3763	10791440051147	6.....PA4088	10791440054537	12.....BF1256	10791440055750	12.....BW5086
10791440045245	12.....BF7535	10791440048772	6.....BT8876-MPG	10791440051154	6.....PA4089	10791440054575	12.....PF7678	10791440055767	6.....B7157
10791440045481	6.....PA2232	10791440048826	12.....B7117	10791440051168	6.....PA4090	10791440054582	6.....PA3834	10791440055787	6.....PA4113
10791440045498	6.....BT8368	10791440048888	6.....PA2235						

I 2/5 TO BALDWIN CASE (SHIPPING CASES)

I 2/5 NUMBER	CASE QTY.	BALDWIN NUMBER	I 2/5 NUMBER	CASE QTY.	BALDWIN NUMBER	I 2/5 NUMBER	CASE QTY.	BALDWIN NUMBER	I 2/5 NUMBER	CASE QTY.	BALDWIN NUMBER	I 2/5 NUMBER	CASE QTY.	BALDWIN NUMBER
10791440058030	12	BF1330-SP	10791440060156	12	PT8452	10791440062549	6	PA4148	10791440065007	12	BF7806	10791440066882	6	PA4668
10791440058054	12	B7165	10791440060170	6	PA3970	10791440062556	12	B1446	10791440065014	12	PT2323	10791440066929	12	B5145
10791440058078	6	PA3825	10791440060217	12	B7177	10791440062587	4	V1560	10791440065038	12	BF7808	10791440066950	12	BF7775
10791440058108	6	PA4114	10791440060286	12	P7178	10791440062600	12	P7199	10791440065052	6	PA4157	10791440066967	12	BF7776
10791440058122	6	B7161	10791440060293	12	B7179	10791440062631	12	PT8481	10791440065069	12	BF1350-SP	10791440066974	12	BF5816
10791440058146	6	BD7166	10791440060316	6	PA4128	10791440062655	12	BF7742	10791440065076	12	BF7809	10791440067001	12	PF7777
10791440058160	6	BT8833	10791440060323	6	PA4129	10791440062785	12	PT8496-MPG	10791440065083	12	PT2325	10791440067018	12	BF7778
10791440058238	6	BT287-3	10791440060347	4	PT8453	10791440062808	12	PF7744	10791440065090	12	PT8884-MPG	10791440067025	12	BT8905
10791440058245	12	BT8428-MPG	10791440060354	6	PA3980	10791440062853	12	BT8497-MPG	10791440065137	12	PF7812 KIT	10791440067032	6	B7246
10791440058269	12	B5087	10791440060378	6	18264	10791440062938	12	BT8460	10791440065151	12	BF7766	10791440067087	12	PF7779
10791440058276	12	B5088	10791440060385	6	18265	10791440062952	12	PF7751	10791440065168	12	PT8885-MPG	10791440067124	6	BT8906
10791440058283	12	BF1265	10791440060446	6	PA4132	10791440062990	12	B7215	10791440065199	6	BT8886-MPG	10791440067131	6	PA4169
10791440058313	12	BT8429	10791440060453	6	18267	10791440063003	12	BT8499	10791440065250	6	PA4158	10791440067148	12	BF7780
10791440058399	12	B7685	10791440060477	12	BF7713	10791440063058	12	BT8501-MPG	10791440065311	12	BF7813	10791440067155	12	PT8907-MPG
10791440058405	6	B7175	10791440060484	6	PA4133	10791440063089	6	PA4149 KIT	10791440065335	6	PA4632	10791440067162	12	PT2742
10791440058443	12	B7167	10791440060491	6	PF7715	10791440063096	12	BT8502	10791440065342	12	PA4633	10791440067216	6	BT249-MPG
10791440058474	12	B1434	10791440060514	12	BF7717	10791440063102	12	B7216	10791440065359	12	BF7814	10791440067223	12	BT8908
10791440058504	12	BF7686	10791440060552	6	BT8801-MPG	10791440063119	6	B7217	10791440065380	12	B7238	10791440067230	12	BF7815
10791440058528	12	PF7687	10791440060620	6	PA3983-FN	10791440063164	6	BT8503-MPG	10791440065403	6	PA4159	10791440067308	6	BT8910-MPG
10791440058542	6	PA3929	10791440060644	12	PF7718	10791440063171	12	BT8504	10791440065427	12	PF7755	10791440067315	6	BT8911-MPG
10791440058559	6	B7180	10791440060651	12	B1441	10791440063201	12	BF7747	10791440065434	12	BF1339-SP	10791440067360	6	PA4681
10791440058566	6	BT8432-MPG	10791440060675	12	P1443	10791440063218	12	PF7748	10791440065441	6	PA4160	10791440067377	6	20005
10791440058573	12	BF7690	10791440060682	6	BD7310	10791440063225	12	PF7749	10791440065472	6	B7239	10791440067384	6	BD7250
10791440058665	6	BD7169	10791440060712	12	BF7711	10791440063270	12	BF7750	10791440065489	6	B10-AL SPS	10791440067391	6	BD7252
10791440058726	12	BF1266	10791440060736	12	B7181	10791440063287	12	BF1283	10791440065496	12	BT8240	10791440067407	12	PT8912
10791440058733	6	PA3931	10791440060750	6	BT8457-MPG	10791440063294	12	BF1281	10791440065502	12	PT8888	10791440067421	6	PA4682
10791440058740	12	B1438	10791440060842	6	B7182	10791440063347	12	B5089	10791440065533	6	PA4162	10791440067469	12	BF1353-SPS
10791440058757	12	B7170	10791440060859	12	B7189	10791440063461	6	PA4150	10791440065540	12	PF7767	10791440067483	6	PF7782
10791440058764	12	B7171	10791440060866	6	PA4134	10791440063539	12	PT8507-MPG	10791440065601	4	PT8889	10791440067490	12	BF7783-D
10791440058788	12	BF1267	10791440060880	12	PT8459	10791440063607	12	BT8509-MPG	10791440065670	12	B5090	10791440067506	12	BF7784-D
10791440058818	6	BT8437	10791440060927	6	PA3986	10791440063614	12	BT8505	10791440065687	6	B7241	10791440067513	12	BF7785-D
10791440058863	12	BF7691	10791440061061	4	P7183	10791440063676	12	BF7753	10791440065694	6	BT8890-MPG	10791440067537	12	BF7786-D
10791440058894	12	BF7693	10791440061085	12	BF7719	10791440063703	6	PA4600	10791440065748	6	BT8892-MPG	10791440067554	12	PA4685
10791440058917	12	B1435	10791440061108	12	BF7720	10791440063713	6	PA4601	10791440065762	6	20003	10791440067551	12	PA4852 FOAM
10791440058948	6	BD7309	10791440061122	6	PA4138	10791440063737	12	BF7756	10791440065793	6	20004	10791440067568	12	PA4853
10791440058993	12	P1440	10791440061139	12	BF7721	10791440063768	12	BT8519	10791440065854	12	66-30	10791440067575	6	PA4854
10791440059020	12	BF1268	10791440061160	12	BF7725	10791440063782	12	BF1275	10791440065861	6	PT8893	10791440067599	12	PA4855
10791440059037	12	BT8440-MPG	10791440061191	12	SA4141	10791440063836	12	PF7758	10791440065878	12	BF7768	10791440067636	12	PA4689
10791440059068	6	BT8439-MPG	10791440061238	12	PA4551	10791440063874	12	BT8220	10791440065885	6	PA4163	10791440067643	12	PA2068 FOAM
10791440059082	6	PA4120	10791440061245	12	PA4552	10791440063904	12	B7221	10791440066011	12	BF1346-SP	10791440067650	12	PA2223 FOAM
10791440059167	6	PA4118	10791440061269	12	B7174-MPG	10791440063911	12	B7222	10791440066059	12	BF1286	10791440067667	12	PA3901 FOAM
10791440059280	6	BF7695	10791440061375	6	PA4555	10791440063935	6	PA4612	10791440066080	6	PA4164	10791440067766	12	PA4694
10791440059297	6	BF1269	10791440061399	6	PA4557	10791440063966	12	BF7760	10791440066141	12	BF7769	10791440067773	12	PA4695
10791440059327	6	PA4121	10791440061405	12	BF7726	10791440063973	6	PT8461	10791440066165	12	PF7770	10791440067780	12	PA4696 FOAM
10791440059334	6	BF1277-SPS	10791440061412	12	PT8462-MPG	10791440064024	12	BF7759	10791440066223	12	BC7242	10791440067803	6	PA4698
10791440059372	6	BF1270-SP	10791440061436	12	PT8468	10791440064031	12	B7197	10791440066236	12	BT8898	10791440067841	6	PA4707
10791440059396	6	PA3941	10791440061467	12	PT8470	10791440064062	12	B5144	10791440066240	6	BT8899	10791440067889	4	PA4711
10791440059419	12	BC7173	10791440061474	12	P7185	10791440064079	12	BF1278	10791440066271	12	BF7771	10791440067919	6	PA4714
10791440059495	6	PA3953	10791440061498	12	BT8472	10791440064086	12	BF1279	10791440066295	12	BW5182	10791440067971	12	PA4720
10791440059501	12	BT8443	10791440061504	12	BT8473	10791440064154	12	BF7762	10791440066301	12	BT8900	10791440068008	2	PA4723
10791440059556	6	PA4123	10791440061511	12	BT8474	10791440064161	12	BT8223	10791440066363	12	B7243	10791440068046	12	PA4727
10791440059563	6	PA4124	10791440061528	12	BT8475	10791440064314	6	PA4151	10791440066387	12	BF7681-D	10791440068077	6	PA4730
10791440059570	6	BT8856-MPG	10791440061535	6	BT8476	10791440064437	6	B7224	10791440066394	12	BF7679-D	10791440068084	6	PA4731
10791440059617	12	BT8444	10791440061542	6	BT8477	10791440064475	12	B7225	10791440066400	12	BF7672-D	10791440068091	12	PA4732
10791440059631	6	BT8847	10791440061559	6	BT8463-MPG	10791440064482	12	BF7765	10791440066417	12	BF7682-D	10791440068107	6	PA4733
10791440059648	12	B7172	10791440061566	6	BT8464	10791440064499	6	PA4152	10791440066424	12	BF7675-D	10791440068114	6	PA4734
10791440059655	12	BF7683	10791440061573	6	BT8465	10791440064512	6	PA4154	10791440066431	12	BF7673-D	10791440068121	12	PA4735
10791440059662	12	BF7696	10791440061610	12	BC7186 KIT	10791440064550	6	19996	10791440066448	12	BF7674-D	10791440068138	12	PA4736 FOAM
10791440059730	6	BF1274-SP	10791440061658	12	B1444	10791440064581	6	19999	10791440066455	12	BF7677-D	10791440068145	6	PA4737
10791440059747	6	BF1274-SPS	10791440061733	6	B7187	10791440064598	6	20000	10791440066462	12	BF7746-D	10791440068152	6	PA4738
10791440059754	6	18055	10791440061856	12	PF7733	10791440064611	6	20002	10791440066479	12	BF7745-D	10791440068275	6	PA4750
10791440059761	6	18056	10791440061863	12	PF7734	10791440064628	12	B7227	10791440066486	12	BF7699-D	10791440068312	6	PA4754
10791440059778	6	18057	10791440061894	12	PT8484	10791440064642	12	BC7228	10791440066493	6	BT8901-MPG	10791440068329	10	PA4755
10791440059785	12	BT8445	10791440061924	12	PF7735	10791440064680	6	B7229	10791440066585	6	PA4701	10791440068336	6	PA4756
10791440059846	6	PA4126	10791440061948	12	P7188	10791440064765	12	PF7799	10791440066592	12	BF7772	10791440068350	12	PA4758
10791440059853	12	BF1271	10791440061962	6	PA4144	10791440064772	12	BF7800	10791440066646	12	BT8902	10791440068374	12	PA4760

I 2/5 TO BALDWIN CASE (SHIPPING CASES)

I 2/5 NUMBER	CASE QTY.	BALDWIN NUMBER	I 2/5 NUMBER	CASE QTY.	BALDWIN NUMBER	I 2/5 NUMBER	CASE QTY.	BALDWIN NUMBER	I 2/5 NUMBER	CASE QTY.	BALDWIN NUMBER	I 2/5 NUMBER	CASE QTY.	BALDWIN NUMBER
10791440069296	12	PF7787	10791440071923	12	B7274	10791440075914	12	PF7882	10791440077826	6	20010	10791440079509	12	BF1378-SPS
10791440069302	12	PF7788	10791440071930	12	B7275	10791440075921	12	BF7881	10791440077833	6	20011	10791440079523	6	PA5359
10791440069319	12	PF7816	10791440071947	12	B7276	10791440075952	12	PA4979	10791440077857	6	20012	10791440079530	12	PF7928
10791440069326	12	PF7817	10791440071954	12	B7277	10791440075982	12	PA4975	10791440077864	6	PA5327	10791440079615	12	BF1379
10791440069333	24	PF7818	10791440071985	12	B7280	10791440076119	12	PT9337-MPG	10791440077871	6	PA5328	10791440079622	12	BF1380
10791440069340	12	PF7819	10791440071992	12	B7281	10791440076263	12	BT7349	10791440077970	12	BF1360	10791440079639	12	BF1381
10791440069357	12	PF7820	10791440072012	12	B7283	10791440076287	12	BF7883	10791440077987	12	BF9191	10791440079646	12	PA4187
10791440069364	12	BF7821	10791440072036	12	B7285	10791440076294	12	BT3060	10791440077994	6	PA4175	10791440079653	12	BF1382-SP
10791440069371	30	PF7822	10791440072043	12	B7286	10791440076379	6	PA4985	10791440078007	6	PA4176	10791440079684	6	PF7930
10791440069388	12	PF7823	10791440072050	12	B7287	10791440076386	6	PA4986	10791440078045	12	BF1293-SPS	10791440079837	12	B7333
10791440069395	30	PF7824	10791440072074	12	B7289	10791440076393	6	PA4987	10791440078052	12	BF1272-SPS	10791440079844	12	BF7931
10791440069401	12	PF7825	10791440072081	12	B7290	10791440076416	6	BF1355-SP	10791440078069	6	20013	10791440079851	6	BF7932
10791440069418	12	PF7826	10791440072098	12	B7291	10791440076430	12	BF7886	10791440078106	6	BT9362-MPG	10791440079912	6	BT9387
10791440069425	6	PF7828	10791440072104	12	B7292	10791440076461	12	P7308	10791440078113	6	BT9363-MPG	10791440079943	12	B7397
10791440069449	12	PF7830	10791440072111	12	B7293	10791440076485	12	BF5587-D	10791440078120	6	PA4177	10791440079950	12	BT9388
10791440069463	12	PF7832	10791440072128	12	B7294	10791440076539	12	B7311-MPG	10791440078137	12	BF9192	10791440080048	6	B7335-MPG
10791440069470	12	PF7833	10791440072494	12	PF7852 KIT	10791440076546	6	P7312	10791440078151	6	BF7913	10791440080055	12	B7334
10791440069487	12	PF7834	10791440072500	6	PA4857	10791440076577	12	P7313	10791440078162	12	BF1352-SPS	10791440080062	6	BT9391-MPG
10791440069500	12	PF7836	10791440072531	6	BF7853	10791440076584	12	PT9342-MPG	10791440078188	12	BF1361	10791440080109	12	P7336 KIT
10791440069517	12	BF7837	10791440072609	6	PA4170	10791440076607	12	PF7889	10791440078397	6	BT9364	10791440080116	6	BT9392-MPG
10791440069524	12	BF7838	10791440072630	12	PA4878	10791440076614	12	PF7889-10	10791440078410	12	BF9195	10791440080123	6	BT9393-MPG
10791440069531	20	BF7839	10791440072647	12	PA4879	10791440076621	12	PF7889-30	10791440078427	6	BT9365-MPG	10791440080200	12	PF7934 KIT
10791440069548	12	BF7840	10791440072685	12	PA4883	10791440076638	12	PF7890	10791440078434	6	BT9366-MPG	10791440080215	12	PF7935
10791440069555	12	BF7841	10791440072708	4	PA4885	10791440076645	12	PF7890-10	10791440078441	6	PA5333	10791440080222	6	PA5393
10791440069562	12	BF7842	10791440072715	12	PA4886	10791440076652	12	PF7890-30	10791440078458	6	BT9367-MPG	10791440080246	12	BF1384-SP
10791440069579	12	BF7843	10791440072739	6	PA4888	10791440076669	6	BT9343-MPG	10791440078489	12	BF1283-SP	10791440080277	6	PA4188
10791440069586	12	BF7844	10791440072753	6	PA4890	10791440076720	12	BF7798-SP	10791440078496	12	BF1362	10791440080284	12	P7338
10791440069593	12	BF7845	10791440072760	12	PA4891	10791440076737	12	PT9344	10791440078502	6	BT9368-MPG	10791440080307	6	PA4190
10791440069616	12	BF7847	10791440072807	12	PA4895	10791440076744	6	B7314	10791440078519	6	BT9369-MPG	10791440080314	6	PA4191
10791440069623	12	BF7848	10791440072869	12	PA4902	10791440076751	12	BF1356	10791440078526	12	BC7326	10791440080338	12	PF7936
10791440069630	12	BF7849	10791440072890	12	PA4905	10791440076768	6	PA4172	10791440078532	12	PF7916	10791440080345	12	P7398
10791440069647	12	BF7850	10791440072906	6	PA4906	10791440076799	6	BT9345	10791440078557	12	BF7917	10791440080352	12	P7399
10791440069654	12	BF7851	10791440072913	12	PA4907	10791440076812	12	BT9346-MPG	10791440078564	12	B7327	10791440080369	12	P7400
10791440069661	12	BF7736-K1	10791440072920	12	PA4908	10791440076829	6	BT9347-MPG	10791440078571	6	BT9370-MPG	10791440080376	12	B7401
10791440069678	12	BT8913-MPG	10791440072944	6	PA4910	10791440076843	6	BT9349-MPG	10791440078601	6	BF1355	10791440080383	6	20014
10791440069685	6	BT8476-MPG	10791440072951	12	PA4911	10791440076850	6	BF1357	10791440078618	12	BF1363	10791440080390	12	BF7937
10791440069692	12	BT366-MPG	10791440073156	12	PA4931	10791440076867	12	BF7888	10791440078632	6	PA5337	10791440080406	6	PA4192
10791440069708	6	BT351-MPG	10791440073163	6	PA4932	10791440076874	12	BF1358-SP	10791440078656	12	B7328	10791440080413	6	PA4193
10791440069715	12	BT371-5	10791440073187	12	PA4934	10791440076881	12	BF7892	10791440078663	6	PA4178	10791440080420	6	PA4194
10791440069722	12	BT8914	10791440073194	12	PA4935	10791440076911	12	BT7316	10791440078670	6	PA4179	10791440080437	6	PA4195 KIT
10791440069746	12	BT8916	10791440073224	4	PA4938	10791440076966	12	BD7317	10791440078687	6	PA4180	10791440080444	6	PA4196
10791440069753	12	BT8917	10791440073231	12	PA4939	10791440077024	6	PF7894	10791440078694	6	PA4181	10791440080451	6	PA4197
10791440069760	12	BT8918	10791440073361	12	PA4872	10791440077031	6	PF7895	10791440078700	6	PA4182	10791440080468	6	PA4198
10791440069777	12	BT8919	10791440073378	12	PA4873	10791440077048	12	B7318	10791440078717	6	PA4183	10791440080475	6	PA4199
10791440069784	12	BT8920	10791440073385	12	PA4874	10791440077086	12	P7319	10791440078724	6	BT9371-MPG	10791440080482	6	PA4303
10791440069807	12	BT8922	10791440073415	12	PA3957 FOAM	10791440077093	12	PF7896	10791440078755	12	BF1365	10791440080499	6	PA4304
10791440069845	12	BT8926	10791440073422	12	PA2069 FOAM	10791440077130	6	PA5306	10791440078816	12	BF7919	10791440080505	6	PA4305
10791440069852	6	BT8927	10791440073439	12	PA2067 FOAM	10791440077154	12	BF7898-D	10791440078847	4	BA5374	10791440080512	6	PA4306
10791440069869	12	BT8928	10791440073545	6	BT8475-MPG	10791440077178	12	B7320	10791440078854	4	BA5375	10791440080529	6	PA4307
10791440069883	6	BT8930	10791440073552	6	BT8477-MPG	10791440077192	6	PA4174	10791440078861	4	BA5376	10791440080536	6	PA4308
10791440069890	6	BT8931	10791440073583	12	BT9321	10791440077321	6	B7322	10791440078878	6	PA5339	10791440080543	6	PA4309
10791440069897	12	BT8935	10791440073613	6	BT9324	10791440077338	12	PA5311	10791440078885	12	PT9374	10791440080550	12	SA4315
10791440069951	6	BT8937	10791440074023	12	PT9238	10791440077345	6	PA5312 KIT	10791440078908	12	BF7921	10791440080567	6	PA4310
10791440070643	12	PT9127	10791440074030	12	PT9239	10791440077369	6	PA5314	10791440078915	6	PA5341	10791440080574	6	PA4311
10791440070681	12	PT9131	10791440074245	12	PT9260	10791440077376	12	BF7903	10791440078939	4	PT9375	10791440080581	6	PA4312
10791440070711	12	PT9134	10791440074481	12	PF7869	10791440077383	12	BF7904-D	10791440078960	6	P7329	10791440080598	6	PA4313
10791440070728	12	PT9135	10791440074511	12	PF7872	10791440077390	6	B7396	10791440078991	12	BF1367	10791440080604	6	PA4314
10791440070735	12	PT9136	10791440074528	12	PF7873	10791440077406	6	BT9353-MPG	10791440079004	12	BF7922	10791440080611	6	B7402
10791440070797	12	PT9142	10791440074535	12	PF7874	10791440077413	12	BF7905-D	10791440079011	12	BF1370	10791440080628	12	B7403
10791440070803	12	PT9143	10791440074542	12	PF7875	10791440077420	12	BF7906-D	10791440079028	12	BW5183	10791440080635	6	PF7938
10791440070810	12	PT9144	10791440074559	12	PF7876	10791440077437	12	BF7907	10791440079035	12	BF1371	10791440080642	12	BF1354-SPS
10791440070841	12	PT9147	10791440074566	12	PF7877	10791440077468	12	PA5316	10791440079059	12	BF7923	10791440080659	6	PA4316
10791440071046	12	PT9167	10791440074573	12	BF7855	10791440077475	6	PA5317	10791440079066	6	P7330	10791440080666	6	PA4317
10791440071060	12	PT9169	10791440074597	12	BF7857	10791440077482	12	PT9354-MPG	10791440079097	6	PA4184	10791440080727	12	PT9394-MPG
10791440071114	12	PT9174	10791440074610	6	BF7859	10791440077499	6	PA5318	10791440079141	24	CTK5029-M	10791440080758	6	PA4319
10791440071176	12	PT9180	10791440074627											

I 2/5 TO BALDWIN CASE (SHIPPING CASES)

I 2/5 NUMBER	CASE QTY.	BALDWIN NUMBER	I 2/5 NUMBER	CASE QTY.	BALDWIN NUMBER	I 2/5 NUMBER	CASE QTY.	BALDWIN NUMBER	I 2/5 NUMBER	CASE QTY.	BALDWIN NUMBER	I 2/5 NUMBER	CASE QTY.	BALDWIN NUMBER
10791440081083	6	PA4327	10791440082264	6	PA4366	10791440083360	12	B7452	10791440086552	12	B7367	10791440088143	12	B7388
10791440081106	6	PA4325	10791440082271	12	B7430	10791440083483	12	B7453	10791440086569	12	PF1392	10791440088167	6	PA4436
10791440081151	12	BF7943	10791440082295	12	PT9405	10791440083513	6	PA4410 KIT	10791440086606	12	PF7994	10791440088174	6	PA4437
10791440081182	12	BF7408	10791440082301	12	B7431	10791440083537	12	OP8750	10791440086613	12	BF7995	10791440088181	12	PT9435-MPG
10791440081199	12	B7409	10791440082318	12	B7432	10791440083544	12	OP8751	10791440086620	12	PF7966	10791440088198	12	BF9830-D
10791440081205	12	B7410	10791440082325	12	B7433	10791440083551	12	OP8752	10791440086675	6	BF7996	10791440088211	12	BF9831
10791440081212	6	PA4329	10791440082332	6	PA4367	10791440083568	12	OP8753	10791440086682	6	PA4428	10791440088235	12	B7390
10791440081229	12	P7411	10791440082349	6	PA4368	10791440083575	6	PA4411	10791440086699	6	BT9421-MPG	10791440088259	12	B7393
10791440081250	12	BF1386-O	10791440082356	6	PA4369	10791440083582	12	P7454	10791440086705	6	20021	10791440088266	12	BF9833-D
10791440081267	12	BF7944	10791440082363	6	PA4370	10791440083599	6	PA4412	10791440086729	6	20023	10791440088273	12	BF9834
10791440081274	12	P7413	10791440082370	6	PA4371	10791440083605	6	PA4413	10791440086781	12	BF7997	10791440088280	12	BF9835-D
10791440081281	12	P7414	10791440082387	6	PA4372	10791440083629	6	PA4415	10791440086798	6	PA5494	10791440088297	6	P7505
10791440081342	12	BF1387-O	10791440082394	6	PA4373	10791440083667	12	P7455	10791440086804	6	PA5495	10791440088303	12	B7457
10791440081359	12	BF1388-O	10791440082400	12	BF7958	10791440083674	6	PA4416 KIT	10791440086811	6	BT9422	10791440088310	12	B7458
10791440081366	12	P7415	10791440082417	12	BF7959	10791440083681	12	BF7969	10791440086828	12	BF7998	10791440088327	12	B7459
10791440081373	6	PA4330	10791440082424	12	BF7960	10791440083698	12	PT9414-MPG	10791440086859	12	BF1289-SP	10791440088343	12	BF9836-D
10791440081380	6	PA4331	10791440082431	12	BF7961	10791440083759	12	BF7972	10791440086880	12	PT9423	10791440088440	6	PA4438
10791440081397	6	PA4332	10791440082448	12	B7434	10791440083766	12	P7438	10791440086927	12	B7370	10791440088464	12	BF1346-O
10791440081403	12	BF7945	10791440082455	6	PA4374	10791440083773	6	PA4417	10791440086965	12	PT9424	10791440088471	12	BF1348-O
10791440081410	6	B7416	10791440082486	6	PA4376	10791440083834	12	BC7456 KIT	10791440086996	12	BF9800	10791440088495	12	B7461
10791440081489	6	BT9398-MPG	10791440082493	6	PA4377	10791440083865	6	PA4418	10791440087009	12	PF9801	10791440088518	12	BF9837-D
10791440081496	6	PF7946	10791440082509	6	PA4380	10791440083872	6	PA4419	10791440087016	6	PT9425-MPG	10791440088624	12	BF9839-D
10791440081502	6	PA4334	10791440082516	6	PA4381	10791440083940	12	PT9417	10791440087023	6	PA4429	10791440088655	6	B10-AL BSPCS
10791440081519	6	PA4335	10791440082523	6	PA4382	10791440083957	12	B7449	10791440087030	12	PT9426	10791440088662	4	BA5566
10791440081564	12	BF1389-O	10791440082530	6	PA4383	10791440083971	12	PT9418	10791440087047	12	BF9802	10791440088679	12	BF1298-O
10791440081571	6	PA4333	10791440082547	6	PA4384	10791440084008	12	BF1397-SP	10791440087054	6	PA4430	10791440088686	12	B7466
10791440081588	6	PA4336	10791440082554	6	PA4385	10791440084015	12	B7350	10791440087061	12	BT7237	10791440088709	12	B7467
10791440081595	12	PF7947	10791440082561	6	PA4386	10791440084039	4	CV15000	10791440087085	12	PF9803	10791440088716	12	B7468
10791440081601	6	PA4337	10791440082578	6	PA4387	10791440084091	12	BF1399-SP	10791440087108	6	PT9427-MPG	10791440088723	12	B7469
10791440081618	12	P7418	10791440082585	12	BF7962	10791440084145	12	PT9419-MPG	10791440087122	12	BF1383-O	10791440088730	12	BF9841
10791440081632	6	BF7948	10791440082592	12	BF7963	10791440084152	6	PA4421	10791440087146	6	PF9804	10791440088808	12	BF9842
10791440081656	12	BF7949-D	10791440082608	12	BF7964-D	10791440084497	4	PT9453-MPG	10791440087177	12	BF9805	10791440088860	12	B7477
10791440081663	12	BF7950-D	10791440082639	12	BF7965	10791440084594	12	PT9454	10791440087184	12	B7372	10791440088907	12	BF9844
10791440081670	6	20015	10791440082646	6	PA4388	10791440085500	12	PF7974	10791440087214	12	BF1222-O	10791440088938	12	B7483
10791440081687	6	20016	10791440082677	6	PA4390	10791440085517	12	B7351-MPG	10791440087238	6	PA4431	10791440088958	12	BC7485
10791440081694	6	20017	10791440082714	6	P7436	10791440085531	12	PT9555	10791440087269	12	BF1345-O	10791440089096	12	BF9846
10791440081700	6	20018	10791440082721	12	P7437	10791440085586	12	PF7975	10791440087313	12	B7373	10791440089102	12	BF9847-D
10791440081724	6	20020	10791440082745	6	BF1392-SPS KIT	10791440085593	12	B7352	10791440087320	12	BF9807	10791440089119	12	BF1299-O
10791440081748	12	BF7951-D	10791440082752	12	BF7965	10791440085692	12	BF7976	10791440087337	12	BF9808-D	10791440089133	6	BT9436-MPG
10791440081755	12	BF7952-D	10791440082769	6	PA4391	10791440085715	4	BA5378	10791440087351	12	BF1223-O	10791440089140	12	B7486
10791440081779	12	BF7953-D	10791440082783	6	PA4392	10791440085722	4	BA5379	10791440087368	12	BF9809-D	10791440089157	12	B7487
10791440081786	12	B7419	10791440082790	6	PA4393	10791440085760	12	PF7978	10791440087375	12	BF9810-D	10791440089164	6	PA4439
10791440081793	6	PA4338	10791440082813	12	B7440	10791440085784	12	PA5457	10791440087382	12	B7375	10791440089171	6	PA4440 KIT
10791440081809	6	PA4340	10791440082820	12	BF7966	10791440085791	6	BD7355	10791440087399	12	B7376	10791440089188	6	PA4441
10791440081816	6	PA4341	10791440082837	12	B5091	10791440085814	6	BT9558-MPG	10791440087405	12	B7377	10791440089195	12	BF9848
10791440081823	6	PA4344	10791440082851	12	B7441	10791440085845	12	B7356	10791440087412	12	BF9811-SP	10791440089201	12	P7488
10791440081830	6	PA4345	10791440082868	6	PA4394	10791440085852	12	BF1366-O	10791440087429	12	B7378	10791440089218	12	P7489
10791440081847	6	PA4348	10791440082875	6	PA5428	10791440085869	12	BF7970	10791440087443	12	BF1292-O	10791440089232	12	BF9850
10791440081854	6	PA4349	10791440082891	12	BF7967	10791440085876	12	BF7979	10791440087450	12	BF1294-O	10791440089239	6	PA4442
10791440081861	6	PA4350	10791440082899	12	BF1393-SP	10791440085883	12	B7357	10791440087474	12	PT9430-MPG	10791440089300	6	PA4443
10791440081878	6	PA4351	10791440082974	6	PA4396	10791440085913	12	B7359	10791440087481	12	B7379	10791440089317	6	PA4444
10791440081885	6	PA4352	10791440082981	6	PA4397	10791440085982	6	PA4422	10791440087504	12	BF9812	10791440089324	12	BF9851
10791440081908	12	BF7955	10791440082998	6	PA4398	10791440085999	6	PA4423	10791440087511	12	BF9813	10791440089331	12	P7490
10791440081915	12	B7420	10791440083001	6	PA4399	10791440086002	12	BF7981	10791440087528	12	PF9814	10791440089348	12	B7491
10791440081922	12	B7422	10791440083018	6	PA4400	10791440086064	6	BT9560-MPG	10791440087535	12	B7383	10791440089355	12	BF9852
10791440081939	12	BF7956-D	10791440083025	12	P7442	10791440086071	12	PF7983	10791440087542	12	B7384	10791440089423	6	PA4446
10791440081946	12	P7423	10791440083049	12	BF1394-SP	10791440086088	12	PF7984	10791440087559	12	B7385	10791440089430	6	PA4447
10791440081984	12	P7417	10791440083087	12	BF1395-SP	10791440086101	12	BF7985	10791440087566	12	B7386	10791440089447	6	PA4448
10791440081991	6	PA4353	10791440083094	6	PA4401	10791440086132	12	B7360	10791440087573	12	B7387	10791440089485	12	BF9857
10791440082004	6	PA4354	10791440083100	6	PA4402	10791440086149	6	PA4424	10791440087580	12	BF9815	10791440089713	6	BT9439
10791440082011	6	PA4355	10791440083131	6	PA4403	10791440086156	12	BF7637	10791440087603	12	BF9816	10791440089715	6	PA4449
10791440082028	6	PA4356	10791440083148	6	PA4404	10791440086187	12	B7361	10791440087610	12	BF1296-O	10791440089768	6	PA5580
10791440082042	6	PA4358	10791440083155	6	PA4405	10791440086194	12	BT9561	10791440087627	12	BF1297-O	10791440089850	12	CV15001
10791440082059	6	PA4359	10791440083186	6	PA4408	10791440086200	12	PF7986	10791440087634	12	BF9817	10791440089867	12	P7492
10791440082066	6	PA4360	10791440083209	12	B7443	10791440086217	12	PF7982	10791440087641	12	BF9818	10791440089904	6	PA4452
10791440082073	6	PA4361	10791440083216	12	B7444	10791440086231	12	B7362	10791440087665	12	BF9820	1		

I 2/5 TO BALDWIN CASE (SHIPPING CASES)

I 2/5 NUMBER	CASE QTY.	BALDWIN NUMBER	I 2/5 NUMBER	CASE QTY.	BALDWIN NUMBER	I 2/5 NUMBER	CASE QTY.	BALDWIN NUMBER	I 2/5 NUMBER	CASE QTY.	BALDWIN NUMBER	I 2/5 NUMBER	CASE QTY.	BALDWIN NUMBER
10791440090184	12	BF9863	10791440092096	12	BF9893	10791440094458	6	PA5770	10791440097558	12	BF46012	10791440103600	12	PA40021
10791440090207	6	PA5619	10791440092102	12	BF9894	10791440094472	6	PA5772	10791440097565	12	BF46013	10791440103617	6	PA10023
10791440090214	6	PA5620	10791440092119	6	B7503	10791440094489	6	PA5773	10791440097572	12	BF46014	10791440103624	6	PA10024
10791440090238	6	PA5622	10791440092188	6	PA5689	10791440094496	12	PF9919	10791440097589	12	BF46015	10791440103631	6	PA10025
10791440090245	6	PA5623	10791440092195	6	PA5690	10791440094502	6	PA5774	10791440097596	12	BF5813-O	10791440103648	6	PA10026
10791440090252	6	PA5624	10791440092201	6	PA5691	10791440094526	12	BF1282-O	10791440097602	12	BF1204-O	10791440103655	6	PA10027
10791440090269	6	BF9864	10791440092232	6	PA5694	10791440094536	6	PA4483	10791440097619	12	BF791-O	10791440103662	6	PA10028
10791440090283	12	PF9865	10791440092270	6	BD7504	10791440094564	12	B9601	10791440097626	12	BF7968-O	10791440103668	6	PA10030
10791440090306	6	PA4464	10791440092287	12	B7506	10791440094601	6	BF9920	10791440097633	12	BF46016-O	10791440103693	6	PA10031
10791440090337	6	PA5629	10791440092294	6	PA4470	10791440094663	6	PA4484	10791440097640	12	BF46017-O	10791440103709	6	PA10032
10791440090351	6	PA5631	10791440092300	6	BF9895 KIT	10791440094694	12	BF9921-O	10791440097657	12	BF46018-O	10791440103716	12	PA40023
10791440090375	12	BT9440	10791440092317	6	PA4471	10791440094700	6	PA4485	10791440097664	12	BF46019-O	10791440103723	12	PA40024
10791440090382	6	BF9866-O	10791440092324	6	PA5698	10791440094755	12	BF9922-O	10791440097671	12	BF46020-O	10791440103730	12	PA40025
10791440090399	6	PA5632	10791440092355	12	PF9897	10791440094809	6	PA4997	10791440097688	12	BF46021-O	10791440103846	12	BF46045-D
10791440090429	6	PA4465	10791440092379	12	BF9898-O	10791440094922	12	PE5272	10791440097695	12	BF46022-O	10791440103921	6	PA10033
10791440090443	12	BF9867-O	10791440092386	12	PF9899	10791440094953	12	BF9923-O	10791440097701	12	BF46023-O	10791440103945	6	PA30126
10791440090467	12	BF1355-O	10791440092409	6	B7507	10791440094991	12	PA5276	10791440097718	12	BF46024-O	10791440103969	12	PF46046
10791440090474	6	PA5633	10791440092416	12	BC7394	10791440095004	12	P9602	10791440097725	12	BF46025-O	10791440104034	12	BF46048
10791440090504	12	PF9868	10791440092423	12	PA5700	10791440095011	12	P9603	10791440097732	12	BF46026-O	10791440104041	12	PA40017
10791440090528	12	BF1395-O	10791440092430	12	PF9901 KIT	10791440095028	12	PT9537-MPG	10791440097749	12	BF46027-O	10791440104133	12	PA30138
10791440090535	12	BF7496	10791440092447	6	PA4473	10791440095080	6	PA5282	10791440097756	12	BF46028-O	10791440104140	12	PA30139
10791440090641	12	BF9869	10791440092522	12	BF9903-SP	10791440095103	4	BA5284	10791440097763	12	BF46029-O	10791440104157	6	PA30140
10791440090665	6	PT9441-MPG	10791440092546	12	B7395	10791440095110	6	PA4486	10791440097770	12	BF46030-O	10791440104163	6	PA30141
10791440090689	12	PF9870	10791440092577	12	BF9904	10791440095127	12	BF1278-O	10791440097787	12	PT23136	10791440104171	6	PA30144
10791440090696	6	PA5637	10791440092584	6	P7508	10791440095134	6	PA4487	10791440097794	12	PT23122	10791440104300	12	BF46050
10791440090702	6	PA5638	10791440092669	12	PT9469	10791440095172	6	PF9924 KIT	10791440097817	12	PT23123	10791440104331	12	PT23536
10791440090795	12	BF9871-O	10791440092676	12	PT9470	10791440095196	12	BF9925-O	10791440097824	6	PT23137	10791440104348	12	BF46051
10791440090855	12	PF9872	10791440092683	6	BD7509	10791440095271	12	BF9927	10791440097831	12	PT23124	10791440104379	6	PA10036
10791440090962	12	B7497	10791440092744	12	BF9905	10791440096506	12	B9604	10791440097848	12	PT23125-MPG	10791440104386	6	PA30151
10791440090993	12	PF9873	10791440092805	12	BT9471	10791440096575	12	P9605	10791440097855	12	PT23126-MPG	10791440104433	12	BF46052
10791440091013	6	PA4466	10791440092812	6	B9606	10791440096612	12	B9606	10791440097862	12	PT23127-MPG	10791440104492	12	PA30153
10791440091020	12	BT9442-MPG	10791440092836	6	PA5722	10791440096629	12	B9607	10791440097879	12	PT23128-MPG	10791440104453	6	PA30154
10791440091037	12	BF9874-DM	10791440092843	6	PA5723	10791440096636	12	PF9928	10791440097886	12	PT23129-MPG	10791440104485	12	PA30157
10791440091044	12	BF9875-DI	10791440092850	6	PA4475	10791440096643	12	PF9929	10791440097916	12	PT23132-MPG	10791440104492	12	PF46112
10791440091068	6	PT9444-MPG	10791440092881	6	PA5725	10791440096644	6	PA10000	10791440097954	12	PA40002	10791440104508	6	PA10037
10791440091075	12	BF9876	10791440092898	12	BF9906	10791440096681	6	PA10001	10791440097961	12	B40006	10791440104546	12	PF46049
10791440091167	12	PT9446	10791440092911	6	PA5727	10791440096698	6	PA10002	10791440097986	12	C40005	10791440104553	6	BD40027
10791440091174	12	PT9447	10791440092928	6	PA5728	10791440096704	12	BF46000	10791440097992	6	PA10008	10791440104562	6	BF1360-O
10791440091181	12	PT9448	10791440092935	6	PA5728 FOAM	10791440096711	12	BF46001	10791440098029	12	BC40007	10791440104669	6	BF1347-O
10791440091198	12	PT9449	10791440092959	6	PA5729	10791440096728	12	B40000	10791440098050	12	BF46031	10791440104690	6	CV15005
10791440091204	12	PT9450-MPG	10791440092980	6	PA5732	10791440096735	12	PA40001	10791440098074	6	PA40008	10791440104706	12	PF46056
10791440091310	12	BF1358-O	10791440092997	12	PF9907	10791440096803	6	PA30007	10791440098081	6	BC40009	10791440104716	12	PF46057
10791440091389	12	BF9877	10791440093154	6	PA5733	10791440096810	6	PA10003	10791440098098	12	PA40010	10791440104737	12	PF46059
10791440091419	6	PA5658	10791440093208	12	BF9910	10791440096841	12	PF46003	10791440098104	12	BF46032	10791440104751	6	BF46061
10791440091440	6	PA5661	10791440093239	12	P7510	10791440096858	12	PF46004	10791440098173	6	PA30072	10791440104775	6	BF46062
10791440091457	6	PA5662	10791440093246	12	PF9911	10791440096865	6	PA10004	10791440098203	12	PF46033	10791440104782	6	BT23543-MPG
10791440091495	6	PA5666	10791440093260	12	B7511	10791440096896	12	BF46005	10791440098234	12	PA40011	10791440104799	12	PT23544-MPG
10791440091525	6	PA4468	10791440093291	6	PA5738	10791440096902	6	PA10006	10791440098241	12	PA40012	10791440104836	12	BF63000
10791440091532	6	PA4469	10791440093420	12	BF1249-O	10791440096919	12	PA40003	10791440098298	12	BF45000	10791440104973	6	RS30142
10791440091549	12	P5092	10791440093468	12	S9475	10791440096926	6	PA10007	10791440098326	12	PA40014	10791440105024	12	BT40028
10791440091566	12	BF9878	10791440093475	12	BF9912-O	10791440096957	6	PA30011	10791440098444	6	PA10011	10791440105031	12	PA40030
10791440091563	6	PA5669	10791440093482	6	PT9476-MPG	10791440096960	12	OAS98000	10791440098975	12	BF46034	10791440105048	6	PA30174
10791440091686	12	B7499	10791440093499	12	BF1281-O	10791440096964	6	PA30012	10791440100593	6	PA30080	10791440105079	6	PA40031-MPG
10791440091709	12	BT9456	10791440093505	12	BF9913	10791440096988	12	PA30014	10791440100616	6	PA10014	10791440105086	6	PA30177
10791440091747	6	PA5679	10791440093512	12	BF1283-O	10791440097008	12	PA30016	10791440100760	12	BT40015	10791440105093	6	BD50000
10791440091754	6	PF9879	10791440093529	6	PA5753	10791440097015	12	PA30017	10791440100777	6	PA30086	10791440105123	6	PA30179
10791440091761	12	BF9880	10791440093567	12	CV15003	10791440097022	12	PA30018	10791440100784	6	PA10015	10791440105185	12	BF46068
10791440091808	12	BF9881	10791440093574	6	PF9914 KIT	10791440097039	12	PA30019	10791440100845	6	20025	10791440105192	12	BF46069
10791440091822	12	PT9462	10791440093581	12	BF9915	10791440097060	12	PA30022	10791440100876	6	BF46036 KIT	10791440105215	12	BT40029
10791440091846	12	BT9464	10791440093659	12	BF9916	10791440097084	12	PA30024	10791440100883	6	PA30093	10791440105222	6	BT23555-MPG
10791440091853	12	PT9463	10791440093666	6	PA4476	10791440097138	12	PA30029	10791440100890	6	PA10016	10791440105239	12	BF46071
10791440091860	12	BF9883	10791440093673	6	PA4477	10791440097145	6	PA30030	10791440100906	6	PA10017	10791440105246	12	BF46072
10791440091884	12	B7501	10791440093680	6	PA4478	10791440097152	12	PA30031	10791440100920	12	BF46037	10791440105284	12	BT40032
10791440091891	12	PE5270	10791440093697	6	PA4479	10791440097190	12	PA30034	10791440100982	12	BF46038-D	10791440105291	12	BF46073
10791440091907	12	PE5271	10791440093703	6	PA4480	10791440097206	12	PA30035	1					

I 2/5 TO BALDWIN CASE (SHIPPING CASES)

I 2/5 NUMBER	CASE QTY.	BALDWIN NUMBER	I 2/5 NUMBER	CASE QTY.	BALDWIN NUMBER	I 2/5 NUMBER	CASE QTY.	BALDWIN NUMBER	I 2/5 NUMBER	CASE QTY.	BALDWIN NUMBER	I 2/5 NUMBER	CASE QTY.	BALDWIN NUMBER
10791440105680	6	PA10043	10791440109039	6	PA10069	10791440110578	12	B40073	10791440111865	6	PA10137	10791440112749	6	PA10269
10791440105697	12	P40035	10791440109046	6	PA10070	10791440110653	12	BF46169-O	10791440111872	12	BF46217	10791440112756	6	PA10152 KIT
10791440105703	12	B40036	10791440109053	6	PA10071	10791440110660	12	BF46170	10791440111889	6	PA10267	10791440112763	6	PA10293
10791440105710	12	PF46077	10791440109060	6	PA10072	10791440110677	6	BT23619-MPG	10791440111896	6	PA10283	10791440112770	6	20067
10791440105727	6	PA30152	10791440109077	6	PA10073	10791440110684	6	PA10097	10791440111902	12	FB46183	10791440112787	6	PA10227
10791440105741	6	PA10044	10791440109152	12	PF46130	10791440110707	6	PA10098	10791440111926	6	PA10197	10791440112800	12	P40090
10791440105758	6	PA10045	10791440109190	6	BF46131	10791440110714	6	PA10099	10791440111933	6	PA10281	10791440112817	6	PA10309
10791440105765	6	PA10046	10791440109220	6	BF46134-O	10791440110745	6	PF46171	10791440111940	12	PA0102	10791440112824	12	20063
10791440105772	12	P40037	10791440109282	6	PA10075	10791440110776	6	20030	10791440111957	6	PA10380	10791440112848	6	PA10199 KIT
10791440105789	12	BT40038	10791440109299	6	PF46135	10791440110783	6	PA30287	10791440111964	6	PA10228	10791440112855	6	PA10324
10791440105796	12	BF46078-D	10791440109305	6	PA10076	10791440110790	12	SA10100	10791440111971	12	PA0109	10791440112879	6	PA10134
10791440105833	6	PF46080	10791440109336	6	PA10077	10791440110813	12	BF1380-O	10791440111988	6	PA10285	10791440112886	6	PA10352
10791440105840	12	PF46081	10791440109343	6	PA10078	10791440110875	6	BF46064-D	10791440111995	6	PA10132	10791440112893	12	BF46195
10791440105857	12	PF46082	10791440109374	6	BT40066-MPG	10791440110882	6	PF46172 KIT	10791440112008	6	PA10292	10791440112916	6	PA10149
10791440106755	6	BF46083-O	10791440109381	6	BT40067-MPG	10791440110899	6	BF46173-O	10791440112022	6	PA10181	10791440112923	6	PA10325
10791440106793	12	PT23561-MPG	10791440109398	12	PF46137	10791440110912	6	PA10101	10791440112039	12	PA0099	10791440112930	6	PA10139
10791440106878	12	BF46084	10791440109411	12	PF46138	10791440110929	6	PA10102	10791440112046	6	PA10277	10791440112947	12	OB40078
10791440106915	12	PE17001	10791440109527	6	PA10081	10791440110943	6	P40074	10791440112053	12	OB40079	10791440112961	6	PA10229
10791440107189	12	BF46085	10791440109534	12	BF1381-O	10791440110981	12	BF46175	10791440112060	6	PA10378	10791440112978	6	PA101375
10791440107202	6	P40042	10791440109541	6	PA30260	10791440110998	6	PA10103	10791440112077	12	PA0106	10791440112985	6	20058
10791440107288	12	PF46087	10791440109558	6	PA30261	10791440111001	6	PA10104	10791440112084	6	PA10143	10791440112992	6	PA10231
10791440107295	6	PA10047	10791440109565	6	PA30262	10791440111025	6	PA10106	10791440112091	6	PA10288	10791440113005	6	PA10389
10791440107301	6	PT23592	10791440109572	12	BT23617	10791440111032	6	PA10107	10791440112107	6	20052	10791440113012	6	PA10148
10791440107318	12	PF46088	10791440109589	12	BF46141	10791440111056	12	P40076	10791440112114	12	PA0108	10791440113029	6	PA10201
10791440107356	6	PF46091	10791440109596	6	PA10082	10791440111148	6	PA30299	10791440112121	12	SA10127	10791440113036	6	PA10235
10791440107363	6	BF46098-O	10791440109602	12	BF46122	10791440111155	6	PA10108	10791440112138	6	PA10320	10791440113043	6	PA10131
10791440107370	6	BF46100-O	10791440109619	6	PF46142	10791440111162	12	BF46176	10791440112145	6	PA10224	10791440113050	6	PA10256
10791440107387	6	BF46099-O	10791440109626	12	BF46143	10791440111193	6	BF46179	10791440112152	6	PA10395	10791440113067	6	PA10146
10791440107394	6	PF46094	10791440109633	6	PA10084	10791440111223	12	BF1379-O	10791440112169	6	PA10376	10791440113074	6	PA10316
10791440107400	6	BF46101-O	10791440109657	6	PA10085	10791440111247	12	BT23628	10791440112176	6	PA10284	10791440113081	12	SA10361
10791440107455	12	B40050	10791440109671	12	CV15010	10791440111254	6	BF46181-O	10791440112183	6	PA10223	10791440113098	12	B40128
10791440107462	12	B40051	10791440109695	6	PA0069	10791440111261	12	BT23629	10791440112190	6	PA10195 KIT	10791440113104	6	PA10385
10791440107684	12	PA0052	10791440109725	6	PF46145	10791440111322	6	PA10063	10791440112206	6	PA10217	10791440113111	12	BF46216
10791440107707	12	PF46103	10791440109749	12	B40070	10791440111339	6	PA30249	10791440112213	6	PA10145 KIT	10791440113128	12	BF46224
10791440107738	6	B40053	10791440109770	12	S40071	10791440111353	12	BF46182-O	10791440112237	6	PA10390	10791440113135	6	PA10241
10791440107745	12	B40054	10791440109787	12	BF46147-O	10791440111360	6	PA30304	10791440112244	6	PA10232	10791440113142	6	PA10354
10791440107769	6	BT23603-MPG	10791440109848	12	BF46149-SP	10791440111407	12	PA0105	10791440112251	12	PA0116	10791440113159	12	BF46205
10791440107776	12	PT23597-MPG	10791440109862	12	RS30273	10791440111414	6	20048	10791440112268	6	PA10142	10791440113166	6	PA10303
10791440107783	12	BT23604	10791440109879	12	RS30274	10791440111421	6	PA10128	10791440112275	6	PA10286	10791440113173	12	B40127
10791440107813	6	BT23605-MPG	10791440109886	6	PA10088	10791440111438	12	PA0104	10791440112282	12	B40126	10791440113180	6	PA10238
10791440107844	12	B40056	10791440109893	6	BF46150-O	10791440111445	6	PA10362	10791440112299	12	PA0110	10791440113197	12	PA0086
10791440107875	6	BT23607-MPG	10791440109909	6	PA10089	10791440111452	12	BT23631	10791440112312	6	PA10282	10791440113203	6	PA10373
10791440107882	6	PA10057	10791440109916	6	PA10090	10791440111469	6	PA10363	10791440112329	6	20045	10791440113210	6	PA10368
10791440107943	1	RS30212	10791440109947	6	PA30276	10791440111476	12	PA0113	10791440112343	6	PA10346	10791440113227	12	PA0081
10791440107950	1	RS30213	10791440109954	12	PF46151	10791440111483	6	PA10364	10791440112350	6	PA10310	10791440113241	6	PA10144
10791440108117	6	BF46104	10791440109961	6	PA30270	10791440111490	12	PA0100	10791440112367	6	PA10233	10791440113258	6	PA10297
10791440108131	6	BF46105-O	10791440109978	12	PA30269	10791440111506	12	PA0119	10791440112374	6	PA10136	10791440113265	6	PA10358
10791440108148	6	PF46106	10791440109985	6	PA10083	10791440111513	6	PA10278	10791440112381	6	PA10159	10791440113272	12	PF46189
10791440108162	6	PF46108	10791440109992	6	PA10091	10791440111520	12	PA0094	10791440112398	12	BF46209	10791440113289	6	PA10141
10791440108186	6	BF46109-O	10791440110028	6	PA30277	10791440111537	6	PA10221	10791440112404	6	PA10219	10791440113296	6	PA10230
10791440108223	12	PA0058	10791440110035	6	20028	10791440111544	6	PA10220	10791440112411	6	20037	10791440113302	6	PA10234
10791440108254	12	BF46111	10791440110066	6	PA10093	10791440111551	6	PA10129	10791440112435	6	PA10289	10791440113319	12	BF46193
10791440108315	12	BF46113-D	10791440110073	6	PA10094	10791440111568	12	PA0103	10791440112442	6	PA10296	10791440113326	6	PA10305
10791440108353	6	PA10058	10791440110080	6	PA10095	10791440111575	12	PA0111	10791440112459	12	PA0115	10791440113333	6	PA10312
10791440108360	6	PA10059	10791440110103	6	PA30255	10791440111582	12	PA0107	10791440112473	6	PA10294	10791440113340	6	PA10307
10791440108452	6	PA10060	10791440110110	6	20026	10791440111599	12	PA0114	10791440112480	6	PA10392	10791440113357	6	PA10264
10791440108469	6	BF46117	10791440110127	6	20027	10791440111605	12	BF46194	10791440112497	6	BF955 KIT	10791440113364	6	20035
10791440108476	12	PF46118	10791440110158	6	PA30279	10791440111612	12	PA10130	10791440112503	6	PA10135	10791440113371	6	PA10308
10791440108483	12	PF46119	10791440110165	12	BF46156	10791440111629	12	BT23630	10791440112510	12	BF46215	10791440113388	6	PA10138
10791440108490	6	PF46092	10791440110172	12	BF46157	10791440111636	6	PA10133	10791440112527	6	PA10365 KIT	10791440113395	12	20031
10791440108506	12	BT23611	10791440110189	12	BF46158	10791440111643	6	PA10391	10791440112534	6	PA10355	10791440113401	6	PA10209 KIT
10791440108575	12	PA0061	10791440110196	12	BF46159	10791440111650	6	PA10367	10791440112541	6	PA10383	10791440113418	6	20053
10791440108582	6	BF46116 KIT	10791440110219	12	BF46161	10791440111674	12	PA0112	10791440112558	6	PA10304	10791440113425	12	BF46225
10791440108605	12	PA30204	10791440110301	6	PA10086	10791440111681	6	20054	10791440112565	6	PA10113	10791440113432	6	PA10147
10791440108629	6	PA10062	10791440110318	6	PA10080	10791440111704	6	PA1						

I 2/5 TO BALDWIN CASE (SHIPPING CASES)

I 2/5 NUMBER	CASE QTY.	BALDWIN NUMBER	I 2/5 NUMBER	CASE QTY.	BALDWIN NUMBER	I 2/5 NUMBER	CASE QTY.	BALDWIN NUMBER	I 2/5 NUMBER	CASE QTY.	BALDWIN NUMBER	I 2/5 NUMBER	CASE QTY.	BALDWIN NUMBER
10791440113623	6	20064	10791440114149	6	PA10345	10791440114774	6	PA10189	10791440115399	6	PA10333	10791440116365	12	PE17002 KIT
10791440113630	6	PA10306	10791440114156	6	PA10326	10791440114781	12	P40131	10791440115405	6	PA10334	10791440116372	6	PA30331
10791440113647	6	PA10140	10791440114170	12	P40118	10791440114798	6	PA10258	10791440115412	6	PA10330	10791440116389	6	PA10413
10791440113654	6	PA10240	10791440114187	12	BF46219	10791440114804	12	BF46220	10791440115429	6	PA10340	10791440116396	6	PA30332
10791440113661	6	PA30301	10791440114194	12	BF46198	10791440114811	6	PA10319	10791440115436	6	20057	10791440116402	12	PF46152
10791440113678	6	PA10393	10791440114200	6	PA10394	10791440114828	6	PA10210 KIT	10791440115450	6	PA10174	10791440116419	6	PA10414
10791440113685	12	BF46203	10791440114217	6	PA10114	10791440114835	6	PA10188	10791440115467	6	PA10247	10791440116426	12	P40143
10791440113692	6	PA10254	10791440114224	6	PA10196 KIT	10791440114842	6	PA10165	10791440115474	6	PA10177	10791440116433	6	PA10415
10791440113708	6	PA10194	10791440114231	12	PA30302	10791440114859	6	PA10211 KIT	10791440115481	6	PA10212 KIT	10791440116440	6	PA10416
10791440113715	12	BF46208	10791440114248	6	20066	10791440114866	6	PT23633	10791440115498	6	PA10342	10791440116457	6	PA10417
10791440113722	6	PA10160	10791440114255	6	PA10341	10791440114873	6	PA10214	10791440115504	6	PA10381	10791440116488	6	CV15015
10791440113739	6	PA10273	10791440114262	6	20041	10791440114897	6	PA10357	10791440115511	6	PA10400	10791440116495	12	PF46241
10791440113746	12	BF46210	10791440114286	6	PA10271	10791440114903	12	BF46204	10791440115566	12	BF46227	10791440116501	6	PA10418
10791440113753	6	20061	10791440114330	6	PA10265	10791440114910	6	PA10344	10791440115573	12	B40133	10791440116518	6	PA10419
10791440113760	6	20062	10791440114354	6	PA10155	10791440114927	6	PA10190	10791440115597	6	PA10401	10791440116525	6	PA10420
10791440113777	6	PA10218	10791440114392	6	PA10207	10791440114934	6	PA10244	10791440115603	12	P40134	10791440116532	12	BF46242
10791440113784	12	P40130	10791440114378	6	PA10208 KIT	10791440114958	6	PA30303	10791440115610	6	PA10402	10791440116549	6	PA10421
10791440113791	6	20044	10791440114385	12	P40101	10791440114965	6	PA10321	10791440115672	6	PT23637-MPG	10791440116556	6	PA10422
10791440113807	6	PA10397	10791440114439	6	PA10200	10791440114989	12	BF46196	10791440115689	6	PA10403	10791440116563	6	PA10423
10791440113814	6	PA10386	10791440114408	6	PA10263	10791440114996	6	PA10167	10791440115696	12	B40136	10791440116631	6	PA10424
10791440113821	6	PA10154	10791440114415	6	PA10245	10791440115009	6	PA10169	10791440115702	6	PA30310	10791440116648	6	BF46244
10791440113838	6	PA10315	10791440114439	12	P40098	10791440115016	6	PA10182	10791440115719	6	B40137	10791440116662	6	PA10425
10791440113845	6	PA10399	10791440114446	12	BF46223	10791440115030	12	BF46199	10791440115726	6	B40138	10791440116679	12	CV15016
10791440113852	6	PA10186 KIT	10791440114453	12	BF46200	10791440115047	12	BF46220	10791440115733	12	BF46228	10791440116686	6	B40145
10791440113869	6	20060	10791440114460	6	PA10370 KIT	10791440115078	6	PA10251	10791440115870	12	BF46229	10791440116693	6	BF46248
10791440113876	6	PA10249	10791440114477	6	PA10242	10791440115085	6	PA10206 KIT	10791440115887	12	BF46230	10791440116785	6	PA30333
10791440113883	6	PA10372	10791440114484	6	PA10250	10791440115092	6	PA10253	10791440115894	6	PA30324	10791440116808	6	PA10426
10791440113890	6	PA10317	10791440114491	6	PA10156	10791440115108	6	PA10260	10791440115900	6	PA30325	10791440116846	12	PF46250
10791440113906	6	PA10382	10791440114507	6	PA10331	10791440115122	6	PA10180 KIT	10791440115917	6	PA10404	10791440116853	6	PA10427
10791440113913	6	20065	10791440114521	12	BF46201	10791440115139	6	PA10337	10791440115962	6	BD40139	10791440116860	6	PA10428
10791440113920	6	PA10193 KIT	10791440114538	6	PA10162	10791440115146	12	BF46197	10791440115979	6	PA10388	10791440116877	6	SA10429
10791440113937	6	PA10314	10791440114552	6	PA10327	10791440115153	6	PA10398	10791440115986	6	PA10396	10791440116884	6	PA10430
10791440113944	12	BF46211	10791440114569	6	20046	10791440115160	6	PA10353	10791440115993	6	PA10406	10791440116891	6	PA10431
10791440113951	12	BF46221	10791440114583	6	20050	10791440115177	6	PA10185	10791440116044	12	BF46233	10791440116921	12	B40150
10791440113975	12	BF46206	10791440114590	6	PA10329	10791440115184	12	P40085	10791440116051	6	PA30329	10791440116938	6	BF46251-SP
10791440113982	6	PA10213	10791440114606	6	PA10323	10791440115191	6	PA10328	10791440116068	12	BF46234	10791440116945	6	BF46252-SP
10791440113999	6	PA10166	10791440114613	6	PA10318	10791440115214	6	PA10215 KIT	10791440116075	6	PA10407	10791440116952	6	BF46256
10791440114002	6	PA10150	10791440114620	12	P40117	10791440115221	6	20068	10791440116082	6	PA30330	10791440116990	6	20071
10791440114019	6	PA10172	10791440114637	6	PA10384	10791440115245	12	PF46188	10791440116099	6	20070	10791440117003	6	20072
10791440114033	6	PA10163	10791440114644	6	PA10343	10791440115252	6	PA10157	10791440116105	12	PF46235	10791440117065	12	PF46258
10791440114040	6	PA10255	10791440114651	12	SA10360	10791440115269	6	PA10173	10791440116112	6	PF46236	10791440117119	6	PA10433
10791440114057	12	PF46187	10791440114675	6	PA10266	10791440115276	6	PA10261	10791440116129	6	PF46237	10791440117133	6	PA10435
10791440114064	6	20051	10791440114682	12	P40132	10791440115283	12	BF46222	10791440116136	12	PF46238	10791440117140	6	PA10436
10791440114071	6	20069	10791440114699	6	PA10183	10791440115290	6	PA10158	10791440116143	6	PA10408	10791440117164	6	PA10438
10791440114088	6	PA10202	10791440114705	6	PA10259	10791440115320	12	PF46186	10791440116150	6	PA10409	10791440117171	6	PA10439
10791440114095	6	PA10356	10791440114712	12	B40125	10791440115337	6	PA10178	10791440116168	12	B40140	10791440117188	6	PA10440
10791440114101	12	P40091	10791440114729	6	PA10203 KIT	10791440115344	6	PA10332	10791440116310	6	PA10410	10791440117195	12	PF46259
10791440114118	6	PA10216 KIT	10791440114736	12	P40096	10791440115351	12	B40121	10791440116327	6	PA10411	10791440117218	6	PA10441
10791440114125	6	PA10335	10791440114750	6	PA10170 KIT	10791440115375	6	PA10175 KIT	10791440116334	6	PA10412	10791440117317	12	P40156
10791440114132	6	20055	10791440114767	12	BF46192	10791440115382	6	PA10176	10791440116358	6	B40142			

NOTES

BALDWIN WEIGHTS AND VOLUMES

BALDWIN NUMBER	CASE QTY.	WEIGHT (ea.) lbs.	WEIGHT (ea.) kgs.	Volume (ea.) ft ³	Volume (ea.) m ³	BALDWIN NUMBER	CASE QTY.	WEIGHT (ea.) lbs.	WEIGHT (ea.) kgs.	Volume (ea.) ft ³	Volume (ea.) m ³	BALDWIN NUMBER	CASE QTY.	WEIGHT (ea.) lbs.	WEIGHT (ea.) kgs.	Volume (ea.) ft ³	Volume (ea.) m ³
B2	12	1.213	0.550	.061	0.002	P80	12	.704	0.319	.063	0.002	PT135	12	.342	0.155	.034	0.001
B2-HPG	12	1.162	0.527	.050	0.001	P80-HD	12	.817	0.371	.063	0.002	PT137	12	1.075	0.488	.106	0.003
B4	12	.954	0.433	.044	0.001	P81	12	.517	0.235	.046	0.001	PT138-10	12	.862	0.391	.080	0.002
BT5	12	1.304	0.591	.049	0.001	P82	12	.725	0.329	.079	0.002	PT138-25	12	.842	0.382	.080	0.002
B6	12	1.221	0.554	.061	0.002	PT82-HD	12	.950	0.431	.105	0.003	PT139-10	12	1.208	0.548	.186	0.005
B6-HPG	12	1.108	0.503	.052	0.001	PT82-HD10	12	.958	0.435	.108	0.003	P140	12	.317	0.144	.033	0.001
B7	12	1.600	0.726	.082	0.002	PT83	6	2.384	1.081	.270	0.008	B141	12	1.038	0.471	.051	0.001
B9	12	1.142	0.518	.061	0.002	PT83-MPG	6	3.200	1.452	.273	0.008	BD142	12	2.100	0.953	.070	0.002
B10-AL	6	2.525	1.145	.154	0.004	P84-2	12	.558	0.253	.040	0.001	B143	12	.760	0.345	.040	0.001
B10-AL BSP	6	2.483	1.126	.156	0.004	PT85	12	.763	0.346	.079	0.002	P144	12	.337	0.153	.040	0.001
B10-AL BSPCS	6	2.530	1.148	.160	0.005	PT86-HD	12	1.204	0.546	.189	0.005	PT146	12	1.304	0.591	.189	0.005
B10-AL CAP	6	1.625	0.737	.043	0.001	PT87-S	12	1.146	0.520	.088	0.002	P148	12	.279	0.127	.033	0.001
B10-AL BOWL	6	.658	0.298	.144	0.004	PT88-HD	12	1.283	0.582	.190	0.005	P150	12	.475	0.215	.046	0.001
PF10	12	.392	0.178	.037	0.001	PT89	12	1.175	0.533	.129	0.004	151	18	.550	0.249	.068	0.002
PF10-CS	12	.408	0.185	.037	0.001	PT90-10	12	1.700	0.771	.186	0.005	151-30	18	.533	0.242	.068	0.002
PT11	12	.917	0.416	.089	0.003	PT90-MPG	12	2.175	0.987	.187	0.005	151-W	18	.600	0.272	.070	0.002
PT11-HD	12	1.079	0.489	.090	0.003	PT91	12	1.838	0.834	.130	0.004	PT151	12	.612	0.278	.051	0.001
PT12	12	.575	0.261	.061	0.002	PT93	12	.958	0.435	.099	0.003	PT152	12	1.088	0.494	.106	0.003
BF13	12	.950	0.431	.043	0.001	PT93-MPG	12	1.192	0.541	.109	0.003	PT153	12	.779	0.353	.080	0.002
P15	12	.483	0.219	.051	0.001	B95	6	2.792	1.266	.142	0.004	PT154	12	.971	0.440	.105	0.003
S16-1	12	.563	0.255	.063	0.002	B95-MPG	6	3.008	1.364	.143	0.004	PF155	12	1.142	0.518	.134	0.004
P18	12	.571	0.259	.065	0.002	B95-SS	6	2.767	1.255	.143	0.004	B156	12	.963	0.437	.045	0.001
P18-HD	12	.717	0.325	.065	0.002	B96	6	2.942	1.334	.163	0.005	B157	12	1.779	0.807	.087	0.002
P19	12	.783	0.355	.081	0.002	B96-MPG	6	3.317	1.505	.163	0.005	B159	12	.708	0.321	.037	0.001
P20-HD	12	1.188	0.539	.133	0.004	B96-SS	6	2.992	1.357	.160	0.005	B160	12	.650	0.295	.028	0.001
P25	12	.754	0.342	.080	0.002	B97	6	2.658	1.206	.148	0.004	B161-S	12	.700	0.318	.032	0.001
P26	12	.808	0.367	.078	0.002	PT98-10	6	3.075	1.395	.327	0.009	P162	12	.529	0.240	.063	0.002
B27	12	1.092	0.495	.051	0.001	PT98-MPG	6	3.567	1.618	.328	0.009	B163	12	1.042	0.473	.051	0.001
BD28	12	1.304	0.591	.057	0.002	B99	6	4.183	1.897	.236	0.007	B164	12	1.400	0.635	.062	0.002
PT29	12	.425	0.193	.048	0.001	B99-B	6	4.492	2.038	.269	0.008	B166	12	1.033	0.469	.050	0.001
AFG30	1	.300	0.136	.014	**	B99-MPG	6	4.542	2.060	.225	0.006	B167	12	1.279	0.580	.068	0.002
B30	12	.754	0.342	.037	0.001	B99-SS	6	4.333	1.965	.225	0.006	B168	12	.796	0.361	.047	0.001
B31	12	.642	0.291	.031	0.001	101	18	.364	0.165	.032	0.001	P170	12	.438	0.199	.049	0.001
B33	12	.529	0.240	.028	0.001	101-30	18	.375	0.170	.034	0.001	P171	12	.396	0.180	.032	0.001
B34	12	1.046	0.474	.049	0.001	101-W	18	.400	0.181	.034	0.001	P172	12	.392	0.178	.034	0.001
B35-S	12	.717	0.325	.035	0.001	P102	12	1.167	0.529	.100	0.003	B173-S	12	.954	0.433	.052	0.001
AFG37R	6	.450	0.204	.040	0.001	BD103	6	3.533	1.603	.165	0.005	P174	12	.458	0.208	.048	0.001
B37	12	.571	0.259	.028	0.001	BD103-MPG	6	3.667	1.663	.164	0.005	P176	12	.321	0.146	.034	0.001
AFG38D	6	.208	0.094	.030	0.001	BD103-SS	6	3.559	1.614	.161	0.005	P177	12	.442	0.200	.047	0.001
B39	12	1.025	0.465	.052	0.001	P104	12	.675	0.306	.065	0.002	B178	12	.725	0.329	.036	0.001
P40	12	.658	0.298	.051	0.001	B105	6	2.092	0.949	.094	0.003	B179	12	.621	0.282	.028	0.001
P41	12	.817	0.371	.080	0.002	P106	12	.150	0.068	.016	**	PT181 KIT	1	1.750	0.794	.239	0.007
P42	12	1.021	0.463	.133	0.004	P106-HD	12	.250	0.113	.022	0.001	P183	12	.267	0.121	.040	0.001
B43-S	12	.625	0.284	.028	0.001	PT108	12	.383	0.174	.038	0.001	P184	12	.617	0.280	.055	0.002
B45	12	2.250	1.021	.107	0.003	PT108-HD	12	.475	0.215	.037	0.001	PT185	12	.658	0.298	.097	0.003
P47	12	.904	0.410	.079	0.002	B109	12	1.271	0.577	.060	0.002	P186	12	.358	0.162	.041	0.001
PT48	12	.438	0.199	.034	0.001	BC110	12	.883	0.401	.062	0.002	P187	12	.296	0.134	.032	0.001
B49	6	2.825	1.281	.161	0.005	BT111	12	1.167	0.529	.061	0.002	PT189	12	1.192	0.541	.099	0.003
B50	12	1.167	0.529	.052	0.001	BT112	12	1.175	0.533	.061	0.002	PT189-MPG	12	1.275	0.578	.107	0.003
P52	12	1.121	0.508	.132	0.004	B113	12	.712	0.323	.036	0.001	P190	12	.463	0.210	.050	0.001
P53	12	.837	0.380	.081	0.002	B114	12	1.208	0.548	.061	0.002	PT191	1	1.750	0.794	.211	0.006
P54	12	.987	0.448	.079	0.002	PT115	12	1.125	0.510	.134	0.004	PT191-5	1	1.800	0.816	.208	0.006
B56	12	.746	0.338	.036	0.001	P116	1	2.600	1.179	.233	0.007	PT191-10	6	2.117	0.960	.255	0.007
P60	12	.725	0.329	.066	0.002	PF116	6	2.334	1.059	.272	0.008	PT193	1	2.150	0.975	.209	0.006
61	12	.238	0.108	.016	**	PT117	6	3.267	1.482	.458	0.013	PT193-3	1	2.250	1.021	.209	0.006
61-W	12	.233	0.106	.016	**	PT117-25	6	3.325	1.508	.454	0.013	PT193 KIT	1	2.400	1.089	.289	0.008
PT61-HD	12	.754	0.342	.080	0.002	B118	12	1.196	0.543	.061	0.002	P194	6	2.025	0.919	.258	0.007
PT62	12	.525	0.238	.040	0.001	PT119	12	2.950	1.338	.395	0.011	P194-HD	6	2.292	1.040	.255	0.007
PT63-1	12	.633	0.287	.081	0.002	PT119-5	1	2.950	1.338	.395	0.011	P194-HD10	6	2.375	1.077	.255	0.007
66	12	.229	0.104	.016	**	PT119-HD	1	3.500	1.588	.395	0.011	PF194	6	2.100	0.953	.258	0.007
66-30	12	.217	0.098	.016	**	PT119-HD5	1	3.550	1.610	.395	0.011	B195	12	.650	0.295	.027	0.001
66-W	12	.229	0.104	.016	**	B120	12	.996	0.452	.051	0.001	B196	6	2.758	1.251	.144	0.004
PT66-HD	12	.771	0.350	.063	0.002	PF121	12	.525	0.238	.047	0.001	P198	12	.708	0.321	.079	0.002
P67	12	.742	0.337	.061	0.002	PT122-5	1	4.400	1.996	.464	0.013	B199	12	.788	0.357	.038	0.001
P68	12	.871	0.395	.082	0.002	BT124	12	1.883	0.854	.087	0.002	201	8	.894	0.406	.128	0.004
PT70	12	.671	0.304	.066	0.002	P125	12	.450	0.204	.046	0.001	201-30	8	1.143	0.518	.129	0.004
PT71	12	.530	0.240	.056	0.002	BT126	12	1.388	0.630	.079	0.002	201-W	8	.950	0.431	.129	0.004
PT72	12	.712	0.323	.081	0.002	P127	12	.788	0.357	.082	0.002	B201-S	12	1.475	0.669	.056	0.002
P73	12	.529	0.240	.040	0.001	B128	12	1.971	0.894	.086	0.002	B202	12	1.175	0.533	.060	0.002
B74	12	1.025	0.465	.052	0.001	B129	12	1.787	0.811	.088	0.002	P203	12	.821	0.372	.080	0.002
B75	12	1.612	0.731	.070	0.002	B131	12	.708	0.321	.028	0.001	P203-HD	12	.958	0.435	.082	0.002
B76	12	2.375	1.077	.120	0.003	B132	12	.975	0.442	.051	0.001	P203-HD10	12	.971	0.440	.078	0.002
B76-MPG	12	2.650	1.202	.120	0.003	C133-OW	7	2.714	1.231	.390	0.011	P204	12	.983	0.446	.107	0.003
B76-SS	12	2.492	1.130	.122	0.003	C133-W	7	2.679	1.215	.388	0.011	P204-HD	12	1.179	0.535	.107	0.003
PT79	12																

BALDWIN WEIGHTS AND VOLUMES

BALDWIN NUMBER	CASE QTY.	WEIGHT (ea.)		Volume (ea.)		BALDWIN NUMBER	CASE QTY.	WEIGHT (ea.)		Volume (ea.)		BALDWIN NUMBER	CASE QTY.	WEIGHT (ea.)		Volume (ea.)	
		lbs.	kgs.	ft ³	m ³			lbs.	kgs.	ft ³	m ³			lbs.	kgs.	ft ³	m ³
B205	6	2.392	1.085	.121	0.003	PT284	12	.238	0.108	.037	0.001	BT364	12	1.175	0.533	.052	0.001
P206	12	.700	0.318	.081	0.002	PT285	6	1.833	0.831	.275	0.008	BT365	12	1.275	0.578	.068	0.002
PT207	12	.908	0.412	.107	0.003	BT287	6	2.558	1.160	.124	0.004	BT365-10	12	1.362	0.618	.080	0.002
PT207-10	12	.896	0.406	.108	0.003	BT287-10	6	2.592	1.176	.126	0.004	BT366-10	12	1.112	0.504	.052	0.001
PT207-HD	12	1.142	0.518	.106	0.003	BT287-3	6	2.608	1.183	.127	0.004	BT366-MPG	12	1.863	0.845	.059	0.002
PT207-HD10	12	1.138	0.516	.107	0.003	PT288-HD	12	1.308	0.593	.133	0.004	BT367	12	.958	0.435	.043	0.001
PT208	6	1.533	0.695	.160	0.005	PT288-HD10	12	1.338	0.607	.134	0.004	BT367-S	12	.896	0.406	.051	0.001
PT210	12	.625	0.284	.062	0.002	PT289	12	.483	0.219	.061	0.002	BT368	12	.904	0.410	.050	0.001
B211	12	1.596	0.724	.070	0.002	PT289-10	12	.475	0.215	.063	0.002	B369	12	1.025	0.465	.051	0.001
PT212-5	1	4.600	2.087	.464	0.013	PT290	12	.471	0.214	.062	0.002	PT370	4	6.163	2.796	.719	0.020
PT213	12	1.009	0.458	.126	0.004	BT292	12	1.125	0.510	.053	0.001	BT371-10	12	1.292	0.586	.061	0.002
PT214(2)	12	.563	0.255	.097	0.003	P294	12	1.867	0.847	.158	0.004	BT371-MPG	12	1.404	0.637	.060	0.002
BT215	12	.717	0.325	.035	0.001	B295	12	.837	0.380	.048	0.001	BT372-10	12	1.804	0.818	.096	0.003
BT216	12	1.183	0.537	.052	0.001	B296	12	.904	0.410	.045	0.001	BT372-MPG	12	1.917	0.870	.096	0.003
BT217	12	1.342	0.609	.068	0.002	PT298-10	12	1.075	0.488	.119	0.003	PT373	12	1.225	0.556	.105	0.003
B218	12	2.508	1.138	.122	0.003	B299	12	1.379	0.626	.067	0.002	PT374	12	.612	0.278	.064	0.002
B220	6	2.658	1.206	.145	0.004	T300-M	12	.729	0.331	.053	0.001	PT375	12	.950	0.431	.099	0.003
BT221	12	1.996	0.905	.080	0.002	301	4	1.600	0.726	.254	0.007	PT376	12	1.433	0.650	.135	0.004
B222	12	1.475	0.669	.057	0.002	301-30	4	1.425	0.646	.260	0.007	PT377	12	.646	0.293	.047	0.001
BT223	12	.700	0.318	.029	0.001	301-CS	4	2.338	1.061	.251	0.007	PT377-10	12	.646	0.293	.048	0.001
PF224	12	.179	0.081	.020	0.001	301-MPG	1	2.560	1.157	.319	0.009	B378	12	1.554	0.705	.084	0.002
PF225	12	.904	0.410	.107	0.003	301-W	4	1.563	0.709	.258	0.007	B378-10	12	1.521	0.690	.083	0.002
PF226	12	.546	0.248	.065	0.002	B301	12	.625	0.284	.031	0.001	PT379 KIT	6	1.383	0.627	.157	0.004
B227	12	.625	0.284	.028	0.001	PT302	12	1.267	0.575	.074	0.002	PT380 KIT	1	2.350	1.066	.221	0.006
B228	12	.667	0.303	.028	0.001	T303-M	12	1.204	0.546	.071	0.002	PT381	12	1.821	0.826	.134	0.004
B229	12	1.004	0.455	.043	0.001	PT304	12	1.333	0.605	.095	0.003	PT382	12	.471	0.214	.035	0.001
BT230	12	1.088	0.494	.051	0.001	BT305	12	1.379	0.626	.065	0.002	PT383	12	1.088	0.494	.132	0.004
PF231	12	.429	0.195	.056	0.002	B307	12	.633	0.287	.032	0.001	PT385	12	1.517	0.688	.134	0.004
BD232	12	2.196	0.996	.078	0.002	T308-M	12	.725	0.329	.054	0.002	PT385-E	12	1.546	0.701	.132	0.004
B233	12	1.071	0.486	.051	0.001	B309	12	1.754	0.796	.086	0.002	PT386	12	1.355	0.615	.231	0.007
BT234	6	2.325	1.055	.095	0.003	BT310	12	.663	0.301	.032	0.001	BT387	6	2.592	1.176	.124	0.004
P235	12	.725	0.329	.100	0.003	PF311	12	.354	0.161	.033	0.001	BT387-10	6	2.625	1.191	.125	0.004
B236	12	1.475	0.669	.079	0.002	PF312	12	1.071	0.486	.100	0.003	BT388	6	3.300	1.497	.264	0.007
BT237	12	1.350	0.612	.066	0.002	PF313	12	.325	0.147	.034	0.001	BT388-10	6	3.325	1.508	.265	0.007
BT238	12	1.787	0.811	.088	0.002	PF314	12	.250	0.113	.034	0.001	BT389	6	3.342	1.516	.263	0.007
B239	6	4.208	1.909	.225	0.006	PF316	6	2.617	1.187	.277	0.008	BT389-10	6	3.392	1.539	.262	0.007
P240	12	.342	0.155	.034	0.001	PT317-MPG	1	1.550	0.703	.096	0.003	PT390-MPG	12	1.796	0.815	.135	0.004
BT241	12	1.108	0.503	.051	0.001	PT318-MPG	1	1.650	0.748	.090	0.003	PT391-MPG	12	1.675	0.760	.130	0.004
P242	12	1.492	0.677	.115	0.003	PT319-MPG	1	3.550	1.610	.366	0.010	PT392	12	1.096	0.497	.131	0.004
B243	12	.767	0.348	.037	0.001	PT320-MPG	1	2.950	1.338	.226	0.006	PT393	12	1.859	0.843	.185	0.005
B244	12	1.125	0.510	.052	0.001	BD324	6	3.100	1.406	.140	0.004	PT394-5	6	2.509	1.138	.254	0.007
B246	12	1.155	0.524	.059	0.002	BD325	12	2.946	1.336	.115	0.003	PT394-15	6	2.600	1.179	.255	0.007
B247	12	.750	0.340	.036	0.001	B326	12	1.783	0.809	.086	0.002	BT395	12	1.083	0.491	.047	0.001
BT248	12	1.183	0.537	.052	0.001	B329	12	1.017	0.461	.051	0.001	PT396	12	.417	0.189	.034	0.001
P249	12	1.471	0.667	.120	0.003	BF330	12	.862	0.391	.042	0.001	PT397	4	3.025	1.372	.378	0.011
BT251	12	1.296	0.588	.066	0.002	PF332	12	.604	0.274	.065	0.002	BT398	12	2.308	1.047	.107	0.003
B252	12	1.425	0.646	.053	0.001	B333	6	3.250	1.474	.164	0.005	PT400	6	1.983	0.899	.205	0.006
B253	12	1.438	0.652	.051	0.001	BT334	12	1.217	0.552	.060	0.002	PT401-MPG	6	1.517	0.688	.148	0.004
B255	12	1.396	0.633	.049	0.001	B336	12	1.188	0.539	.062	0.002	BT402	12	2.333	1.058	.108	0.003
PT256	12	.150	0.068	.036	0.001	B337	12	1.625	0.737	.072	0.002	B403	12	1.563	0.709	.079	0.002
PT257	12	.183	0.083	.035	0.001	BT338	12	1.042	0.473	.046	0.001	B404	6	2.083	0.945	.099	0.003
PT258	12	.350	0.159	.030	0.001	BT339	12	1.208	0.548	.066	0.002	JC405	12	.767	0.348	.070	0.002
BT259	12	1.213	0.550	.060	0.002	BT340	12	2.584	1.172	.120	0.003	CU406	12	.775	0.352	.072	0.002
BT260	12	1.063	0.482	.052	0.001	BT341	12	1.042	0.473	.040	0.001	DF408	6	2.175	0.987	.236	0.007
BT260-10	12	1.112	0.504	.051	0.001	BT342	12	1.458	0.661	.077	0.002	TC413-CPE5	12	1.404	0.637	.122	0.003
BT261	12	1.313	0.596	.068	0.002	BT343	6	3.175	1.440	.143	0.004	V414-B	4	3.313	1.503	.541	0.015
B262	12	1.546	0.701	.084	0.002	BT344-S	12	1.371	0.622	.041	0.001	V414-FF	4	2.963	1.344	.535	0.015
B263	12	2.108	0.956	.107	0.003	BT345 KIT	1	6.250	2.835	.546	0.015	F415-B	4	3.338	1.514	.546	0.015
BT264	12	1.075	0.488	.049	0.001	BT346	12	.950	0.431	.050	0.001	P415-5	4	4.438	2.013	.534	0.015
PT265	12	.675	0.306	.061	0.002	BT347	12	1.821	0.826	.086	0.002	P415-10	4	4.725	2.143	.532	0.015
P266	12	.558	0.253	.055	0.002	BT348	12	1.575	0.714	.073	0.002	P415-25	4	4.313	1.956	.539	0.015
BT267	12	1.496	0.679	.070	0.002	BT349	12	2.063	0.936	.109	0.003	P415-5A	4	4.163	1.888	.532	0.015
PT268	12	1.033	0.469	.132	0.004	BT350	12	1.775	0.805	.089	0.003	P415-10A	4	4.288	1.945	.532	0.015
PT269	12	.558	0.253	.055	0.002	BT351	12	2.625	1.191	.115	0.003	P415-25A	4	4.013	1.820	.532	0.015
P271	12	.392	0.178	.033	0.001	BT351-MPG	6	2.967	1.346	.148	0.004	P415-SAN	4	4.113	1.866	.532	0.015
PT273	12	.538	0.244	.047	0.001	P352	6	1.475	0.669	.201	0.006	P415-GM	4	3.787	1.718	.585	0.017
BT274	12	1.204	0.546	.062	0.002	BT353	12	.854	0.387	.047	0.001	V415-B	4	3.475	1.576	.516	0.015
PT275	12	1.213	0.550	.134	0.004	BT354	12	1.117	0.507	.052	0.001	V415-FF	4	3.063	1.389	.539	0.015
PT275-10	12	1.150	0.522	.134	0.004	BT355	12	1.504	0.682	.072	0.002	PT416	12	.417	0.189	.033	0.001
P276	12	1.029	0.467	.108	0.003	P356	12	.579	0.263	.080	0.002	PT418	4	6.025	2.733	.719	0.020
PT277	12	.871	0.395	.099	0.003	BT357	12	.950	0.431	.051	0.001	BT420	12	1.338	0.607	.041	0.001
B279	12	1.296	0.588	.060	0.002	B358	12	1.071	0.486	.048	0.001	B421	12	.638	0.289	.032	

BALDWIN WEIGHTS AND VOLUMES

BALDWIN NUMBER	CASE QTY.	WEIGHT (ea.) lbs.	WEIGHT (ea.) kgs.	Volume (ea.) ft ³	Volume (ea.) m ³	BALDWIN NUMBER	CASE QTY.	WEIGHT (ea.) lbs.	WEIGHT (ea.) kgs.	Volume (ea.) ft ³	Volume (ea.) m ³	BALDWIN NUMBER	CASE QTY.	WEIGHT (ea.) lbs.	WEIGHT (ea.) kgs.	Volume (ea.) ft ³	Volume (ea.) m ³
PT426	12	1.287	0.584	.107	0.003	PT510	12	1.433	0.650	.133	0.004	PA602	6	1.312	0.595	.258	0.007
BT427	12	1.046	0.474	.054	0.002	PT512	4	1.787	0.811	.280	0.008	PA604	6	1.509	0.684	.230	0.007
V429-B	4	4.750	2.155	.914	0.026	PT513	12	.387	0.176	.055	0.002	B605	12	1.742	0.790	.070	0.002
V429-FF	4	4.387	1.990	.777	0.022	PT514	12	1.108	0.503	.131	0.004	BT606-MPG	12	1.325	0.601	.054	0.002
PT430-FF	6	2.417	1.096	.251	0.007	PT515	4	3.788	1.718	.584	0.017	PA607	6	1.825	0.828	.282	0.008
PT431	12	1.700	0.771	.188	0.005	PT516	12	1.167	0.529	.100	0.003	BT610-MPG	6	3.883	1.761	.162	0.005
PT433	12	1.129	0.512	.109	0.003	PT517	12	1.521	0.690	.231	0.007	BT611-MPG	6	2.575	1.168	.095	0.003
PT434	12	.429	0.195	.038	0.001	PT518	1	8.050	3.651	1.288	0.036	PA612	6	1.217	0.552	.214	0.006
PT434-10	12	.433	0.196	.037	0.001	PT518-10	1	7.950	3.606	1.288	0.036	PA613	6	1.417	0.643	.281	0.008
PT435	12	.513	0.233	.033	0.001	PT520	6	2.792	1.266	.327	0.009	BF614	12	2.017	0.915	.098	0.003
PT436	12	1.525	0.692	.134	0.004	BT521	12	1.921	0.871	.088	0.002	PA615	6	1.350	0.612	.247	0.007
PT437	12	.858	0.389	.083	0.002	PT522	12	.600	0.272	.100	0.003	PA616	1	4.500	2.041	.891	0.025
BT438	12	1.421	0.645	.057	0.002	BT525	12	1.608	0.729	.096	0.003	PA617	1	3.450	1.565	.574	0.016
PT439	12	.587	0.266	.062	0.002	BT526	12	1.167	0.529	.050	0.001	PA618	1	5.450	2.472	.884	0.025
BT440	12	1.733	0.786	.086	0.002	BT526-10	12	1.208	0.548	.050	0.001	PA618-S	1	5.150	2.336	.869	0.025
PT441	12	.983	0.446	.054	0.002	PT527	12	5.100	2.313	.853	0.024	PA618 FOAM	6	.242	0.110	.153	0.004
PT442-MPG	12	2.375	1.077	.139	0.004	P528	12	1.013	0.459	.097	0.003	PA621	6	1.067	0.484	.234	0.007
BT443	6	2.334	1.059	.119	0.003	P529	6	2.625	1.191	.326	0.009	PA625	6	1.717	0.779	.342	0.010
PT445-MPG	12	.829	0.376	.062	0.002	PT534	6	.892	0.405	.157	0.004	PA631	6	3.908	1.773	.959	0.027
P446	12	.346	0.157	.034	0.001	PT535	12	.779	0.353	.063	0.002	PA632	6	2.490	1.129	.410	0.012
B447	12	1.375	0.624	.059	0.002	BT536	12	1.029	0.467	.052	0.001	PA633(2)	12	.808	0.367	.052	0.001
P450	12	.150	0.068	.008	**	P537	6	3.292	1.493	.454	0.013	PA634	6	.700	0.318	.102	0.003
S451	12	.060	0.027	.010	**	PT538	12	1.529	0.694	.189	0.005	PA638	4	2.000	0.907	.502	0.014
BT452	12	1.196	0.543	.062	0.002	PT539	1	1.950	0.885	.230	0.007	PA639	1	5.200	2.359	.780	0.022
P454	12	.346	0.157	.014	**	P540	12	.100	0.045	.016	**	PA640	6	.625	0.284	.106	0.003
S455	12	.067	0.030	.011	**	BT541	12	1.112	0.504	.051	0.001	PA641	1	2.100	0.953	.288	0.008
S456	12	.192	0.087	.034	0.001	PT543 KIT	6	1.642	0.745	.212	0.006	PA642	6	1.217	0.552	.250	0.007
PT457-MPG	6	2.917	1.323	.255	0.007	P545	12	.755	0.342	.059	0.002	PA643	12	.346	0.157	.081	0.002
PT459	12	.162	0.073	.011	**	PT546	12	.542	0.246	.048	0.001	PA644	12	.367	0.166	.082	0.002
PT461	12	.238	0.108	.033	0.001	PT548	6	.400	0.181	.034	0.001	PA645	1	7.850	3.561	1.230	0.035
PT462	6	2.225	1.009	.279	0.008	PT549	12	.600	0.272	.056	0.002	PA648	6	1.042	0.473	.233	0.007
PT463	12	.380	0.172	.021	0.001	PT550-10	6	2.284	1.036	.250	0.007	PA649	6	.584	0.265	.097	0.003
PT466	12	1.505	0.683	.126	0.004	PT551-10	1	3.050	1.383	.318	0.009	PA650	6	1.666	0.756	.214	0.006
PT467-MPG	6	1.575	0.714	.110	0.003	PT554	12	1.642	0.745	.233	0.007	PA651	4	2.125	0.964	.518	0.015
PT468-MPG	12	1.167	0.529	.089	0.003	P555	12	1.600	0.726	.186	0.005	PA652	6	.892	0.405	.148	0.004
PT469	1	2.200	0.998	.233	0.007	BT556-10	12	2.471	1.121	.120	0.003	PA653	1	1.200	0.544	.223	0.006
BT470	12	1.838	0.834	.086	0.002	PT558	6	.867	0.393	.104	0.003	PA654	1	3.992	1.811	.589	0.017
PT471	12	.884	0.401	.185	0.005	PT560 KIT	1	2.550	1.157	.221	0.006	PA655	1	2.650	1.202	.361	0.010
BT472	12	2.563	1.163	.108	0.003	PT561	12	1.542	0.699	.131	0.004	PA656	1	4.100	1.860	.554	0.016
B474	12	.675	0.306	.031	0.001	PT562-10	12	.658	0.298	.066	0.002	PA657	6	1.009	0.458	.185	0.005
PT475	12	1.317	0.597	.136	0.004	PT563	12	1.596	0.724	.189	0.005	PA658	6	.925	0.420	.148	0.004
P476	12	.833	0.378	.102	0.003	BT564	12	1.454	0.660	.070	0.002	PA662	6	2.050	0.930	.185	0.005
PT477	12	.342	0.155	.037	0.001	PT565	6	.842	0.382	.159	0.004	PA666	1	7.400	3.357	1.519	0.043
PT480	12	.629	0.285	.049	0.001	PT566	12	1.379	0.626	.189	0.005	PA669	6	1.334	0.605	.109	0.003
PT480-10	12	.629	0.285	.047	0.001	PT567	12	.942	0.427	.101	0.003	PT670	12	.929	0.421	.108	0.003
PT480-MPG	12	.763	0.346	.048	0.001	PT567-10	12	.892	0.405	.099	0.003	PT670-E	12	.888	0.403	.109	0.003
B481	12	1.338	0.607	.063	0.002	PT568	12	2.137	0.969	.187	0.005	PA671	1	4.200	1.905	.652	0.018
PT483	1	4.100	1.860	.464	0.013	PT571	1	1.800	0.816	.177	0.005	PA671-1	1	3.550	1.610	.652	0.018
S485	12	.010	0.005	.016	**	PT573	1	1.900	0.862	.179	0.005	PA675	6	.450	0.204	.081	0.002
BT486	6	2.667	1.210	.148	0.004	BF577	12	1.488	0.675	.083	0.002	PT676	1	1.450	0.658	.117	0.003
PT487	12	1.208	0.548	.098	0.003	PT578	12	1.033	0.469	.133	0.004	PA677	6	.317	0.144	.034	0.001
B488	12	.967	0.439	.050	0.001	PT579	12	1.071	0.486	.189	0.005	PA678	6	.592	0.269	.100	0.003
PT490	1	3.200	1.452	.318	0.009	BF582	12	1.221	0.554	.060	0.002	PA680	6	1.092	0.495	.194	0.005
PT491	1	5.700	2.586	.464	0.013	BF583	12	1.138	0.516	.054	0.002	PT682	1	2.100	0.953	.234	0.007
PT491-10	1	5.050	2.291	.464	0.013	BF584	12	2.383	1.081	.124	0.004	PT683	1	2.950	1.338	.167	0.005
PT492	12	.329	0.149	.037	0.001	BF584-B	12	2.558	1.160	.128	0.004	PT685-MPG	12	1.146	0.520	.091	0.003
PT493	6	2.984	1.354	.372	0.011	BF585	12	1.071	0.486	.052	0.001	PA691	6	1.075	0.488	.214	0.006
B494	12	1.463	0.664	.054	0.002	BF586	12	.904	0.410	.046	0.001	PT691	1	.500	0.227	.072	0.002
B495	6	2.817	1.278	.147	0.004	BF586-D	12	.925	0.420	.046	0.001	PA693	6	2.034	0.923	.591	0.017
B495-MPG	6	3.008	1.364	.144	0.004	BF587	12	.933	0.423	.046	0.001	PT694	1	3.000	1.361	.231	0.007
B495-SS	6	2.800	1.270	.143	0.004	BF587-D	12	.962	0.436	.046	0.001	PA696	6	.742	0.337	.105	0.003
P496	12	.342	0.155	.034	0.001	BF588	12	1.904	0.864	.086	0.002	PA697	6	.558	0.253	.052	0.001
P497	12	.413	0.187	.048	0.001	BF591	12	1.458	0.661	.081	0.002	PA699	6	.858	0.389	.120	0.003
PT498	12	1.058	0.480	.105	0.003	BF592	12	.983	0.446	.045	0.001	C704-L	4	4.575	2.075	.388	0.011
PT498-10	12	1.071	0.486	.107	0.003	BF593	12	.983	0.446	.042	0.001	P706-M	4	3.675	1.667	.583	0.016
PT499-5	1	2.650	1.202	.289	0.008	BF594-F	12	1.104	0.501	.106	0.003	PT707-HD	12	1.321	0.599	.100	0.003
501	4	1.475	0.669	.251	0.007	PF594	12	.942	0.427	.107	0.003	PT707-HD3	12	1.350	0.612	.101	0.003
501-30	4	1.438	0.652	.252	0.007	BT595	12	1.237	0.561	.066	0.002	PT707-HD10	12	1.354	0.614	.101	0.003
501-W	4	1.588	0.720	.258	0.007	BF596	6	2.808	1.274	.164	0.005	PT708-HD	12	1.313	0.596	.100	0.003
F501-MD	4	1.575	0.714	.152	0.004	BF597	12	1.425	0.646	.099	0.003	PT716	1	1.650	0.748	.137	0.004
PT503	1	3.250	1.474	.486	0.014	PF598	12	.371	0.168	.039	0.001	PF717	12	.196	0.089	.020	0.001
PF506	12	.296	0.134	.034	0.001	PF598-10	12	.350	0.159	.040	0.001	P718-5	4	4.025	1.826	.532	0.015
P507	12	1.188	0.539	.187	0.005	PF598-30	12	.392	0.178	.040	0.001	BF719	12	1.088			

BALDWIN WEIGHTS AND VOLUMES

BALDWIN NUMBER	CASE QTY.	WEIGHT (ea.) lbs.	WEIGHT (ea.) kgs.	Volume (ea.) ft ³	Volume (ea.) m ³	BALDWIN NUMBER	CASE QTY.	WEIGHT (ea.) lbs.	WEIGHT (ea.) kgs.	Volume (ea.) ft ³	Volume (ea.) m ³	BALDWIN NUMBER	CASE QTY.	WEIGHT (ea.) lbs.	WEIGHT (ea.) kgs.	Volume (ea.) ft ³	Volume (ea.) m ³
PT722	6	2.817	1.278	.275	0.008	PF823-E	12	.692	0.314	.080	0.002	PF902	12	.583	0.264	.061	0.002
P723	12	.763	0.346	.107	0.003	PF824	12	.717	0.325	.066	0.002	PF902-S	12	.521	0.236	.063	0.002
PT725-MPG	6	1.892	0.858	.152	0.004	BF825	12	.420	0.191	.030	0.001	PT903	12	.467	0.212	.042	0.001
PT727-HD	12	.600	0.272	.048	0.001	PF826	12	.742	0.337	.082	0.002	PF906	12	.358	0.162	.034	0.001
PT727-HD10	12	.612	0.278	.048	0.001	PF827	12	.158	0.072	.024	0.001	PF907	12	.533	0.242	.063	0.002
PT727-DL	24	.848	0.385	.061	0.002	PF828	12	.408	0.185	.047	0.001	F908-A	6	2.033	0.922	.254	0.007
PT728-MPG	12	.513	0.233	.050	0.001	PF829(2)	6	1.550	0.703	.185	0.005	BF909	12	1.700	0.771	.048	0.001
PT729	4	4.438	2.013	.532	0.015	BF830	12	.633	0.287	.059	0.002	PF910	12	.508	0.230	.062	0.002
BT732	6	2.375	1.077	.090	0.003	PF831	12	.421	0.191	.049	0.001	BF912	12	1.420	0.644	.047	0.001
BT735	12	1.975	0.896	.075	0.002	BF833	12	.204	0.093	.020	0.001	PF913	12	.308	0.140	.034	0.001
PT737	12	1.121	0.508	.101	0.003	BF833-K2	12	.250	0.113	.020	0.001	BF914	6	2.192	0.994	.142	0.004
PT737-10	12	1.121	0.508	.101	0.003	F834-F	12	.379	0.172	.027	0.001	BF915	12	1.350	0.612	.070	0.002
V738-O	12	.667	0.303	.087	0.002	PF834	12	.337	0.153	.034	0.001	F916-C	12	.396	0.180	.062	0.002
BT739	12	2.229	1.011	.096	0.003	BF836	12	.204	0.093	.020	0.001	PF916	12	.492	0.223	.047	0.001
C740-S	12	.450	0.204	.059	0.002	BF836-K3	12	.258	0.117	.020	0.001	BF918-K	12	.250	0.113	.016	0.001
C750-E	4	6.138	2.784	.678	0.019	BF836-K4	12	.100	0.045	.016	0.001	F919-C	60	.283	0.128	.025	0.001
C750-L	4	7.913	3.589	.653	0.018	BF837	12	.100	0.045	.016	0.001	BF920	12	.184	0.083	.018	0.001
C750-L SINGLE	1	8.150	3.697	.704	0.020	BF838-F2	12	.513	0.233	.040	0.001	PF924	12	.529	0.240	.066	0.002
PT751	6	2.233	1.013	.248	0.007	PF838	12	.462	0.210	.040	0.001	PF926	12	.425	0.193	.066	0.002
PT752	6	2.700	1.225	.375	0.011	BT839	12	1.092	0.495	.053	0.001	BF928	12	.125	0.057	.022	0.001
PT753	1	8.250	3.742	1.288	0.036	BT839-10	12	1.104	0.501	.051	0.001	BF929	12	.558	0.253	.065	0.002
PT757	6	2.242	1.017	.250	0.007	BF840	12	.188	0.085	.020	0.001	BF930	12	.254	0.115	.023	0.001
PT757-10	6	2.384	1.081	.250	0.007	BF840-K1	12	.250	0.113	.016	0.001	BF932	12	.121	0.055	.022	0.001
PT760-10	12	1.446	0.656	.133	0.004	VT842-O	12	.558	0.253	.070	0.002	BF933	12	1.100	0.455	.020	0.001
PT760-25	12	1.417	0.643	.134	0.004	BF843	12	.275	0.125	.020	0.001	PF935	12	.208	0.094	.022	0.001
PT761	12	1.429	0.648	.135	0.004	F844-A	12	1.071	0.486	.128	0.004	PF936	12	.542	0.246	.034	0.001
PT763	6	3.067	1.391	.371	0.010	F845-A	12	.488	0.221	.059	0.002	PF937	12	.125	0.057	.014	0.001
PT764	12	1.104	0.501	.083	0.002	PF845	12	.542	0.246	.061	0.002	BF938	12	.946	0.429	.042	0.001
PT765	12	1.171	0.531	.081	0.002	PF846	12	1.329	0.603	.132	0.004	BF939	12	.975	0.442	.043	0.001
PT766	6	2.609	1.183	.454	0.013	PF847	12	.166	0.075	.013	0.001	BF940	12	.604	0.274	.028	0.001
PT767	6	3.183	1.444	.370	0.010	PT849	12	.450	0.204	.033	0.001	BF941	12	.875	0.397	.042	0.001
PT768	6	3.009	1.365	.371	0.010	PT849-10	12	.471	0.214	.034	0.001	PF942	12	.529	0.240	.062	0.002
PT772	6	2.442	1.108	.371	0.010	V852-O	12	.992	0.450	.125	0.004	PF943	12	.383	0.174	.038	0.001
PT773-MPG	6	3.892	1.765	.244	0.007	BF853	12	.375	0.170	.021	0.001	PF945	12	.288	0.131	.033	0.001
BT774	1	5.400	2.449	.210	0.006	BF855	12	.558	0.253	.029	0.001	PF946	12	.379	0.172	.034	0.001
BT775	6	4.317	1.958	.205	0.006	BF856	12	.950	0.431	.035	0.001	PF947	12	.367	0.166	.034	0.001
PT776-MPG	12	2.246	1.019	.135	0.004	PF857	12	.071	0.032	.011	0.001	BF948	12	.950	0.431	.043	0.001
PT777	12	1.508	0.684	.130	0.004	BF858	12	.367	0.166	.037	0.001	BF948-JD	12	1.067	0.484	.061	0.002
BT778	12	1.663	0.754	.084	0.002	PF859	12	.088	0.040	.011	0.001	PF949	1	3.600	1.633	.407	0.012
BT779	12	1.183	0.537	.045	0.001	PF860	12	.288	0.131	.033	0.001	F950-F	12	.646	0.293	.056	0.002
BF781	12	1.317	0.597	.079	0.002	PF861	12	.308	0.140	.033	0.001	PF950	12	.467	0.212	.056	0.002
BF782	12	.692	0.314	.033	0.001	BF862	12	1.092	0.495	.061	0.002	PT951	12	.442	0.200	.039	0.001
BF783	12	1.688	0.766	.087	0.002	BF863	12	1.104	0.501	.060	0.002	PF952	12	1.430	0.649	.115	0.003
BF784	6	2.692	1.221	.139	0.004	PF864	12	.030	0.014	.124	0.004	F953-F	12	.313	0.142	.037	0.001
BF785	6	2.625	1.191	.139	0.004	BF865	12	.213	0.097	.020	0.001	BF954	12	.720	0.327	.028	0.001
BF786	12	1.563	0.709	.058	0.002	BF865-K	12	.275	0.125	.021	0.001	BF955	12	1.096	0.497	.052	0.001
BF788	12	.917	0.416	.032	0.001	PF866	12	.292	0.132	.034	0.001	BF955 KIT	6	1.933	0.877	.143	0.004
BF789	12	.950	0.431	.044	0.001	BF868	12	.367	0.166	.038	0.001	BF956	12	1.150	0.522	.051	0.001
BF790	12	.688	0.312	.029	0.001	PF869	12	1.280	0.581	.231	0.007	BF957	12	1.063	0.482	.055	0.002
BF791	12	1.063	0.482	.044	0.001	PF872	12	.088	0.040	.015	0.001	BF957-D	12	1.075	0.488	.052	0.001
BF791-O	12	1.095	0.497	.051	0.001	BF873	12	.175	0.079	.045	0.001	BF958	12	1.475	0.669	.077	0.002
BF792	12	1.092	0.495	.046	0.001	BF874	12	.621	0.282	.040	0.001	BF959	12	1.075	0.488	.049	0.001
BF794	12	.383	0.174	.038	0.001	BF876	12	1.813	0.822	.086	0.002	P960	12	.404	0.183	.051	0.001
BF795	12	.488	0.221	.076	0.002	BF877	12	1.858	0.843	.087	0.002	BF962	12	1.171	0.531	.062	0.002
BF797	12	1.071	0.486	.052	0.001	BF879	12	.154	0.070	.019	0.001	PF963	12	.629	0.285	.063	0.002
BF798	12	1.321	0.599	.064	0.002	BF880-FP	12	2.121	0.962	.095	0.003	BF966	12	.483	0.219	.046	0.001
BF799	6	4.258	1.931	.247	0.007	BF881	12	.150	0.068	.023	0.001	PF967	12	.492	0.223	.046	0.001
PF802	12	.375	0.170	.034	0.001	PF882	12	.396	0.180	.061	0.002	BF968	12	1.209	0.548	.055	0.002
PF804	12	.621	0.282	.064	0.002	PF883	12	.417	0.189	.048	0.001	BF970	12	1.217	0.552	.066	0.002
BF805	12	.001	**	.011	**	BF884	12	.708	0.321	.048	0.001	BF971	12	1.263	0.573	.069	0.002
BF806	12	.871	0.395	.031	0.001	BF885	12	.788	0.357	.064	0.002	BF974-D	12	1.375	0.624	.070	0.002
PF807	12	.350	0.159	.034	0.001	BF886	12	.321	0.146	.037	0.001	B975	12	1.292	0.586	.067	0.002
PF809	12	.742	0.337	.082	0.002	BF888	12	1.625	0.737	.084	0.002	BF976	12	2.463	1.117	.123	0.003
PF810	12	.563	0.255	.063	0.002	BF890	12	.629	0.285	.047	0.001	BF978	12	1.550	0.703	.084	0.002
PF811	12	1.692	0.767	.188	0.005	BF891	12	1.175	0.533	.063	0.002	BF979	12	1.554	0.705	.084	0.002
BF812	12	.733	0.332	.054	0.002	BF892	12	1.542	0.699	.084	0.002	BF980	12	1.529	0.694	.076	0.002
PF814	12	.508	0.230	.045	0.001	PF893	12	.071	0.032	.023	0.001	PF981	12	.146	0.066	.015	0.001
PF816	12	.275	0.125	.034	0.001	PF893-RV	12	.001	**	.015	**	BF984	12	1.142	0.518	.060	0.002
PF816-S	12	.233	0.106	.033	0.001	PF894	12	.001	**	.010	**	PF986	12	.262	0.119	.020	0.001
PF818	12	.200	0.091	.015	**	PF894-RV	12	.006	0.003	.015	**	PF987	12	.758	0.344	.081	0.002
PF819	12	.725	0.329	.081	0.002	BF896	12	1.133	0.514	.055	0.002	BF988	12	.917	0.416	.033	0.001
PF820-S	12	.308	0.140	.033	0.001	BF897 KIT	1	2.400	1.089	.234	0.007	BF989	12	1.100	0.045	.016	0.001
PF821-S	12	.712	0.323	.062	0.002	SF898	12	.030	0.014	.004	**	BF991	12	1.304	0.591	.067	0.002
PF822	12	.733	0.332</														

BALDWIN WEIGHTS AND VOLUMES

BALDWIN NUMBER	CASE QTY.	WEIGHT (ea.) lbs.	WEIGHT (ea.) kgs.	Volume (ea.) ft ³	Volume (ea.) m ³	BALDWIN NUMBER	CASE QTY.	WEIGHT (ea.) lbs.	WEIGHT (ea.) kgs.	Volume (ea.) ft ³	Volume (ea.) m ³	BALDWIN NUMBER	CASE QTY.	WEIGHT (ea.) lbs.	WEIGHT (ea.) kgs.	Volume (ea.) ft ³	Volume (ea.) m ³
P996	12	2.279	1.034	.234	0.007	BF1225	12	1.362	0.618	.074	0.002	OB1318	1	.800	0.363	.030	0.001
PF997	12	.167	0.076	.020	0.001	BF1226	12	1.040	0.472	.039	0.001	OB1319	1	.700	0.318	.027	0.001
P998	12	1.234	0.560	.185	0.005	BF1231	12	1.992	0.904	.088	0.002	OB1320	1	.700	0.318	.027	0.001
P999-HD	12	1.592	0.722	.186	0.005	BF1232	12	1.029	0.467	.035	0.001	VG1325	1	.250	0.113	.029	0.001
BF1008	12	.550	0.249	.062	0.002	BF1233	12	1.179	0.535	.043	0.001	PG1326	1	.200	0.091	.030	0.001
V1044-O	12	1.067	0.484	.127	0.004	BF1239	6	3.492	1.584	.270	0.008	BF1329	12	2.046	0.928	.110	0.003
BF1045	12	.529	0.240	.061	0.002	BF1240	12	1.862	0.845	.088	0.002	BF1329-SP	12	2.196	0.996	.106	0.003
BF1046	12	.321	0.146	.048	0.001	V1240-C	8	1.581	0.717	.167	0.005	BF1330-SP	12	2.233	1.013	.109	0.003
BF1047	12	.750	0.340	.078	0.002	BF1248	12	1.183	0.537	.063	0.002	BF1339-SP	12	2.167	0.983	.108	0.003
BF1048	12	.746	0.338	.062	0.002	BF1249	12	1.558	0.707	.091	0.003	BF1345	12	1.875	0.851	.088	0.002
BF1049	12	.329	0.149	.037	0.001	BF1249-O	12	1.442	0.654	.083	0.002	BF1345-SP	12	2.033	0.922	.087	0.002
BF1050	12	.788	0.357	.059	0.002	BF1249-SP	12	1.813	0.822	.088	0.002	BF1345-O	12	1.870	0.848	.080	0.002
BF1052	12	.217	0.098	.037	0.001	BF1252	12	1.317	0.597	.078	0.002	BF1346	12	1.963	0.890	.103	0.003
BF1053	1	1.050	0.476	.819	0.023	BF1253	12	1.237	0.561	.054	0.002	BF1346-SP	12	2.258	1.024	.107	0.003
BF1056	12	.646	0.293	.032	0.001	BF1256	12	2.358	1.070	.121	0.003	BF1346-O	12	1.975	0.896	.092	0.003
BF1057	12	.400	0.181	.037	0.001	BF1257	12	.850	0.386	.031	0.001	BF1347	12	2.063	0.936	.106	0.003
BF1058	1	.700	0.318	.228	0.006	BF1258	12	1.525	0.692	.077	0.002	BF1347-O	6	1.567	0.711	.087	0.002
BF1061	12	.504	0.229	.038	0.001	BF1259	12	1.667	0.756	.098	0.003	BF1348	12	1.942	0.881	.088	0.002
BF1100	12	.579	0.263	.038	0.001	BF1261	12	.833	0.378	.032	0.001	BF1348-SP	12	2.096	0.951	.088	0.002
BF1102	12	1.321	0.599	.067	0.002	BF1262	6	3.183	1.444	.183	0.005	BF1348-O	12	1.783	0.809	.079	0.002
BF1104	12	.333	0.151	.037	0.001	BF1265	12	2.504	1.136	.141	0.004	BF1349	12	2.080	0.943	.106	0.003
BF1105	12	.504	0.229	.047	0.001	BF1266	12	1.363	0.618	.069	0.002	BF1350-SP	12	1.754	0.796	.079	0.002
BF1110	12	.754	0.342	.032	0.001	BF1267	12	.671	0.304	.028	0.001	BF1352-SPS	12	1.929	0.875	.074	0.002
BF1120	12	.658	0.298	.060	0.002	BF1268	12	1.333	0.605	.077	0.002	BF1353-SPS	12	2.917	1.323	.137	0.004
BF1123	12	.308	0.140	.032	0.001	BF1269	12	.958	0.435	.033	0.001	BF1354-SPS	12	2.858	1.296	.137	0.004
BF1140	12	.146	0.066	.022	0.001	BF1270-SP	12	1.675	0.760	.064	0.002	BF1355-O	12	2.325	1.055	.121	0.003
BF1148	12	.600	0.272	.038	0.001	BF1271	12	1.296	0.588	.057	0.002	BF1355	6	2.550	1.157	.139	0.004
BF1150	12	.146	0.066	.022	0.001	BF1272-SPS	12	1.942	0.881	.094	0.003	BF1355-SP	6	2.725	1.236	.136	0.004
BF1160	12	.175	0.079	.042	0.001	BF1273-SP	12	2.017	0.915	.090	0.003	BF1356	12	1.475	0.669	.075	0.002
BF1163	12	.421	0.191	.044	0.001	BF1274-SP	6	3.400	1.542	.169	0.005	BF1357	6	3.200	1.452	.183	0.005
BF1166	12	.521	0.236	.060	0.002	BF1274-SPS	6	3.525	1.599	.168	0.005	BF1358-SP	12	2.854	1.295	.140	0.004
BF1170	12	.383	0.174	.047	0.001	BF1275	12	1.037	0.470	.040	0.001	BF1358-O	12	2.475	1.123	.123	0.003
BF1171	12	.354	0.161	.037	0.001	BF1276	12	1.046	0.474	.047	0.001	BF1359-SP	12	2.787	1.264	.140	0.004
BF1172	12	.609	0.276	.228	0.006	BF1277-SP	6	3.392	1.539	.168	0.005	BF1360	12	2.075	0.941	.108	0.003
BF1173	12	.225	0.102	.038	0.001	BF1277-SPS	6	3.675	1.667	.172	0.005	BF1360-O	6	1.590	0.721	.079	0.002
BF1174	12	.433	0.196	.058	0.002	BF1278	12	1.346	0.611	.065	0.002	BF1360-SP	12	2.313	1.049	.109	0.003
BF1177	12	.958	0.435	.065	0.002	BF1278-O	12	1.213	0.550	.057	0.002	BF1361	12	1.054	0.478	.046	0.001
BF1178	12	.146	0.066	.022	0.001	BF1279	12	1.508	0.684	.077	0.002	BF1362	12	1.917	0.870	.087	0.002
BF1179	12	.563	0.255	.039	0.001	BF1280	12	1.342	0.609	.070	0.002	BF1363	12	2.742	1.244	.137	0.004
BF1181	12	.346	0.157	.046	0.001	BF1281-O	12	2.450	1.111	.130	0.004	BF1365	12	1.646	0.747	.076	0.002
BF1182	12	.538	0.244	.062	0.002	BF1281	12	2.517	1.142	.139	0.004	BF1366-O	12	1.338	0.607	.060	0.002
BF1184	12	.363	0.165	.038	0.001	BF1282	12	1.321	0.599	.065	0.002	BF1367	12	1.079	0.489	.046	0.001
BF1185	12	.340	0.154	.050	0.001	BF1282-O	12	1.230	0.558	.061	0.002	OB1368	1	3.650	1.656	.142	0.004
BF1186	12	.483	0.219	.063	0.002	BF1283-O	12	2.408	1.092	.123	0.003	BF1370	12	1.917	0.870	.089	0.003
BF1191	12	.775	0.352	.061	0.002	BF1283	12	2.617	1.187	.141	0.004	BF1371	12	1.383	0.627	.076	0.002
BF1193	12	.642	0.291	.037	0.001	BF1283-SP	12	2.909	1.320	.136	0.004	BF1372	12	1.200	0.544	.046	0.001
BF1195	12	.688	0.312	.047	0.001	BF1285-SP	12	3.033	1.376	.139	0.004	BF1373-SP	12	2.321	1.053	.108	0.003
BF1199	12	.454	0.206	.060	0.002	BF1286	12	2.192	0.994	.106	0.003	BF1374-SP	12	2.517	1.142	.125	0.004
BF1201	12	.563	0.255	.065	0.002	BF1287-O	6	3.050	1.383	.227	0.006	BF1375	12	2.413	1.095	.120	0.003
BF1204	12	1.354	0.614	.069	0.002	BF1288-O	6	2.875	1.304	.183	0.005	BF1376	12	1.263	0.573	.079	0.002
BF1204-O	12	1.237	0.561	.099	0.003	BF1289-SP	12	1.992	0.904	.081	0.002	BF1377	12	2.392	1.085	.121	0.003
BF1204-SP	12	1.621	0.735	.063	0.002	PF1291	12	1.392	0.631	.133	0.004	BF1378-SPS	12	2.250	1.021	.091	0.003
BF1205	12	1.346	0.611	.066	0.002	BF1292-O	12	2.021	0.917	.091	0.003	BF1379	12	1.238	0.562	.038	0.001
BF1205-SP	12	1.596	0.724	.066	0.002	BF1293-SPS	12	2.092	0.949	.091	0.003	BF1379-O	12	.595	0.270	.028	0.001
BF1210	12	2.871	1.302	.138	0.004	BF1294-O	12	2.096	0.951	.109	0.003	BF1380	12	1.225	0.556	.037	0.001
BF1211	12	2.367	1.074	.108	0.003	BF1296-O	12	2.292	1.040	.093	0.003	BF1380-O	12	.587	0.266	.027	0.001
BF1212	12	1.438	0.652	.077	0.002	BF1297-O	12	2.692	1.221	.135	0.004	BF1381	12	1.225	0.556	.039	0.001
BF1212 FOAM	12	.246	0.112	.102	0.003	BF1298-O	12	1.967	0.892	.089	0.003	BF1381-O	12	.583	0.264	.028	0.001
BF1213	12	1.383	0.627	.077	0.002	BF1299-O	12	2.208	1.002	.110	0.003	BF1382-SP	12	2.463	1.117	.128	0.004
BF1214	12	1.329	0.603	.077	0.002	FB1301	1	1.700	0.771	.087	0.002	BF1383-O	12	2.660	1.207	.130	0.004
BF1215	12	.954	0.433	.064	0.002	FB1302	1	1.700	0.771	.092	0.003	BF1384-SP	12	1.713	0.777	.079	0.002
BF1216	6	2.917	1.323	.182	0.005	OB1303	1	2.100	0.953	.092	0.003	BF1385-SPS	12	1.983	0.899	.074	0.002
BF1217	12	1.354	0.614	.075	0.002	OB1305	1	1.250	0.567	.078	0.002	BF1386-O	12	1.537	0.697	.077	0.002
BF1218	12	2.371	1.075	.136	0.004	FB1306	1	2.050	0.930	.107	0.003	BF1387-O	12	1.996	0.905	.091	0.003
BF1219	12	1.921	0.871	.107	0.003	FB1307	1	.500	0.227	.042	0.001	BF1388-O	12	1.838	0.834	.083	0.002
BF1220	12	1.304	0.591	.068	0.002	OB1308	1	1.900	0.862	.111	0.003	BF1389-O	12	1.579	0.716	.061	0.002
BF1221	12	1.071	0.486	.046	0.001	FB1309	1	2.800	1.270	.092	0.003	BF1390-O	12	1.950	0.885	.094	0.003
BF1222	12	1.704	0.773	.076	0.002	FB1310	1	2.500	1.134	.097	0.003	BF1391-O	12	2.379	1.079	.131	0.004
BF1222-SP	12	1.863	0.845	.072	0.002	FB1311	1	.781	0.354	.043	0.001	PF1392	12	.567	0.257	.071	0.002
BF1222-O	12	1.708	0.775	.062	0.002	OB1313	1	2.000	0.907	.091	0.003	BF1392-SPS KIT	6	1.287	0.584	.131	0.004
BF1223	12	1.950	0.885	.086	0.002	OB1314	1	1.900	0.862	.093	0						

BALDWIN WEIGHTS AND VOLUMES

BALDWIN NUMBER	CASE QTY.	WEIGHT (ea.) lbs.	WEIGHT (ea.) kgs.	Volume (ea.) ft ³	Volume (ea.) m ³	BALDWIN NUMBER	CASE QTY.	WEIGHT (ea.) lbs.	WEIGHT (ea.) kgs.	Volume (ea.) ft ³	Volume (ea.) m ³	BALDWIN NUMBER	CASE QTY.	WEIGHT (ea.) lbs.	WEIGHT (ea.) kgs.	Volume (ea.) ft ³	Volume (ea.) m ³
BF1396	12	1.290	0.585	.043	0.001	PA1626	1	5.450	2.472	.987	0.028	PA1702	1	8.100	3.674	1.640	0.046
BF1397-SP	12	2.629	1.193	.124	0.004	LL1626-2	1	7.100	3.221	.987	0.028	PA1702 FOAM	6	408	0.185	.268	0.008
BF1398-O	12	1.430	0.649	.067	0.002	PA1626-2	1	6.300	2.858	1.091	0.031	PA1703	1	4.900	2.223	.869	0.025
BF1399-SP	12	2.296	1.041	.101	0.003	PA1627	6	542	0.246	.106	0.003	PA1704	12	.179	0.081	.012	**
B1400	12	513	0.233	.028	0.001	PA1629-S	1	8.250	3.742	1.527	0.043	PA1705-2	1	5.400	2.449	1.082	0.031
B1402	12	563	0.255	.027	0.001	PA1630	1	8.200	3.720	1.939	0.055	PA1706	1	9.400	4.264	1.939	0.055
BD1403	6	3.450	1.565	.151	0.004	LL1630-2	1	9.550	4.332	1.939	0.055	PA1707-FN	1	2.300	1.043	.395	0.011
B1405	12	679	0.308	.027	0.001	PA1630-2	1	9.350	4.241	1.939	0.055	PA1709	1	3.250	1.474	.421	0.012
B1406	12	546	0.248	.033	0.001	PA1631-S	1	10.050	4.559	2.352	0.067	PA1710	1	2.650	1.202	.321	0.009
B1407	12	725	0.329	.032	0.001	PA1632	42	12.400	5.625	2.854	0.081	PA1712	6	442	0.200	.039	0.001
B1410	12	629	0.285	.032	0.001	PA1633	6	1.125	0.510	.156	0.004	PA1718	6	850	0.386	.116	0.003
B1413	12	663	0.301	.033	0.001	LL1634	1	7.150	3.243	1.163	0.033	PA1719	6	1.275	0.578	.185	0.005
B1416	12	779	0.353	.036	0.001	PA1634	1	5.260	2.386	1.152	0.033	PA1721	6	1.258	0.571	.151	0.004
P1418	12	467	0.212	.047	0.001	PA1634XP	1	5.260	2.386	1.076	0.030	PA1726	1	2.800	1.270	.456	0.013
P1419	12	283	0.128	.049	0.001	PA1635	1	1.600	0.726	.289	0.008	PA1735	6	1.408	0.639	.247	0.007
B1421	12	679	0.308	.027	0.001	LL1636-FN	1	4.200	1.905	.780	0.022	PA1748	12	463	0.210	.082	0.002
B1422	12	671	0.304	.026	0.001	PA1636-FN	1	3.900	1.769	.784	0.022	PA1749-FN	1	4.250	1.928	.869	0.025
B1425	12	679	0.308	.027	0.001	LL1637-FN	1	7.550	3.425	1.686	0.048	PA1750-FN	1	4.700	2.132	.916	0.026
B1428	12	1.250	0.567	.059	0.002	PA1637-FN	1	7.000	3.175	1.686	0.048	PA1752-FN	1	1.950	0.885	.349	0.010
B1429	12	1.150	0.522	.040	0.001	PA1639	6	575	0.261	.092	0.003	PA1753-FN	1	2.600	1.179	.520	0.015
B1430	12	712	0.323	.037	0.001	PA1641	1	6.100	2.767	1.127	0.032	PA1754	1	4.200	1.905	.683	0.019
B1431	12	575	0.261	.032	0.001	LL1642-2	1	8.050	3.651	1.315	0.037	PA1755-FN	1	4.300	1.950	.976	0.028
B1432	12	704	0.319	.034	0.001	PA1642-2	1	7.350	3.334	1.314	0.037	PA1757	12	338	0.153	.038	0.001
P1433	12	1.142	0.064	.019	0.001	PA1643	1	8.350	3.788	1.939	0.055	PA1758	6	2.125	0.964	.531	0.015
B1434	12	1.033	0.469	.051	0.001	PA1644	1	1.050	0.476	.129	0.004	PA1763	12	167	0.076	.021	0.001
B1435	12	958	0.435	.035	0.001	F1645-DS	12	1.963	0.890	.229	0.006	PA1765	1	8.400	3.810	1.003	0.028
B1438	12	1.004	0.455	.051	0.001	V1645-C	7	1.630	0.739	.211	0.006	PA1765 FOAM	12	288	0.131	.257	0.007
P1440	12	1.179	0.081	.034	0.001	PA1646	1	4.550	2.064	.784	0.022	PA1768	1	8.450	3.833	1.477	0.042
B1441	12	1.379	0.626	.060	0.002	LL1646-FN	1	4.950	2.245	.916	0.026	PA1769	1	2.700	1.225	.520	0.015
P1443	12	233	0.106	.048	0.001	PA1646-FN	1	4.500	2.041	.916	0.026	PA1771	1	1.400	0.635	.220	0.006
B1444	12	608	0.276	.028	0.001	PA1647	1	2.950	1.338	.487	0.014	PA1772	1	2.100	0.953	.303	0.009
B1446	12	1.179	0.535	.050	0.001	PA1648	6	883	0.401	.113	0.003	PA1773	1	2.700	1.225	.417	0.012
B1447	12	708	0.321	.028	0.001	LL1649	1	11.250	5.103	2.153	0.061	PA1774	1	3.550	1.610	.493	0.014
P1510	4	4.525	2.053	.809	0.023	PA1649	1	10.300	4.672	2.156	0.061	PA1775	1	3.600	1.633	.537	0.015
P1511	4	4.938	2.240	.916	0.026	PA1650-FN	1	5.250	2.381	1.214	0.034	PA1776	1	4.850	2.200	.612	0.017
V1520-R	4	5.038	2.285	.908	0.026	PA1653	1	1.500	0.680	.261	0.007	PA1777	1	4.950	2.245	.713	0.020
V1542-C	6	1.350	0.612	.219	0.006	V1656-O	6	1.667	0.756	.218	0.006	PA1778	1	5.600	2.540	.759	0.021
V1544-T	16	1.275	0.578	.163	0.005	V1656-T	6	1.825	0.828	.221	0.006	PA1779	1	6.500	2.948	.899	0.025
V1560	4	5.012	2.273	.908	0.026	PA1657	6	1.267	0.575	.243	0.007	PA1780	1	6.300	2.858	.910	0.026
P1561	1	7.950	3.606	.496	0.014	PA1661(3)	6	.942	0.427	.139	0.004	PA1781	1	8.800	3.992	1.145	0.032
P1562	1	14.750	6.691	.906	0.026	PA1663	1	6.350	2.880	1.050	0.030	PA1782	1	11.150	5.058	1.441	0.041
P1563	1	2.500	1.134	.178	0.005	PA1664	1	2.100	0.953	.291	0.008	PA1783	1	12.850	5.829	1.631	0.046
P1565	1	450	0.204	.050	0.001	PA1666	12	338	0.153	.039	0.001	PA1784	1	17.300	7.847	2.143	0.061
P1566	1	450	0.204	.044	0.001	LL1667-FN	1	2.150	0.975	.349	0.010	PA1786	6	2.108	0.956	.525	0.015
P1567	1	6.100	2.767	.477	0.013	PA1667-FN	1	2.050	0.930	.349	0.010	PA1787	1	2.050	0.930	.282	0.008
P1568	1	11.250	5.103	.726	0.021	LL1669	1	8.350	3.788	1.408	0.040	PA1788	1	3.950	1.792	.557	0.016
P1575	1	800	0.363	.050	0.001	PA1669	1	7.950	3.606	1.408	0.040	PA1789	1	5.450	2.472	.756	0.021
P1577	1	1.300	0.590	.095	0.003	PA1670	1	4.900	2.223	.910	0.026	PA1790	1	7.200	3.266	1.315	0.037
PF1584	1	12.650	5.738	.987	0.028	PA1673	1	4.050	1.837	.520	0.015	PA1794-FN	1	2.800	1.270	.554	0.016
PF1585	1	2.100	0.953	.164	0.005	PA1674	1	2.500	1.134	.352	0.010	PA1795	1	3.250	1.474	.779	0.022
PF1587	1	1.100	0.499	.057	0.002	PA1675	1	4.600	2.087	.839	0.024	PA1797	1	5.400	2.449	1.560	0.044
PA1600	12	.050	0.023	.012	**	LL1676-FN	1	9.250	4.196	2.499	0.071	PA1798	6	2.642	1.198	.753	0.021
PA1602	1	2.000	0.907	.288	0.008	PA1676-FN	1	8.400	3.810	2.499	0.071	PA1800	6	2.667	1.210	.762	0.022
PA1603	12	.279	0.127	.039	0.001	PA1679	12	.479	0.217	.052	0.001	PA1802	6	1.400	0.635	.257	0.007
PA1606	1	3.250	1.474	.652	0.018	PA1680	6	1.034	0.469	.230	0.007	PA1805	6	.758	0.344	.104	0.003
PA1607	1	4.200	1.905	.869	0.025	LL1681-FN	1	3.050	1.383	.512	0.014	PA1806	1	5.450	2.472	.740	0.021
LL1608	1	2.550	1.157	.291	0.008	PA1681-FN	1	2.850	1.293	.512	0.014	PA1809	4	.575	0.261	.087	0.002
PA1608	1	2.300	1.043	.288	0.008	PA1682	1	2.500	1.134	.288	0.008	PA1810	1	4.950	2.245	.869	0.025
PA1609	1	3.000	1.361	.395	0.011	PA1683	1	1.650	0.748	.233	0.007	PA1814	6	.775	0.352	.117	0.003
PA1610	1	3.900	1.769	.464	0.013	PA1684	1	1.850	0.839	.239	0.007	PA1815	1	12.700	5.761	2.854	0.081
PA1613	1	3.200	1.452	.429	0.012	PA1686	1	3.750	1.701	.650	0.018	PA1816	1	8.550	3.878	1.432	0.041
PA1613-S	1	3.150	1.429	.429	0.012	PA1687	1	10.600	4.808	2.156	0.061	PA1817	1	3.350	1.520	.652	0.018
LL1614	1	3.800	1.724	.520	0.015	PA1688	12	.413	0.187	.065	0.002	PA1818	1	10.200	4.627	1.939	0.055
PA1614	1	3.300	1.497	.527	0.015	PA1689	1	2.000	0.907	.361	0.010	PA1819	1	4.100	1.860	1.163	0.033
LL1615	1	5.050	2.291	.736	0.021	LL1690-FN	1	1.350	0.612	.209	0.006	PA1821	1	1.350	0.612	.173	0.005
PA1615	1	4.700	2.132	.737	0.021	PA1690-FN	1	1.400	0.635	.207	0.006	PA1822-FN	1	3.250	1.474	.617	0.017
PA1615XP	1	5.100	2.313	.766	0.022	PA1692	1	2.800	1.270	.464	0.013	PA1823	1	8.150	3.697	1.473	0.042
PA1618	1	3.200	1.452	.399	0.011	PA1696	6	.575	0.261	.109	0.003	PA1824	1	6.100	2.767	1.045	0.030
PA1619	1	3.500	1.588	.404	0.011	PA1697	6	.442	0.200	.059	0.002	PA1825	1	3.100	1.406	.853	0.024
PA1620	1	4.350	1.973	.652	0.018	PA1698	1	1.600	0.726	.215	0.006	PA1826	1	2.850	1.293	.650	0.018
PA1620-S	1	4.350	1.973	.656	0.019	PA1699-FN	1	3.100	1.406	.617	0.017	PA1827	1	5.500	2.495	.949	0.027
PA1621	1	4.1															

BALDWIN WEIGHTS AND VOLUMES

BALDWIN NUMBER	CASE QTY.	WEIGHT (ea.) lbs.	WEIGHT (ea.) kgs.	Volume (ea.) ft ³	Volume (ea.) m ³	BALDWIN NUMBER	CASE QTY.	WEIGHT (ea.) lbs.	WEIGHT (ea.) kgs.	Volume (ea.) ft ³	Volume (ea.) m ³	BALDWIN NUMBER	CASE QTY.	WEIGHT (ea.) lbs.	WEIGHT (ea.) kgs.	Volume (ea.) ft ³	Volume (ea.) m ³
PA1834	6	.333	0.151	.051	0.001	PA1922-FN	1	4.250	1.928	.750	0.021	PA2069	6	.750	0.340	.117	0.003
PA1836	1	1.800	0.816	.288	0.008	PA1926	1	3.100	1.406	.486	0.014	PA2069 FOAM	12	.001	**	.016	**
PA1837-FN	1	4.500	2.041	1.308	0.037	PA1932	1	4.750	2.155	.736	0.021	PA2070	6	.383	0.174	.036	0.001
PA1840	1	4.450	2.019	.554	0.016	PA1934	4	2.638	1.197	.647	0.018	PA2071	6	.533	0.242	.106	0.003
PA1841	6	1.517	0.688	.342	0.010	PA1936	1	14.300	6.486	2.897	0.082	PA2072	6	.750	0.340	.097	0.003
PA1845	1	5.900	2.676	.942	0.027	PA1937	1	4.600	2.087	.935	0.026	PA2073	6	2.433	1.104	.527	0.015
LL1846	1	10.600	4.808	1.830	0.052	PA1940	1	3.500	1.588	.456	0.013	PA2074	6	1.292	0.586	.257	0.007
PA1846	1	9.200	4.173	1.830	0.052	PA1941-FN	1	5.400	2.449	1.163	0.033	PA2075	6	2.067	0.938	.257	0.007
PA1846XP	1	7.900	3.583	1.922	0.054	PA1945	1	2.000	0.907	.235	0.007	PA2076	6	1.375	0.624	.353	0.010
PA1847-FN	1	9.950	4.513	3.137	0.089	PA1946	6	.667	0.303	.103	0.003	PA2077	6	.984	0.446	.230	0.007
PA1848	1	4.100	1.860	.736	0.021	PA1949	6	2.125	0.964	.435	0.012	PA2079	6	2.325	1.055	.527	0.015
PA1849	1	3.150	1.429	.487	0.014	PA1951	6	.967	0.439	.113	0.003	PA2081	6	1.858	0.843	.358	0.010
PA1850-FN	1	3.400	1.542	.853	0.024	PA1952	1	14.050	6.373	2.447	0.069	PA2083	6	.592	0.269	.103	0.003
PA1851	1	3.500	1.588	.520	0.015	PA1953	1	12.600	5.715	2.039	0.058	SA2084	12	.121	0.055	.038	0.001
PA1852	6	1.034	0.469	.217	0.006	PA1956-FN	1	6.300	2.858	1.527	0.043	SA2085	12	.179	0.081	.038	0.001
PA1857	6	.975	0.442	.146	0.004	PA1957	1	2.150	0.975	.429	0.012	PA2091	6	2.550	1.157	.524	0.015
PA1858	6	.558	0.253	.080	0.002	PA1960	1	3.600	1.633	.461	0.013	PA2092	6	2.392	1.085	.547	0.015
PA1859	6	.408	0.185	.053	0.001	PA1961	1	4.050	1.837	.462	0.013	PA2093	1	1.950	0.885	.780	0.022
PA1860	6	1.683	0.763	.440	0.012	PA1963	6	1.633	0.741	.209	0.006	PA2094	6	2.450	1.111	.613	0.017
PA1861	6	2.175	0.987	.267	0.008	PA1967	1	1.500	0.680	.233	0.007	PA2095	4	1.638	0.743	.320	0.009
PA1863	1	8.000	3.629	1.521	0.043	PA1969	6	.725	0.329	.137	0.004	PA2096	6	.625	0.284	.106	0.003
PA1864-FN	1	7.850	3.561	2.156	0.061	PA1972	1	4.050	1.837	.456	0.013	PA2099	6	1.158	0.525	.137	0.004
PA1865-FN	1	.800	0.363	.100	0.003	PA1973	6	.933	0.423	.103	0.003	PA2100	6	1.392	0.631	.295	0.008
PA1866	1	3.900	1.769	.652	0.018	PA1975	1	12.000	5.443	2.722	0.077	PA2101A	6	.550	0.249	.113	0.003
PA1867	1	4.300	1.950	.652	0.018	PA1976	1	5.050	2.291	1.071	0.030	PA2102	6	1.350	0.612	.325	0.009
PA1868	1	2.250	1.021	.344	0.010	PA1977-FN	1	6.550	2.971	1.432	0.041	PA2103	6	.475	0.215	.069	0.002
PA1873	4	1.700	0.771	.386	0.011	PA1978-FN	1	7.600	3.447	1.939	0.055	PA2104	6	.483	0.219	.061	0.002
V1874-T	4	3.475	1.576	.540	0.015	PA1979-FN	1	7.850	3.561	2.178	0.062	PA2106	6	1.117	0.507	.230	0.007
PA1875	12	.375	0.170	.060	0.002	PA1980-FN	1	7.400	3.357	1.737	0.049	PA2107	6	1.025	0.465	.185	0.005
PA1877	1	7.500	3.402	1.315	0.037	PA1981	1	1.850	0.839	.339	0.010	PA2109	6	.983	0.446	.236	0.007
PA1880	1	3.700	1.678	.853	0.024	PA1982	1	1.650	0.748	.235	0.007	PA2110	6	2.325	1.055	.425	0.012
PA1881	1	6.500	2.948	1.163	0.033	PA1985	12	.346	0.157	.034	0.001	PA2113	6	1.092	0.495	.230	0.007
PA1882	1	2.500	1.134	.321	0.009	PA1986	1	4.150	1.882	.554	0.016	PA2114	6	1.075	0.488	.148	0.004
PA1883-FN	1	2.400	1.089	.486	0.014	PA1986-K	1	8.300	3.765	1.050	0.030	PA2115	6	2.808	1.274	.666	0.019
LL1884	1	5.400	2.449	.842	0.024	PA1987	1	3.950	1.792	.554	0.016	PA2116	4	3.100	1.406	.667	0.019
PA1884	1	5.100	2.313	.839	0.024	PA1989-FN	1	4.200	1.905	1.164	0.033	PA2117	6	1.400	0.635	.230	0.007
PA1884XP	1	5.600	2.540	.868	0.025	LL1992	1	9.150	4.150	1.640	0.046	PA2121	6	1.075	0.488	.124	0.004
LL1885	1	8.100	3.674	1.409	0.040	PA1992-FN	1	9.350	4.241	3.136	0.089	PA2124	6	1.792	0.813	.353	0.010
PA1885	1	7.400	3.357	1.408	0.040	PA1995	1	8.550	3.878	1.126	0.032	PA2125	6	1.250	0.567	.210	0.006
PA1885XP	1	8.200	3.720	1.442	0.041	PA1996	1	1.950	0.885	.213	0.006	PA2127	6	.592	0.269	.095	0.003
LL1886	1	9.450	4.287	1.640	0.046	PA1997	1	5.800	2.631	.910	0.026	PA2134	6	.992	0.450	.158	0.004
PA1886	1	8.300	3.765	1.640	0.046	PA1998	1	1.450	0.658	.316	0.009	PA2135	6	.583	0.264	.100	0.003
PA1886XP	1	8.300	3.765	1.519	0.043	PA2001	6	1.025	0.465	.154	0.004	PA2136	6	1.108	0.503	.258	0.007
PA1888	6	1.833	0.831	.437	0.012	PA2001 FOAM	12	.067	0.030	.041	0.001	PA2138	6	.583	0.264	.135	0.004
PA1889	6	1.625	0.737	.212	0.006	PA2002	6	1.967	0.892	.542	0.015	PA2139	6	.992	0.450	.152	0.004
PA1891	6	1.167	0.529	.194	0.005	PA2005	6	1.492	0.677	.257	0.007	PA2139 FOAM	12	.067	0.030	.042	0.001
PA1892-FN	1	5.900	2.676	1.432	0.041	PA2006	6	1.858	0.843	.365	0.010	PA2140	6	.908	0.412	.149	0.004
PA1893	1	3.100	1.406	.856	0.024	PA2007	6	1.459	0.662	.257	0.007	PA2147	6	1.850	0.839	.230	0.007
LL1894	1	12.000	5.443	2.232	0.063	PA2008	6	1.792	0.813	.357	0.010	PA2148	6	2.392	1.085	.749	0.021
PA1894	1	10.800	4.899	2.232	0.063	PA2009	6	1.667	0.756	.529	0.015	PA2149	6	1.000	0.454	.151	0.004
PA1894XP	1	11.500	5.216	2.292	0.065	PA2010	6	1.758	0.797	.531	0.015	PA2150	6	.617	0.280	.073	0.002
LL1895	1	6.450	2.926	1.214	0.034	PA2023	6	.700	0.318	.105	0.003	PA2152	6	.917	0.416	.124	0.004
PA1895	1	6.000	2.722	1.214	0.034	PA2024	6	1.858	0.843	.430	0.012	PA2153	6	.767	0.348	.109	0.003
PA1896	1	7.500	3.402	1.432	0.041	SA2027	12	.125	0.057	.038	0.001	PA2154	6	1.392	0.631	.246	0.007
PA1897	1	1.500	0.680	.315	0.009	PA2031	6	1.367	0.620	.211	0.006	PA2156	6	1.783	0.809	.438	0.012
PA1898	1	3.650	1.656	.617	0.017	PA2036	6	.642	0.291	.097	0.003	PA2158	6	.867	0.393	.153	0.004
PA1899	1	1.550	0.703	.239	0.007	PA2037	6	1.159	0.526	.185	0.005	SA2159	12	.154	0.070	.038	0.001
PA1900	1	3.250	1.474	.487	0.014	PA2038	1	.800	0.363	.081	0.002	PA2160	6	.592	0.269	.072	0.002
PA1901	1	1.300	0.590	.233	0.007	SA2039	12	.137	0.062	.038	0.001	PA2162	6	.867	0.393	.153	0.004
LL1902-FN	1	4.850	2.200	1.133	0.032	PA2041	6	.950	0.431	.218	0.006	PA2163	6	.967	0.439	.125	0.004
PA1902-FN	1	4.650	2.109	1.048	0.030	PA2042	4	2.625	1.191	.553	0.016	PA2164	6	.867	0.393	.116	0.003
PA1904	1	3.400	1.542	.617	0.017	PA2044	6	.908	0.412	.159	0.004	PA2167	6	1.692	0.767	.207	0.006
PA1905	1	4.400	1.996	.856	0.024	SA2047	12	.167	0.076	.037	0.001	PA2168	6	1.017	0.461	.107	0.003
PA1906	1	2.050	0.930	.321	0.009	PA2050	6	.642	0.291	.120	0.003	PA2169	6	.933	0.423	.100	0.003
PA1907-FN	1	1.350	0.612	.196	0.006	PA2051	6	1.542	0.699	.353	0.010	PA2171	6	.775	0.352	.192	0.005
PA1909	12	.213	0.097	.039	0.001	PA2052	6	1.592	0.722	.342	0.010	PA2178	6	1.283	0.582	.169	0.005
PA1911	1	1.850	0.839	.484	0.014	PA2053	6	.717	0.325	.103	0.003	PA2181	6	.675	0.306	.107	0.003
PA1912	1	2.050	0.930	.462	0.013	PA2061	6	2.750	1.247	.732	0.021	PA2182	1	1.150	0.522	.174	0.005
PA1913	1	5.250	2.381	.869	0.025	PA2063	6	.908	0.412	.222	0.006	PA2183	1	3.500	1.588	.520	0.015
PA1915	12	.213	0.097	.034	0.001	PA2064	6	.850	0.386	.157	0.004	PA2188	6	1.742	0.790	.342	0.010
PA1916	1	2.550	1.157	.432	0.012	PA2065	6	2.225	1.009	.529	0.015	PA2189	6	.983	0.446	.122	0.003
PA1919-FN	1	3.750	1.701	.780	0.022	PA2067	6										

BALDWIN WEIGHTS AND VOLUMES

BALDWIN NUMBER	CASE QTY.	WEIGHT (ea.)		Volume (ea.)		BALDWIN NUMBER	CASE QTY.	WEIGHT (ea.)		Volume (ea.)		BALDWIN NUMBER	CASE QTY.	WEIGHT (ea.)		Volume (ea.)	
		lbs.	kgs.	ft ³	m ³			lbs.	kgs.	ft ³	m ³			lbs.	kgs.	ft ³	m ³
PA2200	6	.767	0.348	.097	0.003	PA2343	1	8.500	3.856	1.126	0.032	PA2414	1	7.500	3.402	1.315	0.037
PA2204	6	.590	0.268	.090	0.003	LL2344-FN	1	1.800	0.816	.315	0.009	PA2415	1	2.900	1.315	.512	0.014
PA2208	6	.658	0.298	.151	0.004	PA2344-FN	1	1.700	0.771	.317	0.009	PA2417-FN	1	9.050	4.105	1.686	0.048
PA2212	6	.833	0.378	.131	0.004	PA2345	1	9.000	4.082	2.039	0.058	LL2418-FN	1	3.500	1.588	.650	0.018
PA2214	6	.892	0.405	.127	0.004	PA2346	1	3.450	1.565	.824	0.023	PA2418-FN	1	3.150	1.429	.654	0.019
PA2215	1	1.100	0.499	.212	0.006	PA2347	6	.892	0.405	.100	0.003	PA2419	1	.900	0.408	.277	0.008
PA2216	6	.558	0.253	.152	0.004	PA2349-FN	1	8.750	3.969	1.737	0.049	PA2420	1	2.850	1.293	.421	0.012
PA2218	6	.950	0.431	.082	0.002	PA2350	1	11.250	5.103	1.396	0.040	PA2421	1	4.850	2.200	.736	0.021
PA2220	6	.892	0.405	.202	0.006	PA2351	1	3.450	1.565	.512	0.014	PA2422	1	2.350	1.066	.292	0.008
PA2221	6	.700	0.318	.127	0.004	PA2352	1	3.950	1.792	.392	0.011	PA2423	1	3.300	1.497	.395	0.011
PA2222	6	.217	0.098	.038	0.001	PA2353	1	3.800	1.724	.407	0.012	LL2425	1	7.250	3.289	1.214	0.034
PA2223	6	.517	0.235	.075	0.002	PA2354	1	2.750	1.247	.455	0.013	PA2425	1	6.850	3.107	1.214	0.034
PA2223 FOAM	12	.020	0.009	.017	**	PA2356	1	3.050	1.383	.419	0.012	LL2426-FN	1	4.250	1.928	.949	0.027
PA2224	6	.425	0.193	.049	0.001	PA2357	1	12.700	5.761	2.897	0.082	PA2426-FN	1	3.900	1.769	.949	0.027
PA2225	6	.292	0.132	.040	0.001	LL2358	1	7.450	3.379	1.163	0.033	PA2427	1	1.500	0.680	.294	0.008
PA2226	6	.625	0.284	.093	0.003	PA2358	1	7.000	3.175	1.163	0.033	PA2428	1	11.500	5.216	1.830	0.052
PA2228	6	.725	0.329	.179	0.005	PA2359	1	4.150	1.882	1.163	0.033	PA2429	1	10.550	4.785	1.640	0.046
PA2230	6	.717	0.325	.125	0.004	LL2360-FN	1	2.650	1.202	.460	0.013	PA2430	1	8.050	3.651	1.540	0.044
PA2231	6	.650	0.295	.089	0.003	PA2360-FN	1	2.500	1.134	.460	0.013	PA2431	1	3.650	1.656	.617	0.017
PA2232	6	1.470	0.667	.213	0.006	LL2361	1	12.100	5.489	2.610	0.074	PA2432	1	1.150	0.522	.175	0.005
PA2233	6	3.058	1.387	.568	0.016	PA2361	1	10.600	4.808	2.610	0.074	PA2433	1	5.250	2.381	1.640	0.046
PA2234	6	1.175	0.533	.162	0.005	PA2361XP	1	10.850	4.922	2.561	0.072	PA2434	1	6.000	2.722	1.214	0.034
PA2235	6	1.100	0.499	.219	0.006	PA2362	1	4.200	1.905	.824	0.023	PA2435	1	2.400	1.089	.421	0.012
PA2237	6	.758	0.344	.105	0.003	LL2363	1	25.950	11.771	5.278	0.149	PA2436	1	3.900	1.769	.473	0.013
PA2240	6	.792	0.359	.304	0.009	PA2363	1	23.850	10.818	5.285	0.150	PA2437	1	10.000	4.536	2.232	0.063
PA2241	1	1.850	0.839	.695	0.020	PA2363XP	1	25.750	11.680	5.160	0.146	PA2438	1	6.050	2.744	.990	0.028
PA2243	6	.850	0.386	.106	0.003	PA2364	1	8.050	3.651	1.937	0.055	LL2439	1	9.950	4.513	1.617	0.046
PA2244	6	1.033	0.469	.216	0.006	PA2367	1	6.450	2.926	1.269	0.036	PA2439	1	9.000	4.082	1.617	0.046
PA2256	6	.408	0.185	.025	0.001	PA2368	1	2.100	0.953	.407	0.012	PA2440	1	4.100	1.860	.484	0.014
PA2257	6	.808	0.367	.093	0.003	PA2369	1	4.300	1.950	.615	0.017	PA2442	1	7.350	3.334	1.473	0.042
PA2258	6	.317	0.144	.062	0.002	PA2370	1	1.150	0.522	.146	0.004	PA2443	1	2.150	0.975	.342	0.010
PA2260	1	1.750	0.794	.321	0.009	PA2371	1	5.900	2.676	.869	0.025	PA2444	1	15.520	7.040	1.994	0.056
PA2300	1	7.000	3.175	1.408	0.040	PA2372	1	1.950	0.885	.344	0.010	PA2445	1	9.150	4.150	1.432	0.041
PA2301	1	2.400	1.089	.395	0.011	PA2374	1	6.850	3.107	.942	0.027	PA2446	1	2.300	1.043	.434	0.012
PA2302-FN	1	3.700	1.678	.839	0.024	PA2375	1	11.600	5.262	1.457	0.041	LL2447-FN	1	10.500	4.763	2.499	0.071
PA2303	1	1.600	0.726	.239	0.007	PA2376	1	8.650	3.924	2.007	0.057	PA2447-FN	1	9.750	4.423	2.499	0.071
PA2304-FN	1	4.300	1.950	.869	0.025	PA2377	1	8.000	3.629	1.540	0.044	PA2448	1	3.400	1.542	.417	0.012
PA2305	1	1.200	0.544	.239	0.007	PA2378	1	2.450	1.111	.527	0.015	PA2450	1	6.000	2.722	.658	0.019
PA2306	4	1.412	0.640	.201	0.006	PA2379	1	5.000	2.268	.780	0.022	PA2451	1	5.550	2.517	.949	0.027
PA2307	1	3.500	1.588	.617	0.017	PA2379-K	1	6.850	3.107	.987	0.028	PA2452	1	2.100	0.953	.421	0.012
PA2308	4	1.838	0.834	.324	0.009	PA2380-FN	1	2.300	1.043	.486	0.014	LL2453	1	25.700	11.658	4.991	0.141
PA2310	1	4.000	1.814	.767	0.022	PA2381	1	.800	0.363	.146	0.004	PA2453	1	25.000	11.340	4.991	0.141
LL2312	1	9.350	4.241	1.614	0.046	PA2382	1	7.400	3.357	1.473	0.042	PA2453XP	1	25.350	11.499	5.085	0.144
PA2312	1	8.800	3.992	1.614	0.046	PA2383	1	2.100	0.953	.320	0.009	PA2454	1	8.200	3.720	2.447	0.069
PA2313	1	8.150	3.697	2.017	0.057	LL2384	1	8.600	3.901	1.521	0.043	PA2455	1	2.850	1.293	.617	0.017
PA2314	1	3.350	1.520	.460	0.013	PA2384	1	7.750	3.515	1.553	0.044	LL2456	1	12.050	5.466	2.717	0.077
PA2315	1	7.650	3.470	1.492	0.042	PA2384XP	1	8.150	3.697	1.424	0.040	PA2456	1	11.000	4.990	2.881	0.082
PA2316	1	9.100	4.128	1.521	0.043	PA2385	1	6.700	3.039	1.299	0.037	PA2456XP	1	11.850	5.375	2.788	0.079
LL2317	1	12.850	5.829	2.447	0.069	PA2386	1	8.400	3.810	2.039	0.058	PA2457	1	4.650	2.109	1.288	0.036
PA2317	1	11.200	5.080	2.447	0.069	PA2387	1	7.600	3.447	2.039	0.058	LL2458	1	21.450	9.730	3.406	0.096
LL2318	1	5.300	2.404	.949	0.027	PA2388	1	2.850	1.293	.532	0.015	PA2458	1	18.150	8.233	3.406	0.096
PA2318	1	5.200	2.359	.949	0.027	PA2389-FN	1	11.100	5.035	2.269	0.064	PA2459	1	6.200	2.812	1.214	0.034
PA2319	1	1.550	0.703	.239	0.007	PA2390	1	25.500	11.567	4.817	0.136	PA2460	1	2.300	1.043	.395	0.011
PA2320-FN	1	2.950	1.338	.617	0.017	PA2391	1	2.250	1.021	.321	0.009	PA2461	1	8.750	3.969	1.540	0.044
PA2321	1	.900	0.408	.142	0.004	PA2392	1	3.150	1.429	.486	0.014	PA2462	1	2.750	1.247	.532	0.015
PA2322	1	2.250	1.021	.288	0.008	LL2393	1	15.150	6.872	4.491	0.127	PA2463	1	3.650	1.656	.421	0.012
PA2323	1	1.250	0.567	.135	0.004	PA2393	1	14.550	6.600	4.559	0.129	PA2464	1	5.350	2.427	.602	0.017
LL2326	1	9.500	4.309	2.292	0.065	PA2394	1	17.500	7.938	3.773	0.107	PA2465	1	5.350	2.427	.780	0.022
PA2326	1	8.250	3.742	2.260	0.064	PA2395	1	20.900	9.480	3.908	0.111	PA2466	1	6.300	2.858	1.045	0.030
PA2326XP	1	9.100	4.128	2.276	0.064	PA2396	1	10.200	4.627	2.722	0.077	PA2467	1	2.450	1.111	.421	0.012
PA2328	1	3.550	1.610	1.050	0.030	PA2397	1	3.550	1.610	.853	0.024	PA2468	1	13.350	6.056	2.232	0.063
PA2329	1	4.450	2.019	.509	0.014	PA2398	1	10.650	4.831	2.201	0.062	PA2469	1	1.500	0.680	.301	0.009
LL2330	1	8.450	3.833	1.606	0.045	PA2399	1	14.600	6.623	1.630	0.046	PA2472	6	2.917	1.323	.741	0.021
PA2330	1	7.450	3.379	1.618	0.046	PA2401	1	3.950	1.792	.767	0.022	PA2473	1	6.000	2.722	.987	0.028
PA2331	1	1.750	0.794	.233	0.007	PA2402	1	1.750	0.794	.321	0.009	PA2474	1	5.350	2.427	.949	0.027
PA2332	1	1.050	0.476	.189	0.005	PA2403	1	7.000	3.175	1.126	0.032	PA2475	1	7.550	3.425	1.244	0.035
LL2333	1	16.450	7.462	3.136	0.089	PA2404	1	1.800	0.816	.213	0.006	PA2476	6	.375	0.170	.060	0.002
PA2333	1	13.100	5.942	3.136	0.089	PA2405	1	4.400	1.996	.615	0.017	PA2477	6	.683	0.310	.101	0.003
PA2335	6	.583	0.264	.087	0.002	PA2407	1	3.950	1.792	.446	0.013	PA2478	1	11.950	5.421	3.136	0.089
PA2337	6	3.217	1.459	.527	0.015	PA2408	1	4.100	1.860	.437	0.012	PA2479	1	2.150	0.975	.229	0.006
PA2338-FN	1	4.7															

BALDWIN WEIGHTS AND VOLUMES

BALDWIN NUMBER	CASE QTY.	WEIGHT (ea.) lbs.	WEIGHT (ea.) kgs.	Volume (ea.) ft ³	Volume (ea.) m ³	BALDWIN NUMBER	CASE QTY.	WEIGHT (ea.) lbs.	WEIGHT (ea.) kgs.	Volume (ea.) ft ³	Volume (ea.) m ³	BALDWIN NUMBER	CASE QTY.	WEIGHT (ea.) lbs.	WEIGHT (ea.) kgs.	Volume (ea.) ft ³	Volume (ea.) m ³
PA2486	1	2.050	0.930	.288	0.008	PA2559	1	15.700	7.122	3.362	0.095	PA2634	1	1.300	0.590	.227	0.006
PA2487	1	.600	0.272	.162	0.005	LL2562	1	15.550	7.053	3.362	0.095	PA2635-FN	1	3.950	1.792	.796	0.023
PA2488-FN	1	2.200	0.998	.344	0.010	PA2562	1	13.750	6.237	3.362	0.095	PA2636	1	1.350	0.612	.262	0.007
PA2489	1	.650	0.295	.087	0.002	PA2562XP	1	15.500	7.031	3.372	0.095	PA2637	1	3.150	1.429	.456	0.013
PA2490	1	11.900	5.398	2.532	0.072	PA2563	1	6.050	2.744	1.614	0.046	PA2638	1	4.650	2.109	.438	0.012
PA2491	1	3.850	1.746	.827	0.023	PA2564	1	15.700	7.122	2.059	0.058	PA2640	1	9.150	4.150	2.039	0.058
LL2493	1	11.200	5.080	2.092	0.059	PA2566	1	5.000	2.268	.780	0.022	PA2641	1	5.750	2.608	.949	0.027
PA2493	1	10.200	4.627	2.092	0.059	PA2567	1	5.600	2.540	.910	0.026	LL2642	1	10.350	4.695	1.432	0.041
PA2494	1	8.700	3.946	1.617	0.046	PA2568	1	2.100	0.953	.339	0.010	PA2642	1	9.500	4.309	1.432	0.041
PA2495	1	5.050	2.291	.910	0.026	PA2569	1	6.200	2.812	1.640	0.046	PA2643	1	9.350	4.241	1.640	0.046
PA2496	1	2.200	0.998	.235	0.007	PA2570	1	.950	0.431	.140	0.004	PA2644	1	1.000	0.454	.182	0.005
PA2497	1	1.950	0.885	.235	0.007	PA2571	1	9.400	4.264	2.232	0.063	PA2645	1	4.200	1.905	.767	0.022
PA2498	1	5.800	2.631	.486	0.014	PA2572	1	3.500	1.588	.402	0.011	PA2646	1	1.600	0.726	.233	0.007
PA2499	1	1.750	0.794	.175	0.005	PA2573	1	10.750	4.876	2.748	0.078	PA2647	1	6.000	2.722	1.163	0.033
PA2500	1	6.800	3.084	1.382	0.039	PA2573XP	1	12.050	5.466	2.710	0.077	PA2648	1	14.100	6.396	2.854	0.081
PA2502	1	3.100	1.406	.433	0.012	PA2574	1	4.900	2.223	1.244	0.035	PA2650	1	17.650	8.006	2.250	0.064
LL2503	1	9.500	4.309	2.092	0.059	LL2575	1	3.050	1.383	.288	0.008	PA2651	1	4.350	1.973	.693	0.020
PA2503	1	8.800	3.992	2.092	0.059	PA2575	1	3.000	1.361	.288	0.008	PA2652	1	1.250	0.567	.183	0.005
PA2504	1	4.450	2.019	.765	0.022	PA2576	1	2.200	0.998	.234	0.007	PA2653	1	12.520	5.679	2.564	0.073
LL2507	1	25.150	11.408	4.173	0.118	PA2577	1	6.900	3.130	1.408	0.040	PA2653 FOAM	6	.350	0.159	.424	0.012
PA2507	1	23.450	10.637	4.173	0.118	PA2578	1	2.500	1.134	.456	0.013	PA2654	1	9.650	4.377	2.039	0.058
PA2508	1	6.450	2.926	1.674	0.047	PA2579	1	3.050	1.383	.617	0.017	PA2655	1	3.300	1.497	.683	0.019
PA2509	1	7.650	3.470	1.473	0.042	PA2580	1	13.650	6.192	2.532	0.072	PA2656	1	5.250	2.381	.780	0.022
PA2510	1	2.550	1.157	.421	0.012	PA2581	1	4.900	2.223	.693	0.020	PA2657-FN	1	2.200	0.998	.352	0.010
PA2511	1	4.100	1.860	.617	0.017	LL2582	1	9.250	4.196	1.623	0.046	PA2658	1	9.250	4.196	2.092	0.059
PA2512	1	1.400	0.635	.241	0.007	PA2582	1	7.900	3.583	1.552	0.044	PA2659	1	5.550	2.517	.827	0.023
PA2513	1	2.050	0.930	.321	0.009	PA2583	1	3.050	1.383	.532	0.015	PA2660	1	8.850	4.014	2.092	0.059
PA2514	1	.700	0.318	.080	0.002	PA2585	1	4.500	2.041	.688	0.019	LL2661	1	7.100	3.221	1.679	0.048
PA2515	1	13.950	6.328	2.555	0.072	PA2586	1	1.850	0.839	.234	0.007	PA2661	1	6.100	2.767	1.640	0.046
PA2516	1	17.150	7.779	3.201	0.091	PA2587	1	2.500	1.134	.460	0.013	PA2662	1	1.900	0.862	.229	0.006
PA2517	1	12.800	5.806	2.499	0.071	PA2588	1	.850	0.386	.090	0.003	PA2663-FN	1	11.750	5.330	3.136	0.089
LL2518	1	11.150	5.058	2.039	0.058	PA2589-FN	1	2.100	0.953	.361	0.010	PA2664	1	5.350	2.427	1.071	0.030
PA2518	1	9.900	4.491	2.178	0.062	PA2591	1	7.700	3.493	1.473	0.042	PA2665	1	1.950	0.885	.349	0.010
PA2518XP	1	9.450	4.287	2.151	0.061	PA2592	1	2.100	0.953	.288	0.008	PA2666	1	3.250	1.474	.486	0.014
PA2519	1	4.000	1.814	.853	0.024	PA2593	1	9.150	4.150	1.412	0.040	LL2667	1	6.550	2.971	1.212	0.034
PA2520	1	5.650	2.563	.869	0.025	PA2595	1	13.650	6.192	3.136	0.089	PA2667	1	6.200	2.812	1.214	0.034
LL2521	1	7.450	3.379	1.214	0.034	PA2596	1	4.650	2.109	.987	0.028	PA2668	1	1.850	0.839	.239	0.007
PA2521	1	7.050	3.198	1.219	0.034	PA2598	1	4.750	2.155	.736	0.021	PA2669-FN	1	3.000	1.361	.617	0.017
PA2522	1	2.350	1.066	.395	0.011	PA2599	1	6.150	2.790	1.011	0.029	PA2670	1	1.000	0.454	.156	0.004
PA2523	1	4.350	1.973	.853	0.024	PA2601	1	4.450	2.019	.666	0.019	PA2672	1	5.000	2.268	1.071	0.030
PA2524-FN	1	4.250	1.928	.949	0.027	PA2602	1	.950	0.431	.204	0.006	PA2673	1	6.050	2.744	1.045	0.030
LL2525	1	9.150	4.150	1.902	0.054	PA2604	1	7.900	3.583	1.408	0.040	PA2674	1	2.350	1.066	.421	0.012
PA2525	1	8.250	3.742	1.844	0.052	PA2605	1	2.700	1.225	.456	0.013	PA2675	1	12.250	5.557	2.722	0.077
PA2526	1	3.400	1.542	.650	0.018	PA2606	1	5.200	2.359	1.163	0.033	LL2676	1	10.400	4.717	2.039	0.058
PA2527	1	3.150	1.429	.486	0.014	PA2607	1	2.100	0.953	.368	0.010	PA2676	1	9.050	4.105	2.039	0.058
PA2528	1	5.400	2.449	.693	0.020	LL2608	1	14.950	6.781	2.897	0.082	PA2676XP	1	9.050	4.105	1.899	0.054
PA2529	1	6.650	3.016	1.275	0.036	PA2608	1	13.050	5.919	2.897	0.082	PA2677	1	5.950	2.699	1.214	0.034
PA2530	1	2.150	0.975	.339	0.010	LL2609	1	9.650	4.377	2.129	0.060	PA2678	1	.750	0.340	.068	0.002
PA2531	1	6.400	2.903	1.288	0.036	PA2609	1	8.500	3.856	2.129	0.060	PA2679	1	18.500	8.392	3.773	0.107
PA2532	1	8.100	3.674	1.492	0.042	PA2610	1	4.800	2.177	.771	0.022	PA2680	1	11.900	5.398	2.572	0.073
PA2533	1	10.650	4.831	2.156	0.061	PA2611	1	8.250	3.742	1.408	0.040	PA2684-FN	1	2.750	1.247	.512	0.014
PA2534	1	2.900	1.315	.373	0.011	PA2612	1	9.350	4.241	1.674	0.047	LL2685	1	11.500	5.216	2.047	0.058
PA2535	1	.750	0.340	.192	0.005	PA2613	1	1.650	0.748	.201	0.006	PA2687	1	2.050	0.930	.351	0.010
PA2536	1	1.450	0.658	.211	0.006	PA2614	1	12.400	5.625	2.532	0.072	LL2688	1	5.900	2.676	1.045	0.030
PA2538	1	7.150	3.243	1.214	0.034	PA2615	1	3.800	1.724	.824	0.023	PA2688	1	5.750	2.608	1.045	0.030
PA2539	1	2.400	1.089	.395	0.011	PA2616	1	6.550	2.971	1.163	0.033	PA2689	1	.900	0.408	.143	0.004
PA2540	1	4.500	2.041	.949	0.027	PA2616XP	1	6.550	2.971	1.076	0.030	PA2690	1	10.450	4.740	1.450	0.041
PA2541-FN	1	2.450	1.111	.461	0.013	PA2617	1	4.700	2.132	.595	0.017	PA2691	1	12.550	5.693	2.048	0.058
PA2542	1	3.700	1.678	.683	0.019	LL2618	1	13.600	6.169	2.446	0.069	PA2692	1	5.950	2.699	.996	0.028
PA2544	1	14.800	6.713	2.854	0.081	PA2618	1	13.050	5.919	2.446	0.069	PA2693	1	7.400	3.357	.862	0.024
PA2545	1	2.000	0.907	.321	0.009	PA2619	1	4.450	2.019	.455	0.013	PA2694	1	13.150	5.965	2.452	0.069
PA2546	1	6.250	2.835	.945	0.027	PA2620	1	6.400	2.903	1.244	0.035	PA2698	1	13.800	6.260	2.532	0.072
PA2547	1	1.100	0.499	.268	0.008	PA2621	1	2.600	1.179	.464	0.013	PA2699	1	3.750	1.701	.439	0.012
PA2548	1	6.100	2.767	.996	0.028	PA2622	1	.850	0.386	.134	0.004	PA2700	1	.750	0.340	.135	0.004
PA2550	1	5.200	2.359	.796	0.023	PA2623	1	5.850	2.654	1.288	0.036	PA2701	1	1.850	0.839	.234	0.007
PA2551	1	4.100	1.860	.650	0.018	PA2624	1	10.100	4.581	2.156	0.061	PA2702	1	.700	0.318	.111	0.003
PA2552	1	5.500	2.495	.990	0.028	PA2625	1	4.050	1.837	.796	0.023	PA2703	1	7.650	3.470	1.678	0.047
PA2554	1	7.350	3.334	.845	0.024	PA2626	1	2.750	1.247	.303	0.009	PA2704	1	9.300	4.218	2.039	0.058
PA2554 FOAM	6	.258	0.117	.148	0.004	PA2627	1	4.800	2.177	.869	0.025	PA2705	1	8.850	4.014	1.950	0.055
PA2555	1	5.200	2.359	.869	0.025	PA2628	1	9.650	4.377	2.092	0.059	PA2706	1	1.650	0.748	.345	0.010
PA2556	1	6.300	2.8														

BALDWIN WEIGHTS AND VOLUMES

BALDWIN NUMBER	CASE QTY.	WEIGHT (ea.)		Volume (ea.)		BALDWIN NUMBER	CASE QTY.	WEIGHT (ea.)		Volume (ea.)		BALDWIN NUMBER	CASE QTY.	WEIGHT (ea.)		Volume (ea.)	
		lbs.	kgs.	ft ³	m ³			lbs.	kgs.	ft ³	m ³			lbs.	kgs.	ft ³	m ³
PA2712	1	3.150	1.429	.512	0.014	PA2801	1	11.950	5.421	3.136	0.089	PA2889	1	250	0.113	.056	0.002
PA2713	1	10.150	4.604	2.447	0.069	PA2803	1	3.250	1.474	.347	0.010	PA2890	1	1.150	0.522	.149	0.004
PA2714	1	4.050	1.837	.827	0.023	PA2804	1	3.350	1.520	.349	0.010	PA2891	1	4.750	2.155	.724	0.020
PA2715	1	7.400	3.357	1.678	0.047	PA2805	1	4.700	2.132	.520	0.015	PA2895	1	2.500	1.134	.429	0.012
PA2717	1	.800	0.363	.100	0.003	PA2806	1	5.600	2.540	.969	0.027	PA2896	1	1.400	0.635	.214	0.006
PA2718	1	9.000	4.082	2.096	0.059	PA2807	1	1.250	0.567	.267	0.008	PA2897	1	4.200	1.905	.767	0.022
PA2719	1	2.750	1.247	.512	0.014	PA2812	1	9.500	4.309	1.432	0.041	PA2900	1	11.250	5.103	2.805	0.079
PA2721	1	13.800	6.260	2.258	0.064	PA2813	1	7.850	3.561	1.550	0.044	PA2902	1	11.600	5.262	2.532	0.072
PA2722	1	19.200	8.709	2.805	0.079	PA2814	1	2.050	0.930	.385	0.011	PA2903	1	4.250	1.928	.838	0.024
PA2723	1	20.150	9.140	3.591	0.102	PA2815	1	3.400	1.542	.708	0.020	PA2904	1	2.050	0.930	.288	0.008
PA2724	1	22.200	10.070	2.955	0.084	PA2816	1	4.450	2.019	.520	0.015	PA2905	1	2.500	1.134	.352	0.010
PA2725	1	1.800	0.816	.213	0.006	PA2817	1	1.750	0.794	.427	0.012	PA2906	1	1.350	0.612	.289	0.008
PA2726	1	5.200	2.359	838	0.024	PA2818	1	3.500	1.588	.769	0.022	PA2909	1	3.600	1.633	.520	0.015
PA2727	1	2.500	1.134	.321	0.009	PA2819	1	7.100	3.221	.963	0.027	PA2912	1	1.450	0.658	.166	0.005
PA2728	1	.950	0.431	.180	0.005	PA2820	1	4.800	2.177	.978	0.028	PA2913	1	2.350	1.066	.319	0.009
PA2729	1	12.150	5.511	2.532	0.072	PA2821	1	7.800	3.538	1.846	0.052	PA2914	1	12.700	5.761	2.532	0.072
PA2730	1	1.900	0.862	.213	0.006	PA2822	1	1.250	0.567	.256	0.007	PA2915	1	5.400	2.449	.824	0.023
PA2731	1	27.150	12.315	4.196	0.119	PA2823	1	2.200	0.998	.213	0.006	PA2932	1	2.250	1.021	.324	0.009
PA2732	1	8.650	3.924	2.168	0.061	PA2824	1	2.900	1.315	.288	0.008	PA2936	1	2.250	1.021	.420	0.012
PA2733	1	4.550	2.064	.910	0.026	PA2825	1	3.000	1.361	.404	0.011	PA2938	1	3.000	1.361	.736	0.021
PA2734	1	15.350	6.963	3.773	0.107	PA2826	1	2.850	1.293	.445	0.013	PA2942	1	7.850	3.561	1.154	0.033
PA2735	1	3.600	1.633	.736	0.021	PA2827	1	3.600	1.633	.402	0.011	PA2944-FN	1	1.350	0.612	.231	0.007
PA2736	1	1.550	0.703	.239	0.007	PA2828	1	3.500	1.588	.402	0.011	LL2945	1	8.350	3.788	1.676	0.047
PA2737	1	2.350	1.066	.321	0.009	PA2829	1	4.750	2.155	.520	0.015	PA2945	1	7.200	3.266	1.702	0.048
PA2738	1	2.950	1.338	.512	0.014	PA2830	1	5.600	2.540	.630	0.018	PA2946	1	3.100	1.406	.460	0.013
PA2739	1	2.600	1.179	.421	0.012	PA2831	1	9.400	4.264	1.465	0.041	PA2947	1	6.900	3.130	1.183	0.033
PA2740	1	2.100	0.953	.319	0.009	PA2832	1	.600	0.272	.090	0.003	PA2948	1	3.700	1.678	.512	0.014
PA2742	1	7.050	3.198	1.473	0.042	PA2833	1	10.100	4.581	1.640	0.046	PA2949-FN	1	1.900	0.862	.348	0.010
PA2743	1	2.100	0.953	.387	0.011	PA2834	1	3.300	1.497	.693	0.020	PA2950	1	5.200	2.359	.773	0.022
PA2744	1	14.700	6.668	2.897	0.082	PA2835	1	1.300	0.590	.200	0.006	PA2951	1	8.650	3.924	1.408	0.040
PA2745	1	4.600	2.087	.938	0.027	PA2836	1	1.100	0.499	.265	0.007	PA2952	1	10.650	4.831	1.830	0.052
PA2746	1	15.550	7.053	3.787	0.107	PA2837	1	1.050	0.476	.183	0.005	PA2953	1	6.100	2.767	.949	0.027
PA2747	1	7.350	3.334	2.070	0.059	PA2838	1	11.900	5.398	1.737	0.049	PA2954-FN	1	4.350	1.973	.798	0.023
PA2748	1	.300	0.136	.111	0.003	PA2839	1	14.400	6.532	2.826	0.080	PA2955	1	16.100	7.303	2.202	0.062
PA2749	1	11.600	5.262	2.446	0.069	PA2840	1	12.400	5.625	2.039	0.058	PA2956-FN	1	13.250	6.010	3.136	0.089
PA2750	1	.950	0.431	.853	0.024	PA2843	1	5.200	2.359	.777	0.022	PA2957	1	3.750	1.701	.856	0.024
PA2751	1	6.750	3.062	1.552	0.044	PA2844	1	3.400	1.542	.396	0.011	PA2958	1	1.850	0.839	.517	0.015
PA2752	1	3.150	1.429	.363	0.010	PA2845	1	2.950	1.338	.410	0.012	PA2959-FN	1	12.050	5.466	3.136	0.089
PA2753	1	3.600	1.633	.429	0.012	PA2846-FN	1	2.100	0.953	.347	0.010	PA2960	1	3.400	1.542	.692	0.020
PA2754	1	3.050	1.383	.512	0.014	PA2847	1	7.500	3.402	1.473	0.042	PA2961-FN	1	4.600	2.087	.869	0.025
PA2755	1	7.900	3.583	1.492	0.042	PA2848	1	9.100	4.128	1.737	0.049	PA2962	1	11.700	5.307	2.380	0.067
PA2756	1	3.800	1.724	.650	0.018	PA2849	1	16.850	7.643	4.599	0.130	PA2963	1	9.200	4.173	1.614	0.046
PA2757	1	9.600	4.355	1.614	0.046	PA2851	1	7.150	3.243	1.540	0.044	PA2964	1	4.300	1.950	.824	0.023
PA2759	1	3.650	1.656	.607	0.017	PA2852	1	7.950	3.606	1.830	0.052	PA2967	1	3.300	1.497	.856	0.024
PA2761	1	5.150	2.336	.963	0.027	PA2853	1	2.850	1.293	.533	0.015	PA2968-FN	1	3.350	1.520	.555	0.016
PA2763	1	1.750	0.794	.402	0.011	PA2854	1	10.700	4.854	1.985	0.056	PA2970	1	3.550	1.610	.572	0.016
PA2767	1	2.400	1.089	.317	0.009	PA2855	1	12.500	5.670	2.774	0.079	PA2971	1	5.750	2.608	1.335	0.038
PA2771	1	10.550	4.785	1.113	0.031	PA2856	1	5.100	2.313	.856	0.024	PA2973	1	14.000	6.350	2.805	0.079
PA2772	1	2.700	1.225	.348	0.010	PA2857	1	13.000	5.897	2.879	0.081	PA2976-FN	1	2.350	1.066	.512	0.014
PA2773	1	2.800	1.270	.650	0.018	PA2858	1	1.850	0.839	.179	0.005	PA2977-FN	1	4.000	1.814	.750	0.021
PA2774	1	11.300	5.126	1.939	0.055	PA2859-FN	1	4.650	2.109	1.163	0.033	PA2978	1	.950	0.431	.144	0.004
PA2775	1	3.000	1.361	.650	0.018	PA2860-FN	1	1.750	0.794	.236	0.007	PA2980	1	2.400	1.089	.584	0.017
PA2776	1	9.300	4.218	1.830	0.052	PA2861	1	.500	0.227	.051	0.001	PA2982	1	9.850	4.468	1.840	0.052
PA2777	1	6.350	2.880	1.052	0.030	PA2862	1	.550	0.249	.065	0.002	PA2984	1	1.200	0.544	.305	0.009
PA2778-FN	1	1.100	0.499	.151	0.004	PA2862 FOAM	12	.020	0.009	.022	0.001	PA2988	1	17.300	7.847	4.111	0.116
LL2779	1	5.000	2.268	.767	0.022	RS2863	1	3.800	1.724	.750	0.021	PA2989	1	14.700	6.668	4.285	0.121
PA2779	1	4.650	2.109	.767	0.022	RS2863XP	1	3.750	1.701	.750	0.021	HSG3077	1	1.850	0.839	.347	0.010
PA2781	1	12.750	5.783	2.446	0.069	PA2865	1	5.600	2.540	.869	0.025	HSG3078	1	1.900	0.862	.352	0.010
PA2782	1	6.850	3.107	1.674	0.047	PA2866	1	6.100	2.767	.942	0.027	AB3349	1	.850	0.386	.047	0.001
PA2783	1	4.450	2.019	.901	0.025	PA2867-FN	1	10.700	4.854	2.499	0.071	PA3404	1	11.600	5.262	2.794	0.079
PA2784	1	6.250	2.835	1.477	0.042	PA2869	1	3.700	1.678	.520	0.015	PA3405	1	3.400	1.542	.607	0.017
PA2785	1	5.400	2.449	1.288	0.036	PA2870-FN	1	7.900	3.583	1.939	0.055	PA3406-FN	1	2.400	1.089	.361	0.010
PA2786	1	8.400	3.810	1.540	0.044	PA2871	1	2.650	1.202	.486	0.014	PA3411-FN	1	2.400	1.089	.429	0.012
PA2787	1	3.200	1.452	.824	0.023	PA2874	1	19.050	8.641	2.651	0.075	PA3414	6	.775	0.352	.125	0.004
PA2788	1	4.500	2.041	.949	0.027	PA2875	1	17.250	7.825	2.555	0.072	PA3415	1	4.300	1.950	.741	0.021
PA2789	1	8.300	3.765	1.126	0.032	PA2876	1	14.000	6.350	1.785	0.051	PA3416	1	1.500	0.680	.322	0.009
PA2790-FN	1	2.750	1.247	.456	0.013	PA2877-FN	1	2.950	1.338	.512	0.014	PA3417	1	1.700	0.771	.337	0.010
PA2791	1	.800	0.363	.158	0.004	PA2878	1	2.250	1.021	.656	0.019	PA3419	6	.475	0.215	.078	0.002
PA2792	1	1.750	0.794	.233	0.007	PA2880	1	4.600	2.087	.695	0.020	PA3420	1	2.950	1.338	.402	0.011
PA2793	1	4.550	2.064	.693	0.020	PA2881	1	2.250	1.021	.461	0.013	PA3421	1	4.750	2.155	.537	0.015
PA2794	1																

BALDWIN WEIGHTS AND VOLUMES

BALDWIN NUMBER	CASE QTY.	WEIGHT (ea.) lbs.	WEIGHT (ea.) kgs.	Volume (ea.) ft ³	Volume (ea.) m ³	BALDWIN NUMBER	CASE QTY.	WEIGHT (ea.) lbs.	WEIGHT (ea.) kgs.	Volume (ea.) ft ³	Volume (ea.) m ³	BALDWIN NUMBER	CASE QTY.	WEIGHT (ea.) lbs.	WEIGHT (ea.) kgs.	Volume (ea.) ft ³	Volume (ea.) m ³
PA3442	1	3.200	1.452	.369	0.010	RS3531	1	2.900	1.315	.853	0.024	PA3651-FN	1	2.050	0.930	.234	0.007
PA3446	1	3.800	1.724	.767	0.022	RS3532	1	4.700	2.132	.947	0.027	PA3652	1	9.150	4.150	2.156	0.061
PA3447	1	2.600	1.179	.486	0.014	RS3533	1	1.700	0.771	.344	0.010	PA3653	1	3.400	1.542	.433	0.012
PA3448	1	4.450	2.019	.768	0.022	RS3534	1	13.550	6.146	2.847	0.081	PA3654	1	1.300	0.590	.201	0.006
PA3452	1	9.050	4.105	1.785	0.051	RS3535	1	1.550	0.703	.293	0.008	PA3655	1	6.600	2.994	1.048	0.030
PA3453	1	9.050	4.105	1.640	0.046	RS3536	1	2.050	0.930	.402	0.011	PA3656	1	2.600	1.179	.460	0.013
PA3457	1	1.350	0.612	.144	0.004	RS3537	1	.650	0.295	.127	0.004	PA3657	1	1.850	0.839	.321	0.009
PA3458	1	13.100	5.942	2.805	0.079	RS3538	1	3.850	1.746	.833	0.024	PA3658	1	2.600	1.179	.289	0.008
PA3460	1	4.850	2.200	.856	0.024	RS3539	1	8.350	3.788	1.974	0.056	PA3660-FN	1	3.400	1.542	.652	0.018
PA3461	1	15.200	6.895	3.407	0.096	RS3539XP	1	8.250	3.742	1.990	0.056	PA3664-FN	1	1.150	0.522	.211	0.006
PA3463	1	16.800	7.620	3.406	0.096	RS3540	1	3.600	1.633	.796	0.023	PA3667-FN	1	2.150	0.975	.348	0.010
PA3464	1	11.150	5.058	2.532	0.072	RS3541	1	.900	0.408	.236	0.007	PA3668	1	3.850	1.746	.853	0.024
PA3466-FN	1	2.800	1.270	.512	0.014	RS3542	1	1.750	0.794	.288	0.008	PA3669-FN	1	4.300	1.950	.856	0.024
PA3467	1	4.700	2.132	.856	0.024	RS3543	1	.500	0.227	.125	0.004	PA3670	1	3.600	1.633	.512	0.014
PA3469	1	5.650	2.563	.910	0.026	RS3544	1	2.450	1.111	.398	0.011	PA3671-FN	1	2.250	1.021	.352	0.010
PA3470	1	2.350	1.066	.421	0.012	RS3545	1	.600	0.272	.129	0.004	PA3672	1	.800	0.363	.140	0.004
PA3471	1	2.100	0.953	.349	0.010	RS3547	1	.300	0.136	.051	0.001	PA3674	1	.850	0.386	.124	0.004
PA3472	1	.800	0.363	.090	0.003	RS3548	1	5.950	2.699	1.277	0.036	PA3675	1	8.050	3.651	1.408	0.040
PA3472-FN	1	.800	0.363	.127	0.004	RS3548XP	1	5.950	2.699	1.277	0.036	PA3676	1	2.600	1.179	.299	0.008
PA3473	1	2.100	0.953	.237	0.007	RS3549	1	1.750	0.794	.321	0.009	PA3679	1	.800	0.363	.072	0.002
PA3474	1	5.200	2.359	.736	0.021	RS3550	1	2.750	1.247	.554	0.016	PA3680	1	.400	0.181	.227	0.006
PA3475	1	3.700	1.678	.617	0.017	PA3551	1	5.250	2.381	1.473	0.042	PA3681	1	3.750	1.701	.520	0.015
PA3476	1	1.550	0.703	.352	0.010	PA3554	1	4.400	1.996	.450	0.013	PA3682	1	.700	0.318	.112	0.003
PA3477	1	9.850	4.468	2.039	0.058	PA3555	1	6.450	2.926	.734	0.021	PA3683	1	1.050	0.476	.167	0.005
PA3478	1	6.650	3.016	1.383	0.039	PA3556	1	11.950	5.421	1.276	0.036	PA3684	1	.750	0.340	.094	0.003
PA3478XP	1	5.700	2.586	1.367	0.039	PA3557-FN	1	1.350	0.612	.234	0.007	PA3685	1	.900	0.408	.128	0.004
PA3479	1	4.650	2.109	.869	0.025	PA3558	1	8.050	3.651	1.639	0.046	PA3686	1	.900	0.408	.125	0.004
PA3480	1	3.400	1.542	.650	0.018	PA3560	1	14.100	6.396	3.406	0.096	PA3687	1	.650	0.295	.174	0.005
PA3481	1	2.350	1.066	.299	0.008	PA3562	1	6.100	2.767	.827	0.023	PA3688	1	10.050	4.559	1.830	0.052
PA3482	1	1.500	0.680	.153	0.004	PA3563	1	14.100	6.396	2.805	0.079	PA3689	1	2.650	1.202	.456	0.013
PA3483	1	5.300	2.404	.538	0.015	PA3565	1	.400	0.181	.051	0.001	PA3690	1	4.200	1.905	.709	0.020
PA3484	1	13.800	6.260	2.532	0.072	PA3566	1	2.900	1.315	.617	0.017	PA3691	1	7.150	3.243	1.678	0.047
PA3486	1	11.400	5.171	1.950	0.055	PA3568	1	22.400	10.161	6.272	0.177	PA3697	6	1.783	0.809	.234	0.007
PA3487	1	3.800	1.724	.617	0.017	PA3569	1	16.400	7.439	3.787	0.107	PA3698	1	3.350	1.520	.486	0.014
PA3491	1	4.350	1.973	.694	0.020	PA3572	1	7.850	3.561	1.244	0.035	PA3699	1	8.250	3.742	1.408	0.040
PA3492	1	1.100	0.499	.221	0.006	PA3573	1	11.700	5.307	2.232	0.063	RS3700	1	9.750	4.423	2.426	0.069
PA3493	1	13.700	6.214	1.453	0.041	PA3576	1	17.500	7.938	5.766	0.163	RS3700XP	1	10.000	4.536	2.324	0.066
PA3494	1	1.950	0.885	.612	0.017	PA3578	1	2.150	0.975	.342	0.010	RS3701	1	4.150	1.882	1.045	0.030
PA3495	1	1.900	0.862	.237	0.007	PA3579	1	13.050	5.919	2.532	0.072	RS3703	1	.500	0.227	.125	0.004
PA3496	1	17.450	7.915	4.529	0.128	PA3581	1	6.100	2.767	1.288	0.036	RS3704	1	.900	0.408	.122	0.003
PA3498	1	6.450	2.926	1.698	0.048	PA3584	1	17.950	8.142	4.599	0.130	RS3705	1	.350	0.159	.051	0.001
PA3499	1	9.350	4.241	2.039	0.058	PA3587	1	16.000	7.258	3.406	0.096	RS3706	1	2.100	0.953	.538	0.015
RS3501	1	1.250	0.567	.229	0.006	PA3588	1	14.600	6.623	3.549	0.100	RS3707	1	1.900	0.862	.346	0.010
RS3502	1	3.800	1.724	.741	0.021	PA3595	1	18.250	8.278	3.839	0.109	RS3708	1	2.200	0.998	.421	0.012
RS3503	1	1.250	0.567	.231	0.007	PA3597	1	6.550	2.971	.869	0.025	RS3709	1	.750	0.340	.316	0.009
RS3504	1	5.400	2.449	1.180	0.033	PA3598	1	8.050	3.651	1.315	0.037	RS3710	1	5.050	2.291	1.299	0.037
RS3504XP	1	5.400	2.449	1.180	0.033	PA3600	1	6.150	2.790	1.045	0.030	RS3711	1	2.100	0.953	.456	0.013
RS3505	1	1.400	0.635	.413	0.012	PA3601	1	.650	0.295	.127	0.004	RS3712	1	8.450	3.833	1.995	0.056
RS3506	1	6.450	2.926	1.426	0.040	PA3602	1	9.800	4.445	2.156	0.061	RS3713	1	3.600	1.633	.949	0.027
RS3506XP	1	6.400	2.903	1.426	0.040	PA3604	1	8.150	3.697	1.939	0.055	RS3714	1	8.750	3.969	2.039	0.058
RS3507	1	2.000	0.907	.421	0.012	PA3605	1	5.500	2.495	.949	0.027	RS3715	1	.600	0.272	.092	0.003
RS3508	1	5.500	2.495	1.192	0.034	PA3606	1	14.500	6.577	2.600	0.074	RS3716	1	.900	0.408	.134	0.004
RS3508XP	1	5.300	2.404	1.192	0.034	PA3607-FN	1	2.900	1.315	.512	0.014	RS3717	1	2.100	0.953	.532	0.015
RS3509	1	2.400	1.089	.486	0.014	PA3608-FN	1	3.250	1.474	.512	0.014	RS3718	1	9.150	4.150	1.937	0.055
RS3510	1	6.800	3.084	1.639	0.046	PA3609	1	5.250	2.381	.856	0.024	RS3719	1	2.800	1.270	.838	0.024
RS3510XP	1	7.000	3.175	1.614	0.046	PA3611	1	20.900	9.480	5.623	0.159	RS3720	1	8.700	3.946	2.321	0.066
RS3511	1	3.200	1.452	.856	0.024	PA3612	1	1.350	0.612	.195	0.006	RS3721	1	4.150	1.882	1.071	0.030
RS3512	1	7.300	3.311	1.629	0.046	PA3613	1	1.450	0.658	.120	0.003	RS3722	1	1.850	0.839	.421	0.012
RS3513	1	2.750	1.247	.739	0.021	PA3614	1	16.100	7.303	3.614	0.102	RS3724	1	7.850	3.561	1.677	0.047
RS3514	1	8.650	3.924	1.927	0.055	PA3627	1	3.950	1.792	.520	0.015	RS3726	1	9.000	4.082	2.039	0.058
RS3514XP	1	8.750	3.969	1.887	0.053	PA3628	1	.900	0.408	.174	0.005	RS3727	1	7.650	3.470	1.859	0.053
RS3515	1	3.050	1.383	.856	0.024	PA3629	1	5.050	2.291	.949	0.027	RS3728	1	9.200	4.173	2.355	0.067
RS3516	1	5.950	2.699	1.343	0.038	PA3630-FN	1	4.850	2.200	1.244	0.035	RS3729	1	3.300	1.497	.824	0.023
RS3516XP	1	6.250	2.835	1.676	0.047	PA3631	1	1.750	0.794	.288	0.008	RS3730	1	7.250	3.289	1.909	0.054
RS3517	1	5.300	2.404	1.250	0.035	PA3632	1	.600	0.272	.105	0.003	RS3731	1	4.250	1.928	1.076	0.030
RS3517XP	1	5.200	2.359	1.233	0.035	PA3633	1	34.200	15.513	7.671	0.217	RS3732	1	1.800	0.816	.339	0.010
RS3518	1	7.300	3.311	1.615	0.046	PA3633 FOAM	1	1.250	0.567	1.004	0.028	RS3733	1	3.850	1.746	.868	0.025
RS3518XP	1	7.400	3.357	1.628	0.046	PA3636	1	2.750	1.247	.321	0.009	RS3734	1	4.050	1.837	.882	0.025
RS3519	1	2.400	1.089	.456	0.013	PA3637	1	24.700	11.204	4.991	0.141	RS3734XP	1	4.100	1.860	.858	0.024
RS3520	1	4.300	1.950	.964	0.027	PA3638	1	15.500	7.031	4.526	0.128	RS3735	1	4.000	1.814	.512	0.014
RS3521	1	1.600	0.726	.314	0.009	PA3640	1	8.250									

BALDWIN WEIGHTS AND VOLUMES

BALDWIN NUMBER	CASE QTY.	WEIGHT (ea.) lbs.	WEIGHT (ea.) kgs.	Volume (ea.) ft ³	Volume (ea.) m ³	BALDWIN NUMBER	CASE QTY.	WEIGHT (ea.) lbs.	WEIGHT (ea.) kgs.	Volume (ea.) ft ³	Volume (ea.) m ³	BALDWIN NUMBER	CASE QTY.	WEIGHT (ea.) lbs.	WEIGHT (ea.) kgs.	Volume (ea.) ft ³	Volume (ea.) m ³
RS3741	1	2.700	1.225	.858	0.024	PA3832	1	3.150	1.429	.617	0.017	PA3916	1	10.600	4.808	2.039	0.058
RS3743	1	6.900	3.130	1.678	0.047	PA3833	1	1.850	0.839	.282	0.008	PA3917	1	.700	0.318	.116	0.003
RS3744	1	7.650	3.470	1.609	0.046	PA3834	6	.200	0.091	.076	0.002	PA3918	1	6.650	3.016	1.074	0.030
RS3744XP	1	7.700	3.493	1.609	0.046	PA3835	6	.183	0.083	.081	0.002	PA3919	1	2.100	0.953	.404	0.011
RS3745	1	2.300	1.043	.532	0.015	PA3836	6	1.283	0.582	.285	0.008	RS3920	1	2.000	0.907	.395	0.011
RS3746	1	2.350	1.066	.398	0.011	PA3838	1	12.200	5.534	2.274	0.064	RS3921	1	.500	0.227	.095	0.003
RS3747	1	.550	0.249	.121	0.003	PA3839	6	.675	0.306	.125	0.004	RS3922	1	2.250	1.021	.460	0.013
RS3749	1	9.400	4.264	2.232	0.063	PA3840	6	.442	0.200	.028	0.001	RS3923	1	.700	0.318	.241	0.007
RS3750	1	5.650	2.563	1.223	0.035	PA3843	1	2.650	1.202	.938	0.027	PA3924-FN	1	3.800	1.724	.736	0.021
RS3750XP	1	5.300	2.404	1.247	0.035	PA3844	1	17.450	7.915	2.269	0.064	PA3925	1	4.650	2.109	.725	0.021
PA3752	1	4.000	1.814	.607	0.017	PA3847	1	2.600	1.179	.460	0.013	RS3926	1	11.100	5.035	2.701	0.076
PA3753	1	2.250	1.021	.292	0.008	PA3848-FN	1	2.300	1.043	.535	0.015	RS3927	1	3.300	1.497	.838	0.024
PA3754	1	13.650	6.192	2.129	0.060	PA3849	1	6.000	2.722	1.351	0.038	PA3928	1	4.500	2.041	.652	0.018
PA3755	1	3.750	1.701	.630	0.018	PA3850	1	6.650	3.016	1.192	0.034	PA3929	6	.692	0.314	.104	0.003
PA3756	1	2.200	0.998	.417	0.012	PA3851	1	1.750	0.794	.213	0.006	RS3930	1	.200	0.091	.020	0.001
PA3757	1	.900	0.408	.093	0.003	PA3852-FN	1	3.450	1.565	.717	0.020	PA3931	6	.275	0.125	.108	0.003
PA3758	1	1.550	0.703	.237	0.007	PA3853-FN	1	3.000	1.361	.622	0.018	PA3932	1	18.650	8.460	4.489	0.127
PA3760	1	6.350	2.880	.952	0.027	PA3854-FN	1	5.350	2.427	1.408	0.040	PA3933	1	11.200	5.080	3.240	0.092
PA3761-FN	1	2.200	0.998	.346	0.010	PA3855-FN	1	7.700	3.493	1.640	0.046	RS3934	1	3.850	1.746	.853	0.024
PA3763	6	1.400	0.635	.242	0.007	PA3859	1	3.550	1.610	.547	0.015	RS3935	1	1.300	0.590	.317	0.009
RS3764	1	9.550	4.332	2.418	0.068	PA3860	1	7.950	3.606	1.890	0.053	RS3936	1	6.900	3.130	1.805	0.051
PA3765	1	12.150	5.511	2.365	0.067	PA3861	1	4.150	1.882	1.001	0.028	PA3937	1	2.100	0.953	.263	0.007
PA3766	1	8.250	3.742	1.326	0.038	PA3862-FN	1	6.800	3.084	1.408	0.040	PA3938	1	9.150	4.150	1.616	0.046
PA3767	1	11.500	5.216	2.300	0.065	PA3863	1	1.550	0.703	.288	0.008	PA3939	1	1.250	0.567	.168	0.005
PA3768	1	15.550	7.053	2.793	0.079	PA3864	1	5.850	2.654	1.163	0.033	RS3940	1	1.750	0.794	.321	0.009
PA3773	6	.867	0.393	.201	0.006	PA3865	1	3.600	1.633	.938	0.027	PA3941	6	.775	0.352	.123	0.003
PA3774	1	2.350	1.066	.395	0.011	PA3867	1	3.500	1.588	.591	0.017	RS3942	1	1.300	0.590	.211	0.006
PA3775	1	6.450	2.926	1.048	0.030	PA3868	1	3.500	1.588	.781	0.022	RS3943	1	.400	0.181	.090	0.003
PA3777	1	1.050	0.476	.231	0.007	PA3869	1	3.500	1.588	.506	0.014	PA3944	1	3.900	1.769	.848	0.024
PA3778	1	2.000	0.907	.321	0.009	RS3870	1	8.650	3.924	2.038	0.058	PA3945	1	2.500	1.134	.370	0.010
PA3779-FN	1	3.400	1.542	.693	0.020	RS3870XP	1	8.800	3.992	2.039	0.058	PA3946	1	6.700	3.039	1.288	0.036
PA3780	1	10.250	4.649	1.830	0.052	RS3871	1	3.000	1.361	.681	0.019	PA3948	1	6.500	2.948	1.640	0.046
PA3781	1	2.100	0.953	.240	0.007	PA3872	12	1.470	0.667	.631	0.018	PA3949	1	1.850	0.839	.367	0.010
PA3782	1	2.250	1.021	.371	0.010	PA3873	12	1.121	0.508	.525	0.015	PA3950	1	.650	0.295	.097	0.003
PA3783	1	1.550	0.703	.199	0.006	PA3874	1	5.000	2.268	.758	0.021	PA3951	1	9.050	4.105	2.092	0.059
PA3785-FN	1	1.750	0.794	.325	0.009	PA3875-FN	1	2.450	1.111	.422	0.012	RS3952	1	8.500	3.856	1.938	0.055
PA3786-FN	1	10.300	4.672	3.136	0.089	PA3877	1	3.250	1.474	.457	0.013	PA3953	6	.500	0.227	.083	0.002
PA3787	1	4.600	2.087	1.141	0.032	PA3878	1	2.900	1.315	.395	0.011	RS3954	1	1.100	0.499	.175	0.005
PA3790	1	3.400	1.542	.572	0.016	PA3879-FN	1	3.000	1.361	.486	0.014	PA3956	1	2.600	1.179	.775	0.022
PA3791-FN	1	2.250	1.021	.352	0.010	PA3880	6	.725	0.329	.107	0.003	PA3957	6	.550	0.249	.071	0.002
PA3792	1	1.100	0.499	.123	0.003	PA3881	1	2.600	1.179	.427	0.012	PA3957 FOAM	12	.020	0.009	.017	**
PA3794	1	10.000	4.536	1.674	0.047	RS3882	1	3.200	1.452	.693	0.020	PA3958	6	.500	0.227	.137	0.004
PA3795	1	1.050	0.476	.127	0.004	RS3882XP	1	2.950	1.338	.637	0.018	PA3959	1	.500	0.227	.065	0.002
PA3796	1	5.000	2.268	.750	0.021	RS3883	1	.950	0.431	.179	0.005	BA3964(4)	1	14.650	6.645	4.370	0.124
PA3797	1	1.450	0.658	.288	0.008	RS3884	1	4.100	1.860	.856	0.024	BA3965(4)	1	23.180	10.514	8.233	0.233
PA3798	1	2.350	1.066	.215	0.006	RS3885	1	1.300	0.590	.219	0.006	PA3966	1	2.150	0.975	.512	0.014
PA3800	1	14.850	6.736	2.153	0.061	PA3886	1	1.550	0.703	.289	0.008	PA3967	6	1.209	0.548	.230	0.007
PA3801-FN	1	2.000	0.907	.352	0.010	PA3887	1	12.300	5.579	2.532	0.072	PA3969	1	1.850	0.839	.231	0.007
PA3802	1	2.700	1.225	.210	0.006	RS3888	1	8.250	3.742	1.937	0.055	PA3970	6	1.308	0.593	.232	0.007
PA3803	1	2.850	1.293	.433	0.012	PA3889	1	4.550	2.064	1.288	0.036	RS3971	1	3.300	1.497	.650	0.018
PA3804	1	1.450	0.658	.226	0.006	PA3890	6	2.233	1.013	.381	0.011	PA3972	1	2.200	0.998	.319	0.009
PA3805-FN	1	1.800	0.816	.317	0.009	PA3891	1	12.700	5.761	2.039	0.058	PA3973	1	.800	0.363	.093	0.003
PA3806	1	16.900	7.666	3.406	0.096	PA3892	1	11.800	5.352	2.201	0.062	RS3974	1	6.200	2.812	1.277	0.036
PA3807	1	5.000	2.268	.652	0.018	PA3893	1	3.900	1.769	.853	0.024	RS3975	1	2.450	1.111	.838	0.024
PA3808-FN	1	6.250	2.835	1.473	0.042	PA3894	1	2.800	1.270	.527	0.015	PA3978	1	11.300	5.126	1.640	0.046
PA3809	1	2.000	0.907	.339	0.010	PA3895-FN	1	.700	0.318	.090	0.003	PA3979	1	2.300	1.043	.425	0.012
PA3810	1	6.000	2.722	1.785	0.051	PA3896	1	3.050	1.383	.532	0.015	PA3980	6	.742	0.337	.175	0.005
PA3811-FN	1	1.250	0.567	.223	0.006	PA3897	1	2.300	1.043	.392	0.011	PA3983-FN	6	.633	0.287	.103	0.003
PA3812	1	.300	0.136	.059	0.002	PA3898	1	5.850	2.654	1.288	0.036	PA3984	1	3.100	1.406	.617	0.017
PA3814	1	13.000	5.897	1.373	0.039	PA3899	1	2.600	1.179	.819	0.023	PA3985	1	.900	0.408	.143	0.004
PA3815	1	12.500	5.670	1.403	0.040	PA3900	1	1.900	0.862	.381	0.011	PA3986	6	.333	0.151	.093	0.003
PA3816	1	2.150	0.975	.358	0.010	PA3901	6	.767	0.348	.125	0.004	PA3987	1	15.600	7.076	2.293	0.065
PA3817	1	.700	0.318	.135	0.004	PA3901 FOAM	12	.083	0.038	.029	0.001	RS3988	1	1.600	0.726	.291	0.009
PA3818-FN	1	1.800	0.816	.319	0.009	PA3902	1	5.700	2.586	1.315	0.037	PA3989-FN	1	3.100	1.406	.512	0.014
PA3819	1	.300	0.136	.085	0.002	PA3903	1	1.800	0.816	.372	0.011	RS3990	1	.750	0.340	.176	0.005
PA3820-FN	1	1.700	0.771	.298	0.008	PA3904	1	14.950	6.781	3.664	0.104	RS3991	1	.300	0.136	.072	0.002
PA3821	1	1.550	0.703	.246	0.007	PA3905	1	10.650	4.831	3.448	0.098	RS3992	1	3.150	1.429	.654	0.019
PA3822	6	1.192	0.541	.171	0.005	PA3906	1	6.100	2.767	1.045	0.030	RS3993	1	.850	0.386	.319	0.009
PA3823	6	1.483	0.673	.248	0.007	PA3907	1	10.700	4.854	1.676	0.047	RS3994	1	3.950	1.792	.856	0.024
PA3824	1	3.250	1.474	.455	0.013	PA3908	1	1.900	0.862	.291	0.008	RS3995	1	1.000	0.454	.326	0.009
PA3825	6	.842	0.382	.135	0.004	PA3909	1	.800	0.363	.095	0.003	RS3996	1	6.000	2		

BALDWIN WEIGHTS AND VOLUMES

BALDWIN NUMBER	CASE QTY.	WEIGHT (ea.) lbs.	WEIGHT (ea.) kgs.	Volume (ea.) ft ³	Volume (ea.) m ³	BALDWIN NUMBER	CASE QTY.	WEIGHT (ea.) lbs.	WEIGHT (ea.) kgs.	Volume (ea.) ft ³	Volume (ea.) m ³	BALDWIN NUMBER	CASE QTY.	WEIGHT (ea.) lbs.	WEIGHT (ea.) kgs.	Volume (ea.) ft ³	Volume (ea.) m ³
PA4005	6	2.933	1.330	.752	0.021	PA4148	6	1.550	0.703	.245	0.007	PA4328	1	1.750	0.794	.267	0.008
PA4015	6	.925	0.420	.104	0.003	PA4149 KIT	6	.659	0.299	.124	0.004	PA4329	6	.667	0.303	.152	0.004
PA4016	6	.642	0.291	.092	0.003	PA4150	6	.717	0.325	.121	0.003	PA4330	6	.758	0.344	.265	0.007
PA4018	6	.591	0.268	.090	0.003	PA4151	6	1.158	0.525	.211	0.006	PA4331	6	1.050	0.476	.271	0.008
PA4023	6	1.167	0.529	.160	0.005	PA4152	6	.333	0.151	.057	0.002	PA4332	6	.442	0.200	.148	0.004
PA4026	6	.533	0.242	.097	0.003	PA4153	1	.600	0.272	.383	0.011	PA4333	6	.925	0.420	.230	0.007
PA4028	6	1.133	0.514	.132	0.004	PA4154	6	.568	0.258	.084	0.002	PA4334	6	.609	0.276	.230	0.007
PA4041	1	1.600	0.726	.187	0.005	PA4155 KIT	1	.750	0.340	.197	0.006	PA4335	6	.767	0.348	.104	0.003
PA4042	6	1.240	0.562	.163	0.005	PA4156 KIT	1	.600	0.272	.169	0.005	PA4336	6	1.342	0.609	.176	0.005
PA4043	6	.492	0.223	.073	0.002	PA4157	6	.834	0.378	.208	0.006	PA4337	6	.680	0.308	.130	0.004
PA4044	6	.658	0.298	.089	0.003	PA4158	6	.433	0.196	.066	0.002	PA4338	6	.942	0.427	.160	0.005
PA4045	6	.667	0.303	.132	0.004	PA4159	6	.817	0.371	.208	0.006	PA4340	6	.500	0.227	.084	0.002
PA4046	6	.983	0.446	.126	0.004	PA4160	6	.683	0.310	.123	0.003	PA4341	6	1.067	0.484	.208	0.006
PA4047	6	.717	0.325	.126	0.004	RS4161	1	1.200	0.544	.201	0.006	PA4344	6	.934	0.424	.148	0.004
PA4048	6	.725	0.329	.199	0.006	PA4162	6	1.467	0.665	.228	0.006	PA4345	6	.900	0.408	.130	0.004
PA4049	6	.758	0.344	.087	0.002	PA4163	6	.983	0.446	.133	0.004	PA4348	6	.925	0.420	.124	0.004
PA4050	6	.775	0.352	.081	0.002	PA4164	6	1.200	0.544	.208	0.006	PA4349	6	1.450	0.658	.234	0.007
PA4060	6	.917	0.416	.127	0.004	PA4165	1	1.300	0.590	.193	0.005	PA4350	6	.858	0.389	.208	0.006
PA4061	6	1.100	0.499	.238	0.007	PA4166	6	.834	0.378	.109	0.003	PA4351	6	1.167	0.529	.133	0.004
PA4069	6	.942	0.427	.196	0.006	PA4167	6	.700	0.318	.107	0.003	PA4352	6	.575	0.261	.148	0.004
PA4070	6	1.533	0.695	.445	0.013	PA4168	1	.550	0.249	.271	0.008	PA4354	6	.883	0.401	.133	0.004
PA4071	6	.925	0.420	.309	0.009	PA4169	6	.808	0.367	.210	0.006	PA4355	6	1.209	0.548	.160	0.005
PA4072	6	2.350	1.066	.439	0.012	PA4170	6	1.042	0.473	.244	0.007	PA4356	6	.917	0.416	.208	0.006
PA4073	6	1.400	0.635	.298	0.008	PA4171	1	1.550	0.703	.314	0.009	PA4358	6	1.217	0.552	.177	0.005
PA4075	6	1.067	0.484	.392	0.011	PA4172	6	1.192	0.541	.207	0.006	PA4359	6	1.167	0.529	.246	0.007
PA4077	6	1.117	0.507	.238	0.007	PA4173	1	1.000	0.454	.235	0.007	PA4360	6	1.067	0.484	.138	0.004
PA4078	6	1.117	0.507	.160	0.005	PA4174	6	.875	0.397	.208	0.006	PA4361	6	.725	0.329	.124	0.004
PA4079	6	.992	0.450	.126	0.004	PA4175	6	.725	0.329	.124	0.004	PA4362	6	.675	0.306	.111	0.003
PA4081	6	1.033	0.469	.124	0.004	PA4176	6	.675	0.306	.129	0.004	PA4363	6	.525	0.238	.127	0.004
PA4084	6	.717	0.325	.075	0.002	PA4177	6	.833	0.378	.112	0.003	PA4364	6	1.000	0.454	.154	0.004
PA4085	6	.650	0.295	.144	0.004	PA4178	6	.925	0.420	.134	0.004	PA4365	6	.283	0.128	.129	0.004
PA4088	6	.733	0.332	.275	0.008	PA4179	6	.933	0.423	.143	0.004	PA4366	6	.650	0.295	.097	0.003
PA4089	6	.842	0.382	.260	0.007	PA4180	6	.625	0.284	.160	0.005	PA4367	6	1.125	0.510	.203	0.006
PA4090	6	1.175	0.533	.228	0.006	PA4181	6	.508	0.230	.122	0.003	PA4368	6	1.083	0.491	.126	0.004
PA4091	6	.867	0.393	.198	0.006	PA4182	6	.908	0.412	.153	0.004	PA4369	6	1.292	0.586	.160	0.005
PA4092	6	.708	0.321	.151	0.004	PA4183	6	.800	0.363	.134	0.004	PA4370	6	.459	0.208	.124	0.004
PA4093	6	1.925	0.873	.230	0.007	PA4184	6	.750	0.340	.114	0.003	PA4371	6	.417	0.189	.148	0.004
PA4099	6	.567	0.257	.094	0.003	PA4185	6	.933	0.423	.153	0.004	PA4372	6	.258	0.117	.051	0.001
PA4100	6	.533	0.242	.066	0.002	PA4187	12	.076	0.034	.009	**	PA4373	6	.508	0.230	.079	0.002
PA4101	1	1.200	0.544	.325	0.009	PA4188	6	.434	0.197	.148	0.004	PA4374	6	1.108	0.503	.230	0.007
PA4102	6	.867	0.393	.122	0.003	RS4189	1	.850	0.386	.212	0.006	PA4376	6	.675	0.306	.125	0.004
PA4103	6	.975	0.442	.095	0.003	PA4190	6	1.025	0.465	.160	0.005	PA4377	6	1.350	0.612	.175	0.005
PA4104	6	.867	0.393	.131	0.004	PA4191	6	1.034	0.469	.160	0.005	PA4381	6	.758	0.344	.125	0.004
PA4105	6	.825	0.374	.153	0.004	PA4192	6	.742	0.337	.163	0.005	PA4383	6	1.008	0.457	.176	0.005
PA4106	6	1.308	0.593	.223	0.006	PA4193	6	1.150	0.522	.160	0.005	PA4384	6	1.050	0.476	.208	0.006
PA4107	6	.883	0.401	.122	0.003	PA4194	6	.450	0.204	.148	0.004	PA4385	6	.675	0.306	.129	0.004
PA4108	6	.950	0.431	.113	0.003	PA4195 KIT	6	.634	0.288	.148	0.004	PA4386	6	.767	0.348	.108	0.003
PA4109	6	.600	0.272	.086	0.002	PA4196	6	.525	0.238	.148	0.004	PA4388	6	.883	0.401	.384	0.011
PA4110	6	1.558	0.707	.256	0.007	PA4197	6	.683	0.310	.085	0.002	PA4389	1	.800	0.363	.245	0.007
PA4111	6	1.158	0.525	.240	0.007	PA4198	6	.617	0.280	.148	0.004	PA4390	6	1.633	0.741	.242	0.007
PA4112	6	.475	0.215	.124	0.004	PA4199	6	.509	0.231	.148	0.004	PA4391	6	.459	0.208	.148	0.004
PA4113	6	1.625	0.737	.216	0.006	PA4303	6	1.034	0.469	.160	0.005	PA4393	6	.500	0.227	.148	0.004
PA4114	6	.725	0.329	.129	0.004	PA4304	6	.892	0.405	.257	0.007	PA4394	6	.442	0.200	.075	0.002
PA4118	6	1.050	0.476	.200	0.006	PA4305	6	.517	0.235	.124	0.004	PA4397	6	1.084	0.492	.160	0.005
PA4120	6	1.017	0.461	.162	0.005	PA4306	6	1.042	0.473	.160	0.005	PA4398	6	.525	0.238	.169	0.005
PA4121	6	.775	0.352	.133	0.004	PA4307	6	.784	0.356	.160	0.005	PA4399	6	.717	0.325	.134	0.004
PA4123	6	.700	0.318	.094	0.003	PA4308	6	.784	0.356	.230	0.007	PA4400	6	.683	0.310	.118	0.003
PA4124	6	.767	0.348	.110	0.003	PA4309	6	.942	0.427	.123	0.003	PA4401	6	.908	0.412	.134	0.004
PA4126	6	.975	0.442	.160	0.005	PA4310	6	1.267	0.575	.226	0.006	PA4402	6	1.292	0.586	.194	0.005
PA4127	6	1.617	0.733	.207	0.006	PA4311	6	.642	0.291	.105	0.003	PA4404	6	.492	0.223	.148	0.004
PA4128	6	.817	0.371	.104	0.003	PA4312	6	.767	0.348	.122	0.003	PA4405	6	.458	0.208	.105	0.003
PA4129	6	1.267	0.575	.223	0.006	PA4313	6	.667	0.303	.105	0.003	PA4408	6	.380	0.172	.137	0.004
RS4130	1	.900	0.408	.210	0.006	PA4314	6	.590	0.268	.140	0.004	PA4409	6	.908	0.412	.118	0.003
RS4131	1	1.800	0.816	.288	0.008	SA4315	12	.137	0.062	.039	0.001	PA4410 KIT	6	.458	0.208	.096	0.003
PA4132	6	.842	0.382	.101	0.003	PA4316	6	1.067	0.484	.160	0.005	PA4411	6	.367	0.166	.136	0.004
PA4133	6	.725	0.329	.236	0.007	PA4317	6	.542	0.246	.235	0.007	PA4412	6	1.233	0.559	.167	0.005
PA4134	6	1.560	0.708	.204	0.006	PA4318	1	2.150	0.975	.402	0.011	PA4413	6	1.233	0.559	.167	0.005
SA4137	12	.104	0.047	.020	0.001	PA4319	6	.530	0.240	.079	0.002	PA4415	6	.933	0.423	.399	0.011
PA4138	6	.617	0.280	.085	0.002	PA4320	6	.817	0.371	.084	0.002	PA4416 KIT	6	.684	0.310	.208	0.006
SA4141	12	.267	0.121	.037	0.001	PA4321	6	.692	0.314	.115	0.003	PA4417	6	1.042	0.473	.109	0.003
SA4142	12	.067	0.030	.021	0.001	PA4322	6	1.775	0.805	.233	0.007	PA4418	6	1.617	0.733	.229	0.006
PA4144	6	1.042	0.473	.131	0.004	PA4323	6	1.200	0.544	.210	0.006	PA4419	6	.617	0.280	.129	0.004
PA4145	1	6.000	2.722	.767	0.022	PA4324	6	1.775	0.805	.591	0.017	PA4421	6	.866	0.393	.148	0.004
PA4146	6	.758	0.344	.109	0.003												

BALDWIN WEIGHTS AND VOLUMES

BALDWIN NUMBER	CASE QTY.	WEIGHT (ea.) lbs.	WEIGHT (ea.) kgs.	Volume (ea.) ft ³	Volume (ea.) m ³	BALDWIN NUMBER	CASE QTY.	WEIGHT (ea.) lbs.	WEIGHT (ea.) kgs.	Volume (ea.) ft ³	Volume (ea.) m ³	BALDWIN NUMBER	CASE QTY.	WEIGHT (ea.) lbs.	WEIGHT (ea.) kgs.	Volume (ea.) ft ³	Volume (ea.) m ³
PA4424	6	.533	0.242	.115	0.003	PA4567	1	1.800	0.816	.299	0.008	PA4661	12	1.183	0.537	.442	0.013
PA4425	6	.950	0.431	.230	0.007	PA4570	1	.550	0.249	.225	0.006	PA4662	12	1.125	0.510	.441	0.012
PA4426	6	.560	0.254	.112	0.003	PA4571	1	15.000	6.804	3.136	0.089	PA4663	12	.892	0.405	.327	0.009
PA4428	6	1.017	0.461	.187	0.005	RS4572	1	8.200	3.720	2.355	0.067	PA4664	12	1.100	0.499	.470	0.013
PA4429	6	1.130	0.513	.220	0.006	PA4573	1	10.650	4.831	2.039	0.058	PA4665-FN	1	.850	0.386	.130	0.004
PA4430	6	.783	0.355	.149	0.004	PA4574	1	3.500	1.588	.683	0.019	PA4666	1	.350	0.159	.047	0.001
PA4431	6	1.008	0.457	.173	0.005	RS4576	1	6.600	2.994	1.539	0.044	RS4672	1	4.150	1.882	.879	0.025
PA4433	6	1.600	0.726	.315	0.009	RS4577	1	2.250	1.021	.538	0.015	RS4673	1	1.500	0.680	.269	0.008
PA4434	6	1.258	0.571	.267	0.008	RS4578	1	1.950	0.885	.288	0.008	PA4674-FN	1	2.750	1.247	.512	0.014
PA4435	6	1.350	0.612	.219	0.006	RS4579	1	9.550	4.332	2.700	0.076	RS4676	1	4.800	2.177	1.094	0.031
PA4436	6	.942	0.427	.152	0.004	RS4580	1	4.450	2.019	1.244	0.035	RS4677	1	1.800	0.816	.339	0.010
PA4437	6	.708	0.321	.150	0.004	PA4581	1	5.400	2.449	.856	0.024	RS4678	1	2.400	1.089	.395	0.011
PA4438	6	1.017	0.461	.173	0.005	PA4582	1	3.050	1.383	.683	0.019	RS4679	1	.600	0.272	.128	0.004
PA4439	6	1.308	0.593	.296	0.008	PA4583-FN	1	2.200	0.998	.395	0.011	RS4680	1	2.000	0.907	.392	0.011
PA4440 KIT	6	1.175	0.533	.200	0.006	PA4585	1	9.900	4.491	1.937	0.055	PA4681	6	.525	0.238	.130	0.004
PA4441	6	.842	0.382	.157	0.004	PA4592	1	2.000	0.907	.294	0.008	PA4682	6	.375	0.170	.087	0.002
PA4442	6	.433	0.196	.078	0.002	PA4593	1	3.300	1.497	.512	0.014	PA4683	1	4.250	1.928	.870	0.025
PA4443	6	.433	0.196	.086	0.002	PA4594	1	1.150	0.522	.178	0.005	PA4689	12	.750	0.340	.063	0.002
PA4444	6	.700	0.318	.269	0.008	RS4595	1	1.600	0.726	.321	0.009	PA4693	1	1.450	0.658	.303	0.009
RS4445	1	.950	0.431	.290	0.008	RS4597	1	2.050	0.930	.346	0.010	PA4694	12	.910	0.413	.080	0.002
PA4446	6	.558	0.253	.115	0.003	RS4598	1	2.600	1.179	.460	0.013	PA4695	12	.529	0.240	.071	0.002
PA4447	6	.883	0.401	.155	0.004	RS4599	1	.800	0.363	.167	0.005	PA4696 FOAM	12	.010	0.005	.024	0.001
PA4448	6	.733	0.332	.169	0.005	PA4600	6	1.942	0.881	.386	0.011	PA4697-FN	1	2.900	1.315	.673	0.019
PA4449	6	1.000	0.454	.168	0.005	PA4601	6	1.983	0.899	.430	0.012	PA4698	6	.400	0.181	.025	0.001
RS4450	1	.950	0.431	.293	0.008	PA4602	1	3.500	1.588	.693	0.020	CA4700	1	5.400	2.449	1.047	0.030
PA4451	1	.942	0.427	.170	0.005	PA4603	1	1.100	0.499	.156	0.004	PA4701	6	.608	0.276	.134	0.004
PA4452	6	.875	0.397	.133	0.004	PA4604-FN	1	1.450	0.658	.233	0.007	CA4702	1	2.900	1.315	.314	0.009
PA4453	6	.975	0.442	.131	0.004	PA4605	1	9.200	4.173	1.686	0.048	CA4703	1	3.600	1.633	.477	0.013
PA4454	6	1.117	0.507	.238	0.007	PA4606	1	17.550	7.961	3.770	0.107	PA4704	1	.700	0.318	.099	0.003
PA4455	6	.658	0.298	.133	0.004	PA4608	1	2.250	1.021	.265	0.007	PA4705	1	.300	0.136	.020	0.001
PA4456	6	1.142	0.518	.220	0.006	RS4613	1	10.050	4.559	2.348	0.066	PA4706	1	1.350	0.612	.123	0.003
PA4458	1	2.050	0.930	.395	0.011	PA4614	1	2.150	0.975	.276	0.008	PA4707	1	1.300	0.590	.237	0.007
PA4460 KIT	12	.179	0.081	.048	0.001	RS4616	1	10.700	4.854	2.573	0.073	PA4708	1	.400	0.181	.047	0.001
PA4461	6	.341	0.155	.078	0.002	RS4617	1	3.900	1.769	1.263	0.036	PA4709	1	3.600	1.633	.783	0.022
PA4462	6	.542	0.246	.137	0.004	RS4618	1	9.200	4.173	1.937	0.055	PA4711	4	1.537	0.697	.589	0.017
PA4463	6	1.067	0.484	.222	0.006	PA4619	1	1.000	0.454	.156	0.004	PA4713	1	.900	0.408	.151	0.004
PA4464	6	1.200	0.544	.227	0.006	RS4620	1	5.050	2.291	1.288	0.036	PA4714	6	.950	0.431	.122	0.003
PA4465	6	.992	0.450	.239	0.007	RS4621	1	2.100	0.953	.464	0.013	PA4715	1	1.450	0.658	.200	0.006
PA4466	6	1.533	0.695	.265	0.007	RS4622	1	7.350	3.334	1.466	0.041	PA4716	1	1.400	0.635	.146	0.004
PA4468	6	1.250	0.567	.128	0.004	RS4623	1	1.800	0.816	.533	0.015	PA4720	12	.479	0.217	.082	0.002
PA4469	6	.508	0.230	.081	0.002	PA4624	1	5.650	2.563	.942	0.027	PA4727	12	.296	0.134	.044	0.001
PA4470	6	.658	0.298	.097	0.003	PA4625	1	2.050	0.930	.395	0.011	PA4730	6	.433	0.196	.075	0.002
PA4471	6	.950	0.431	.151	0.004	PA4627	1	3.250	1.474	.693	0.020	PA4731	6	.200	0.091	.014	**
PA4472	6	1.925	0.873	.497	0.014	PA4628	1	1.350	0.612	.241	0.007	PA4732	12	.363	0.165	.061	0.002
PA4473	6	.600	0.272	.132	0.004	RS4629	1	5.200	2.359	1.753	0.050	PA4733	6	.533	0.242	.074	0.002
PA4474	6	.483	0.219	.102	0.003	PA4630	1	18.200	8.256	2.242	0.063	PA4734	6	.100	0.045	.027	0.001
PA4475	6	.442	0.200	.093	0.003	PA4631-FN	1	3.050	1.383	.617	0.017	PA4735	12	.001	**	.007	**
PA4476	6	1.050	0.476	.131	0.004	PA4632	6	.742	0.337	.076	0.002	PA4736 FOAM	12	.020	0.009	.017	**
PA4477	6	1.058	0.480	.135	0.004	PA4633	12	.150	0.068	.012	**	PA4737	6	.942	0.427	.075	0.002
PA4478	6	1.233	0.559	.170	0.005	RS4634	1	6.450	2.926	1.812	0.051	PA4740	1	.400	0.181	.111	0.003
PA4479	6	.725	0.329	.115	0.003	RS4634XP	1	6.450	2.926	1.805	0.051	PA4741	1	5.650	2.563	1.179	0.033
PA4480	6	.917	0.416	.134	0.004	PA4635	1	2.350	1.066	.400	0.011	PA4750	6	.200	0.091	.031	0.001
PA4481	6	1.000	0.454	.138	0.004	RS4636	1	5.900	2.676	1.214	0.034	PA4753	1	.600	0.272	.171	0.005
PA4483	6	.833	0.378	.110	0.003	RS4637	1	2.000	0.907	.743	0.021	PA4754	6	.200	0.091	.017	**
PA4484	6	.650	0.295	.100	0.003	RS4638	1	8.650	3.924	2.048	0.058	PA4755	10	.445	0.202	.070	0.002
PA4485	6	1.100	0.499	.185	0.005	RS4639	1	3.100	1.406	.684	0.019	PA4756	6	.020	0.009	.019	0.001
PA4486	6	.475	0.215	.091	0.003	PA4640-FN	1	3.500	1.610	.767	0.022	PA4758	12	.254	0.115	.051	0.001
PA4487	6	1.100	0.499	.185	0.005	PA4641	1	2.700	1.225	.306	0.009	PA4760	12	.429	0.195	.064	0.002
PA4488	1	.500	0.227	.140	0.004	RS4642	1	8.600	3.901	2.123	0.060	PA4763	12	.417	0.189	.076	0.002
PA4489	1	.350	0.159	.116	0.003	RS4643	1	2.600	1.179	1.244	0.035	PA4764	6	.525	0.238	.074	0.002
PA4548	1	.750	0.340	.112	0.003	PA4644	1	2.750	1.247	.486	0.014	PA4766	1	1.150	0.522	.195	0.006
RS4549	1	2.600	1.179	.681	0.019	RS4646	1	6.950	3.153	1.762	0.050	PA4769	12	.358	0.162	.062	0.002
PA4551	12	.413	0.187	.056	0.002	PA4647	1	2.000	0.907	.300	0.008	PA4773	12	.530	0.240	.070	0.002
PA4552	12	.513	0.233	.057	0.002	PA4648	1	2.850	1.293	.293	0.008	RS4775	1	5.450	2.472	.935	0.026
PA4553	1	.700	0.318	.165	0.005	PA4649	1	1.900	0.862	.313	0.009	PA4778	12	.254	0.115	.029	0.001
PA4554	1	1.750	0.794	.273	0.008	PA4650-FN	1	4.850	2.200	1.144	0.032	PA4781	1	1.300	0.590	.307	0.009
PA4555	6	.300	0.136	.025	0.001	PA4651	1	1.550	0.703	.349	0.010	PA4793	6	1.025	0.465	.259	0.007
PA4557	6	.333	0.151	.064	0.002	PA4652	1	1.750	0.794	.211	0.006	RS4794	1	5.250	2.381	1.037	0.029
PA4559	1	8.500	0.386	.605	0.017	PA4653	1	17.050	7.734	1.885	0.053	PA4795	1	1.150	0.522	.292	0.008
PA4560	1	2.200	0.998	.692	0.020	PA4654 KIT	1	5.000	2.268	.406	0.011	PA4802	1	.950	0.431	.179	0.005
RS4561	1	7.650	3.470	1.408	0.040	PA4655	1	7.050	3.198	.917	0.026	RS4803	1	.950	0.431	.140	0.004
RS4562	1	5.250	2.381	1.473	0.042	PA4656	1	4.500	2.041	.650	0.018	RS4804	1	.550	0.249	.090	0.003
RS4563	1	7.050															

BALDWIN WEIGHTS AND VOLUMES

BALDWIN NUMBER	CASE QTY.	WEIGHT (ea.) lbs.	WEIGHT (ea.) kgs.	Volume (ea.) ft ³	Volume (ea.) m ³	BALDWIN NUMBER	CASE QTY.	WEIGHT (ea.) lbs.	WEIGHT (ea.) kgs.	Volume (ea.) ft ³	Volume (ea.) m ³	BALDWIN NUMBER	CASE QTY.	WEIGHT (ea.) lbs.	WEIGHT (ea.) kgs.	Volume (ea.) ft ³	Volume (ea.) m ³
PA4819	12	.496	.225	.064	.002	RS4968	1	5.350	2.427	.945	.027	BW5201	12	1.883	0.854	.051	.001
PA4820	12	.346	.157	.031	.001	RS4969	1	6.450	2.926	1.062	.030	BW5250	12	1.890	0.857	.049	.001
PA4823	6	.450	0.204	.075	.002	RS4970	1	5.350	2.427	.792	.022	PE5270	12	.333	0.151	.033	.001
PA4824	12	.387	0.176	.029	.001	RS4971	1	8.100	3.674	1.587	.045	PE5271	12	.404	0.183	.051	.001
PA4825	1	2.550	1.157	.465	.013	RS4972	1	3.750	1.701	.645	.018	PE5272	12	.446	0.202	.027	.001
PA4827	1	.650	0.295	.150	.004	PA4973	1	4.950	2.245	.740	.021	RS5273	1	.600	0.272	.089	.003
PA4829	6	.400	0.181	.076	.002	PA4977-FN	1	6.650	3.016	1.672	.047	PA5274	1	8.950	4.060	1.786	.051
PA4830	12	.408	0.185	.051	.001	PA4978	1	.050	0.023	.018	.001	PA5275	1	3.200	1.452	.681	.019
PA4833-FN	1	.950	0.431	.174	.005	PA4979	12	.508	0.230	.125	.004	PA5276	1	.088	0.040	.011	.001
PA4834-FN	1	.950	0.431	.140	.004	PA4983	1	2.400	1.089	.538	.015	CA5278	1	2.550	1.157	.389	.011
PA4848	2	.750	0.340	.243	.007	PA4984-FN	1	6.250	2.835	1.277	.036	PA5281	1	4.650	2.109	.522	.015
PA4852	12	.275	0.125	.039	.001	PA4985	6	.367	0.166	.093	.003	PA5282	6	.850	0.386	.116	.003
PA4852 FOAM	12	.400	0.181	.130	.004	PA4986	6	.758	0.344	.082	.002	PA5283	1	3.550	1.610	.329	.009
PA4853	12	.125	0.057	.029	.001	PA4987	6	.408	0.185	.059	.002	BA5284	4	5.687	2.580	.203	.006
PA4854	6	.150	0.068	.029	.001	RS4988	1	9.600	4.355	2.288	.065	RS5285	1	1.800	0.816	.346	.010
PA4855	12	.100	0.045	.024	.001	RS4989	1	13.450	6.101	3.115	.088	RS5287	1	14.200	6.441	3.064	.087
PA4857	6	.417	0.189	.112	.003	PA4991	1	2.400	1.089	.366	.010	RS5287XP	1	13.100	5.942	2.942	.083
PA4858	1	1.500	0.680	.372	.011	RS4992	1	4.450	2.019	.915	.026	RS5288	1	10.100	4.581	2.250	.064
RS4859	1	4.350	1.973	.853	.024	RS4993	1	8.450	3.833	1.966	.056	RS5288XP	1	9.350	4.241	2.287	.065
PA4860	1	17.350	7.870	1.885	.053	RS4994	1	2.250	1.021	.395	.011	PA5289	1	2.900	1.315	.516	.015
RS4861	1	5.800	2.631	1.192	.034	RS4995	1	.600	0.272	.124	.004	PA5290	1	.400	0.181	.060	.002
RS4862	1	7.300	3.311	1.640	.046	CA4996	1	1.300	0.590	.282	.008	RS5291	1	6.100	2.767	1.458	.041
RS4863	1	2.650	1.202	1.318	.037	PA4997	6	.625	0.284	.079	.002	RS5292	1	2.400	1.089	.638	.018
RS4864	1	4.050	1.837	.820	.023	CA4999	1	5.850	2.654	.814	.023	RS5293	1	24.400	11.068	6.233	.176
PA4870-FN	1	2.400	1.089	.475	.013	CFB5000	1	1.600	0.726	.090	.003	RS5293XP	1	27.150	12.315	6.368	.180
PA4871	1	1.250	0.567	.240	.007	CS5007	12	1.308	0.593	.035	.001	RS5294	1	7.850	3.561	2.344	.066
PA4872	12	.333	0.151	.030	.001	CS5008	12	1.200	0.544	.037	.001	PA5297	1	4.250	1.928	.589	.017
PA4874	12	1.109	0.503	.713	.020	CS5009	6	4.725	2.143	.148	.004	PA5298	1	1.450	0.658	.260	.007
PA4876	1	2.400	1.089	.440	.012	CS5010	1	49.420	22.417	1.356	.038	PA5299	1	4.600	2.087	.413	.012
PA4877	1	1.550	0.703	.266	.008	CS5011	1	524.000	237.686	10.623	.301	PA5300	1	3.300	1.497	.371	.010
PA4878	12	.267	0.121	.037	.001	CSC5012	4	9.862	4.473	.308	.009	RS5301	1	4.700	2.132	.979	.028
PA4879	12	.010	0.005	.002	.001	CSC5013	1	48.850	22.158	1.242	.035	PA5302	1	11.900	5.398	2.663	.075
PA4881	1	.600	0.272	.078	.002	CTK5028	1	.500	0.227	.033	.001	PA5303	1	18.000	8.165	3.876	.110
PA4883	12	.300	0.136	.023	.001	CTK5029	24	.190	0.086	.023	.001	RS5304	1	.850	0.386	.314	.009
PA4885	4	.100	0.045	.028	.001	CTK5029-M	24	.180	0.082	.026	.001	RS5305	1	2.100	0.953	.349	.010
PA4886	12	.638	0.289	.075	.002	CTK5029-1	1	.001	.001	.001	.001	PA5306	6	.850	0.386	.128	.004
PA4887	1	15.650	7.099	1.777	.050	CTK5029-4	1	.001	.001	.010	.001	PA5310	1	.600	0.272	.097	.003
PA4889	1	7.350	3.334	1.434	.041	CS5057	1	51.280	23.261	1.338	.038	PA5311	12	.383	0.174	.058	.002
PA4890	6	1.467	0.665	.234	.007	CS5058	6	5.050	2.291	.149	.004	PA5312 KIT	6	1.283	0.582	.199	.006
PA4891	12	.271	0.123	.018	.001	OTK5060	10	.050	0.023	.023	.001	RS5313	1	2.900	1.315	.683	.019
PA4893	1	.917	0.416	.189	.005	OTK5061	12	.020	0.009	.008	.001	PA5314	6	.750	0.340	.127	.004
PA4895	12	.304	0.138	.037	.001	OTK5063	10	.020	0.009	.011	.001	PA5315	1	2.900	1.315	.396	.011
PA4896	1	.300	0.136	.050	.001	BW5070	12	.979	0.444	.041	.001	PA5316	12	.096	0.044	.013	.001
PA4897	1	.900	0.408	.210	.006	BW5071	12	1.104	0.501	.041	.001	PA5317	6	.658	0.298	.165	.005
PA4900	1	.200	0.091	.042	.001	BW5072	12	1.133	0.514	.041	.001	PA5318	6	.742	0.337	.141	.004
PA4902	12	.421	0.191	.059	.002	BW5073	12	1.292	0.586	.050	.001	PA5319	6	.758	0.344	.101	.003
PA4903	1	1.300	0.590	.176	.005	BW5074	12	1.454	0.660	.053	.001	PA5320	6	.600	0.272	.118	.003
PA4905	12	.129	0.059	.029	.001	BW5075	12	1.521	0.690	.049	.001	PA5321	6	.517	0.235	.128	.004
PA4907	12	.533	0.242	.078	.002	BW5076	12	2.075	0.941	.066	.002	PA5323	1	15.500	7.031	4.002	.113
PA4908	12	.188	0.085	.062	.002	BW5082	12	1.217	0.552	.048	.001	RS5325	1	1.100	0.499	.176	.005
PA4911	12	.020	0.009	.016	.001	BW5086	12	1.500	0.680	.059	.002	PA5326	1	2.300	1.043	.231	.007
PA4912	1	.800	0.363	.111	.003	B5087	12	1.204	0.546	.062	.002	PA5327	6	.383	0.174	.045	.001
PA4918	1	1.600	0.726	.312	.009	B5088	12	1.025	0.465	.041	.001	PA5328	6	.900	0.408	.102	.003
PA4919	1	.700	0.318	.161	.005	B5089	12	.967	0.439	.041	.001	RS5329	1	1.950	0.885	.667	.019
PA4925	1	4.800	2.177	.909	.026	B5090	12	1.263	0.573	.051	.001	PA5331	1	1.950	0.885	.385	.011
PA4928	1	.400	0.181	.158	.004	B5091	12	1.096	0.497	.051	.001	RS5332	1	8.400	3.810	2.039	.058
PA4929	1	10.750	4.876	2.204	.062	P5092	10	.687	0.312	.060	.002	PA5333	6	.425	0.193	.064	.002
PA4930	1	.800	0.363	.113	.003	B5134	12	1.150	0.522	.050	.001	RS5334	1	3.150	1.429	.638	.018
PA4931	12	.020	0.009	.043	.001	BW5136	12	1.046	0.474	.042	.001	RS5335	1	.800	0.363	.315	.009
PA4932	6	.650	0.295	.125	.004	BW5137	12	1.071	0.486	.042	.001	PA5336	1	.850	0.386	.532	.015
PA4934	12	.554	0.251	.081	.002	BW5138	12	1.150	0.522	.049	.001	PA5337	6	.483	0.219	.080	.002
PA4935	12	.413	0.187	.063	.002	BW5139	12	1.325	0.601	.049	.001	PA5338-FN	1	2.400	1.089	.486	.014
PA4938	4	.850	0.386	.213	.006	BW5140	12	1.558	0.707	.065	.002	PA5339	6	.734	0.333	.160	.005
PA4939	12	.321	0.146	.052	.001	BW5141	12	1.196	0.543	.050	.001	PA5340	1	.700	0.318	.425	.012
PA4942	1	6.820	3.094	1.018	.029	BW5142	12	1.292	0.586	.051	.001	PA5341	6	.542	0.246	.124	.004
PA4945	1	.800	0.363	.433	.012	BW5143	12	1.475	0.669	.050	.001	RS5342	1	8.500	3.856	1.779	.050
PA4955	1	.850	0.386	.433	.012	B5144	12	.712	0.323	.051	.001	RS5343	1	9.500	4.309	2.284	.065
PA4956	1	.400	0.181	.118	.003	B5145	12	1.071	0.486	.041	.001	RS5344	1	5.250	2.381	1.215	.034
RS4959	1	7.800	3.538	1.602	.045	B5176	12	1.146	0.520	.049	.001	RS5345	1	.980	0.445	.312	.009
PA4960-FN	1	4.650	2.109	.865	.024	B5177	12	1.558	0.707	.069	.002	RS5347	1	1.150	0.522	.475	.013
PA4961	1	1.000	0.454	.227	.006	BW5178	12	1.279	0.580	.052	.001	RS5348	1	4.600	2.087	1.173	.033
RS4962	1	.450	0.204	.127	.004	BW5179	12	1.883	0.854	.070	.002	PA5350	1	.020	0.009	.067	.002
RS4963	1	7.550	3.425	.164	.005	BW5182	12	1.254	0.569	.046	.001	RS5351	1	2.800	1.270	.683	.019
RS4966	1	8.550	3.878	1.808	.051	BW5183	12	1.330	0.603	.050	.001	CA5352	1	3.050	1.383	.385	.011
RS4967	1	9.700	4.400	2.251	.06												

BALDWIN WEIGHTS AND VOLUMES

BALDWIN NUMBER	CASE QTY.	WEIGHT (ea.)		Volume (ea.)		BALDWIN NUMBER	CASE QTY.	WEIGHT (ea.)		Volume (ea.)		BALDWIN NUMBER	CASE QTY.	WEIGHT (ea.)		Volume (ea.)	
		lbs.	kgs.	ft ³	m ³			lbs.	kgs.	ft ³	m ³			lbs.	kgs.	ft ³	m ³
RS5354	1	5.900	2.676	1.289	0.036	PA5446	1	3.900	1.769	.901	0.025	RS5547	1	1.350	0.612	.334	0.009
RS5355	1	2.050	0.930	.486	0.014	RS5447	1	5.000	2.268	1.071	0.030	RS5548	1	1.500	0.680	.402	0.011
RS5356	1	8.150	3.697	1.887	0.053	RS5448	1	1.000	0.454	.272	0.008	RS5549	1	1.750	0.794	.563	0.016
PA5357	1	5.850	2.654	1.640	0.046	RS5449	1	850	0.386	.137	0.004	RS5550	1	.800	0.363	.172	0.005
RS5358	1	8.300	3.765	1.597	0.045	CA5450	1	1.750	0.794	.257	0.007	PA5554	1	1.800	0.816	.220	0.006
PA5359	6	.400	0.181	.094	0.003	PA5451	1	.550	0.249	.088	0.002	PA5557	1	1.800	0.816	.331	0.009
RS5360	1	7.000	3.175	1.301	0.037	RS5452	1	5.700	2.586	1.438	0.041	PA5556	1	4.800	2.177	.953	0.027
RS5361	1	1.800	0.816	.448	0.013	RS5453	1	1.350	0.612	.403	0.011	RS5558	1	4.350	1.973	1.035	0.029
PA5363	1	1.450	0.658	.136	0.004	PA5454	1	11.400	5.171	1.301	0.037	RS5559	1	1.750	0.794	.439	0.012
PA5364	1	12.100	5.489	2.177	0.062	RS5455	1	5.450	2.472	1.392	0.039	PA5563	1	1.300	0.590	.163	0.005
PA5365	1	3.650	1.656	.787	0.022	RS5456	1	2.550	1.157	.611	0.017	BA5566	4	5.750	2.608	.162	0.005
CA5366	1	3.850	1.746	.521	0.015	PA5457	12	1.479	0.671	.554	0.016	PA5580	6	.567	0.257	.147	0.004
CA5368	1	7.250	3.289	1.221	0.035	RS5458	1	5.800	2.631	1.278	0.036	PA5581	1	1.450	0.658	.202	0.006
CA5369	1	3.300	1.497	.494	0.014	RS5459	1	12.600	5.715	2.835	0.080	PA5583	1	1.150	0.522	.386	0.011
CA5370	1	2.850	1.293	.335	0.009	RS5460	1	4.650	2.109	1.320	0.037	PA5584	1	.800	0.363	.203	0.006
BA5371	1	6.200	2.812	1.129	0.004	RS5461	1	5.350	2.427	1.312	0.037	PA5585	1	.050	0.023	.065	0.002
BA5373	1	16.100	7.303	.398	0.011	RS5462	1	2.200	0.998	.692	0.020	PA5586	1	.150	0.068	.112	0.003
BA5374	4	6.160	2.794	.156	0.004	PA5463	1	17.400	7.893	4.616	0.131	BF5587-D	12	1.154	0.523	.060	0.002
BA5375	4	6.150	2.790	.175	0.005	PA5464	1	3.400	1.542	.853	0.024	PA5588	1	7.390	3.352	1.730	0.049
BA5376	4	5.530	2.508	.137	0.004	PA5465	1	10.450	4.740	2.465	0.070	PA5589	1	3.250	1.474	.677	0.019
BA5377	1	9.200	4.173	.220	0.006	PA5467	1	3.850	1.746	.552	0.016	RS5591XP	1	2.150	0.975	.419	0.012
BA5378	4	5.850	2.654	.179	0.005	PA5468	1	.800	0.363	.185	0.005	BA5592	4	5.750	2.608	.161	0.005
BA5379	4	5.888	2.671	.161	0.005	RS5470	1	9.600	4.355	2.610	0.074	RS5593XP	1	3.850	1.746	.755	0.021
RS5387 KIT	1	2.550	1.157	.727	0.021	RS5471	1	2.178	0.988	.703	0.020	PA5597	1	.400	0.181	.112	0.003
PA5388	1	4.350	1.973	.693	0.020	RS5472	1	10.800	4.899	2.620	0.074	PA5618	1	.550	0.249	.115	0.003
RS5389-FN	1	8.200	3.720	2.210	0.063	PA5475	1	.400	0.181	.132	0.004	PA5619	6	.708	0.321	.134	0.004
RS5390	1	8.800	3.992	1.859	0.053	PA5476	1	1.000	0.454	.158	0.004	PA5620	6	.358	0.162	.102	0.003
RS5391	1	6.300	2.858	1.308	0.037	PA5477	1	1.400	0.635	.260	0.007	PA5621	1	1.200	0.544	.238	0.007
RS5392	1	2.050	0.930	.421	0.012	RS5478-FN	1	3.600	1.633	1.018	0.029	PA5622	6	.375	0.170	.104	0.003
PA5393	6	.125	0.057	.033	0.001	RS5479	1	.750	0.340	.220	0.006	PA5623	6	1.267	0.575	.224	0.006
RS5395-FN	1	2.650	1.202	.615	0.017	PA5482	6	1.317	0.597	.198	0.006	PA5624	6	.250	0.113	.154	0.004
PA5396	1	.850	0.386	.183	0.005	RS5483	1	6.100	2.767	1.247	0.035	PA5625	1	.500	0.227	.060	0.002
RS5397	1	5.950	2.699	1.174	0.033	RS5484	1	7.800	3.538	1.662	0.047	PA5626	1	1.750	0.794	.309	0.009
RS5398	1	1.900	0.862	.387	0.011	PA5485-FN	1	5.050	2.291	1.089	0.031	RS5627	1	5.450	2.472	1.363	0.039
PA5399	1	.700	0.318	.163	0.005	PA5486	1	1.900	0.862	.469	0.013	RS5628	1	1.450	0.658	.630	0.018
PA5400	1	.750	0.340	.161	0.005	RS5488	1	6.880	3.121	1.843	0.052	PA5629	6	.542	0.246	.136	0.004
PA5401	1	.400	0.181	.095	0.003	RS5489	1	4.200	1.905	.867	0.025	PA5630	1	.150	0.068	.050	0.001
PA5403	1	.350	0.159	.072	0.002	RS5490	1	.750	0.340	.241	0.007	PA5631	6	.750	0.340	.153	0.004
PA5404	1	.750	0.340	.223	0.006	PA5491	1	4.350	1.973	.668	0.019	PA5632	6	1.192	0.541	.177	0.005
PA5405	1	.200	0.091	.044	0.001	PA5492	1	.750	0.340	.118	0.003	PA5633	6	.717	0.325	.083	0.002
RS5408	1	3.250	1.474	.518	0.015	PA5493	1	.350	0.159	.109	0.003	PA5636	1	4.250	1.928	.489	0.014
RS5409	1	5.250	2.381	.962	0.027	PA5494	6	.150	0.068	.037	0.001	PA5637	6	.500	0.227	.106	0.003
PA5410-FN	1	1.400	0.635	.229	0.006	PA5495	6	.280	0.127	.138	0.004	PA5638	6	.242	0.110	.065	0.002
RS5411	1	5.600	2.540	1.140	0.032	PA5496	1	6.350	2.880	.999	0.028	RS5641	1	2.350	1.066	.463	0.013
PA5412	1	2.400	1.089	.527	0.015	PA5497	1	2.440	1.107	.395	0.011	PA5642	1	.750	0.340	.307	0.009
RS5413	1	8.500	3.856	2.016	0.057	PA5498	1	9.350	4.241	1.565	0.044	PA5649	1	.700	0.318	.146	0.004
RS5414	1	11.350	5.148	2.447	0.069	PA5499	1	3.750	1.701	.543	0.015	PA5650	1	.500	0.227	.064	0.002
RS5415	1	3.400	1.542	.838	0.024	CA5500	1	10.700	4.854	1.639	0.046	PA5651	1	.300	0.136	.048	0.001
CA5416	1	2.900	1.315	.386	0.011	PA5503	1	5.350	2.427	.715	0.020	PA5652	1	1.100	0.499	.233	0.007
CA5417	1	4.200	1.905	.675	0.019	PA5504	1	1.950	0.885	.266	0.008	PA5653	1	3.100	1.406	.341	0.010
PA5418	1	.850	0.386	.183	0.005	PA5505	1	8.250	3.742	1.905	0.054	PA5654	1	2.400	1.089	.216	0.006
CA5419	1	8.100	3.674	1.177	0.033	RS5506	1	6.050	2.744	1.545	0.044	PA5655	1	2.600	1.179	.263	0.007
CA5420	1	6.050	2.744	1.081	0.031	RS5507	1	9.900	4.491	1.640	0.046	PA5656	1	1.250	0.567	.247	0.007
CA5421	1	4.950	2.245	.835	0.024	RS5508	1	7.300	3.311	1.533	0.043	PA5657	1	5.150	2.336	.541	0.015
RS5422	1	3.200	1.452	.616	0.017	RS5509	1	9.000	4.082	2.070	0.059	PA5658	6	.500	0.227	.104	0.003
PA5423-FN	1	2.039	0.925	.326	0.009	RS5510	1	2.750	1.247	.702	0.020	PA5661	6	.342	0.155	.047	0.001
RS5424	1	3.600	1.633	.839	0.024	PA5511	1	.500	0.227	.173	0.005	PA5662	6	.200	0.091	.063	0.002
PA5425	1	10.850	4.922	2.588	0.073	PA5512	1	.450	0.204	.112	0.003	PA5663	1	1.550	0.703	.119	0.003
PA5426	1	8.980	4.073	1.216	0.034	CA5514	1	3.900	1.769	.617	0.017	PA5664	1	1.150	0.522	.208	0.006
PA5428	6	1.742	0.790	.297	0.008	PA5515	1	1.050	0.476	.277	0.008	PA5665	1	1.850	0.839	.456	0.013
RS5429	1	7.050	3.198	1.595	0.045	PA5516	1	4.500	0.204	.165	0.005	PA5666	6	.783	0.355	.121	0.003
RS5430	1	2.850	1.293	1.163	0.033	RS5517	1	2.450	1.111	.404	0.011	PA5667	1	.900	0.408	.157	0.004
RS5431	1	3.650	1.656	.773	0.022	PA5528	1	6.300	2.858	1.319	0.037	PA5668	1	3.300	1.497	.329	0.009
RS5432	1	6.050	2.744	1.626	0.046	PA5529	1	2.450	1.111	.404	0.011	PA5669	6	.942	0.427	.125	0.004
RS5433	1	4.550	2.064	.929	0.026	RS5534	1	6.850	3.107	1.724	0.049	RS5670	1	1.450	0.658	.304	0.009
RS5434	1	3.450	1.565	.736	0.021	RS5535	1	5.050	2.291	.919	0.026	RS5672	1	8.200	3.720	1.874	0.053
RS5435	1	4.250	1.928	.947	0.027	RS5536	1	3.600	1.633	.768	0.022	RS5673	1	3.350	1.520	.876	0.025
PA5436	1	1.600	0.726	.578	0.016	RS5537	1	5.450	2.472	1.019	0.029	PA5674	1	15.850	7.190	2.773	0.078
PA5437	1	.500	0.227	.042	0.001	RS5538	1	6.000	2.722	1.486	0.042	RS5675	1	6.950	3.153	1.473	0.042
RS5438	1	4.500	2.041	.752	0.021	RS5539	1	2.150	0.975	.646	0.018	RS5676	1	1.000	0.454	.422	0.012
RS5440	1	6.350	2.880	1.745	0.049	RS5540	1	7.400	3.357	1.686	0.048	PA5678	1	.001	**	.064	0.002
RS5441																	

BALDWIN WEIGHTS AND VOLUMES

BALDWIN NUMBER	CASE QTY.	WEIGHT (ea.) lbs.	kgs.	Volume (ea.) ft ³	m ³	BALDWIN NUMBER	CASE QTY.	WEIGHT (ea.) lbs.	kgs.	Volume (ea.) ft ³	m ³	BALDWIN NUMBER	CASE QTY.	WEIGHT (ea.) lbs.	kgs.	Volume (ea.) ft ³	m ³
PA5683	6	.417	0.189	.078	0.002	PA5780	1	2.700	1.225	.225	0.006	BK6095	1	9.600	4.355	.524	0.015
RS5684	1	.650	0.295	.176	0.005	PA5781	1	2.400	1.089	.209	0.006	BK6096	1	4.100	1.860	.538	0.015
RS5685	1	2.650	1.202	.382	0.011	RS5782	1	2.900	1.315	.642	0.018	BK6097	1	5.100	2.313	.439	0.012
PA5686	1	2.850	1.293	.213	0.006	RS5783	1	.850	0.386	.305	0.009	BK6098	1	4.500	2.041	.751	0.021
PA5689	6	1.708	0.775	.408	0.012	RS5784	1	2.250	1.021	.395	0.011	BK6099	1	9.850	4.468	.538	0.015
PA5690	6	.350	0.159	.121	0.003	PA5785	1	3.850	1.746	.533	0.015	BK6100	1	8.300	3.765	.538	0.015
PA5691	6	.250	0.113	.095	0.003	PA5786	1	1.400	0.635	.257	0.007	BK6103	1	6.800	3.084	.524	0.015
RS5692	1	4.850	2.200	1.133	0.032	PA5787	1	3.900	1.769	.536	0.015	BK6104	1	10.600	4.808	.756	0.021
RS5693	1	5.450	2.472	1.309	0.037	CA5788	1	5.430	2.463	1.036	0.029	BK6105	1	9.100	4.128	.750	0.021
PA5694	6	.275	0.125	.099	0.003	CA5789	1	7.600	3.447	1.530	0.043	BK6106	1	6.800	3.084	.524	0.015
PA5695	1	.850	0.386	.134	0.004	CA5790	1	5.300	2.404	.903	0.026	BK6107	1	8.150	3.697	.748	0.021
PA5696	1	1.450	0.658	.235	0.007	CA5791	1	5.900	2.676	1.109	0.031	BK6108	1	6.700	3.039	1.252	0.035
PA5697	1	.650	0.295	.116	0.003	PA5792	1	1.350	0.612	.246	0.007	BK6110	1	6.150	2.790	1.462	0.041
PA5698	6	.392	0.178	.052	0.001	CA5793	1	2.650	1.202	.548	0.016	BK6112	1	4.550	2.064	1.101	0.031
PA5699	1	15.500	7.031	3.541	0.100	PA5796	1	1.550	0.703	.430	0.012	BK6114	1	9.700	4.400	.747	0.021
PA5700	12	.646	0.293	.035	0.001	PA5797	1	.400	0.181	.158	0.004	BK6115	1	9.000	4.082	.750	0.021
RS5707	1	7.100	3.221	1.611	0.046	PA5798	1	.300	0.136	.096	0.003	BK6116	1	10.800	4.899	.766	0.022
RS5708	1	2.600	1.179	.771	0.022	BF5800	12	1.425	0.646	.074	0.002	BK6117	1	12.400	5.625	.833	0.024
PA5710	1	1.650	0.748	.122	0.003	BF5801	12	1.400	0.635	.074	0.002	BK6118	1	9.950	4.513	.748	0.021
PA5711	1	3.750	1.701	.391	0.011	BF5810	12	1.296	0.588	.067	0.002	BK6120	1	9.000	4.082	.743	0.021
PA5712	1	2.100	0.953	.173	0.005	BF5812	12	1.513	0.686	.091	0.003	BK6121	1	10.700	4.854	.768	0.022
PA5713	1	.010	0.005	.070	0.002	BF5813	12	1.542	0.699	.088	0.002	BK6124	1	11.300	5.126	.787	0.022
PA5716	1	.001	**	.022	0.001	BF5813-O	12	1.388	0.630	.080	0.002	BK6138	1	11.850	5.375	.760	0.022
PA5719	1	.001	**	.010	**	BF5815	12	1.325	0.601	.067	0.002	BK6140	1	9.700	4.400	.752	0.021
PA5720	6	.866	0.393	.159	0.004	BF5816	12	1.367	0.620	.065	0.002	BK6161	1	2.450	1.111	.454	0.013
PA5722	6	.392	0.178	.081	0.002	6017	6	.558	0.253	.057	0.002	BK6167	1	5.650	2.563	.452	0.013
PA5723	6	.208	0.094	.042	0.001	6020	6	1.342	0.609	.140	0.004	BK6183	1	8.550	3.878	.736	0.021
PA5725	6	.675	0.306	.122	0.003	6021	6	.508	0.230	.059	0.002	BK6184	1	6.600	2.994	.598	0.017
PA5727	6	.050	0.023	.013	**	BK6022	1	7.850	3.561	.520	0.015	BK6185	1	12.050	5.466	.749	0.021
PA5728	6	.658	0.298	.073	0.002	BK6023	1	8.950	4.060	.839	0.024	BK6187	1	9.550	4.332	.736	0.021
PA5728 FOAM	6	.067	0.030	.031	0.001	BK6024	1	5.500	2.495	.423	0.012	BK6195	1	6.600	2.994	.423	0.012
PA5729	6	.550	0.249	.121	0.003	BK6025	1	7.050	3.198	.473	0.013	BK6196	1	7.900	3.583	.736	0.021
RS5730	1	8.500	3.856	1.967	0.056	BK6026	1	3.850	1.746	.747	0.021	BK6215	1	8.750	3.969	.736	0.021
RS5731	1	2.400	1.089	.585	0.017	BK6027	1	10.450	4.740	.831	0.024	BK6287	1	4.300	1.950	.423	0.012
PA5732	6	.117	0.053	.045	0.001	BK6028	1	18.690	8.478	1.167	0.033	BK6341	1	6.100	2.767	.530	0.015
PA5733	6	.483	0.219	.079	0.002	BK6029	1	10.650	4.831	.773	0.022	BK6375	1	6.750	3.062	.520	0.015
PA5734	1	1.200	0.544	.154	0.004	BK6031	1	5.550	2.517	.558	0.016	BK6376	1	5.700	2.586	.423	0.012
PA5735	1	10.450	4.740	1.459	0.041	BK6032	1	7.700	3.493	.559	0.016	BK6380	1	6.600	2.994	.423	0.012
PA5736	1	2.600	1.179	.257	0.007	BK6035	1	5.350	2.427	.453	0.013	BK6426	1	9.950	4.513	.720	0.020
PA5738	6	.667	0.303	.053	0.001	BK6045	1	6.950	3.153	.449	0.013	BK6429	1	7.650	3.470	.520	0.015
PA5739	1	1.500	0.680	.087	0.002	BK6049	1	5.650	2.563	.468	0.013	BK6438	1	7.300	3.311	.766	0.022
RS5741	1	2.200	0.998	.369	0.010	BK6050	1	21.850	9.911	1.683	0.048	BK6440	1	7.900	3.583	.530	0.015
RS5742	1	.650	0.295	.230	0.007	BK6051	1	11.500	5.216	.789	0.022	BK6457	1	12.750	5.783	.770	0.022
RS5743	1	21.400	9.707	5.055	0.143	BK6053	1	10.300	4.672	.775	0.022	BK6464	1	7.500	3.402	.735	0.021
RS5743XP	1	24.100	10.932	5.558	0.157	BK6054	1	10.600	4.808	.783	0.022	BK6467	1	6.000	2.722	.423	0.012
RS5744	1	6.550	2.971	1.675	0.047	BK6055	1	8.600	3.901	.728	0.021	BK6561	1	9.650	4.377	.520	0.015
RS5745	1	2.500	1.134	.419	0.012	BK6057	1	12.850	5.829	.764	0.022	BK6562	1	8.600	3.901	.554	0.016
RS5746	1	.800	0.363	.311	0.009	BK6058	1	10.400	4.717	.830	0.023	BK6579	1	9.550	4.332	.520	0.015
RS5747	1	1.800	0.816	.302	0.009	BK6059	1	9.850	4.468	.817	0.023	BK6583	1	6.700	3.039	.520	0.015
RS5748	1	.700	0.318	.233	0.007	BK6060	1	12.700	5.761	.997	0.028	BK6595	1	8.000	3.629	.521	0.015
RS5749	1	3.350	1.520	.638	0.018	BK6061	1	6.650	3.016	.539	0.015	BK6600	1	7.550	3.425	.520	0.015
RS5750	1	1.500	0.680	.396	0.011	BK6062	1	10.550	4.785	.792	0.022	BK6601	1	6.400	2.903	.429	0.012
PA5751	1	8.200	3.720	1.825	0.052	BK6064	1	10.650	4.831	.758	0.021	BK6610	1	6.600	2.994	.429	0.012
PA5752	1	2.000	0.907	.292	0.008	BK6065	1	3.300	1.497	.367	0.010	BK6613	1	10.850	4.922	.749	0.021
PA5753	6	.500	0.227	.107	0.003	BK6067	1	2.800	1.270	.447	0.013	BK6619	1	7.750	3.515	.551	0.016
RS5754	1	10.750	4.876	2.845	0.081	BK6068	1	11.100	5.035	.752	0.021	BK6634	1	7.650	3.470	.423	0.012
PA5755	1	3.150	1.429	.249	0.007	BK6069	1	12.350	5.602	.747	0.021	BK6650	1	10.270	4.658	.521	0.015
RS5756	1	6.650	3.016	1.694	0.048	BK6070	1	9.650	4.377	.539	0.015	BK6652	1	5.400	2.449	.611	0.017
PA5757	1	3.000	1.361	.218	0.006	BK6071	1	8.050	3.651	.541	0.015	BK6653	1	11.700	5.307	.854	0.024
RS5758	1	5.450	2.472	.987	0.028	BK6073	1	12.500	5.670	.774	0.022	BK6656	1	13.000	5.897	.849	0.024
RS5759	1	1.750	0.794	.414	0.012	BK6075	1	11.500	5.216	.790	0.022	BK6657	1	12.200	5.534	.749	0.021
RS5761	1	2.350	1.066	.362	0.010	BK6076	1	8.150	3.697	.766	0.022	BK6658	1	11.250	5.103	.846	0.024
PA5762	1	7.250	3.289	1.949	0.055	BK6080	1	5.950	2.699	.446	0.013	BK6659	1	11.000	4.990	.749	0.021
PA5763	1	3.800	1.724	.392	0.011	BK6081	1	9.800	4.445	.752	0.021	BK6661	1	1.300	0.590	.296	0.008
PA5764	1	.900	0.408	.120	0.003	BK6082	1	9.750	4.423	.536	0.015	BK6662	1	10.700	4.854	.739	0.021
PA5765	6	.617	0.280	.106	0.003	BK6083	1	10.850	4.922	.775	0.022	BK6663	1	10.150	4.604	.520	0.015
PA5766	6	1.558	0.707	.170	0.005	BK6085	1	9.500	4.309	.724	0.020	BK6665	1	10.400	4.717	.520	0.015
RS5767	1	4.550	2.064	1.116	0.032	BK6086	1	9.550	4.332	.748	0.021	BK6666	1	11.400	5.171	.753	0.021
PA5768	6	.433	0.196	.081	0.002	BK6087	1	2.850	1.293	.439	0.012	BK6670	1	11.050	5.012	.749	0.021
PA5770	6	.942	0.427	.165	0.005	BK6088	1	4.950	2.245	.730	0.021	BK6675	1	2.250	1.021	.640	0.018
PA5771	1	4.050	1.837	.274	0.008	BK6089	1	6.150	2.790	1.541	0.044	BK6676	1	3.650	1.656	.779	0.022
PA5772	6	.733	0.332	.111	0.003	BK6090	1	11.600	5.262	.779	0.022	BK6683	1	9.20			

BALDWIN WEIGHTS AND VOLUMES

BALDWIN NUMBER	CASE QTY.	WEIGHT (ea.) lbs.	WEIGHT (ea.) kgs.	Volume (ea.) ft ³	Volume (ea.) m ³	BALDWIN NUMBER	CASE QTY.	WEIGHT (ea.) lbs.	WEIGHT (ea.) kgs.	Volume (ea.) ft ³	Volume (ea.) m ³	BALDWIN NUMBER	CASE QTY.	WEIGHT (ea.) lbs.	WEIGHT (ea.) kgs.	Volume (ea.) ft ³	Volume (ea.) m ³
BK6696	1	10.600	4.808	.749	0.021	B7089	12	1.304	0.591	.062	0.002	P7188	12	500	0.227	.101	0.003
BK6700	1	10.250	4.649	.749	0.021	B7091	12	.913	0.414	.042	0.001	B7189	12	1.521	0.690	.059	0.002
BK6702	1	9.450	4.287	.520	0.015	P7092	12	1.308	0.593	.132	0.004	P7190	1	1.000	0.454	.127	0.004
BK6704	1	11.950	5.421	.749	0.021	P7093	12	1.787	0.811	.131	0.004	B7191	12	2.592	1.176	.123	0.003
BK6705	1	10.500	4.763	.736	0.021	BD7095	12	1.438	0.652	.069	0.002	P7192	1	.950	0.431	.241	0.007
BK6710	1	13.750	6.237	.749	0.021	B7097	1	3.650	1.656	.215	0.006	P7193	1	2.950	1.338	.321	0.009
BK6720	1	12.250	5.557	.749	0.021	B7099	12	1.104	0.501	.043	0.001	BC7194	12	.904	0.410	.062	0.002
BK6721	1	10.400	4.717	.749	0.021	P7102	1	2.800	1.270	.234	0.007	P7195	1	4.950	2.245	.460	0.013
BK6723	1	11.700	5.307	.749	0.021	P7103	12	.325	0.147	.034	0.001	P7196	12	.467	0.212	.066	0.002
BK6764	1	6.700	3.039	.551	0.016	P7104	12	.804	0.365	.080	0.002	B7197	12	1.121	0.508	.050	0.001
BK6780	1	15.300	6.940	2.532	0.072	BD7105	6	3.200	1.452	.136	0.004	P7199	12	.458	0.208	.056	0.002
BK6799	1	2.800	1.270	.221	0.006	P7106	12	1.517	0.688	.085	0.002	B7215	12	1.325	0.601	.064	0.002
BK6903	1	6.800	3.084	.598	0.017	P7107	12	.875	0.397	.120	0.003	B7216	12	.642	0.291	.033	0.001
BK6923	1	7.350	3.334	.520	0.015	B7113	12	1.875	0.851	.089	0.003	B7217	6	2.408	1.092	.119	0.003
BK6930	1	13.350	6.056	.749	0.021	P7114	12	.504	0.229	.062	0.002	B7219	12	1.454	0.660	.061	0.002
BK6934	1	6.750	3.062	.520	0.015	B7116	12	1.950	0.885	.087	0.002	B7220	12	1.042	0.473	.050	0.001
BK6942	1	12.100	5.489	.749	0.021	B7117	12	1.067	0.484	.053	0.001	B7221	12	.913	0.414	.052	0.001
BK6954	1	8.300	3.765	.809	0.023	B7119	12	.788	0.357	.032	0.001	B7222	12	.671	0.304	.030	0.001
BK6955	1	7.950	3.606	.750	0.021	B7121	12	2.021	0.917	.086	0.002	B7223	12	1.746	0.792	.070	0.002
BK6956	1	11.700	5.307	.783	0.022	B7124	12	1.646	0.747	.071	0.002	B7224	6	4.992	2.264	.230	0.007
BK6980	1	8.750	3.969	.578	0.016	B7125	12	1.296	0.588	.062	0.002	B7225	12	2.425	1.100	.121	0.003
BK6982	1	7.800	3.538	.736	0.021	P7126	1	4.050	1.837	.353	0.010	B7227	12	1.813	0.822	.086	0.002
BK6983	1	9.600	4.355	.854	0.024	P7127	1	2.750	1.247	.132	0.004	BC7228	12	1.142	0.518	.079	0.002
BK6984	1	24.850	11.272	2.921	0.083	B7128	12	1.088	0.494	.045	0.001	B7229	6	4.358	1.977	.222	0.006
BK6985	1	6.500	2.948	.591	0.017	V7129-C	7	5.021	2.278	.416	0.012	P7230	6	1.242	0.563	.208	0.006
BK6986	1	6.500	2.948	.520	0.015	B7130	12	1.662	0.754	.072	0.002	B7231	12	1.321	0.599	.069	0.002
BK6987	1	3.750	1.701	.489	0.014	B7131	12	1.529	0.694	.049	0.001	P7232	12	.575	0.261	.109	0.003
BK6997	1	2.850	1.293	.423	0.012	P7132	12	.140	0.064	.013	**	P7233	12	.917	0.416	.133	0.004
P7000 KIT	6	3.350	1.520	.454	0.013	P7134	12	.358	0.162	.038	0.001	P7235	12	.450	0.204	.081	0.002
B7001	12	1.167	0.529	.051	0.001	B7135	6	4.317	1.958	.225	0.006	BT7237	12	1.330	0.603	.060	0.002
P7003	3	3.933	1.784	.394	0.011	P7136	12	.275	0.125	.040	0.001	B7238	12	.654	0.297	.035	0.001
B7004	6	2.358	1.070	.123	0.003	P7137	12	.371	0.168	.049	0.001	B7239	6	2.367	1.074	.121	0.003
B7005	6	2.375	1.077	.122	0.003	P7138	12	.267	0.121	.039	0.001	B7240	12	1.038	0.471	.050	0.001
P7007	4	3.863	1.752	.508	0.014	B7139	12	.788	0.357	.036	0.001	B7241	6	2.667	1.210	.146	0.004
B7009	12	1.479	0.671	.071	0.002	BD7141	6	2.725	1.236	.120	0.003	BC7242	12	1.179	0.535	.081	0.002
B7010	12	.704	0.319	.036	0.001	B7142	12	1.900	0.862	.095	0.003	B7243	12	.725	0.329	.032	0.001
B7011	6	3.458	1.569	.268	0.008	B7143	12	1.475	0.669	.078	0.002	B7245	6	4.367	1.981	.224	0.006
P7012	4	4.838	2.195	.723	0.020	B7144	12	1.671	0.758	.072	0.002	B7246	6	3.450	1.565	.176	0.005
P7013	12	.638	0.289	.090	0.003	P7145	12	.475	0.215	.101	0.003	P7247	12	.158	0.072	.020	0.001
B7014	12	1.096	0.497	.051	0.001	B7151	12	2.167	0.983	.106	0.003	B7249-MPG	6	4.500	2.041	.227	0.006
P7015	12	.563	0.255	.079	0.002	B7152	12	.967	0.439	.051	0.001	BD7250	6	4.300	1.950	.210	0.006
P7016	12	.546	0.248	.099	0.003	BD7153	6	4.350	1.973	.203	0.006	BD7252	6	3.475	1.576	.149	0.004
P7017	12	.387	0.176	.056	0.002	BD7154	6	4.083	1.852	.171	0.005	P7255	12	.304	0.138	.051	0.001
B7018	12	1.754	0.796	.073	0.002	B7155	6	2.442	1.108	.119	0.003	P7256	12	.100	0.045	.014	**
B7019	6	2.650	1.202	.146	0.004	B7156	12	1.154	0.523	.054	0.002	P7259	12	.150	0.068	.008	**
B7020	12	.717	0.325	.035	0.001	B7157	6	4.292	1.947	.225	0.006	P7260	12	.150	0.068	.003	0.001
P7021	12	1.004	0.455	.119	0.003	BD7158	1	2.900	1.315	.133	0.004	P7263	12	.092	0.042	.011	**
B7022	12	1.179	0.535	.060	0.002	BD7159	6	2.117	0.960	.077	0.002	P7264	12	1.405	0.637	.128	0.004
B7023	12	1.229	0.557	.049	0.001	BD7160	1	1.450	0.658	.072	0.002	P7267	1	1.550	0.703	.194	0.005
B7024	12	.954	0.433	.050	0.001	B7161	6	3.550	1.610	.171	0.005	P7268	1	2.000	0.907	.149	0.004
B7025	12	1.179	0.535	.052	0.001	B7162	6	4.358	1.977	.231	0.007	P7269	12	.508	0.230	.063	0.002
B7026-MPG	12	1.188	0.539	.054	0.002	B7163	12	2.150	0.975	.076	0.002	B7271	12	1.163	0.528	.061	0.002
BD7028	12	1.917	0.870	.069	0.002	B7164	12	2.121	0.962	.095	0.003	B7273	12	1.163	0.528	.063	0.002
BD7029	12	1.783	0.809	.064	0.002	B7165	12	.629	0.285	.025	0.001	B7274	12	1.090	0.494	.044	0.001
B7030	6	4.333	1.965	.239	0.007	BD7166	6	2.700	1.225	.119	0.003	B7275	12	.779	0.353	.037	0.001
B7031	12	1.304	0.591	.062	0.002	B7167	12	.688	0.312	.027	0.001	B7276	12	.592	0.269	.031	0.001
B7033	12	.713	0.323	.033	0.001	BD7168	1	3.350	1.520	.171	0.005	B7277	12	.758	0.344	.037	0.001
B7034	12	1.246	0.565	.047	0.001	BD7169	6	2.117	0.960	.076	0.002	B7280	12	1.417	0.643	.056	0.002
P7035	12	1.000	0.454	.120	0.003	B7170	12	1.592	0.722	.078	0.002	B7281	12	.792	0.359	.036	0.001
B7039	12	1.833	0.831	.087	0.002	B7171	12	2.542	1.153	.107	0.003	B7283	12	.783	0.355	.044	0.001
B7042	12	1.183	0.537	.053	0.001	B7172	12	.737	0.334	.030	0.001	B7285	12	.525	0.238	.026	0.001
B7044	12	1.508	0.684	.063	0.002	BC7173	12	.892	0.405	.062	0.002	B7286	12	.546	0.248	.031	0.001
B7045	12	1.717	0.779	.071	0.002	B7174-MPG	12	2.692	1.221	.108	0.003	B7287	12	.629	0.285	.029	0.001
B7047	12	1.246	0.565	.044	0.001	B7175	6	4.392	1.992	.223	0.006	B7289	12	.725	0.329	.028	0.001
B7049	12	.621	0.282	.032	0.001	BD7176	6	4.867	2.208	.167	0.005	B7290	12	.780	0.354	.030	0.001
P7050	12	.567	0.257	.057	0.002	B7177	12	1.221	0.554	.067	0.002	B7291	12	1.079	0.489	.050	0.001
B7051	12	1.787	0.811	.070	0.002	P7178	12	.404	0.183	.034	0.001	B7292	12	.650	0.295	.020	0.001
P7052	12	1.204	0.546	.127	0.004	B7179	12	1.679	0.762	.071	0.002	B7293	12	.617	0.280	.030	0.001
P7053	12	.983	0.446	.119	0.003	B7180	6	4.392	1.992	.189	0.005	B7294	12	.679	0.308	.028	0.001
P7058	1	1.000	0.454	.116	0.003	B7181	12	1.204	0.546	.066	0.002	B7295	1	.646	0.293	.028	0.001
P7059	1	1.550	0.703	.189	0.005	B7182	6	3.683	1.671	.171	0.005	B7298	12	1.129	0.512	.051	0.001
P7081	12	.563	0.255	.065	0.002	P7183	4	4.200	1.905	.810	0.023	B7299	6	4.283	1.943	.225	0.006
B7082	12	1.167	0.529	.052	0.001	P7185	12	2.158	0.979	.							

BALDWIN WEIGHTS AND VOLUMES

BALDWIN NUMBER	CASE QTY.	WEIGHT (ea.) lbs.	WEIGHT (ea.) kgs.	Volume (ea.) ft ³	Volume (ea.) m ³	BALDWIN NUMBER	CASE QTY.	WEIGHT (ea.) lbs.	WEIGHT (ea.) kgs.	Volume (ea.) ft ³	Volume (ea.) m ³	BALDWIN NUMBER	CASE QTY.	WEIGHT (ea.) lbs.	WEIGHT (ea.) kgs.	Volume (ea.) ft ³	Volume (ea.) m ³
P7308	12	.333	.151	.050	.001	P7411	12	.150	.068	.017	**	P7512	12	1.833	.831	.143	.004
BD7309	6	3.508	1.591	.162	.005	P7413	12	.221	.100	.034	.001	B7513	6	2.583	1.172	.120	.003
BD7310	6	3.517	1.595	.160	.005	P7414	12	.254	.115	.048	.001	P7514	1	10.100	4.581	.587	.017
B7311-MPG	12	1.467	.665	.067	.002	P7415	12	.313	.142	.049	.001	P7515	12	.250	.113	.037	.001
P7312	6	2.234	1.013	.270	.008	B7416	6	2.575	1.168	.123	.003	B7516	12	1.354	.614	.063	.002
P7313	12	.142	.064	.024	.001	P7417	12	.217	.098	.038	.001	P7517	12	.254	.115	.037	.001
B7314	6	4.092	1.856	.222	.006	P7418	12	.225	.102	.048	.001	BF7519	12	.379	.172	.037	.001
BT7316	12	1.617	.733	.071	.002	B7419	12	.521	.236	.033	.001	BF7522	1	.900	.408	.077	.002
BD7317	12	1.558	.707	.069	.002	B7420	12	1.317	.597	.051	.001	BF7528	12	1.108	.503	.046	.001
B7318	12	.567	.257	.031	.001	B7422	12	.667	.303	.032	.001	BF7529	12	1.379	.626	.063	.002
P7319	12	.746	.338	.129	.004	P7423	12	.430	.195	.060	.002	BF7531	12	.917	.416	.040	.001
B7320	12	1.150	.522	.052	.001	B7424	12	1.046	.474	.052	.001	BF7532	12	1.504	.682	.057	.002
P7321	1	2.250	1.021	.182	.005	P7426	12	.225	.102	.033	.001	BF7534	12	1.496	.679	.056	.002
B7322	6	2.067	.938	.071	.002	P7427	12	.217	.098	.033	.001	BF7535	12	1.496	.679	.056	.002
B7324	6	2.417	1.096	.124	.004	B7428	12	.700	.318	.030	.001	BF7537	12	.624	.283	.050	.001
BD7325	6	2.717	1.232	.119	.003	B7430	12	.792	.359	.032	.001	BF7538	12	1.083	.491	.044	.001
BC7326	12	.779	.353	.091	.003	B7431	12	1.120	.508	.050	.001	BF7541	12	.904	.410	.046	.001
B7327	12	1.492	.677	.063	.002	B7432	12	.916	.415	.040	.001	BF7544	12	.704	.319	.030	.001
B7328	12	1.150	.522	.052	.001	B7433	12	.788	.357	.036	.001	PF7545	12	.075	.034	.011	**
P7329	6	1.042	.473	.173	.005	B7434	12	.725	.329	.033	.001	BF7546	12	1.321	.599	.069	.002
P7330	6	.475	.215	.142	.004	B7435	1	3.050	1.383	.125	.004	PF7549	12	.117	.053	.011	**
PT7332	1	1.142	.518	.109	.003	P7436	6	.950	.431	.118	.003	PF7550	12	.213	.097	.020	.001
B7333	12	.508	.230	.029	.001	P7437	12	1.146	.520	.122	.003	PF7551	12	.371	.168	.034	.001
B7334	12	.692	.314	.031	.001	P7438	12	.196	.089	.034	.001	BF7552	12	1.008	.457	.051	.001
B7335-MPG	6	2.925	1.327	.132	.004	B7440	12	1.408	.639	.049	.001	PF7553	12	.892	.405	.090	.003
P7336 KIT	12	.392	.178	.067	.002	B7441	12	.590	.268	.022	.001	PF7554	12	.633	.287	.081	.002
P7337	1	7.850	3.561	.678	.019	P7442	12	.163	.074	.023	.001	PF7556	1	.550	.249	.089	.003
P7338	12	.204	.093	.033	.001	B7443	12	.679	.308	.033	.001	BF7557	12	1.208	.548	.067	.002
BT7349	12	1.442	.654	.065	.002	B7444	12	.758	.344	.036	.001	BF7558	12	1.513	.686	.083	.002
B7350	12	1.671	.758	.062	.002	B7445	12	.763	.346	.028	.001	BF7559	12	1.079	.489	.044	.001
B7351-MPG	12	1.304	.591	.051	.001	B7446	12	.584	.265	.025	.001	BF7571	6	3.400	1.542	.266	.008
B7352	12	.770	.349	.028	.001	B7449	12	.729	.331	.033	.001	PF7572	12	.746	.338	.081	.002
B7356	12	.525	.238	.034	.001	P7450	12	.213	.097	.033	.001	BF7576	12	.500	.227	.029	.001
B7357	12	1.670	.758	.076	.002	B7451	12	1.310	.594	.054	.002	B7577	6	2.992	1.357	.144	.004
B7359	12	1.342	.609	.052	.001	B7452	12	1.133	.514	.055	.002	BF7579	12	.542	.246	.030	.001
B7360	12	1.196	.543	.053	.001	B7453	12	1.042	.473	.042	.001	BF7580	12	.467	.212	.030	.001
B7361	12	.675	.306	.031	.001	P7454	12	.129	.059	.021	.001	BF7584	12	2.158	.979	.109	.003
B7362	12	1.654	.750	.062	.002	P7455	12	.383	.174	.054	.002	B7585	12	1.721	.781	.082	.002
B7363	6	3.550	1.610	.260	.007	BC7456 KIT	12	.167	.076	.052	.001	BF7586	12	1.304	.591	.061	.002
P7364	12	.246	.112	.034	.001	B7457	12	1.317	.597	.055	.002	BF7587	12	1.992	.904	.097	.003
P7365	12	.288	.131	.037	.001	B7458	12	.950	.431	.035	.001	PF7588	12	.387	.176	.032	.001
B7367	12	1.695	.769	.080	.002	B7459	12	3.288	1.491	.142	.004	BF7591-D	12	.933	.423	.041	.001
P7368	12	1.846	.837	.191	.005	B7461	12	1.483	.673	.067	.002	PF7592	12	.621	.282	.064	.002
B7370	12	1.320	.599	.054	.002	B7467	12	1.204	.546	.053	.001	BF7593	12	1.371	.622	.050	.001
B7372	12	1.442	.654	.066	.002	B7468	12	2.954	1.340	.126	.004	PF7594	12	.725	.329	.062	.002
B7373	12	1.517	.688	.059	.002	B7469	12	1.271	.577	.054	.002	PF7595	12	.271	.123	.037	.001
B7375	12	1.375	.624	.067	.002	B7477	12	1.717	.779	.080	.002	PF7596	12	.258	.117	.033	.001
B7376	12	1.480	.671	.070	.002	B7483	12	2.317	1.051	.077	.002	PF7597	12	1.213	.550	.120	.003
B7377	12	1.242	.563	.057	.002	BC7485	12	1.029	.467	.091	.003	BF7598	12	.992	.450	.046	.001
B7378	12	1.621	.735	.078	.002	B7486	12	1.588	.720	.064	.002	B7600	12	2.292	1.040	.118	.003
B7379	12	1.446	.656	.066	.002	B7487	12	.767	.348	.028	.001	B7600-SS	12	2.396	1.087	.120	.003
P7380	12	1.800	.816	.199	.006	P7488	12	.263	.119	.041	.001	BF7602	12	1.017	.461	.044	.001
B7383	12	2.710	1.229	.101	.003	P7489	12	.163	.074	.034	.001	BF7606	12	1.287	.584	.067	.002
B7384	12	1.250	.567	.050	.001	P7490	12	.142	.064	.011	**	P7607	1	.500	.227	.077	.002
B7385	12	1.571	.713	.066	.002	B7491	12	.658	.298	.026	.001	BF7608	12	.771	.350	.032	.001
B7386	12	1.613	.732	.064	.002	P7492	12	.221	.100	.032	.001	BF7612	12	2.004	.909	.095	.003
B7387	12	1.409	.639	.065	.002	P7493	12	.108	.049	.035	.001	BF7613	12	2.479	1.124	.121	.003
B7388	12	1.258	.571	.056	.002	P7494	6	1.108	.503	.165	.005	BF7614	12	1.417	.643	.050	.001
B7390	12	.938	.425	.035	.001	P7495	1	3.150	1.429	.282	.008	P7615	12	.921	.418	.078	.002
B7393	12	2.188	.992	.093	.003	B7496	12	1.092	.495	.045	.001	PT7616	1	1.550	.703	.140	.004
BC7394	12	1.179	.535	.078	.002	B7497	12	1.533	.695	.074	.002	PT7617	12	3.446	1.563	.277	.008
B7395	12	1.404	.637	.053	.001	B7499	12	1.155	.524	.045	.001	PF7618	12	1.354	.614	.135	.004
B7396	6	2.908	1.319	.165	.005	F7500	4	5.438	2.467	.585	.017	BF7619	12	1.008	.457	.039	.001
B7397	12	1.871	.849	.086	.002	P7500	4	5.425	2.461	.582	.016	BF7623	6	3.383	1.535	.265	.007
P7398	12	.154	.070	.023	.001	B7501	12	2.454	1.113	.120	.003	BF7624	12	1.450	.658	.057	.002
P7399	12	.225	.102	.039	.001	P7502	6	.875	.397	.210	.006	BF7625	12	.196	.089	.034	.001
P7400	12	.275	.125	.275	.008	B7503	6	3.433	1.557	.178	.005	PF7627	6	.608	.276	.092	.003
B7401	12	.679	.308	.033	.001	BD7504	6	3.450	1.565	.162	.005	BF7628	12	1.858	.843	.074	.002
B7402	6	3.583	1.625	.171	.005	P7505	6	2.858	.843	.206	.006	BF7629	12	1.846	.837	.087	.002
B7403	12	1.133	.514	.046	.001	B7506	12	2.404	1.090	.122	.003	BF7630	1	1.000	.454	.399	.011
P7406	12	.250	.113	.040	.001	B7507	6	4.275	1.939	.238	.007	BF7631	12	1.975	.896	.096	.003
B7407	12	.750	.340	.033	.001	P7508	6	1.200	.544	.162	.005	BF7632	12	1.383	.627	.066	.002
P7408	12	.192	.087	.034	.001	BD7509	6	4.067	1.845	.170	.005	BF7633	12	1.338	.607	.065	.002
B7409	12	2.279	1.034	.122	.003	P7510	12	1.254	.569	.097	.003	BF7634	12	1.200	.544	.046	.001
B7410	12	.608	.276	.034	.001	B7511	12	1.050	.476	.050	.001	BF7635	6	3.992	1.811	.227	.006

* Sold in Full Cases Only. TBD To be Determined. ** Measurement is less than 0.001.



WARNING: These products can expose you to chemicals, including Diisononyl Phthalate, Carbon black extracts, Nickel, 1,3 Butadiene, Ethylene Oxide, Epichlorohydrin, which are known to the State of California to cause cancer, and Bisphenol-A, Ethylene Glycol, Ethylene Oxide, 1,3 Butadiene, Epichlorohydrin, which are known to the State of California to cause birth defects or other reproductive harm. For more information go to www.P65Warnings.ca.gov.

BALDWIN WEIGHTS AND VOLUMES

BALDWIN NUMBER	CASE QTY.	WEIGHT (ea.)		Volume (ea.)		BALDWIN NUMBER	CASE QTY.	WEIGHT (ea.)		Volume (ea.)		BALDWIN NUMBER	CASE QTY.	WEIGHT (ea.)		Volume (ea.)	
		lbs.	kgs.	ft ³	m ³			lbs.	kgs.	ft ³	m ³			lbs.	kgs.	ft ³	m ³
BF7637	12	1.104	0.501	.045	0.001	BF7759	12	1.371	0.622	.077	0.002	PF7852 KIT	12	471	0.214	.081	0.002
BF7639	6	4.433	2.011	.228	0.006	BF7760	12	1.260	0.572	.057	0.002	BF7853	12	1.862	0.845	.088	0.002
BF7639-D	6	4.392	1.992	.229	0.006	PF7761	12	575	0.261	.092	0.003	BF7855	12	.067	0.030	.011	**
BF7640	12	1.508	0.684	.065	0.002	BF7762	12	321	0.146	.038	0.001	BF7857	12	.010	0.005	.008	**
BF7644	12	1.533	0.695	.079	0.002	BF7763	1	1.050	0.476	.825	0.023	BF7859	6	.150	0.068	.017	**
BF7645	12	1.296	0.588	.062	0.002	BF7765	12	604	0.274	.046	0.001	BF7860	12	.010	0.005	.007	**
BF7648	12	817	0.371	.032	0.001	BF7766	12	2.292	1.040	.086	0.002	BF7863	12	.138	0.063	.022	0.001
BF7653	12	1.571	0.713	.075	0.002	PF7767	12	610	0.277	.100	0.003	BF7864	12	.079	0.036	.019	0.001
PF7655	12	1.125	0.510	.128	0.004	BF7768	12	367	0.166	.047	0.001	BF7865	12	.050	0.023	.015	**
BF7656	12	1.933	0.877	.095	0.003	BF7769	12	375	0.170	.046	0.001	BF7866	12	.746	0.338	.060	0.002
BF7657	12	2.517	1.142	.121	0.003	PF7770	12	2.150	0.975	.227	0.006	PF7869	12	.001	**	.008	**
BF7658	12	346	0.157	.037	0.001	BF7771	12	400	0.181	.046	0.001	BF7871	12	.571	0.259	.050	0.001
BF7659	12	504	0.229	.038	0.001	BF7772	12	1.096	0.497	.045	0.001	PF7872	12	200	0.091	.019	0.001
BF7661	12	408	0.185	.036	0.001	BF7773	12	2.100	0.953	.095	0.003	PF7873	12	.079	0.036	.012	**
BF7662	12	441	0.200	.031	0.001	BF7774	12	1.100	0.499	.051	0.001	PF7874	12	.100	0.045	.007	**
BF7663	12	929	0.421	.046	0.001	BF7775	12	413	0.187	.047	0.001	PF7875	12	.040	0.018	.007	**
BF7664	12	1.271	0.577	.051	0.001	BF7776	12	413	0.187	.047	0.001	PF7876	12	.355	0.161	.046	0.001
BF7666	12	946	0.429	.046	0.001	PF7777	12	392	0.178	.039	0.001	PF7877	12	.096	0.044	.016	**
BF7667	12	379	0.172	.038	0.001	BF7778	12	1.146	0.520	.061	0.002	PF7878	12	.640	0.290	.070	0.002
BF7668	12	379	0.172	.045	0.001	PF7779	12	.712	0.323	.062	0.002	BF7879	12	1.175	0.533	.051	0.001
BF7669	1	950	0.431	.752	0.021	BF7780	12	813	0.369	.126	0.004	BF7880	12	.683	0.310	.028	0.001
BF7670	12	667	0.303	.080	0.002	PF7782	6	850	0.386	.116	0.003	BF7881	12	400	0.181	.029	0.001
BF7671	1	750	0.340	.233	0.007	BF7783-D	12	629	0.285	.048	0.001	PF7882	12	.104	0.047	.029	0.001
BF7672-D	12	683	0.310	.054	0.002	BF7784-D	12	775	0.352	.053	0.001	BF7883	12	1.171	0.531	.045	0.001
BF7673-D	12	650	0.295	.050	0.001	BF7785-D	12	875	0.397	.064	0.002	BF7886	12	1.713	0.777	.056	0.002
BF7674-D	12	733	0.332	.052	0.001	BF7786-D	12	829	0.376	.064	0.002	BF7888	12	1.250	0.567	.050	0.001
BF7675-D	12	592	0.269	.041	0.001	PF7787	12	425	0.193	.050	0.001	PF7889	12	.638	0.289	.080	0.002
BF7677-D	12	854	0.387	.063	0.002	PF7788	12	438	0.199	.050	0.001	PF7889-10	12	.638	0.289	.081	0.002
PF7678	12	933	0.423	.100	0.003	BF7798-O	12	1.504	0.682	.116	0.003	PF7889-30	12	.596	0.270	.080	0.002
BF7679-D	12	688	0.312	.052	0.001	BF7798-SP	12	2.034	0.923	.091	0.003	PF7890	12	1.067	0.484	.131	0.004
PF7680	12	875	0.397	.079	0.002	PF7799	12	1.929	0.875	.236	0.007	PF7890-10	12	.996	0.452	.131	0.004
BF7681-D	12	612	0.278	.047	0.001	BF7800	12	413	0.187	.046	0.001	PF7890-30	12	1.025	0.465	.134	0.004
BF7682-D	12	771	0.350	.064	0.002	BF7801	12	675	0.306	.062	0.002	BF7892	12	.779	0.353	.036	0.001
BF7683	12	638	0.289	.032	0.001	BF7802	12	383	0.174	.046	0.001	PF7894	6	.925	0.420	.106	0.003
B7685	12	2.258	1.024	.124	0.004	BF7803	12	638	0.289	.061	0.002	PF7895	6	.891	0.404	.079	0.002
BF7686	12	108	0.049	.020	0.001	BF7804	12	621	0.282	.060	0.002	PF7896	12	.479	0.217	.066	0.002
PF7687	12	596	0.270	.047	0.001	BF7805	12	521	0.236	.077	0.002	BF7898-D	12	.779	0.353	.064	0.002
BF7690	12	313	0.142	.039	0.001	BF7806	12	1.342	0.609	.065	0.002	PF7899	1	1.250	0.567	.158	0.004
BF7691	12	238	0.108	.020	0.001	BF7806-O	12	1.088	0.494	.050	0.001	PF7900	1	1.700	0.771	.180	0.005
BF7693	12	246	0.112	.038	0.001	BF7808	12	375	0.170	.038	0.001	BF7903	12	.050	0.023	.013	**
BF7695	6	1.133	0.514	.104	0.003	BF7809	12	438	0.199	.047	0.001	BF7904-D	12	.550	0.249	.041	0.001
BF7696	12	1.538	0.698	.078	0.002	PF7812 KIT	12	529	0.240	.079	0.002	BF7905-D	12	.654	0.297	.053	0.001
BF7697	6	2.708	1.228	.141	0.004	BF7813	12	1.354	0.614	.066	0.002	BF7906-D	12	.771	0.350	.053	0.001
PF7698	12	996	0.452	.079	0.002	BF7814	12	2.521	1.144	.122	0.003	BF7907	12	1.183	0.537	.053	0.001
BF7699-D	12	683	0.310	.047	0.001	BF7815	12	1.446	0.656	.069	0.002	BF7908	12	1.450	0.658	.054	0.002
BF7700	12	2.421	1.098	.121	0.003	PF7816	12	175	0.079	.034	0.001	BF7909	12	.671	0.304	.032	0.001
BF7711	12	696	0.316	.130	0.004	PF7817	12	150	0.068	.016	**	PF7910	12	275	0.125	.032	0.001
BF7713	12	513	0.233	.094	0.003	PF7818	24	056	0.025	.011	**	BF7911	12	1.942	0.881	.087	0.002
PF7715	6	2.058	0.934	.271	0.008	PF7819	12	050	0.023	.015	**	BF7912	12	.300	0.136	.035	0.001
PF7716	1	2.450	1.111	.396	0.011	PF7820	12	050	0.023	.015	**	BF7913	6	3.433	1.557	.163	0.005
BF7717	12	1.933	0.877	.076	0.002	BF7821	12	783	0.355	.063	0.002	PF7914	1	1.700	0.771	.193	0.005
PF7718	12	1.204	0.546	.107	0.003	PF7822	30	070	0.032	.008	**	BF7915	12	.642	0.291	.031	0.001
BF7719	12	379	0.172	.046	0.001	PF7823	12	167	0.076	.022	0.001	PF7916	12	.254	0.115	.034	0.001
BF7720	12	450	0.204	.038	0.001	PF7824	30	065	0.029	.005	**	BF7917	12	1.417	0.643	.081	0.002
BF7721	12	879	0.399	.060	0.002	PF7825	12	146	0.066	.034	0.001	BF7919	12	1.229	0.557	.057	0.002
BF7725	12	107	0.030	.013	**	PF7826	12	221	0.100	.033	0.001	BF7921	12	1.063	0.482	.040	0.001
BF7726	12	1.125	0.510	.065	0.002	PF7828	6	100	0.045	.025	0.001	BF7922	12	1.596	0.724	.070	0.002
PF7733	12	1.204	0.546	.107	0.003	PF7830	12	020	0.009	.016	**	BF7923	12	1.379	0.626	.063	0.002
PF7734	12	1.258	0.571	.108	0.003	PF7832	12	171	0.078	.020	0.001	BF7924	12	1.454	0.660	.072	0.002
PF7735	12	538	0.244	.052	0.001	PF7833	12	221	0.100	.028	0.001	BF7925	12	1.288	0.584	.065	0.002
BF7736	12	090	0.041	.010	**	PF7836	12	179	0.081	.028	0.001	FD7926	1	.300	0.136	.062	0.002
BF7736-K1	12	229	0.104	.027	0.001	BF7837	12	688	0.312	.028	0.001	BF7927	12	1.967	0.892	.086	0.002
BF7742	12	467	0.212	.046	0.001	BF7838	12	917	0.416	.046	0.001	PF7928	12	1.154	0.523	.107	0.003
PF7744	12	821	0.372	.080	0.002	BF7839	20	600	0.272	.029	0.001	BF7929 KIT	1	2.650	1.202	.185	0.005
BF7745-D	12	654	0.297	.045	0.001	BF7840	12	683	0.310	.029	0.001	PF7930	6	1.075	0.488	.108	0.003
BF7746-D	12	888	0.403	.064	0.002	BF7841	12	792	0.359	.036	0.001	BF7931	12	.990	0.449	.030	0.001
BF7747	12	1.242	0.563	.053	0.001	BF7842	12	1.221	0.554	.060	0.002	BF7932	6	4.159	1.887	.147	0.004
PF7748	12	904	0.410	.080	0.002	BF7843	12	001	**	.004	**	PF7934 KIT	12	1.004	0.455	.128	0.004
PF7749	12	1.479	0.671	.130	0.004	BF7844	12	892	0.405	.078	0.002	PF7935	12	.717	0.325	.104	0.003
BF7750	12	1.146	0.520	.053	0.001	BF7845	12	188	0.085	.020	0.001	PF7936	12	.567	0.257	.067	0.002
PF7751	12	508	0.230	.071	0.002	BF7847	12	179	0.081	.021	0.001	BF7937	12	.671	0.304	.079	0.002
BF7753	12	2.046	0.928	.099	0.003	BF7848	12	100	0.045	.025	0.001	PF7938	6	.650	0.295	.074	0.002
PF7755	12	842	0.382	.081													

BALDWIN WEIGHTS AND VOLUMES

BALDWIN NUMBER	CASE QTY.	WEIGHT (ea.) lbs.	WEIGHT (ea.) kgs.	Volume (ea.) ft ³	Volume (ea.) m ³	BALDWIN NUMBER	CASE QTY.	WEIGHT (ea.) lbs.	WEIGHT (ea.) kgs.	Volume (ea.) ft ³	Volume (ea.) m ³	BALDWIN NUMBER	CASE QTY.	WEIGHT (ea.) lbs.	WEIGHT (ea.) kgs.	Volume (ea.) ft ³	Volume (ea.) m ³
BF7942	12	1.704	0.773	.075	0.002	BT8328	12	1.421	0.645	.052	0.001	PT8433-MPG	1	3.200	1.452	.314	0.009
BF7943	12	2.671	1.212	.121	0.003	PT8329	12	1.229	0.557	.129	0.004	PT8435-MPG	1	1.950	0.885	.140	0.004
BF7944	12	.409	0.186	.031	0.001	PT8330-MPG	6	1.242	0.563	.143	0.004	PT8436	1	4.300	1.950	.464	0.013
BF7945	12	.583	0.264	.037	0.001	PT8331-MPG	1	2.650	1.202	.146	0.004	BT8437	6	3.542	1.607	.151	0.004
PF7946	6	.783	0.355	.159	0.004	BT8333	6	1.617	0.733	.085	0.002	BT8439-MPG	6	2.375	1.077	.091	0.003
PF7947	12	.808	0.367	.132	0.004	PT8334	6	3.250	1.474	.327	0.009	BT8440-MPG	12	1.471	0.667	.064	0.002
BF7948	6	3.017	1.369	.161	0.005	PT8335	6	2.292	1.040	.225	0.006	PT8441	1	2.000	0.907	.238	0.007
BF7949-D	12	.770	0.349	.060	0.002	PT8338	12	1.233	0.559	.134	0.004	PT8442	1	3.050	1.383	.232	0.007
BF7949-DM	12	.750	0.340	.063	0.002	PT8339	12	1.108	0.503	.106	0.003	BT8443	12	1.696	0.769	.076	0.002
BF7950-D	12	.650	0.295	.045	0.001	PT8341	12	.238	0.108	.020	0.001	BT8444	12	2.158	0.979	.076	0.002
BF7951-D	12	.750	0.340	.062	0.002	PT8344	12	.833	0.378	.101	0.003	BT8445	12	1.117	0.507	.053	0.001
BF7952-D	12	.617	0.280	.051	0.001	PT8345	12	.725	0.329	.081	0.002	PT8446-MPG	1	3.550	1.610	.214	0.006
BF7954-D	12	.629	0.285	.051	0.001	BT8347	6	1.733	0.786	.104	0.003	PT8447-MPG	1	3.250	1.474	.231	0.007
BF7955	12	1.425	0.646	.055	0.002	PT8350	12	.579	0.263	.048	0.001	P8448	12	1.375	0.624	.088	0.002
BF7956-D	12	.583	0.264	.061	0.002	PT8351	12	.533	0.242	.063	0.002	BT8449	12	1.388	0.630	.060	0.002
BF7957	12	1.758	0.797	.064	0.002	PT8352	12	.387	0.176	.037	0.001	BT8449-10	12	1.433	0.650	.062	0.002
BF7958	12	1.038	0.471	.085	0.002	PT8353	6	1.792	0.813	.208	0.006	BT8450	12	2.713	1.231	.124	0.004
BF7959	12	.588	0.267	.047	0.001	PT8354	12	.454	0.206	.047	0.001	PT8451-MPG	1	.450	0.204	.020	0.001
BF7960	12	.383	0.174	.047	0.001	PT8355	12	.408	0.185	.048	0.001	PT8452	12	.996	0.452	.101	0.003
BF7961	12	.488	0.221	.037	0.001	PT8356	12	.638	0.289	.080	0.002	PT8453	4	2.000	0.907	.197	0.006
BF7962	12	.567	0.257	.064	0.002	BT8357	12	1.304	0.591	.063	0.002	PT8455-MPG	1	3.650	1.656	.321	0.009
BF7963	12	.542	0.246	.037	0.001	PT8359	1	1.700	0.771	.176	0.005	PT8456-MPG	1	1.700	0.771	.116	0.003
BF7964-D	12	.834	0.378	.068	0.002	PT8361	1	4.950	2.245	.650	0.018	BT8457-MPG	6	5.617	2.548	.243	0.007
BF7965	12	.938	0.425	.080	0.002	PT8363	12	1.450	0.658	.111	0.003	PT8458-MPG	1	.950	0.431	.048	0.001
BF7966	12	1.721	0.781	.065	0.002	PT8366	12	1.400	1.860	.464	0.013	BT8459	12	.921	0.418	.099	0.003
BF7967	12	.858	0.389	.030	0.001	BT8368	6	3.783	1.716	.267	0.008	BT8460	12	.950	0.431	.031	0.001
BF7968	12	1.079	0.489	.044	0.001	PT8370-MPG	12	1.938	0.879	.132	0.004	PT8461	6	2.433	1.104	.268	0.008
BF7968-O	12	1.075	0.488	.052	0.001	PT8371-MPG	6	3.558	1.523	.269	0.008	PT8462-MPG	12	1.188	0.539	.089	0.003
BF7969	12	.710	0.322	.026	0.001	PT8372	12	.150	0.068	.016	**	BT8463-MPG	6	2.442	1.108	.090	0.003
BF7970	12	1.330	0.603	.060	0.002	PT8375-MPG	6	1.725	0.782	.144	0.004	BT8464	6	2.208	1.002	.089	0.003
BF7971-D	12	.729	0.331	.063	0.002	PT8376-MPG	6	3.934	1.784	.454	0.013	BT8465	6	3.490	1.583	.138	0.004
BF7971-DM	12	.742	0.337	.063	0.002	PT8378-MPG	1	1.800	0.816	.111	0.003	BT8466-MPG	1	3.400	1.542	.113	0.003
BF7972	12	.929	0.421	.062	0.002	PT8380	1	5.450	2.472	.465	0.013	PT8467	1	2.300	1.043	.170	0.005
PF7973	1	1.850	0.839	.239	0.007	BT8381	6	5.010	2.273	.264	0.007	PT8468	12	.587	0.266	.037	0.001
PF7974	12	.071	0.032	.011	**	BT8382	6	3.925	1.780	.227	0.006	PT8470	12	.971	0.440	.100	0.003
PF7975	12	.050	0.023	.003	**	PT8383	1	4.400	1.996	.464	0.013	BT8471-MPG	1	3.800	1.724	.230	0.007
BF7976	12	1.108	0.503	.060	0.002	BT8384	12	1.133	0.514	.040	0.001	BT8472	12	1.221	0.554	.052	0.001
PF7977	12	.438	0.199	.040	0.001	PT8385	12	.696	0.316	.040	0.001	BT8473	12	1.608	0.729	.078	0.002
PF7978	12	.583	0.264	.065	0.002	BT8386	12	.396	0.180	.032	0.001	BT8474	12	1.542	0.699	.080	0.002
BF7979	12	1.808	0.820	.081	0.002	PT8387	1	3.000	1.361	.245	0.007	BT8475	12	2.488	1.129	.115	0.003
PF7980	1	2.200	0.998	.334	0.009	PT8388	1	3.300	1.497	.258	0.007	BT8475-MPG	6	3.170	1.438	.130	0.004
BF7981	12	1.458	0.661	.063	0.002	BT8391	12	1.088	0.494	.053	0.001	BT8476	6	2.892	1.312	.146	0.004
PF7982	12	.642	0.291	.071	0.002	PT8392	12	.196	0.089	.021	0.001	BT8476-MPG	6	3.575	1.622	.155	0.004
PF7983	12	.704	0.319	.087	0.002	BT8393	12	1.608	0.729	.079	0.002	BT8477	6	2.775	1.259	.150	0.004
PF7984	12	.816	0.370	.089	0.003	PT8394-MPG	1	2.850	1.293	.236	0.007	BT8477-MPG	6	3.658	1.659	.156	0.004
BF7985	12	1.442	0.654	.050	0.001	PT8395	1	9.250	4.196	.641	0.018	PT8478	1	5.850	2.654	.683	0.019
PF7986	12	.558	0.253	.080	0.002	PT8396	1	9.950	4.513	.646	0.018	PT8479	1	1.450	0.658	.198	0.006
BF7987	12	1.671	0.758	.052	0.001	BT8397-MPG	1	3.400	1.542	.118	0.003	PT8480	1	5.000	2.268	.325	0.009
BF7988	12	1.646	0.747	.052	0.001	PT8400-MPG	1	1.000	0.454	.091	0.003	PT8481	12	.750	0.340	.063	0.002
BF7989-D	12	.690	0.313	.060	0.002	BT8401-MPG	6	4.820	2.186	.226	0.006	PT8484	12	1.046	0.474	.059	0.002
BF7990	12	1.220	0.553	.043	0.001	PT8403-MPG	12	1.300	0.590	.111	0.003	PT8485	12	.317	0.144	.049	0.001
BF7993	12	1.288	0.584	.066	0.002	PT8404-MPG	12	2.525	1.145	.122	0.003	BT8486	12	.983	0.446	.051	0.001
PF7994	12	.100	0.045	.023	0.001	PT8407	12	.563	0.255	.081	0.002	PT8487	12	.712	0.323	.083	0.002
BF7995	12	1.288	0.584	.062	0.002	BT8408	1	3.100	1.406	.342	0.010	BT8488	12	1.704	0.773	.076	0.002
BF7996	6	4.280	1.941	.239	0.007	BT8409	12	.667	0.303	.029	0.001	PT8489	1	1.700	0.771	.276	0.008
BF7997	12	2.070	0.939	.074	0.002	PT8410	1	3.500	1.588	.626	0.018	PT8490-MPG	1	1.950	0.885	.304	0.009
BF7998	12	1.050	0.476	.045	0.001	PT8411	1	2.850	1.293	.319	0.009	PT8491	1	6.250	2.835	.464	0.013
BT8301	12	.933	0.423	.045	0.001	BT8412	12	1.396	0.633	.090	0.003	PT8492	1	6.200	2.812	.683	0.019
BT8302	12	2.083	0.945	.109	0.003	BT8413	12	.904	0.410	.028	0.001	BT8493	12	1.229	0.557	.049	0.001
BT8304	12	1.496	0.679	.062	0.002	PT8414-MPG	1	2.600	1.179	.198	0.006	PT8494	1	3.050	1.383	.340	0.010
PT8305	4	2.825	1.281	.532	0.015	BT8415	12	1.658	0.752	.080	0.002	PT8495-MPG	1	1.750	0.794	.295	0.008
PT8306-10	12	1.325	0.601	.100	0.003	BT8416	6	1.900	0.862	.088	0.002	PT8496-MPG	12	2.121	0.962	.187	0.005
PT8306-25	12	1.287	0.584	.098	0.003	BT8417	12	1.088	0.494	.032	0.001	BT8497-MPG	12	1.987	0.901	.086	0.002
BT8307-MPG	6	2.750	1.247	.156	0.004	BT8418	6	2.375	1.077	.129	0.004	BT8498	1	1.000	0.454	.050	0.001
BT8308-MPG	6	3.650	1.656	.263	0.007	PT8419	12	1.075	0.488	.080	0.002	BT8499	12	.929	0.421	.051	0.001
BT8308-MPG KIT	1	7.050	3.198	.924	0.026	BT8420	12	1.213	0.550	.051	0.001	BT8501-MPG	12	1.608	0.729	.049	0.001
BT8309-MPG	1	2.650	1.202	.148	0.004	BT8421-MPG	1	2.650	1.202	.136	0.004	BT8502	12	1.162	0.527	.050	0.001
BT8310-MPG	1	3.550	1.610	.230	0.007	BT8422-MPG	6	3.575	1.622	.264	0.007	BT8503-MPG	6	3.958	1.795	.127	0.004
BT8312	6	2.900	1.315	.132	0.004	BT8423	1	2.650	1.202	.162	0.005	BT8504	12	1.275	0.578	.062	0.002
BT8314	12	1.050	0.476	.053	0.001	PT8425	1	.600	0.272	.112	0.003	BT8505	12	1.125	0.510	.053	0.001
BT8316-MPG	12	1.350	0.612	.061	0.002	BT8426-MPG	6	2.450	1.111	.091	0.003	PT8506-MPG	1	2.850	1.293	.229	0.006

BALDWIN WEIGHTS AND VOLUMES

BALDWIN NUMBER	CASE QTY.	WEIGHT (ea.) lbs.	WEIGHT (ea.) kgs.	Volume (ea.) ft ³	Volume (ea.) m ³	BALDWIN NUMBER	CASE QTY.	WEIGHT (ea.) lbs.	WEIGHT (ea.) kgs.	Volume (ea.) ft ³	Volume (ea.) m ³	BALDWIN NUMBER	CASE QTY.	WEIGHT (ea.) lbs.	WEIGHT (ea.) kgs.	Volume (ea.) ft ³	Volume (ea.) m ³
BT8512	12	1.875	0.851	.062	0.002	PT8893	6	2.084	0.945	.204	0.006	PT8995-MPG	1	250	0.113	.014	**
PT8517-MPG	1	3.100	1.406	.318	0.009	PT8894-MPG	1	400	0.181	.015	**	PT8996-MPG	1	350	0.159	.016	**
PT8519-MPG	1	1.800	0.816	.188	0.005	PT8895-MPG	1	400	0.181	.018	0.001	PT8997-MPG	1	1.550	0.703	.110	0.003
OP8709	1	.030	0.014	.001	**	PT8896	1	4.500	2.041	.464	0.013	PT8998-MPG	1	200	0.091	.012	**
OB8711	1	1.700	0.771	.071	0.002	PT8897-MPG	1	2.250	1.021	.117	0.003	PT8999-MPG	1	.750	0.340	.053	0.001
OB8712	1	1.850	0.839	.072	0.002	BT8898	12	1.100	0.499	.054	0.002	H9001	1	3.100	1.406	.228	0.006
OB8720	1	1.600	0.726	.072	0.002	BT8899	6	3.383	1.535	.241	0.007	H9007	1	5.950	2.699	.430	0.012
OB8721	1	1.700	0.771	.075	0.002	BT8900	12	1.463	0.664	.067	0.002	H9013	1	13.700	6.214	.966	0.027
OB8722	1	1.700	0.771	.072	0.002	BT8901-MPG	6	2.740	1.243	.130	0.004	H9014	1	12.150	5.511	.936	0.026
OB8724	1	1.650	0.748	.073	0.002	BT8902	12	.750	0.340	.036	0.001	H9020	1	6.650	3.016	.494	0.014
OB8731	1	1.650	0.748	.072	0.002	BT8903	12	1.500	0.680	.084	0.002	H9021	1	6.950	3.153	.501	0.014
OB8732	1	1.700	0.771	.074	0.002	BT8904-MPG	6	2.367	1.074	.089	0.003	H9024	1	9.500	4.309	.970	0.027
OB8741	1	1.600	0.726	.072	0.002	BT8905	12	1.088	0.494	.050	0.001	H9036	1	1.700	0.771	.144	0.004
OB8742	1	1.600	0.726	.072	0.002	BT8906	6	3.342	1.516	.137	0.004	H9041	1	300	0.136	.017	**
OB8743	1	1.600	0.726	.072	0.002	PT8907-MPG	12	1.042	0.473	.070	0.002	H9042	1	300	0.136	.023	0.001
OB8744	1	1.600	0.726	.073	0.002	BT8908	12	.700	0.318	.029	0.001	H9043	1	350	0.159	.023	0.001
OB8745	1	1.600	0.726	.074	0.002	PT8909	1	4.400	1.996	.464	0.013	H9043-V	1	350	0.159	.023	0.001
OP8750	12	.058	0.026	.065	0.002	BT8910-MPG	6	5.092	2.310	.222	0.006	H9044	1	300	0.136	.019	0.001
OP8751	12	.040	0.018	.065	0.002	BT8911-MPG	6	4.950	2.245	.222	0.006	H9045	1	550	0.249	.041	0.001
OP8752	12	.010	0.005	.003	**	PT8912	12	1.671	0.758	.188	0.005	H9046	1	500	0.227	.037	0.001
OP8753	12	.010	0.005	.004	**	BT8913-MPG	12	1.671	0.758	.062	0.002	H9047	1	500	0.227	.035	0.001
OB8771	1	2.600	1.179	.103	0.003	BT8914	12	1.612	0.731	.081	0.002	H9048	1	500	0.227	.035	0.001
OB8772	1	2.700	1.225	.102	0.003	BT8915	1	3.450	1.565	.197	0.006	H9049	1	450	0.204	.021	0.001
OB8773	1	2.250	1.021	.106	0.003	BT8916	12	800	0.363	.037	0.001	H9050	1	200	0.091	.014	**
CFB8784	1	1.750	0.794	.071	0.002	BT8917	12	.708	0.321	.029	0.001	H9051	1	950	0.431	.032	0.001
BT8800-MPG	1	4.600	2.087	.227	0.006	BT8918	12	1.104	0.501	.049	0.001	H9052	1	500	0.227	.038	0.001
BT8801-MPG	6	3.658	1.659	.148	0.004	BT8919	12	1.338	0.607	.063	0.002	H9054	1	600	0.272	.020	0.001
BT8802-MPG	6	3.517	1.595	.148	0.004	BT8920	12	2.296	1.041	.112	0.003	H9055	1	900	0.408	.019	0.001
BT8803-MPG	6	3.667	1.663	.264	0.007	BT8922	12	1.779	0.807	.059	0.002	H9056	1	950	0.431	.020	0.001
BT8805-MPG	1	5.050	2.291	.231	0.007	BT8926	12	1.900	0.862	.079	0.002	H9058	1	2.550	1.157	.178	0.005
BT8812-MPG	6	3.508	1.591	.147	0.004	BT8927	6	2.858	1.296	.124	0.004	H9060	1	2.750	1.247	.173	0.005
BT8813-MPG	1	4.250	1.928	.231	0.007	BT8928	12	1.683	0.763	.061	0.002	H9062	1	4.150	1.882	.281	0.008
BT8830	6	1.817	0.824	.083	0.002	BT8930	6	2.825	1.281	.125	0.004	H9069	1	800	0.363	.044	0.001
BT8831	1	1.900	0.862	.090	0.003	BT8931	6	3.158	1.432	.154	0.004	H9070	1	700	0.318	.036	0.001
BT8832	6	2.067	0.938	.115	0.003	BT8935	12	1.483	0.673	.059	0.002	H9071	1	750	0.340	.034	0.001
BT8833	6	2.092	0.949	.118	0.003	BT8937	6	3.033	1.376	.128	0.004	H9072	1	750	0.340	.037	0.001
BT8834-MPG	1	3.250	1.474	.098	0.003	PT8939-MPG	1	1.700	0.771	.138	0.004	H9072-V	1	700	0.318	.033	0.001
BT8840-MPG	6	2.258	1.024	.091	0.003	PT8940-MPG	1	1.250	0.567	.040	0.001	H9073	1	1.150	0.522	.058	0.002
BT8841-MPG	6	2.292	1.040	.091	0.003	PT8941-MPG	1	4.400	1.996	.338	0.010	H9074	1	1.100	0.499	.059	0.002
BT8842-MPG	6	2.233	1.013	.091	0.003	PT8943-MPG	1	15.950	7.235	1.161	0.033	H9075	1	1.100	0.499	.059	0.002
BT8843-MPG	6	2.358	1.070	.092	0.003	PT8945-MPG	1	1.550	0.703	.097	0.003	H9075-V	1	1.150	0.522	.059	0.002
BT8844	6	2.208	1.002	.089	0.003	PT8946-MPG	1	500	0.227	.030	0.001	H9076	1	1.100	0.499	.058	0.002
BT8845	6	2.192	0.994	.090	0.003	PT8947-MPG	1	1.650	0.748	.123	0.003	H9076-V	1	1.150	0.522	.059	0.002
BT8846	6	2.300	1.043	.092	0.003	PT8948-MPG	1	800	0.363	.053	0.001	H9077	1	1.850	0.839	.149	0.004
BT8847	6	2.433	1.104	.090	0.003	PT8950-MPG	1	4.800	2.177	.363	0.010	H9078	1	1.600	0.726	.090	0.003
BT8848-MPG	6	2.700	1.225	.130	0.004	PT8951-MPG	1	2.550	1.157	.201	0.006	H9078-V	1	1.750	0.794	.160	0.005
BT8849-MPG	6	2.333	1.058	.091	0.003	PT8952-MPG	1	400	0.181	.015	**	H9079	1	1.650	0.748	.090	0.003
BT8850-MPG	6	3.133	1.421	.130	0.004	PT8954-MPG	1	500	0.227	.022	0.001	H9080	1	1.650	0.748	.090	0.003
BT8851-MPG	6	3.017	1.369	.129	0.004	PT8955-MPG	1	1.300	0.590	.033	0.001	H9081	1	1.600	0.726	.090	0.003
BT8852-MPG	6	3.075	1.531	.133	0.004	PT8956-MPG	1	700	0.318	.042	0.001	H9082	1	1.700	0.771	.093	0.003
BT8853-MPG	6	3.075	1.395	.130	0.004	PT8957-MPG	1	350	0.159	.026	0.001	H9083	1	2.300	1.043	.177	0.005
BT8855-MPG	6	3.067	1.391	.130	0.004	PT8958-MPG	1	1.100	0.499	.125	0.004	H9084	1	2.100	0.953	.117	0.003
BT8856-MPG	6	3.275	1.486	.127	0.004	PT8959-MPG	1	1.000	0.454	.054	0.002	H9085	1	2.150	0.975	.117	0.003
BT8861	6	2.983	1.353	.128	0.004	PT8960-MPG	1	200	0.091	.009	**	H9086	1	2.200	0.998	.118	0.003
BT8862	6	2.900	1.315	.132	0.004	PT8962-MPG	1	250	0.113	.013	**	H9087	1	2.000	0.907	.117	0.003
BT8863	6	3.008	1.364	.132	0.004	PT8967-MPG	1	2.000	0.907	.154	0.004	H9092	1	2.600	1.179	.095	0.003
BT8870-MPG	6	5.617	2.548	.276	0.008	PT8969-MPG	1	2.500	1.134	.211	0.006	H9093	1	4.300	1.950	.146	0.004
BT8873	6	4.550	2.064	.221	0.006	PT8970-MPG	1	3.100	1.406	.314	0.009	H9096	1	1.150	0.522	.059	0.002
BT8874-MPG	6	4.658	2.113	.224	0.006	PT8971-MPG	1	3.550	1.610	.396	0.011	H9097	1	1.050	0.476	.068	0.002
BT8875-MPG	6	3.692	1.675	.157	0.004	PT8972-MPG	1	250	0.113	.015	**	H9103	1	2.500	1.134	.068	0.002
BT8876-MPG	6	4.950	2.245	.221	0.006	PT8974-MPG	1	550	0.249	.033	0.001	H9107	1	500	0.227	.017	**
BT8877-MPG	6	4.725	2.143	.223	0.006	PT8975-MPG	1	300	0.136	.013	**	H9108	1	500	0.227	.018	0.001
BT8878-MPG	6	4.733	2.147	.222	0.006	PT8978-MPG	1	650	0.295	.037	0.001	H9110	1	500	0.227	.017	**
BT8879-MPG	6	5.142	2.332	.225	0.006	PT8980-MPG	1	1.500	0.680	.067	0.002	H9111	1	550	0.249	.066	0.002
BT8880-MPG	6	3.658	1.659	.156	0.004	PT8981-MPG	1	3.750	1.701	.194	0.005	H9112	1	700	0.318	.039	0.001
PT8883	12	.992	0.450	.079	0.002	PT8982-MPG	1	1.600	0.726	.131	0.004	H9113	1	800	0.363	.041	0.001
PT8884-MPG	12	1.783	0.809	.109	0.003	PT8984-MPG	1	700	0.318	.032	0.001	H9114	1	700	0.318	.040	0.001
PT8885-MPG	12	1.933	0.877	.130	0.004	PT8985-MPG	1	1.400	0.635	.072	0.002	H9123	1	2.400	1.089	.190	0.005
BT8886-MPG	6	2.530	1.148	.130	0.004	PT8986-MPG	1	550	0.249	.034	0.001	PT9129	1	1.350	0.612	.166	0.005
PT8887	1	.550	0.249	.037	0.001	PT8987-MPG	1	500	0.227	.030	0.001	PT9131	12	.387	0.176	.034	0.001
PT8888	12	.946	0.429	.130	0.004	PT8989-MPG	1	600	0.272	.043	0.001	PT9132	1	800	0.363	.069	0.002
PT8889	4	3.113	1.412	.366	0.010	PT8990-MPG	1	8.800	3.992	.898	0.025	PT9134	12	.267	0.121	.020	0.001
BT8																	

BALDWIN WEIGHTS AND VOLUMES

BALDWIN NUMBER	CASE QTY.	WEIGHT (ea.) lbs.	WEIGHT (ea.) kgs.	Volume (ea.) ft ³	Volume (ea.) m ³	BALDWIN NUMBER	CASE QTY.	WEIGHT (ea.) lbs.	WEIGHT (ea.) kgs.	Volume (ea.) ft ³	Volume (ea.) m ³	BALDWIN NUMBER	CASE QTY.	WEIGHT (ea.) lbs.	WEIGHT (ea.) kgs.	Volume (ea.) ft ³	Volume (ea.) m ³
PT9139	1	1.150	0.522	.133	0.004	PT9267	1	.400	0.181	.024	0.001	PT9373-MPG	1	2.400	1.089	.114	0.003
PT9140	1	.375	0.170	.026	0.001	PT9268	1	1.800	0.816	.082	0.002	PT9374	12	.521	0.236	.052	0.001
PT9142	12	.150	0.068	.016	0.001	PT9272	1	2.500	1.134	.238	0.007	PT9375	4	3.600	1.633	.366	0.010
PT9143	12	.408	0.185	.082	0.002	PT9277	1	1.700	0.771	.161	0.005	PT9376	1	2.150	0.975	.171	0.005
PT9144	12	.996	0.452	.101	0.003	PT9278	1	.700	0.318	.056	0.002	BT9377	1	3.950	1.792	.229	0.006
PT9145	1	.700	0.318	.033	0.001	PT9279	1	1.050	0.476	.090	0.003	PT9378-MPG	1	.500	0.227	.024	0.001
PT9148	1	1.450	0.658	.141	0.004	PT9282-MPG	1	.650	0.295	.024	0.001	PT9379	1	6.150	2.790	.683	0.019
PT9149	1	1.150	0.522	.053	0.001	PT9283-MPG	1	5.100	2.313	.332	0.009	PT9380-MPG	12	2.575	1.168	.139	0.004
PT9150	1	1.100	0.499	.053	0.001	PT9284-MPG	1	1.250	0.567	.082	0.002	PT9381-MPG	1	1.450	0.658	.114	0.003
PT9152	1	1.350	0.612	.060	0.002	PT9286-MPG	1	.800	0.363	.038	0.001	BT9382	12	1.271	0.577	.055	0.002
PT9153	1	.850	0.386	.040	0.001	PT9287-MPG	1	.500	0.227	.030	0.001	PT9383-MPG	1	6.000	2.722	.551	0.016
PT9157	1	.800	0.363	.039	0.001	PT9288-MPG	1	2.850	1.293	.249	0.007	PT9384-MPG	1	1.350	0.612	.049	0.001
PT9158	1	1.100	0.499	.054	0.002	PT9289-MPG	1	.450	0.204	.024	0.001	PT9385-MPG	1	3.400	1.542	.322	0.009
PT9161	1	2.200	0.998	.134	0.004	PT9290-MPG	1	3.350	1.520	.253	0.007	PT9386-MPG	12	1.333	0.605	.140	0.004
PT9162	1	3.450	1.565	.211	0.006	PT9291-MPG	1	1.300	0.590	.095	0.003	BT9387	6	3.892	1.765	.165	0.005
BT9164	1	4.750	2.155	.211	0.006	PT9293-MPG	1	.650	0.295	.033	0.001	BT9388	12	.571	0.259	.028	0.001
PT9165	1	.600	0.272	.031	0.001	PT9296-MPG	1	.450	0.204	.024	0.001	PT9389-MPG	1	1.400	0.635	.114	0.003
PT9167	1	.500	0.227	.038	0.001	PT9297-MPG	1	1.850	0.839	.103	0.003	PT9390-MPG	1	1.800	0.816	.091	0.003
PT9168	1	2.150	0.975	.212	0.006	PT9300-MPG	1	1.150	0.522	.059	0.002	BT9391-MPG	6	4.800	2.177	.221	0.006
PT9169	10	1.830	0.830	.127	0.004	PT9303-MPG	1	2.800	1.270	.139	0.004	BT9392-MPG	6	2.533	1.149	.131	0.004
PT9170	1	1.600	0.726	.123	0.003	PT9304-MPG	1	.750	0.340	.022	0.001	BT9393-MPG	6	1.500	0.680	.085	0.002
PT9172	1	2.050	0.930	.139	0.004	PT9306-MPG	1	3.800	1.724	.396	0.011	PT9394-MPG	12	.863	0.391	.051	0.001
PT9174	12	.600	0.272	.042	0.001	PT9307-MPG	1	1.050	0.476	.056	0.002	PT9395-MPG	6	1.100	0.499	.141	0.004
PT9175	1	1.267	0.575	.090	0.003	PT9308-MPG	1	.300	0.136	.015	0.001	PT9396	12	.467	0.212	.038	0.001
PT9176	1	2.100	0.953	.239	0.007	PT9309-MPG	1	.650	0.295	.031	0.001	PT9397-MPG	1	1.950	0.885	.113	0.003
PT9178	1	.500	0.227	.032	0.001	PT9310-MPG	1	.250	0.113	.014	0.001	BT9398-MPG	6	1.975	0.896	.085	0.002
PT9179	1	.300	0.136	.018	0.001	PT9311-MPG	1	.400	0.181	.016	0.001	PT9399-MPG	1	5.050	2.291	.474	0.013
PT9180	12	.400	0.181	.023	0.001	PT9313-MPG	1	1.550	0.703	.067	0.002	BT9400-MPG	6	2.558	1.160	.105	0.003
PT9181	1	1.300	0.590	.110	0.003	PT9315 KIT	1	.700	0.318	.043	0.001	PT9401	1	2.700	1.225	.300	0.008
PT9183	1	2.150	0.975	.205	0.006	BT9316-MPG	1	2.100	0.953	.088	0.002	BT9402	12	1.113	0.505	.039	0.001
PT9185	12	.429	0.195	.037	0.001	BT9318	12	1.467	0.665	.044	0.001	PT9504-MPG	1	1.700	0.771	.111	0.003
PT9186	1	.750	0.340	.044	0.001	BT9320	1	3.217	1.459	.128	0.004	PT9403-MPG	1	5.200	2.359	.244	0.007
PT9187	1	.500	0.227	.040	0.001	BT9321	12	1.517	0.688	.069	0.002	PT9404-MPG	1	.700	0.318	.036	0.001
PT9188	1	1.500	0.680	.131	0.004	BT9324	6	2.958	1.342	.124	0.004	PT9405	12	1.479	0.671	.121	0.003
PT9189	1	2.900	1.315	.252	0.007	BT9326	1	1.000	0.454	.021	0.001	PT9406-MPG	1	.950	0.431	.033	0.001
PT9191	1	2.950	1.338	.387	0.011	H9327	1	.400	0.181	.020	0.001	PT9407-MPG	1	2.400	1.089	.231	0.007
PT9193	1	.500	0.227	.025	0.001	PT9328-MPG	1	9.150	4.150	.968	0.027	BT9408	12	.725	0.329	.031	0.001
PT9195	1	.350	0.159	.017	0.001	PT9329	12	.521	0.236	.035	0.001	PT9409-MPG	1	1.400	0.635	.072	0.002
PT9196	1	.900	0.408	.072	0.002	PT9330-MPG	1	.550	0.249	.024	0.001	PT9410-MPG	1	1.850	0.839	.093	0.003
PT9197	1	.550	0.249	.040	0.001	PT9331	1	1.250	0.567	.115	0.003	PT9411-MPG	1	2.650	1.202	.210	0.006
PT9199	1	1.300	0.590	.136	0.004	PT9337-MPG	12	.204	0.093	.008	0.001	PT9413-MPG	12	1.713	0.777	.120	0.003
PT9203	1	.450	0.204	.032	0.001	PT9338-MPG	1	6.300	2.858	.464	0.013	PT9414-MPG	12	.588	0.267	.038	0.001
PT9208	1	.300	0.136	.013	0.001	PT9340-MPG	1	2.900	1.315	.221	0.006	PT9415-MPG KIT	1	2.600	1.179	.181	0.005
PT9209	1	.300	0.136	.013	0.001	PT9341	1	1.700	0.771	.143	0.004	PT9416-MPG KIT	1	1.900	0.862	.128	0.004
PT9210	1	.350	0.159	.030	0.001	PT9342-MPG	12	1.517	0.688	.100	0.003	PT9417	12	.242	0.110	.035	0.001
PT9212	1	1.900	0.862	.184	0.005	BT9343-MPG	6	3.900	1.769	.149	0.004	PT9418	12	1.746	0.792	.189	0.005
PT9214	12	.650	0.295	.056	0.002	PT9344	12	.725	0.329	.082	0.002	PT9419-MPG	12	.542	0.246	.038	0.001
PT9215	1	.600	0.272	.057	0.002	BT9345	6	3.367	1.527	.264	0.007	PT9420-MPG	1	1.250	0.567	.088	0.002
PT9217	1	2.600	1.179	.247	0.007	BT9346-MPG	12	1.450	0.658	.061	0.002	BT9421-MPG	6	5.633	2.555	.224	0.006
PT9222	1	.100	0.045	.022	0.001	BT9347-MPG	6	5.345	2.424	.168	0.005	BT9422	6	3.080	1.397	.140	0.004
PT9223	1	.400	0.181	.026	0.001	PT9348-MPG	1	7.500	3.402	.464	0.013	PT9423	12	.325	0.147	.022	0.001
PT9224	1	.900	0.408	.081	0.002	BT9349-MPG	6	1.658	0.752	.084	0.002	PT9424	12	.129	0.059	.011	0.001
PT9225	1	.550	0.249	.034	0.001	PT9350-MPG	1	10.300	4.672	1.250	0.035	PT9425-MPG	6	2.100	0.953	.176	0.005
PT9227	1	1.550	0.703	.015	0.001	PT9351-MPG	1	2.650	1.202	.213	0.006	PT9426	12	.133	0.060	.009	0.001
PT9228	1	.400	0.181	.031	0.001	PT9352	1	2.050	0.930	.189	0.005	PT9427-MPG	6	5.183	2.351	.337	0.010
H9231	1	.600	0.272	.030	0.001	BT9353-MPG	6	5.183	2.351	.224	0.006	PT9429-MPG	1	2.850	1.293	.182	0.005
PT9237	1	.450	0.204	.040	0.001	PT9354-MPG	12	.688	0.312	.040	0.001	PT9430-MPG	12	2.083	0.945	.140	0.004
PT9238	12	1.104	0.501	.080	0.002	PT9355-MPG	1	10.900	4.944	.639	0.018	PT9432-MPG	1	2.450	1.111	.201	0.006
PT9239	12	.505	0.229	.030	0.001	BT9356	6	2.575	1.168	.127	0.004	BT9433	6	3.250	1.474	.129	0.004
PT9240	1	.250	0.113	.015	0.001	PT9357	1	4.850	2.200	.464	0.013	PT9434	12	.683	0.310	.063	0.002
PT9242	1	.600	0.272	.040	0.001	BT9358	1	3.000	1.361	.076	0.002	PT9435-MPG	12	.375	0.170	.037	0.001
PT9244	1	4.650	2.109	.338	0.010	PT9359-MPG	1	2.400	1.089	.138	0.004	BT9436-MPG	6	2.433	1.104	.091	0.003
PT9245	1	1.550	0.703	.131	0.004	BT9360	1	6.350	2.880	.182	0.005	BT9439	6	2.900	1.315	.154	0.004
PT9247	1	7.350	3.334	.614	0.017	PT9361	1	4.400	1.996	.464	0.013	BT9440	6	1.833	0.831	.066	0.002
PT9248	1	.700	0.318	.051	0.001	BT9362-MPG	6	4.708	2.136	.222	0.006	PT9441-MPG	6	3.742	1.697	.329	0.009
PT9250	1	3.500	1.588	.397	0.011	BT9363-MPG	6	3.183	1.444	.130	0.004	PT9442-MPG	12	1.217	0.552	.051	0.001
PT9251	1	3.000	1.361	.236	0.007	BT9364	6	2.242	1.017	.089	0.003	PT9443	1	4.450	2.019	.263	0.007
PT9254	1	2.150	0.975	.195	0.006	BT9365-MPG	6	4.950	2.245	.227	0.006	PT9444-MPG	6	3.925	1.780	.328	0.009
PT9255	1	.350	0.159	.015	0.001	BT9366-MPG	6	3.325	1.508	.131	0.004	PT9445-MPG	1	4.300	1.950	.375	0.011
PT9256-MPG	1	.550	0.249	.040	0.001	BT9367-MPG	6	5.467	2.480	.169	0.005	PT9446	12	1.642	0.745	.123	0.003
PT9258	1	2.100	0.953	.203	0.006	BT9368-MPG	6	3.450	1.565	.110	0.003	PT9447	12	1.038	0.471	.071	0.002
PT9260	12	.538															

BALDWIN WEIGHTS AND VOLUMES

BALDWIN NUMBER	CASE QTY.	WEIGHT (ea.) lbs.	WEIGHT (ea.) kgs.	Volume (ea.) ft ³	Volume (ea.) m ³	BALDWIN NUMBER	CASE QTY.	WEIGHT (ea.) lbs.	WEIGHT (ea.) kgs.	Volume (ea.) ft ³	Volume (ea.) m ³	BALDWIN NUMBER	CASE QTY.	WEIGHT (ea.) lbs.	WEIGHT (ea.) kgs.	Volume (ea.) ft ³	Volume (ea.) m ³
PT9452	1	5.000	2.268	.500	0.014	BT9561	12	1.250	0.567	.047	0.001	BF9880	12	2.790	1.266	.144	0.004
BT9454	1	4.150	1.882	.124	0.004	P9600	12	1.175	0.079	.022	0.001	BF9881	12	1.029	0.467	.075	0.002
BT9456	12	1.200	0.544	.046	0.001	B9601	12	1.908	0.865	.092	0.003	BF9883	12	1.383	0.627	.067	0.002
PT9459-MPG	1	15.500	7.031	1.015	0.029	P9602	12	2.58	0.117	.029	0.001	BF9884	12	0.71	0.032	.010	**
PT9462	12	.363	0.165	.020	0.001	P9603	12	1.104	0.047	.012	**	BF9885	6	4.217	1.913	.140	0.004
BT9464	12	1.917	0.870	.099	0.003	B9604	12	2.330	1.057	.121	0.003	BF9886	12	3.00	0.136	.018	0.001
BT9465	12	1.092	0.495	.054	0.002	P9605	12	1.183	0.083	.029	0.001	BF9887	12	0.975	0.442	.046	0.001
BT9466-MPG	6	3.350	1.520	.138	0.004	B9606	12	2.440	1.107	.134	0.004	BF9888	6	2.533	1.149	.147	0.004
PT9468	1	.450	0.204	.015	**	B9607	12	2.320	1.052	.134	0.004	PF9889	12	0.833	0.378	.085	0.002
PT9469	12	1.100	0.045	.007	**	BF9800	12	2.654	1.204	.122	0.003	PF9890	12	0.592	0.269	.050	0.001
PT9470	12	1.075	0.488	.019	0.001	PF9801	12	3.88	0.176	.040	0.001	BF9891-D	12	0.850	0.386	.063	0.002
BT9471	12	1.117	0.507	.041	0.001	BF9802	12	2.660	1.207	.123	0.003	BF9892-D	12	0.642	0.291	.048	0.001
PT9472	1	3.050	1.383	.295	0.008	PF9803	12	0.538	0.244	.051	0.001	BF9893	12	1.333	0.605	.068	0.002
S9475	12	0.013	0.006	.005	**	PF9804	6	2.408	1.092	.259	0.007	BF9894	12	1.279	0.580	.068	0.002
PT9476-MPG	6	1.250	0.567	.159	0.004	BF9805	12	0.510	0.231	.048	0.001	BF9895 KIT	6	1.342	0.609	.173	0.005
PT9477	1	.250	0.113	.016	**	BF9807	12	0.313	0.142	.037	0.001	PF9897	12	0.671	0.304	.061	0.002
PT9478-MPG	1	3.000	0.136	.013	**	BF9808-D	12	0.617	0.280	.047	0.001	BF9898-O	12	1.642	0.745	.108	0.003
PT9479-MPG	1	1.450	0.658	.081	0.002	BF9809-D	12	0.925	0.420	.088	0.002	PF9899	12	0.675	0.306	.057	0.002
PT9481-MPG	1	.250	0.113	.025	0.001	BF9810-D	12	0.767	0.348	.064	0.002	PF9901 KIT	12	0.729	0.331	.102	0.003
PT9482-MPG	1	.550	0.249	.024	0.001	BF9811-SP	12	2.308	1.047	.101	0.003	PF9902	12	1.183	0.083	.055	0.002
PT9483-MPG	1	2.950	1.338	.197	0.006	BF9812	12	1.208	0.548	.067	0.002	BF9903-SP	12	2.562	1.162	.123	0.003
PT9484-MPG	1	.900	0.408	.016	**	BF9813	12	1.325	0.601	.069	0.002	BF9904	12	1.079	0.489	.086	0.002
PT9486-MPG	1	1.000	0.454	.043	0.001	PF9814	12	1.117	0.507	.106	0.003	BF9905	12	0.246	0.112	.029	0.001
PT9487-MPG	1	4.250	1.928	.285	0.008	BF9815	12	1.492	0.677	.072	0.002	BF9906	12	0.125	0.057	.014	**
PT9488-MPG	1	4.300	1.950	.291	0.008	BF9816	12	1.921	0.871	.080	0.002	PF9907	12	0.121	0.055	.013	**
PT9489-MPG	1	2.850	1.293	.141	0.004	BF9817	12	3.021	1.370	.135	0.004	PF9908 KIT	1	1.900	0.862	.191	0.005
PT9490-MPG	1	1.050	0.476	.041	0.001	BF9818	12	2.841	1.289	.160	0.005	BF9910	12	1.042	0.473	.040	0.001
PT9491-MPG	1	1.050	0.476	.040	0.001	BF9820	12	1.704	0.773	.063	0.002	PF9911	12	0.079	0.036	.007	**
PT9492-MPG	1	2.600	1.179	.074	0.002	BF9821	12	0.996	0.452	.047	0.001	BF9912-O	12	1.550	0.703	.061	0.002
PT9493-MPG	1	.550	0.249	.023	0.001	BF9822-D	12	0.604	0.274	.064	0.002	BF9913	12	0.750	0.340	.079	0.002
PT9494-MPG	1	1.900	0.862	.109	0.003	PF9823	12	0.321	0.146	.035	0.001	PF9914 KIT	6	1.292	0.586	.183	0.005
PT9495-MPG	1	2.700	1.225	.104	0.003	PF9825	12	2.00	0.091	.036	0.001	BF9915	12	0.592	0.269	.035	0.001
PT9496-MPG	1	3.900	1.769	.268	0.008	PF9826	12	1.238	0.562	.108	0.003	BF9916	12	0.196	0.089	.017	**
PT9497-MPG	1	4.050	1.837	.268	0.008	BF9827-D	12	0.692	0.314	.064	0.002	BF9917	12	2.950	1.338	.130	0.004
PT9498-MPG	1	2.000	0.907	.092	0.003	BF9828-D	12	0.596	0.270	.051	0.001	BF9918 KIT	6	2.075	0.941	.156	0.004
PT9499-MPG	1	1.050	0.476	.082	0.002	PF9829 KIT	1	1.500	0.680	.403	0.011	PF9919	12	0.600	0.272	.061	0.002
PT9500-MPG	1	6.900	3.130	.421	0.012	BF9830-D	12	0.463	0.210	.053	0.001	BF9920	6	3.567	1.618	.173	0.005
PT9501-MPG	1	2.050	0.930	.128	0.004	BF9831	12	1.521	0.690	.081	0.002	BF9921-O	12	2.267	1.028	.180	0.005
PT9502-MPG	1	1.100	0.499	.057	0.002	BF9833-D	12	0.588	0.267	.051	0.001	BF9922-O	12	1.204	0.546	.059	0.002
PT9503-MPG	1	1.250	0.567	.086	0.002	BF9834	12	1.625	0.737	.083	0.002	BF9923-O	12	1.313	0.596	.066	0.002
PT9505-MPG	1	1.400	0.635	.088	0.002	BF9835-D	12	0.600	0.272	.051	0.001	PF9924 KIT	6	2.350	1.066	.226	0.006
PT9507	1	2.200	0.998	.241	0.007	BF9836-D	12	0.521	0.236	.051	0.001	BF9925-O	12	1.650	0.748	.108	0.003
PT9508	1	.700	0.318	.030	0.001	BF9837-D	12	0.780	0.354	.058	0.002	BF9927	12	1.833	0.831	.077	0.002
PT9509	1	2.350	1.066	.218	0.006	BF9839-D	12	0.667	0.303	.063	0.002	PF9928	12	1.080	0.490	.124	0.004
PT9510	1	.250	0.113	.016	**	BF9841	12	0.867	0.393	.035	0.001	PF9929	12	1.033	0.469	.107	0.003
PT9511	1	1.500	0.680	.110	0.003	BF9842	12	0.750	0.340	.041	0.001	PA10000	6	0.700	0.318	.147	0.004
PT9513	1	1.650	0.748	.172	0.005	BF9844	12	2.550	1.157	.115	0.003	PA10001	6	1.358	0.616	.211	0.006
PT9514	1	1.800	0.363	.042	0.001	BF9846	12	0.763	0.346	.062	0.002	PA10002	6	0.400	0.181	.062	0.002
PT9515	1	3.250	1.474	.281	0.008	BF9847-D	12	0.621	0.282	.051	0.001	PA10003	6	0.808	0.367	.194	0.005
PT9516	1	.400	0.181	.025	0.001	BF9848	12	0.483	0.219	.060	0.002	PA10004	6	0.916	0.415	.129	0.004
PT9517	1	2.150	0.975	.203	0.006	BF9850	12	1.663	0.754	.073	0.002	RS10005	1	0.900	0.408	.151	0.004
PT9518-MPG	1	5.100	2.313	.431	0.012	BF9851	12	0.675	0.306	.078	0.002	PA10006	6	1.033	0.469	.147	0.004
PT9519-MPG	1	1.900	0.862	.105	0.003	BF9852	12	1.546	0.701	.085	0.002	PA10007	6	0.716	0.325	.211	0.006
PT9520-MPG	1	5.300	2.404	.642	0.018	BF9857	12	0.363	0.165	.063	0.002	PA10008	6	0.825	0.374	.104	0.003
PT9522-MPG	1	1.000	0.454	.053	0.001	BF9858 KIT	1	2.550	1.157	.188	0.005	PA10009	1	0.300	0.136	.063	0.002
PT9523-MPG	1	3.250	1.474	.238	0.007	BF9860	6	5.142	2.332	.172	0.005	PA10010	6	0.767	0.348	.136	0.004
PT9524-MPG	1	14.950	6.781	1.550	0.044	PF9861	12	0.379	0.172	.047	0.001	PA10011	6	0.500	0.227	.196	0.006
PT9525-MPG	1	2.300	1.043	.118	0.003	PF9862	12	0.183	0.083	.018	0.001	PA10012	6	1.550	0.703	.370	0.010
PT9526-MPG	1	1.300	0.590	.083	0.002	BF9863	12	1.179	0.081	.019	0.001	PA10014	6	0.450	0.204	.091	0.003
PT9528	1	5.500	2.495	.601	0.017	BF9864	6	3.208	1.455	.171	0.005	PA10015	6	1.091	0.495	.154	0.004
PT9529	1	3.000	1.361	.137	0.004	PF9865	12	0.442	0.200	.056	0.002	PA10016	6	0.200	0.091	.042	0.001
PT9530	1	1.750	0.794	.232	0.007	BF9866-O	12	2.460	1.116	.130	0.004	PA10017	6	0.458	0.208	.103	0.003
PT9532	6	2.892	1.312	.151	0.004	BF9867-O	12	2.317	1.051	.127	0.004	PA10018	6	0.900	0.408	.103	0.003
BT9533	1	3.650	1.656	.165	0.005	PF9868	12	0.729	0.331	.086	0.002	PA10020	1	0.700	0.318	.309	0.009
PT9535-MPG	1	.950	0.431	.058	0.002	BF9869	12	2.213	1.004	.100	0.003	RS10021	1	1.650	0.748	.358	0.010
PT9536-MPG	1	.750	0.340	.105	0.003	PF9870	12	0.650	0.295	.087	0.002	PA10022	6	1.666	0.756	.218	0.006
PT9537-MPG	12	.225	0.102	.020	0.001	BF9871-O	12	1.846	0.837	.107	0.003	PA10023	6	1.150	0.522	.179	0.005
BT9553	12	1.360	0.617	.050	0.001	PF9872	12	0.554	0.251	.056	0.002	PA10024	6	1.375	0.624	.255	0.007
PT9554-MPG	1	4.350	1.973	.328	0.009	PF9873	12	0.050	0.023	.005	**	PA10025	6	0.808	0.367	.117	0.003
PT9555	12	1.300	0.590	.134	0.004	BF9874-DM	12	0.613	0.278	.052	0.001	PA10026	6	1.083	0.491	.133	0.004
PT9556-MPG	1	5.750	2.608	.452	0.013	BF9875-DM	12	0.650	0.295	.053	0.001	PA1002					

BALDWIN WEIGHTS AND VOLUMES

BALDWIN NUMBER	CASE QTY.	WEIGHT (ea.) lbs.	WEIGHT (ea.) kgs.	Volume (ea.) ft ³	Volume (ea.) m ³	BALDWIN NUMBER	CASE QTY.	WEIGHT (ea.) lbs.	WEIGHT (ea.) kgs.	Volume (ea.) ft ³	Volume (ea.) m ³	BALDWIN NUMBER	CASE QTY.	WEIGHT (ea.) lbs.	WEIGHT (ea.) kgs.	Volume (ea.) ft ³	Volume (ea.) m ³
PA10033	6	1.625	0.737	410	0.012	PA10124	1	1.600	0.726	504	0.014	PA10201	6	.758	0.344	208	0.006
PA10034	1	.350	0.159	.096	0.003	PA10125	1	1.150	0.522	343	0.010	PA10202	6	.558	0.253	.117	0.003
RS10035	1	2.000	0.907	415	0.012	PA10126	1	.850	0.386	.198	0.006	PA10203 KIT	6	.730	0.331	.169	0.005
PA10036	6	1.267	0.575	.165	0.005	SA10127	12	.125	0.057	.036	0.001	PA10204 KIT	6	.558	0.253	.154	0.004
PA10037	6	.833	0.378	.160	0.005	PA10128	6	.375	0.170	.075	0.002	PA10205 KIT	1	2.800	1.270	.416	0.012
PA10038	1	.692	0.314	.098	0.003	PA10129	6	.375	0.170	.076	0.002	PA10206 KIT	6	.500	0.227	.134	0.004
PA10039	6	.742	0.337	.110	0.003	PA10130	6	.758	0.344	.104	0.003	PA10207	6	1.140	0.517	.300	0.008
PA10040	6	.725	0.329	.101	0.003	PA10131	6	.300	0.136	.062	0.002	PA10208 KIT	6	1.208	0.548	.218	0.006
PA10041	6	.625	0.284	.303	0.009	PA10132	6	.525	0.238	.080	0.002	PA10209 KIT	6	.425	0.193	.090	0.003
PA10042	6	.450	0.204	.090	0.003	PA10133	6	.200	0.091	.160	0.005	PA10210 KIT	6	.742	0.337	.133	0.004
PA10043	6	.408	0.185	.079	0.002	PA10134	6	.650	0.295	.103	0.003	PA10211 KIT	6	.425	0.193	.066	0.002
PA10044	6	1.208	0.548	.117	0.003	PA10135	6	.517	0.235	.092	0.003	PA10212 KIT	6	.967	0.439	.210	0.006
PA10045	6	1.642	0.745	.255	0.007	PA10136	6	.470	0.213	.155	0.004	PA10213	6	.625	0.284	.152	0.004
PA10046	6	1.050	0.476	.206	0.006	PA10137	6	.450	0.204	.167	0.005	PA10214	6	.667	0.303	.218	0.006
PA10047	6	1.058	0.480	.145	0.004	PA10138	6	.808	0.367	.127	0.004	PA10215 KIT	6	.600	0.272	.160	0.005
PA10057	6	.800	0.363	.122	0.003	PA10139	6	.458	0.208	.090	0.003	PA10216 KIT	6	.550	0.249	.106	0.003
PA10058	6	.883	0.401	.135	0.004	PA10140	6	.900	0.408	.137	0.004	PA10217	6	.125	0.057	.021	0.001
PA10059	6	.758	0.344	.113	0.003	PA10141	6	.508	0.230	.156	0.004	PA10218	6	.583	0.264	.125	0.004
PA10060	6	1.050	0.476	.210	0.006	PA10142	6	.600	0.272	.168	0.005	PA10219	6	.743	0.337	.129	0.004
PA10061	1	2.350	1.066	.776	0.022	PA10143	6	1.017	0.461	.201	0.006	PA10220	6	.700	0.318	.100	0.003
PA10062	6	.975	0.442	.296	0.008	PA10144	6	.417	0.189	.138	0.004	PA10221	6	1.108	0.503	.163	0.005
PA10063	6	1.058	0.480	.192	0.005	PA10145 KIT	6	.383	0.174	.166	0.005	PA10222	6	1.108	0.503	.168	0.005
PA10064	6	.841	0.381	.149	0.004	PA10146	6	.350	0.159	.063	0.002	PA10223	6	1.258	0.571	.131	0.004
PA10066	6	.283	0.128	.064	0.002	PA10147	6	.317	0.144	.061	0.002	PA10224	6	.975	0.442	.168	0.005
PA10067	6	.583	0.264	.089	0.003	PA10148	6	.592	0.269	.166	0.005	PA10225	1	1.600	0.726	.355	0.010
PA10068	1	1.900	0.862	.507	0.014	PA10149	6	.425	0.193	.163	0.005	PA10226	1	1.100	0.499	.200	0.006
PA10069	6	1.091	0.495	.130	0.004	PA10150	6	.275	0.125	.058	0.002	PA10227	6	.667	0.303	.134	0.004
PA10070	6	.717	0.325	.102	0.003	PA10152 KIT	6	1.283	0.582	.209	0.006	PA10228	6	1.170	0.531	.150	0.004
PA10071	6	.792	0.359	.097	0.003	PA10153	6	.608	0.276	.116	0.003	PA10229	6	1.208	0.548	.177	0.005
PA10072	6	1.267	0.575	.204	0.006	PA10154	6	.380	0.172	.059	0.002	PA10230	6	1.083	0.491	.146	0.004
PA10073	6	.883	0.401	.110	0.003	PA10155	6	.383	0.174	.151	0.004	PA10231	6	.820	0.372	.140	0.004
PA10075	6	1.025	0.465	.290	0.008	PA10156	6	.742	0.337	.101	0.003	PA10232	6	1.342	0.609	.207	0.006
PA10076	6	1.200	0.544	.291	0.008	PA10157	6	.292	0.132	.064	0.002	PA10233	6	.883	0.401	.210	0.006
PA10077	6	1.258	0.571	.233	0.007	PA10158	6	.958	0.435	.182	0.005	PA10234	6	1.225	0.556	.218	0.006
PA10078	6	.925	0.420	.162	0.005	PA10159	6	.300	0.136	.131	0.004	PA10235	6	1.125	0.510	.135	0.004
PA10081	6	.366	0.166	.078	0.002	PA10160	6	.433	0.196	.092	0.003	PA10236	6	1.158	0.525	.170	0.005
PA10082	6	.308	0.140	.056	0.002	PA10161	6	.590	0.268	.140	0.004	PA10237	6	1.158	0.525	.176	0.005
PA10083	6	.633	0.287	.098	0.003	PA10162	6	1.075	0.488	.101	0.003	PA10238	6	1.042	0.473	.162	0.005
PA10084	6	.950	0.431	.129	0.004	PA10163	6	.467	0.212	.056	0.002	PA10239	6	1.010	0.458	.133	0.004
PA10085	6	.366	0.166	.095	0.003	PA10164	6	.533	0.242	.217	0.006	PA10240	6	1.158	0.525	.170	0.005
PA10086	6	.866	0.393	.107	0.003	PA10165	6	.400	0.181	.061	0.002	PA10241	6	1.333	0.605	.222	0.006
PA10087	6	1.083	0.491	.163	0.005	PA10166	6	.550	0.249	.160	0.005	PA10242	6	1.467	0.665	.187	0.005
PA10088	6	.817	0.371	.136	0.004	PA10167	6	.358	0.162	.097	0.003	PA10243	1	1.650	0.748	.463	0.013
PA10089	6	1.150	0.522	.213	0.006	PA10168	1	.750	0.340	.445	0.013	PA10244	6	1.392	0.631	.192	0.005
PA10090	6	.916	0.415	.127	0.004	PA10169	6	.967	0.439	.141	0.004	PA10245	6	1.175	0.533	.212	0.006
PA10091	6	.758	0.344	.127	0.004	PA10170 KIT	6	1.092	0.495	.158	0.004	PA10246	1	3.250	1.474	.558	0.016
PA10093	6	1.216	0.552	.257	0.007	PA10171	6	.350	0.159	.152	0.004	PA10247	6	.734	0.333	.124	0.004
PA10094	6	1.342	0.609	.252	0.007	PA10172	6	.710	0.322	.170	0.005	PA10248	6	.808	0.367	.140	0.004
PA10095	6	1.725	0.782	.266	0.008	PA10173	6	.458	0.208	.121	0.003	PA10249	6	1.225	0.556	.177	0.005
PA10096	6	1.291	0.586	.228	0.006	PA10174	6	.591	0.268	.251	0.007	PA10250	6	1.317	0.597	.168	0.005
PA10097	6	.541	0.245	.096	0.003	PA10175 KIT	6	1.600	0.726	.297	0.008	PA10251	6	.842	0.382	.116	0.003
PA10098	6	.958	0.435	.183	0.005	PA10176	6	.325	0.147	.134	0.004	PA10253	6	1.058	0.480	.131	0.004
PA10099	6	.741	0.336	.123	0.003	PA10177	6	.567	0.257	.134	0.004	PA10254	6	1.075	0.488	.208	0.006
SA10100	12	.195	0.088	.066	0.002	PA10178	6	1.092	0.495	.119	0.003	PA10255	6	1.242	0.563	.173	0.005
PA10101	6	1.050	0.476	.170	0.005	PA10179	6	.533	0.242	.154	0.004	PA10256	6	.692	0.314	.099	0.003
PA10102	6	1.150	0.522	.200	0.006	PA10180 KIT	6	1.590	0.721	.181	0.005	PA10257	1	1.580	0.717	.592	0.017
PA10103	6	.617	0.280	.189	0.005	PA10181	6	.392	0.178	.089	0.003	PA10258	6	.950	0.431	.121	0.003
PA10104	6	.358	0.162	.081	0.002	PA10182	6	.400	0.181	.065	0.002	PA10259	6	.908	0.412	.107	0.003
PA10106	6	1.125	0.510	.277	0.008	PA10183	6	.520	0.236	.170	0.005	PA10260	6	1.000	0.454	.135	0.004
PA10108	6	.350	0.159	.107	0.003	PA10184	1	.550	0.249	.083	0.002	PA10261	6	.317	0.144	.046	0.001
PA10109	1	1.100	0.499	.414	0.012	PA10185	6	.433	0.196	.134	0.004	PA10262	1	1.640	0.744	.756	0.021
PA10110	1	.900	0.408	.289	0.008	PA10186 KIT	6	.570	0.259	.214	0.006	PA10263	6	.925	0.420	.127	0.004
PA10111	1	1.350	0.612	.381	0.011	PA10188	6	1.000	0.454	.140	0.004	PA10264	6	1.317	0.597	.153	0.004
PA10112	1	2.300	1.043	.783	0.022	PA10189	6	1.025	0.465	.218	0.006	PA10265	6	1.217	0.552	.166	0.005
PA10113	6	1.083	0.491	.266	0.008	PA10190	6	.433	0.196	.052	0.001	PA10266	6	.650	0.295	.098	0.003
PA10114	6	1.375	0.624	.372	0.011	PA10191 KIT	6	.467	0.212	.075	0.002	PA10267	6	1.030	0.467	.163	0.005
PA10115	1	.950	0.431	.236	0.007	PA10192	1	1.050	0.476	.353	0.010	PA10268	6	.858	0.389	.103	0.003
PA10116	1	1.950	0.885	.684	0.019	PA10193 KIT	6	.775	0.352	.104	0.003	PA10269	6	.708	0.321	.156	0.004
PA10117	1	.800	0.363	.151	0.004	PA10194	6	.442	0.200	.087	0.002	PA10270	6	.883	0.401	.154	0.004
PA10118	1	1.700	0.771	.560	0.016	PA10195 KIT	6	.575	0.261	.093	0.003	PA10271	6	1.067	0.484	.168	0.005
PA10119	1	.750	0.340	.212	0.006	PA10196 KIT	6	.775	0.352	.220	0.006	PA10272	6	.725	0.329	.128	0.004
PA10120	1	1.850	0.839	.646	0.018	PA10197	6	1.192	0.541	.302	0.009	PA10273	6	1.			

BALDWIN WEIGHTS AND VOLUMES

BALDWIN NUMBER	CASE QTY.	WEIGHT (ea.)		Volume (ea.)		BALDWIN NUMBER	CASE QTY.	WEIGHT (ea.)		Volume (ea.)		BALDWIN NUMBER	CASE QTY.	WEIGHT (ea.)		Volume (ea.)	
		lbs.	kgs.	ft ³	m ³			lbs.	kgs.	ft ³	m ³			lbs.	kgs.	ft ³	m ³
PA10277	.6	.942	.427	.199	.006	PA10353	.6	.391	.177	.079	.002	18011	.6	.775	.352	.143	.004
PA10278	.6	1.020	.463	.235	.007	PA10354	.6	2.250	1.021	.550	.016	18012	.6	.433	.196	.056	.002
PA10279	.6	1.425	.646	.218	.006	PA10355	.6	1.867	.847	.526	.015	18013	.6	.775	.352	.100	.003
PA10280	.6	1.092	.495	.207	.006	PA10356	.6	1.484	.673	.386	.011	18022	.6	1.250	.567	.146	.004
PA10281	.6	.900	.408	.173	.005	PA10357	.6	1.209	.548	.238	.007	18024	.6	1.000	.454	.145	.004
PA10282	.6	.617	.280	.080	.002	PA10358	.6	1.267	.575	.160	.005	18025	.6	1.017	.461	.142	.004
PA10283	.6	1.350	.612	.216	.006	SA10359	12	.117	.053	.020	.001	18027	.6	1.108	.503	.292	.008
PA10284	.6	1.133	.514	.174	.005	SA10360	12	.133	.060	.038	.001	18029	.6	1.042	.473	.147	.004
PA10285	.6	1.017	.461	.178	.005	SA10361	12	.058	.026	.013	.001	18031	.6	.800	.363	.043	.001
PA10286	.6	.417	.189	.080	.002	PA10362	.6	.225	.102	.052	.001	18032	.6	.675	.306	.059	.002
PA10287	.1	1.450	.658	.796	.023	PA10363	.6	.383	.0174	.059	.002	18033	.6	1.010	.458	.144	.004
PA10288	.6	1.230	.558	.230	.007	PA10364	.6	.342	.155	.080	.002	18034	.6	.966	.438	.143	.004
PA10289	.6	.390	.177	.060	.002	PA10365 KIT	.6	.233	.106	.050	.001	18055	.6	.858	.389	.074	.002
PA10290	.1	1.090	.495	.208	.006	PA10367	.6	.333	.151	.073	.002	18056	.6	1.100	.499	.230	.007
PA10291	.6	1.002	.454	.151	.004	PA10368	.6	.750	.340	.142	.004	18057	.6	1.400	.635	.212	.006
PA10292	.6	1.417	.643	.214	.006	PA10369	.6	.767	.348	.109	.003	18104	.6	.633	.287	.059	.002
PA10293	.6	1.217	.552	.208	.006	PA10370 KIT	.6	.567	.257	.132	.004	18139	.6	1.308	.593	.139	.004
PA10294	.6	1.142	.518	.213	.006	PA10371	.1	.200	.091	.070	.002	18155	.6	1.150	.522	.229	.006
PA10295	.6	1.017	.461	.217	.006	PA10372	.6	.217	.098	.053	.001	18163	.6	.717	.325	.073	.002
PA10296	.6	.550	.249	.082	.002	PA10373	.6	.533	.242	.169	.005	18171	.6	.933	.423	.145	.004
PA10297	.6	.725	.329	.104	.003	PA10374	.1	1.350	.612	.226	.006	18198	.6	1.217	.552	.146	.004
PA10298	.6	.925	.420	.175	.005	PA10375	.6	.650	.295	.167	.005	18236	.6	1.330	.603	.137	.004
PA10299	.6	1.367	.620	.275	.008	PA10376	.6	.450	.204	.104	.003	18245	.6	1.016	.461	.146	.004
PA10300	.6	1.000	.454	.175	.005	PA10378	.6	.700	.318	.149	.004	18264	.6	1.425	.646	.295	.008
PA10301	.6	.970	.440	.188	.005	PA10379	.6	1.258	.571	.129	.004	18265	.6	1.450	.658	.290	.008
PA10302	.6	1.392	.631	.216	.006	PA10380	.6	.683	.310	.113	.003	18267	.6	.742	.337	.143	.004
PA10303	.6	1.250	.567	.229	.006	PA10381	.6	1.170	.531	.209	.006	18268	.6	.742	.337	.059	.002
PA10304	.6	1.058	.480	.218	.006	PA10382	.6	.750	.340	.085	.002	19739	.1	2.400	1.089	.194	.005
PA10305	.6	.908	.412	.133	.004	PA10383	.6	.700	.318	.130	.004	19828	.6	.525	.238	.074	.002
PA10306	.6	.825	.374	.160	.005	PA10384	.6	.850	.386	.181	.005	19992	.6	1.267	.575	.122	.003
PA10307	.6	.683	.310	.112	.003	PA10385	.6	.933	.423	.239	.007	19996	.6	1.700	.771	.289	.008
PA10308	.6	1.200	.544	.172	.005	PA10386	.6	.875	.397	.163	.005	19999	.6	1.620	.735	.292	.008
PA10309	.6	1.360	.617	.440	.012	PA10387	.6	1.308	.593	.256	.007	20000	.6	1.750	.794	.287	.008
PA10310	.6	1.267	.575	.211	.006	PA10388	.6	.667	.303	.128	.004	20002	.6	1.267	.575	.303	.009
PA10311	.6	1.167	.529	.205	.006	PA10389	.6	.617	.280	.095	.003	20003	.6	1.375	.624	.293	.008
PA10312	.6	1.417	.643	.252	.007	PA10390	.6	1.067	.484	.203	.006	20004	.6	1.342	.609	.293	.008
PA10313	.6	.660	.299	.110	.003	PA10391	.6	.700	.318	.131	.004	20005	.6	.942	.427	.289	.008
PA10314	.6	.900	.408	.145	.004	PA10392	.6	1.080	.490	.168	.005	20006	.6	1.350	.612	.298	.008
PA10315	.6	.975	.442	.133	.004	PA10393	.6	1.158	.525	.231	.007	20007	.6	1.283	.582	.292	.008
PA10316	.6	1.017	.461	.180	.005	PA10394	.6	.775	.352	.165	.005	20008	.6	.725	.329	.073	.002
PA10317	.6	1.367	.620	.280	.008	PA10395	.6	.600	.272	.091	.003	20010	.6	.692	.314	.059	.002
PA10318	.6	.492	.223	.137	.004	PA10396	.6	.316	.143	.105	.003	20011	.6	1.142	.518	.288	.008
PA10319	.6	.858	.389	.134	.004	PA10397	.6	.775	.352	.124	.004	20012	.6	1.042	.473	.142	.004
PA10320	.6	.816	.370	.155	.004	PA10398	.6	.842	.382	.162	.005	20013	.6	1.058	.480	.143	.004
PA10321	.6	.625	.284	.109	.003	PA10399	.6	.475	.215	.097	.003	20014	.6	1.333	.605	.197	.006
PA10323	.6	.675	.306	.124	.004	PA10400	.6	.300	.136	.150	.004	20015	.6	.942	.427	.100	.003
PA10324	.6	.867	.393	.144	.004	PA10401	.6	.416	.189	.065	.002	20016	.6	1.442	.654	.290	.008
PA10325	.6	.917	.416	.146	.004	PA10402	.6	.366	.166	.080	.002	20017	.6	1.433	.650	.292	.008
PA10326	.6	.817	.371	.152	.004	PA10403	.6	.533	.242	.088	.002	20018	.6	1.250	.567	.229	.006
PA10327	.6	1.233	.559	.223	.006	PA10404	.6	.917	.416	.125	.004	20019	.1	1.600	.726	.435	.012
PA10328	.6	.458	.208	.060	.002	PA10405	.1	1.400	.635	.348	.010	20020	.6	1.158	.525	.225	.006
PA10329	.6	.817	.371	.154	.004	PA10407	.6	.983	.446	.108	.003	20021	.6	1.667	.756	.291	.008
PA10330	.6	.908	.412	.125	.004	PA10409	.6	.833	.378	.135	.004	20022	.1	1.050	.476	.433	.012
PA10331	.6	.892	.405	.174	.005	PA10411	.6	.308	.140	.067	.002	20023	.6	1.342	.609	.147	.004
PA10332	.6	.992	.450	.167	.005	PA10412	.6	.475	.215	.056	.002	20024	.1	.850	.386	.225	.006
PA10333	.6	.708	.321	.104	.003	PA10414	.6	TBD	TBD	TBD	TBD	20025	.6	1.000	.454	.275	.008
PA10334	.6	.733	.332	.103	.003	CV15000	.4	1.637	.743	.240	.007	20026	.6	.642	.291	.101	.003
PA10335	.6	1.683	.763	.252	.007	CV15001	12	.338	.153	.033	.001	20027	.6	.858	.389	.143	.004
PA10336	.1	.800	.363	.211	.006	CV15002	.1	.700	.318	.075	.002	20028	.6	1.966	.892	.232	.007
PA10337	.6	.933	.423	.138	.004	CV15003	12	.496	.225	.106	.003	20029	.6	1.808	.820	.348	.010
PA10338	.1	1.450	.658	.413	.012	CV15004	.1	1.050	.476	.173	.005	20030	.6	1.816	.824	.339	.010
PA10339	.1	1.250	.567	.408	.012	CV15005	.6	1.033	.469	.211	.006	20031	12	.533	.242	.048	.001
PA10340	.6	1.475	.669	.256	.007	CV15006	.1	.800	.363	.086	.002	20033	.1	.950	.431	.399	.011
PA10341	.6	.808	.367	.113	.003	CV15007	.6	1.158	.525	.215	.006	20035	.6	.925	.420	.101	.003
PA10342	.6	.558	.253	.141	.004	CV15008	.6	.966	.438	.211	.006	20037	.6	.467	.212	.059	.002
PA10343	.6	.800	.363	.132	.004	CV15010	.6	2.350	1.066	.262	.007	20041	.6	.933	.423	.142	.004
PA10344	.6	1.175	.533	.192	.005	CV15011	.6	.241	.109	.027	.001	20042	.6	.692	.314	.074	.002
PA10345	.6	1.258	.571	.217	.006	BA16000	.1	4.700	2.132	.234	.007	20043	.6	.808	.367	.072	.002
PA10346	.6	1.300	.590	.215	.006	PE17000	12	.279	.127	.037	.001	20044	.6	1.750	.794	.284	.008
RS10347	.1	.950	.431	.192	.005	PE17001	12	.225	.102	.020	.001	20045	.6	.900	.408	.075	.002
RS10348	.1	.600	.272	.127	.004	18002	.6	1.025	.465	.151	.004	20046	.6	1.000	.454	.220	.006
RS10349	.1	1.350	.612	.309	.009	18004	.6	.833	.378	.096	.003	20048	.6	.817	.371	.101	.003
RS10350	.1	2.400	1.089	.444	.013	18007	.6	1.030	.467	.225	.006	20050	.6	1.042	.473	.069	.002
RS10351	.1	1.000	.454	.288	.008	18009	.6	.700	.318	.135	.004	20051	.6	.758	.344	.071	.002
PA10352	.6	1.142	.518	.230	.007	18010	.6	1.375	.624	.293	.008	20052	.6	1.650	.748	.373	.011

++ Measurement is less than 0.001.

TBD To be Determined.

* Sold in Full Cases Only.



WARNING: These products can expose you to chemicals, including Diisononyl Phthalate, Carbon black extracts, Nickel, 1,3 Butadiene, Ethylene Oxide, Epichlorohydrin, which are known to the State of California to cause cancer, and Bisphenol-A, Ethylene Glycol, Ethylene Oxide, 1,3 Butadiene, Epichlorohydrin, which are known to the State of California to cause birth defects or other reproductive harm. For more information go to www.P65Warnings.ca.gov.

</

BALDWIN WEIGHTS AND VOLUMES

BALDWIN NUMBER	CASE QTY.	WEIGHT (ea.) lbs.	WEIGHT (ea.) kgs.	Volume (ea.) ft ³	Volume (ea.) m ³	BALDWIN NUMBER	CASE QTY.	WEIGHT (ea.) lbs.	WEIGHT (ea.) kgs.	Volume (ea.) ft ³	Volume (ea.) m ³	BALDWIN NUMBER	CASE QTY.	WEIGHT (ea.) lbs.	WEIGHT (ea.) kgs.	Volume (ea.) ft ³	Volume (ea.) m ³
20053	6	.458	.208	.058	.002	PT23061-MPG	1	1.750	.794	.086	.002	BT23140-MPG	1	2.750	1.247	.145	.004
20054	6	.730	.331	.070	.002	PT23062-MPG	1	8.800	3.992	.540	.015	PT23141	1	1.115	.506	.092	.003
20055	6	.775	.352	.056	.002	PT23063-MPG	1	1.800	.816	.141	.004	PT23142	1	.750	.340	.029	.001
20057	6	.642	.291	.058	.002	PT23064-MPG	1	.550	.249	.023	.001	PT23143	1	.350	.159	.022	.001
20058	6	1.242	.563	.228	.006	PT23065-MPG	1	15.500	7.031	.953	.027	PT23144	1	1.250	.567	.097	.003
20060	6	.383	.174	.058	.002	PT23066-MPG	1	.650	.295	.033	.001	PT23145	1	.050	.023	.005	.002
20061	6	.833	.378	.074	.002	PT23067-MPG	1	.700	.318	.033	.001	PT23146	1	1.100	.499	.082	.002
20062	6	1.008	.457	.224	.006	PT23068-MPG	1	2.650	1.202	.167	.005	PT23147	1	1.750	.794	.199	.006
20063	12	.241	.109	.051	.001	PT23069-MPG	1	.350	.159	.014	.002	PT23148	1	1.250	.567	.082	.002
20064	6	.875	.397	.103	.003	PT23070-MPG	1	3.350	1.520	.336	.010	PT23149	1	1.400	.635	.085	.002
20065	6	1.000	.454	.076	.002	PT23071-MPG	1	1.150	.522	.042	.001	PT23150	1	1.200	.544	.116	.003
20066	6	1.092	.495	.139	.004	PT23072-MPG	1	2.750	1.247	.157	.004	PT23151	1	3.150	1.429	.522	.015
20067	6	.583	.264	.072	.002	PT23073-MPG	1	.300	.136	.015	.002	PT23152	1	3.400	1.542	.378	.011
20068	6	.817	.371	.071	.002	PT23074-MPG	1	.650	.295	.016	.002	PT23154	1	1.600	.726	.157	.004
20069	6	1.300	.590	.224	.006	PT23075-MPG	1	1.350	.612	.038	.001	PT23155	1	2.500	1.134	.104	.003
20070	6	1.408	.639	.233	.007	PT23076-MPG	1	1.200	.544	.055	.002	PT23156	1	2.800	1.270	.241	.007
BW21000	12	1.504	.682	.064	.002	PT23077-MPG	1	.550	.249	.023	.001	PT23157	1	14.400	6.532	1.972	.056
PT23000	1	2.350	1.066	.247	.007	PT23078-MPG	1	.850	.386	.055	.002	PT23158	1	2.600	1.179	.301	.009
PT23001	1	2.550	1.157	.251	.007	PT23079-MPG	1	1.700	.771	.093	.003	PT23159	1	2.150	.975	.192	.005
PT23002	1	1.059	.480	.037	.001	PT23080-MPG	1	1.800	.816	.082	.002	PT23160	1	1.200	.544	.059	.002
PT23003	1	1.900	.862	.212	.006	PT23081-MPG	1	2.750	1.247	.137	.004	PT23161	1	1.550	.703	.085	.002
PT23004	1	2.600	1.179	.233	.007	PT23082-MPG	1	.450	.204	.032	.001	PT23162	1	.850	.386	.053	.001
PT23005	1	.650	.295	.054	.002	PT23083-MPG	1	.450	.204	.033	.001	PT23163	1	1.500	.680	.081	.002
PT23006	1	.500	.227	.031	.001	PT23084-MPG	1	.750	.340	.037	.001	PT23164	1	.300	.136	.015	.002
PT23007	1	.500	.227	.031	.001	PT23085-MPG	1	1.550	.703	.072	.002	PT23165	1	1.250	.567	.152	.004
PT23008	1	.550	.249	.039	.001	PT23086-MPG	1	.300	.136	.016	.002	PT23166	1	1.550	.703	.082	.002
PT23009	1	.750	.340	.053	.001	PT23087-MPG	1	.300	.136	.013	.002	PT23167	1	2.250	1.021	.237	.007
PT23010	1	2.050	.930	.124	.004	PT23088-MPG	1	.300	.136	.013	.002	PT23168	1	2.600	1.179	.104	.003
PT23011	1	2.600	1.179	.277	.008	PT23089-MPG	1	2.250	1.021	.121	.003	PT23169	1	2.200	.998	.188	.005
PT23012	1	1.250	.567	.098	.003	PT23090-MPG	1	.450	.204	.015	.002	PT23170	1	2.700	1.225	.241	.007
PT23013	1	1.550	.703	.114	.003	PT23091-MPG	1	.700	.318	.033	.001	PT23172	1	.800	.363	.053	.001
PT23014	1	2.601	1.180	.099	.003	PT23092-MPG	1	.700	.318	.032	.001	PT23173	1	2.450	1.111	.241	.007
PT23015	1	.900	.408	.057	.002	PT23093-MPG	1	1.150	.522	.053	.001	PT23174	1	3.350	1.520	.245	.007
PT23016	1	.850	.386	.056	.002	PT23094-MPG	1	1.500	.680	.084	.002	PT23175	1	.550	.249	.032	.001
PT23017	1	.500	.227	.023	.001	PT23095-MPG	1	.550	.249	.024	.001	PT23176	1	.850	.386	.057	.002
PT23018	1	.300	.136	.017	.002	PT23096-MPG	1	.500	.227	.014	.002	PT23178	1	1.050	.476	.082	.002
PT23019	1	2.469	1.120	.222	.006	PT23097-MPG	1	.300	.136	.017	.002	PT23179	1	1.250	.567	.110	.003
PT23020	1	2.000	.907	.110	.003	PT23098-MPG	1	2.900	1.315	.302	.009	PT23180	1	2.400	1.089	.229	.006
PT23023	1	2.954	1.340	.146	.004	PT23100-MPG	1	.300	.136	.017	.002	PT23181	1	1.750	.794	.113	.003
PT23024	1	1.250	.567	.098	.003	PT23101-MPG	1	3.350	1.520	.231	.007	PT23182	1	1.800	.816	.110	.003
PT23025	1	1.455	.660	.060	.002	PT23102-MPG	1	.900	.408	.044	.001	PT23183	1	1.000	.454	.099	.003
PT23026	1	1.499	.680	.060	.002	PT23103-MPG	1	1.050	.476	.053	.001	PT23184	1	1.200	.544	.099	.003
PT23027	1	2.400	1.089	.158	.004	PT23104-MPG	1	15.350	6.963	.951	.027	PT23185	1	2.350	1.066	.214	.006
PT23028-MPG	1	1.720	.780	.038	.001	PT23105-MPG	1	.400	.181	.017	.002	PT23186	1	2.500	1.134	.247	.007
PT23029-MPG	1	1.455	.660	.060	.002	PT23106-MPG	1	3.900	1.769	.198	.006	PT23187	1	1.950	.885	.156	.004
PT23030-MPG	1	2.910	1.320	.146	.004	PT23107-MPG	1	.400	.181	.017	.002	PT23188	1	2.200	.998	.201	.006
PT23031-MPG	1	.250	.113	.014	.001	PT23108-MPG	1	.750	.340	.037	.001	PT23189	1	.800	.363	.084	.002
PT23032-MPG	1	.300	.136	.014	.001	PT23109-MPG	1	.750	.340	.037	.001	PT23190	1	.850	.386	.025	.001
PT23033-MPG	1	4.250	1.928	.232	.007	PT23110-MPG	1	1.150	.522	.044	.001	PT23193-MPG	1	.350	.159	.013	.002
PT23034-MPG	1	1.750	.794	.081	.002	PT23111-MPG	1	1.700	.771	.072	.002	PT23195-MPG	1	.550	.249	.032	.001
PT23035-MPG	1	.850	.386	.053	.001	PT23112-MPG	1	1.700	.771	.072	.002	PT23196-MPG	1	.800	.363	.043	.001
PT23036-MPG	1	.350	.159	.014	.001	PT23113-MPG	1	2.650	1.202	.164	.005	PT23197-MPG	1	1.150	.522	.056	.002
PT23037-MPG	1	.353	.160	.010	.001	PT23114-MPG	1	2.600	1.179	.189	.005	PT23198-MPG	1	.700	.318	.053	.001
PT23038-MPG	1	.550	.249	.021	.001	PT23115-MPG	1	.600	.272	.043	.001	PT23200-MPG	1	.950	.431	.050	.001
PT23039-MPG	1	.550	.249	.022	.001	PT23116-MPG	1	6.350	2.880	.413	.012	PT23201-MPG	1	1.050	.476	.057	.002
PT23040-MPG	1	1.300	.590	.058	.002	PT23117-MPG	1	.850	.386	.053	.001	PT23202-MPG	1	.350	.159	.024	.001
PT23041-MPG	1	1.650	.748	.115	.003	PT23118-MPG	1	1.700	.771	.072	.002	PT23203-MPG	1	.700	.318	.029	.001
PT23042-MPG	1	1.400	.635	.104	.003	PT23119-MPG	1	3.350	1.520	.206	.006	PT23204-MPG	1	1.300	.590	.058	.002
PT23043-MPG	1	.750	.340	.021	.001	PT23120-MPG	1	4.750	2.155	.310	.009	PT23205-MPG	1	.450	.204	.016	.002
PT23044-MPG	1	1.300	.590	.096	.003	PT23122	12	.846	.384	.101	.003	PT23206-MPG	1	.800	.363	.024	.001
PT23045-MPG	1	1.700	.771	.078	.002	PT23123	12	.650	.295	.069	.002	PT23207-MPG	1	.850	.386	.024	.001
PT23046-MPG	1	1.650	.748	.070	.002	PT23124	12	1.310	.594	.109	.003	PT23209-MPG	1	1.800	.816	.110	.003
PT23047-MPG	1	.600	.272	.034	.001	PT23125-MPG	12	3.270	1.483	.100	.003	PT23211-MPG	1	4.200	1.905	.279	.008
PT23048-MPG	1	2.900	1.315	.243	.007	PT23126-MPG	12	.775	.352	.031	.001	PT23212-MPG	1	.950	.431	.032	.001
PT23049-MPG	1	2.800	1.270	.105	.003	PT23127-MPG	12	.816	.370	.040	.001	PT23213-MPG	1	1.750	.794	.113	.003
PT23051-MPG	1	15.100	6.849	1.423	.040	PT23128-MPG	12	.617	.280	.030	.001	PT23214-MPG	1	2.050	.930	.157	.004
PT23052-MPG	1	4.300	1.950	.151	.004	PT23129-MPG	12	1.150	.522	.062	.002	PT23215-MPG	1	1.700	.771	.131	.004
PT23053-MPG	1	3.950	1.792	.111	.003	PT23131-MPG	1	3.071	1.393	.083	.002	PT23216-MPG	1	1.750	.794	.082	.002
PT23054-MPG	1	2.350	1.066	.105	.003	PT23132-MPG	12	.875	.397	.032	.001	PT23217-MPG	1	.500	.227	.055	.002
PT23055-MPG	1	.300	.136	.014	.001	PT23133-MPG	1	6.250	2.835	.496	.014	PT23218-MPG	1	.650	.295	.017	.002
PT23056-MPG	1	2.750	1.247	.072	.002	PT23135-MPG	1	1.800	.816	.074	.002	PT23219-MPG	1	.900	.408	.029	.001
PT23057-MPG	1	2.300	1.043	.119	.003	PT23136	12	.700	.318	.070	.002	PT23220-MPG	1	2.050	.930	.102	.003
PT23058-MPG	1	.300	.136	.017	.001	PT23137	6	2.630	1.193	.275	.008	PT23221-MPG	1	2.700	1.225	.143	.004
PT23059-MPG	1	1.000	.454	.053	.001	PT23138	1	1.100	.499	.097	.003	PT23223-MPG	1	2.800	1.270	.143	.004
PT23060-MPG	1	1.150	.522	.058	.002	PT23139-MPG	1	5.35									

BALDWIN WEIGHTS AND VOLUMES

BALDWIN NUMBER	CASE QTY.	WEIGHT (ea.) lbs.	WEIGHT (ea.) kgs.	Volume (ea.) ft ³	Volume (ea.) m ³	BALDWIN NUMBER	CASE QTY.	WEIGHT (ea.) lbs.	WEIGHT (ea.) kgs.	Volume (ea.) ft ³	Volume (ea.) m ³	BALDWIN NUMBER	CASE QTY.	WEIGHT (ea.) lbs.	WEIGHT (ea.) kgs.	Volume (ea.) ft ³	Volume (ea.) m ³
PT23226-MPG	1	1.150	0.522	.347	0.010	PT23315	1	3.360	1.524	.243	0.007	PT23390-MPG	1	2.700	1.225	.243	0.007
PT23227-MPG	1	6.150	2.790	.384	0.011	PT23316	1	1.450	0.658	.074	0.002	PT23391-MPG	1	1.000	0.454	.056	0.002
PT23228-MPG	1	2.800	1.270	.153	0.004	PT23317	1	1.800	0.816	.091	0.003	PT23392-MPG	1	3.400	1.542	.283	0.008
PT23229-MPG	1	2.700	1.225	.247	0.007	PT23318	1	2.400	1.089	.330	0.009	PT23393-MPG	1	2.200	0.998	.140	0.004
PT23230-MPG	1	1.750	0.794	.085	0.002	PT23319	1	200	0.091	.017	**	PT23394-MPG	1	3.300	1.497	.292	0.008
PT23231-MPG	1	2.800	1.270	.139	0.004	PT23320	1	350	0.159	.023	0.001	PT23395-MPG	1	1.450	0.658	.055	0.002
PT23232-MPG	1	3.150	1.429	.276	0.008	PT23321	1	550	0.249	.043	0.001	PT23396-MPG	1	2.750	1.247	.056	0.002
PT23233-MPG	1	550	0.249	.034	0.001	PT23322	1	550	0.249	.016	**	PT23397-MPG	1	2.750	1.247	.055	0.002
PT23234-MPG	1	4.050	1.837	.380	0.011	PT23323	1	1.550	0.703	.159	0.004	PT23398-MPG	1	2.750	1.247	.060	0.002
PT23235-MPG	1	1.500	0.680	.279	0.008	PT23324	1	2.200	0.998	.282	0.008	PT23399-MPG	1	1.450	0.658	.294	0.008
PT23236-MPG	1	1.500	0.680	.283	0.008	PT23325	1	3.150	1.429	.084	0.002	PT23400-MPG	1	900	0.408	.016	**
PT23237-MPG	1	2.700	1.225	.166	0.005	PT23326	1	900	0.408	.042	0.001	PT23401-MPG	1	2.800	1.270	.143	0.004
PT23238-MPG	1	2.150	0.975	.143	0.004	PT23327	1	950	0.431	.055	0.002	PT23402-MPG	1	3.400	1.542	.165	0.005
PT23239-MPG	1	7.550	3.425	.519	0.015	PT23328	1	850	0.386	.057	0.002	PT23403-MPG	1	4.250	1.928	.212	0.006
PT23240-MPG	1	1.300	0.590	.030	0.001	PT23329	1	550	0.249	.029	0.001	PT23404-MPG	1	4.250	1.928	.210	0.006
PT23241-MPG	1	2.800	1.270	.137	0.004	PT23330	1	1.150	0.522	.100	0.003	PT23405-MPG	1	4.300	1.950	.212	0.006
PT23242-MPG	1	2.650	1.202	.175	0.005	PT23331	1	3.250	1.474	.251	0.007	PT23406-MPG	1	1.100	0.499	.204	0.006
PT23243-MPG	1	2.450	1.111	.110	0.003	PT23332	1	700	0.318	.033	0.001	PT23407-MPG	1	500	0.227	.055	0.002
PT23244-MPG	1	2.850	1.293	.137	0.004	PT23333	1	500	0.227	.024	0.001	PT23408-MPG	1	1.950	0.885	.029	0.001
PT23245-MPG	1	4.850	2.200	.312	0.009	PT23334	1	800	0.363	.059	0.002	PT23409-MPG	1	3.850	1.746	.299	0.008
PT23246-MPG	1	1.450	0.658	.057	0.002	PT23335	1	2.650	1.202	.284	0.008	PT23410-MPG	1	1.150	0.522	.058	0.002
PT23247-MPG	1	2.500	1.134	.137	0.004	PT23336	1	1.100	0.499	.075	0.002	PT23411-MPG	1	5.550	2.517	1.026	0.029
PT23248-MPG	1	16.250	7.371	1.039	0.029	PT23337	1	400	0.181	.024	0.001	PT23412-MPG	1	1.950	0.885	.091	0.003
PT23249-MPG	1	7.600	3.447	.517	0.015	PT23338-MPG	1	400	0.181	.016	**	PT23413-MPG	1	8.900	4.037	.266	0.008
PT23250-MPG	1	3.900	1.769	.280	0.008	PT23339-MPG	1	3.300	1.497	.070	0.002	PT23414-MPG	1	1.400	0.635	.059	0.002
PT23251-MPG	1	4.000	1.814	.253	0.007	PT23340-MPG	1	2.800	1.270	.114	0.003	PT23415-MPG	1	2.700	1.225	.174	0.005
PT23252-MPG	1	4.050	1.837	.271	0.008	PT23341-MPG	1	4.000	1.814	.104	0.003	PT23416-MPG	1	2.200	0.998	.141	0.004
PT23253-MPG	1	8.850	4.014	.522	0.015	PT23342-MPG	1	2.250	1.021	.123	0.003	PT23417-MPG	1	900	0.408	.170	0.005
PT23254-MPG	1	4.300	1.950	.104	0.003	PT23343-MPG	1	18.700	8.482	1.972	0.056	PT23418-MPG	1	900	0.408	.016	**
PT23255-MPG	1	15.800	7.167	1.026	0.029	PT23344-MPG	1	1.350	0.612	.085	0.002	PT23419-MPG	1	1.300	0.590	.058	0.002
PT23257-MPG	1	2.200	0.998	.115	0.003	PT23345-MPG	1	2.050	0.930	.165	0.005	PT23420-MPG	1	5.350	2.427	.268	0.008
PT23258-MPG	1	600	0.272	.017	**	PT23346-MPG	1	1.150	0.522	.058	0.002	PT23421-MPG	1	8.000	3.629	.376	0.011
PT23259-MPG	1	3.900	1.769	.190	0.005	PT23347-MPG	1	1.000	0.454	.052	0.001	PT23422-MPG	1	8.800	3.992	.266	0.008
PT23260-MPG	1	250	0.113	.017	**	PT23348-MPG	1	2.650	1.202	.140	0.004	PT23423-MPG	1	4.600	2.087	.161	0.005
PT23261-MPG	1	1.450	0.658	.072	0.002	PT23349-MPG	1	5.400	2.449	.396	0.011	PT23424-MPG	1	4.750	2.155	1.026	0.029
PT23263-MPG	1	900	0.408	.017	**	PT23350-MPG	1	700	0.318	.031	0.001	PT23425-MPG	1	4.700	2.132	1.003	0.028
PT23264-MPG	1	2.350	1.066	.136	0.004	PT23351-MPG	1	1.150	0.522	.059	0.002	PT23426-MPG	1	5.650	2.563	.996	0.028
PT23265-MPG	1	2.050	0.930	.099	0.003	PT23352-MPG	1	300	0.136	.014	**	PT23427-MPG	1	2.150	0.975	.449	0.013
PT23266-MPG	1	750	0.340	.025	0.001	PT23353-MPG	1	2.400	1.089	.098	0.003	PT23428-MPG	1	4.900	2.223	.996	0.028
PT23267-MPG	1	1.050	0.476	.053	0.001	PT23354-MPG	1	2.400	1.089	.104	0.003	PT23429-MPG	1	3.750	1.701	.101	0.003
PT23269-MPG	1	850	0.386	.030	0.001	PT23355-MPG	1	7.450	3.379	.511	0.014	PT23430-MPG	1	1.700	0.771	.040	0.001
PT23270-MPG	1	300	0.136	.016	**	PT23356-MPG	1	2.950	1.338	.102	0.003	PT23431-MPG	1	5.750	2.608	1.041	0.029
PT23271-MPG	1	2.700	1.225	.170	0.005	PT23357-MPG	1	850	0.386	.024	0.001	PT23432-MPG	1	1.800	0.816	.061	0.002
PT23272-MPG	1	2.050	0.930	.101	0.003	PT23358-MPG	1	550	0.249	.022	0.001	PT23433-MPG	1	1.950	0.885	.090	0.003
PT23273-MPG	1	2.650	1.202	.135	0.004	PT23359-MPG	1	2.400	1.089	.116	0.003	PT23434-MPG	1	7.750	3.515	.395	0.011
PT23274-MPG	1	2.650	1.202	.073	0.002	PT23360-MPG	1	8.550	3.878	.538	0.015	PT23435-MPG	1	4.400	1.996	.267	0.008
PT23275-MPG	1	3.100	1.406	.070	0.002	PT23361-MPG	1	1.150	0.522	.042	0.001	PT23436-MPG	1	2.050	0.930	.041	0.001
PT23276-MPG	1	4.250	1.928	.136	0.004	PT23362-MPG	1	4.800	2.177	.233	0.007	PT23437-MPG	1	1.250	0.567	.031	0.001
PT23277-MPG	1	2.850	1.293	.143	0.004	PT23363-MPG	1	1.650	0.748	.074	0.002	PT23438-MPG	1	2.200	0.998	.101	0.003
PT23278-MPG	1	1.950	0.885	.104	0.003	PT23364-MPG	1	3.950	1.792	.200	0.006	PT23439-MPG	1	5.800	2.631	1.040	0.029
PT23279-MPG	1	2.650	1.202	.170	0.005	PT23365-MPG	1	1.700	0.771	.040	0.001	PT23440-MPG	1	2.550	1.157	.141	0.004
PT23280-MPG	1	450	0.204	.017	**	PT23366-MPG	1	2.400	1.089	.111	0.003	PT23441-MPG	1	750	0.340	.104	0.003
PT23281-MPG	1	1.450	0.658	.072	0.002	PT23367-MPG	1	300	0.136	.016	**	PT23442-MPG	1	750	0.340	.025	0.001
PT23282-MPG	1	6.200	2.812	.403	0.011	PT23368-MPG	1	2.950	1.338	.140	0.004	PT23443-MPG	1	750	0.340	.031	0.001
PT23283-MPG	1	1.900	0.862	.094	0.003	PT23369-MPG	1	750	0.340	.020	0.001	PT23444-MPG	1	800	0.363	.054	0.002
PT23284-MPG	1	850	0.386	.053	0.001	PT23370-MPG	1	1.650	0.748	.074	0.002	PT23445-MPG	1	1.700	0.771	.079	0.002
PT23285-MPG	1	450	0.204	.032	0.001	PT23371-MPG	1	600	0.272	.022	0.001	PT23446-MPG	1	3.300	1.497	.287	0.008
PT23286-MPG	1	450	0.204	.017	**	PT23372-MPG	1	2.650	1.202	.072	0.002	PT23447-MPG	1	350	0.159	.017	**
PT23287-MPG	1	1.950	0.885	.101	0.003	PT23373-MPG	1	700	0.318	.030	0.001	PT23448-MPG	1	550	0.249	.030	0.001
PT23289-MPG	1	1.300	0.590	.058	0.002	PT23374-MPG	1	500	0.227	.014	**	PT23449-MPG	1	6.050	2.744	.390	0.011
PT23290-MPG	1	400	0.181	.016	**	PT23375-MPG	1	600	0.272	.022	0.001	PT23450-MPG	1	5.650	2.563	.280	0.008
PT23291-MPG	1	2.850	1.293	.137	0.004	PT23376-MPG	1	1.300	0.590	.024	0.001	PT23451	1	4.700	2.132	.519	0.015
PT23292-MPG	1	450	0.204	.024	0.001	PT23377-MPG	1	200	0.091	.016	**	PT23453	1	6.050	2.744	.598	0.017
PT23294-MPG	1	300	0.136	.017	**	PT23378-MPG	1	700	0.318	.030	0.001	PT23454	1	3.400	1.542	.426	0.012
PT23295-MPG	1	1.550	0.703	.055	0.002	PT23379-MPG	1	353	0.160	.010	**	PT23455	1	2.000	0.907	.218	0.006
PT23296-MPG	1	1.200	0.544	.057	0.002	PT23380-MPG	1	1.950	0.885	.093	0.003	PT23456	1	1.000	0.454	.092	0.003
PT23297	1	1.350	0.612	.114	0.003	PT23381-MPG	1	1.650	0.748	.086	0.002	PT23457	1	1.950	0.885	.192	0.005
PT23306	1	1.700	0.771	.221	0.006	PT23382-MPG	1	1.000	0.454	.035	0.001	PT23458	1	1.900	0.862	.196	0.006
PT23308	1	1.150	0.522	.041	0.001	PT23383-MPG	1	3.150	1.429	.115	0.003	PT23459	1	1.250	0.567	.079	0.002
PT23309	1	250	0.113	.017	**	PT23384-MPG											

BALDWIN WEIGHTS AND VOLUMES

BALDWIN NUMBER	CASE QTY.	WEIGHT (ea.) lbs.	WEIGHT (ea.) kgs.	Volume (ea.) ft ³	Volume (ea.) m ³	BALDWIN NUMBER	CASE QTY.	WEIGHT (ea.) lbs.	WEIGHT (ea.) kgs.	Volume (ea.) ft ³	Volume (ea.) m ³	BALDWIN NUMBER	CASE QTY.	WEIGHT (ea.) lbs.	WEIGHT (ea.) kgs.	Volume (ea.) ft ³	Volume (ea.) m ³
PT23467	1	4.150	1.882	.378	0.011	PT23546-MPG	1	5.600	2.540	.479	0.014	PA30024	12	.554	0.251	.056	0.002
PT23468	1	1.450	0.658	.089	0.003	BT23555-MPG	6	3.633	1.648	.204	0.006	PA30025	1	.850	0.386	.296	0.008
PT23469	1	2.100	0.953	.201	0.006	PT23556-MPG	1	1.050	0.476	.100	0.003	PA30026	1	2.650	1.202	.597	0.017
PT23470	1	.450	0.204	.032	0.001	PT23560	6	4.650	2.109	.065	0.002	PA30028	1	1.450	0.658	.208	0.006
PT23471	1	2.400	1.089	.201	0.006	PT23561-MPG	12	1.438	0.652	.118	0.003	PA30029	12	.308	0.140	.055	0.002
PT23472	1	1.050	0.476	.082	0.002	PT23565-MPG	1	2.350	1.066	.238	0.007	PA30030	6	.791	0.359	.125	0.004
PT23473	1	1.400	0.635	.165	0.005	PT23566-MPG	1	2.950	1.338	.286	0.008	PA30031	12	.437	0.198	.061	0.002
PT23474	1	.650	0.295	.034	0.001	PT23567-MPG	1	.400	0.181	.040	0.001	PA30032	1	2.400	1.089	.282	0.008
PT23475	1	1.450	0.658	.095	0.003	PT23568-MPG	1	.650	0.295	.021	0.001	PA30033	1	.500	0.227	.092	0.003
PT23476	1	1.000	0.454	.053	0.001	PT23569-MPG	1	1.000	0.454	.065	0.002	PA30034	12	.475	0.215	.040	0.001
PT23477	1	1.700	0.771	.115	0.003	PT23570-MPG	1	.550	0.249	.023	0.001	PA30035	12	.370	0.168	.043	0.001
PT23478	1	.450	0.204	.025	0.001	PT23571-MPG	1	.200	0.091	.013	0.001	PA30036	1	.800	0.363	.127	0.004
PT23479	1	1.700	0.771	.141	0.004	PT23572-MPG	1	.550	0.249	.030	0.001	PA30037	1	11.700	5.307	1.378	0.039
PT23480	1	1.450	0.658	.089	0.003	PT23573-MPG	1	.300	0.136	.016	0.001	PA30038	1	10.500	4.763	1.515	0.043
PT23481	1	1.250	0.567	.083	0.002	PT23574-MPG	1	.200	0.091	.024	0.001	PA30039	1	21.750	9.866	3.666	0.104
PT23482	1	1.200	0.544	.082	0.002	PT23575-MPG	1	.450	0.204	.016	0.001	PA30040	1	12.600	5.715	1.672	0.047
PT23483-MPG	1	8.250	3.742	.937	0.027	PT23576-MPG	1	.700	0.318	.030	0.001	PA30041	1	17.600	7.983	2.805	0.079
PT23484-MPG	1	2.000	0.907	.030	0.001	PT23577-MPG	1	1.650	0.748	.243	0.007	PA30042	1	3.350	1.520	.533	0.015
PT23485-MPG	1	8.000	3.629	.519	0.015	PT23578-MPG	1	1.300	0.590	.059	0.002	PA30043	1	19.100	8.664	2.824	0.080
PT23486-MPG	1	14.100	6.396	1.147	0.032	PT23579-MPG	1	2.450	1.111	.196	0.006	PA30044	6	.233	0.106	.064	0.002
PT23487-MPG	1	3.450	1.565	.282	0.008	PT23580-MPG	1	1.600	0.726	.069	0.002	PA30045	1	.900	0.408	.197	0.006
PT23488-MPG	1	2.200	0.998	.160	0.005	PT23581-MPG	1	5.000	2.268	.331	0.009	PA30048	1	4.200	1.905	.380	0.011
PT23489-MPG	1	.700	0.318	.030	0.001	PT23582-MPG	1	2.700	1.225	.194	0.005	PA30049	1	6.100	2.767	.376	0.011
PT23490-MPG	1	1.150	0.522	.057	0.002	PT23583-MPG	1	2.450	1.111	.244	0.007	PA30050	6	.408	0.185	.066	0.002
PT23491-MPG	1	.500	0.227	.030	0.001	PT23585	1	2.500	1.134	.137	0.004	PA30051	6	.283	0.128	.046	0.001
PT23492-MPG	1	.200	0.091	.017	0.001	PT23586	1	.800	0.363	.082	0.002	PA30052	6	.516	0.234	.085	0.002
PT23493-MPG	1	1.850	0.839	.083	0.002	PT23587	1	1.350	0.612	.121	0.003	PA30053	6	.183	0.083	.022	0.001
PT23494-MPG	1	.300	0.136	.014	0.001	PT23588	1	2.650	1.202	.333	0.009	PA30054	6	.375	0.170	.064	0.002
PT23495-MPG	1	.450	0.204	.031	0.001	PT23589	1	5.950	2.699	.516	0.015	PA30055	6	.283	0.128	.046	0.001
PT23496-MPG	1	2.850	1.293	.243	0.007	PT23590	1	3.200	1.452	.086	0.002	PA30056	6	.283	0.128	.040	0.001
PT23497-MPG	1	6.850	3.107	.408	0.012	PT23591-MPG	1	5.450	2.472	.417	0.012	RS30057	1	8.000	3.629	1.897	0.054
PT23498-MPG	1	.750	0.340	.031	0.001	PT23592	6	1.667	0.756	.148	0.004	RS30058	1	2.750	1.247	.690	0.020
PT23499-MPG	1	1.250	0.567	.039	0.001	PT23595-MPG	1	3.350	1.520	.265	0.007	RS30059-FN	1	4.250	1.928	.987	0.028
PT23500-MPG	1	.450	0.204	.023	0.001	PT23597-MPG	12	1.979	0.898	.098	0.003	RS30060-FN	1	2.150	0.975	.462	0.013
PT23501-MPG	1	.600	0.272	.042	0.001	PT23598-MPG	1	2.250	1.021	.200	0.006	RS30061	1	.650	0.295	.220	0.006
PT23502-MPG	1	2.600	1.179	.197	0.006	BT23600	1	4.700	2.132	.477	0.013	RS30062	1	5.550	2.517	1.283	0.036
PT23503-MPG	1	.650	0.295	.037	0.001	BT23603-MPG	6	2.542	1.153	.094	0.003	PA30063	1	.850	0.386	.133	0.004
PT23504-MPG	1	1.450	0.658	.081	0.002	BT23604	12	1.895	0.860	.053	0.001	PA30064	1	2.200	0.998	.372	0.011
PT23505-MPG	1	4.600	2.087	.378	0.011	BT23605-MPG	6	4.291	1.946	.237	0.007	RS30065	1	11.650	5.284	2.340	0.066
PT23506-MPG	1	2.900	1.315	.141	0.004	BT23607-MPG	6	2.100	0.953	.102	0.003	RS30065 KIT	1	15.400	6.985	4.117	0.117
PT23507-MPG	1	2.200	0.998	.105	0.003	BT23609-MPG	1	4.800	2.177	.226	0.006	PA30066	1	13.150	5.965	2.280	0.064
PT23508-MPG	1	8.150	3.697	.527	0.015	BT23611	12	1.563	0.709	.051	0.001	PA30067	1	4.600	2.087	.604	0.017
PT23509-MPG	1	1.450	0.658	.060	0.002	PT23613-MPG	1	9.800	4.445	.594	0.017	PA30068	1	1.350	0.612	.122	0.003
PT23510-MPG	1	.200	0.091	.017	0.001	PT23616-MPG	1	3.400	1.542	.228	0.006	PA30069	1	4.300	1.950	1.529	0.043
PT23511-MPG	1	3.850	1.746	.245	0.007	BT23617	12	1.291	0.586	.049	0.001	PA30070	1	3.950	1.792	.581	0.016
PT23512-MPG	1	.500	0.227	.033	0.001	BT23619-MPG	12	2.733	1.240	.106	0.003	CA30071	1	3.450	1.565	.784	0.022
PT23513-MPG	1	.500	0.227	.032	0.001	BT23628	12	1.971	0.894	.078	0.002	PA30072	6	1.158	0.525	.158	0.004
PT23514-MPG	1	1.650	0.748	.113	0.003	PT23629	12	.317	0.144	.024	0.001	PA30073	1	15.100	6.849	1.981	0.056
PT23515-MPG	1	4.200	1.905	.287	0.008	BT23630	12	.717	0.325	.029	0.001	PA30074	1	16.150	7.326	1.941	0.055
PT23516-MPG	1	.750	0.340	.053	0.001	BT23631	12	.567	0.257	.034	0.001	PA30075	1	2.350	1.066	.410	0.012
PT23517-MPG	1	5.300	2.404	.382	0.011	PT23633	6	1.017	0.461	.152	0.004	PA30076	1	2.950	1.338	.896	0.025
PT23518-MPG	1	1.250	0.567	.115	0.003	PA30000	1	.350	0.159	.089	0.003	RS30077	1	1.200	0.544	.197	0.006
PT23519-MPG	1	4.250	1.928	.282	0.008	PA30001	1	.200	0.091	.076	0.002	RS30078	1	.450	0.204	.106	0.003
PT23520-MPG	1	6.400	2.903	.380	0.011	PA30002	1	2.100	0.953	.280	0.008	CA30079	1	3.350	1.520	.581	0.016
PT23521-MPG	1	1.300	0.590	.245	0.007	PA30003	1	2.800	1.270	.581	0.016	PA30080	6	.716	0.325	.045	0.001
PT23522-MPG	1	2.350	1.066	.170	0.005	PA30004	1	2.400	1.089	.306	0.009	PA30081	1	.450	0.204	.082	0.002
PT23523-MPG	1	1.900	0.862	.135	0.004	PA30005	1	1.400	0.635	.189	0.005	PA30086	6	.591	0.268	.112	0.003
PT23524-MPG	1	.550	0.249	.022	0.001	PA30006	1	.550	0.249	.178	0.005	RS30087	1	14.600	6.623	3.431	0.097
BT23525-MPG	12	1.429	0.648	.063	0.002	PA30007	6	1.041	0.472	.214	0.006	RS30088	1	4.950	2.245	1.339	0.038
PT23526	1	2.150	0.975	.106	0.003	RS30008	1	14.050	6.373	3.351	0.095	RS30090-FN	1	6.000	2.722	1.650	0.047
PT23527	12	.350	0.159	.030	0.001	RS30009	1	3.600	1.633	1.078	0.031	RS30091	1	6.750	3.062	1.630	0.046
PT23528-MPG	1	.350	0.159	.014	0.001	PA30010	1	9.000	4.082	1.898	0.054	RS30092	1	1.950	0.885	.481	0.014
PT23530	1	1.750	0.794	.140	0.004	PA30011	6	.808	0.367	.125	0.004	PA30093	6	.425	0.193	.098	0.003
PT23531-MPG	1	4.600	2.087	.281	0.008	PA30012	6	.666	0.302	.076	0.002	PA30094	1	.300	0.136	.147	0.004
PT23532-MPG	1	1.250	0.567	.041	0.001	PA30013	1	1.900	0.862	.408	0.012	PA30095	1	2.650	1.202	.464	0.013
PT23533	1	2.550	1.157	.035	0.001	PA30014	12	.445	0.202	.086	0.002	PA30096	1	.350	0.159	.097	0.003
PT23536	12	.642	0.291	.060	0.002	PA30015	1	.450	0.204	.118	0.003	PA30098	1	.900	0.408	.114	0.003
PT23535	1	.662	0.300	.064	0.002	PA30016	12	.529	0.240	.062	0.002	RS30099	1	1.300	0.590	.144	0.004
BT23537	1	2.750	1.247	.113	0.003	PA30017	12	.508	0.230	.082	0.002	PA30100	1	.150	0.068	.024	0.001
BT23539	1	3.250	1.474	.184	0.005	PA30018	12	.562	0.255	.065	0.002	PA30101	1	.			

BALDWIN WEIGHTS AND VOLUMES

BALDWIN NUMBER	CASE QTY.	WEIGHT (ea.)		Volume (ea.)		BALDWIN NUMBER	CASE QTY.	WEIGHT (ea.)		Volume (ea.)		BALDWIN NUMBER	CASE QTY.	WEIGHT (ea.)		Volume (ea.)	
		lbs.	kgs.	ft ³	m ³			lbs.	kgs.	ft ³	m ³			lbs.	kgs.	ft ³	m ³
PA30107	1	.020	0.009	.021	0.001	PA30185	6	1.500	0.680	.259	0.007	RS30311	1	12.550	5.693	3.050	0.086
PA30108	1	2.900	1.315	.592	0.017	RS30187XP	1	13.600	6.169	2.943	0.083	RS30313	1	7.450	3.379	1.446	0.041
PA30109	1	9.000	4.082	1.566	0.044	PA30188	6	.105	0.048	.026	0.001	PA30314	1	13.650	6.192	2.061	0.058
PA30110	1	.500	0.227	.077	0.002	PA30189	6	.950	0.431	.133	0.004	PA30315	1	15.600	7.076	2.267	0.064
RS30112	1	7.400	3.357	1.933	0.055	PA30190	6	1.525	0.692	.165	0.005	PA30316	1	18.500	8.392	2.952	0.084
PA30113	1	.300	0.136	.089	0.003	RS30191	1	1.500	0.680	.517	0.015	PA30317	1	17.100	7.757	2.488	0.070
PA30114	1	.450	0.204	.177	0.005	RS30192	1	6.250	2.835	1.328	0.038	PA30318	1	15.600	7.076	2.026	0.057
PA30115	6	.383	0.174	.063	0.002	PA30193-FN	1	6.900	3.130	1.650	0.047	PA30319	1	17.950	8.142	2.753	0.078
RS30116	1	9.950	4.513	2.143	0.061	PA30194	1	1.400	0.635	.612	0.017	PA30320	1	12.350	5.602	1.593	0.045
PA30117	1	.550	0.249	.140	0.004	PA30204	12	.783	0.355	.066	0.002	PA30321	1	12.050	5.466	1.595	0.045
PA30118	1	1.800	0.816	.361	0.010	PA30206	1	2.550	1.157	.416	0.012	PA30322	1	19.100	8.664	2.822	0.080
PA30119	1	.550	0.249	.077	0.002	PA30207	1	2.550	1.157	.387	0.011	PA30323	1	22.650	10.274	3.452	0.098
RS30120	1	1.200	0.544	.302	0.009	PA30208	1	.500	0.227	.178	0.005	PA30324	6	.766	0.347	.108	0.003
RS30121	1	5.100	2.313	1.170	0.033	RS30209	1	1.000	0.454	.159	0.004	PA30325	6	.483	0.219	.115	0.003
PA30122	1	.750	0.340	.178	0.005	PA30211	1	1.600	0.726	.334	0.009	RS30327	1	10.100	4.581	2.610	0.074
PA30123	1	1.000	0.454	.186	0.005	RS30212	1	2.750	1.247	.495	0.014	RS30328	1	3.100	1.406	.824	0.023
PA30124	1	.850	0.386	.172	0.005	RS30213	1	.750	0.340	.241	0.007	PA30329	6	1.600	0.726	.185	0.005
PA30125	1	5.600	2.540	1.287	0.036	RS30216	1	8.050	3.651	1.966	0.056	PA30330	6	.533	0.242	.135	0.004
PA30126	6	1.117	0.507	.194	0.005	RS30217	1	2.000	0.907	.489	0.014	PA30331	6	.250	0.113	.035	0.001
PA30127	1	.600	0.272	.090	0.003	RS30220	1	1.800	0.816	.293	0.008	PA30332	6	.858	0.389	.127	0.004
RS30128	1	11.550	5.239	2.567	0.073	RS30221	1	.450	0.204	.124	0.004	PA31000	1	9.850	4.468	1.213	0.034
RS30129	1	4.050	1.837	1.056	0.030	RS30222XP	1	3.750	1.701	.748	0.021	PA31001	1	1.400	0.635	.145	0.004
RS30130	1	6.300	2.858	1.511	0.043	RS30223	1	7.050	3.198	1.332	0.038	PA31002	1	6.600	2.994	.873	0.025
CA30131	1	8.250	3.742	1.195	0.034	RS30224	1	2.250	1.021	.555	0.016	PA31003	1	1.250	0.567	.076	0.002
CA30132	1	8.650	3.924	1.400	0.040	RS30225	1	6.250	2.835	1.402	0.040	PA31004	1	5.200	2.359	.474	0.013
RS30133	1	9.150	4.150	2.048	0.058	RS30226	1	2.050	0.930	.513	0.015	PA31005	1	.850	0.386	.056	0.002
RS30134	1	2.950	1.338	.805	0.023	PA30228	1	.250	0.113	.070	0.002	PA31006	1	7.000	3.175	.647	0.018
RS30135	1	8.850	4.014	2.090	0.059	PA30229	1	.150	0.068	.029	0.001	PA31007	1	.900	0.408	.076	0.002
RS30136	1	2.550	1.157	.676	0.019	RS30232	1	9.150	4.150	1.924	0.054	PA31008	1	7.900	3.583	1.129	0.032
PA30137	1	.450	0.204	.098	0.003	PA30233-FN	1	4.950	2.245	.930	0.026	PA31009	1	1.550	0.703	.130	0.004
PA30138	12	.637	0.289	.319	0.009	RS30234	1	.450	0.204	.138	0.004	PA31010	1	2.800	1.270	.296	0.008
PA30139	12	.700	0.318	.353	0.010	PA30235	1	10.550	4.785	1.815	0.051	PA31011	1	.900	0.408	.061	0.002
PA30140	6	.475	0.215	.103	0.003	RS30236	1	5.400	2.449	.967	0.027	PA31012	1	5.300	2.404	.672	0.019
PA30141	6	.641	0.291	.141	0.004	RS30237	1	3.100	1.406	.881	0.025	PA31013	1	2.700	1.225	.241	0.007
RS30142	1	8.300	3.765	1.677	0.047	RS30243	1	.500	0.227	.129	0.004	PA31014	1	.600	0.272	.038	0.001
RS30142 KIT	1	10.900	4.944	3.146	0.089	PA30244	1	5.250	2.381	.891	0.025	PA32000	1	9.000	4.082	1.294	0.037
RS30143	1	9.900	4.491	2.012	0.057	PA30244	1	1.700	0.771	.217	0.006	PA32001	1	4.950	2.245	.654	0.019
RS30143 KIT	1	12.750	5.783	4.084	0.116	PA30249	6	.792	0.359	.114	0.003	PA32002	1	12.750	5.783	1.855	0.052
PA30144	6	.441	0.200	.095	0.003	PA30251	6	.441	0.200	.091	0.003	PA32003	1	6.400	2.903	.786	0.022
PA30145	1	10.800	4.899	2.457	0.070	PA30252	6	.675	0.306	.079	0.002	PA32004	1	.400	0.181	.029	0.001
PA30146	1	4.000	1.814	.847	0.024	PA30253	1	1.400	0.635	.268	0.008	B40000	12	.500	0.227	.027	0.001
RS30147	1	1.050	0.476	.175	0.005	PA30255	6	.517	0.235	.078	0.002	P40001	12	.229	0.104	.037	0.001
PA30148	1	.150	0.068	.030	0.001	RS30257	1	4.550	2.064	.911	0.026	P40002	12	.100	0.045	.008	**
PA30149	1	1.625	0.737	.392	0.011	PA30258	1	2.350	1.066	.292	0.008	P40003	12	.492	0.223	.089	0.003
PA30150	1	.300	0.136	.065	0.002	PA30260	6	.516	0.234	.120	0.003	C40004	1	1.000	0.454	.073	0.002
PA30151	6	.675	0.306	.104	0.003	PA30261	6	.158	0.072	.036	0.001	C40005	12	.804	0.365	.064	0.002
PA30152	6	.300	0.136	.053	0.001	PA30262	6	.241	0.109	.052	0.001	B40006	12	.758	0.344	.028	0.001
PA30153	12	.329	0.149	.038	0.001	PA30263	6	1.275	0.578	.227	0.006	BC40007	12	.400	0.181	.022	0.001
PA30154	6	.216	0.098	.066	0.002	PA30264	1	2.350	1.066	.174	0.005	P40008	6	1.100	0.499	.194	0.005
PA30155	1	.250	0.113	.103	0.003	PA30268	1	.600	0.272	.100	0.003	BC40009	6	.800	0.363	.099	0.003
PA30156	1	.850	0.386	.090	0.003	PA30269	12	.296	0.134	.066	0.002	P40010	12	.129	0.059	.020	0.001
PA30157	12	.010	0.005	.001	**	PA30270	6	.558	0.253	.083	0.002	P40011	12	.400	0.181	.034	0.001
PA30158	1	7.650	3.470	1.154	0.033	PA30271	1	7.500	3.402	.566	0.016	P40012	12	.833	0.378	.107	0.003
RS30159	1	8.400	3.810	2.174	0.062	PA30272	6	1.050	0.476	.146	0.004	B40013	1	5.700	2.586	.246	0.007
RS30160	1	2.450	1.111	.691	0.020	PA30275	1	4.500	2.041	.759	0.021	P40014	12	.171	0.078	.029	0.001
RS30161	1	8.450	3.833	1.662	0.047	PA30276	6	.341	0.155	.089	0.003	BT40015	12	.595	0.270	.027	0.001
RS30162	1	6.200	2.812	.366	0.010	PA30277	6	.408	0.185	.089	0.003	P40017	12	.400	0.181	.067	0.002
PA30163	1	.300	0.136	.165	0.005	PA30279	6	.508	0.230	.061	0.002	P40019	12	.800	0.363	.127	0.004
PA30164	1	.350	0.159	.071	0.002	PA30281	6	.141	0.064	.047	0.001	P40020	12	.354	0.161	.053	0.001
PA30165	1	.100	0.045	.071	0.002	RS30285	1	6.800	3.084	1.495	0.042	P40021	12	.304	0.138	.049	0.001
PA30166	1	.015	0.007	.017	**	PA30287	6	.166	0.075	.085	0.002	B40022-MPG	12	2.017	0.915	.099	0.003
RS30168	1	4.300	1.950	.856	0.024	RS30290	1	14.850	6.736	3.407	0.096	P40023	12	.317	0.144	.049	0.001
RS30169	1	1.000	0.454	.238	0.007	PA30292	1	2.000	0.901	.054	0.002	P40024	12	.238	0.108	.032	0.001
PA30170	1	9.450	4.287	2.087	0.059	PA30293	1	.350	0.159	.070	0.002	PA40025	12	.329	0.149	.046	0.001
PA30171	1	6.000	2.722	1.456	0.041	PA30299	6	1.766	0.801	.353	0.010	BD40027	6	4.167	1.890	.168	0.005
PA30172	1	.842	0.382	.285	0.008	PA30301	6	.550	0.249	.105	0.003	BT40028	12	1.033	0.469	.049	0.001
PA30173	1	.250	0.113	.060	0.002	PA30302	12	.112	0.051	.020	0.001	BT40029	12	1.996	0.905	.076	0.002
PA30174	6	.858	0.389	.181	0.005	PA30303	6	.775	0.352	.124	0.004	P40030	12	.463	0.210	.088	0.002
RS30175	1	7.950	3.606	1.901	0.054	PA30304	6	.733	0.332	.101	0.003	P40031-MPG	6	1.383	0.627	.188	0.005
PA30177	6	.533	0.242	.103	0.003	RS30305	1	8.750	3.969	1.974	0.056	BT40032	12	1.346	0.611	.065	0.002
PA30179	6	.400	0.181	.124	0.004	RS303											

BALDWIN WEIGHTS AND VOLUMES

BALDWIN NUMBER	CASE QTY.	WEIGHT (ea.) lbs.	WEIGHT (ea.) kgs.	Volume (ea.) ft ³	Volume (ea.) m ³	BALDWIN NUMBER	CASE QTY.	WEIGHT (ea.) lbs.	WEIGHT (ea.) kgs.	Volume (ea.) ft ³	Volume (ea.) m ³	BALDWIN NUMBER	CASE QTY.	WEIGHT (ea.) lbs.	WEIGHT (ea.) kgs.	Volume (ea.) ft ³	Volume (ea.) m ³
BT40038	12	.729	0.331	.022	0.001	BF45000	12	.129	0.059	.020	0.001	BF46098-O	6	1.533	0.695	.080	0.002
P40042	6	1.075	0.488	.163	0.005	BF46000	12	.962	0.436	.063	0.002	BF46099-O	6	1.975	0.896	.146	0.004
B40050	12	1.037	0.470	.119	0.003	BF46001	12	.900	0.408	.064	0.002	BF46100-O	6	1.550	0.703	.092	0.003
B40051	12	.758	0.344	.028	0.001	BF46002	6	3.883	1.761	.149	0.004	BF46101-O	6	2.142	0.972	.105	0.003
PF40052	12	.258	0.117	.034	0.001	PF46003	12	.792	0.359	.108	0.003	PF46103	12	.300	0.136	.035	0.001
B40053	6	3.067	1.391	.152	0.004	PF46004	12	.750	0.340	.105	0.003	BF46104	12	1.883	0.854	.065	0.002
B40054	12	1.804	0.818	.074	0.002	BF46005	12	.413	0.187	.030	0.001	BF46105-O	6	2.042	0.926	.104	0.003
B40056	12	1.342	0.609	.050	0.001	BF46006	12	.658	0.298	.034	0.001	PF46106	6	1.900	0.862	.204	0.006
P40058	12	.150	0.068	.017	0.001	BF46007	12	.100	0.045	.019	0.001	PF46108	12	.795	0.361	.089	0.003
P40061	12	.204	0.093	.036	0.001	BF46008	12	.170	0.077	.011	0.001	BF46109-O	6	1.990	0.903	.096	0.003
P40062	1	1.200	0.544	.217	0.006	PF46009	12	.200	0.091	.019	0.001	BF46111	12	.929	0.421	.048	0.001
B40063	6	2.175	0.987	.074	0.002	PF46010 KIT	1	2.550	1.157	.474	0.013	PF46112	12	.358	0.162	.037	0.001
BT40065	12	.912	0.414	.046	0.001	BF46012	12	1.212	0.550	.066	0.002	BF46113-D	12	.575	0.261	.050	0.001
BT40066-MPG	6	4.675	2.121	.200	0.006	BF46013	12	1.290	0.585	.061	0.002	BF46116 KIT	6	3.000	1.361	.181	0.005
B40070	12	1.317	0.597	.041	0.001	BF46014	12	1.180	0.535	.065	0.002	BF46117	12	2.529	1.147	.120	0.003
S40071	12	.200	0.091	.033	0.001	BF46015	12	2.350	1.066	.144	0.004	PF46118	12	.342	0.155	.049	0.001
B40073	12	1.175	0.533	.046	0.001	BF46016-O	12	1.862	0.845	.107	0.003	PF46119	12	.038	0.017	.004	0.001
P40074	6	.320	0.145	.060	0.002	BF46017-O	12	1.037	0.470	.052	0.001	BF46122	12	2.238	1.015	.101	0.003
OB40078	12	.754	0.342	.051	0.001	BF46018-O	6	1.842	0.836	.124	0.004	BF46123-O	6	2.358	1.070	.130	0.004
P40076	12	.246	0.112	.034	0.001	BF46019-O	12	1.033	0.469	.051	0.001	BF46125	12	.150	0.068	.012	0.001
OB40079	12	.704	0.319	.057	0.002	BF46020-O	12	1.041	0.472	.051	0.001	PF46126	12	.492	0.223	.062	0.002
OB40080	1	.800	0.363	.030	0.001	BF46021-O	12	1.112	0.504	.051	0.001	BF46127	12	1.608	0.729	.063	0.002
P40081	12	.425	0.193	.042	0.001	BF46022-O	12	1.116	0.506	.051	0.001	BF46128-D	6	1.866	0.846	.167	0.005
P40083	12	.492	0.223	.063	0.002	BF46023-O	12	1.045	0.474	.052	0.001	BF46129	6	4.200	1.905	.131	0.004
P40085	12	.279	0.127	.034	0.001	BF46024-O	12	1.050	0.476	.052	0.001	PF46130	12	.396	0.180	.065	0.002
P40086	12	.292	0.132	.033	0.001	BF46025-O	12	1.300	0.590	.065	0.002	BF46131	6	1.858	0.843	.082	0.002
P40089	12	.188	0.085	.021	0.001	BF46026-O	12	1.175	0.533	.063	0.002	PF46135	6	.783	0.355	.107	0.003
P40090	12	.179	0.081	.020	0.001	BF46027-O	12	1.362	0.618	.150	0.004	PF46137	12	.433	0.196	.049	0.001
P40091	12	.196	0.089	.021	0.001	BF46028-O	12	1.141	0.518	.081	0.002	PF46137 KIT	1	.950	0.431	.087	0.002
P40093	12	.321	0.146	.039	0.001	BF46029-O	12	1.079	0.489	.050	0.001	PF46138	12	.375	0.170	.038	0.001
P40094	12	.242	0.110	.031	0.001	BF46030-O	12	1.237	0.561	.065	0.002	PF46140	12	.416	0.189	.057	0.002
P40095	12	.283	0.128	.048	0.001	BF46031	12	1.508	0.684	.091	0.003	BF46141	12	1.608	0.729	.079	0.002
P40096	12	.288	0.131	.047	0.001	BF46032	12	2.116	0.960	.087	0.002	PF46142	6	.350	0.159	.070	0.002
P40098	12	.246	0.112	.047	0.001	PF46033	12	.570	0.259	.064	0.002	BF46143	12	1.725	0.782	.098	0.003
P40099	12	.233	0.106	.048	0.001	BF46034	12	2.595	1.177	.128	0.004	PF46145	6	2.667	1.210	.278	0.008
P40100	12	.263	0.119	.036	0.001	BF46037	12	1.025	0.465	.060	0.002	BF46147-O	12	1.404	0.637	.074	0.002
P40101	12	.110	0.050	.020	0.001	BF46038-D	12	.800	0.363	.064	0.002	BF46149-SP	12	1.275	0.578	.045	0.001
P40102	12	.238	0.108	.034	0.001	BF46039-D	12	.721	0.327	.065	0.002	BF46150-O	6	3.041	1.379	.240	0.007
P40103	12	.283	0.128	.038	0.001	BF46040-D	12	.562	0.255	.049	0.001	PF46151	12	.595	0.270	.059	0.002
P40104	12	.292	0.132	.033	0.001	BF46041-D	12	.792	0.359	.065	0.002	PF46152	12	.583	0.264	.081	0.002
P40105	12	.313	0.142	.041	0.001	BF46042-D	6	1.833	0.831	.166	0.005	BF46161	12	2.658	1.206	.122	0.003
P40106	12	.296	0.134	.041	0.001	BF46043-D	6	1.883	0.854	.164	0.005	BF46162-O	12	1.022	0.464	.048	0.001
P40107	12	.250	0.113	.050	0.001	BF46044-D	12	.800	0.363	.063	0.002	BF46163-O	12	1.725	0.782	.106	0.003
P40108	12	.242	0.110	.039	0.001	BF46045-D	12	.708	0.321	.051	0.001	BF46164-O	12	.754	0.342	.032	0.001
P40109	12	.196	0.089	.038	0.001	PF46046	12	.650	0.295	.081	0.002	BF46169-O	12	1.516	0.688	.100	0.003
P40110	12	.417	0.189	.061	0.002	BF46048	12	1.692	0.767	.066	0.002	BF46170	12	1.841	0.835	.087	0.002
P40111	12	.279	0.127	.038	0.001	PF46049	12	.500	0.227	.058	0.002	PF46171	6	1.183	0.537	.107	0.003
P40112	12	.213	0.097	.049	0.001	BF46050	12	1.650	0.748	.074	0.002	BF46173-O	6	2.383	1.081	.096	0.003
P40113	12	.208	0.094	.029	0.001	BF46051	12	1.367	0.620	.079	0.002	BF46175	12	.775	0.352	.062	0.002
P40114	12	.258	0.117	.033	0.001	BF46052	12	1.300	0.590	.066	0.002	BF46176	12	1.070	0.485	.053	0.001
P40115	12	.258	0.117	.049	0.001	PF46056	12	.567	0.257	.055	0.002	BF46179	6	5.016	2.275	.166	0.005
P40116	12	.146	0.066	.025	0.001	PF46057	12	.446	0.202	.033	0.001	BF46181-O	6	1.625	0.737	.105	0.003
P40117	12	.429	0.195	.065	0.002	PF46059	12	.358	0.162	.037	0.001	BF46182-O	12	1.579	0.716	.076	0.002
P40118	12	.312	0.142	.061	0.002	BF46062	12	1.150	0.522	.077	0.002	FB46183	12	1.746	0.792	.051	0.001
P40119	12	.200	0.091	.029	0.001	BF46064-D	6	1.591	0.722	.170	0.005	FB46184	1	1.300	0.590	.065	0.002
B40120	12	1.179	0.535	.060	0.002	BF46065-SPS	12	1.825	0.828	.079	0.002	FB46185	1	1.050	0.476	.065	0.002
B40122	12	TBD	TBD	TBD	TBD	BF46069	12	1.725	0.782	.077	0.002	PF46186	12	.613	0.278	.057	0.002
B40124	12	.663	0.301	.029	0.001	BF46071	12	2.650	1.202	.158	0.004	PF46187	12	.420	0.191	.060	0.002
B40125	12	.908	0.412	.048	0.001	BF46072	12	2.608	1.183	.153	0.004	PF46188	12	.463	0.210	.056	0.002
B40126	12	.667	0.303	.031	0.001	BF46073	12	2.921	1.325	.131	0.004	PF46189	12	.440	0.200	.060	0.002
B40127	12	1.254	0.569	.063	0.002	PF46076	12	.408	0.185	.048	0.001	BF46192	12	1.060	0.481	.101	0.003
B40128	12	.783	0.355	.036	0.001	PF46077	12	.158	0.072	.020	0.001	BF46193	12	.325	0.147	.037	0.001
B40129	12	.775	0.352	.038	0.001	BF46078-D	12	.567	0.257	.051	0.001	BF46194	12	.192	0.087	.021	0.001
P40130	12	.154	0.070	.030	0.001	PF46079	1	4.100	1.860	.441	0.012	BF46195	12	.879	0.399	.077	0.002
P40131	12	.154	0.070	.032	0.001	PF46080	6	2.233	1.013	.258	0.007	BF46196	12	.158	0.072	.020	0.001
P40132	12	.138	0.063	.011	0.001	PF46081	12	.858	0.389	.105	0.003	BF46197	12	.125	0.057	.020	0.001
B40133	12	1.646	0.747	.074	0.002	PF46082	12	.821	0.372	.104	0.003	BF46198	12	.658	0.298	.047	0.001
B40136	12	.695	0.315	.024	0.001	BF46083-O	6	1.558	0.707	.083	0.002	BF46199	12	.896	0.406	.067	0.002
B40137	6	1.966	0.892	.075	0.002	BF46084	12	.358	0.162	.048	0.001	BF46200	12	.792	0.359	.061	0.002
B40138	6	1.950	0.885	.074	0.002	BF46085	12	2.463	1.117	.098	0.003	BF46201	12	.763	0.346	.051	0.001
BD40139	6	5.050	2.291	.167	0.005	BF46087	12	.858	0.389	.095	0.003	BF46202	12	.546	0.248		

BALDWIN WEIGHTS AND VOLUMES

BALDWIN NUMBER	CASE QTY.	WEIGHT (ea.) lbs.	WEIGHT (ea.) kgs.	Volume (ea.) ft ³	Volume (ea.) m ³	BALDWIN NUMBER	CASE QTY.	WEIGHT (ea.) lbs.	WEIGHT (ea.) kgs.	Volume (ea.) ft ³	Volume (ea.) m ³	BALDWIN NUMBER	CASE QTY.	WEIGHT (ea.) lbs.	WEIGHT (ea.) kgs.	Volume (ea.) ft ³	Volume (ea.) m ³
BF46207	12	.471	.0214	.043	.0001	OAS98053	1	32.850	14.901	6.309	.0179	24-WLK	1	.300	.0136	.023	.0001
BF46208	12	.563	.0255	.046	.0001	OAS98054	1	25.350	11.499	5.715	.0162	285-DS	1	.200	.0091	.082	.0002
BF46209	12	.621	.0282	.037	.0001	OAS98056	1	4.600	2.087	.639	.0018	286-SK	1	.800	.0363	.013	.0004
BF46210	12	.608	.0276	.060	.0002	OAS98057	1	19.200	8.709	3.476	.0098	300	1	15.750	7.144	.863	.0024
BF46211	12	.525	.0238	.037	.0001	OAS98058	1	7.450	3.379	1.609	.0046	300-DHRAP5	1	120.000	54.432	37.875	1.072
BF46212	12	.375	.0170	.038	.0001	OAS98060	1	2.950	1.338	.094	.0003	300-DHRAS5	1	143.000	64.865	41.427	1.172
BF46213	1	.750	.0340	.434	.0012	OAS98061	1	7.500	3.402	.253	.0007	300-H	1	15.800	7.167	.871	.0025
BF46214	1	1.000	.0454	.167	.0005	OAS99001	1	2.800	1.270	.141	.0004	300-W30	1	15.550	7.053	.871	.0025
BF46215	12	.400	.0181	.037	.0001	OAS99005	1	3.700	1.678	.269	.0008	500	1	248.000	112.493	34.050	.964
BF46216	12	.454	.0206	.040	.0001	OAS99006	1	13.900	6.305	1.966	.0056	500-12	1	4.800	2.177	.237	.0007
BF46217	12	.837	.0380	.048	.0001	OAS99008	1	20.500	9.299	2.695	.0076	500-15	1	.500	.0027	.029	.0001
BF46218	12	.750	.0340	.080	.0002	OAS99014	1	20.000	9.072	2.260	.0064	500-BP22	1	289.500	131.317	38.250	1.082
BF46219	12	.850	.0386	.098	.0003	OAS99015	1	6.200	2.812	.616	.0017	500-MFVBP22	1	780.000	353.808	72.575	2.054
BF46220	12	.358	.0162	.048	.0001	OAS99017	1	5.700	2.586	.669	.0019	55-EK	1	.550	.0249	.125	.0004
BF46221	12	.525	.0238	.047	.0001	OAS99018	1	36.420	16.520	5.278	.0149	60-21	1	.250	.0113	.037	.0001
BF46222	12	.250	.0113	.078	.0002	OAS99020	1	6.100	2.767	.408	.0012	60-21A	1	.150	.0068	.041	.0001
BF46223	12	.454	.0206	.049	.0001	OAS99025	1	4.500	2.041	.422	.0012	60-30	1	.100	.0045	.001	.0001
BF46224	12	.580	.0263	.050	.0001	OAS99028	1	3.800	1.724	.210	.0006	60-GK	1	.100	.0045	.005	.0001
BF46225	12	.167	.0076	.019	.0001	OAS99029	1	5.150	2.336	.145	.0004	65	1	1.550	.0703	.111	.0003
BF46227	12	1.713	.0777	.075	.0002	OAS99034	1	10.000	4.536	1.280	.0036	65-35A	1	.050	.0023	.018	.0001
BF46228	12	.742	.0337	.033	.0001	OAS99035	12	1.700	0.771	.140	.0004	65-W30	1	1.550	.0703	.108	.0003
BF46229	12	.362	.0164	.035	.0001	OAS99038	1	9.550	4.332	1.493	.0042	75	1	2.050	.0930	.107	.0003
BF46233	12	2.779	1.261	.122	.0003	OAS99047	1	6.450	2.926	.282	.0008	75-21	1	.600	.0272	.036	.0001
PF46235	12	.796	.0361	.103	.0003	OAS99048	1	2.750	1.247	.080	.0002	75-W30	1	2.050	.0930	.110	.0003
PF46236	6	1.150	.0522	.167	.0005	1S-9133	1	.020	.0009	.003	.0001	85-EK	1	1.100	.0499	.352	.0010
PF46237	6	1.150	.0522	.167	.0005	4L-8212-R	1	.020	.0009	.002	.0001	85-P	1	.300	.0136	.008	.0001
PF46238	12	.763	.0346	.104	.0003	5H-5601	1	.001	.0001	.001	.0001	85-V	1	.350	.0159	.008	.0001
BD50000	6	4.425	2.007	.166	.0005	5M-954	1	.025	.0011	.002	.0001	AF521-WN	1	.050	.0023	.001	.0001
BF63000	12	1.592	.0722	.140	.0004	6L-1540	1	.010	.0005	.004	.0001	AF525-WN	1	.001	.0001	.001	.0001
OAS98000	12	.920	.0417	.032	.0001	7B-7635	1	.010	.0005	.002	.0001	ES1001	1	.001	.0001	.001	.0001
OAS98001	1	5.850	2.654	.662	.0019	8M-7830	1	.020	.0009	.004	.0001	ES1023	1	.001	.0001	.001	.0001
OAS98002	1	6.100	2.767	.605	.0017	G15-AF	1	.160	.0073	.001	.0001	ES1026	1	.020	.0009	.001	.0001
OAS98003	1	6.550	2.971	.569	.0016	G21-AF	1	.020	.0009	.019	.0001	ES1030	1	.020	.0009	.001	.0001
OAS98004	1	6.600	2.994	.569	.0016	100	1	4.850	2.200	.273	.0008	ES1031	1	.018	.0008	.001	.0001
OAS98005	1	4.950	2.245	.595	.0017	100-12	1	.300	.0136	.042	.0001	ES1032	1	.010	.0005	.001	.0001
OAS98006	1	7.400	3.357	.241	.0007	100-21	1	.250	.0113	.040	.0001	ES1034	1	.001	.0001	.001	.0001
OAS98007	1	7.400	3.357	1.443	.0041	100-21AL	1	.650	.0295	.040	.0001	ES1036	1	.001	.0001	.001	.0001
OAS98008	1	3.900	1.769	.569	.0016	100-21BP	1	.300	.0136	.040	.0001	ES1039	1	.020	.0009	.001	.0001
OAS98009	1	13.150	5.965	2.356	.0067	100-21M	1	.300	.0136	.040	.0001	ES1049	1	.001	.0001	.001	.0001
OAS98010	1	12.950	5.874	2.189	.0062	100-28	1	.010	.0005	.001	.0001	ES1066	1	.001	.0001	.001	.0001
OAS98011	1	3.750	1.701	.538	.0015	100-29	1	.050	.0023	.001	.0001	ES1067	1	.001	.0001	.001	.0001
OAS98012	1	2.050	.0930	.281	.0008	100-30	1	.100	.0045	.001	.0001	ES1068	1	.001	.0001	.001	.0001
OAS98013	1	34.300	15.558	6.493	.0184	100-BP	1	4.900	2.223	.269	.0008	ES1071	1	.001	.0001	.001	.0001
OAS98015	1	19.650	8.913	3.062	.0087	100-DEPR KIT	1	.250	.0113	.064	.0002	ES1074	1	.001	.0001	.001	.0001
OAS98016	1	5.000	2.268	.651	.0018	100-GK	1	.001	.0001	.001	.0001	ES1092	1	.020	.0009	.001	.0001
OAS98017	1	22.600	10.251	3.844	.0109	100-M	1	5.850	2.654	.267	.0008	ES1303-A	1	.020	.0009	.001	.0001
OAS98018	1	9.450	4.287	1.735	.0049	100-MFV	1	17.500	7.938	1.606	.0045	ES1303-B	1	.001	.0001	.001	.0001
OAS98019	1	6.050	2.744	.939	.0027	100-MMV	1	19.650	8.913	1.603	.0045	ES1369-A	1	.020	.0009	.001	.0001
OAS98020	1	8.500	3.856	1.590	.0045	100-MNTG KIT	1	.900	0.408	.023	.0001	ES1376	1	.001	.0001	.001	.0001
OAS98021	1	33.650	15.264	4.768	.0135	100-W	1	5.000	2.268	.264	.0007	ES1377	1	.001	.0001	.001	.0001
OAS98022	1	5.850	2.654	1.027	.0029	100-W30	1	4.850	2.200	.235	.0007	ES24-B	1	.001	.0001	.001	.0001
OAS98023	1	6.200	2.812	1.777	.0050	140-50 KIT	1	.150	.0068	.014	.0001	ES24-D	1	.001	.0001	.001	.0001
OAS98024	1	25.500	11.567	3.476	.0098	150	1	6.150	2.790	.368	.0010	ES3012	1	.001	.0001	.001	.0001
OAS98025	1	9.700	4.400	1.519	.0043	150-31	1	.100	.0045	.001	.0001	ES3028	1	.001	.0001	.001	.0001
OAS98026	1	22.950	10.410	3.843	.0109	150-GK	1	.010	.0005	.007	.0001	ES3029	1	.001	.0001	.001	.0001
OAS98027	1	14.400	6.532	3.970	.0112	150-H	1	6.400	2.903	.387	.0011	ES3063	1	.001	.0001	.001	.0001
OAS98028	1	4.400	1.996	.250	.0007	150-M	1	7.250	3.289	.379	.0011	ES3231	1	.040	.0018	.007	.0002
OAS98029	1	2.150	.0975	.309	.0009	150-W30	1	6.200	2.812	.379	.0011	ES4007	1	.010	.0005	.001	.0001
OAS98031	1	8.750	3.969	1.463	.0041	185-DS	1	.300	.0136	.042	.0001	ES4008	1	.001	.0001	.001	.0001
OAS98032	1	7.050	3.198	.613	.0017	186-SK	1	.650	.0295	.015	.0001	G102-A	1	.020	.0009	.002	.0001
OAS98033	1	15.700	7.122	2.194	.0062	200	1	12.100	5.489	.641	.0018	G103	1	.001	.0001	.001	.0001
OAS98034	1	30.850	13.994	3.804	.0108	200-15	1	.010	.0005	.003	.0001	G103-N	1	.001	.0001	.001	.0001
OAS98035	1	2.850	1.293	.582	.0016	200-21	1	.400	.0181	.122	.0003	G104	1	.020	.0009	.001	.0001
OAS98036	1	4.300	1.950	.534	.0015	200-21BP	1	.450	.0204	.117	.0003	G105	1	.001	.0001	.001	.0001
OAS98037	1	70.200	31.843	9.176	.0260	200-21H	1	.550	.0249	.111	.0003	G106	1	.010	.0005	.001	.0001
OAS98038	1	11.350	5.148	1.575	.0045	200-21HBP	1	.650	.0295	.117	.0003	G107	1	.001	.0001	.001	.0001
OAS98040	1	29.350	13.313	6.309	.0179	200-21M	1	.550	.0249	.118	.0003	G1086-AF	1	.080	.0036	.002	.0001
OAS98041	1	24.100	10.932	4.019	.0114	200-30U	1	.300	.0136	.002	.0001	G115-A	1	.001	.0001	.001	.0001
OAS98042	1	21.800	9.888	3.450	.0098	200-31	1	.100	.0045	.001	.0001	G115-MSB	1	.001	.0001	.001	.0001
OAS98043	1	3.000	1.361	.270	.0008	200-DEPR KIT	1	.400	.0181	.106	.0003	G120-A	1	.025	.0011	.001	.0001
OAS98044	1	5.250	2.381	.678	.0019	200-GK	1	.020	.0009	.012	.0001	G123	1	.010	.0005	.001	.0001
OAS98045	1	1.000	.0454	.104	.0003	200-M	1	13.300	6.033	.630	.0018	G127	1	.020	.0009	.001	.0001
OAS98046	1	13.900	6.305	2.662	.0075	200-MFV	1	36.100	16.375	2.821	.0080	G132	1	.020	.0009	.001	.0001
OAS98050	1	28.050	12.723	3.724													

BALDWIN WEIGHTS AND VOLUMES

BALDWIN NUMBER	CASE QTY.	WEIGHT (ea.) lbs.	WEIGHT (ea.) kgs.	Volume (ea.) ft ³	Volume (ea.) m ³	BALDWIN NUMBER	CASE QTY.	WEIGHT (ea.) lbs.	WEIGHT (ea.) kgs.	Volume (ea.) ft ³	Volume (ea.) m ³	BALDWIN NUMBER	CASE QTY.	WEIGHT (ea.) lbs.	WEIGHT (ea.) kgs.	Volume (ea.) ft ³	Volume (ea.) m ³
G141-AF	1	.267	.121	.402	.011	G298-AF	1	.100	.045	.040	.001	G449-B	1	.001	**	.001	**
G143	1	.001	**	.002	**	G299	1	.020	.009	.001	**	G458	1	.001	**	.001	**
G144	1	.020	.009	.002	**	G302	1	.010	.005	.001	**	G467	1	.003	.001	.001	**
G145-AF	1	.140	.064	.028	.001	G303	1	.020	.009	**	**	G468	1	.006	.003	.001	**
G147-A	1	.001	**	**	**	G304	1	.020	.009	.027	.001	G472-AF	1	.160	.073	.014	**
G148	1	.020	.009	.002	**	G305	1	.001	**	.006	**	G480	1	.020	.009	.001	**
G153	1	.001	**	.001	**	G306	1	.080	.036	.007	**	G483	1	.020	.009	.001	**
G155	1	.001	**	.006	**	G307	1	.001	**	.002	**	G494	1	.026	.012	.003	**
G157	1	.001	**	.008	**	G309-B	1	.001	**	.009	**	G498-A	1	.044	.020	.003	**
G161	1	.001	**	.001	**	G310	1	.001	**	.002	**	G499-AF	1	.240	.109	.028	.001
G162	1	.001	**	.001	**	G314	1	.020	.009	.004	**	G501-AF	1	.107	.049	.053	.001
G164-A	1	.020	.009	.002	**	G315	1	.001	**	.002	**	G523-AF	1	.290	.132	.010	**
G165	1	.001	**	**	**	G31-AF	1	.040	.018	.022	.001	G534-AF	1	.020	.009	.024	.001
G168-B	1	.020	.009	.001	**	G323	1	.001	**	.001	**	G704	1	.040	.018	.001	**
G169	1	.001	**	.002	**	G332	1	.010	.005	.001	**	G710	1	.022	.010	.001	**
G171	1	.001	**	.001	**	G333	1	.020	.009	.001	**	G717	1	.038	.017	.004	**
G172-A	1	.001	**	.001	**	G336	1	.001	**	.003	**	G725	1	.001	**	.003	**
G183	1	.010	.005	.001	**	G340	1	.001	**	.001	**						
G184-A	1	.010	.005	.002	**	G342	1	.001	**	.001	**						
G193	1	.001	**	.007	**	G343-A	1	.022	.010	.003	**						
G196-B	1	.001	**	.002	**	G344	1	.008	.004	.001	**						
G1972	1	.060	.027	.014	**	G347	1	.012	.005	.002	**						
G1973	1	.800	.363	.684	.019	G348-AF	1	.120	.054	.028	.001						
G202	1	.001	**	.001	**	G34-AF	1	.020	.009	.010	**						
G203	1	.020	.009	.002	**	G354	1	.014	.006	.003	**						
G204-A	1	.001	**	.001	**	G356	1	.028	.013	.003	**						
G206	1	.080	.036	.008	**	G359	1	.016	.007	.003	**						
G207-AF	1	.100	.045	.014	**	G360	1	.014	.006	.002	**						
G208-A	1	.010	.005	.001	**	G362	1	.020	.009	.002	**						
G210	1	.020	.009	.003	**	G363	1	.014	.006	.002	**						
G211	1	.001	**	.003	**	G366	1	.008	.004	.001	**						
G214	1	.001	**	.001	**	G368	1	.020	.009	.002	**						
G219	1	.020	.009	.002	**	G369-B	1	.001	**	.001	**						
G220	1	.020	.009	.001	**	G369-V	1	.010	.005	.002	**						
G222-B	1	.020	.009	.001	**	G372	1	.032	.015	.002	**						
G225-AF	1	.180	.082	.193	.005	G376	1	.013	.006	.001	**						
G229	1	.001	**	.001	**	G379	1	.006	.003	.001	**						
G232	1	.020	.009	.001	**	G37-AF	1	.060	.027	.025	.001						
G233-A	1	.001	**	.001	**	G380	1	.044	.020	.002	**						
G233-B	1	.001	**	.001	**	G381-A	1	.013	.006	.001	**						
G236-A	1	.020	.009	.003	**	G382	1	.016	.007	.003	**						
G238	1	.001	**	.007	**	G382-V	1	.024	.011	.003	**						
G239	1	.020	.009	.001	**	G385	1	.001	**	.003	**						
G240	1	.020	.009	.001	**	G386	1	.024	.011	.003	**						
G241	1	.001	**	.001	**	G392	1	.032	.015	.003	**						
G243-A	1	.010	.005	.001	**	G394	1	.034	.015	.004	**						
G247	1	.001	**	.001	**	G397	1	.001	**	.002	**						
G251	1	.001	**	.001	**	G39-AF	1	.006	.003	.001	**						
G252	1	.001	**	.008	**	G400	1	.064	.029	.005	**						
G253-A	1	.020	.009	.002	**	G401	1	.001	**	.001	**						
G255	1	.001	**	.001	**	G402	1	.010	.005	.001	**						
G257	1	.010	.005	.002	**	G403	1	.006	.003	.001	**						
G25-AF	1	.160	.073	.026	.001	G406	1	.018	.008	.002	**						
G260	1	.001	**	.002	**	G409	1	.026	.012	.002	**						
G261	1	.001	**	.004	**	G410	1	.010	.005	.001	**						
G263	1	.030	.014	.004	**	G411	1	.028	.013	.002	**						
G264-A	1	.001	**	.001	**	G412	1	.020	.009	.004	**						
G265	1	.020	.009	.002	**	G416	1	.056	.025	.005	**						
G268	1	.001	**	.001	**	G417	1	.042	.019	.003	**						
G269	1	.020	.009	.002	**	G422-AF	1	.220	.100	.026	.001						
G270	1	.001	**	.001	**	G431	1	.012	.005	.001	**						
G273	1	.010	.005	.001	**	G432	1	.001	**	.001	**						
G274	1	.019	.009	.001	**	G433	1	.030	.014	.004	**						
G275	1	.020	.009	.001	**	G434	1	.014	.006	.001	**						
G278	1	.040	.018	.004	**	G435	1	.008	.004	.001	**						
G280	1	.001	**	.002	**	G436	1	.016	.007	.001	**						
G281	1	.020	.009	.002	**	G438	1	.044	.020	.009	**						
G283	1	.001	**	**	**	G439	1	.024	.011	.003	**						
G285-AF	1	.150	.068	.039	.001	G441	1	.006	.003	.001	**						
G286-C	1	.001	**	.006	**	G442	1	.007	.003	.001	**						
G288	1	.040	.018	.001	**	G443	1	.012	.005	.002	**						
G289	1	.020	.009	.005	**	G444	1	.001	**	.002	**						
G291	1	.020	.009	.001	**	G445	1	.026	.012	.003	**						
G293-B	1	.060	.027	.006	**	G446	1	.048	.022	.004	**						
G296	1	.020	.009	.002	**	G447	1	.011	.005	.001	**						

* Sold in Full Cases Only. TBD To be Determined. ** Measurement is less than 0.001.



WARNING: These products can expose you to chemicals, including Diisononyl Phthalate, Carbon black extracts, Nickel, 1,3 Butadiene, Ethylene Oxide, Epichlorohydrin, which are known to the State of California to cause cancer, and Bisphenol-A, Ethylene Glycol, Ethylene Oxide, 1,3 Butadiene, Epichlorohydrin, which are known to the State of California to cause birth defects or other reproductive harm. For more information go to www.P65Warnings.ca.gov.

FILTER WRENCHES



**PKG400 4 1/8" - 5" O.D.
(104.8 - 127.0)**

BT5	BF588	BF1354-SPS	B7223
B45	BF596	BF1355	B7225
B49	B605	BF1355-O	B7227
B75	BT610-MPG	BF1355-SP	B7239
B76	BT611-MPG	BF1357	B7241
B76-MPG	BT774	BF1358-O	B7246
B76-SS	BT775	BF1358-SP	BD7250
B95	BF783	BF1359-SP	BD7252
B95-MPG	BF784	BF1360	B7280
B95-SS	BF785	BF1360-O	BD7309
B96	BF786	BF1360-SP	BD7310
B96-MPG	BF876	BF1362	BT7316
B96-SS	BF877	BF1363	B7324
B97	BF880-FP	BF1370	BD7325
BD103	BF976	BF1373-SP	B7373
BD103-MPG	BF1210	BF1374-SP	B7383
BD103-SS	BF1211	BF1375	B7385
B105	BF1216	BF1377	B7386
BT124	BF1218	BF1382-SP	B7393
B128	BF1219	BF1383-O	B7396
B129	BF1222	BF1386-O	B7397
B134	BF1222-O	BF1387-O	B7409
BD142	BF1222-SP	BF1388-O	B7416
B157	BF1223	BF1389-O	B7459
B196	BF1223-O	BF1390-O	B7468
B201-S	BF1223-SP	BF1391-O	B7477
B205	BF1224	BF1395-O	B7483
B211	BF1231	BF1395-SP	B7501
B218	BF1240	BF1397-SP	B7503
B220	BF1256	BF1399-SP	BD7504
BT221	BF1262	B5177	B7506
B222	BF1265	BW5179	BD7509
BD232	BF1273-SP	B7004	B7513
BT234	BF1274-SP	B7005	B7577
BT238	BF1274-SPS	B7009	BF7584
B263	BF1277-SP	B7018	B7585
BT267	BF1277-SPS	B7019	BF7593
B309	BF1281	BD7028	BF7612
BD324	BF1281-O	B7039	BF7613
BD325	BF1283	B7045	BF7628
B326	BF1283-O	B7051	BF7629
B333	BF1283-SP	BD7105	BF7656
B337	BF1285-SP	B7113	BF7657
BT340	BF1286	B7116	B7685
BT347	BF1287-O	B7121	BF7697
BT348	BF1288-O	B7124	B7700
BT349	BF1292-O	B7130	BF7717
BT350	BF1294-O	B7131	BF7773
BT351	BF1296-O	BD7141	BF7814
BT351-MPG	BF1297-O	B7142	BF7853
BT355	BF1298-O	B7144	BF7911
BT359	BF1299-O	B7151	BF7913
BT398	BF1329	BD7153	BF7927
BT402	BF1329-SP	BD7154	BF7932
B404	BF1330-SP	B7155	BF7943
BT440	BF1339-SP	BD7158	BF7948
BT443	BF1345	BD7159	BT8302
B447	BF1345-O	B7164	BT8320
BT470	BF1345-SP	BD7166	BT8381
BT472	BF1346	BD7168	BT8401-MPG
B494	BF1346-O	BD7169	BT8432-MPG
B495	BF1346-SP	B7171	BT8450
B495-MPG	BF1347	BF174-MPG	BT8457-MPG
B495-SS	BF1347-O	BD7176	BT8471-MPG
BT521	BF1348	B7179	BT8475
BT556-10	BF1348-O	B7189	BT8475-MPG
BT564	BF1348-SP	B7191	BT8476
BF584	BF1349	B7217	BT8476-MPG
BF584-B	BF1353-SPS	B7219	BT8477

**PKG400 4 1/8" - 5" O.D. (Cont'd.)
(104.8 - 127.0)**

B40142	BF46061	BF46105-O	BF46134-O	BF46181-O
B40145	BF46073	BF46109-O	BF46147-O	BF46182-O
BF46002	BF46083-O	BF46116 KIT	BF46150-O	BF46233
BF46016-O	BF46085	BF46117	BF46161	BF46234
BF46018-O	BF46098-O	BF46122	BF46163-O	BF46244
BF46027-O	BF46099-O	BF46123-O	BF46169-O	BF46248
BF46031	BF46100-O	BF46129	BF46173-O	BD50000
BF46034	BF46101-O	BF46131	BF46179	OAS99028

**PKG401 4 3/8" - 5 1/4" O.D.
(111.1 - 133.4)**



B49	BF785	B7335-MPG	BT8803-MPG	BF9866-O
B95	BF1216	B7396	BT8805-MPG	BF9867-O
B95-MPG	BF1239	B7416	BT8812-MPG	BF9885
B95-SS	BF1262	B7468	BT8813-MPG	BF9888
B96	BF1274-SP	B7503	BT8870-MPG	BF9920
B96-MPG	BF1274-SPS	BD7504	BT8873	BT23140-MPG
B96-SS	BF1277-SP	BD7509	BT8874-MPG	BT23539
B97	BF1277-SPS	B7513	BT8875-MPG	BT23542-MPG
BD103	BF1281-O	BF7571	BT8876-MPG	BT23543-MPG
BD103-MPG	BF1283-O	B7577	BT8877-MPG	BT23603-MPG
BD103-SS	BF1287-O	BF7623	BT8878-MPG	BT23609-MPG
B105	BF1288-O	BF7697	BT8879-MPG	BD40027
B196	BF1347-O	BF7717	BT8880-MPG	B40053
B205	BF1355	BF7913	BT8890-MPG	BT40066-MPG
B220	BF1355-O	BF7932	BT8892-MPG	BT40067-MPG
BT287	BF1355-SP	BF7948	BT8901-MPG	B40138
BT287-10	BF1357	BT8307-MPG	BT8910-MPG	BD40139
BT287-3	BF1358-O	BT8308-MPG	BT8911-MPG	B40142
BD324	BF1395-O	BT8308-MPG	BT8915	B40145
B333	BD1403	KIT	BT8927	BF46002
BT345 KIT	BA5371	BT8309-MPG	BT8930	BF46027-O
BT351	B7004	BT8310-MPG	BT8931	BF46061
BT351-MPG	BF9871-O	B7005	BT8937	BF46083-O
BT359	BF9885	B7011	BT9320	BF46109-O
BT387	BF9888	B7019	BT9324	BF46122
BT387-10	BF7911	BD7105	BT9343-MPG	BF46123-O
BT388	BF9898-O	BD7141	BT9345	BF46129
BT388-10	BF9903-SP	BD7153	BT9347-MPG	BF46150-O
BT389	BF9912-O	BD7154	BT9353-MPG	BF46173-O
BT389-10	BF9917	B7155	BT9356	BF46179
B404	BF9920	BD7159	BT9360	BF46244
BT424	BT8302	BD7166	BT9362-MPG	BF46248
BT425	BF9925-O	BD7169	BT9365-MPG	BD50000
BT443	BT23542-MPG	BD7176	BT9367-MPG	
BT486	BT23543-MPG	BT486	BT9369-MPG	
B495	BT23603-MPG	B495	BT9371-MPG	
B495-MPG	BT23609-MPG	B7241	BT9391-MPG	
B495-SS	BD40027	B7246	BT9421-MPG	
BT610-MPG	B40053	BD7250	BT9439	
BT611-MPG	B40054	BD7252	BT9558-MPG	
BT774	BT40066-MPG	BD7309	BT9560-MPG	
BT775	BT40067-MPG	BD7310	B9606	
BF784	B40138	B7324	BF9860	
	BD40139	BD7325	BF9864	



WARNING: These products can expose you to chemicals, including Diisononyl Phthalate, Carbon black extracts, Nickel, 1,3 Butadiene, Ethylene Oxide, Epichlorohydrin, which are known to the State of California to cause cancer, and Bisphenol-A, Ethylene Glycol, Ethylene Oxide, 1,3 Butadiene, Epichlorohydrin, which are known to the State of California to cause birth defects or other reproductive harm. For more information go to www.P65Warnings.ca.gov.

FILTER WRENCHES

PKG402 4 3/4" - 5 1/2" O.D. (120.7 - 139.7)



B99	BF1355-O	B7299	BT8475	BT9343-MPG
B99-B	BD1403	B7314	BT8475-MPG	BT9345
B99-MPG	BA5284	B7335-MPG	BT8476	BT9356
B99-SS	BA5371	B7363	BT8476-MPG	BT9360
B239	BA5374	B7402	BT8477	BT9371-MPG
BT287	BA5375	B7507	BT8477-MPG	BT9377
BT287-10	BA5376	BF7571	BT8510-MPG	BT9387
BT287-3	BA5378	BF7623	BT8800-MPG	BT9533
BT343	BA5379	BF7635	BT8801-MPG	BT23140-MPG
BT345 KIT	BA5566	BF7639	BT8802-MPG	BT23537
BT351	BA5592	BF7639-D	BT8803-MPG	BT23539
BT351-MPG	B7011	BF7996	BT8805-MPG	BT23542-MPG
BT387	B7030	BT8307-MPG	BT8812-MPG	BT23555-MPG
BT387-10	B7097	BT8308-MPG	BT8813-MPG	BT23605-MPG
BT388	B7135	BT8308-MPG	BT8873	BT23609-MPG
BT388-10	B7157	KIT	BT8876-MPG	B40013
BT389	B7161	BT8309-MPG	BT8899	BF46150-O
BT389-10	B7162	BT8310-MPG	BT8901-MPG	BF46173-O
BT424	B7175	BT8368	BT8906	BF46251-SP
BT425	B7180	BT8382	BT8915	BF46252-SP
BT486	B7182	BT8421-MPG	BT8927	BF46256
BT774	B7187	BT8422-MPG	BT8930	OAS99029
BT775	B7224	BT8423	BT8931	OAS99047
BF799	B7229	BT8437	BT8937	
BF1239	B7245	BT8450	BT9164	
BF1287-O	B7246	BT8457-MPG	BT9320	
BF1288-O	B7249-MPG	BT8471-MPG	BT9324	

PKG411 2 9/16" - 3 11/16" O.D. (65.1 - 93.7)



PKG411 2 9/16" - 3 11/16" O.D. (65.1 - 93.7)

PKG 411 (65.1 to 93.7)	B164	B281	B403	BF791	BF988	B1406	B7091	B7387	BF7664
B2	B167	BT292	BT420	BF797	BF991	B1407	BD7095	B7388	BF7666
B2-HPG	B168	B295	B421	BF798	BF992	B1410	B7099	B7390	BF7683
B4	B173-S	B296	BT427	BT839	BF1056	B1413	B7117	B7395	BF7695
B6	B178	B299	BT452	BT839-10	BF1102	B1416	B7119	B7401	BF7696
B6-HPG	B179	B301	B474	BF862	BF1110	B1421	B7125	B7403	BF7747
B7	B195	BT305	B481	BF863	BF1204	B1422	B7128	B7407	BF7750
B9	B199	B307	B488	BF888	BF1204-SP	B1425	B7139	B7410	BF7753
BF13	B202	BT310	BT525	BF891	BF1205-SP	B1428	B7143	B7419	BF7759
BD28	BT215	B329	BT526	BF892	BF1212	B1429	B7152	B7420	BF7760
B30	BT216	BF330	BT526-10	BF896	BF1213	B1430	B7156	B7422	BF7772
B31	BT217	BT334	BT536	BF900	BF1214	B1431	BD7160	B7424	BF7774
B33	BT223	B336	BT541	BF915	BF1214	B1432	B7165	B7428	BF7798-O
B34	B227	BT338	BF577	BF938	BF1217	B1434	B7167	B7430	BF7798-SP
B35-S	B228	BT339	BF582	BF939	BF1220	B1435	B7170	B7432	BF7806
B37	B229	BT341	BF583	BF940	BF1221	B1438	B7172	B7433	BF7806-O
B39	BT230	BT342	BF585	BF941	BF1222	B1441	B7177	B7434	BF7813
B43-S	B233	BT346	BF586	BF948	BF1225	B1444	B7181	B7440	BF7837
B50	B236	BT353	BF586-D	BF948-JD	BF1226	B1447	B7197	B7441	BF7838
B56	BT237	BT354	BF587	BF954	BF1232	BW5070	B7215	B7443	BF7840
BT111	B243	BT357	BF587-D	BF955	BF1233	BW5071	B7216	B7444	BF7844
BT112	B244	B358	BF591	BF955 KIT	BF1248	BW5072	B7220	B7445	BF7879
B113	B247	BT361	BF592	BF956	BF1249	BW5073	B7221	B7446	BF7880
B118	BT248	BT364	BT595	BF957	BF1249-SP	BW5074	B7222	B7449	BF7883
B120	BT251	BT365	BF597	BF957-D	BF1252	BW5075	B7231	B7451	BF7886
BT126	B252	BT365-10	BT606-MPG	BF958	BF1253	BW5076	BT7237	B7453	BF7888
B131	B253	BT366-10	BF614	BF962	BF1257	BW5082	B7238	B7457	BF7892
B132	B255	BT367	BF719	BF968	BF1258	B5088	B7240	B7458	BF7907
B141	BT259	BT367-S	BF720	BF970	BF1259	B5089	B7243	B7461	BF7908
B143	BT260	BT368	BT778	BF971	BF1261	B5090	B7271	B7467	BF7909
B156	BT260-10	B369	BT779	BF974-D	BF1266	B5091	B7273	B7469	BF7915
B159	BT261	BT372-10	BF781	B795	BF1267	B5134	B7274	B7487	BF7917
B160	B262	BT372-MPG	BF782	BF978	BF1268	BW5136	B7275	B7491	BF7919
B161-S	BT264	B378	BF788	BF979	BF1269	BW5137	B7276	B7496	BF7921
B163	BT274	B378-10	BF789	BF980	BF1270-SP	BW5138	B7277	B7497	BF7922
	B279	BT395	BF790	BF984	BF1271	BW5139	B7281	B7499	BF7923
					BF1272-SPS	BW5140	B7283	B7511	BF7925
					BF1275	BW5141	B7285	BF7528	BF7931
					BF1276	BW5142	B7286	BF7529	BF7940
					BF1278	BW5143	B7287	BF7531	BF7957
					BF1278-O	B5144	B7289	BF7532	BF7966
					BF1280	B5145	B7290	BF7534	BF7967
					BF1282	B5176	B7291	BF7535	BF7968
					BF1282-O	BW5178	B7292	BF7538	BF7969
					BF1289-SP	BW5182	B7293	BF7541	BF7970
					BF1293-SPS	BW5183	B7294	BF7544	BF7976
					BF1350-SP	BW5200	B7295	BF7546	BF7981
					BF1352-SPS	BW5201	B7306	BF7552	BF7985
					BF1356	BW5250	B7311-MPG	BF7557	BF7990
					BF1361	BF5587-D	BD7317	BF7558	BF7993
					BF1365	BF5800	B7318	BF7559	BF7998
					BF1366-O	BF5801	BF320	BF7586	BT8304
					BF1367	BF5810	B7327	BF7587	BT8314
					BF1371	BF5812	B7333	BF7591-D	BT8316-MPG
					BF1372	BF5813	BF334	BF7598	BT8323
					BF1376	BF5815	BT7349	BF7602	BT8328
					BF1379	BF5816	B7351-MPG	BF7606	BT8333
					BF1379-O	B7001	B7352	BF7608	BT8357
					BF1380	B7010	B7356	BF7614	BT8384
					BF1380-O	B7014	B7360	BF7619	BT8391
					BF1381	B7020	BF7624	BF7624	BT8393
					BF1381-O	B7023	B7362	BF7631	BT8409
					BF1384-SP	B7024	B7367	BF7632	BT8413
					BF1385-SPS	B7025	BF7370	BF7633	BT8415
					BF1393-SP	B7026-MPG	B7372	BF7634	BT8417
					BF1394-SP	B7031	B7375	BF7637	BT8418
					BF1396	B7033	BF7376	BF7640	BT8420
					BF1398-O	B7042	B7377	BF7644	BT8428-MPG
					B1400	B7049	B7378	BF7648	BT8440-MPG
					B1402	B7082	BF7379	BF7653	BT8445
					B1405	B7089	B7384	BF7663	BT8460



WARNING: These products can expose you to chemicals, including Diisononyl Phthalate, Carbon black extracts, Nickel, 1,3 Butadiene, Ethylene Oxide, Epichlorohydrin, which are known to the State of California to cause cancer, and Bisphenol-A, Ethylene Glycol, Ethylene Oxide, 1,3 Butadiene, Epichlorohydrin, which are known to the State of California to cause birth defects or other reproductive harm. For more information go to www.P65Warnings.ca.gov.

FILTER WRENCHES

**PKG411 2 9/16" - 3 11/16" O.D. (Cont'd.)
(65.1 - 93.7)**

BT8472	BT8917	BF9831	BT23630	B40140
BT8473	BT8918	BF9834	BT23631	B40150
BT8474	BT8926	BF9841	B40000	BF46012
BT8493	BT9346-MPG	BF9842	B40006	BF46014
BT8499	BT9349-MPG	BF9850	BT40015	BF46015
BT8501-MPG	BT9366-MPG	BF9852	BT40028	BF46021-O
BT8502	BT9382	BF9876	BT40032	BF46022-O
BT8504	BT9388	BF9877	BT40034	BF46032
BT8505	BT9392-MPG	BF9878	B40036	BF46048
BT8509-MPG	BT9393-MPG	BF9883	BT40065	BF46065-SPS
BT8830	BT9402	BF9887	B40070	BF46111
BT8831	BT9408	BF9893	B40073	BF46141
BT8832	BT9440	BF9894	B40120	BF46143
BT8833	BT9442-MPG	BF9910	B40121	BF46149-SP
BT8886-MPG	BT9464	BF9913	B40124	BF46164-O
BT8898	BT9465	BF9922-O	B40125	BF46170
BT8900	BF9812	CV15016	B40126	BF46176
BT8902	BF9813	BW21000	B40127	BF46228
BT8903	BF9815	BT23604	B40128	BF46230
BT8908	BF9820	BT23607-MPG	B40129	OAS98000
BT8916	BF9821	BT23611	B40136	

**PKG412 3 5/8" - 4" O.D. (Cont'd.)
(92.1 - 101.6)**

BW5072	B7271	BF7766	BT8502	BF9893
BW5073	B7273	BF7774	BT8504	BF9894
BW5074	B7274	BF7798-O	BT8505	BF9904
BW5075	B7291	BF7798-SP	BT8509-MPG	BF9913
BW5076	B7298	BF7806	BT8512	BF9922-O
BW5082	B7306	BF7806-O	BT8830	BF9923-O
BW5086	B7311-MPG	BF7813	BT8831	BF9927
B5087	BD7317	BF7815	BT8832	CV15016
B5088	B7320	BF7842	BT8833	BW21000
B5089	B7322	BF7879	BT8834-MPG	BT23525-MPG
B5090	B7327	BF7883	BT8840-MPG	BT23540
B5091	B7328	BF7886	BT8841-MPG	BT23611
B5134	BT7349	BF7888	BT8842-MPG	BT23617
BW5136	B7350	BF7907	BT8843-MPG	BT23619-MPG
BW5137	B7351-MPG	BF7908	BT8844	B40022-MPG
BW5138	B7357	BF7917	BT8845	BT40028
BW5139	B7359	BF7919	BT8846	BT40029
BW5140	B7360	BF7922	BT8847	BT40032
BW5141	B7362	BF7923	BT8848-MPG	B40050
BW5142	B7372	BF7924	BT8849-MPG	B40051
BW5143	B7375	BF7925	BT8850-MPG	B40056
B5144	B7376	BF7940	BT8851-MPG	B40063
B5145	B7377	BF7941	BT8852-MPG	BT40065
B5176	B7378	BF7942	BT8853-MPG	B40070
BW5178	B7379	BF7955	BT8855-MPG	B40073
BW5182	B7388	BF7957	BT8856-MPG	B40120
BW5183	B7395	BF7966	BT8861	B40121
BW5200	B7403	BF7968	BT8862	B40133
BW5201	B7420	BF7968-O	BT8863	B40150
BW5250	B7424	BF7979	BT8898	BF46015
BF5800	B7431	BF7981	BT8900	BF46017-O
BF5801	B7440	BF7985	BT8903	BF46019-O
BF5810	B7451	BF7987	BT8904-MPG	BF46020-O
BF5812	B7453	BF7988	BT8905	BF46021-O
BF5813	B7467	BF7993	BT8913-MPG	BF46022-O
BF5813-O	B7486	BF7995	BT8914	BF46023-O
BF5815	B7496	BF7997	BT8916	BF46024-O
BF5816	B7497	BT8301	BT8918	BF46025-O
B7001	B7499	BT8304	BT8919	BF46026-O
B7014	B7511	BT8312	BT8922	BF46028-O
B7022	B7516	BT8314	BT8926	BF46029-O
B7023	BF7528	BT8316-MPG	BT8928	BF46030-O
B7024	BF7529	BT8328	BT8935	BF46032
B7025	BF7538	BT8347	BT9316-MPG	BF46036 KIT
B7026-MPG	BF7541	BT8357	BT9318	BF46048
BD7029	BF7546	BT8391	BT9321	BF46050
B7031	BF7552	BT8393	BT9326	BF46065-SPS
B7034	BF7557	BT8397-MPG	BT9346-MPG	BF46068
B7042	BF7558	BT8415	BT9358	BF46069
B7044	BF7559	BT8416	BT9363-MPG	BF46104
B7047	BF7586	BT8420	BT9364	BF46111
B7082	BF7587	BT8426-MPG	BT9366-MPG	BF46127
B7089	BF7602	BT8428-MPG	BT9368-MPG	BF46141
BD7095	BF7606	BT8439-MPG	BT9370-MPG	BF46143
B7099	BF7614	BT8440-MPG	BT9382	BF46156
B7117	BF7624	BT8443	BT9398-MPG	BF46157
B7125	BF7631	BT8444	BT9400-MPG	BF46158
B7128	BF7632	BT8445	BT9433	BF46159
B7143	BF7633	BT8449	BT9436-MPG	BF46162-O
B7152	BF7640	BT8449-10	BT9442-MPG	BF46170
B7156	BF7644	BT8463-MPG	BT9456	BF46175
B7163	BF7645	BT8464	BT9465	BF46227
B7170	BF7653	BT8465	BT9466-MPG	OAS98060
B7177	BF7664	BT8472	BT9471	OAS99048
B7181	BF7666	BT8473	BT9553	
B7197	BF7695	BT8474	BT9561	
B7215	BF7696	BT8486	B9601	
B7220	BF7747	BT8488	BF9820	
B7221	BF7750	BT8493	BF9834	
B7231	BF7753	BT8497-MPG	BF9877	
BT7237	BF7759	BT8499	BF9878	
B7240	BF7760	BT8501-MPG	BF9887	

**PKG412 3 5/8" - 4" O.D.
(92.1 - 101.6)**



B2	B255	B378	BF862	BF1249
B2-HPG	BT259	B378-10	BF863	BF1249-O
B6	BT260	BT395	BF888	BF1249-SP
B6-HPG	BT260-10	B403	BF891	BF1252
B7	BT261	BT420	BF892	BF1253
B9	B262	BT427	BF896	BF1258
B27	BT264	BT438	BF900	BF1259
BD28	BT274	BT452	BF915	BF1266
B34	B279	B481	BF948	BF1268
B39	B281	B488	BF948-JD	BF1270-SP
B50	BT292	BT525	BF955	BF1271
B74	B296	BT526	BF955 KIT	BF1272-SPS
B109	B299	BT526-10	BF956	BF1278
BT111	BT305	BT536	BF957	BF1278-O
BT112	B329	BT541	BF957-D	BF1279
B114	BT334	BF577	BF958	BF1280
B118	B336	BF582	BF962	BF1282
B120	BT338	BF583	BF968	BF1282-O
BT126	BT339	BF585	BF970	BF1289-SP
B132	BT341	BF591	BF971	BF1293-SPS
B141	BT342	BF592	BF974-D	BF1350-SP
B156	BT344-S	BF593	B975	BF1352-SPS
B163	BT346	BF595	BF978	BF1356
B164	BT354	BF597	BF979	BF1361
B166	BT357	BT606-MPG	BF980	BF1365
B167	B358	BF614	BF984	BF1366-O
B173-S	B360	BF719	BF991	BF1371
B202	BT361	BF720	BF992	BF1376
BT216	BT364	BT732	BF1102	BF1378-SPS
BT217	BT365	BT735	BF1204	BF1384-SP
B229	BT365-10	BT739	BF1204-O	BF1385-SPS
BT230	BT366-10	BT778	BF1204-SP	BF1393-SP
B233	BT366-MPG	BT779	BF1205	BF1394-SP
B236	BT367	BF781	BF1205-SP	BF1398-O
BT237	BT367-S	BF789	BF1212	B1428
BT241	BT368	BF791	BF1213	B1429
B244	B369	BF791-O	BF1214	B1434
B246	BT371-10	BF792	BF1217	B1438
BT248	BT371-5	BF797	BF1220	B1441
BT251	BT371-MPG	BF798	BF1225	B1446
B252	BT372-10	BT839	BF1233	BW5070
B253	BT372-MPG	BT839-10	BF1248	BW5071



WARNING: These products can expose you to chemicals, including Diisononyl Phthalate, Carbon black extracts, Nickel, 1,3 Butadiene, Ethylene Oxide, Epichlorohydrin, which are known to the State of California to cause cancer, and Bisphenol-A, Ethylene Glycol, Ethylene Oxide, 1,3 Butadiene, Epichlorohydrin, which are known to the State of California to cause birth defects or other reproductive harm. For more information go to www.P65Warnings.ca.gov.

BALDWIN HEAVY-DUTY FILTERS

QUALITY. COVERAGE. SERVICE. AVAILABILITY.

FIND THE COVERAGE YOU'RE LOOKING FOR

FILTERS FOR ALL OF YOUR NEEDS

Baldwin's high quality filters are designed for on and off-road vehicles with diesel engines.

- service shops
- farmers
- trucking companies
- contractors
- municipalities
- fleets or anyone who operates diesel equipment

No matter what the industry or operating conditions, you can be confident that Baldwin's heavy-duty filters provide protection that matches or exceeds the original equipment.

HEAVY-DUTY FILTER HOTLINE

Toll Free:

1-800-822-5394

Cross-Reference Lookup and Other Filter Info:
baldwinfilters.com

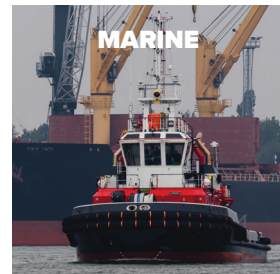
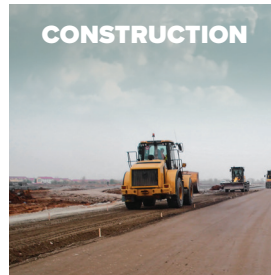

TS 16949
ISO 9001



QUALITY SYSTEM
CERTIFIED

baldwinfilters.com