

SYSTEM KITS

Standard Kit 1 Includes:

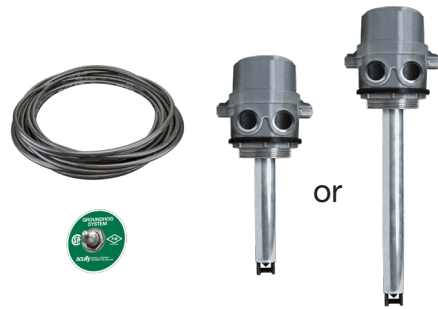

Conductor Cable, Ground Bolt,
7" Standard or 12" Extended Sensor

Standard Kit 2 Includes:

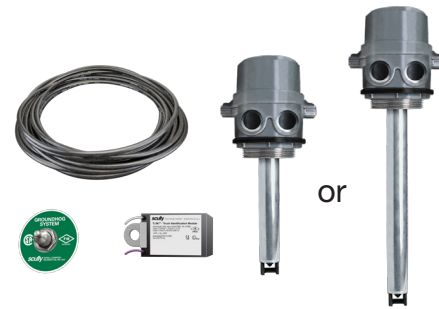

Conductor Cable, Ground Bolt, T.I.M.
7" Standard or 12" Extended Sensor

2 WIRE SYSTEM KITS-OVERFILL ONLY

Number of Compartments	Cable Type/ Cable Length	7" Standard Sensor Part Number	7" Standard Sensor with T.I.M. Part Number	12" Extended Sensor Part Number	12" Extended Sensor with T.I.M. Part Number
1	7 Conductor/100 ft.	09640	09640T	09656	09656T
2	7 Conductor/100 ft.	09641	09641T	09657	09657T
3	7 Conductor/100 ft.	09642	09642T	09658	09658T
4	7 Conductor/100 ft.	09643	09643T	09659	09659T
5	7 Conductor/100 ft.	09644	09644T	09660	09660T
6	7 Conductor/100 ft.	09645	09645T	09661	09661T
7	11 Conductor/100 ft.	09646	09646T	09662	09662T
8	11 Conductor/100 ft.	09647	09647T	09663	09663T

2 WIRE SYSTEM KITS-OVERFILL & RETAINED

Number of Compartments	Cable Type/ Cable Length	7" Standard Sensor Part Number	7" Standard Sensor with T.I.M. Part Number	12" Extended Sensor Part Number	12" Extended Sensor with T.I.M. Part Number
1	7 Conductor/200 ft.	09648	09648T	09664	09664T
2	7 Conductor/200 ft.	09649	09649T	09665	09665T
3	7 Conductor/200 ft.	09650	09650T	09666	09666T
4	7 Conductor/200 ft.	09651	09651T	09667	09667T
5	7 Conductor/200 ft.	09652	09652T	09668	09668T
6	7 Conductor/200 ft.	09653	09653T	09669	09669T
7	11 Conductor/200 ft.	09654	09654T	09670	09670T
8	11 Conductor/200 ft.	09655	09655T	09671	09671T

Copyright © 2016 Scully Signal Company. Dynacheck, Dynamic Self-Checking, Dynamic Self-Testing, Faysafe, IntelliCheck, Intellitrol are registered trademarks of Scully Signal Company. All Rights Reserved. Specifications are subject to change without notice.

XXXXX Rev A
June 2016

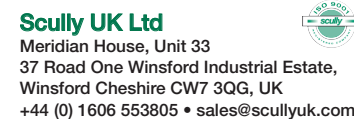

Dynamic Self-Testing® Overfill Prevention Systems



Scully Intellicheck®3

Complete Overfill Prevention & Retained Product Monitoring System

Featuring Dynacheck® – Automatic and Continuous Self-Checking Circuitry

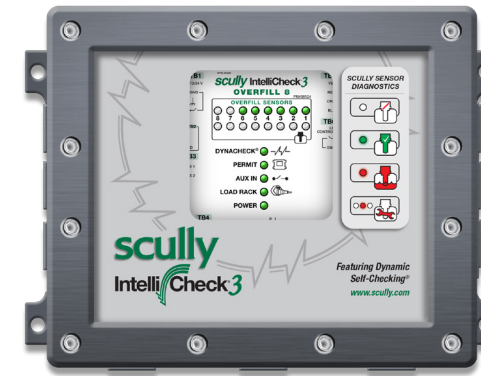

IntelliCheck®3

DESCRIPTION

IntelliCheck®3 is the safest and most advanced tank trailer overfill prevention and retained product monitoring system. It saves time and money by reducing down-time and ensuring safe, dependable loading operations.

FEATURES & BENEFITS

Overfill Prevention

- Advanced, easy-to-understand diagnostics with Bi-color LEDs
- High-level detection in each vehicle compartment, using either Scully 2 Wire or 5 Wire sensors
- Simplified programming
- System shutdown within one-half second of high-level or fault condition detection.
- Individual sensor indicators for static conditions such as "wet" sensor or operational faults
- New 5 Wire Series Wired Sensor compatibility adds diagnostic capability to 5 wire vehicles.
- Detects opens, shorts and helps pinpoint specific sensor to save time in troubleshooting
- Prevents bypassing sensors for maximum safety
- RoHS compliant design to protect the environment
- Corrosion resistant housing
- Impact and UV resistant window for improved performance
- Dual Level model available to detect and control 2 sensors per compartment

Dynacheck® Safety

- Complete automatic and continuous checking of all system components for static operation
- Complete system diagnostics
- Visual indication of Dynacheck® self-checking, sensor status and fault conditions
- Indicator for auxiliary switch operation, such as vapor interlock
- Loading rack connection indicators

Retained Product Monitoring

- Retained product detection using two-wire optic sensors
- Loading "lock-out" feature if vehicle returns with product
- Driver must press retained product acknowledge button for loading to occur
- Helps prevent product mixing
- Warns against overfilling of vehicle compartments

Advanced Optic Sensing

- Scully optic sensors are used as the "eyes" of the IntelliCheck®3 to determine loading status
- Each sensor is independently monitored and tested up to 30 times per second
- Withstands extreme road and temperature conditions.
- IntelliCheck® Kits include Scully sensors- the most reliable sensors in the market with nearly double the warranty of any other sensor.



Scully Signal Company 70 Industrial Way, Wilmington, MA 01887, USA • 800-272-8559 • sales@scully.com • www.scully.com

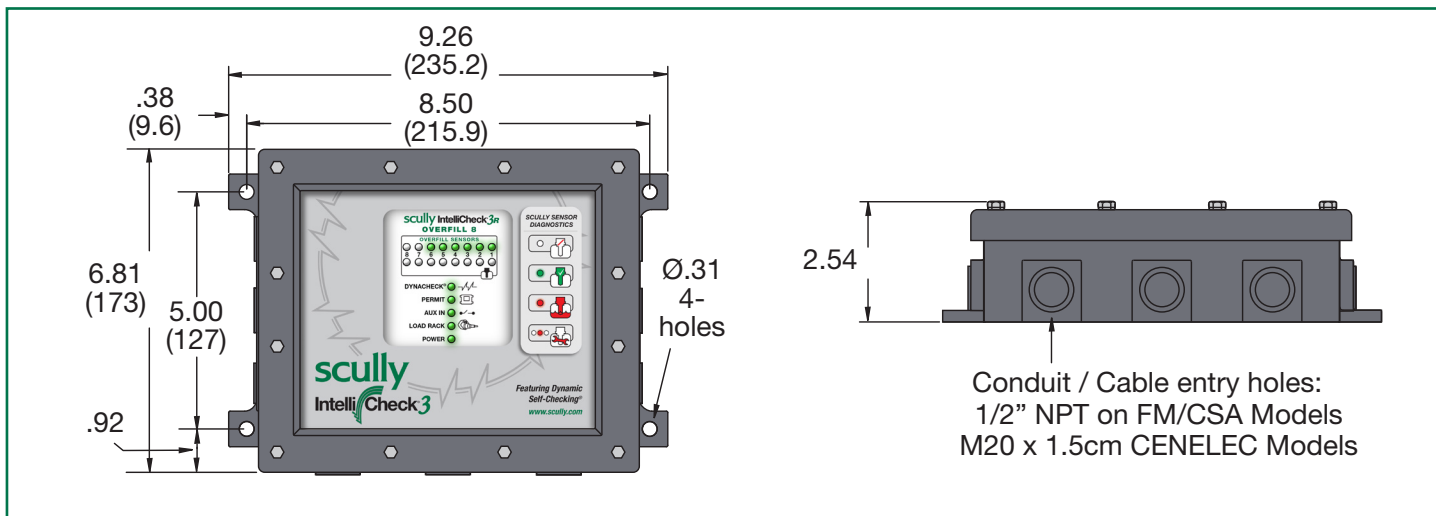

TECHNICAL SPECIFICATIONS

Temperature Range

Operating:
-40 to +60 Degrees C (-40 to +140 Degrees F)
Storage:
-45 to +85 Degrees C (-50 to +185 Degrees F)

Power Requirement

Nominal Voltage: 12 to 24 VDC (-0.5, +8 VDC)
Consumption: 9.6 Watts maximum at 24 VDC
4.8 Watts maximum at 12 VDC

Outside Dimensions

9.26" wide X 6.81" high X 2.54" deep

Weight

2.7 kg (6.lb)

Interface Inputs:

- TB4 & TB5 Sensor Inputs: EN 13922 compliant
- TB3 Auxiliary: I.S. input switch closure less than 100 ohms

Interface Outputs:

- TB7: 2.0A at 32 VDC maximum Non-intrinsically safe relay
- TB6 Rack interface: EN 13922 compliant I.S. interface for 2/5- wire sensors
- TB6: Intrinsically safe relay output. 200mA at 32 VDC maximum or 1.6A at 16 VDC maximum

APPROVALS

IntelliCheck[®]3 has safety approvals as an intrinsically safe monitoring device for use in:

- Canada and the United States:
Class I, Division 2, Group CD, T6, Type 4 or
Class I, Zone 2, IIB T6, IP 65
With intrinsically safe outputs for
Class I, Division 1, Group CD
Class 1, Zone 0, IIB Locations
- Ambient temperature for all ratings
($T_a \leq -40^\circ\text{C}$ to $+60^\circ\text{C}$)



COMPLETE ASSEMBLY

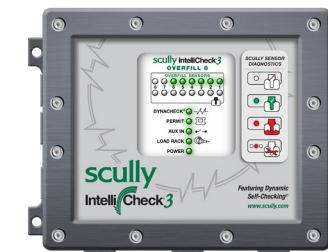

Overfill Monitor

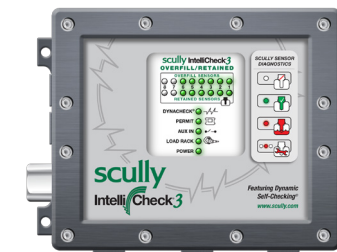

Overfill & Retained Monitor

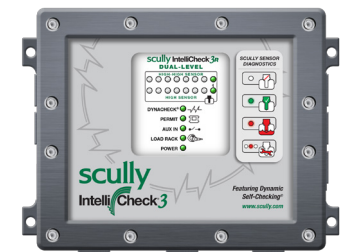

Dual Level Monitor

ORDERING INFORMATION

Description	Part Number
IntelliCheck [®] 3 Overfill Control Monitor	09562
IntelliCheck [®] 3 Overfill and Retained Monitor	09566
IntelliCheck [®] 3 Dual Level Monitor	09578

UPGRADE KIT (Includes include the IntelliCheck[®]3 module, window kit, compliance label & quick start guide)

ORDERING INFORMATION

Description	Part Number
IntelliCheck [®] 3-R Upgrade Kit, Overfill 8	09584
IntelliCheck [®] 3-R Upgrade Kit, Overfill and Retained	09585
IntelliCheck [®] 3-R Upgrade Kit, Dual Level	09586

REPLACEMENT PARTS

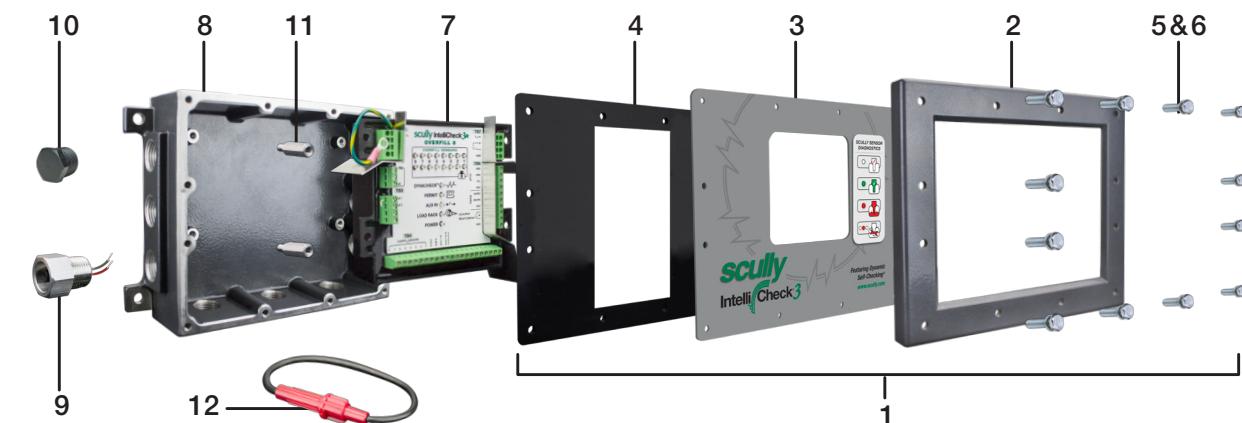

ORDERING INFORMATION

Description	Part Number
1. Cover Assembly (Cover, Window, Gasket, Screw, Lockwasher)	09575
2. Cover	32600
3. Window	38041
4. Gasket, Cover	92000
5. Screw, Hex Head, 10-24 x 3/4", Stainless Steel	50151
6. Lockwasher, Split, #10, Stainless Steel	51122
7. Replacement Module, Overfill	09563
Replacement Module, Overfill & Retained	09567
Replacement Module, Dual Level	09579
8. Base, 1/2" NPT Conduit Entries	32599
9. Switch Assembly, Reset	31820
10. Pipe Plug, 1/2" NPT	50796
11. Standoff, Male-Female, 5/16" Hex, 10-32 x 7/8" Lg., Aluminum	31842
12. Fuse and Holder, In-Line, 1/2 AMP	26425
Fuse Only	26427