

Smith Meter® Rotary Vane PD Meters

Smith Meter® 3-Bladed Double Case PD Meters

Service Manual

Bulletin MN01006 Issue/Rev 0.4 (12/18)

Models

JB10 - S1, S3, S5, S6, S7, and S8

K12 - S3, S5, S6, and S7

M16 - S3, S5, and S6



Important

All information and technical specifications in this documentation have been carefully checked and compiled by the author. However, we cannot completely exclude the possibility of errors and are always grateful to be informed of these errors.

Smith Meter® is a registered trademark of TechnipFMC.

Customer Support

Contact Information:

Customer Service

TechnipFMC

FMC Technologies, Inc.

1602 Wagner Avenue

Erie, Pennsylvania 16510 USA

P: +1 814 898-5000

F: +1 814 899-8927

measurement.solutions@technipfmc.com

www.technipfmc.com

Table of Contents

1 – Overview/Introduction.....	5
1.1. – Description.....	5
2 – Meter Disassembly	7
2.1. – General.....	7
2.2. – High Pressure Packing Gland Maintenance.....	7
2.3. – Suggested Tools and Fixtures	7
2.4. – Removing Inner Unit from Housing	8
2.5. – Removing Inner Unit Cover	9
2.6. – Rotor Assembly Removal	11
2.7. – Rotor Disassembly	13
2.8. – Disassembly of Cam Shaft.....	16
2.9. – Disassembly of Blade Rollers.....	17
2.10. – Disassembly of Rotor Gear Plate Assembly.....	18
2.11. – Removal of Rotor Bearings in Cover Assembly.....	19
3 – Reassembly and Clearance Checks	21
3.1. – Reassembly.....	21
3.2. – Clearance Guide.....	27
3.3. – Meter Clearance Record	28
4 – Related Publications	29

This page left intentionally blank.

1 – Overview

This manual provides detailed inspection and service information for the models of Smith Meter® Double Case, 3-bladed Rotary Meters listed. See related publication for Specifications, Part Lists, and Installation/Operation information pertaining to your specific model of meter.

Double case meter construction features ease of maintenance and service. For example, the measuring unit can be removed vertically from the outer housing with little spillage and without disturbing pipe connections. Also, within a given size, complete metering units and parts are interchangeable. As a result, the simple removal and disassembly steps encourage periodic preventive maintenance inspections.

It is suggested that a detailed record be maintained for each meter in the installation. Nameplate data (Figure 1), clearances, progressive totalizer readings, meter factor, parts used, and other similar information provide background material for scheduling a preventive maintenance program. An increase in meter factor drift against throughput can be used as the basis for making an inspection.

The time of the first inspection must be based on the operating conditions imposed by the installation. Flow rate, lubrication properties of the fluid, and the possibility of abrasive contaminants are points to consider. Then, at the time of inspection, the condition of the meter should indicate whether the inspection interval could be lengthened or shortened.

When ordering parts or inquiring about a unit, be sure to include complete model and serial number information from the plate, Figure 1.

Note: Meters constructed to special specifications (designated by a 6-digit serial number) may have clearances in variance to those shown in this manual. Consult your representative or the factory for the correct information pertaining to your meter.

MODEL		
SERIAL NO.		
ASSEM. NO.		
MAWP		
FLOW RANGE		
W&M		
METER CLEARANCES SIZED FOR:		
TEMP. MAX.		VISC. MAX.
PAT. NOS. 2,207, 182 & 2,263, 145		
FMC Measurement Solutions Inc.		
Erie, PA 16510		

Figure 1

1.1 Description

Smith Meter double case rotary meters are of the positive displacement type, Figure 2. The metering mechanism is an inner unit bolted into the outer housing. The double case design eliminates distortion of the measuring chamber due to pressure differential and piping strains. Pipe connections are confined to the outer housing, which means the meter can be removed by taking off the cover assembly and lifting it out. Inspection, maintenance, and service are greatly simplified through the double case design.

The measuring function is accomplished in a chamber of precise volume created by the moving blades, rotor, body, and cover. There is a smooth flow of product through the meter. The blades rotate around a fixed cam, which causes them to move out to, but not touch, the body of the meter. Six chambers per revolution are formed as the rotor and blades are turned by product flow.

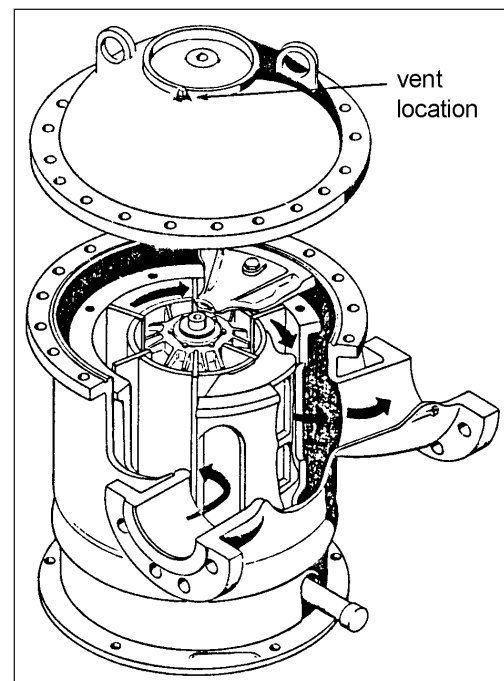

Figure 2 – High Capacity Double Case Meter

This page left intentionally blank.

2 – Meter Disassembly

2.1 General

To assure adequate inspection and maintenance, the step-by-step procedures in this manual should be carefully followed. To gain a better understanding of high capacity rotary meter design and construction, it is suggested that the serviceman review this manual before starting disassembly. Unless otherwise identified, all illustrations are of the M16 meter, as it typifies the entire group.

All parts, as they are removed, should be thoroughly washed and cleaned in solvent. Parts that are worn enough to affect operation or calibration should be replaced. All parts that are nicked, gouged, or have rough places on them, should be dressed with a fine file or crocus cloth, as conditions warrant.

2.2. High Pressure Packing Gland Maintenance

Glycerine solution is used as a sealant and lubricant in this type of packing gland. The gland should be serviced on an interval determined by experience, however, the period between injections should not exceed 60 days.

Ambient Temperature	Lubricant
-4°F to 300°F (-20°C to 150°C)	High Purity (99%) Glycerine Solution

Table 1

2.3. Suggested Tools and Fixtures

In addition to ordinary hand tools, the following tools and equipment will facilitate work on the meter:

- Suitable lifting equipment with a capacity of 2 tons.
- Crocus cloth.
- Feeler gauges¹, leaf type (as illustrated during disassembly) - (see Table 2).
- Eye bolts: one 1"-8, two 1/2"-13, two 3/8"-16.
- Micrometer¹, depth type - 1".
- Clamp (8" capacity).
- Rotor shaft nut with loop¹, and spiders¹.

Feeler Gauge Sizes

Parts No. ²	Thickness	Part No. ²	Thickness
515252-1	.0015"	515252-11	.011"
515252-2	.002"	515252-12	.012"
515252-3	.003"	515252-13	.013"
515252-4	.004"	515252-14	.014"
515252-5	.005"	515252-15	.015"
515252-6	.006"	515252-16	.016"
515252-7	.007"	515252-17	.017"
515252-8	.008"	515252-18	.018"
515252-9	.009"	515252-19	.019"
515252-10	.010"	515252-20	.020"

Table 2

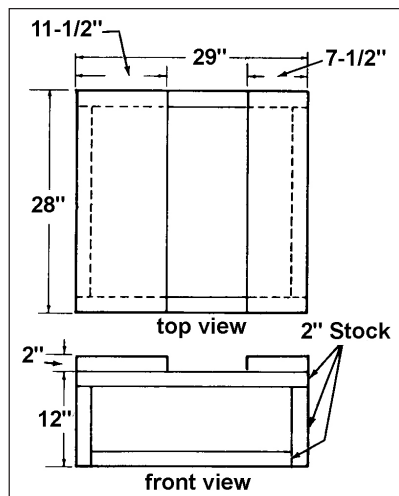

Figure 3A – Wood box for supporting inner unit

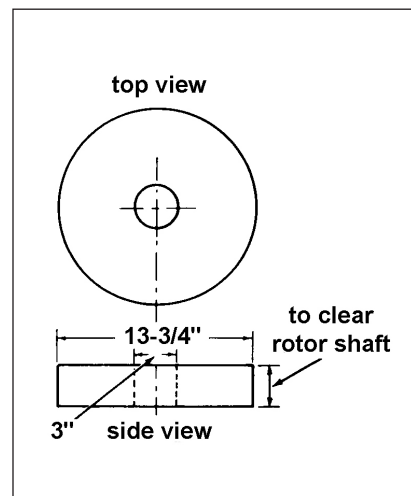

Figure 3B – Circular wood block for supporting rotor

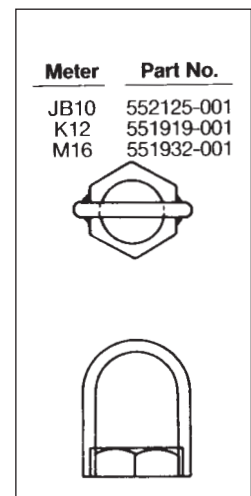

Figure 3C – Rotor shaft nut with loop

¹ Reference Form No. PO0A001.

² Consists of feeler gauge soldered to 15" rod. An extension rod (22") and coupling is available as Part No. 515250

2.4. Removing Inner Unit from Housing

1. With all accessory equipment and the adapter removed from the top cover of the housing, lift the packing gland assembly from its location, Figure 4A.
 - When removing an adapter carrying a temperature type calibrator, exercise care in handling of the capillary from the adapter to the bulb.
2. Using needle-nose pliers, remove the extension shaft from the hole exposed by the removal of the packing gland, Figure 4B.

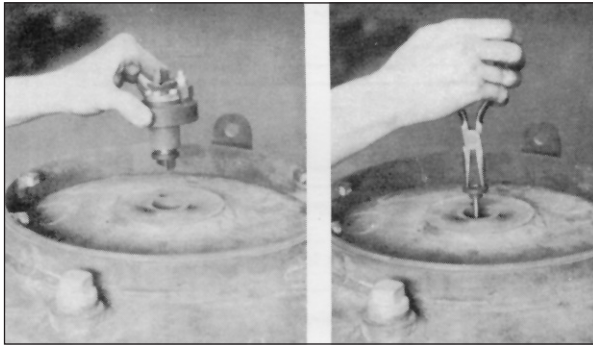

Figure 4A

Figure 4B

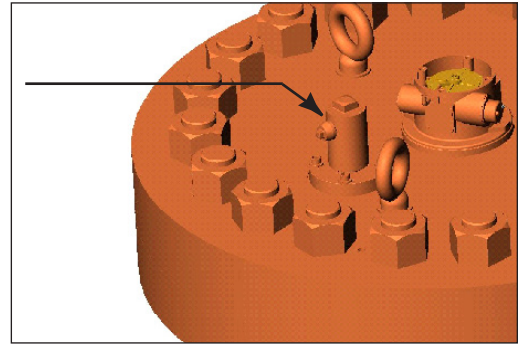

Figure 5

3. If equipped, remove the bolts retaining the Vent Kit Body (see arrow in Figure 5).
 - Remove and inspect the Vent Kit O-Ring, if necessary replace it.
4. Remove the studs securing the cover to the housing body.
5. Using a suitable lifting device, Figure 6, remove the cover from the housing.
 - Note locating pin in housing flange. This pin must line up with locating hole in flange of cover when cover is replaced.
 - Also note lifting eyes which are preassembled into the cover of the inner case. These are to remain in the cover and need not be removed.
 - Set housing cover on a clean surface and turn over so that flange may be inspected and cleaned.
6. Figure 7 shows the gear train as it appears on the inner unit cover of an M16 meter.
7. Before removing inner unit, wash top of unit with solvent, kerosene, or other liquid cleaner. Do not use water.

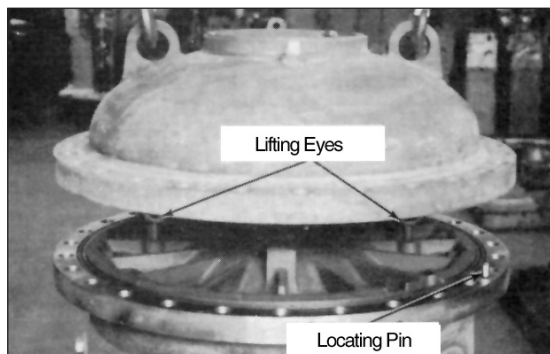

Figure 6

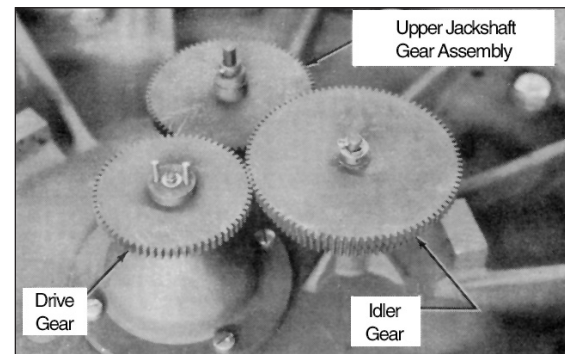

Figure 7

8. Remove the locking bolts from the outer housing. Lift inner unit from housing, Figure 8, and set on level floor.
 - The M16 has two (2) locking bolts located at the top and bottom of the outlet nozzle.
 - The K12 and JB10 have four (4) locking bolts located at the top and bottom of the inlet nozzle.
 - The M16 locking bolts are larger than the other bolts and are equipped with O-rings.
 - Use a suitable lifting device with a minimum capacity of 2 tons.
9. Clean outside of inner unit and wash all interior surfaces that can be reached from inlet and outlet ports, as instructed in Step 6. Rotor can be rotated by hand from either port to wash rotor surface.

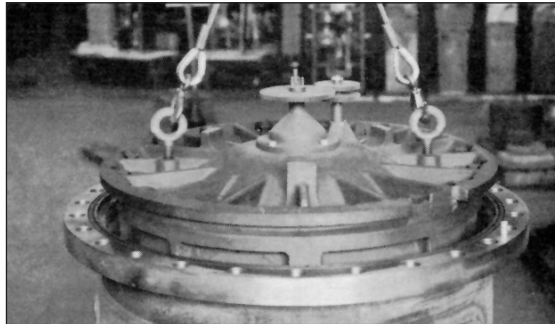

Figure 8

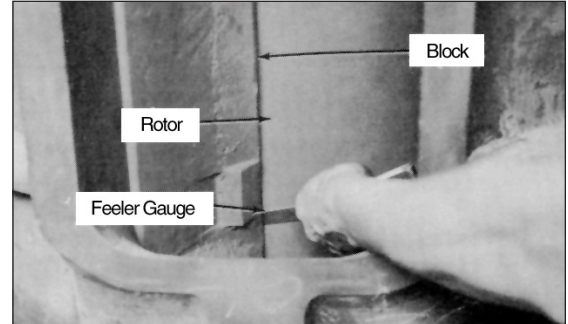

Figure 9

10. Rotor to block clearances should now be checked with feeler gauges at both inlet and outlet ports, Figure 9. Likewise, top and bottom rotor clearances can be determined. Rotor slot clearances on all six slots can be determined. The slots should be numbered with chalk or crayon so that they can be identified properly when the inner unit cover is removed. All clearances recorded at this point will be those clearances that are in the meter before disassembly and should be noted as "as found" clearances. A comparison of these "as found" clearances with the "as assembled" clearances from the last inspection will indicate the degree of wear for the number of barrels throughput (at these points) from the last inspection.
 - Compare the "as found" clearances with Clearance Guide on Page 27.

2.5. Removing Inner Unit Cover

1. If equipped, remove and inspect the vent tube, Figure 10A. Then check the elbow, vent tube, standoff, tee, and second vent tube for blockage or damage, Figure 10A.
2. Position the calibrator drive gear so that the cotter pin can be removed from the shaft.
 - This positioning can be accomplished by turning the rotor by hand from either the inlet or outlet port.
 - With cotter pin removed, lift off calibrator drive gear, Figure 10B.
3. Remove cotter pin and idler gear, Figure 11.
 - Remove thrust bearing assembly on shaft, under gear.

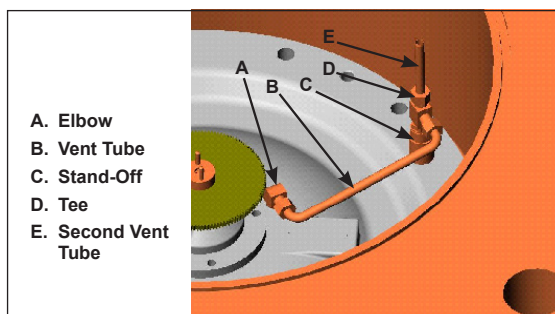

Figure 10A

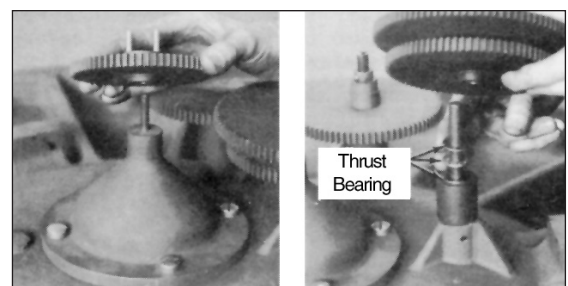

Figure 10B

Figure 11

4. Remove screws and lift adjusting screw cap from cover, Figure 12.
 - It may be necessary to loosen the cap with a “soft” hammer.

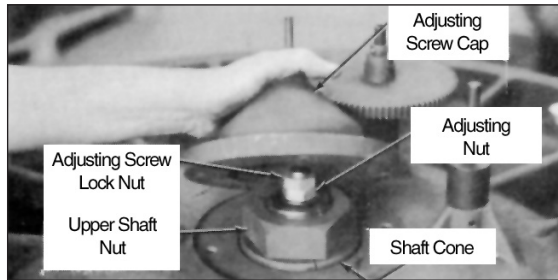

Figure 12

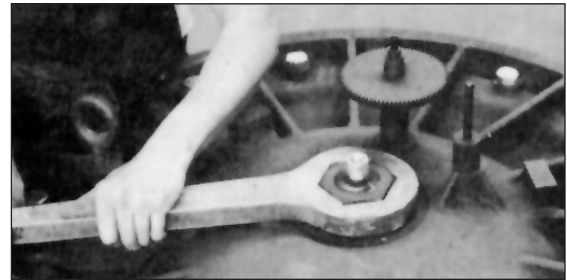

Figure 13

5. Loosen and remove upper shaft nut from shaft, Figure 13.
6. The shaft cone is removed by driving a screwdriver into the slot as shown in Figure 14.
 - This will expand the cone and permit lifting it off.

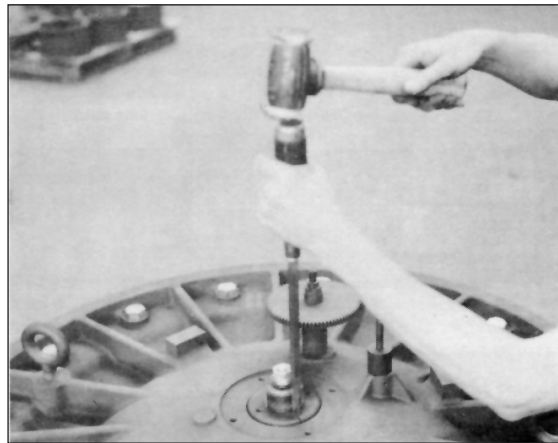

Figure 14

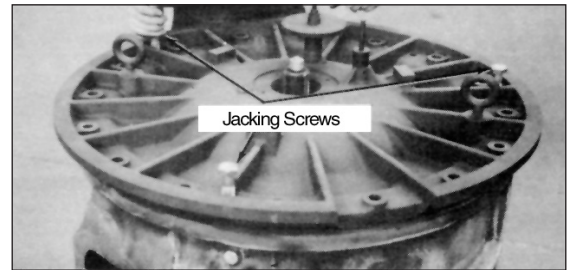

Figure 15

7. The top cover of the inner unit can now be removed.
 - After removal of cover cap screws, it may be necessary to loosen the cover before it can be lifted off.
 - Insert three cap screws into the tapped holes provided in the cover, Figure 15, and jack the cover from the inner case.
 - Remove cover as shown in Figure 16 and place on two 2" x 4" wood blocks on the floor. This will protect the jackshaft gear from being damaged.

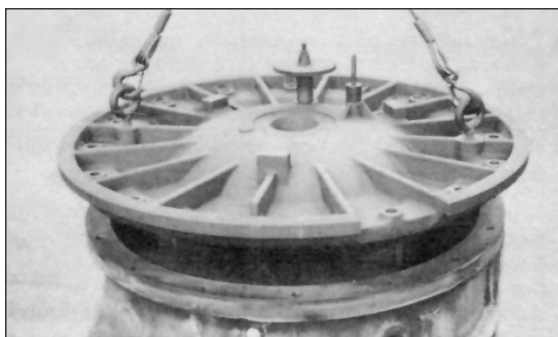

Figure 16

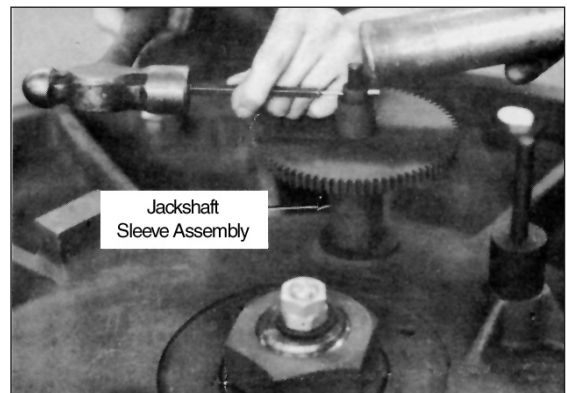

Figure 17

8. Remove jackshaft gear assembly. Use “back up” when removing pin to prevent damage to shaft, Figure 17.
 - Use “back up” when reassembling also.
 - Inspect fit of jackshaft in bushings of jackshaft sleeve assembly for excessive wear.
 - To remove jackshaft sleeve assembly, press out from bottom of cover.

2.6. Rotor Assembly Removal

1. Using two wrenches, loosen the adjusting screw lock nut (upper nut) from the adjusting nut (lower nut), Figure 18. Then, turning adjusting nut counter-clockwise, lower the complete rotor assembly until it rests on the base of the inner unit.
 - Bottoming the rotor will square off the rotor with the case and will eliminate any side play that may be present due to the top of the rotor shaft being unsupported.

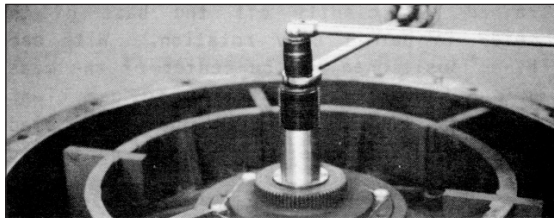

Figure 18

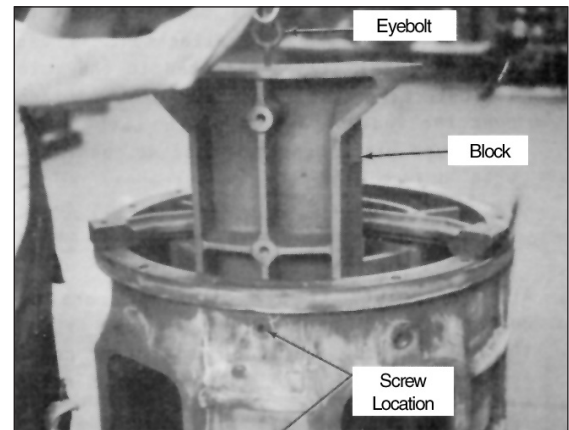

Figure 19

2. Normally it is not necessary to remove the block from the meter case. However, if it is desired, the block can be taken out by removing the screws from the side of the housing and lifting out the block with an eye bolt and a lifting device, Figure 19.
 - Spiders (concentricity fixtures) can be used to maintain rotor concentric with inner housing, Figure 20.
 - If a spider is not used, do not remove block until blade tip to housing clearances has been checked.
3. Transfer the chalk or crayon numbers that were placed by the slots before removal of the cover to the same slots at the top of the rotor. This will identify the slot clearance and the blade tip to meter case with the same number. These clearances will be “as found” clearances and should be so noted.

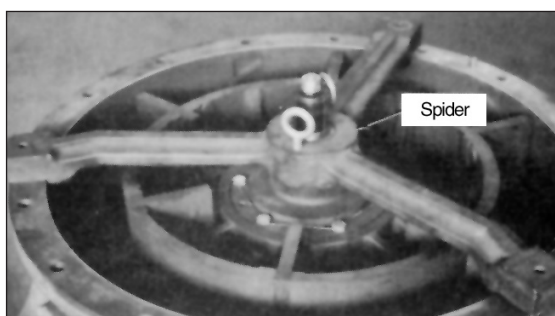

Figure 20

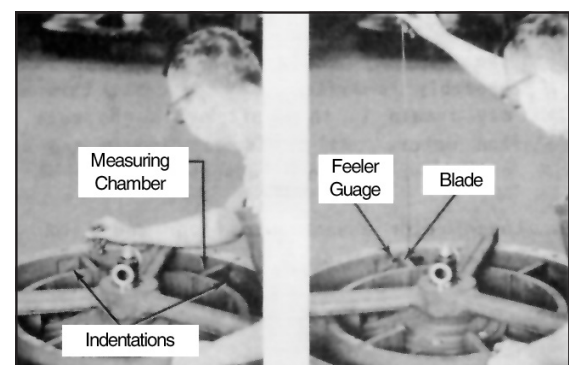

Figure 21

Figure 22

4. With the rotor bottomed, forcibly turn rotor until a blade is in the measuring chamber between the indentations in the meter case, Figure 21.
 - If spider is used, do not bottom rotor.
 - With the blade in this position, check blade tip to meter case clearance from top to bottom, Figure 22. Compare with Clearance Guide on Page 27.
5. Repeat clearance check on all blades and record all clearances.
6. If the rotor was bottomed, it should now be raised sufficiently off the base of the meter to permit easy rotation. With each blade positioned in the center of the measuring chamber, blade roller to cam clearances can be determined by moving the blade back and forth over the radius portion of the cam.
 - This determination can be made visually. However, if it is felt that a more accurate determination should be made, a dial indicator (with magnetic attachment is best for this use) may be attached to the rotor to determine the movement of the blades over the radius portion of the cam. Play in rotor and blade bearings must be considered when determining the measurement. These clearances should be noted as "as found" clearances.
7. At this point, if all clearances are acceptable, and partial inspection is all that is planned, the inner unit cover can be replaced after again bottoming the rotor.
 - After installing the cover cap screws, shaft cone, and upper shaft nut, the rotor should be repositioned in the case using the adjusting nut. Refer to reassembly section for these instructions.
8. Position the inner unit on a suitable support, Figure 23, and remove screw, lock washer, and shaft cover base.
 - Refer to Page 7 for information on construction of a wooden box support.



Figure 23

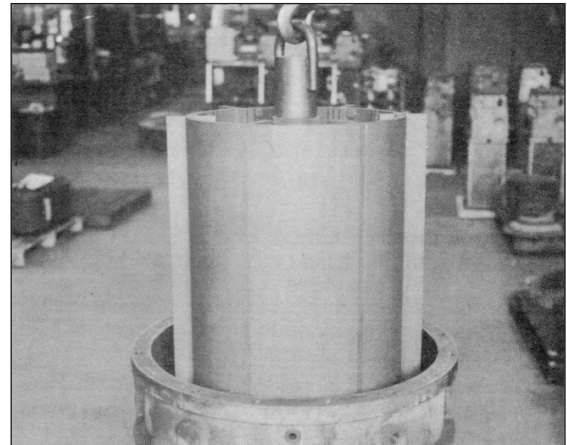

Figure 24

9. Using the lifting plate or shaft nut with loop as described on Page 7, lift the rotor assembly from the inner unit case, Figure 24.
 - The bottom of the rotor shaft is keyed to the base of the meter. When the rotor assembly is lifted from the case, this key may remain in the shaft or in the base of the meter. It should be removed and set aside for use in reassembly.
10. Lower rotor assembly to floor and allow it to lay on its side.
 - Do not lay rotor on bare floor as the blades could be damaged. Heavy cardboard or wooden planking will make a suitable cushion.

11. Insert an eyebolt into tapped hole in bottom end of rotor shaft (shaft nut with loop for the JB10). Raise rotor assembly and set on a suitable wooden block or metal plate, Figure 25 (see Page 7).

- The wooden block or metal plate must have a hole in the center to receive the shaft. It must also be high enough to allow shaft to clear the floor.

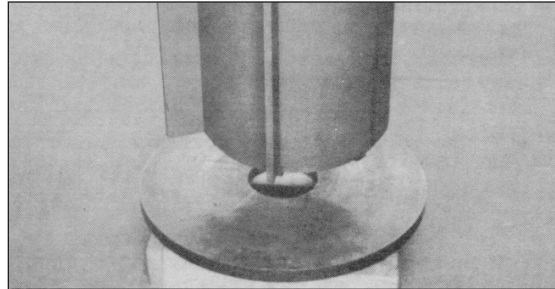

Figure 25

2.7. Rotor Disassembly

1. Figure 26 is a view of the bottom of the rotor assembly.
2. Remove rotor cover rollers, Figure 27.
 - Cut wires, remove cap screws, and lift off clamps. There are two clamps for each rotor cover roller.
 - Lift out rollers and pins, check for wear and smoothness of operation.

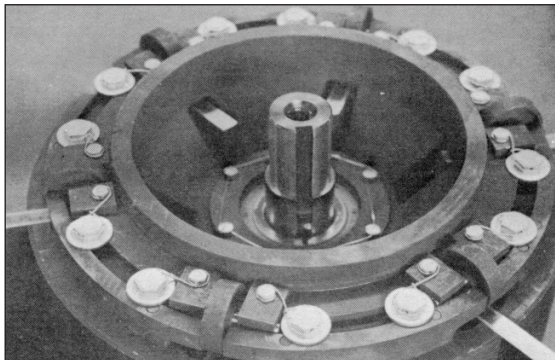

Figure 26

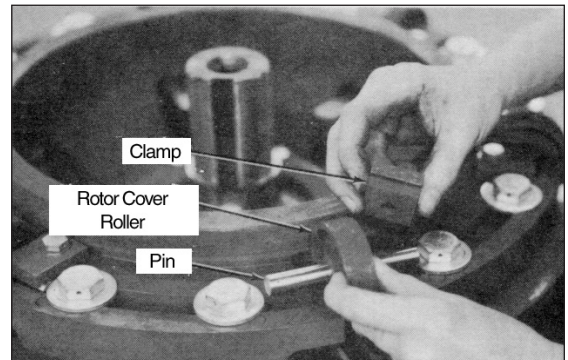

Figure 27

3. Lift off rotor cover.
 - To separate the cover and rotor, pry up at the openings provided, Figure 28. This will prevent damaging the edge of the rotor. There are three tapped holes in the JB10 that can be used for jack screws.
 - Using a suitable lifting device, lift off the cover, Figure 29. Note position of location pin and hole to assure proper positioning during assembly.

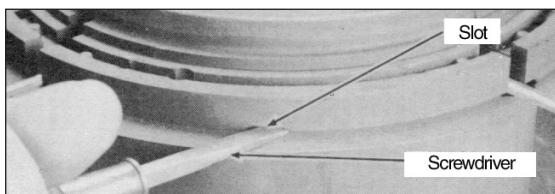

Figure 28

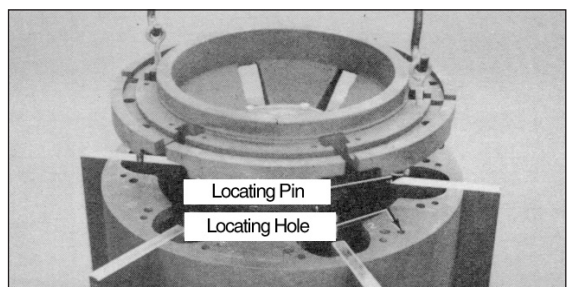

Figure 29

4. The blades are matched to their own rotor slots. Therefore, before removing the blades from the rotor, the blades and rotor slots must be match-marked.
 - Figure 30 shows one method of marking rotor and blade. Using a 3-corner file, notch first blade (on the back end) and area on rotor next to blade, with one notch, Figure 31. Repeat at second blade and rotor with two notches and three notches at the third blade.
 - It is unnecessary to mark all six blades and slots for obvious reasons.

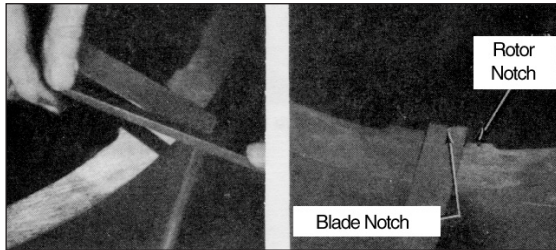

Figure 30

Figure 31

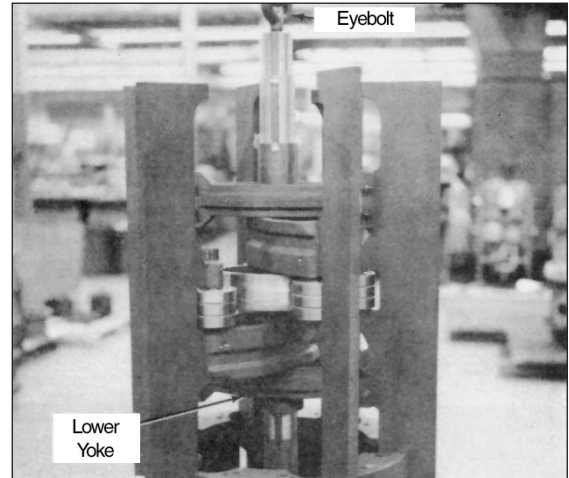

Figure 32

5. Insert an eyebolt into the rotor shaft (nut with loop for the JB10) and raise shaft and blade assembly to approximate height as shown in Figure 32.
 - Do not lift assembly completely out of rotor, as assembly will be lowered back into the unit after the removal of the adjusting collar and lower yoke.
6. Apply a clamp to the assembly as shown in Figure 33.
 - This will keep the blade whose yoke is under the cam from dropping down when the adjusting collar is removed.
7. Remove the lower yoke from blade assembly, Figure 32.
 - This will be the lower yoke on the blade that has an upper and lower yoke. The other blade assemblies have only one yoke.
 - The yoke is attached to the blade by bolts and dowels. Drive out dowels with a drift pin punch from the side opposite the stamped numbers.
 - The blades and yokes are matched during initial assembly and must not be interchanged, as misalignment of blades can occur.
 - The number stamped on the yoke corresponds to a like number on the blade, Figure 34. When reassembling, be sure to match blade and yoke.

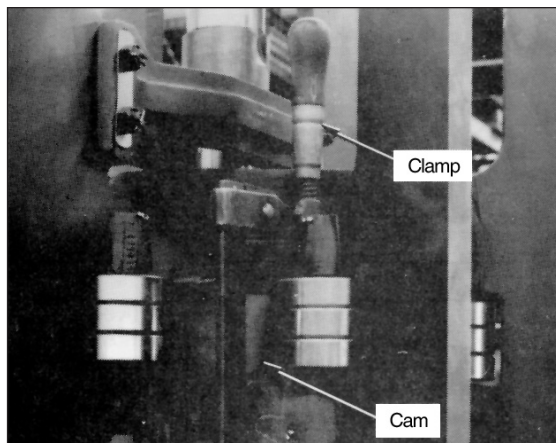

Figure 33

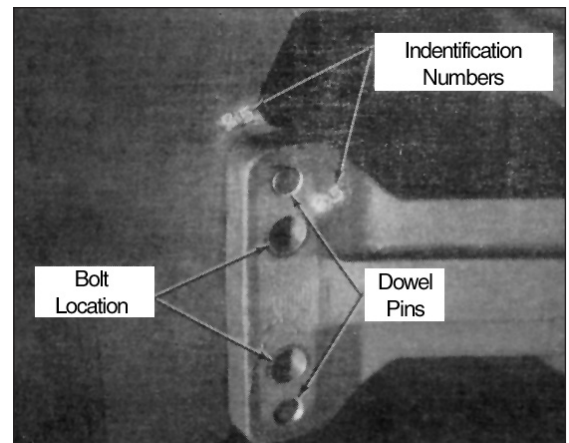

Figure 34

8. Remove adjusting collar, Figure 35.
 - When removing last screw from collar, support the collar so that it will not drop.
9. With adjusting collar completely removed, lower the assembly back into the rotor and remove clamp.

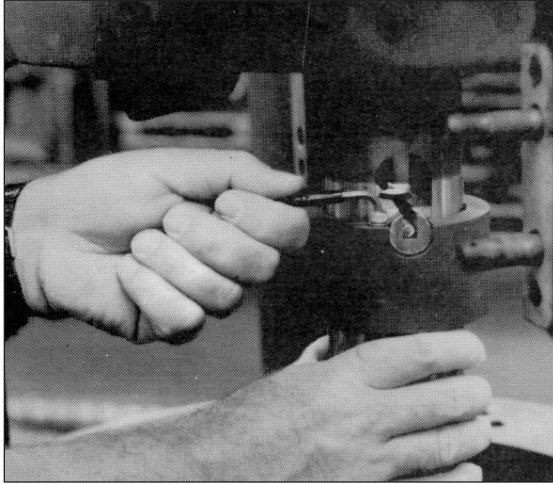

Figure 35

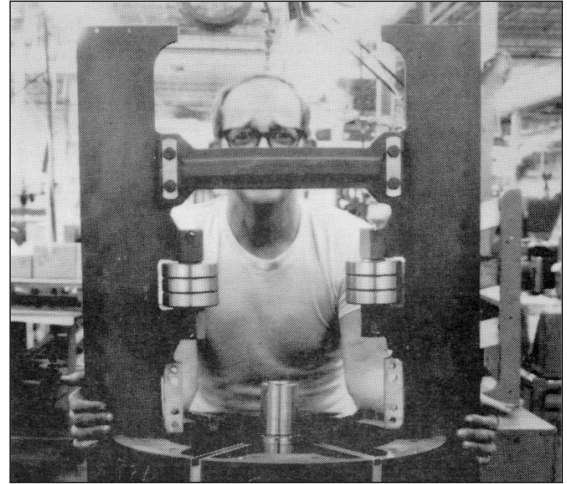

Figure 36

10. The blades and shaft can now be removed in sequence as shown in Figures 36, 37, 38, and 39.
 - When reinstalling blades into the rotor, be sure to install each blade assembly into its own proper slot.
 - Replace blade assemblies and shaft assembly in reverse sequence of removal.



Figure 37

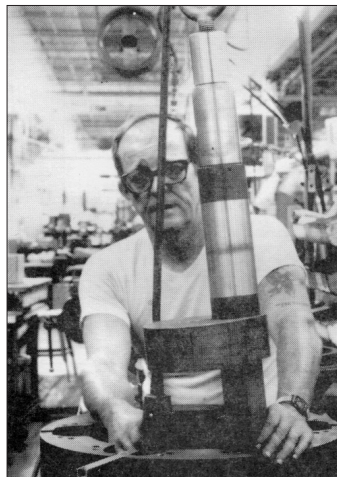

Figure 38

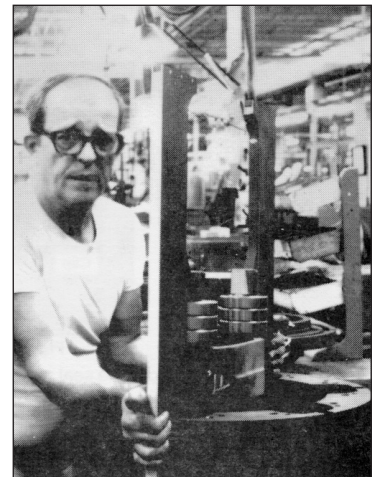

Figure 39

2.8. Disassembly of Cam Shaft

1. The lock roll pin is removed from the adjusting bar by driving it out of the adjusting block with a drift pin punch, Figure 40.
2. The adjusting screw is removed from the shaft.
 - Using the nuts as the head of the adjusting screw, Figure 41, remove the screw from the adjusting block.
 - The block is now loose and will slide out of the slot.
3. Figure 42 shows the components that make up the adjusting assembly.
4. Reassembly is performed in reverse of the disassembly procedure.
 - After reassembly, adjust the block so that its edge is even with the machined surface edge of the cam shaft, Figure 43. The adjusting and locking nuts should be at the end of the adjusting screw.
 - This will assist in aligning the cam with the blade rollers when the inner mechanism is reassembled.

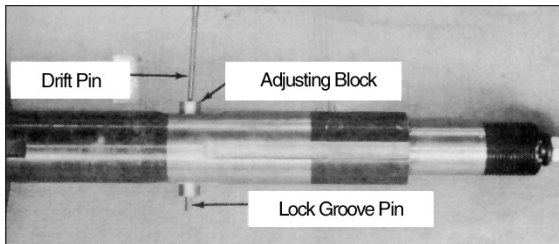

Figure 40

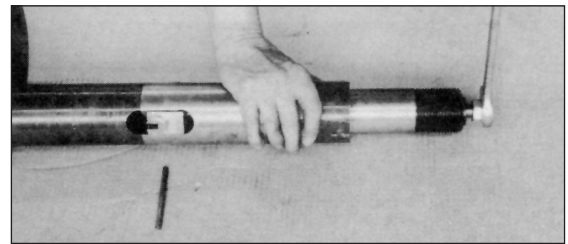

Figure 41

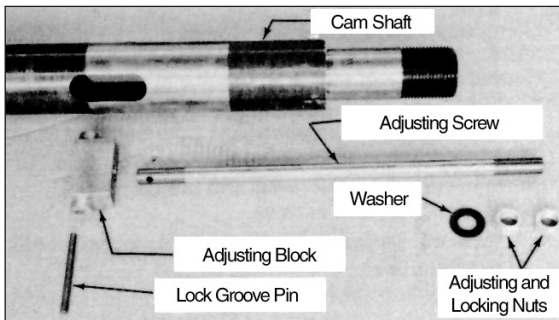

Figure 42

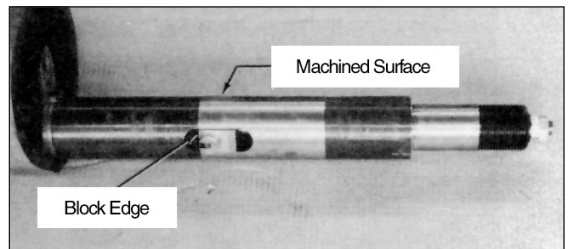

Figure 43

2.9. Disassembly of Blade Rollers

1. With cotter pin removed from blade, Figure 44, insert an Allen wrench and unscrew the socket head screw.

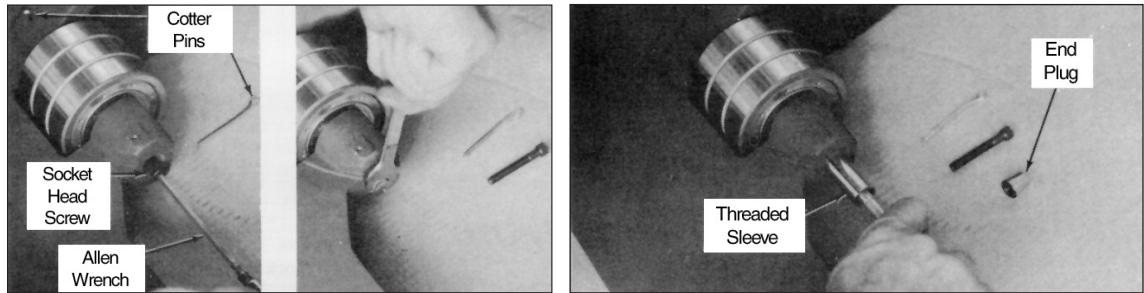

Figure 44

Figure 45

Figure 46

2. Using a machine screw of appropriate size and length and a washer, jack end plug from assembly, Figure 45.
3. Using a smaller machine screw of appropriate size and length, remove threaded sleeve, Figure 46.
4. Repeat same procedure on other end of blade roller assembly.
 - The blade roller assembly can now be lifted from the blade assembly.
5. Reassemble in reverse order and bring into position with the socket head screws.
 - Figure 47 shows a cutaway view of the M16 assembly.
 - Replace bearings if worn or damaged.

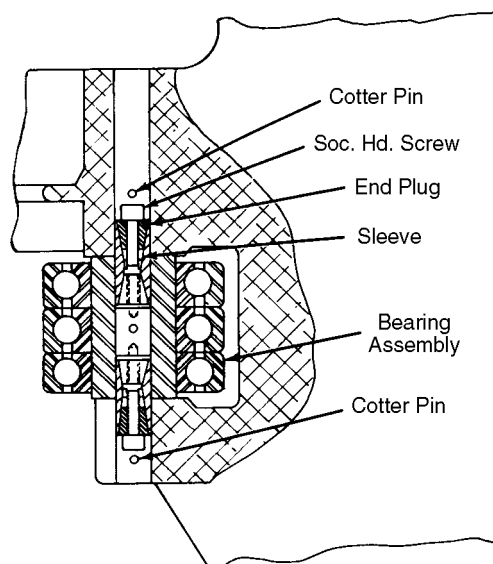

Figure 47

2.10. Disassembly of Rotor Gear Plate Assembly

Should inspection or repairs of the rotor gear plate assembly be required, the assembly can be removed without disassembling the rotor from the housing.

1. With the rotor upright, cut the seal wire and remove wire and screws from the assembly, Figure 48.
2. Remove the gear plate assembly.
 - Attach two 1/2"-13 eyebolts to the gear plate assembly and lift from the rotor, Figure 49.

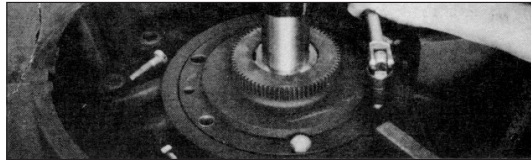

Figure 48

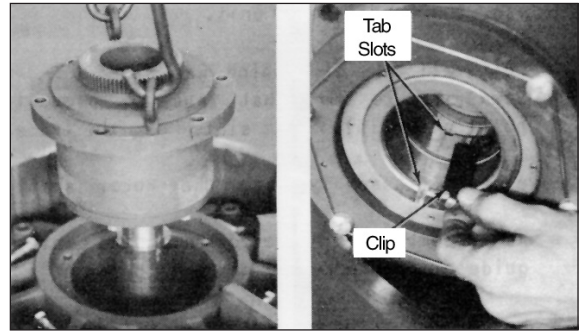

Figure 49

Figure 50

- The clip, Figure 50, may stay in the shaft or come out with the assembly. Remove and set aside for reassembly.
 - Note slots in inner race for positioning of clip.
3. Figure 51 shows the complete disassembly of the gear plate assembly. The items are arranged in a counter-clockwise direction and numbered in order of reassembly
 - Replace bearings if worn or damaged.

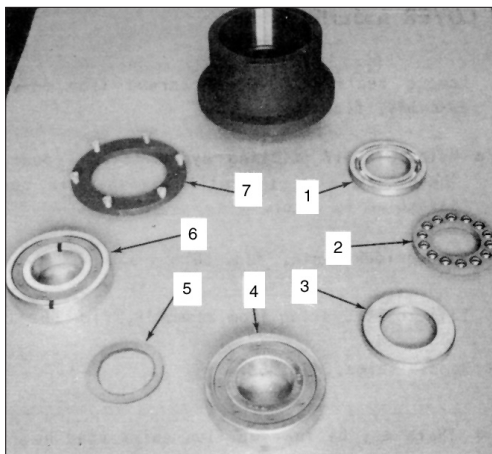

Figure 51

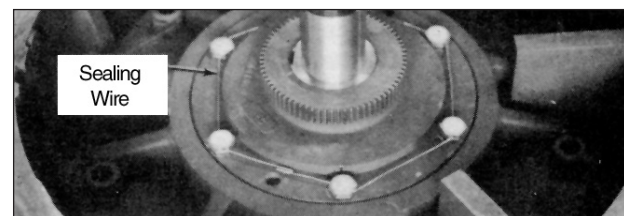

Figure 52

4. Reassemble in reverse of disassembly
 - When reassembling, replace all items as shown in Figure 51.
 - For example: Install Item 1 with groove facing up. Insert Item 2. Install Item 3 with groove down, etc.
 - When replacing cover ring, Item 7, make certain that no part of ring protrudes beyond the outer circumference of the gear plate assembly, as this will prevent reassembly of the unit to the rotor. When assembling screws, in cover ring, line up safety wire holes so that they are tangent to the bolt circle. It may be necessary to interchange screws from one hole to another to accomplish this.

- Reinstall the bearing clip which was set aside (Figure 50), using a sufficient amount of heavy grease to hold it in position in the slots of the inner races.
5. Reinstall assembly onto the rotor shaft.
 - As assembly is lowered onto the shaft, guide clip into keyway on shaft.
 - Secure to rotor with screws and lock all screws in place with sealing wire as shown in Figure 52.

2.11. Removal of Rotor Bearings in Cover Assembly

1. Remove sealing wire and screws from cover assembly, Figure 53.
 - Note 3/8"-16 lifting eyebolts in cover. These may stay in until assembly is reassembled to rotor.
 - Remove bearing clip.
2. Remove lock plate, Figure 54.
3. Lift rotor bearing from assembly, Figure 55.
4. Remove shims, Figure 56.
 - There may be four or five shims used here.

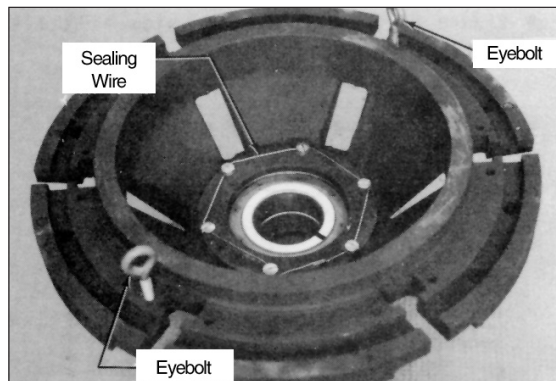

Figure 53

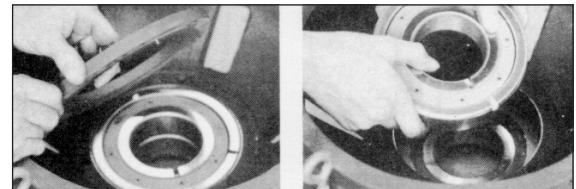

Figure 54

Figure 55

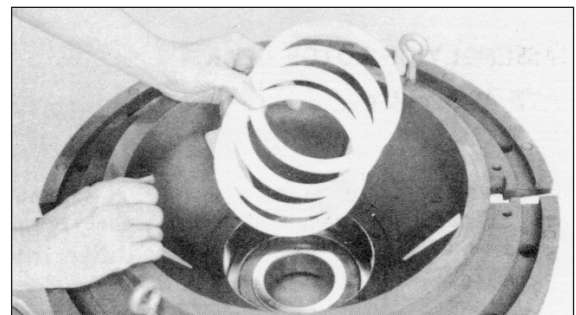

Figure 56

5. Remove remaining rotor bearing, Figure 57.
 - If the rotor bearings will not lift out by hand, they should be driven out with a brass rod and hammer.
 - The brass rod should only contact the outer race of the bearings.
6. Reassemble in reverse of the disassembly steps, using a sufficient amount of heavy grease to hold bearing clip in position in the slots of the inner races.
 - Reinstall sealing wire.



Figure 57

This page left intentionally blank.

3 – Reassembly and Clearance Checks

3.1. Reassembly

Reassembly is essentially the reverse of the disassembly procedure. Be sure to observe the reassembly precautions noted during tear down of the unit.

1. Should it become necessary to install a new rotor assembly into a meter, check rotor to block clearances, refer to Clearance Guide Table, Page 27.
 - If clearances are too small, block should be removed and the necessary clearances provided by filing metal from the front faces of the block.
 - If clearances are too great, the block should be shimmed to provide the proper clearances.
 - Dress all rotor slot edges lightly with a mill file to remove any burrs, etc.
2. New blades installed into a rotor must be fitted to the meter case.
 - After installation of blades into the rotor, install the complete assembly into the inner housing:
 - a. Position any two adjacent blades to their furthest extended position.
 - b. Raise the assembly to a position over the inner unit.
 - c. Line up rotor so that the extended blades are just inside of the indentations in the case (opposite the block) at either end of the measuring chamber, Figure 58.
 - d. Slowly, lower rotor assembly into position in the inner housing.
 - e. By means of the adjusting screw, lower rotor until it bottoms. If spider is used, there should be some clearance between rotor and base.
 - With the rotor in this position, determine blade end clearances for full length of blade as described on Page 7. Check Clearance Guide Table on Page 27 for proper clearances.
 - In most instances with new blades, these clearances will be found to be too close. When this is the case, the complete rotor assembly must be removed and the blade end dressed.
 - Support the rotor assembly vertically on wood locks of sufficient height so that the blade ends can be dressed down the full length, Figure 59.
 - a. Using a Vixen (Babbit Metal) file, dress each blade to size.

Caution: Care should be taken not to remove too much metal from the blade. Also, blades should have sharp, clean-cut edges.

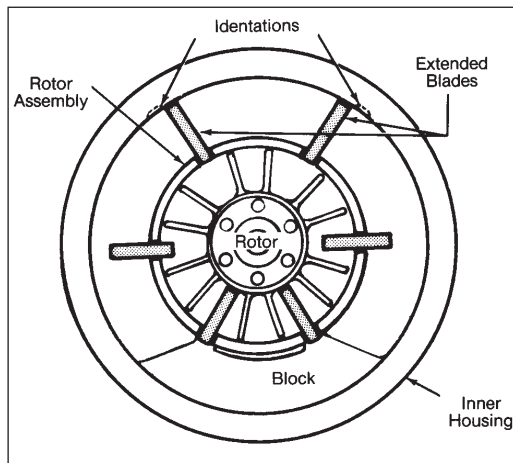

Figure 58



Figure 59

- After all the blade ends have been dressed down, reinstall rotor assembly back into the inner housing. Recheck clearances.
 - If not enough metal is removed the first time, the process must be repeated until the desired clearances are obtained.
 - Record these measurements as “as assembled” clearances.
 - After the properly fitted rotor assembly has been lowered into the inner housing, it may be necessary to turn the entire rotor assembly, shaft and all, clockwise or counter-clockwise a slight amount to line up keyway slots in lower end of shaft and the bottom of the housing. This can be accomplished by using a short length of 1" x 4" board, inserted in the blade slot between the rear of an extended blade and the rotor housing. This prevents the rotor and blades from turning on the cam and forces the shaft to turn in the housing.
3. Care must be taken when installing the inner unit cover to assure that the rotor gear and the lower jackshaft gear are properly meshed.
 - The fit of the inner unit cover is normally close enough to necessitate tapping the cover with a soft hammer to drive it into place on the inner unit. At the same time, rotate the rotor by hand from one of the ports. The upper jackshaft gear will begin to turn when the teeth are engaged.
 - The cover may now be fitted down snugly and cap screws installed.
 4. If equipped, reinstall the Vent Kit to the inner body cover as shown in Figure 10A.
 5. Total end clearances (see Clearance Guide Table) is divided, top and bottom, by setting the rotor adjusting screw.
 - Loosen the adjusting screw lock nut and while turning the rotor, Figure 60, slowly raise the rotor assembly until it just begins to bind against the top cover.
 - With the rotor in this position, check the bottom rotor clearances at both the inlet and outlet ports, compare with Clearance Guide.
 - By means of the adjusting screw, lower the rotor until 1/3 of this clearance is at the top and 2/3 is at the bottom.
 - Add .002" - .004" to the top clearances to allow for the tightening of the lock nut.
 - Tighten adjusting shaft lock nut and check top and bottom rotor clearances to see that they are 1/3 off the top and 2/3 off the bottom.
 - If these clearances do not check, loosen lock nut and repeat the complete adjusting procedure.
 - After this adjustment has been satisfactorily completed, and lock nut tightened, record these measurements as “as assembled” clearances.

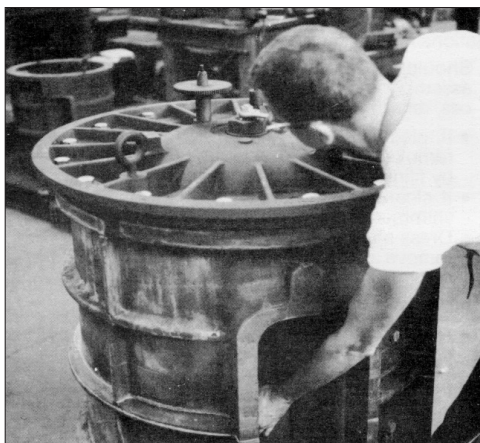

Figure 60

6. Determine rotor to block and blade slot clearances as described in Step 9 under Removing Inner Unit from Housing.
 - Record these measurements as “as assembled” clearances.

7. Assemble inner unit into outer housing.

- Clean the machined surfaces of the outlet port of the inner unit and outer housing with alcohol or solvent. Do not use a scraper or screwdriver on these surfaces (see Figure 61).
- Coat both surfaces with Loctite 518 (see Figure 61).

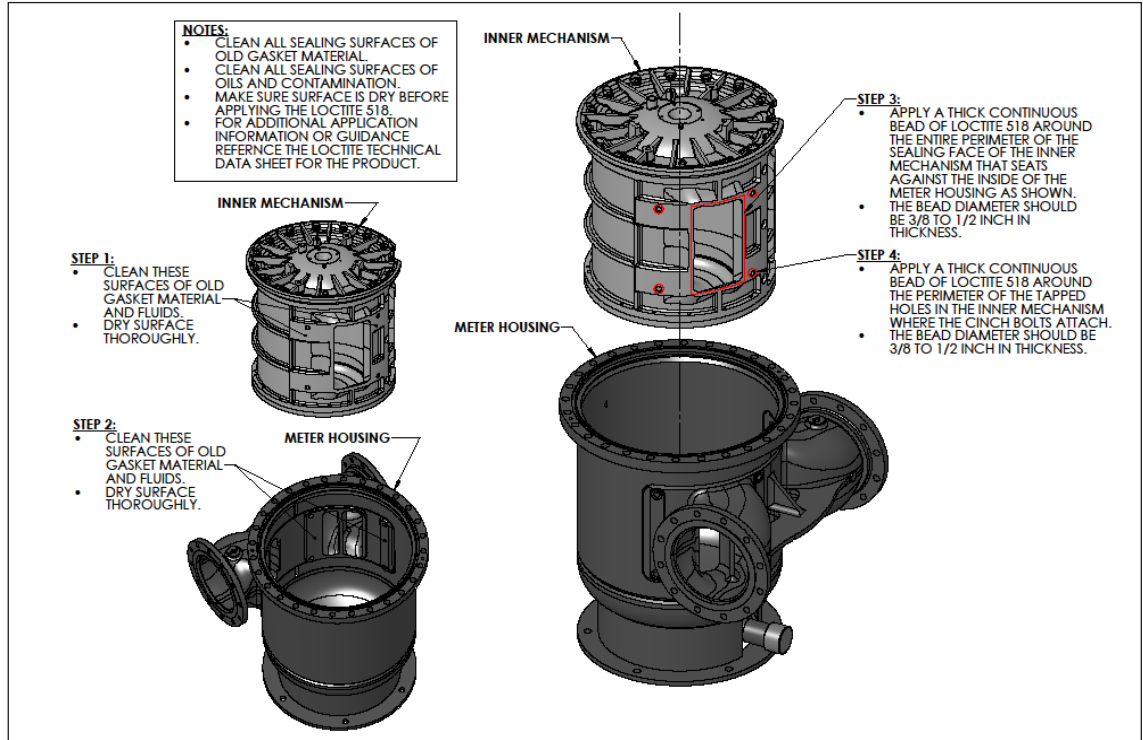

Figure 61 – Inner mech sealing

- Lower inner unit into outer housing. Apply Molykote O-ring grease to the O-rings on the cap screws and installing washers, draw inner unit up to seal outlet port (M16 only). See Table 3 for torque values.
- For all other sizes, refer to Figure 62 for cinch bolt sealing before torquing. See Table 3 for torque values.

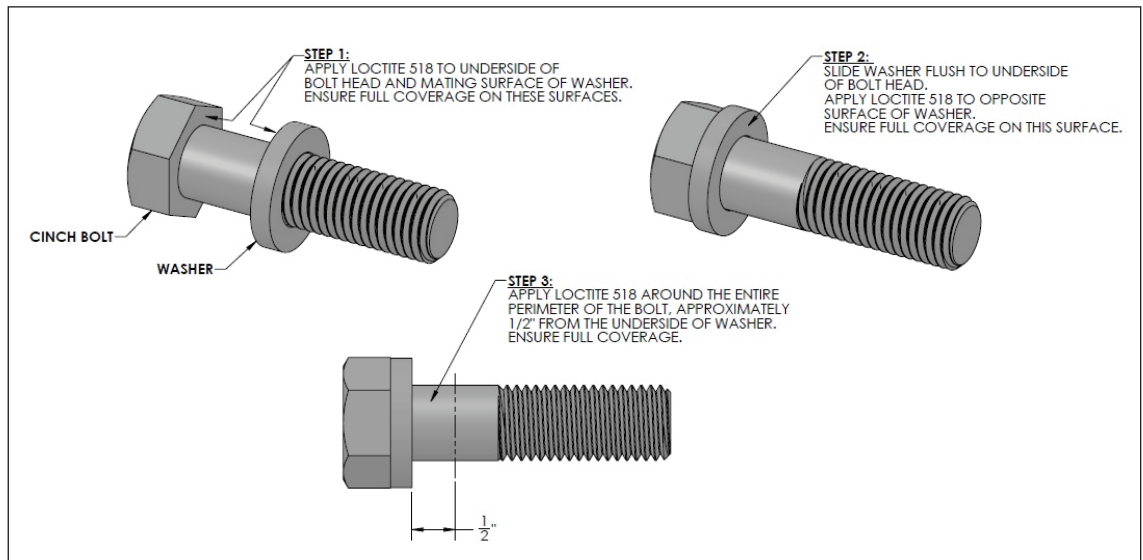

Figure 61 – Inner mech sealing

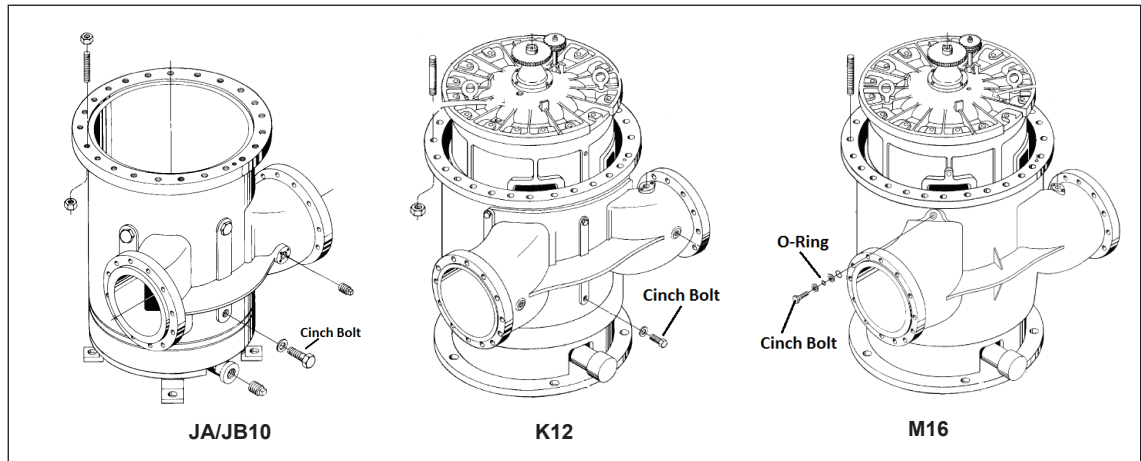

Figure 63 – Cinch bolt assembly

PD Meter	Pressure Rating	Stud Size (Inch)	Tightening Torque - Dry or Wet FT*LB)
JB10	S1 to S7	5/8	110-125
K12	S1 to S6	7/8	255-270
M16 (1993-Present only)	S1 to S6	1	450-465

Table 3 – Torque values

8. Complete reassembly

- Coat O-ring with Molykote O-ring grease and install O-ring in groove in top of outer housing.
- Install cover. Be sure to align locating pins in the meter body with the holes in the cover.
- Install cover studs (see Figure 64). Torque studs per Tables 4, 5, and 6.

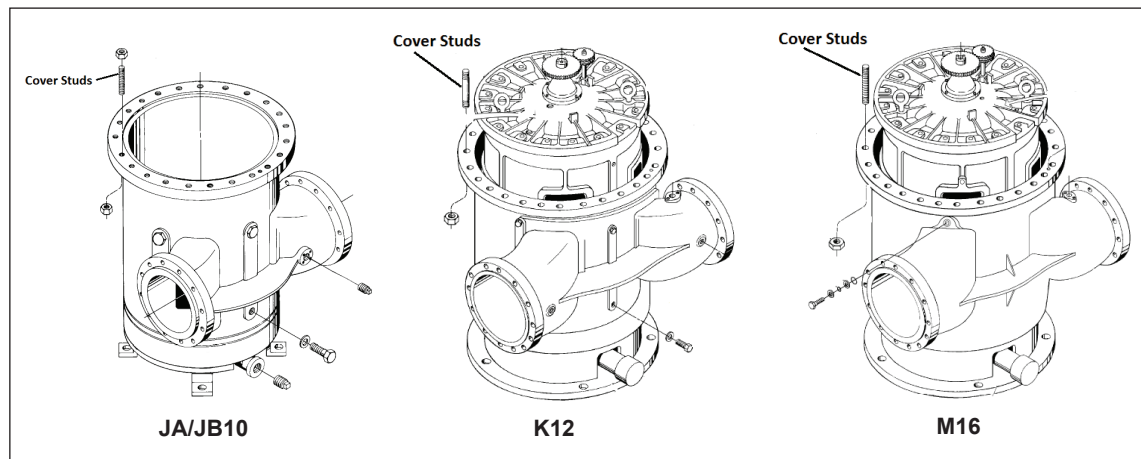

Figure 64 – Cover studs

PD Meter	Pressure Rating	Stud Size (Inch)	Tightening Torque - Dry (FT*LB)	Stud Size (Inch)	Tightening Torque - Dry (FT*LB)
Implementation		Pre 1993		1993-present	
M16	S1	1-1/4	960-1,070		
	S3 & S5	1-1/2	1,545-1,710	1-1/2	1,545-1,710
	S6	1-3/4	2,760-3,050	1-3/4	2,760-3,050

Table 4

PD Meter	Pressure Rating	Stud Size (Inch)	Tightening Torque - Dry (FT*LB)
K12	S1	1	610-675
	S3 & S5	1	610-675
	S6	1-1/4	690-1,070
	S7	1-1/2	1,545-1,710

Table 5

PD Meter	Pressure Rating	Stud Size (Inch)	Tightening Torque - Dry (FT*LB)	Stud Size (Inch)	Tightening Torque - Dry (FT*LB)	Stud Size (Inch)	Tightening Torque - Dry (FT*LB)
Implementation		Pre 1998		1998-2003		2003-Present	
JB10	S1	3/4	248-275				
	S3 & S5	1	610-675	1-1/8	760-840	1-1/8	760-840
	S6					1	610-675
	S7					1-3/8	1,295-1,430

Table 6

- To aid in reinstalling the vent kit (if equipped) use a 2-3 foot piece of 1/4" tubing.
 - a. Insert the tubing into the vent kit stand-off inside the body.
 - b. Install the vent kit O-ring on the underside of the vent kit housing with Vaseline or petroleum jelly.
 - c. Place the vent kit body on the tube and install it on the cover.
 - d. Remove the 1/4" piece of guide tube.
 - Using long needle nose pliers place the link shaft back into the meter and engage the coupling on the inner mechanism.
 - Reinstall the O-ring on the packing gland
 - Align the coupling on the packing gland with the link shaft and reinstall the packing gland on the cover (see Figure 65). Torque screws per Table 7.

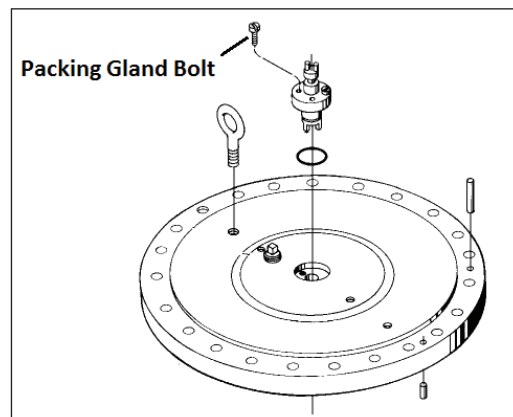

Figure 65

Packing Gland Type	Bolt Size	Tightening Torque - Dry	Typical CT Meter / Pressure Rating
PG-30 HP-4 HP-12	5/16	12-16	JB10-S1 to S5 K12-S1 to S5 M16-S1
PG-144 PG-222 HP-2	7/16	35-47	JB10-S6 to S7 K12-S6 to S7 M16-S3 to S6

Table 7

- Finally reinstall the adaptor, calibrator and any accessories that came with your meter.
- Install cover. Be sure to line up locating pin in cover with hole in housing flange.
- Install all remaining parts and accessories.

3.2. Clearance Guide

This clearance guide lists the recommended minimum and maximum fitting clearances for repaired meters.

Meters often exhibit acceptable accuracy if the clearances exceed the ranges shown.

(All units of measurement are inches.)

Meter Model/Size	Rotor To Block Clearance	Rotor Adj. Total End Clearance ¹	Blade Slot Clearance ²	Blade Ends Below Rotor Clearance ³	Blade Roller Over Cam Radius Clearance ⁴	Blade Tip To Housing Clearance ⁵
10"	.004"-.008"	.010"-.016"	.002"-.006"	.000"-.004"	.001"-.006"	.008"-.013"
12"	.005"-.010"	.014"-.022"	.003"-.008"	.000"-.004"	.001"-.006"	.013"-.018"
16"	.009"-.014"	.016"-.022"	.003"-.010"	.004"-.008"	.001"-.006"	.015"-.024"
Note: For Special Clearances, Consult Factory or Authorized Service Representative						

The above clearances apply to meters operating at standard operating temperatures and viscosities as listed below. For meters built to operate at higher temperatures and viscosities (designated by a 6-digit serial number), consult factory. Specify serial number and record special clearances in space provided.

Standard Temperature Ranges

JB10: -20°F (-29°C) to 125°F (52°C)

K12: -20°F (-29°C) to 115°F (46°C)

M16: -20°F (-29°C) to 105°F (41°C)

Standard Viscosity Limit

Less than 1,000 SSU (200 mPa•s).

- (1) Adjust rotor so that 1/3 of total available clearance is at top and 2/3 at bottom.
- (2) Blades should move freely in rotor slots and the average clearance in each slot should not exceed the listed clearances.
- (3) Lower edge of blade should not project below bottom surface of rotor.
- (4) With the blade in the measuring chamber, this total clearance should be maintained between the radius of the cam and one roller only.
- (5) With the blade held toward the housing, these clearances should be maintained between the measuring chamber and the full length of the edge of the blade.

Meter Clearance Record

3.3. Meter Clearance Record

Item	Date	As Found	As Assembled	Date	As Found	As Assembled	Date	As Found	As Assembled
Rotor to Block									
Rotor Adj. Total End Clearance									
Blade Slot Total Clearance									
Blade Ends Top End Clearance Below Rotor									
Blade Roller Over Radius Portion of Cam									
Blade Tip Toward Housing									
Item	Date	As Found	As Assembled	Date	As Found	As Assembled	Date	As Found	As Assembled
Rotor to Block									
Rotor Adj. Total End Clearance									
Blade Slot Total Clearance									
Blade Ends Top End Clearance Below Rotor									
Blade Roller Over Radius Portion of Cam									
Blade Tip Toward Housing									

The following literature can be obtained from TechnipFMC Measurement Fulfillment at measurement.fulfillment@TechnipFMC.com or online at http://info.smithmeter.com/literature/online_index.html.
When requesting literature from Literature Fulfillment, please reference the appropriate bulletin number and title.

Model	Specifications	Parts Lists	Manuals
JB10	SS01019	PO01019 - JB10-S1, S3, S5 PO01020 - JB10-S6, S7	MN01011 Installation / Operation / Maintenance Manual
K12	SS01020	PO01018 - K12	
M16	SS01021	PO01024 - M16-S1, S3, S5, S6 (Prior to 1993) PO01023 - M16-S1, S5, S6 (1993 to Present)	

Technical Support

Contact Information:

Field Service Response Center
24/7 Technical Support/Schedule
a Technician: 1-844-798-3819
System Installation Supervision,
Start-Up, Commissioning Services,
and Training Available

Revisions included in MN01006 Issue/Rev. 0.4 (12/18):

Added to document: Required torque values for studs and bolts at the cover, inner-mech (cinch bolts) and packing gland based on size, material, and application. Total revision of page numbers and layout of the document.

Editorial Change - May 2019 - Page 9: Section 2.4 number 8, bullet 3 - "M16 locking bolts are larger..."

The specifications contained herein are subject to change without notice and any user of said specifications should verify from the manufacturer that the specifications are currently in effect. Otherwise, the manufacturer assumes no responsibility for the use of specifications which may have been changed and are no longer in effect.

TechnipFMC.com

Copyright © 2018 TechnipFMC plc. All rights reserved. MN01006 Issue/Rev. 0.4 (12/18)

TechnipFMC
FMC Technologies, Inc.
13460 Lockwood Road
Building S01
Houston, Texas 77044 USA
P: +1 281.591.4000

USA Operation
1602 Wagner Avenue
Erie, Pennsylvania 16510 USA
P: +1 814.898.5000

Germany Operation
Smith Meter GmbH
Regentstrasse 1
25474 Ellerbek, Germany
P: +49 4101 304.0